

CB Series PC/104-Plus Multiport Serial Module

User's Manual

www.moxa.com/product

Fourth Edition, January 2008

MOXA[®]

© 2008 Moxa Inc., all rights reserved.
Reproduction without permission is prohibited.

CB Series PC/104-Plus Multiport Serial Module User's Manual

The software described in this manual is furnished under a license agreement and may be used only in accordance with the terms of that agreement.

Copyright Notice

Copyright © 2008 Moxa Inc.
All rights reserved.
Reproduction without permission is prohibited.

Trademarks

MOXA is a registered trademark of Moxa Inc.
All other trademarks or registered marks in this manual belong to their respective manufacturers.

Disclaimer

Information in this document is subject to change without notice and does not represent a commitment on the part of Moxa.

Moxa provides this document "as is," without warranty of any kind, either expressed or implied, including, but not limited to, its particular purpose. Moxa reserves the right to make improvements and/or changes to this manual, or to the products and/or the programs described in this manual, at any time.

Information provided in this manual is intended to be accurate and reliable. However, Moxa assumes no responsibility for its use, or for any infringements on the rights of third parties that may result from its use.

This product might include unintentional technical or typographical errors. Changes are periodically made to the information herein to correct such errors, and these changes are incorporated into new editions of the publication.

Technical Support Contact Information

www.moxa.com/support

Moxa Americas:

Toll-free: 1-888-669-2872

Tel: +1-714-528-6777

Fax: +1-714-528-6778

Moxa China (Shanghai office):

Toll-free: 800-820-5036

Tel: +86-21-5258-9955

Fax: +86-10-6872-3958

Moxa Europe:

Tel: +49-89-3 70 03 99-0

Fax: +49-89-3 70 03 99-99

Moxa Asia-Pacific:

Tel: +886-2-8919-1230

Fax: +886-2-8919-1231

Table of Contents

Chapter 1	Introduction	1-1
	Overview	1-2
	Package Checklist.....	1-2
	Product Features	1-2
	Product Specifications	1-3
Chapter 2	Hardware Installation	2-1
	Hardware Installation	2-2
	Block Diagrams	2-2
	Rotary Switch	2-3
	Termination Resistor	2-3
	Serial Interface Selection.....	2-4
Chapter 3	Software Installation	3-1
	Windows NT.....	3-2
	Installing the Driver	3-2
	Configuring the Ports.....	3-5
	Removing the Board.....	3-7
	Updating the Driver	3-7
	Removing the Driver	3-8
	Windows 95/98/ME.....	3-9
	Installing the Driver	3-9
	Configuring the Ports.....	3-13
	Updating the Driver	3-15
	Removing the Driver	3-17
	Windows Vista (32-bit and 64-bit)	3-18
	Installing the Driver	3-18
	Using Device Manager to Verify Installation	3-25
	Port Configuration	3-26
	Windows XP, 2003 (32-bit and 64-bit).....	3-28
	Installing the Driver	3-28
	Using Device Manager to Verify Installation	3-34
	Port Configuration	3-35
	Using PComm.....	3-37
	Using Event Log	3-37
	Disabling the Module	3-37
	Uninstalling the Module	3-38
	Windows 2000.....	3-39
	Installing the Driver	3-39
	Using Device Manager to Verify Installation	3-45
	Port Configuration	3-46
	Using PComm.....	3-47
	Using Event Log	3-48
	Disabling the Module	3-48
	Uninstalling the Module	3-49
	Linux (32-bit and 64-bit)	3-51
	DOS.....	3-51
	Installing the Driver	3-51
	Driver Setup.....	3-52
	Loading the Driver.....	3-54

	Unloading the Driver	3-54
	Windows CE 5.0.....	3-54
	Installing the driver.....	3-54
Chapter 4	Serial Programming Tools.....	4-1
	Serial Programming Library	4-2
	PComm Utilities	4-2
	Installation	4-2
	PComm Diagnostic.....	4-2
	PComm Monitor.....	4-3
	PComm Terminal Emulator.....	4-3
Chapter 5	Pin Assignments	5-1
	Box Header Pin Assignments	5-1
	RS-232	5-1
	RS-422, 4-wire RS-485	5-1
	2-wire RS-485.....	5-2
	Serial Cable Pin Assignments.....	5-2
	DB9(M) Connectors	5-2
	DB25(M) Connectors	5-3

Welcome to the CB Series of *PC/104-Plus* communication modules, a multiport serial module for industrial applications. It is designed for *PC/104-Plus* CPU boards that accept the *PC/104-Plus* expansion interface. Optional DB9 and DB25 cables are available to connect different devices. The device drivers make full use of the 128-byte Tx/Rx FIFO and on-chip flow control, which allows up to 921.6 Kbps data transmission.

The CB Series includes the following models:

CB-108: 8 ports, RS-232

CB-108-T: 8 ports, RS-232, wide temperature

CB-114: 4 ports, RS-232/422/485

CB-114-T: 4 ports, RS-232/422/485, wide temperature

CB-134I: 4 ports, RS-422/485, optical isolation protection

CB-134I-T: 4 ports, RS-422/485, optical isolation protection, wide temperature

2 KV optical isolation is provided on optical isolation models. Wide temperature models are rated for operation between -40 to 85°C.

The following topics are covered in this chapter:

- Overview**
- Package Checklist**
- Product Features**
- Product Specifications**

Overview

The CB Series PC/104-*Plus* module is designed to be used with PC/104-*Plus* CPU modules or CPU cards with the PC/104-*Plus* expansion interface. Models are available for RS-232, RS-422, and RS-485, with 4 or 8 ports. The serial ports are accessed through a 40-pin box header connector on the module. DIP switches allow you to select the serial interface. The industry-standard MOXA UART (16C550 compatible) is fully programmable. Built-in 15 KV ESD protection protects devices connected to the serial network.

Package Checklist

MOXA performs a careful mechanical and electrical inspection of each module prior to shipping. Your module should arrive in perfect electrical order, free of any marks or scratches. Please handle the module by the edges only, since your body's static charge can damage the integrated circuits. When the module is not in use, please keep it in the anti-static package provided. You may also use this package to return the module if it requires repair.

The CB Series module is shipped with the following items:

- CB Series PC/104-*Plus* multiport serial module
- Documentation and Software CD
- Quick Installation Guide
- 5-year product warranty statement

Note: Please notify your sales representative if any of the above items are missing or damaged.

Product Features

The CB Series module features the following:

- 4 or 8 serial ports (depending on model)
- RS-232, RS-422, or RS-485 operation (depending on model)
- 128-byte FIFOs and on-chip flow control
- Up to 921.6Kbps data transmission speed
- Built-in 15 KV ESD protection
- Onboard Tx, Rx LED indicators for each port
- Optional wide temperature support (-40 to 85°C)

Product Specifications

CB Series PC/104-Plus Multiport Serial Module

Hardware

I/O controller	MU860 (16C550C compatible)
Connector Type	40-pin box header

Interface

Bus	PC/104-Plus (PCI) bus
No. of Ports	4 ports (CB-114, CB-134I) 8 ports (CB-108)
Max. No. of Modules	4

Signals

RS-232	TxD, RxD, RTS, CTS, DTR, DSR, DCD, GND
RS-422	TxD+(B), TxD-(A), RxD+(B), RxD-(A), GND
4-wire RS-485	TxD+(B), TxD-(A), RxD+(B), RxD-(A), GND
2-wire RS-485	Data+(B), Data-(A), GND

Performance

Baudrate	50 bps to 921.6 Kbps
----------	----------------------

Configuration

Parity	None, Even, Odd, Space, Mark
Data Bits	5, 6, 7, 8
Stop Bit(s)	1, 1.5, 2
IRQ	BIOS assigned
FIFO	128 bytes
Additional Settings	Serial interface selection by DIP switch
Driver Support	DOS Windows 2000, Windows XP/2003/Vista (x86 and x64) Linux 2.4, Linux 2.6 (x86 and x64)

Power and Environment

Operating Temperature	Standard models: 0 to 55°C (32 to 131°F) “-T” models: -40 to 85°C (-40 to 185°F)
Operating Humidity	5 to 95% RH
Storage Temperature	-40 to 70°C (-40 to 158°F)
ESD Protection	Embedded 15 KV ESD protection

Other

Dimensions (W x D)	96 x 90 mm
Regulatory Approvals	EN55022 Class A, EN55024, EN6100-3-2, EN61000-3-3, FCC Part 15 Class A

Warranty	5 years
----------	---------

2

Hardware Installation

This chapter explains how to install the CB Series PC/104-*Plus* multiport serial module.

The following topics are covered:

- ❑ **Hardware Installation**
- ❑ **Block Diagrams**
 - Rotary Switch
 - Termination Resistor
- ❑ **Serial Interface Selection**

Hardware Installation

Installing the CB Series module is easy. Before inserting the module into the PC/104-Plus slot, you must first configure the I/O base address, interrupt vector, IRQ, and serial interface (for select models).



ATTENTION

Safety First!

To prevent damage to your system or board, make sure your embedded PC's power is turned off before installing your CB Series module.

Step 1: Shut off power to your embedded PC and to any peripheral devices. After shutting off power, remove the cover of your embedded PC.

Step 2: Use the DIP switches on the module to select the serial interface. Details for each model are provided later in this chapter.

Step 3: Insert the module firmly into the embedded PC's PC/104-Plus slot.

Step 4: Screw the control board in place.

Step 5: Connect the cables.

Step 6: Power on the embedded PC. The BIOS will automatically set the IRQ and I/O address

Step 7: Proceed with the software installation. Please refer to Chapter 3.

Block Diagrams

CB-108

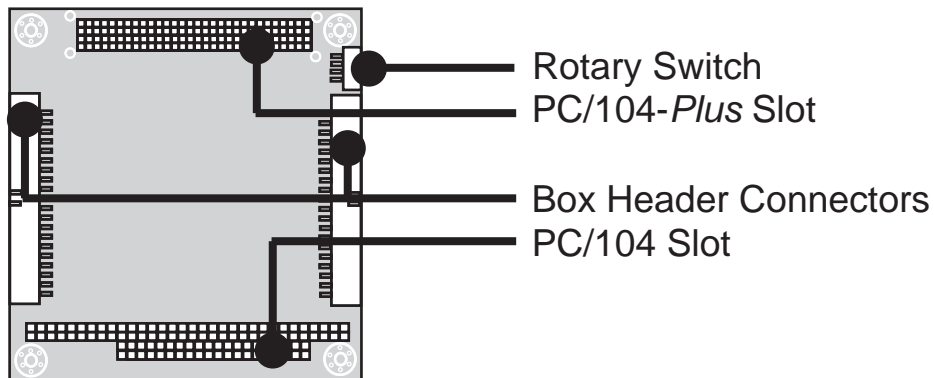

CB-114

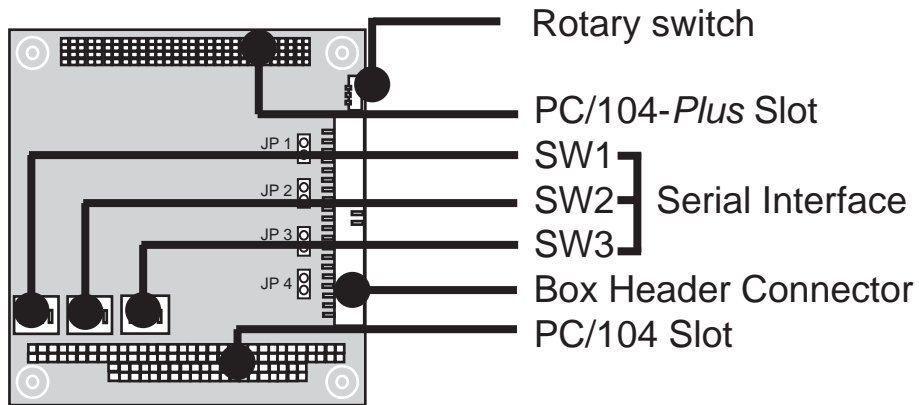

CB-134I

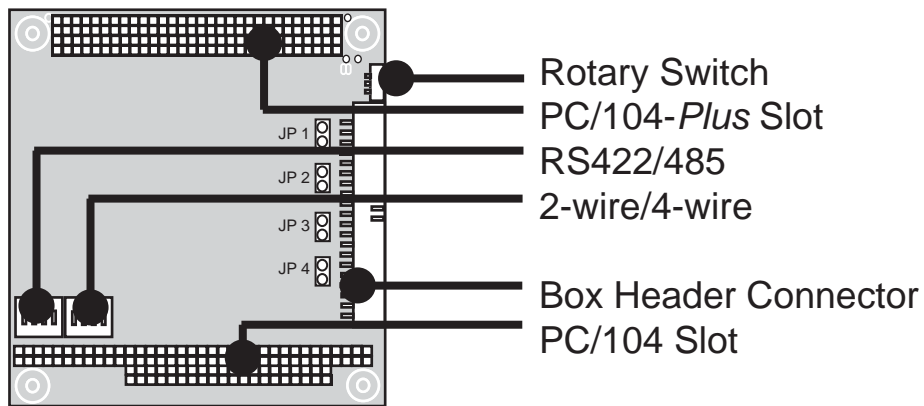

Rotary Switch

A rotary switch on the board makes it easy to set the appropriate signals, particularly when installing multiple PC/104-Plus modules in the same unit. The rotary switch, which looks like a clock, provides a bi-directional path with no signal propagation delay. The first module on the stack should be set to CLK0, the second to CLK1, etc., to eliminate clock skew between modules.

Termination Resistor

Onboard termination resistors can be activated individually for each serial port using jumpers JP1 through JP4. JP1 corresponds to serial port 1. Short the jumper pins to activate the termination resistor; leave the jumper pins open to bypass the termination resistor.

Serial Interface Selection

For the CB-114 and CB-134I, the serial interface is selecting using the onboard DIP switches.

CB-114

Mode	S1	S2	S3
RS-232	---	---	ON
RS-422	---	ON	off
4-wire RS-485	ON	off	off
2-wire RS-485	off	off	off

CB-134I

Mode	S1	S2
RS-422	---	off
4-wire RS-485	off	ON
2-wire RS-485	ON	ON

3

Software Installation

After installing the CB Series module in your embedded computer, the next step is installing the software. Drivers for various operating systems are provided, including DOS, Windows, and Linux. This chapter explains how to install and remove the CB Series driver.

The following topics are covered in this chapter:

- Windows NT**
- Windows 95/98/ME**
- Windows Vista (32-bit and 64-bit)**
- Windows XP, 2003 (32-bit and 64-bit)**
- Windows 2000**
- Linux (32-bit and 64-bit)**
- DOS**
- Windows CE 5.0**

Windows NT

Installing the Driver

You will need to plug the board in an available PCI or PCI-X slot first, before installing the driver.

Note that these instructions use the CB-114 as an example. The procedure for installing all models is the same.

1. Log into Windows NT as Administrator.
2. Locate the appropriate folder for your board's drivers on the Document & Software CD. The NT drivers will be located under the product folder in the **\Software\WinNT** directory (e.g., under **\CB-114 Series\Software**). Copy this folder to the PC's hard disk and remember its location.
3. In the **Control Panel**, open **Network** applet. On the **Adapters** tab, click **Add**. When prompted to select a product, click **Have Disk....**

You will be prompted to enter the path to the driver. Enter the location of the drivers that you copied from the Document & Software CD (**C:\Windows.nt** in this example) and then click **OK**.

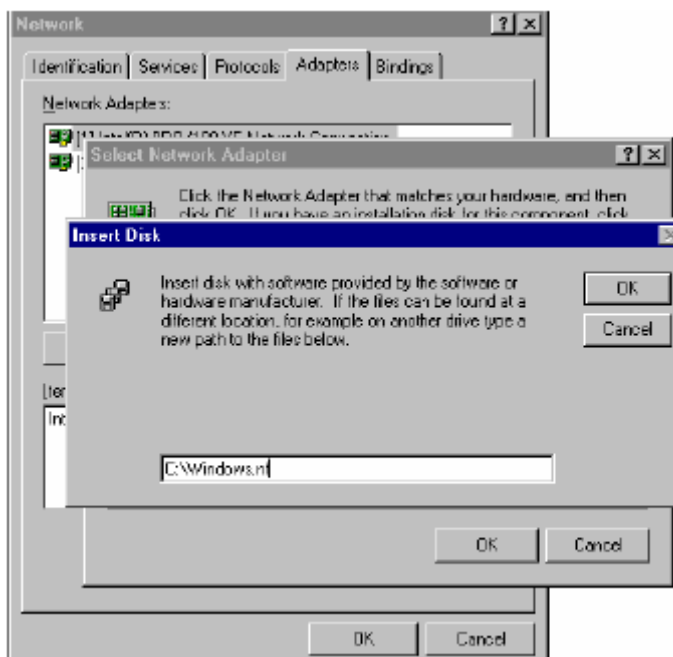

- When prompted, select your board model (**Smartio/Industio Family multiport board** in this example) and click **OK**.

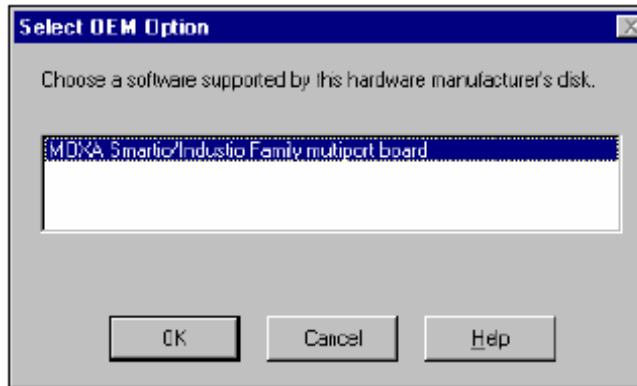

- After the files have been installed, a configuration panel will open. This is where boards are installed, configured, and removed. If another board has already been installed on the system, it will already be listed. Windows NT does not automatically detect Moxa UPCI boards, so you will need to click **Add** for a newly installed board.

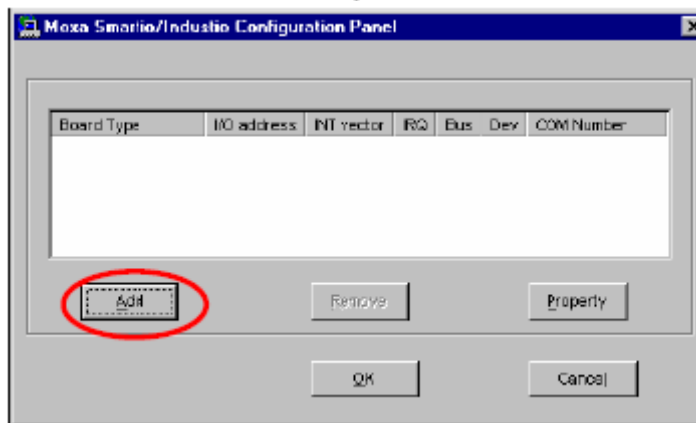

- Under **Board Type**, select the UPCI board that is being installed. The window will show the COM settings for the serial ports on the board. You can modify the COM settings for any port at this time by selecting a port and clicking **Port Setting**. If you are satisfied with the COM settings, click **OK** to return to the configuration panel.

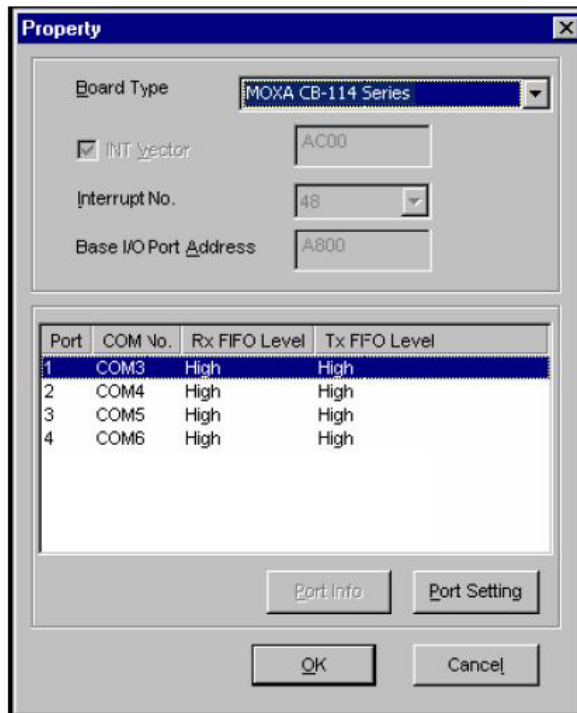

- The board will now appear in the configuration panel (**CB-114 Series in this example**). Click **OK** to return to the Network applet. After that, click **OK** again to exit the Network applet

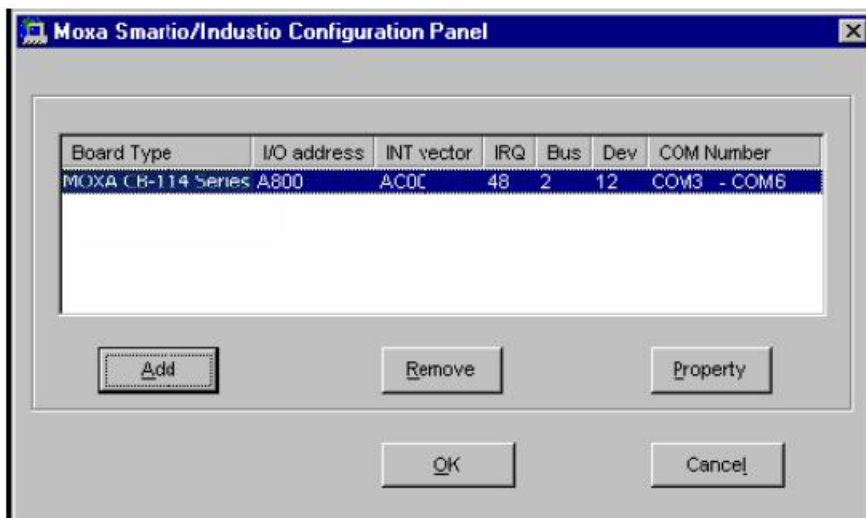

- Restart the PC. After you have logged back into Windows NT, you may check the event log issued by the Moxa driver to see if the board's ports have been initialized successfully. In the **Administrative** group, open **Event Viewer** and select **Log and System**. For each newly installed or configured Moxa UPCI board, check for a message stating that the board has been enabled (e.g., "MoxaCB-114 board, with first serial port COM3, has been enabled").

Configuring the Ports

1. In Windows **Control Panel**, open the **Network** applet. In the **Adapters** tab, UPCI boards will appear as a type of Moxa adapter (**MOXA Smartio/Industio Family Adapter** in this example). Select the Moxa adapter and click **Properties....**

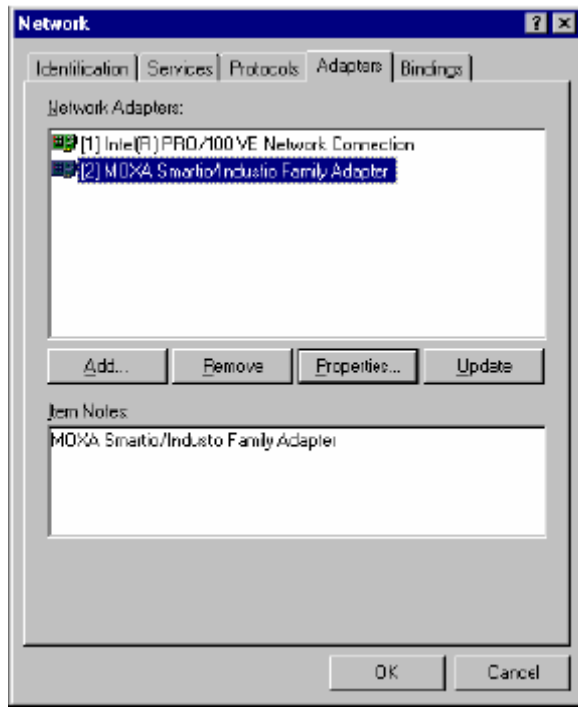

2. The configuration panel will open with a list of installed boards. Select your board and click **Property**. Up to 4 Moxa UPCI boards can be installed at a time.

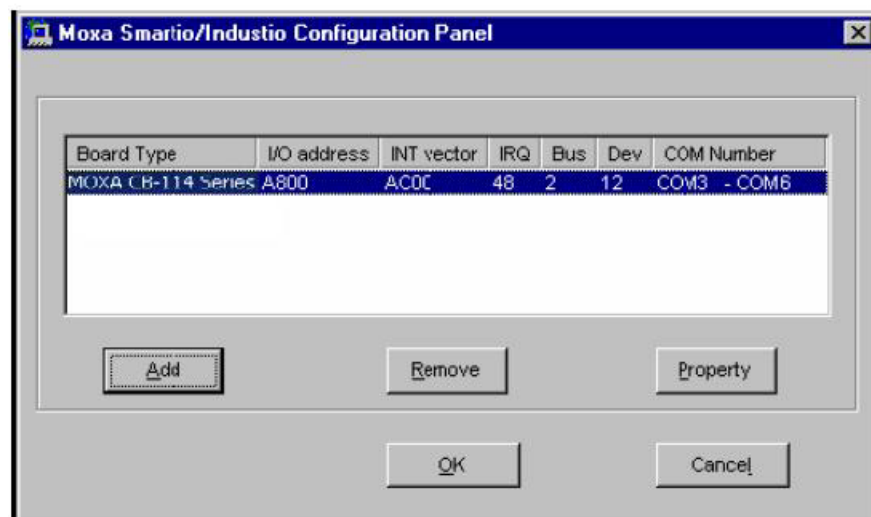

3. Select a port to configure and click **Port Setting**.

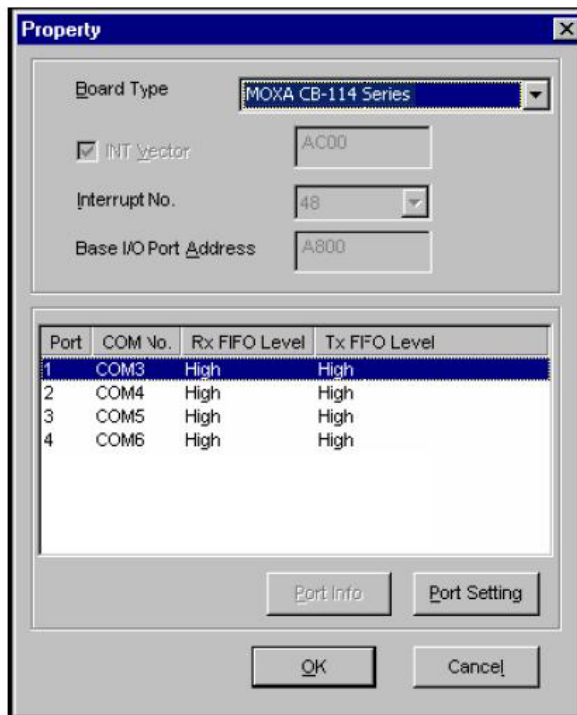

Under **Port Number**, select a COM number to assign to the serial port. Select **Auto Enumerating COM Number** to map subsequent ports in numerical order. For example, if COM 3 is assigned to Port 1, then COM 4 will be automatically assigned to Port 2.

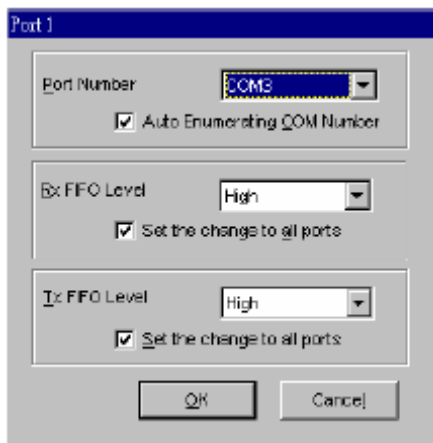

4. Select an **Rx FIFO Trigger** and **Tx FIFO Size**. The default Rx FIFO Trigger is 120 bytes (high level). The default Tx FIFO Size is 128 bytes (high level). Select **Set the change to all ports** to use this setting for all serial ports on the board.

	TxFIFO	RxFIFO
High	128	120
Middle	64	60
Low	1	1

- Click **OK** to approve the settings for the selected port. Continue in the same way to configure the other ports. When you have finished setting up the ports, click **OK** to close the **Properties** window and apply the new port settings. Click **OK** again to exit the Network applet.

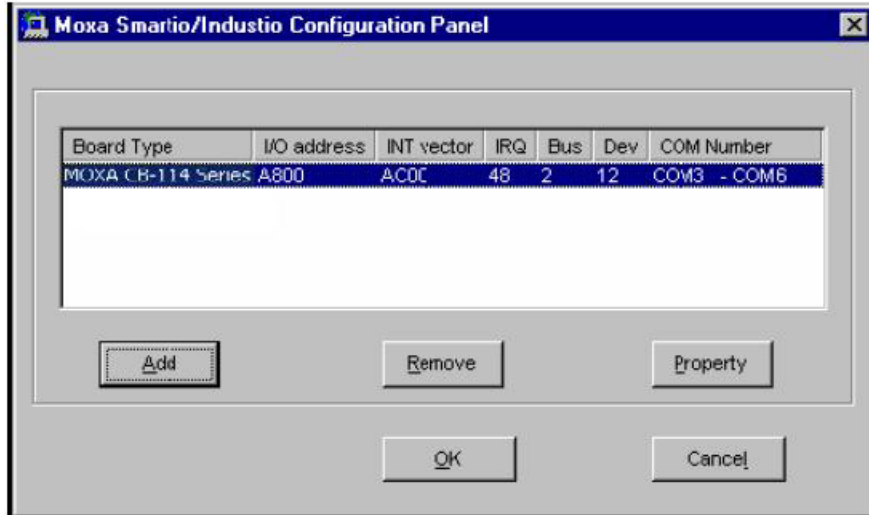

Removing the Board

To remove a board, shut of your PC and physically remove the board from the PCI slot. The next time you start up the PC, Windows NT will automatically remove the configuration. You do not need to go through the Windows control panel.

Updating the Driver

- In Windows **Control Panel**, open the **Network** applet. In the **Adapters** tab, UPCI boards will appear as a type of Moxa adapter (**MOXA Smartio/Industio Family Adapter** in this example). Select the Moxa adapter and click **Remove**.

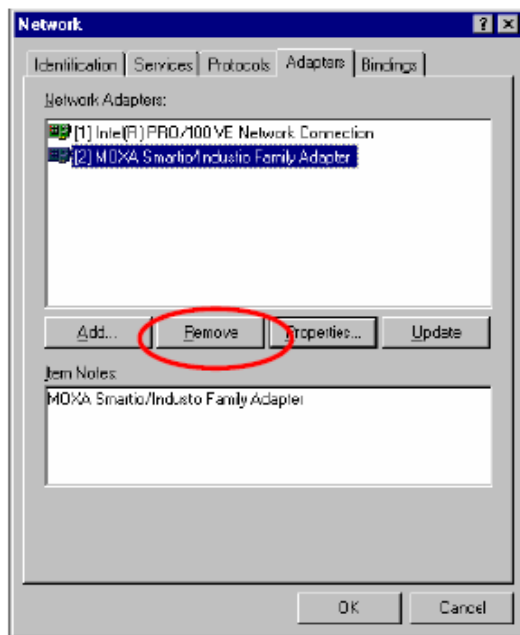

2. Restart the system.
3. Go through the process of installing the drivers using the new drivers.

Removing the Driver

1. In Windows **Control Panel**, open the **Network** applet. In the **Adapters** tab, UPCI boards will appear as a type of Moxa adapter (**MOXA Smartio/Industio Family Adapter** in this example). Select the Moxa adapter and click **Remove**.

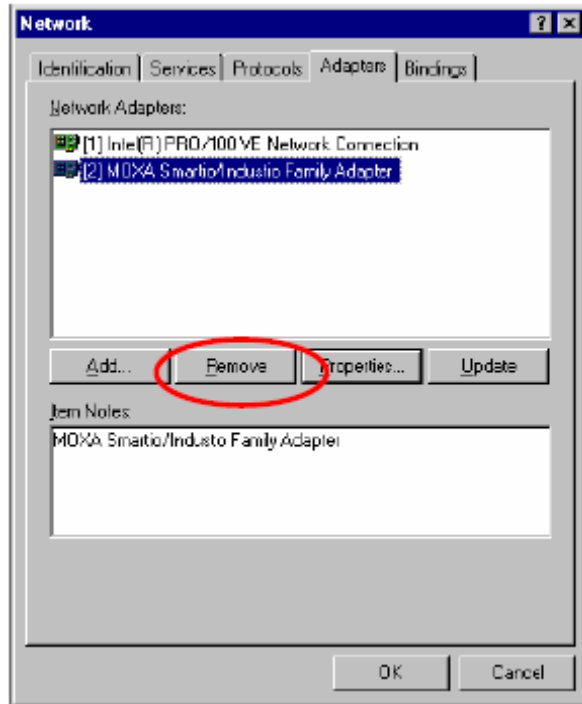

2. Click **OK** to exit the Network applet and restart the system.

Windows 95/98/ME

Installing the Driver

Windows 95

1. After the board is physically installed and the PC boots up, Windows will automatically detect the new board and the Found New Hardware Wizard window will open. Click **Next** to continue.



2. Select **Other Locations...**

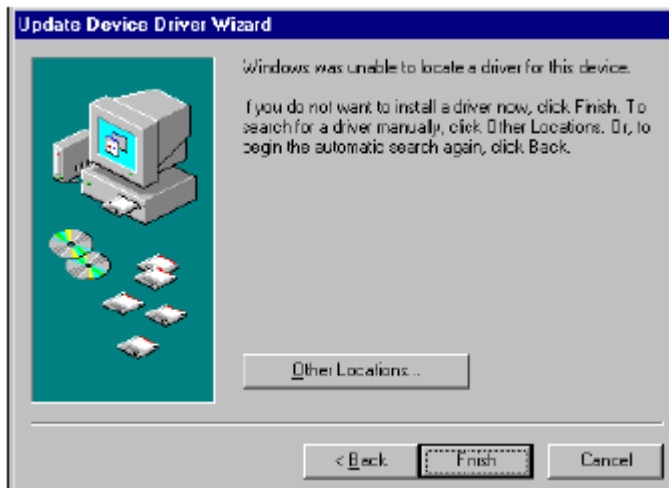

3. Click **Browse** and select the appropriate directory on the Document & Software CD for the driver. Drivers for all operating systems are located under the product folder in the \Software directory. Select the \Win9x folder and click **OK** to continue.

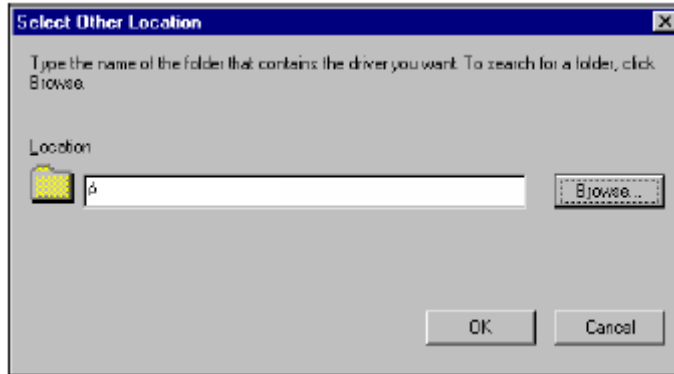

4. After Windows finds the drivers, click **Finish**.



You may begin configuring and using the new COM ports right away without restarting Windows.

Windows 98 and ME

1. After the board is physically installed and the PC boots up, Windows will automatically detect the new board and the Found New Hardware Wizard window will open. Click **Next** to continue.



2. Select **Display a list...** and click **Next**.



3. Select **Other Devices** and click **Next**.

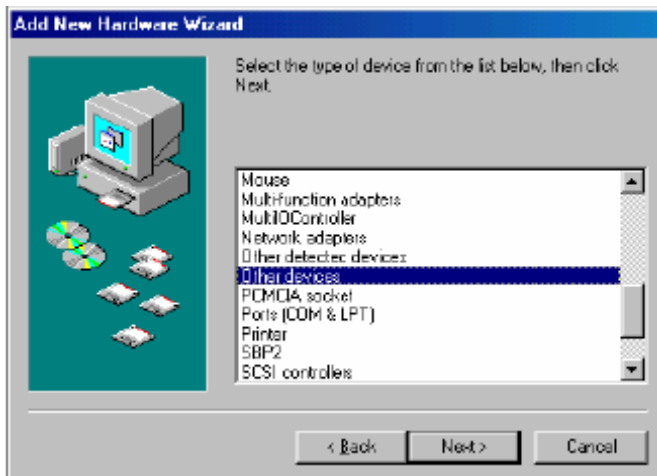

4. Select **Have Disk...**

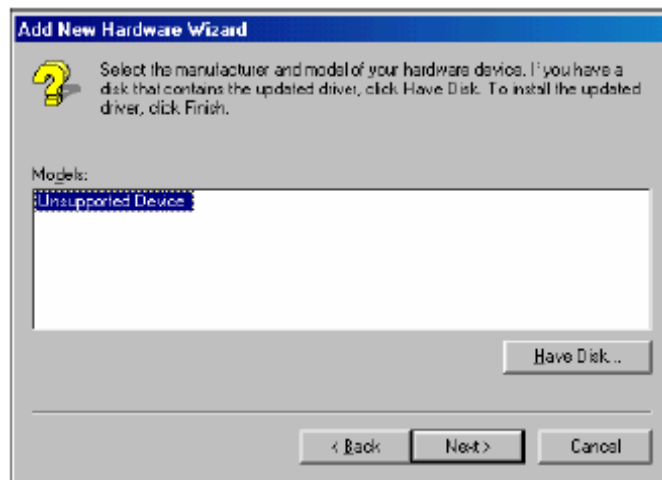

5. Click **Browse** and select the appropriate directory on the Document & Software CD for the driver. Drivers for all operating systems are located under the product folder in the **\Software** directory. Select the **\Win9x** folder and click **OK** to continue.

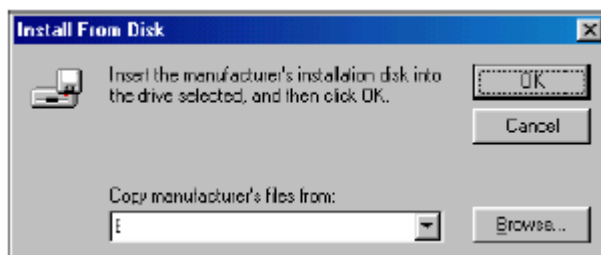

6. After Windows installs the drivers, click **Finish**.



Configuring the Ports

You may configure the COM ports after the board and drivers have been installed.

1. In the Windows **Control Panel**, open the **System** applet.

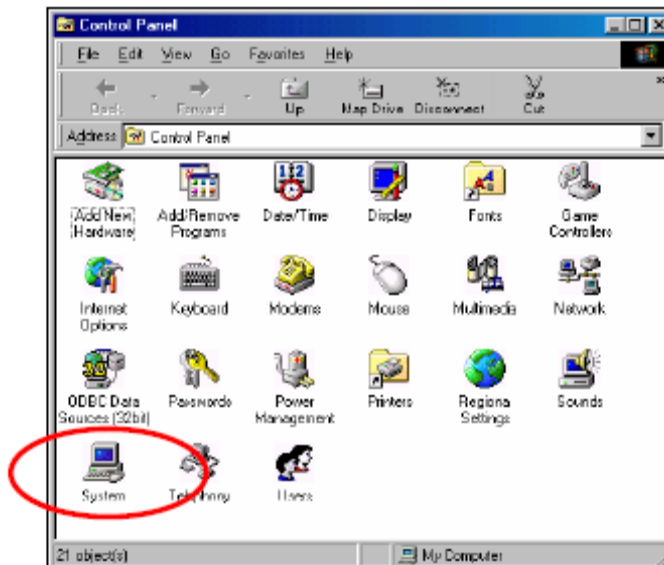

- In the **Device Manager** tab, expand the **Moxa Smartio/Industio multiport board** category by clicking the “+” sign next to it. Select the desired board and click **Properties**.

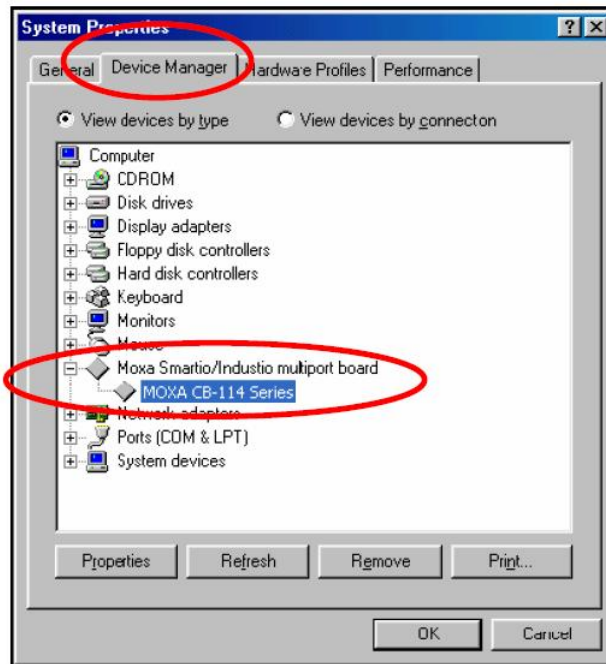

- On the **Ports Configuration** tab, select a port to configure and click **Port Setting**.

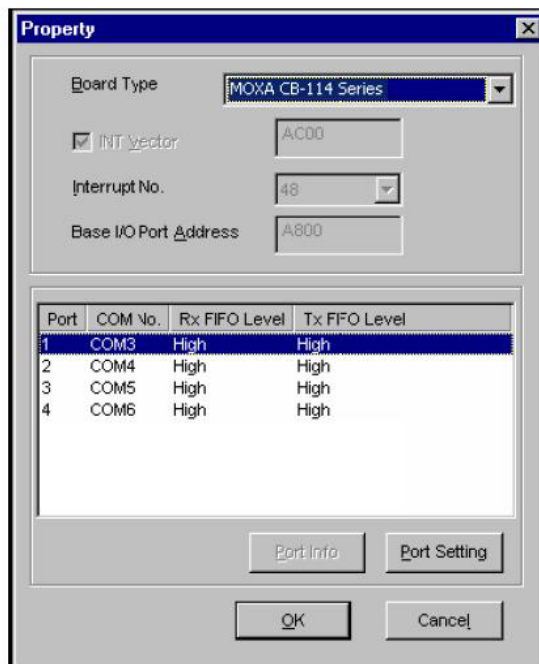

Under **Port Number**, select a COM number to assign to the serial port. Select **Auto Enumerating COM Number** to map subsequent ports in numerical order. For example, if COM 3 is assigned to Port 1, then COM 4 will be automatically assigned to Port 2.



4. Select an **Rx FIFO Trigger** and **Tx FIFO Size**. The default Rx FIFO Trigger is 120 bytes (high level). The default Tx FIFO Size is 128 bytes (high level). Select **Set the change to all ports** to use this setting for all serial ports on the board.

	TxFIFO	RxFIFO
High	128	120
Middle	64	60
Low	1	1

5. Click **OK** to approve the settings for the selected port. Continue in the same way to configure the other ports. When you have finished setting up the ports, click **OK** to close the **Properties** window and apply the new port settings. Click **OK** again to close the **Device Manager** and restart the system.

Updating the Driver

You may configure the COM ports after the board and drivers have been installed.

1. In the Windows **Control Panel**, open the **System** applet.

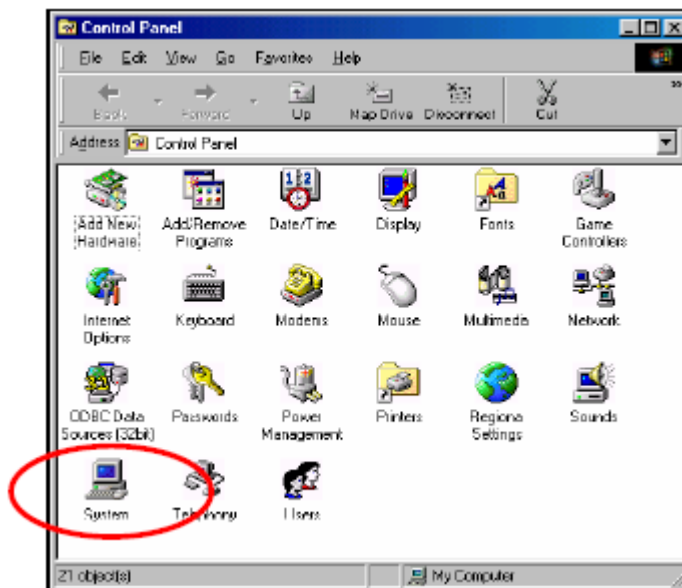

- In the **Device Manager** tab, expand the **Moxa Smartio/Industio multiport board** category by clicking the “+” sign next to it. Select the desired board and click **Properties**.

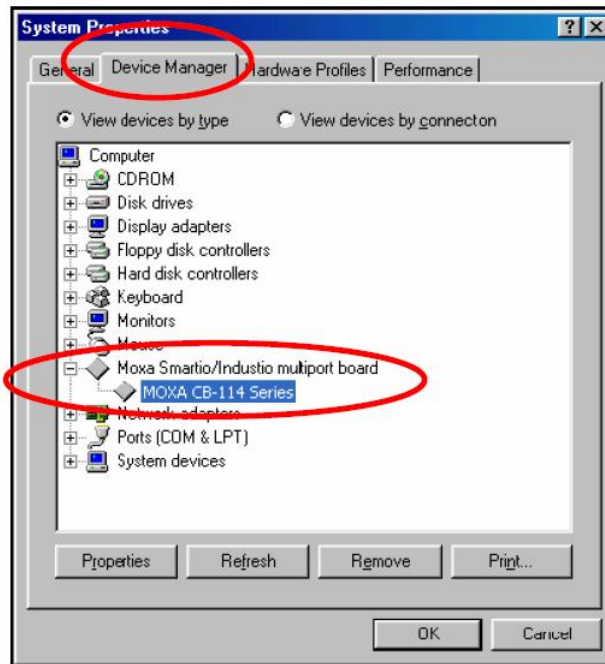

- In the **Driver** tab, click **Update Driver...**

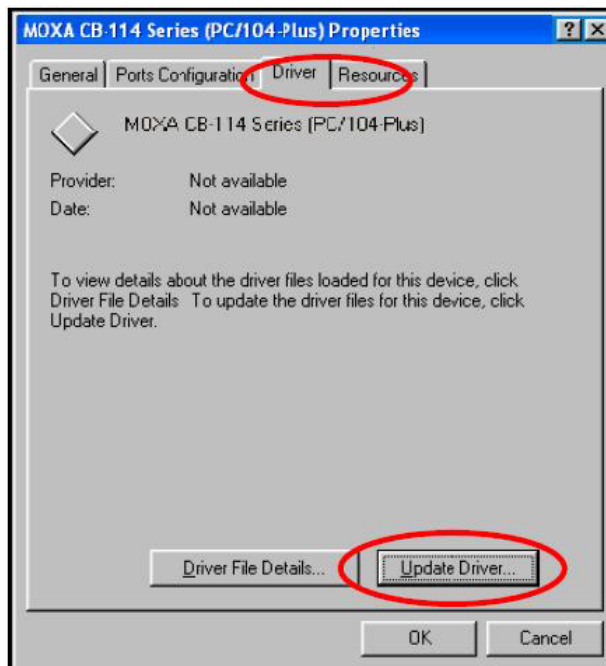

4. Select the appropriate model (CP-168U in this example) and click **Have Disk...**



5. When prompted, select the appropriate directory on the Document & Software CD for the driver. Drivers for all operating systems are located under the product folder in the **\Software** directory. Select the **\Win9x** folder and click **OK** to continue.
6. You will be prompted to restart the system. The new drivers will be in effect the next time you restart.

Removing the Driver

1. In the Windows Control Panel, open the **Add/Remove Programs** applet. On the Install/Uninstall tab, select **MOXA Smartio/Industio Driver** and click **Add/Remove**.

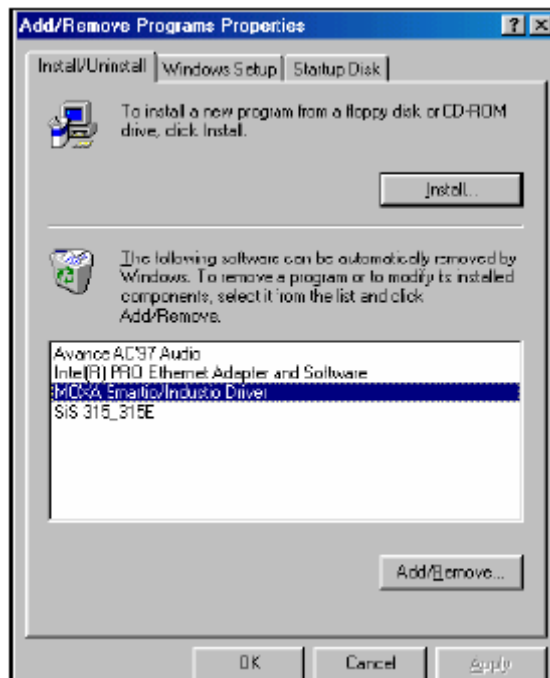

- When prompted, click **Yes** to confirm that you want to remove the driver.

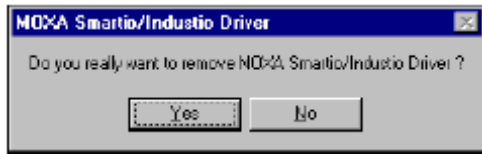

- After the driver has been removed, click **OK** to return to the **Add/Remove Programs** applet.



Windows Vista (32-bit and 64-bit)

The Windows Vista (32-bit/64-bit) drivers conform to the Win32 COMM API standard and support all models in the CB Series. In the following instructions, the CB-114 is used as an example.

Installing the Driver

- After the module has been plugged into a *PC/104-Plus* slot, turn the embedded computer on.
- Windows will automatically detect the new module and the **Found New Hardware Wizard** will open automatically. Select **Locate and install driver software (recommended)**.

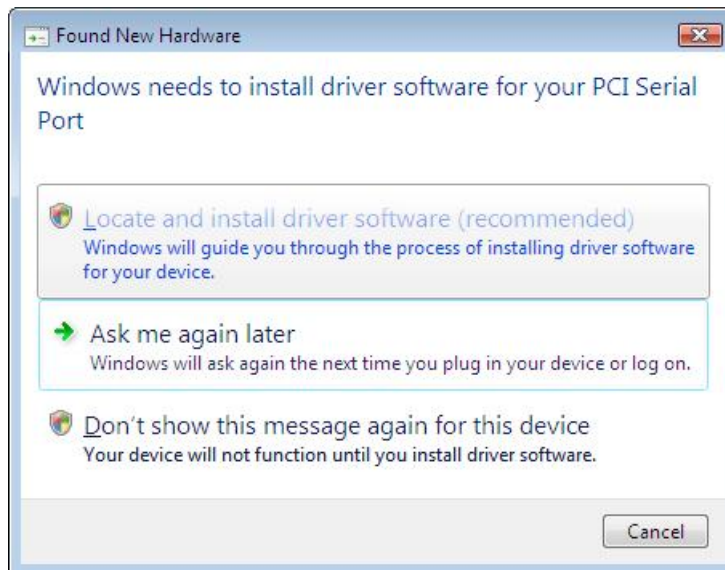

- When prompted to insert the disc, select **I don't have the disc. Show me other options.**

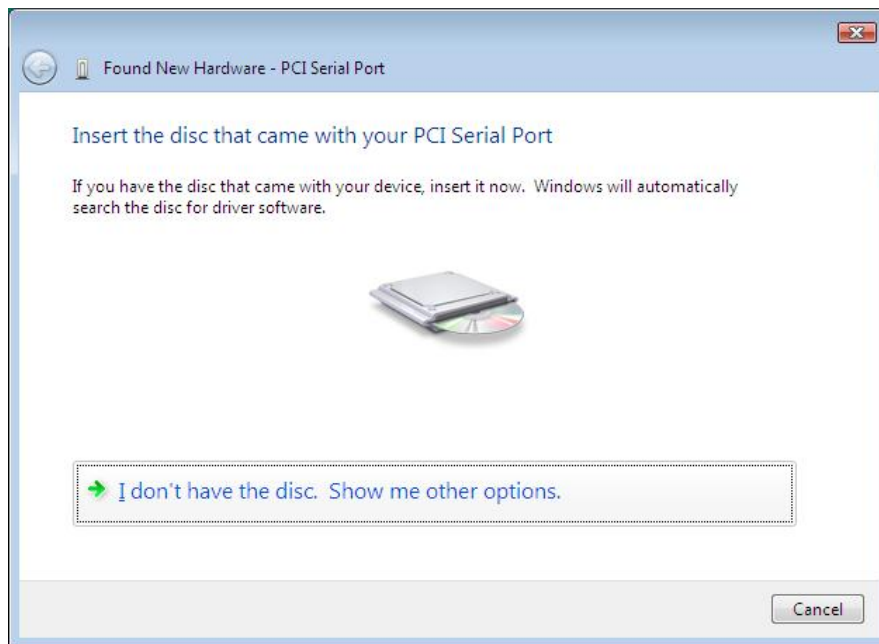

- Select **Browse my computer for driver software (advanced).**

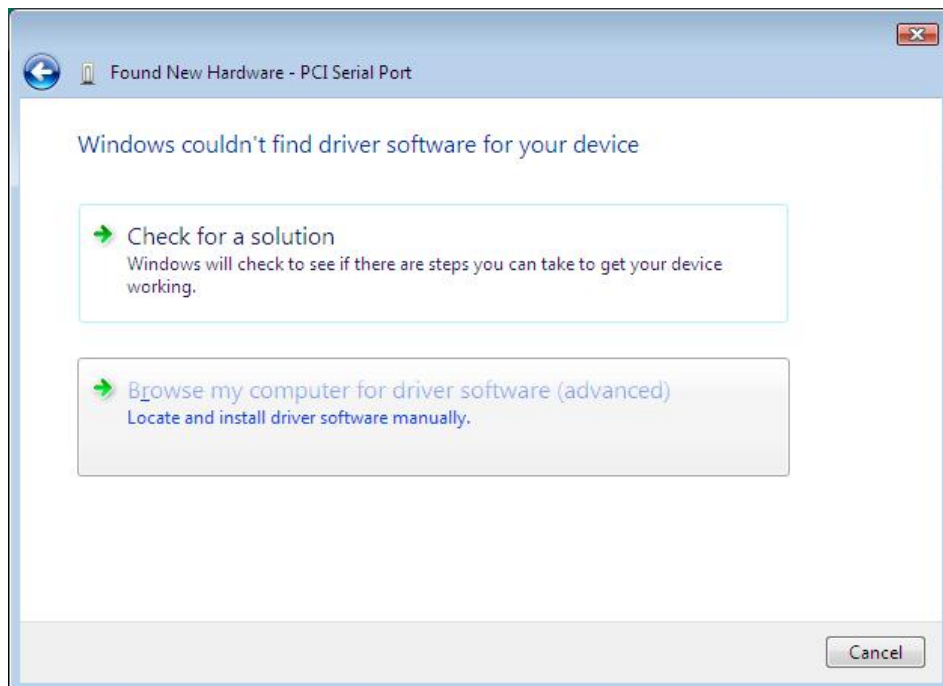

- Click **Browse** to manually specify the folder in which to find the driver. For 32-bit (x86) platforms, select the \CB Series\Software\Windows Vista\x86 folder on the CD. For 64-bit (x64) platforms, select the \CB Series\Software\Windows Vista\x64 folder on the CD. Click **Next** to continue.

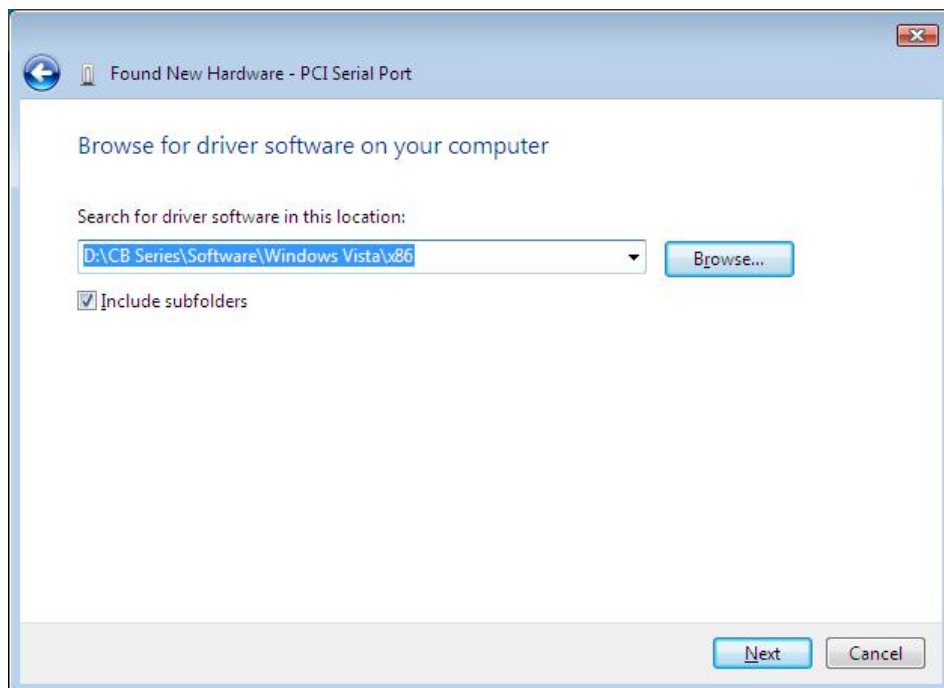
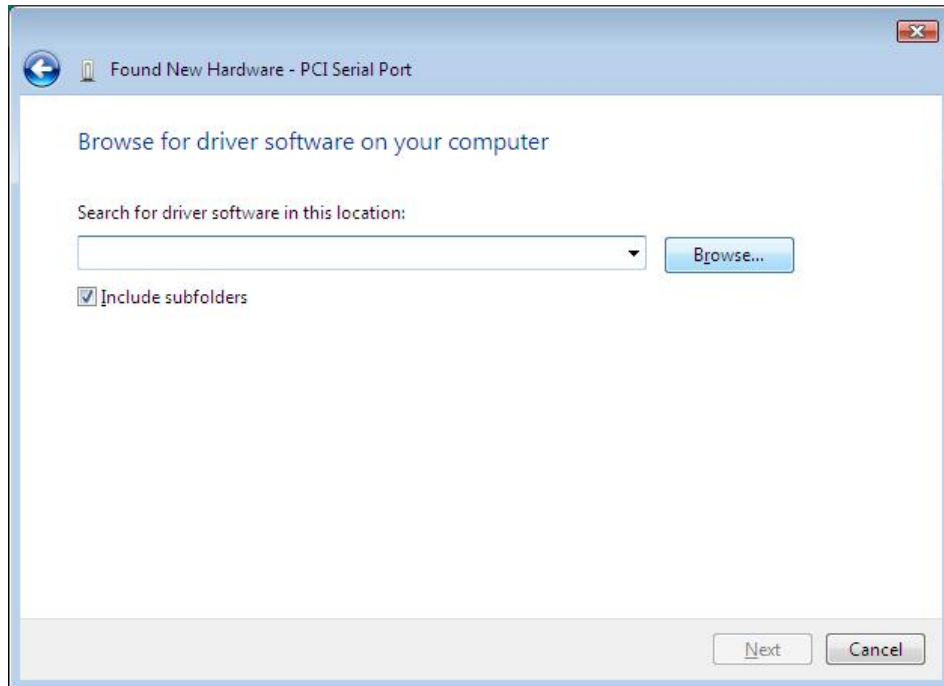

6. If you see a warning that the software has not passed Windows Logo testing, click **Install this driver software anyway**.

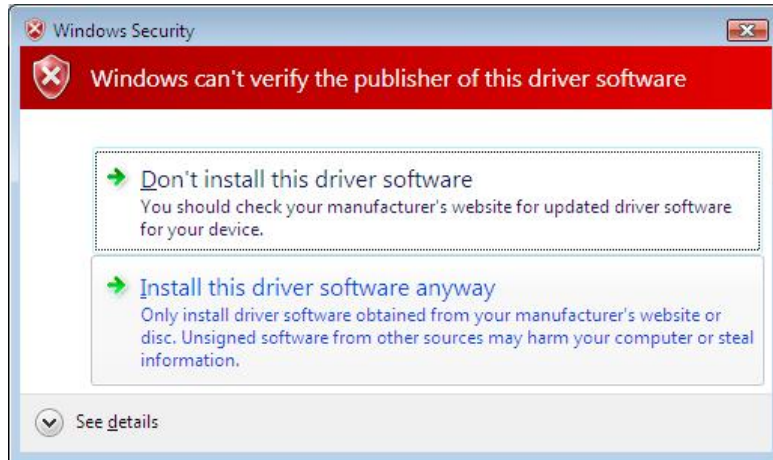

7. After the files have been installed, click **Close**.

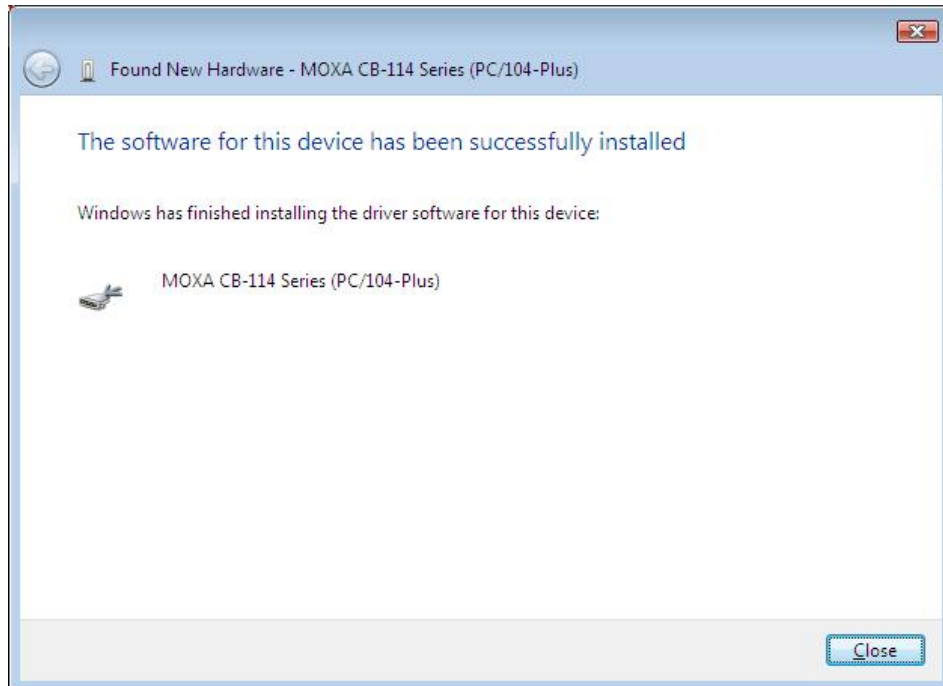

8. After the module is installed, you will be prompted to install the new serial ports. A **Found New Hardware Wizard** window will open for the first serial port, port 0. Select **Locate and install driver software (recommended)** to continue.

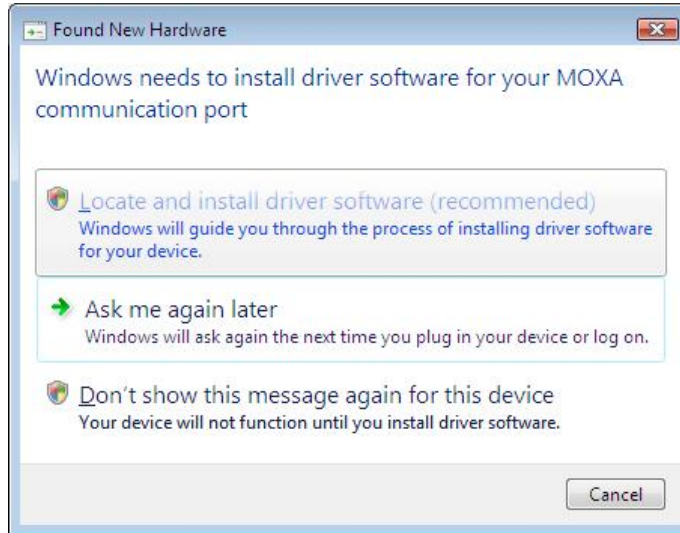

9. Select **I don't have the disc. Show me other options.**

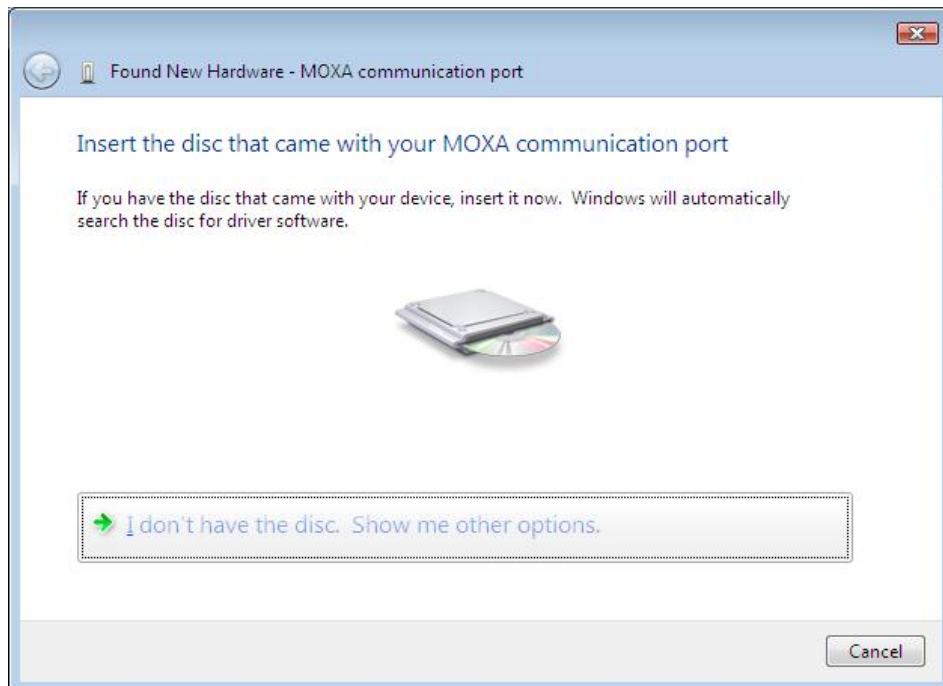

10. Select **Browse my computer for driver software (advanced)**.

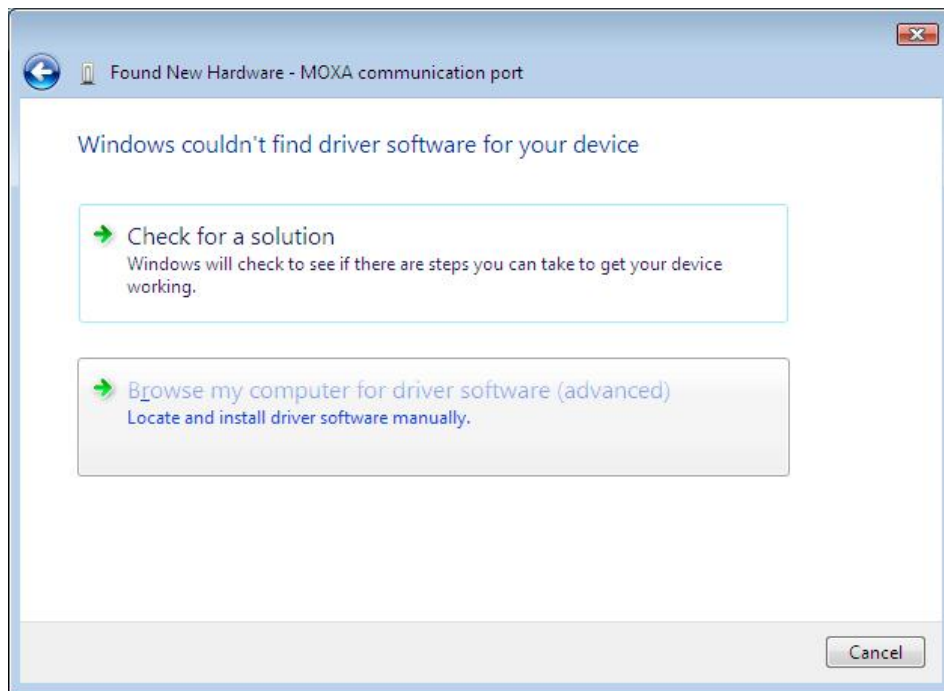

11. Click **Browse** to manually specify the folder in which to find the driver. For 32-bit (x86) platforms, select the `\CB Series\Software\Windows Vista\x86` folder on the CD. For 64-bit (x64) platforms, select the `\CB Series\Software\Windows Vista\x64` folder on the CD. Click **Next** to continue.
12. Windows will install the driver software.

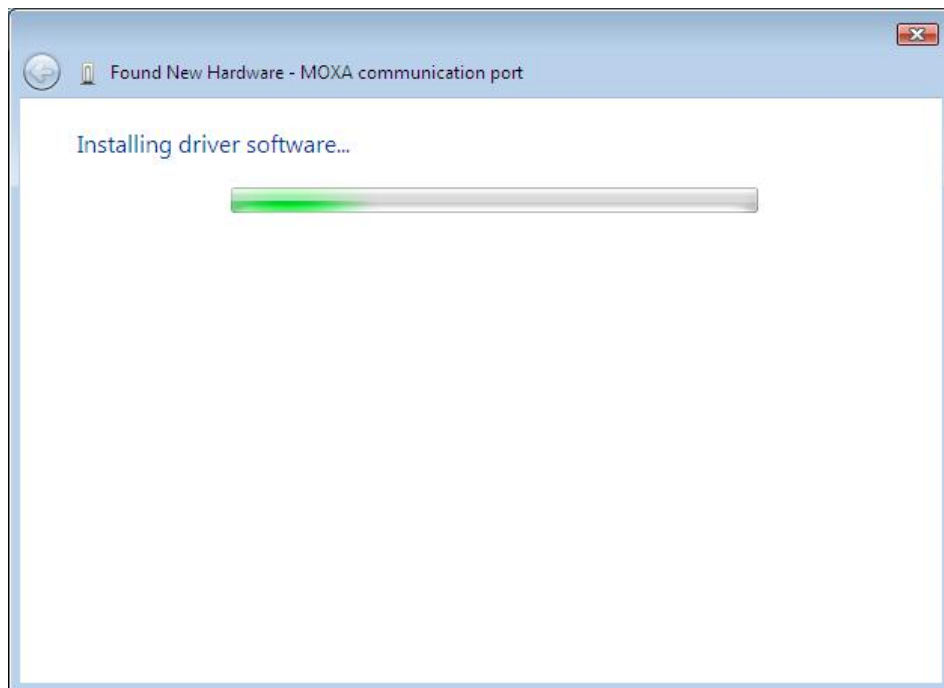

13. If you see a warning that the software has not passed Windows Logo testing, click **Install this driver software anyway**.

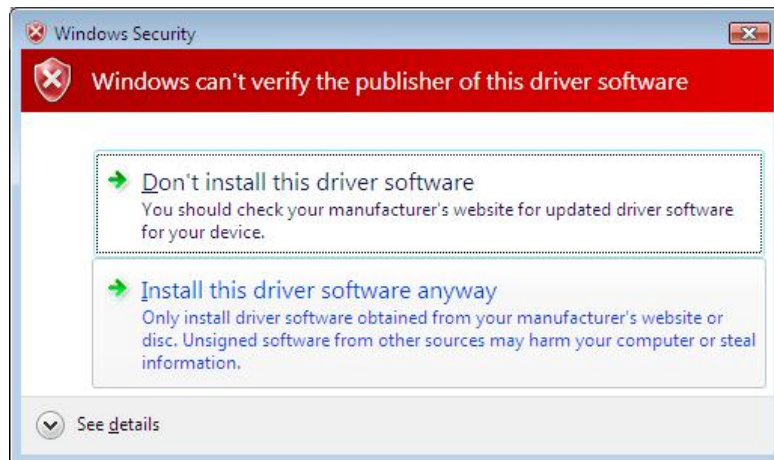

14. After the files have been installed, click **Close**. The remaining serial ports will automatically install in the background.

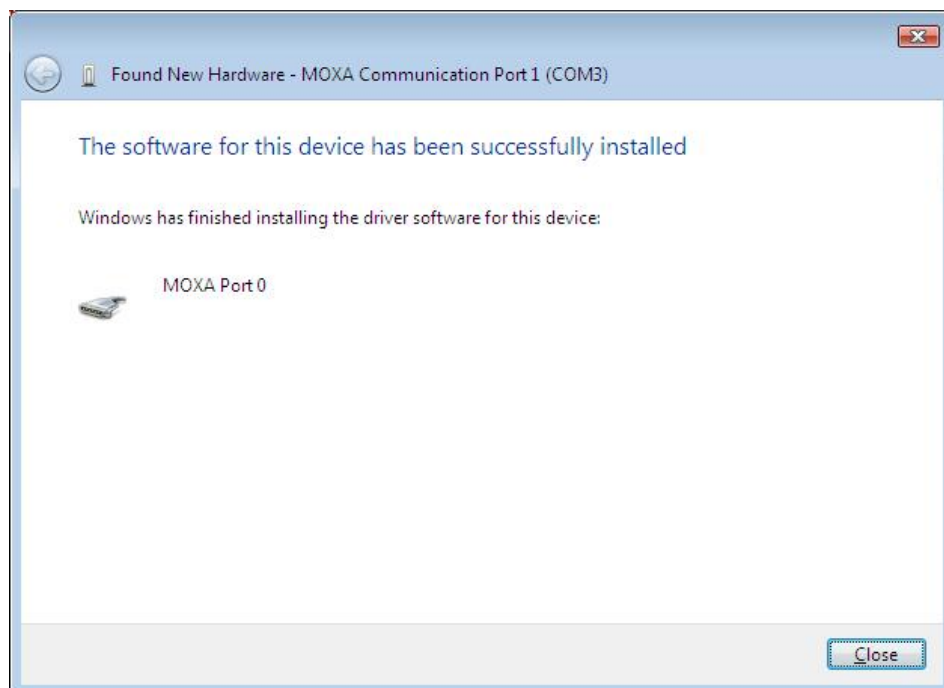

Using Device Manager to Verify Installation

You can use Windows Device Manager to verify proper installation of the CB Series module. In the following instructions, the CB-114 is used as an example.

1. Under **My Computer**, click **System Properties**.

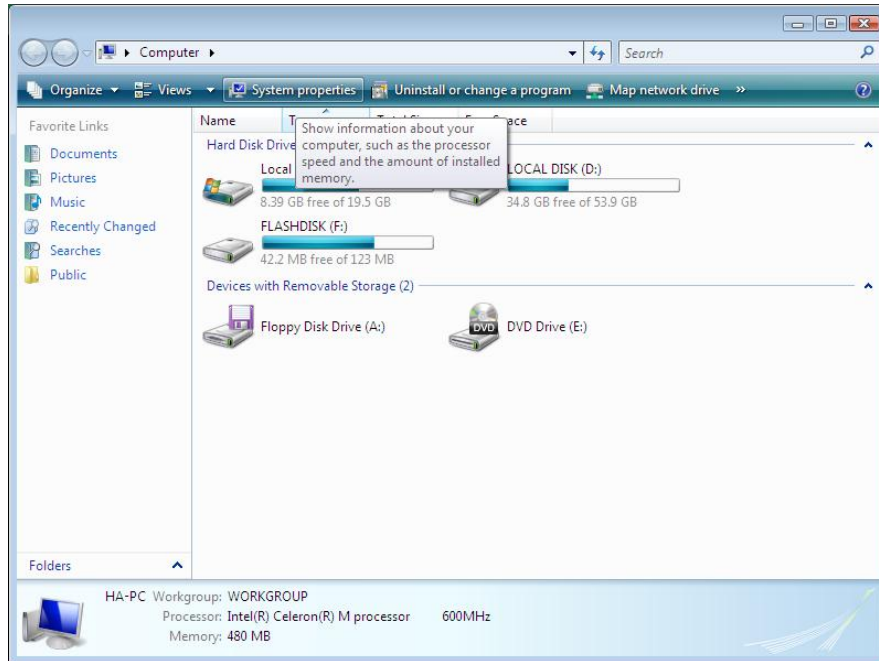

2. In the **System** window, click **Device Manager**.

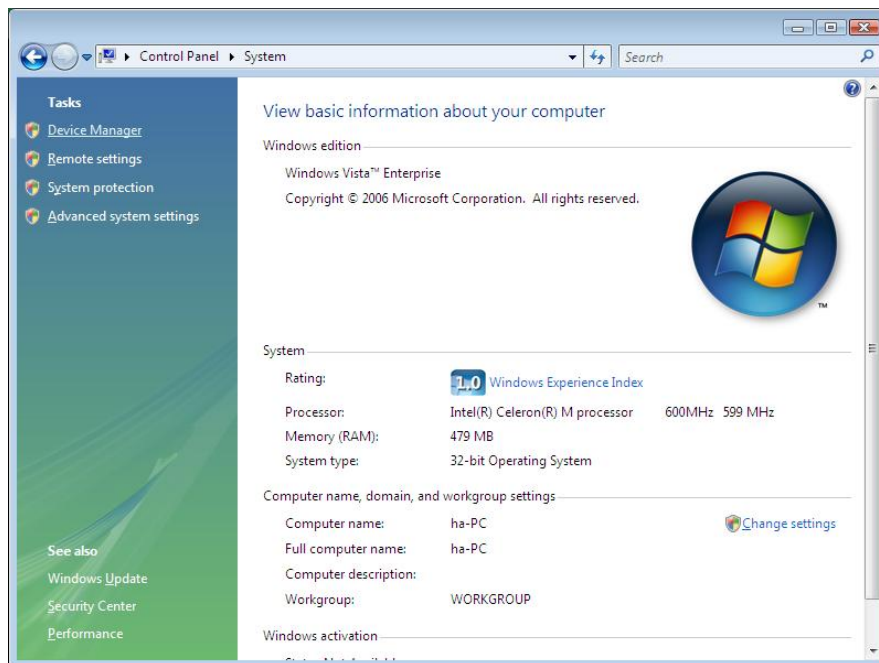

3. In the **Device Manager** window, you should see your CB Series module under **Multi-port serial adapters**. You should also see Moxa communication ports under **Ports (COM & LPT)**.

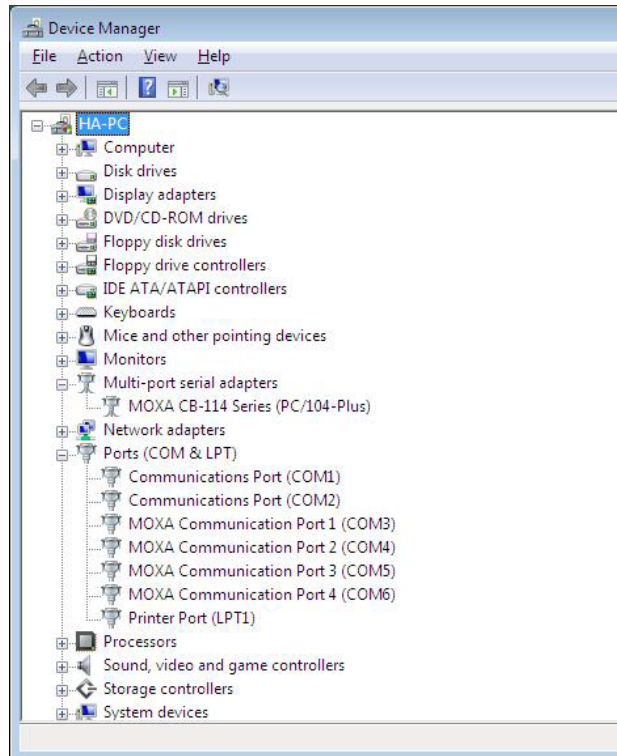

4. If you see any special marks, such as a question mark or an exclamation mark, next to the Moxa items, the installation of your module or serial ports was not successful. Examine the Windows event log for details.

Port Configuration

After the driver is installed, a CB Series Properties window will appear. The system will map the serial ports automatically. It will prompt you to take care of port configuration if another CB Series module has been installed on the PC.

1. Select a specific port under the **Port Configuration** tab and click **Port Setting**.

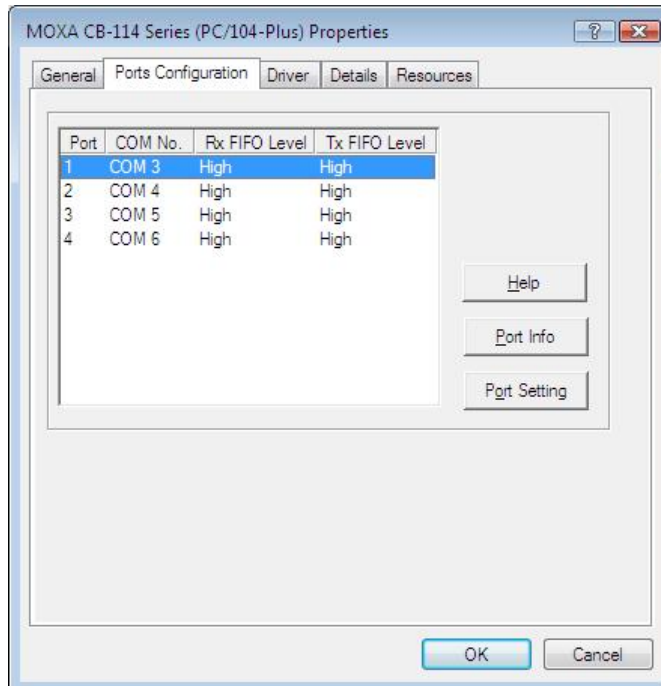

- Under **Port Number**, select a COM number to assign to the serial port.

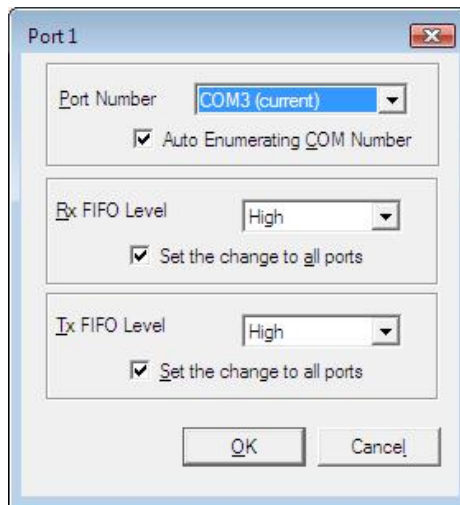

Select **Auto Enumerating COM Number** to map subsequent ports in numerical order. For example, if COM 3 is assigned to Port 1, then COM 4 will be automatically assigned to Port 2.

	Tx FIFO	Rx FIFO
High	128 bytes	120 bytes
Middle	64 bytes	60 bytes
Low	1 byte	1 byte

Select an **Rx FIFO Trigger**. The default value is 120 bytes (high level). Select **Set the change to all ports** to use this setting for all serial ports on the module.

Select a **Tx FIFO Size**. The default value is 128 bytes (high level). Select **Set the change to all ports** to use this setting for all serial ports on the module.

3. Click **OK** to approve the port settings. Click **OK** again to close the **CB Series Properties** window and apply the new port settings.

Windows XP, 2003 (32-bit and 64-bit)

The Windows XP and 2003 (32-bit and 64-bit) drivers conform to the Win32 COMM API standard and support all models in the CB Series. In the following instructions, the CB-114 is used as an example.

Installing the Driver

1. After the module has been plugged into a *PC/104-Plus* slot, turn the embedded computer on.
2. Windows will automatically detect the new module and the **Found New Hardware Wizard** will open automatically. Select **No, not this time** and click **Next**.



3. Select **Install from a list or specific location (Advanced)** and click **Next** to continue.

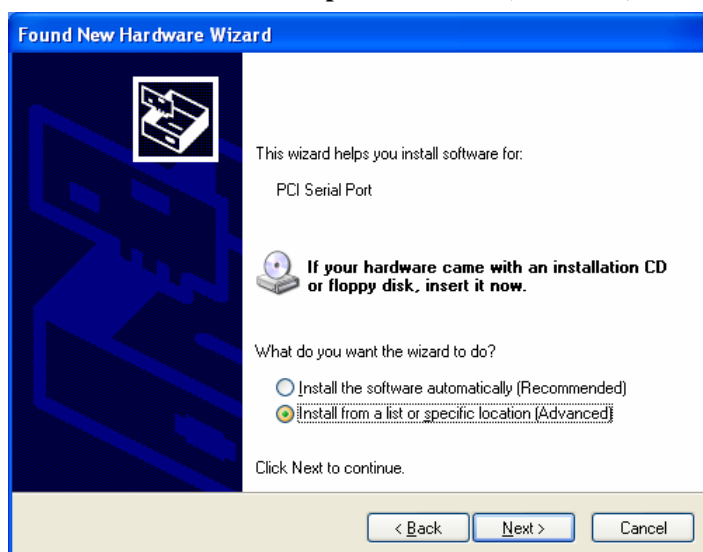

- Click **Browse** to manually specify the folder in which to find the driver. For 32-bit (x86) platforms, select the `\CB Series\Software\Windows XP_2003\x86` folder on the CD. For 64-bit (x64) platforms, select the `\CB Series\Software\Windows XP_2003\x64` folder on the CD. Click **Next** to continue.

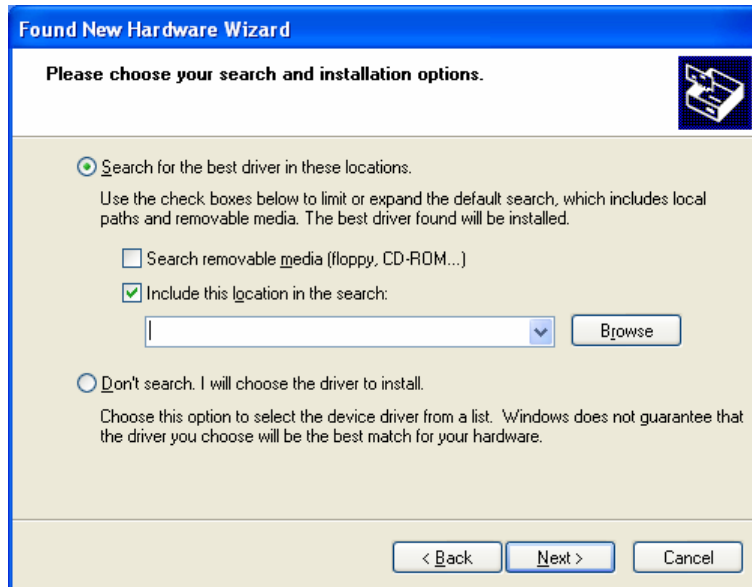

- If you see a warning that the software has not passed Windows Logo testing, click **Continue Anyway**.



- Windows will install the drivers. When the installation is complete, click **Finish**.

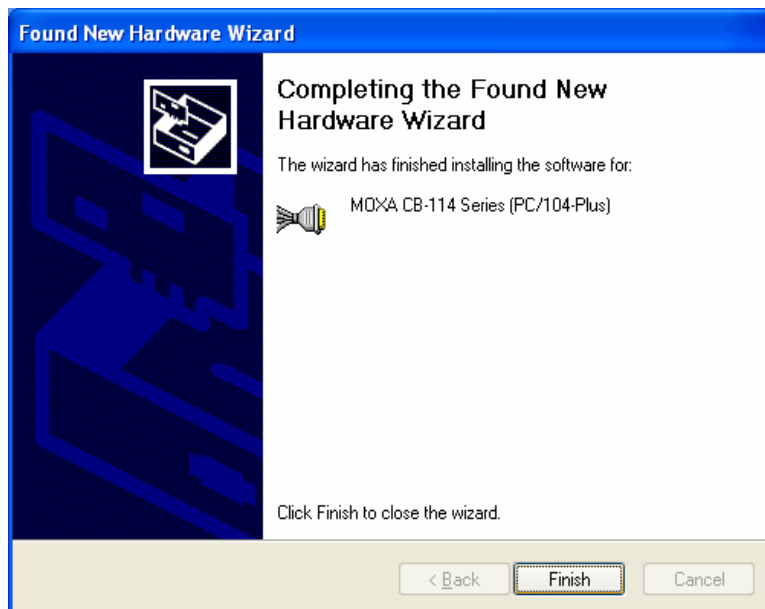
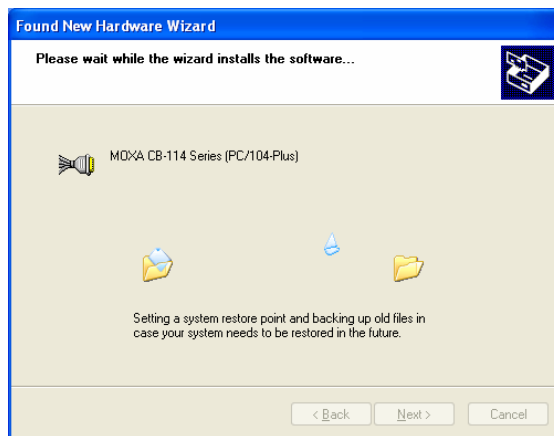

- After the module is installed, you will be prompted to install the new serial ports. A **Found New Hardware Wizard** window will open for the first serial port, port 0. Select **No**, **not this time** and click **Next**.



8. Select **Install from a list or specific location (Advanced)** and click **Next**.

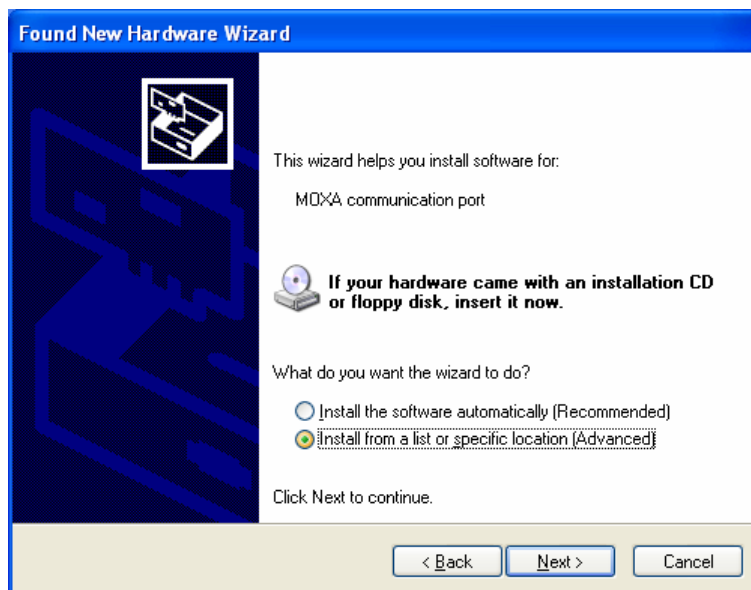

9. Select **Search for the best driver in these locations** and **Include this location in the search**. For 32-bit (x86) platforms, select the `\CB Series\Software\Windows XP_2003\x86` folder on the CD. For 64-bit (x64) platforms, select the `\CB Series\Software\Windows XP_2003\x64` folder on the CD. Click **Next** to continue.

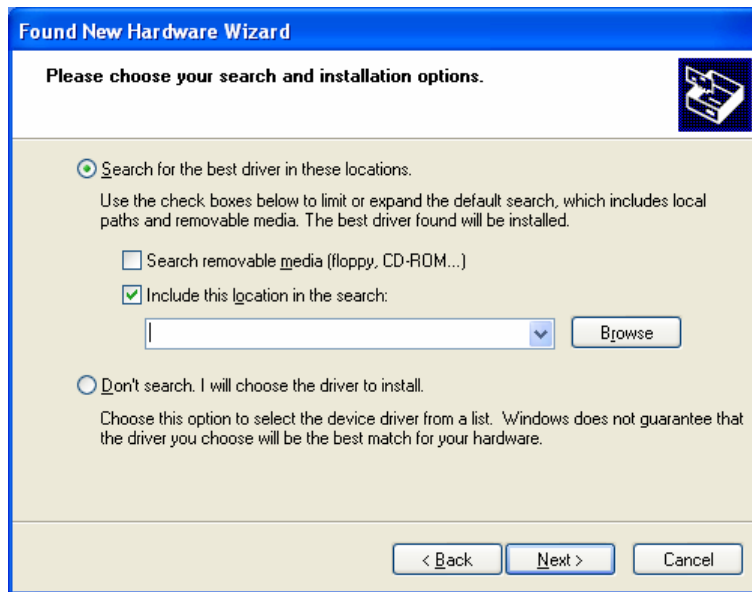

10. If you see a warning that the software has not passed Windows Logo testing, click **Continue Anyway**.

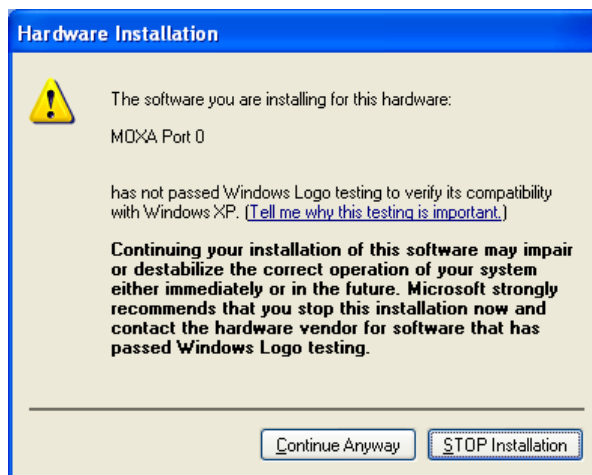

11. Windows will install the necessary drivers.

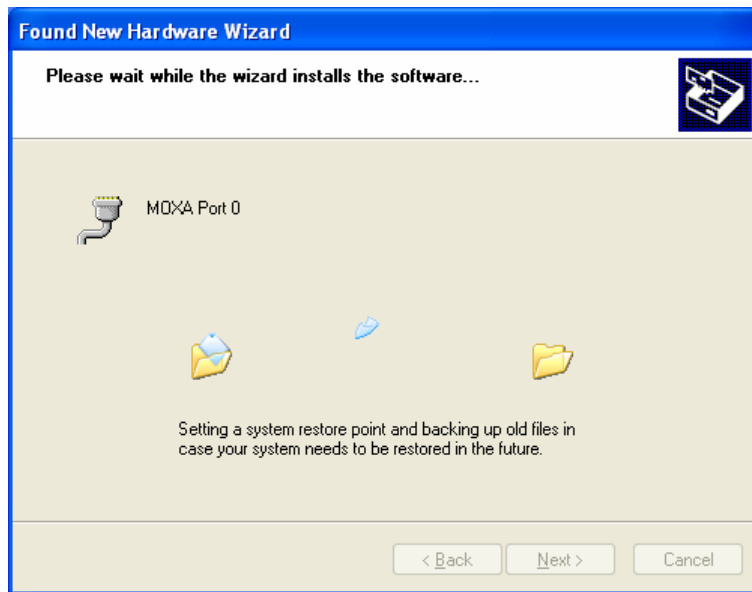

12. After the installation is complete, click **Finish**.

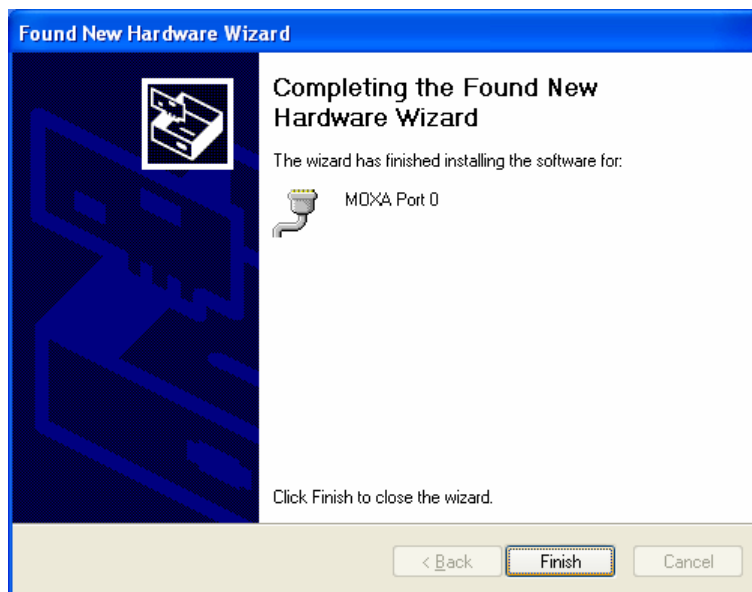

13. Repeat the installation process for the remaining serial ports.

Using Device Manager to Verify Installation

You can use Windows Device Manager to verify proper installation of the CB Series module. In the following instructions, the CB-114 is used as an example.

1. Right-click **My Computer** and select **Properties** in the context menu.

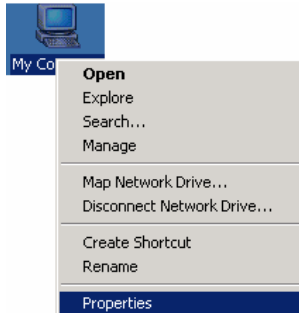

2. In the **Hardware** tab, click **Device Manager**.

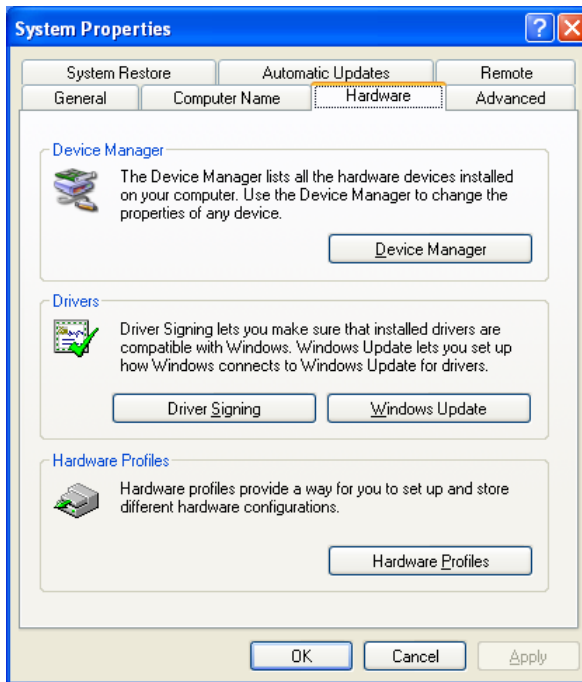

3. In the **Device Manager** window, you should see your CB Series module under **Multi-port serial adapters**. You should also see Moxa communication ports under **Ports (COM & LPT)**.

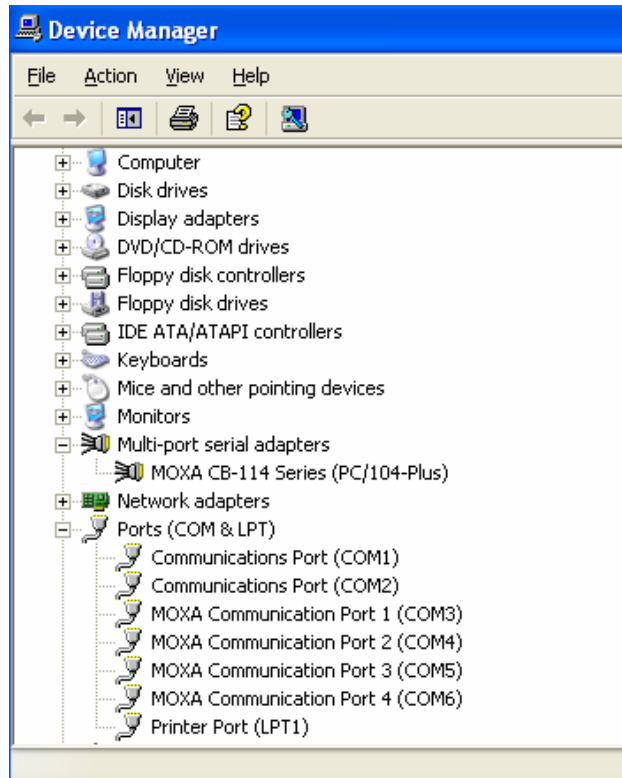

4. If you see any special marks, such as a question mark or an exclamation mark, next to the Moxa items, the installation of your module or serial ports was not successful. Examine the Windows event log for details.

Port Configuration

After the driver is installed, a CB Series Properties window will appear. The system will map the serial ports automatically. It will prompt you to take care of port configuration if another CB Series module has been installed on the PC.

1. Select a specific port under the **Port Configuration** tab and click **Port Setting**.

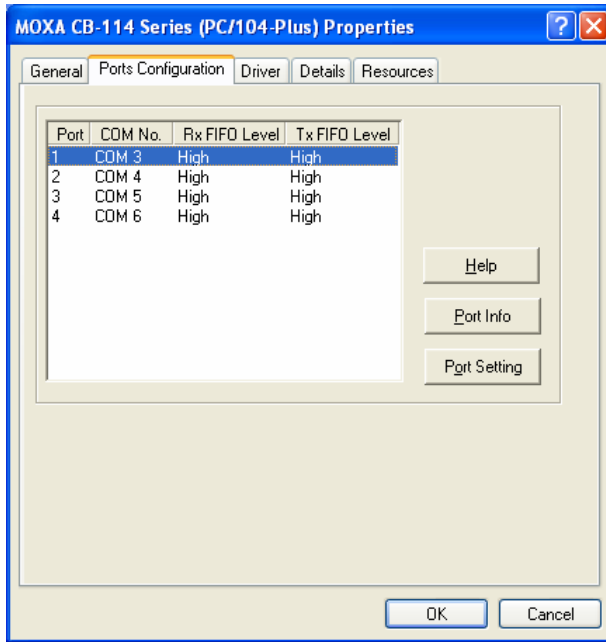

- Under **Port Number**, select a COM number to assign to the serial port.

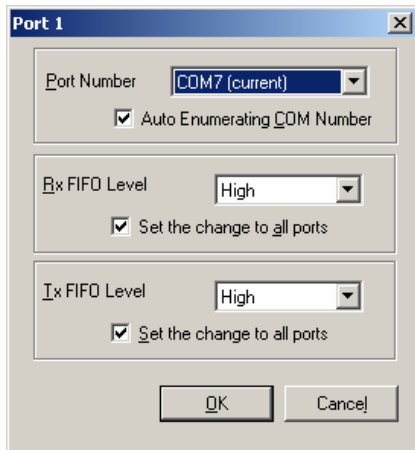

Select **Auto Enumerating COM Number** to map subsequent ports in numerical order. For example, if COM 3 is assigned to Port 1, then COM 4 will be automatically assigned to Port 2.

	Tx FIFO	Rx FIFO
High	128 bytes	120 bytes
Middle	64 bytes	60 bytes
Low	1 byte	1 byte

Select an **Rx FIFO Trigger**. The default value is 120 bytes (high level). Select **Set the change to all ports** to use this setting for all serial ports on the module.

Select a **Tx FIFO Size**. The default value is 128 bytes (high level). Select **Set the change to all ports** to use this setting for all serial ports on the module.

- Click **OK** to approve the port settings. Click **OK** again to close the **CB Series Properties** window and apply the new port settings.

Using PComm

PComm Diagnostic is a useful program for checking the module's status. It provides internal and external testing of IRQ, TxD/RxD, UART, CTS/RTS, DTR/DSR, and other items. You can use PComm Diagnostic to verify that the module and serial ports are working properly.

You can download the free version of PComm at Moxa's website (www.moxa.com).

Using Event Log

You may refer to the Windows event log to verify operation of the module. To view the event log, open Event Viewer, which is located under Administrative Tools in the Control Panel. Information about the module will be located under the System category.

Disabling the Module

1. Right-click **My Computer** and select **Properties** in the context menu.

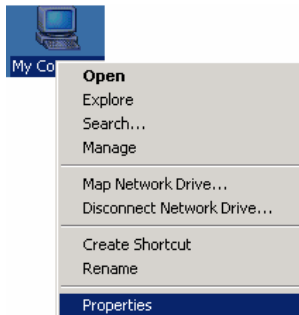

2. In the **Hardware** tab, click **Device Manager**.

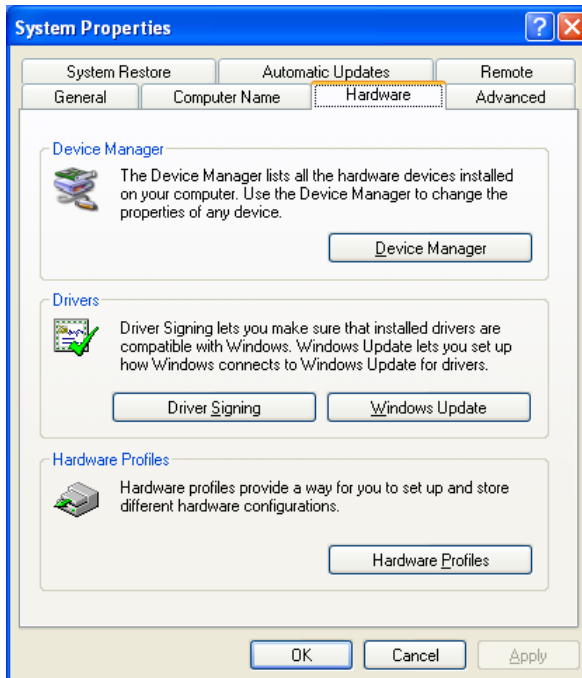

3. In **Device Manager**, right-click your module under **Multi-port serial adapters** and select **Disable** in the context menu. This will disable the module.

Uninstalling the Module

1. Right-click **My Computer** and select **Properties** in the context menu.

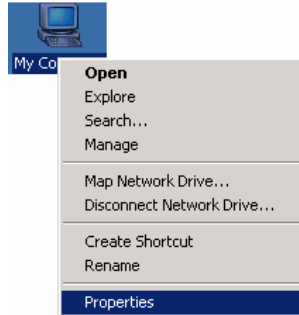

2. In the **Hardware** tab, click **Device Manager**.

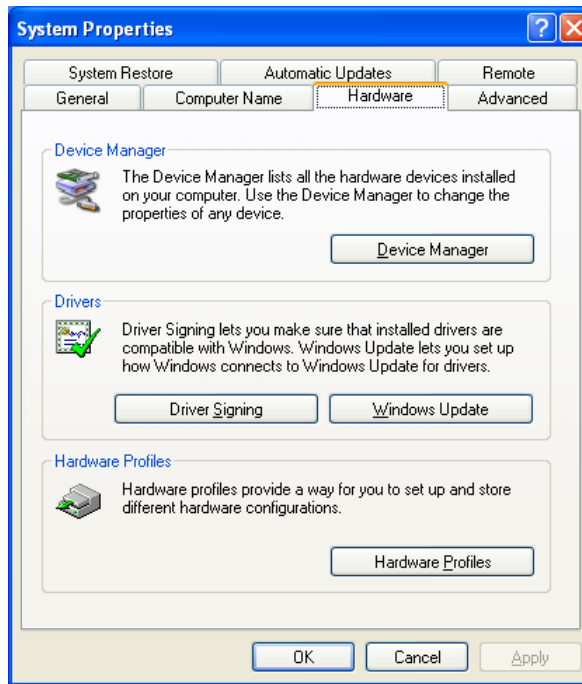

- Right-click your module under **Multi-port serial adapters** and select **Uninstall** in the context menu.

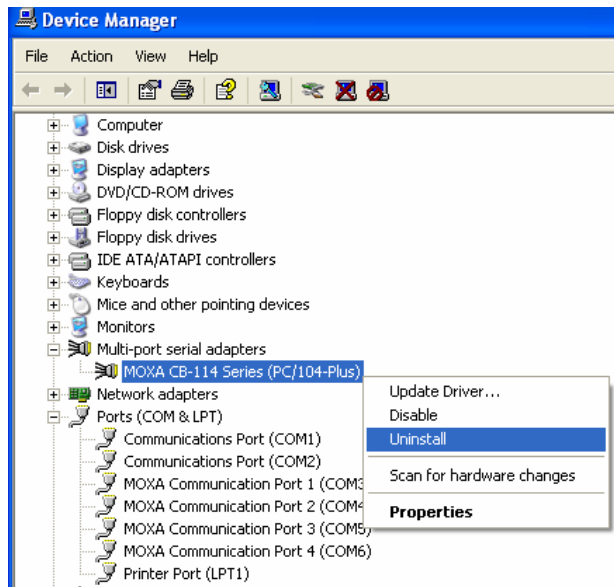

- A confirmation dialog will appear. Click **OK** to uninstall the device.

Windows 2000

The Windows 2000 drivers conform to the Win32 COMM API standard and support all models in the CB Series. In the following instructions, the CB-114 is used as an example.

Installing the Driver

- After the module has been plugged into a *PC/104-Plus* slot, turn the embedded computer on.
- Windows will automatically detect the new module and the **Found New Hardware Wizard** will open automatically. Click **Next** to continue.



3. Select **Search for a suitable driver for my device (recommended)** and click **Next** to continue.



4. Select **Specify a location** and click **Next** to continue.

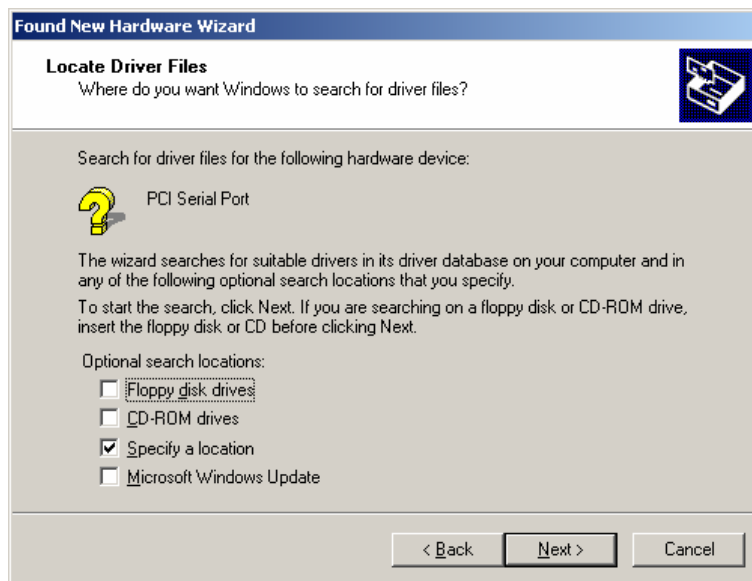

- Click **Browse** to manually specify the folder in which to find the driver. Select the **\CB Series\Software\Windows 2K** folder on the CD and click **Next** to continue.



- To begin installing the module, click **Next**.

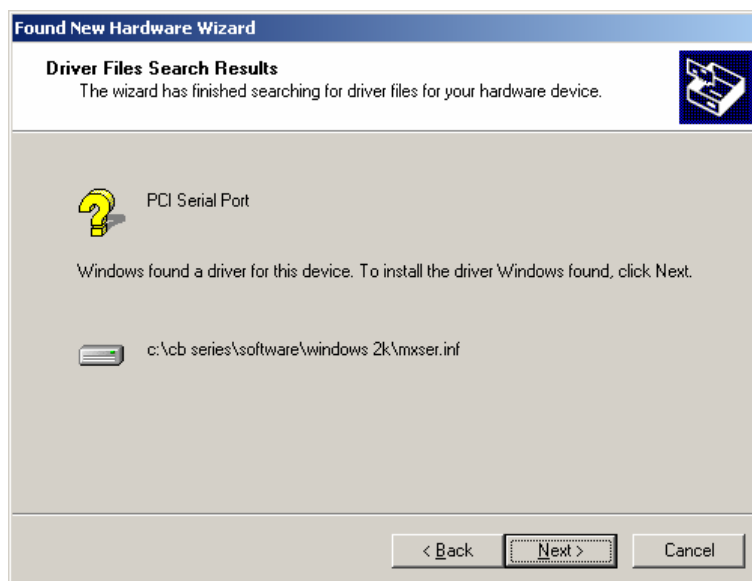

- If you see a warning that the Microsoft digital signature was not found, click **Yes** to proceed with the installation.

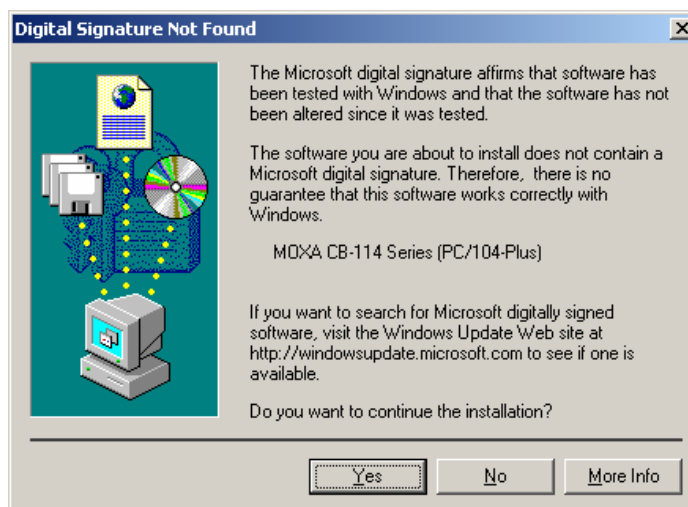

8. Windows will install the drivers. When the installation is complete, click **Finish**.

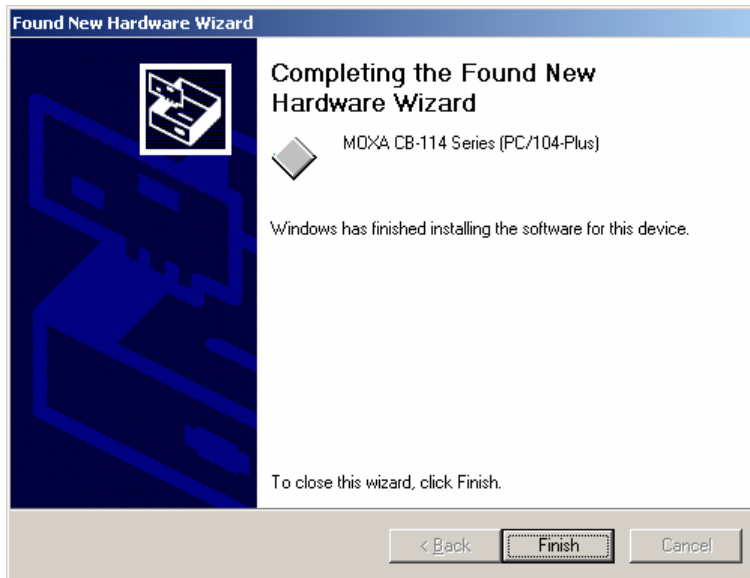

9. After the module is installed, you will be prompted to install the new serial ports. A **Found New Hardware Wizard** window will open for the first serial port, port 0. Click **Next** to proceed.



10. Select **Search for a suitable driver for my device [recommended]** and click **Next**.



11. Select **Specify a location** and click **Next**.

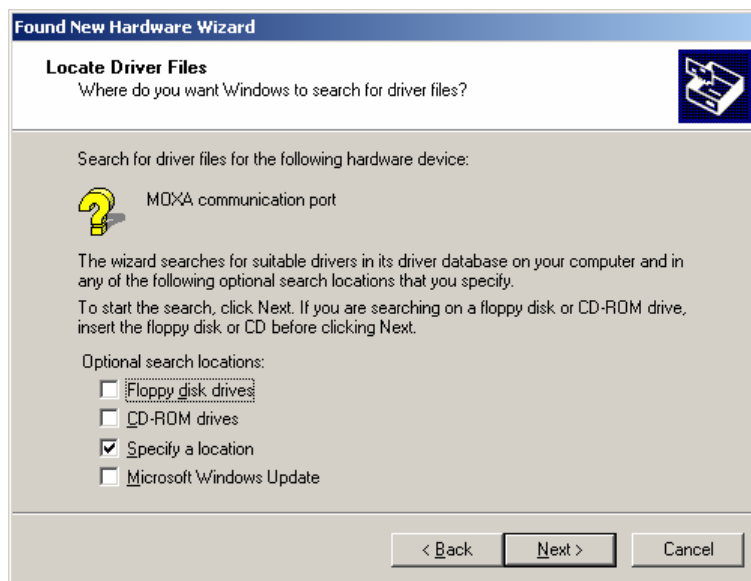

12. Select the **\CB Series\Software\Windows 2K** folder on the CD and click **Next**.



- When the driver has been found, click **Next** to proceed.

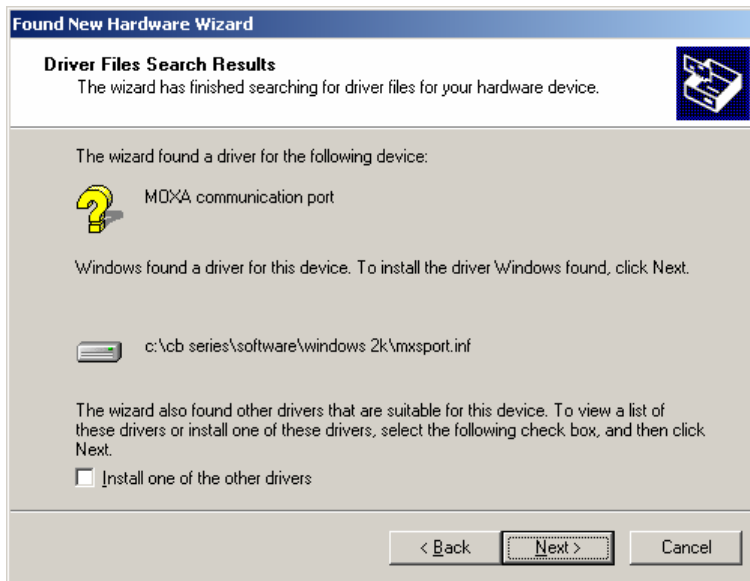

- Windows will install the necessary drivers. After the installation is complete, click **Finish**.

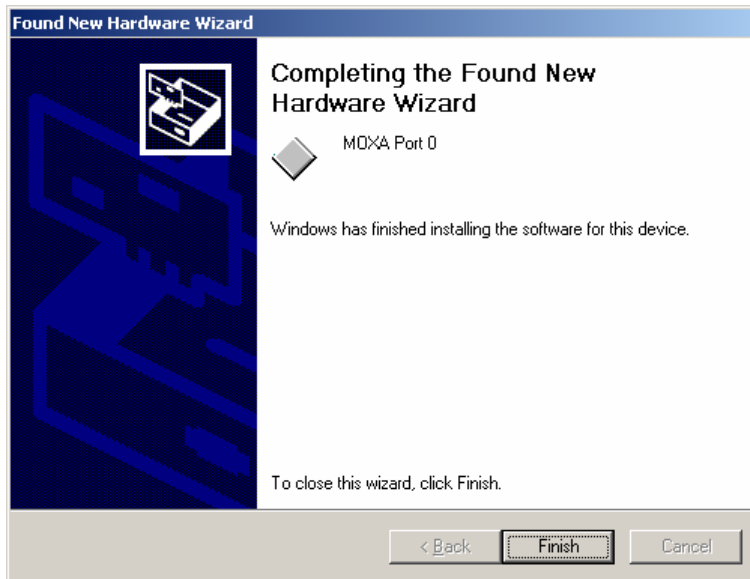

The remaining serial ports will be installed automatically in the background.

Using Device Manager to Verify Installation

You can use Windows Device Manager to verify proper installation of the CB Series module. In the following instructions, the CB-114 is used as an example.

1. Right-click **My Computer** and select **Properties** in the context menu.

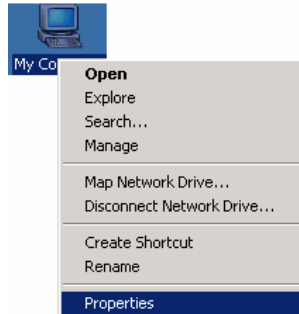

2. In the **Hardware** tab, click **Device Manager**.

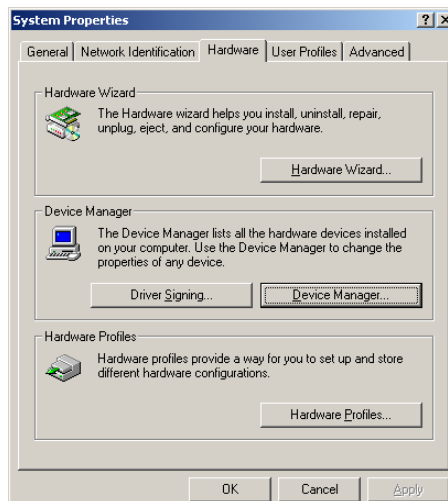

3. In the **Device Manager** window, you should see your CB Series module under **Multi-port serial adapters**. You should also see Moxa communication ports under **Ports (COM & LPT)**.

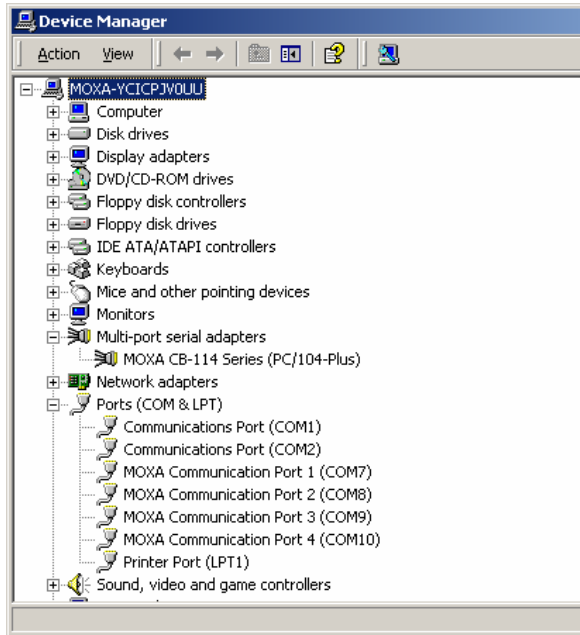

4. If you see any special marks, such as a question mark or an exclamation mark, next to the Moxa items, the installation of your module or serial ports was not successful. You can check the Windows event log for details.

Port Configuration

After the driver is installed, a CB Series Properties window will appear. The system will map the serial ports automatically. It will prompt you to take care of port configuration if another CB Series module has been installed on the PC.

1. Select a specific port under the **Port Configuration** tab and click **Port Setting**.

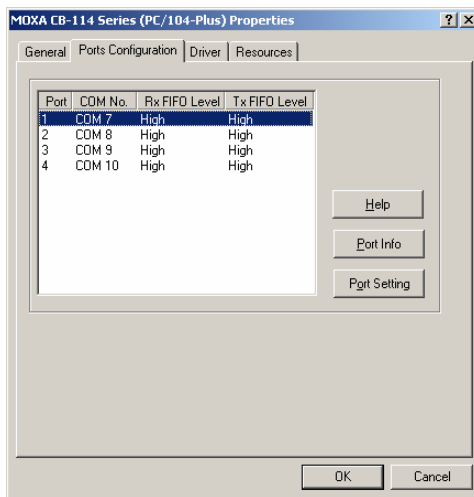

- Under **Port Number**, select a COM number to assign to the serial port.

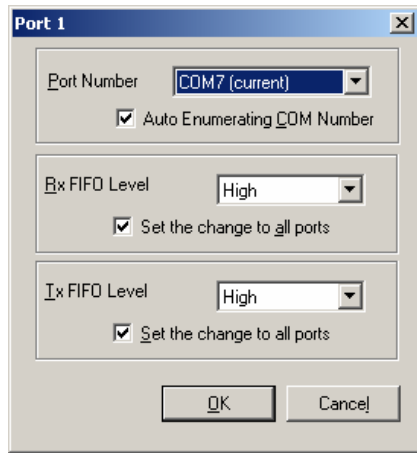

Select **Auto Enumerating COM Number** to map subsequent ports in numerical order. For example, if COM 3 is assigned to Port 1, then COM 4 will be automatically assigned to Port 2.

	Tx FIFO	Rx FIFO
High	128 bytes	120 bytes
Middle	64 bytes	60 bytes
Low	1 byte	1 byte

Select an **Rx FIFO Trigger**. The default value is 120 bytes (high level). Select **Set the change to all ports** to use this setting for all serial ports on the module.

Select a **Tx FIFO Size**. The default value is 128 bytes (high level). Select **Set the change to all ports** to use this setting for all serial ports on the module.

- Click **OK** to approve the port settings. Click **OK** again to close the **CB Series Properties** window and apply the new port settings.

Using PComm

PComm Diagnostic is a useful program for checking the module's status. It provides internal and external testing of IRQ, Tx/D/RxD, UART, CTS/RTS, DTR/DSR, and other items. You can use PComm Diagnostic to verify that the module and serial ports are working properly.

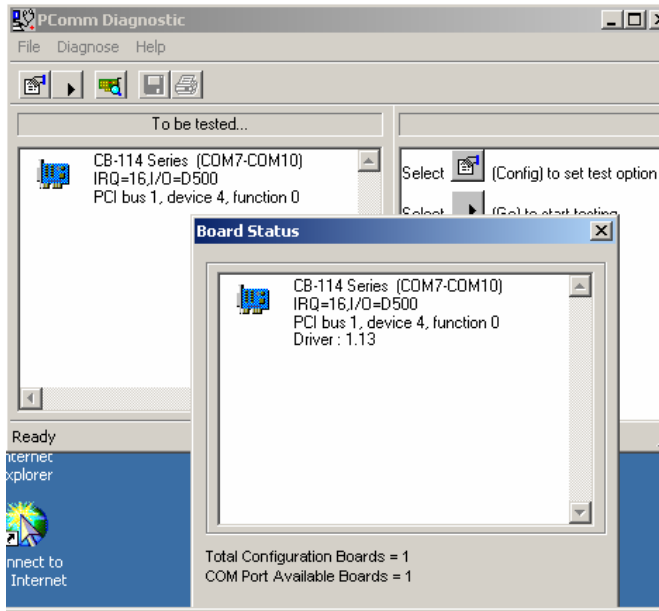

The free version of PComm is available at Moxa's website (www.moxa.com).

Using Event Log

You may refer to the Windows event log to verify operation of the module. To view the event log, open Event Viewer, which is located under Administrative Tools in the Control Panel. Information about the module will be located under the System category.

Disabling the Module

1. Right-click **My Computer** and select **Properties** in the context menu.

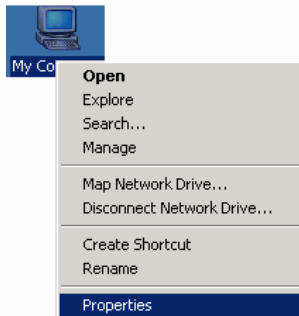

2. In the **Hardware** tab, click **Device Manager**.

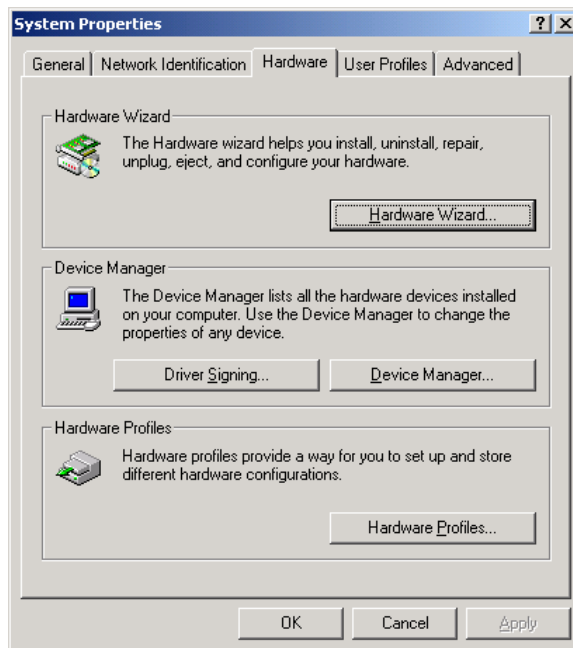

3. In **Device Manager**, right-click your module under **Multi-port serial adapters** and select **Disable** in the context menu. This will disable the module.

Uninstalling the Module

1. Right-click **My Computer** and select **Properties** in the context menu.

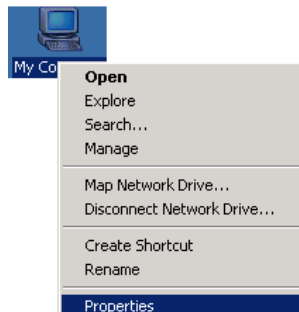

2. In the **Hardware** tab, click **Device Manager**.

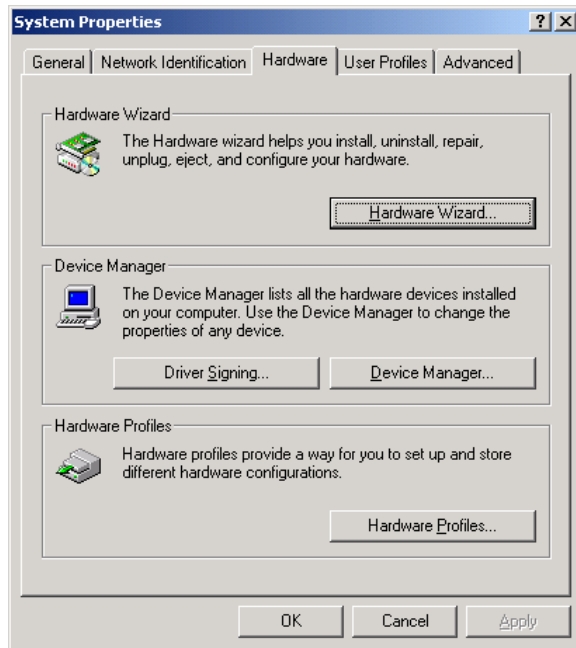

3. Right-click your module under **Multi-port serial adapters** and select **Uninstall** in the context menu.

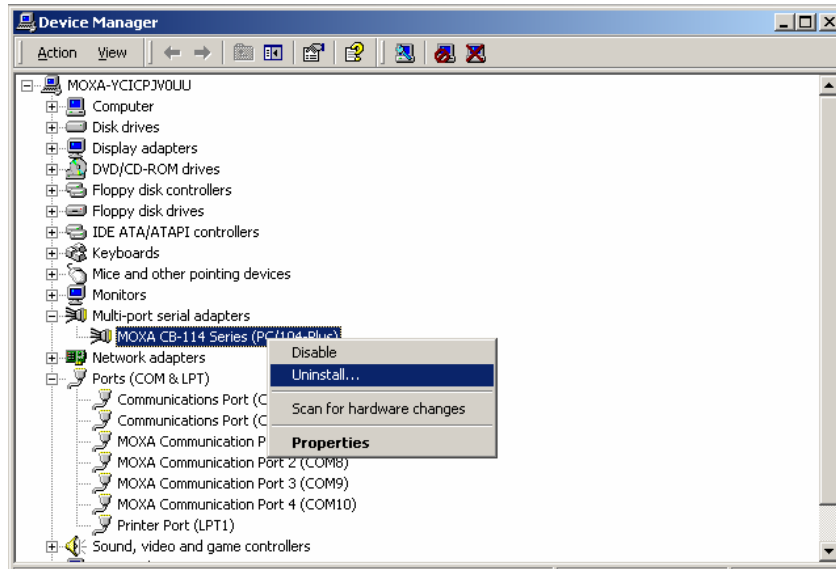

4. A confirmation dialog will appear. Click **OK** to uninstall the device.

Linux (32-bit and 64-bit)

Execute the following commands from the Linux prompt:

```
#mount /dev/cdrom /mnt/cdrom
#cd /
#mkdir moxa
#cd moxa
#cp /mnt/cdrom/<driver directory>/mxser.tgz .
#tar xvfz mxser.tgz

#cd mxser
# make clean; make install

#cd /moxa/mxser/driver
#./msmknod

#modprobe mxser
```

You can use the Moxa diagnostic utility to verify the driver status:

```
#cd /moxa/mxser/utility/diag
#./msdiag
```

You can use the Moxa terminal utility to test the tty ports:

```
#cd /moxa/mxser/utility/term
#./msterm
```

DOS

Moxa DOS API-232 is a software package that can help you develop or debug serial communications programs. This section will explain how to install the package, set up the driver, and load or unload the driver. For additional information about the API-232 library and utilities, please refer to Chapter 4.

The DOS drivers support all models in the CB Series.

In the following instructions, the CB-104 is used as an example.

Installing the Driver

Run the installation program, **DOSINST.EXE**, in the DOS folder. Specify the target directory for the API-232 files (e.g., **C:\MOXA**). Press **F2** to start the installation.



After installation is complete, you will be prompted to set up the board and driver initial values. We strongly recommended that you do so.



Driver Setup

The following instructions are not intended to illustrate every function of the setup program. For more detailed information, please refer to the help files by pressing F1 in the setup program.

1. Run the setup program, **BIN\SETUP.EXE**.
2. Select your CB Series model and press **Enter**.
3. A window will open displaying all configuration information for all installed modules. Press **PgDn** to view advanced port setup options and to make configuration changes. Your module's configuration will be displayed along with other settings such as port number, buffer size, etc.
4. Verify the settings and make any necessary changes.



Port number: This is the port ID of each port. Application software will refer to a port by its port number (ID). Port numbers must be unique; duplicate port numbers are not allowed. The port ID can range from 0 to 127 as long as it does not overlap with another port. Generally, you should consider the convenience of programming when specifying the port number.

TxD buffer size: This is the transmission (output) buffer allocated in the system for each port.

RxD buffer size: This is the receiving (input) buffer allocated in the system for each port.

F5: Group Edit: This allows you to configure several ports simultaneously as a group.



5. Press **F10** to save the latest configuration and exit the setup program.

Loading the Driver

After setting up the driver, you must load the driver in order to gain access to the serial ports on the module. Run **BIN\DPC-DRV.EXE** at the DOS prompt. The driver will detect your CB Series module automatically. You should see messages indicating successful detection of your module, such as the following:

```
Smartio/Industio Family DOS driver Version 1.8
Setup driver ...
CB-114 series (Bus=x, Dev=y) : OK!
Device driver setup O.K.
```

At this point, you can execute applications that support API-232 functions, or start developing applications using the API-232 library.

Unloading the Driver

To unload or release the CB Series driver from memory, enter **DPC-DRV/Q** at the DOS prompt.

Windows CE 5.0

In this section, we explain how to install Moxa CB series boards under WinCE 5.0. These instructions are intended for users who are familiar with the Windows CE Platform Builder 5.0 Toolkit, and would like to install one or more Moxa Tech products. Here, we only give the step-by-step installation instructions for the development environment. You will need to download the image file to the target host yourself.

The WinCE 5.0 driver for the Moxa CB Series PC/104-Plus Multiport Serial Module supports the following products:

- CB Series: CB-108, CB-114, CB-134I

The CB-114 board is used to illustrate the installation procedure.

Installing the driver

The following procedure explains how to install the CB-114 multiport serial module driver under WinCE.

1. Obtain a copy of Moxa Tech WinCE 5.0 driver package and extract it to your computer. Double click the Install package to copy the **Mxser** folder to %WINCEROOT%\PLATFORM\ automatically, and import the supported MOXA Tech products into the **Folder**.

2. Start WinCE Platform Builder, select **File**, and open **New Platform**.

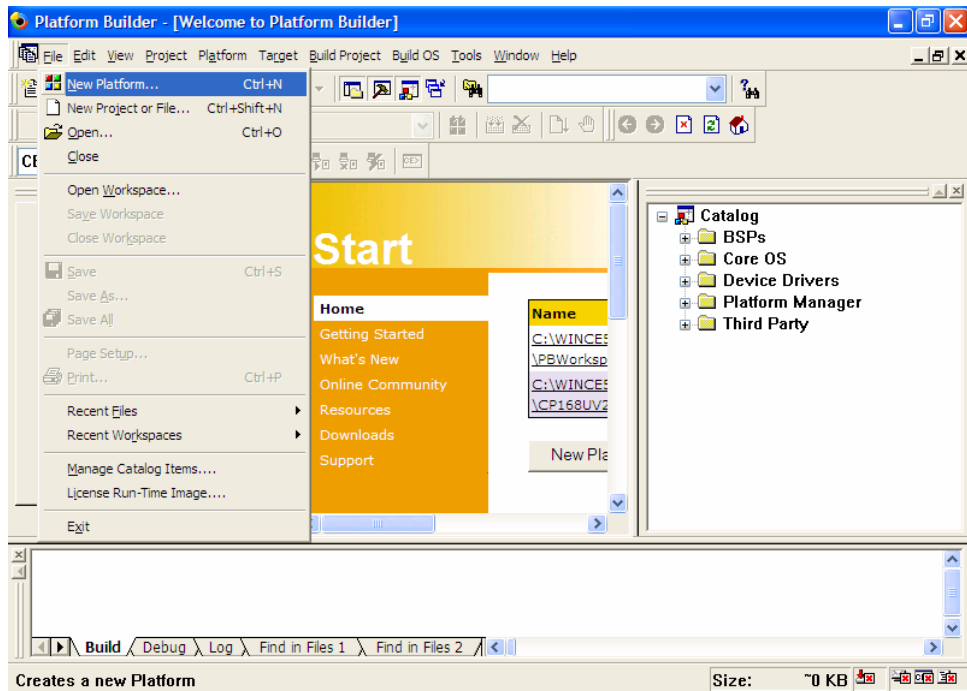

3. Enter a Name for Workspace and press **Next**.

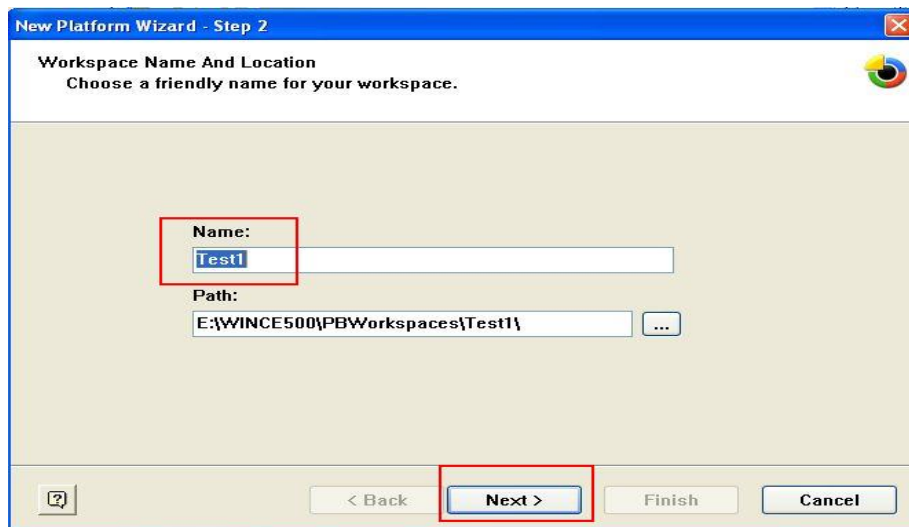

4. When you see **Board Support Packages, Design Template, Applications & Media, Networking & Communications, OBEX Server**, select what you need to build your own environment. The **Completing the New Platform Wizard** window will open to indicate that it has finished creating a new platform. Click **Finish** to complete the setup.

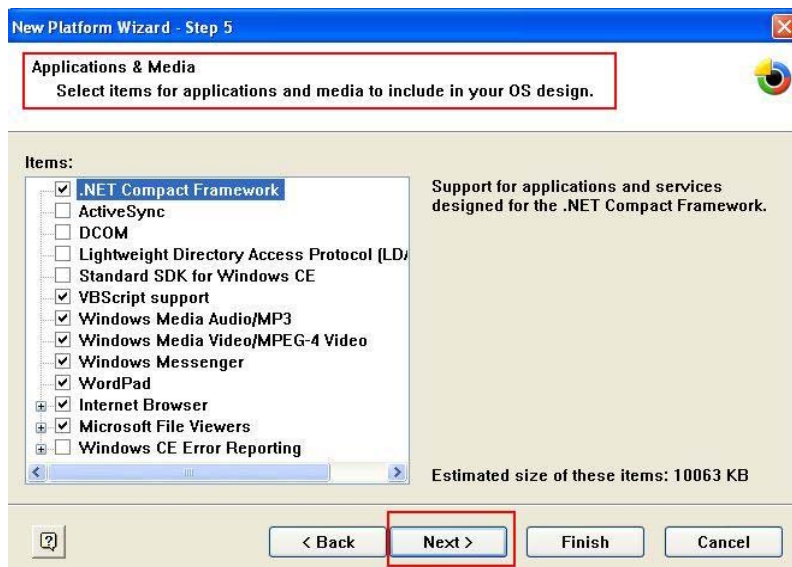
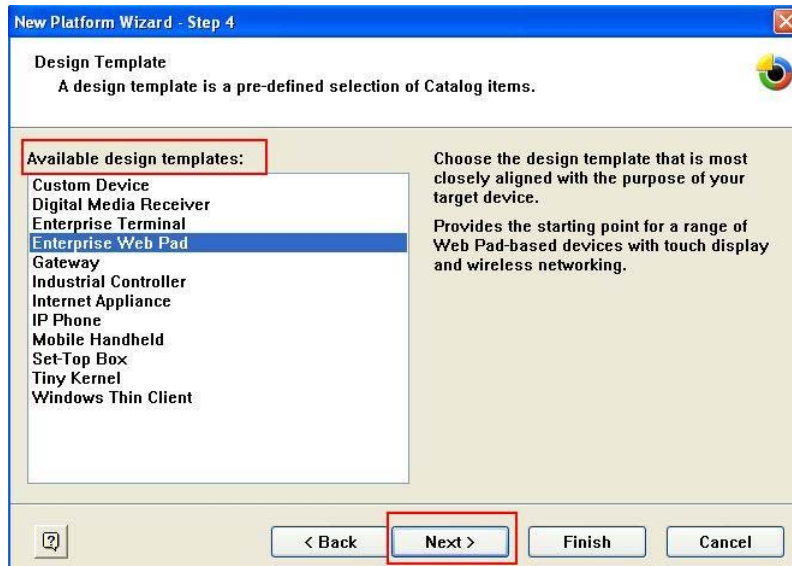

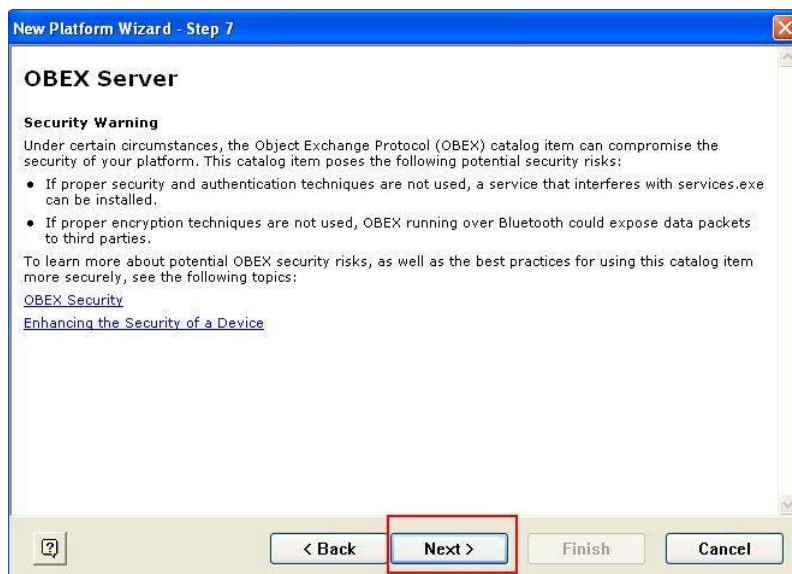
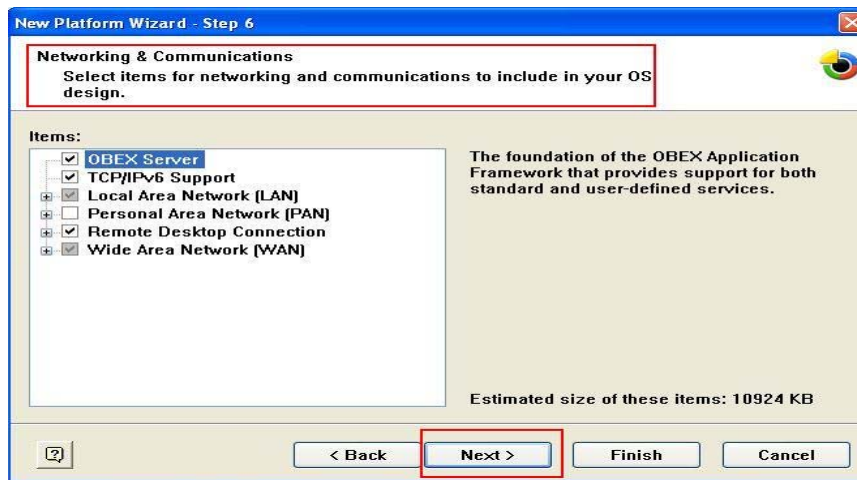



5. Open Manage Catalog Items (**File → Manage Catalog Items**). In the Catalog (**View → Catalog**), browse to **\Third Party\Device Drivers\ MOXA Smartio/Industio-PCI, PC/104-Plus**. Right-click on the driver **Prefix COM** or **Prefix MXU** you would like to include and choose **Add to OS Design**.

Note: You can only select either **Prefix COM** or **Prefix MXU**, but not both.

Prefix COM supports up to 10 ports, from COM0 to COM9. Prefix MXU supports more than 10 ports, so it is better for you to select Prefix MXU if you are not sure how many ports the device has. Otherwise, you will only be allowed to use one multiport serial board on the target host.

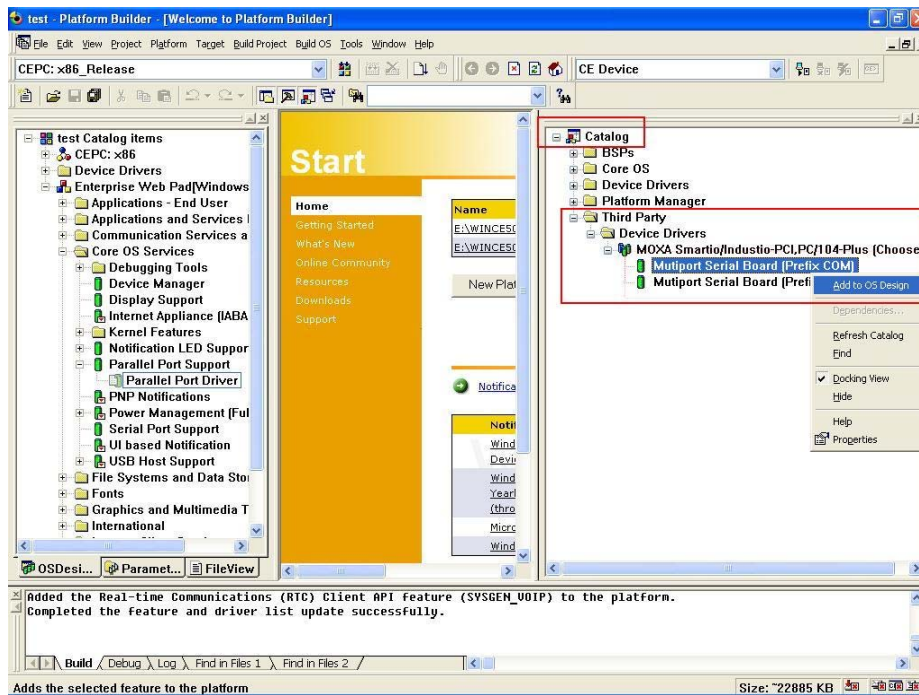

- After adding Moxa Tech drivers into your **OS Design**, a new project is automatically added to your workspace. The project name is **mxserce5**. The project can be accessed from File View (**View → File View**). The **mxserce5** project contains a number of files used to configure the drivers included in your **OS Design**.

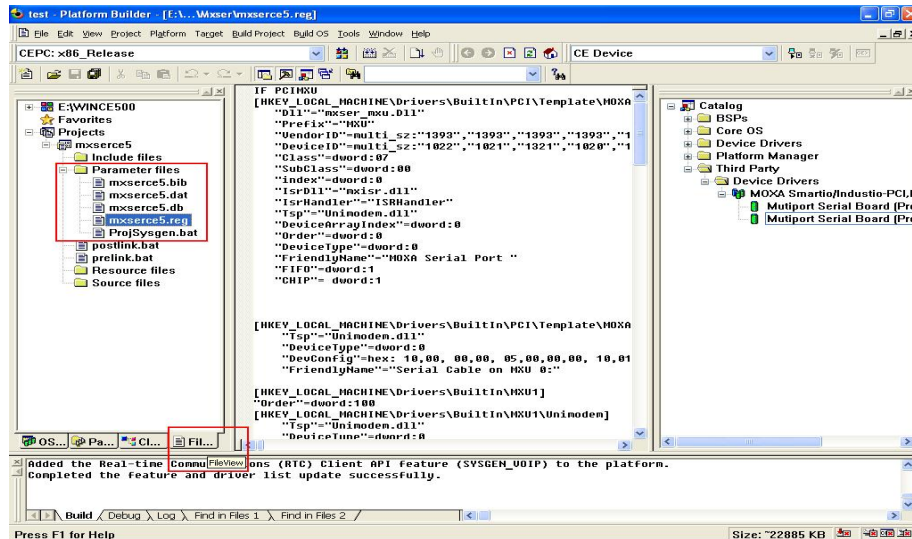

Note: If you would like to use “Terminal Emulator” tool, please modify mxserce5.reg and keyboard like below (This is only just for “one” “COM” port). You have to notice number of ports, COM, MXU and enter the correct information.

```
[HKEY_LOCAL_MACHINE\ExtModems\HayesCompat1]
"Port"="COM2:"
"DeviceType"=dword:1
"FriendlyName"="Hayes Compatible on COM2:"
```

- Finally, open **Build OS**, select **Build and Sysgen**, and be sure to click **Copy Files to Release Directory After Build** and **Make Run-Time Image After Build**.

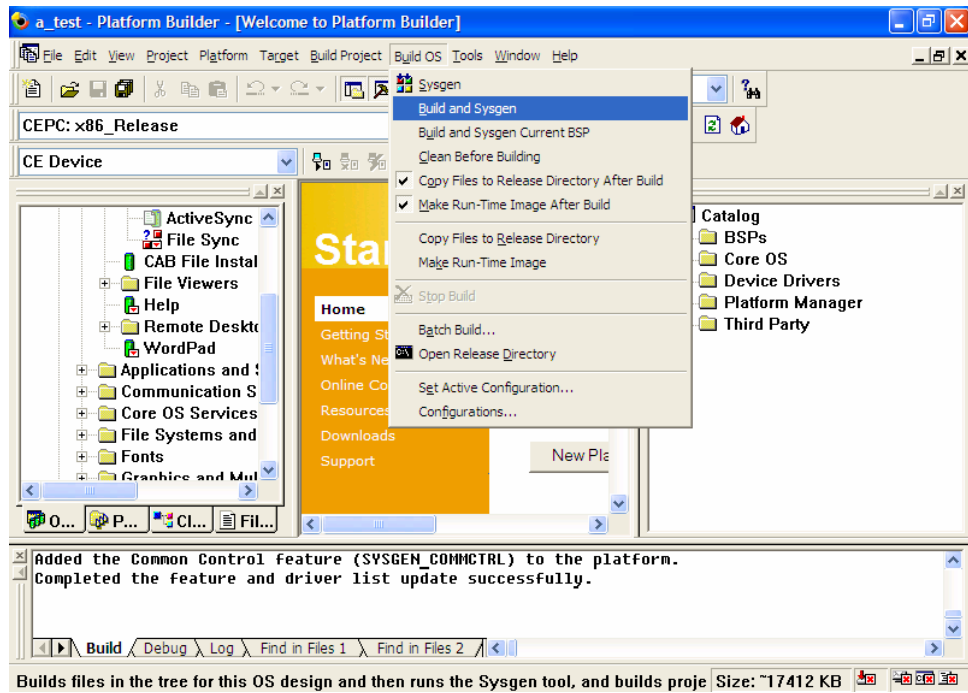

8. Finally, copy your image file to the target Host.

Note: If you have created a Windows CE Platform Builder in the development environment, you can skip steps 2, 3, and 4.

Serial Programming Tools

Moxa provides Windows serial programming libraries and troubleshooting utilities that are easy to use and powerful. You can use these tools to reduce software development time.

The serial communication library is useful for developing applications for data communications, remote access, data acquisition, and industrial control. It provides a simpler solution compared to the more complex Windows Win32 COMM API.

PComm is a professional serial communication tool for Windows PCs. PComm includes the following features:

- Useful utilities for diagnostics, port monitoring, and terminal emulation
- Sample programs
- Comprehensive help files

The following topics are covered in this chapter:

- ❑ **Serial Programming Library**
- ❑ **PComm Utilities**
 - Installation
 - PComm Diagnostic
 - PComm Monitor
 - PComm Terminal Emulator

Serial Programming Library

The serial programming library assists you in developing serial communications programs for any COM port that complies with the Microsoft Win32 API. It facilitates the implementation of multi-process and multi-thread serial communication programs and can remarkably reduce development time.

The library provides a complete set of functions as well as various sample programs for Visual C++, Visual Basic, and Delphi. To view detailed descriptions of the available functions and sample programs, go to **Start → Program → PComm Lite** and select **PComm Lib Help**, **PComm Porting Notes**, or **PComm Programming Guide**. You may also refer to the sample programs in the PComm directory.

PComm Utilities

This section provides brief descriptions of the PComm utilities. For more information about these utilities, please refer to the help files or to the API-232.txt file for DOS.

Installation

To install PComm, run **Setup.exe** from the installation diskette. Please note that the PComm diagnostic and monitor utilities are for Moxa boards only. These two utilities will not work with other serial boards.

PComm Diagnostic

PComm Diagnostic is designed for Moxa boards only. It provides internal and external testing of IRQ, TxD/RxD, UART, CTS/RTS, DTR/DSR, DTR/DCD, and other items. You can use PComm Diagnostic to check the operation of both software and hardware.

To run the Diagnostic program, go to **Start → Program → PComm Lite → Diagnostic**.

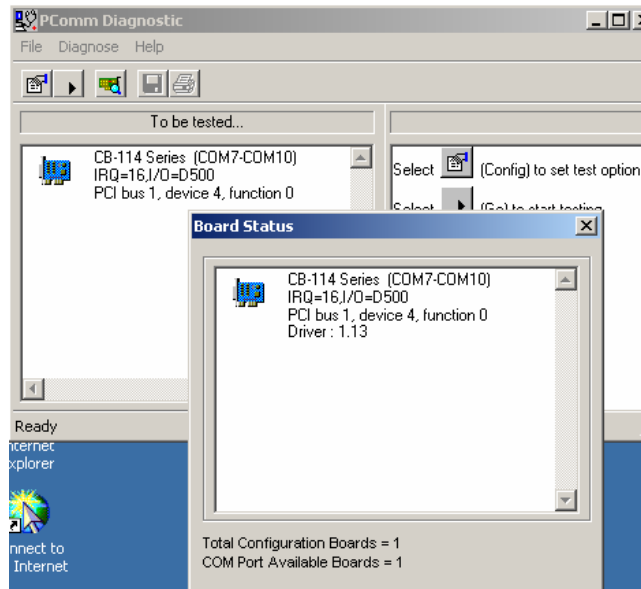

PComm Monitor

PComm Monitor is designed for Moxa board in Windows NT only. It allows you to monitor data transmission of selected MOXA COM ports. It monitors data transmission, throughput, and line status at regular intervals. Click on a specific port to view that port's communication parameters and status.

To run PComm Monitor, go to **Start → Program → PComm Lite → Monitor**.

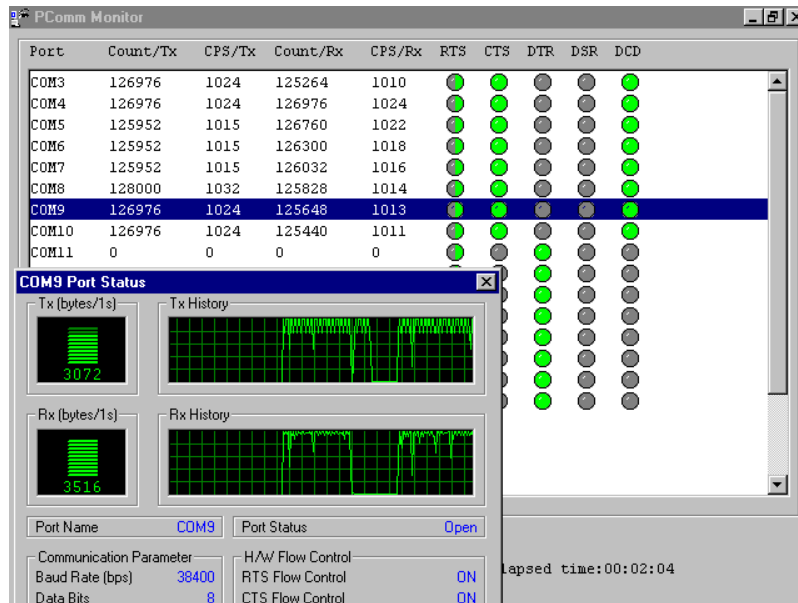

PComm Terminal Emulator

PComm Terminal Emulator can be used to connect to a serial port to verify that data transmission is functioning correctly. It supports multiple windows and both VT100 and ANSI terminal types. You can interactively transfer data, periodically send patterns, and transfer files using ASCII, XMODEM, YMODEM, ZMODEM, and KERMIT protocols.

To run PComm Terminal Emulator, go to **Start → Program → PComm Lite → Terminal Emulator**.

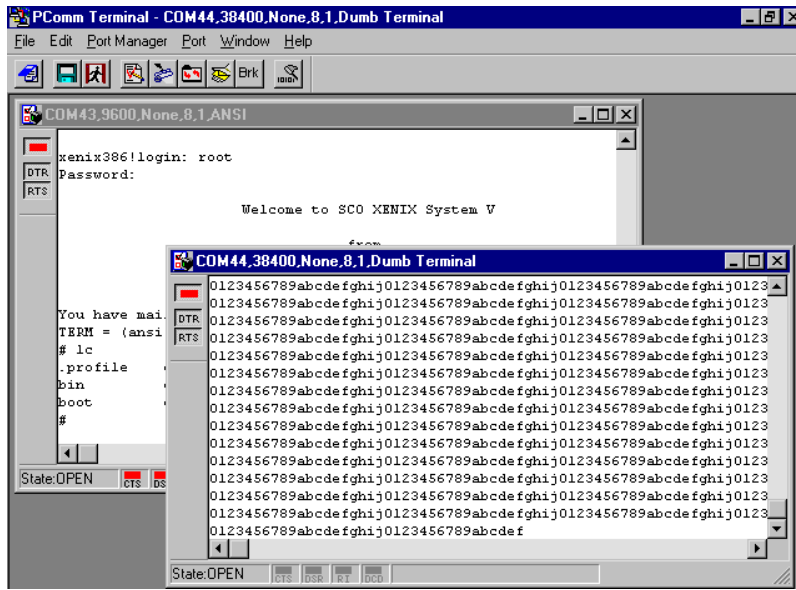

Pin Assignments

The box header connector(s) on the module is used to connect to serial devices. Optional cables are available that provide DB9 or DB25 connectors. The pin assignments of the box header connectors and available cables are provided below.

Box Header Pin Assignments

RS-232

These pin assignments apply to the CB-108 and CB-114. Note that there are two 40-pin box header connectors on the CB-108, each of which connects to 4 serial ports.

Pin	Signal	Pin	Signal	Pin	Signal	Pin	Signal
1	DCD0	11	DCD1	21	DCD2	31	DCD3
2	DSR0	12	DSR1	22	DSR2	32	DSR3
3	RxD0	13	RxD1	23	RxD2	33	RxD3
4	RTS0	14	RTS1	24	RTS2	34	RTS3
5	TxD0	15	TxD1	25	TxD2	35	TxD3
6	CTS0	16	CTS1	26	CTS2	36	CTS3
7	DTR0	17	DTR1	27	DTR2	37	DTR3
8	---	18	---	28	---	38	---
9	GND0	19	GND1	29	GND2	39	GND3
10	---	20	---	30	---	40	---

RS-422, 4-wire RS-485

These pin assignments apply to the CB-114 and CB134I.

Pin	Signal	Pin	Signal	Pin	Signal	Pin	Signal
1	TxD0-(A)	11	TxD1-(A)	21	TxD2-(A)	31	TxD3-(A)
3	TxD0+(B)	13	TxD1+(B)	23	TxD2+(B)	33	TxD3+(B)
5	RxD0+(B)	15	RxD1+(B)	25	RxD2+(B)	35	RxD3+(B)
7	RxD0-(A)	17	RxD1-(A)	27	RxD2-(A)	37	RxD3-(A)
9	GND0	19	GND1	29	GND2	39	GND3

2-wire RS-485

These pin assignments apply to the CB-114 and CB134I.

Pin	Signal	Pin	Signal	Pin	Signal	Pin	Signal
5	Data0+(B)	15	Data1+(B)	25	Data2+(B)	35	Data3+(B)
7	Data0-(A)	17	Data1-(A)	27	Data2-(A)	37	Data3-(A)
9	GND0	19	GND1	29	GND2	39	GND3

Serial Cable Pin Assignments

DB9(M) Connectors

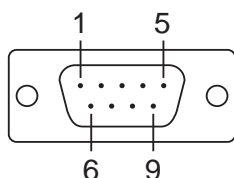

The CBL-F40M9x4-50 and CBL-F20M9x4-50 cables provide DB9 (M) connectors for each serial port, with pin assignments as follows:

Pin	RS-232	RS-422	
		4-wire RS-485	2-wire RS-485
1	DCD	TxD-(A)	---
2	RxD	TxD+(B)	---
3	TxD	RxD+(B)	Data+(B)
4	DTR	RxD-(A)	Data-(A)
5	GND	GND	GND
6	DSR		
7	RTS		
8	CTS		

DB25(M) Connectors

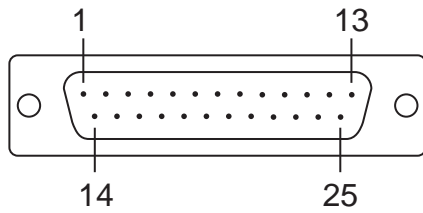

The CBL-F40M25x4-50 and CBL-F20M25x4-50 cables provide DB25 (M) connectors for each serial port, with pin assignments as follows:

Pin	RS-422		
	RS-232	4-wire RS-485	2-wire RS-485
2	TxD	RxD+(B)	Data+(B)
3	RxD	TxD+(B)	---
4	RTS	---	---
5	CTS	---	---
6	DSR	---	---
7	GND	GND	GND
8	DCD	TxD-(A)	---
20	DTR	RxD-(A)	Data-(A)