

UC-8100/UC-8100-ME-T Series Linux Software User's Manual (For Debian 8)

Edition 2.0, April 2018

www.moxa.com/product



© 2018 Moxa Inc. All rights reserved.

UC-8100 Series Linux Software User's Manual

The software described in this manual is furnished under a license agreement and may be used only in accordance with the terms of that agreement.

Copyright Notice

© 2018 Moxa Inc. All rights reserved.

Trademarks

The MOXA logo is a registered trademark of Moxa Inc.
All other trademarks or registered marks in this manual belong to their respective manufacturers.

Disclaimer

Information in this document is subject to change without notice and does not represent a commitment on the part of Moxa.

Moxa provides this document as is, without warranty of any kind, either expressed or implied, including, but not limited to, its particular purpose. Moxa reserves the right to make improvements and/or changes to this manual, or to the products and/or the programs described in this manual, at any time.

Information provided in this manual is intended to be accurate and reliable. However, Moxa assumes no responsibility for its use, or for any infringements on the rights of third parties that may result from its use.

This product might include unintentional technical or typographical errors. Changes are periodically made to the information herein to correct such errors, and these changes are incorporated into new editions of the publication.

Technical Support Contact Information

www.moxa.com/support

Moxa Americas

Toll-free: 1-888-669-2872
Tel: +1-714-528-6777
Fax: +1-714-528-6778

Moxa Europe

Tel: +49-89-3 70 03 99-0
Fax: +49-89-3 70 03 99-99

Moxa India

Tel: +91-80-4172-9088
Fax: +91-80-4132-1045

Moxa China (Shanghai office)

Toll-free: 800-820-5036
Tel: +86-21-5258-9955
Fax: +86-21-5258-5505

Moxa Asia-Pacific

Tel: +886-2-8919-1230
Fax: +886-2-8919-1231

Table of Contents

1. Introduction	1-1
2. Getting Started	2-1
Software Architecture	2-2
Software Packages	2-2
Connecting to the UC-8100-LX	2-2
Connecting through the Serial Console	2-3
SSH Console	2-4
User Account Management	2-6
Switching to the Root Account	2-6
Creating and Deleting User Accounts	2-7
Disabling the Default User Account	2-7
Network Settings	2-7
Configuring Ethernet Interfaces	2-7
Connecting to a Cellular Network	2-9
System Administration	2-9
Querying the Firmware Version	2-9
Adjusting the Time	2-9
Setting the Time Zone	2-10
Determining Available Drive Space	2-11
Enabling and Disabling Daemons	2-11
Package Management	2-12
Shutting Down the Device	2-13
3. Advanced Configuration of Peripherals	3-1
Serial Ports	3-2
Changing the Terminal Settings	3-2
USB Port	3-3
Disabling the USB Port	3-3
USB Automount	3-4
SD and MicroSD Slot	3-4
Enabling Write Protection	3-5
Preparing a Bootable SD Card (UC-8100 Series Only)	3-6
Creating a Linux System Image Using a Windows Platform	3-6
Creating a System Image in a Linux Environment	3-7
Booting up the UC-8100-LX for the First Time	3-8
File System Resizing	3-8
Booting from a MicroSD Card (UC-8112 Only)	3-8
Firmware Update Using an SD Card (UC-8100-ME-T Series Only)	3-9
Prepare an SD card	3-9
Update the Firmware	3-11
Firmware Update using TFTP Server	3-12
Preparing the TFTP Server	3-12
Updating the Firmware	3-12
Push Button and LED Indicators	3-13
Diagnosing Device and Subsystem Failures	3-13
Restoring the Firmware to Factory Default	3-14
Using Cellular Modules	3-14
Cellular Signal Strength	3-14
Cellular Dial-Up Mode	3-15
Cellular GPS Port	3-15
Configuring MC7304/MC7354 Cellular Modules	3-15
Configuring the Wireless LAN	3-17
Configuring WPA2 Settings	3-17
Wi-Fi Module	3-18
	3-24
4. UC-8100-LX Security	4-1
Secure Boot	4-2
Sudo Mechanism	4-3
5. General Debian Package	5-1
NTP Client	5-3
Executing Scheduled Commands Using Cron	5-3
Updating System Time and RTC	5-3
Rocket-Fast System for Log Processing: rsyslog	5-4
Rsyslog's Configuration File	5-4
Syntax of the Selector	5-5
OpenSSL	5-5
Ciphers	5-6
Cryptographic Hash Functions	5-6

Public-Key Cryptography	5-6
The Apache Web Server	5-6
Editing the Server Name in the Configuration File	5-7
SFTP	5-7
DNS	5-8
/etc/hosts	5-8
/etc/resolv.conf	5-8
/etc/nsswitch.conf	5-9
iptables	5-9
Observing and Erasing Chain Rules	5-12
Defining a Policy for Chain Rules	5-12
Append or Delete Rules	5-13
rsync	5-13
Using rsync for External Backups	5-14
Automating rsync Backups	5-14
NAT	5-15
NAT Example	5-15
Enabling NAT at Bootup	5-16
NFS (Network File System)	5-17
Setting Up the UC-8100-LX as an NFS Client	5-17
SNMP	5-17
OpenVPN	5-19
Static-Key VPN	5-19
Package Management	5-20
apt-get	5-20
apt-cache	5-20
List All Available Packages	5-20
Find Package Name and Software Description	5-20
Check Package Information	5-21
Check Dependencies for Specific Packages	5-21
Check Cache Statistics	5-21
Update System Packages	5-21
Install or Upgrade Specific Packages	5-21
Upgrade All Software Packages	5-21
Install Multiple Packages	5-21
Install Packages without Upgrading	5-21
Upgrade Specific Packages	5-22
Install Specific Package Version	5-22
Remove Packages Without Configuration	5-22
Completely Remove Packages	5-22
Clean Up Disk Space	5-22
Download Only Source Code of Package	5-22
Download and Unpack a Package	5-22
Download, Unpack, and Compile a Package	5-22
Download a Package Without Installing	5-23
Check the Package Change Log	5-23
Check Broken Dependencies	5-23
Search and Build Dependencies	5-23
Auto Clean Apt-Get Cache	5-23
Auto Remove Installed Packages	5-23
6. Programmer's Guide	6-1
Linux Tool Chain Introduction	6-2
Native Compilation	6-2
Cross Compilation	6-2
Cross Compiling Applications and Libraries	6-4
Test Program—Developing Hello.c	6-4
Compiling Hello.c Using Native Compilation	6-4
Compiling Hello.c Using Cross Compilation	6-5
Makefile Example	6-6
Modbus	6-6
RTC (Real Time Clock)	6-6
WDT (Watchdog Timer)	6-8
Cryptographic Hardware Accelerator	6-9
Diagnostic LED	6-9
Turning on the LEDs	6-9
Turning off the LEDs	6-9
Blinking the LEDs	6-9
Using cell_mgmt	6-10
Manual Page	6-10
Automatic Dial-Up	6-12
Cellular Module	6-13
cell_mgmt at ['AT_COMMAND']	6-14

SIM Card.....	6-15
Switching Between Carrier Frequency Bands.....	6-15
GPS.....	6-16
Cellular Management.....	6-16
A. Extending the Lifetime of the SD Card.....	A-1
Overview.....	A-2
SD Flash Types.....	A-2
Tips for Running GNU/Linux on an SD Card.....	A-2
Choosing an SLC SD Card.....	A-2
Using a Larger Capacity SD Card.....	A-2
Tweaking GNU/Linux to Write to the RAM Instead of the SD card.....	A-3
Setting the SD Card to Read-Only Mode.....	A-4
B. Copying Images from an SD/MicroSD Card (UC-8131-LX, UC-8132-LX, UC-8162-LX, UC-8112-LX, and UC-8112-LX1 Only).....	B-1
Using Win32 Disk Imager.....	B-2
Using the dd Command.....	B-3

Introduction

This is the programming and software operation manual for the Linux OS models of the UC-8100 series of embedded computers.

The UC-8100 series of computers come in various models that support a range of operating systems, ARM architecture CPUs, and software enhancements. The following models are covered by this manual:

UC-8131-LX	RISC-based platform with 300 MHz CPU, 2 Ethernet ports, 1 serial port, 1 GB SD, USB port, and Debian ARM 8
UC-8132-LX	RISC-based platform with 300 MHz CPU, Mini PCIe socket for cellular connectivity, 2 Ethernet ports, 2 serial ports, 1 GB SD, USB port, and Debian ARM 8
UC-8162-LX	RISC-based platform with 600 MHz CPU, Mini PCIe socket for cellular connectivity, 2 Ethernet ports, 2 serial ports, 1 GB SD, USB port, and Debian ARM 8
UC-8112-LX	RISC-based platform with 1 GHz CPU, Mini PCIe socket for cellular connectivity, 2 Ethernet ports, 2 serial ports, 2 GB MicroSD, USB port, SD-card socket, and Debian ARM 8
UC-8112-LX1	RISC-based platform with 1 GHz CPU, Mini PCIe socket for cellular, 2 Ethernet ports, 2 serial ports, 2 GB MicroSD, USB port, SD-card socket (1 GB SD card pre-installed), and Debian ARM 8
UC-8112-ME-T-LX	RISC-based platform with 1 GHz CPU, 512 MB RAM, Mini PCIe socket for cellular connectivity, 2 Ethernet ports, 2 serial ports, 4 GB eMMC flash, USB port, SD-card socket, and Debian ARM 8
UC-8112-ME-T-LX1	RISC-based platform with 1 GHz CPU, 1 GB RAM, Mini PCIe socket for cellular connectivity, 2 Ethernet ports, 2 serial ports, 4 GB eMMC flash, USB port, SD-card socket, and Debian ARM 8
UC-8112-ME-T-LX-US-LTE	RISC-based platform with 1 GHz CPU, 512 MB RAM, 4 GB eMMC flash, Mini PCIe socket for cellular connectivity (with cellular module for North America built in), 2 Ethernet ports, 2 serial ports, USB port, and Debian ARM 8
UC-8112-ME-T-US-LTE-LX1	RISC-based platform with 1 GHz CPU, 1 GB RAM, 4 GB eMMC flash, Mini PCIe socket for cellular connectivity (with cellular module for North America built in), 2 Ethernet ports, 2 serial ports, USB port, and Debian ARM 8

Getting Started

In this chapter, we describe how to configure the UC-8100's basic settings.

The following topics are covered in this chapter:

- ❑ **Software Architecture**
- ❑ **Software Packages**
- ❑ **Connecting to the UC-8100-LX**
 - Connecting through the Serial Console
 - SSH Console
- ❑ **User Account Management**
 - Switching to the Root Account
- ❑ **Creating and Deleting User Accounts**
- ❑ **Disabling the Default User Account**
- ❑ **Network Settings**
 - Configuring Ethernet Interfaces
 - Connecting to a Cellular Network
- ❑ **System Administration**
 - Querying the Firmware Version
 - Adjusting the Time
 - Setting the Time Zone
- ❑ **Determining Available Drive Space**
- ❑ **Enabling and Disabling Daemons**
- ❑ **Package Management**
- ❑ **Shutting Down the Device**

Software Architecture

The Linux operating system that is pre-installed in UC-8100-LX series follows standard Linux architecture, making it easy to accept programs that follow the POSIX standard. This computer uses the Debian ARM 8 distribution so that users can enjoy the full range of Debian software, and benefit from its strong community of developers and documentation. With Debian ARM, the UC-8100-LX supports both native and cross compilation, making programming on the computer easier and more straightforward.

The UC-8100-LX series image is partitioned into bootloader and Linux kernel, backup root file system and root file system. Refer to the following image partition table for reference.

Partition	System Content	Partition Format	Partition Size
1	Bootloader and Linux kernel	W95 FAT32	32 MB
2	Backup root file system	EXT4	128 MB
3	Root file system	EXT4	Rest of the capacity

The default file system format of the UC-8100 Series is EXT4, which is a journaling file system for Linux, developed as the successor to EXT3. The journaling file system keeps track of the changes before committing them to the main file system. In the event of a system crash or power failure, journaling file systems are quicker to bring back online and less likely to become corrupted.

NOTE Click on the following links for more information on EXT4.
<https://wiki.debian.org/Ext4>
https://ext4.wiki.kernel.org/index.php/Ext4_Howto

Software Packages

Refer to Appendix A for software packages installed by default. Most of the software packages come from the Debian community, whereas the unique features of the UC-8100-LX series, such as the diagnostic LED and wireless connection, are supported by Moxa. Refer to the Package Management section for information on how to manage the software packages installed on UC-8100-LX series computers.

Connecting to the UC-8100-LX

You will need another computer to connect to the UC-8100-LX and log on to the command line interface. There are two ways to connect: through serial console cable or through Ethernet cable. Refer to the Hardware Manual to see how to set up the physical connections.

The default login username and password are:

Username: moxa

Password: moxa

The username and password are the same for all serial console and SSH remote log in actions. Root account login is disabled until you manually create a password for the account. The user **moxa** is in the **sudo** group so you can operate system level commands with this user using the **sudo** command. For additional details, see the *Sudo Mechanism* section in chapter 4.



ATTENTION

For security reasons, we recommend that you disable the default user account and create your own user accounts.

Connecting through the Serial Console

This method is particularly useful when using the computer for the first time. The signal is transmitted over a direct serial connection so you do not need to know either of its two IP addresses in order to connect to the UC-8100-LX. To connect through the serial console, configure your PC's terminal software using the following settings.

Serial Console Port Settings	
Baudrate	115200 bps
Parity	None
Data bits	8
Stop bits	1
Flow Control	None
Terminal	VT100

Below we show how to use the terminal software to connect to the UC-8100-LX in a Linux environment and in a Windows environment.

Linux Users

NOTE These steps apply to the Linux PC you are using to connect to the UC-8100-LX. Do NOT apply these steps to the UC-8100-LX itself.

Take the following steps to connect to the UC-8100-LX from your Linux PC.

1. Install **minicom** from the package repository of your operating system.

For Centos and Fedora:

```
user@PC1:~# yum -y install minicom
```

For Ubuntu and Debian:

```
user@PC2:~# apt-get install minicom
```

2. Use the **minicom -s** command to enter the configuration menu and set up the serial port settings.

```
user@PC1:~# minicom -s
```

3. Select **Serial port setup**.

```
+-----[configuration]-----+
| Filenames and paths          |
| File transfer protocols     |
| Serial port setup           |
| Modem and dialing           |
| Screen and keyboard         |
| Save setup as dfl           |
| Save setup as..             |
| Exit                         |
| Exit from Minicom           |
+-----+-----+
|
|
```

4. Select **A** to change the serial device. Note that you need to know which device node is connected to the UC-8100-LX.

```
+-----+-----+
| A - Serial Device           : /dev/tty8 |
| B - Lockfile Location      : /var/lock  |
| C - Callin Program         :           |
| D - Callout Program        :           |
| E - Bps/Par/Bits           : 115200 8N1 |
| F - Hardware Flow Control  : Yes       |
| G - Software Flow Control  : No        |
|                             |
| Change which setting? █ |
+-----+-----+
|
| Screen and keyboard       |
| Save setup as dfl        |
| Save setup as..          |
| Exit                     |
| Exit from Minicom        |
+-----+-----+
```

5. Select **E** to configure the port settings according to the **Serial Console Port Settings** table provided.
6. Select **Save setup as dfl** (from the main configuration menu) to use default values.
7. Select **Exit from minicom** (from the configuration menu) to leave the configuration menu.
8. Execute **minicom** after completing the above configurations.

```
user@PC1:~# minicom
```

```
Welcome to minicom 2.6.1

OPTIONS: I18n
Compiled on Feb 11 2012, 18:56:01.
Port /dev/tty8

Press CTRL-A Z for help on special keys
```

Windows Users

NOTE These steps apply to the Windows PC you are using to connect to the UC-8100-LX. Do NOT apply these steps to the UC-8100-LX itself.

Take the following steps to connect to the UC-8100-LX from your Windows PC.

1. Download PuTTY <http://www.chiark.greenend.org.uk/~sgtatham/putty/download.html> to set up a serial connection with the UC-8100-LX in a Windows environment. The figure below shows a simple example of the configuration that is required.
2. Once the connection is established, the following window will open.

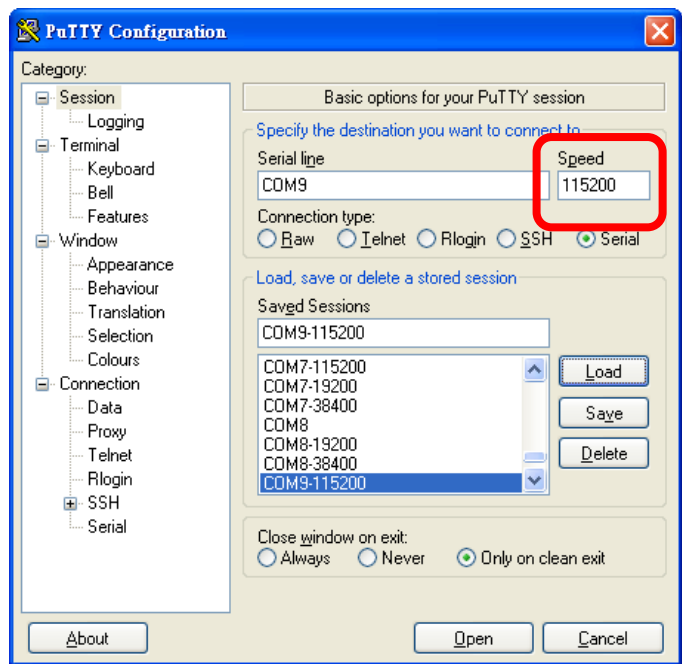

SSH Console

The UC-8100-LX supports SSH connections over an Ethernet network. Use the following default IP addresses to connect to the UC-8100-LX.

Port	Default IP
LAN 1	192.168.3.127
LAN 2	192.168.4.127

Linux Users

NOTE These steps apply to the Linux PC you are using to connect to the UC-8100-LX. Do NOT apply these steps to the UC-8100-LX itself.

Use the **ssh** command from a Linux computer to access the UC-8100-LX's LAN1 port.

```
user@PC1:~ ssh moxa@192.168.3.127
```

Type **yes** to complete the connection.

```
The authenticity of host '192.168.3.127 (192.168.4.127)' can't be established.  
RSA key fingerprint is 8b:ee:ff:84:41:25:fc:cd:2a:f2:92:8f:cb:1f:6b:2f.  
Are you sure you want to continue connection (yes/no)? yes_
```



ATTENTION

Rekey SSHD regularly

In order to secure your system, we suggest doing a regular SSH-rekey, as shown in the following steps.

```
cd /etc/ssh  
sudo rm -rf  
ssh_host_dsa_key      ssh_host_ecdsa_key      ssh_host_rsa_key  
ssh_host_dsa_key.pub  ssh_host_ecdsa_key.pub  ssh_host_rsa_key.pub  
sudo ssh-keygen -t rsa -f /etc/ssh/ssh_host_rsa_key  
sudo ssh-keygen -t dsa -f /etc/ssh/ssh_host_dsa_key  
sudo ssh-keygen -t ecdsa -f. /etc/ssh/ssh_host_ecdsa_key
```

When prompted for a passphrase, leave the passphrase empty and press enter.

```
Restart SSH  
moxa@Moxa:~$ sudo /etc/init.d/ssh restart
```

For more information about SSH, refer to the following link.

<https://wiki.debian.org/SSH>

Windows Users

NOTE These steps apply to the Windows PC you are using to connect to the UC-8100-LX. Do NOT apply these steps to the UC-8100-LX itself.

Take the following steps from your Windows PC.

Click on the link <http://www.chiark.greenend.org.uk/~sgtatham/putty/download.html> to download PuTTY (free software) to set up an SSH console for the UC-8100-LX in a Windows environment. The following figure shows a simple example of the configuration that is required.

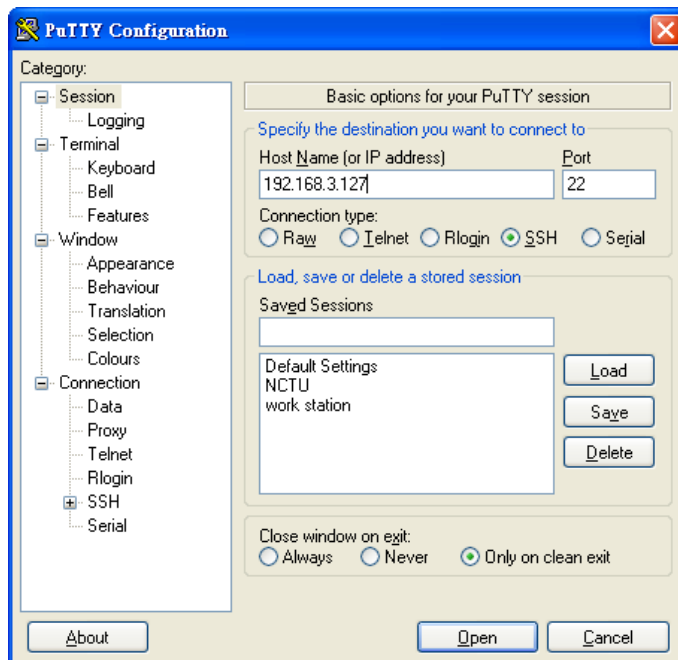

User Account Management

Switching to the Root Account

You can switch to root using **sudo -i** (or **sudo su**). For security reasons, do not operate the **all** commands from the **root** account.

NOTE Click the following link for more information on the **sudo** command.
<https://wiki.debian.org/sudo>



ATTENTION

You might get the **permission denied** message when using pipe or redirect behavior with a non-root account. You must use `'sudo su -c'` to run the command instead of using `>`, `<`, `>>`, `<<`, etc.

Note: The single quotes around the full command are required.

Creating and Deleting User Accounts

You can use the `useradd` and `userdel` commands to create and delete user accounts. Be sure to reference the main page of these commands to set relevant access privileges for the account. Following example shows how to create a `test1` user in the `sudo` group whose default login shell is `bash` and has home directory at `/home/test1`:

```
moxa@moxa:~# sudo useradd -m -G sudo -s /bin/bash test1
```

To change the password for `test1`, use the `passwd` option along with the new password. Retype the password to confirm the change.

```
moxa@moxa:~# sudo passwd test1
Enter new UNIX password:
Retype new UNIX password:
passwd: password updated successfully
```

To delete user `test1`, use the `userdel` command.

```
moxa@moxa:~# sudo userdel test1
```

Disabling the Default User Account



ATTENTION

You should first create a user account before you disable the default account.

Use the `passwd` command to lock the default user account so the user `moxa` cannot log in.

```
root@moxa:~# passwd -l moxa
```

To unlock the user `moxa`:

```
root@moxa:~# passwd -u moxa
```

Network Settings

Configuring Ethernet Interfaces

After the first login, you can configure the UC-8100-LX's network settings to better fit your application. Note that it is more convenient to manipulate the network interface settings from the serial console than from an SSH login to avoid reconnections.

Modifying Network Settings via the Serial Console

In this section, we use the serial console to configure the UC-8100-LX's network settings. Follow the instructions in the *Connecting to the UC-8100-LX* section to access the Console Utility of the target computer via the serial Console port, and then type `Moxa:~# cd /etc/network` to change directories.

```
moxa@moxa:~$ cd /etc/network/
moxa@moxa:/etc/network/~$
```

Type `Moxa:~# sudo vi interfaces` to edit the network configuration file in the `vi` editor. You can configure the UC-8100-LX's Ethernet ports to use either **static** or **dynamic** (DHCP) IP addresses.

Setting a Static IP address

To set a static IP address for the UC-8100-LX, use the `iface` command to modify the **address**, **network**, **netmask**, and **broadcast** parameters of the Ethernet interface.

```
# interfaces(5) file used by ifup(8) and ifdown(8)
auto eth0 eth1 lo
iface lo inet loopback

# embedded ethernet LAN1
#iface eth0 inet dhcp
iface eth0 inet static
    address 192.168.3.127
    network 192.168.3.0
    netmask 255.255.255.0
    broadcast 192.168.3.255

# embedded ethernet LAN2
iface eth1 inet static
    address 192.168.4.127
    network 192.168.4.0
    netmask 255.255.255.0
    broadcast 192.168.4.255~
```

Setting Dynamic IP Addresses:

To configure one or both LAN ports to request an IP address dynamically use the `dhcp` option in place of the `static` in the `iface` command as follows:

Default Setting for LAN1	Dynamic Setting using DHCP
<pre>iface eth0 inet static address 192.168.3.127 network: 192.168.3.0 netmask 255.255.255.0 broadcast 192.168.3.255</pre>	<pre>iface eth0 inet dhcp</pre>

```
# embedded ethernet LAN1
iface eth0 inet dhcp
```

Connecting to a Cellular Network

You can install cellular modules on the UC-8100-LX. Refer to the Moxa website (www.moxa.com) or product data for compatible cellular modules.

The cellular connection utility is `cell_mgmt`. Once the cellular module is installed and the SIM card is inserted, use this command to establish a cellular connection.

The `cell_mgmt` configuration file `/etc/qmi-network.conf` contains the APN, Username, and Password information. When you use the `cell_mgmt` command for the first time, you can type the following instructions directly along with the command without editing the `qmi-network.conf` file. The APN, username, and password will be automatically recorded in the configuration file and retrieved when you run the command again.

```
moxa@Moxa:~$ sudo cell_mgmt start APN=internet USERNAME=moxa PASSWORD=moxa PIN=123
```

Next, use "cell_mgmt start" directly with valid configuration information.

```
moxa@Moxa:~$ sudo cell_mgmt start
```

For detailed information about cellular network settings, refer to the "Using Cellular Modules" section.

System Administration

Querying the Firmware Version

To check the UC-8100-LX's firmware version, type:

```
moxa@Moxa:~$ kversion
UC-8112-LX version 1.0.0
```

Add the `-a` option to create a full build version:

```
moxa@Moxa:~$ kversion -a
UC-8112-LX version 1.0.0 Build 14050416
```

Adjusting the Time

NOTE The UC-8100 series uses a rechargeable battery that provides power for about one week. Be sure to sync with a time server every time the battery is recharged to ensure that the UC-8100 is using the correct time.

The UC-8100-LX has two time settings. One is the system time, and the other is the RTC (Real Time Clock) time kept by the UC-8100-LX hardware. Use the `#date` command to query the current system time or set a new system time. Use the `#hwclock` command to query the current RTC time or set a new RTC time.

Use the `date MMDDhhmmYYYY` command to set the system time:

MM = Month
DD = Date
hhmm = hour and minute

```
moxa@Moxa:~$ sudo date 071123192014
Mon Jul 11 23:19:00 UTC 2014
```

Use the following command to set the RTC time to system time:

```
moxa@moxa:~$ sudo hwclock -w
moxa@moxa:~$ sudo hwclock
Fri 11 Jul 2014 11:19:38 PM UTC -1.006862 seconds
```

NOTE Click the following links for more information on date and time:

<https://www.debian.org/doc/manuals/system-administrator/ch-sysadmin-time.html>

<https://wiki.debian.org/DateTime>

Setting the Time Zone

There are two ways to configure the Moxa embedded computer's **timezone**. One is using the **TZ** variable. The other is using the **/etc/localtime** file.

Using the TZ Variable

The format of the TZ environment variable looks like this:

```
TZ=<Value>HH[:MM[:SS]][daylight[HH[:MM[:SS]]][,start date[/starttime], enddate[/endtime]]]
```

Here are some possible settings for the North American Eastern time zone:

1. **TZ=EST5EDT**
2. **TZ=ESTOEDT**
3. **TZ=EST0**

In the first case, the reference time is GMT and the stored time values are correct worldwide. A simple change of the TZ variable can print the local time correctly in any time zone.

In the second case, the reference time is Eastern Standard Time and the only conversion performed is for Daylight Saving Time. Therefore, there is no need to adjust the hardware clock for Daylight Saving Time twice per year.

In the third case, the reference time is always the time reported. You can use this option if the hardware clock on your machine automatically adjusts for Daylight Saving Time or you would like to manually adjust the hardware time twice a year.

```
moxa@moxa:~$ TZ=EST5EDT
moxa@moxa:~$ export TZ
```

You must include the TZ setting in the **/etc/rc.d/rc.local** file. The timezone setting will be activated when you restart the computer.

The following table lists other possible values for the TZ environment variable:

Hours From Greenwich Mean Time (GMT)	Value	Description
0	GMT	Greenwich Mean Time
+1	ECT	European Central Time
+2	EET	European Eastern Time
+2	ART	
+3	EAT	Saudi Arabia
+3.5	MET	Iran
+4	NET	
+5	PLT	West Asia
+5.5	IST	India
+6	BST	Central Asia
+7	VST	Bangkok
+8	CTT	China
+9	JST	Japan

Hours From Greenwich Mean Time (GMT)	Value	Description
+9.5	ACT	Central Australia
+10	AET	Eastern Australia
+11	SST	Central Pacific
+12	NST	New Zealand
-11	MIT	Samoa
-10	HST	Hawaii
-9	AST	Alaska
-8	PST	Pacific Standard Time
-7	PNT	Arizona
-7	MST	Mountain Standard Time
-6	CST	Central Standard Time
-5	EST	Eastern Standard Time
-5	IET	Indiana East
-4	PRT	Atlantic Standard Time
-3.5	CNT	Newfoundland
-3	AGT	Eastern South America
-3	BET	Eastern South America
-1	CAT	Azores

Using the Localtime File

The local timezone is stored in the `/etc/localtime` and is used by GNU Library for C (glibc) if no value has been set for the TZ environment variable. This file is either a copy of the `/usr/share/zoneinfo/` file or a symbolic link to it. The UC-8100-LX does not provide `/usr/share/zoneinfo/` files. You should find a suitable time zone information file and write over the original local time file in the UC-8100-LX

Determining Available Drive Space

To determine the amount of available drive space, use the `df` command with the `-h` tag. The system will return the amount of drive space broken down by file system. Here is an example:

```
moxa@moxa:~$ df -h
Filesystem      Size  Used Avail Use% Mounted on
rootfs          803M  238M  524M  32% /
/dev/root       803M  238M  524M  32% /
tmpfs           25M   188K   25M   1% /run
tmpfs           5.0M    0   5.0M   0% /run/lock
tmpfs           10M    0   10M   0% /dev
tmpfs           50M    0   50M   0% /run/shm
```

Enabling and Disabling Daemons

By default, only the following daemons are enabled in the UC-8100-LX:

- sftpd** SFTP Server / Client daemon
- sshd** Secure Shell Server daemon

You can use the `insserv` command to manage which services run in the background. The following example shows how to add the Apache daemon to the current *run level*.

```
moxa@moxa:~$ sudo insserv -d apache2
```

The Apache daemon will not get activated in the current boot session, but will be running in the background from the next boot session.

To disable the Apache daemon, use the following command:

```
moxa@moxa:~$ sudo inserv -r apache2
```

You can also write your own script to start and stop a daemon during the system "init" stage:

```
### BEGIN INIT INFO
# Provides:          scriptname
# Required-Start:    $remote_fs $syslog
# Required-Stop:     $remote_fs $syslog
# Default-Start:     2 3 4 5
# Default-Stop:      0 1 6
# Short-Description: Start daemon at boot time
# Description:       Enable service provided by daemon.
### END INIT INFO

YOUR SCRIPT
```

Linux daemons can be started or stopped in a current boot session by using the scripts in `/etc/init.d`. To start the apache daemon, use:

```
moxa@moxa:~$ sudo /etc/init.d/apache2 start
```

To stop the apache daemon, use:

```
moxa@moxa:~$ sudo /etc/init.d/apache2 stop
```

In comparison to `inserv`, scripts in `/etc/init.d/` will only start or stop the services in the current boot session. Once you reboot the UC-8100-LX, it will go back to the default settings managed by `inserv`.

Package Management

Most of the software packages are maintained by the Debian community through the Debian official apt repository, whereas features only supported by the UC-8100-LX are maintained by Moxa. Adding the Moxa repository to the `/etc/apt/sources.list` will allow you to keep your system up to date with the newest UC-8100-LX packages.

```
moxa@moxa:~$ cat /etc/apt/sources.list
deb http://debian.moxa.com/debian jessie main

deb http://ftp.us.debian.org/debian/ jessie main contrib non-free
deb-src http://ftp.us.debian.org/debian/ jessie main contrib non-free

deb http://ftp.us.debian.org/debian/ jessie-updates main contrib non-free
deb-src http://ftp.us.debian.org/debian/ jessie-updates main contrib non-free

deb http://security.debian.org/ jessie/updates main contrib non-free
deb-src http://security.debian.org/ jessie/updates main contrib non-free

deb http://ftp.debian.org/debian jessie-backports main contrib non-free
deb-src http://ftp.debian.org/debian jessie-backports main contrib non-free
```

Shutting Down the Device

To shut down the device, disconnect the power source to the computer. When the computer is powered off, main components such as the CPU, RAM, and storage devices are powered off, although an internal clock may retain battery power.

You can use the Linux command **shutdown** to close all software running on the device and halt the system. However, main components such as the CPU, RAM, and storage devices will continue to be powered after you run this command.

```
moxa@Moxa:~$ sudo shutdown -h now
```

Advanced Configuration of Peripherals

In this chapter, we include more information on the UC-8100-LX's peripherals, such as the serial interface, storage, diagnostic LEDs, and the cellular module.

The following topics are covered in this chapter:

- ❑ **Serial Ports**
 - Changing the Terminal Settings
- ❑ **USB Port**
 - Disabling the USB Port
 - USB Automount
- ❑ **SD and MicroSD Slot**
 - Enabling Write Protection
- ❑ **Preparing a Bootable SD Card (UC-8100 Series Only)**
 - Creating a Linux System Image Using a Windows Platform
 - Creating a System Image in a Linux Environment
- ❑ **Booting up the UC-8100-LX for the First Time**
 - File System Resizing
 - Booting from a MicroSD Card (UC-8112 Only)
- ❑ **Firmware Update Using an SD Card (UC-8100-ME-T Series Only)**
 - Prepare an SD card
 - Update the Firmware
- ❑ **Firmware Update using TFTP Server**
 - Preparing the TFTP Server
 - Updating the Firmware
- ❑ **Push Button and LED Indicators**
 - Diagnosing Device and Subsystem Failures
- ❑ **Restoring the Firmware to Factory Default**
- ❑ **Using Cellular Modules**
 - Cellular Signal Strength
 - Cellular Dial-Up Mode
 - Cellular GPS Port
 - Configuring MC7304/MC7354 Cellular Modules
- ❑ **Configuring the Wireless LAN**
 - Configuring WPA2 Settings
 - Wi-Fi Module
 -

Serial Ports

The UC-8131-LX has 1 serial port at `/dev/ttyM0`, while all other UC-8100-LX models have 2 serial ports at `/dev/ttyM0` and `/dev/ttyM1`. The serial ports support RS-232, RS-422, and RS-485 2-wire operation modes with flexible baudrate settings.

The default operation mode is set to RS-422; use the `setinterface` command to change the operation mode.

Usage: `setinterface device-node [interface-no]`
Device-node: `/dev/ttyMn; n = 0,1,2,...`
Interface-no: As in the following table

Interface-no	Operation Mode
None	Display current setting
0	RS-232
1	RS-485 2-wire
2	RS-422 / RS-485 4-wire

For example, to set `/dev/ttyM0` to RS-485 2-wire mode, use the following command:

```
moxa@moxa:~# sudo setinterface /dev/ttyM0 1
Now setting is RS485-2W mode
moxa@moxa:~# sudo setinterface /dev/ttyM0
UART Port#0 is in RS485-2W Mode
```

Changing the Terminal Settings

The `stty` command is used to manipulate the terminal settings. You can view and modify the serial terminal settings with this command. Details are given below.

Displaying All Settings

The following text shows how to display all settings.

```
moxa@moxa:~$ sudo stty -a -F /dev/ttyM0
speed 9600 baud; rows 0; columns 0; line = 0;
intr = ^C; quit = ^\; erase = ^?; kill = ^U; eof = ^D; eol = <undef>;
eol2 = <undef>; swtch = <undef>; start = ^Q; stop = ^S; susp = ^Z; rprnt = ^R;
werase = ^W; lnext = ^V; flush = ^O; min = 1; time = 0;
-parenb -parodd cs8 hupcl -cstopb cread clocal -crtcts
-ignbrk -brkint -ignpar -parmrk -inpck -istrip -inlcr -igncr icrnl ixon -ixoff
-iuclc -ixany -imaxbel -iutf8
opost -olcuc -ocrnl onlcr -onocr -onlret -ofill -ofdel nl0 cr0 tab0 bs0 vt0 ff0
isig icanon iexten echo echoe echok -echonl -noflsh -xcase -tostop -echoprt
echoctl echoke
```

Configuring Serial Settings

The following example changes the baudrate to 115200.

```
moxa@moxa:~$ sudo stty 115200 -F /dev/ttyM0
```

After running this command, the baudrate will be changed to 115200.

```
moxa@moxa:~$ sudo stty -a -F /dev/ttyM0
speed 115200 baud; rows 0; columns 0; line = 0;
intr = ^C; quit = ^\; erase = ^?; kill = ^U; eof = ^D; eol = <undef>;
eol2 = <undef>; swtch = <undef>; start = ^Q; stop = ^S; susp = ^Z; rprnt = ^R;
werase = ^W; lnext = ^V; flush = ^O; min = 1; time = 0;
-parenb -parodd cs8 hupcl -cstopb cread clocal -crtcts
-ignbrk -brkint -ignpar -parmrk -inpck -istrip -inlcr -igncr icrnl ixon -ixoff
-iuclc -ixany -imaxbel -iutf8
opost -olcuc -ocrnl onlcr -onocr -onlret -ofill -ofdel nl0 cr0 tab0 bs0 vt0 ff0
isig icanon iexten echo echoe echok -echonl -noflsh -xcase -tostop -echoprt
echoctl echoke
```

NOTE Detailed information on the `stty` utility is available at the following link:
<http://www.gnu.org/software/coreutils/manual/coreutils.html>

USB Port

The UC-8100 series has a USB port for storage expansion.

Disabling the USB Port

USB ports on the UC-8100 can be disabled. To disable a USB port, take the following steps:

1. After powering on the UC-8100 computer, press to enter the bootloader configuration settings.

UC-8100-LX

```
-----
Boot Loader Version 1.4.0S13          CPU TYPE: 1GHz
Build date: Apr 7 2017 - 16:04:58    Serial Number: MOXATESTTSN01
LAN1 MAC: 00:90:E8:4C:B2:CF          LAN2 MAC: 00:90:E8:4C:B2:D0
-----
(0) SD Card Write Protect           (1) Extend USB Port Control
(2) Firmware Update by SD Card      (3) Auto update ThingsPro from SD card
(4) Go To OS
-----
Command>>
```

UC-8112-ME-T-LX

```
-----
Model: UC-8112-ME-T-LX
Boot Loader Version 1.2.0S07          CPU TYPE: 1GHz
Build date: Apr 7 2017 - 08:52:40    Serial Number: MOXATESTTSN01
LAN1 MAC: 00:90:E8:5B:35:41          LAN2 MAC: 00:90:E8:5B:35:42
-----
(0) Extend USB Port Control           (1) Firmware Update by SD Card
(2) Firmware Update by Tftp          (3) Select Boot Device
(4) Go To OS                         (5) Auto update ThingsPro from SD card
-----
Command>>
```

- To enable **Extend USB Port Control**, do the following:

```
UC-8100-LX      enter 1
```

```
UC-8112-ME-T-LX  enter 0
```

```
Current Extend USB Port is ON.
```

```
Change to ,0 - ON, 1 - OFF (0-1,enter for abort):
```

For example, UC-8100-LX users can enter 1 to disable the USB port.

```
Change to ,0 - ON, 1 - OFF (0-1,enter for abort): 1
```

```
Saving Environment to EEPROM...
```

- Reboot the UC-8100-LX computer to make the change effective.

You will see the following message on the console, which indicates the successful disabling of the USB port.

```
[60.268951] hub 2-0:1.0: unable to enumerate USB device on port 1
```



ATTENTION

No USB devices can be mounted when the port is disabled

This includes USB block storage devices and dongles, neither of which will be able to be mounted.

USB Automount

The UC-8100-LX supports hot plug function for connecting USB mass storage devices. However, by default, the **automount** utility (udev) only supports auto-mounting of one partition. Use the **mount** command to view details about all partitions.



ATTENTION

Remember to type the **#sync** command before you disconnect the USB mass storage device to prevent loss of data.

Exit from the `/media/usb*` directory when you disconnect the storage device. If you stay in `/media/usb*`, the auto unmount process will fail. If that happens, type `#umount /media/usb*` to unmount the device manually.

SD and MicroSD Slot

The SD slot supports the SD, SDHC, and SDXC formats, and is used as the main storage for the UC-8100-LX series. The UC-8100-LX comes with a pre-installed 1GB SD card, but allows using SD cards with up to 64 GB of storage space.

The UC-8112-LX has an internal MicroSD slot. The storage media with a valid boot code will serve as the main storage, and the other storage media will be used as expansion. Either the SD or MicroSD slot can serve as the main storage. In either case, the expansion storage will be auto-mounted to `/media/sd-mmcb1k1pX`, where X is the partition number.

Below we explain how to enable write protection on the SD and MicroSD slot, and how to prepare a bootable SD with different capacities.

Enabling Write Protection

The SD slot does not support the write protection lock switch on SD cards or MicroSD-SD converters. However, it can be configured as read-only through the bootloader. The MicroSD slot can also be configured as read-only through the bootloader. Take the following steps to enable write protection on these slots.

1. Press to enter the bootloader configuration setting after powering on the device.
2. Select (1) SD Card Write Protect.

```
-----
Boot Loader Version 1.0.0S12      CPU TYPE: 1GHz
Build date: May 7 2014 - 15:55:07  Serial Number: MOXATESTSN01
LAN1 MAC: 00:90:E8:00:00:01      LAN2 MAC: 00:90:E8:00:00:02
-----
(0) TPM Setting                    (1) SD Card Write Protect
(2) Extend USB Port Control
-----
Command>>1
```

3. Select on which storage device you would like to configure write protection.

```
-----
Boot Loader Version 1.0.0S12      CPU TYPE: 1GHz
Build date: May 7 2014 - 15:55:07  Serial Number: MOXATESTSN01
LAN1 MAC: 00:90:E8:00:00:01      LAN2 MAC: 00:90:E8:00:00:02
-----
(0) Boot Storage Write Protect    (1) Extend Storage Write Protect
-----
Command>>0
```

4. You will first see the storage device's current write protection status. You can choose to Enable or Disable the write-protect function here.

```
Current Boot Storage Write Protect is Disabled.
Change to ,0 - Disabled, 1 - Enabled (0-1,enter for abort):
```

The above steps will mount the partitions on the storage as read-only after booting up. You can alter the read-only status in the OS by remounting the partitions using the `mount` command. For example, to mount the root directory as read/write, use `mount -o remount,rw /`, and when you don't need to write in the root directory, use the `umount` command to make it read-only again.



ATTENTION

If you create your own bootable SD or MicroSD card, do not set the boot storage to be read-only when the system is booted up for the first time. The system is required to configure itself with read-writeable mode on the first boot. You can set up write protection for the boot storage after the first boot up.

Preparing a Bootable SD Card (UC-8100 Series Only)

If you want to use an SD card with higher capacity, or upgrade the UC-8100's firmware, you can download the latest UC-8100-LX image from Moxa's official website and prepare a bootable SD card.

You can download the image file to either a Windows or Linux PC, and then transfer the file to the SD card. Refer to the following tutorial for details.

Creating a Linux System Image Using a Windows Platform

If you are using Windows, take the following steps.

1. Make sure the SD card's write protection switch is unlocked.



2. Insert the SD card into a Windows PC.
3. Download win32diskimager from following link.
<http://sourceforge.net/projects/win32diskimager/>
4. Execute the win32diskimager after installation.
5. Make sure the device name matches the USB device.

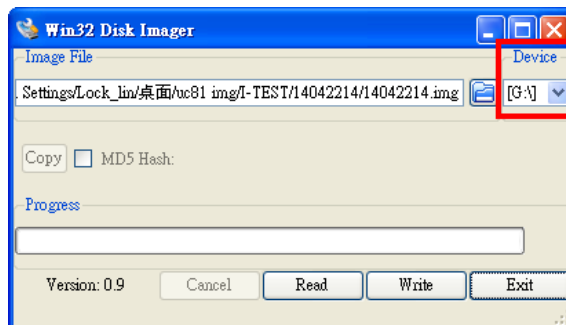

6. Select the image file.

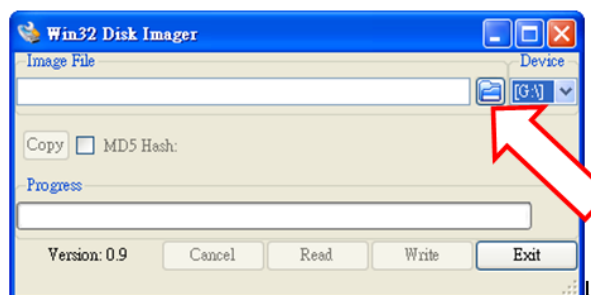

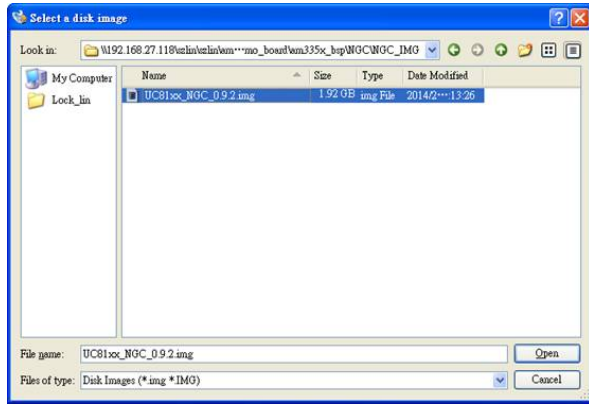

7. Make sure you have selected the correct image file, and then click the **Write** button.

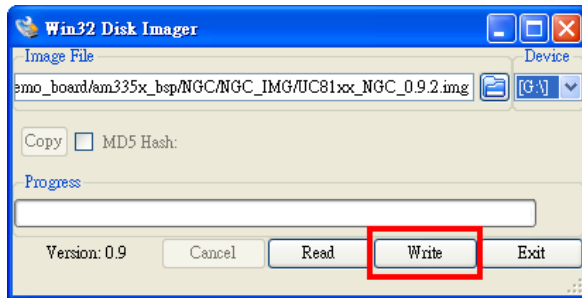

8. When finished, click **OK**.

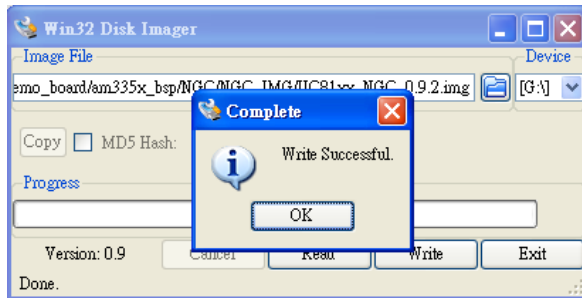

Creating a System Image in a Linux Environment

If you are using Linux, take the following steps.

1. Make sure the SD card's write protection switch is unlocked.



2. Insert the SD card into a Linux PC.

3. Use the `dmesg` command to determine the device node.

```
scsi 25:0:0:0: Direct-Access    TS-RDF5  SD  Transcend    TS35 PQ: 0 ANSI: 6
sd 25:0:0:0: Attached scsi generic sg3 type 0
sd 25:0:0:0: [sdd] 31260672 512-byte logical blocks: (16.0 GB/14.9 GiB)
sd 25:0:0:0: [sdd] Write Protect is off
sd 25:0:0:0: [sdd] Mode Sense: 23 00 00 00
sd 25:0:0:0: [sdd] Write cache: disabled, read cache: enabled, doesn't support DPO or FUA
sdd: unknown partition table
sd 25:0:0:0: [sdd] Attached SCSI removable disk
```

4. Use the `dd` command to configure the UC-8100-LX image on the SD card.

```
root@Moxa:/home/work# sudo dd if=./140
42420.img of=/dev/sdd
bs=512k
      1954+0 records in
      1954+0 records out
1024458752 bytes (1.0 GB) copied, 119.572 s, 8.6 MB/s
```

NOTE Click the following links for more information on the `dd` command.

http://www.gnu.org/software/coreutils/manual/html_node/dd-invocation.html

Booting up the UC-8100-LX for the First Time

We suggest using the serial console to log in for the first time. See the UC-8100 Hardware Manual for instructions on how to connect to the serial console.

File System Resizing

Connect the UC-8100-LX to a power source; the computer will immediately boot up. The power LED will be light up first, after which the SD Card LED will light up. You will also see messages printed out from the serial console. On the first boot up, you will notice that the root filesystem is being resized and initialized, as indicated by the notification shown below.

```
[...] Starting resize2fs_once...It will take some time to finish this action!:resize2fs 1.42.5 (29-Jul-2012)
Filesystem at /dev/root is mounted on /; on-line resizing required
old desc blocks = 4, new desc blocks = 29
[ 9.563018] PHY: 0:10 - Link is Up - 100/Full
[ 9.567718] ADDRCONF(NETDEV_CHANGE): eth0: link becomes ready
Performing an on-line resize of /dev/root to 7550976 (1k) blocks.
[ ok ] Starting OpenBSD Secure Shell server: sshd.
[ ok ] Starting Trusted Computing daemon: tcsd.
```

The procedure could take a few minutes, with the actual time required depending on the capacity of the SD card. The diagnostic LED indicators will be activated as indicated in below while the table is being resized. Please wait patiently until the diagnostic LEDs turn off.

System Status	Diagnostic LED		
	RED	YELLOW	GREEN
Expanding root filesystem	Off	Blinking	On

Booting from a MicroSD Card (UC-8112 Only)

By default, the UC-8100-LX will boot up from the SD card. However, since the UC-8112-LX model provides the option to put the image on the internal MicroSD card, the UC-8112-LX will boot up from the MicroSD slot if no boot up code is found on an SD card in the SD card slot.

Firmware Update Using an SD Card (UC-8100-ME-T Series Only)

Prepare an SD card

If you are using Windows, take the following steps.

1. Make sure the SD card's write protection switch is unlocked.



2. Insert the SD card into a Windows PC.
3. Make sure the SD card is using FAT32 file system.

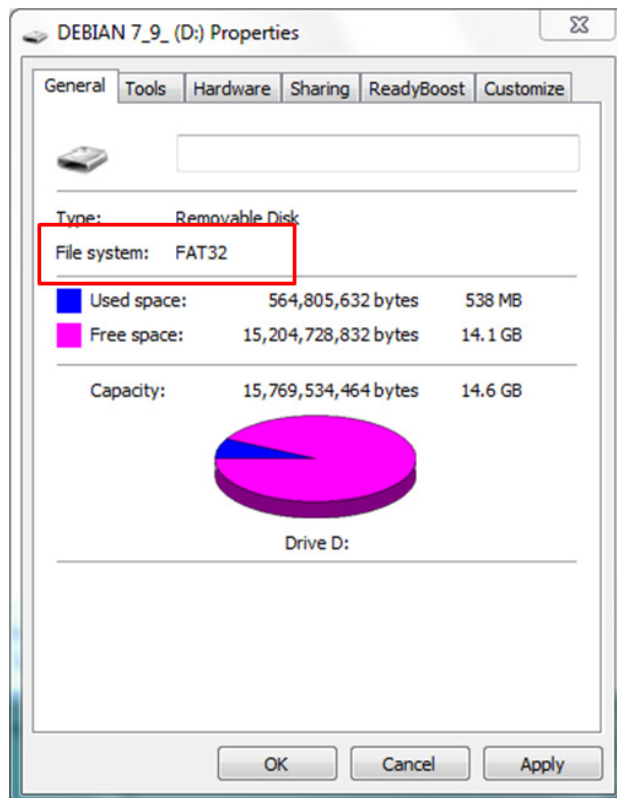

4. If the SD card is not using a FAT32 file system, you will need to format it to a FAT32 file system.

NOTE When you format the SD card, all of the files on the SD card will be deleted.

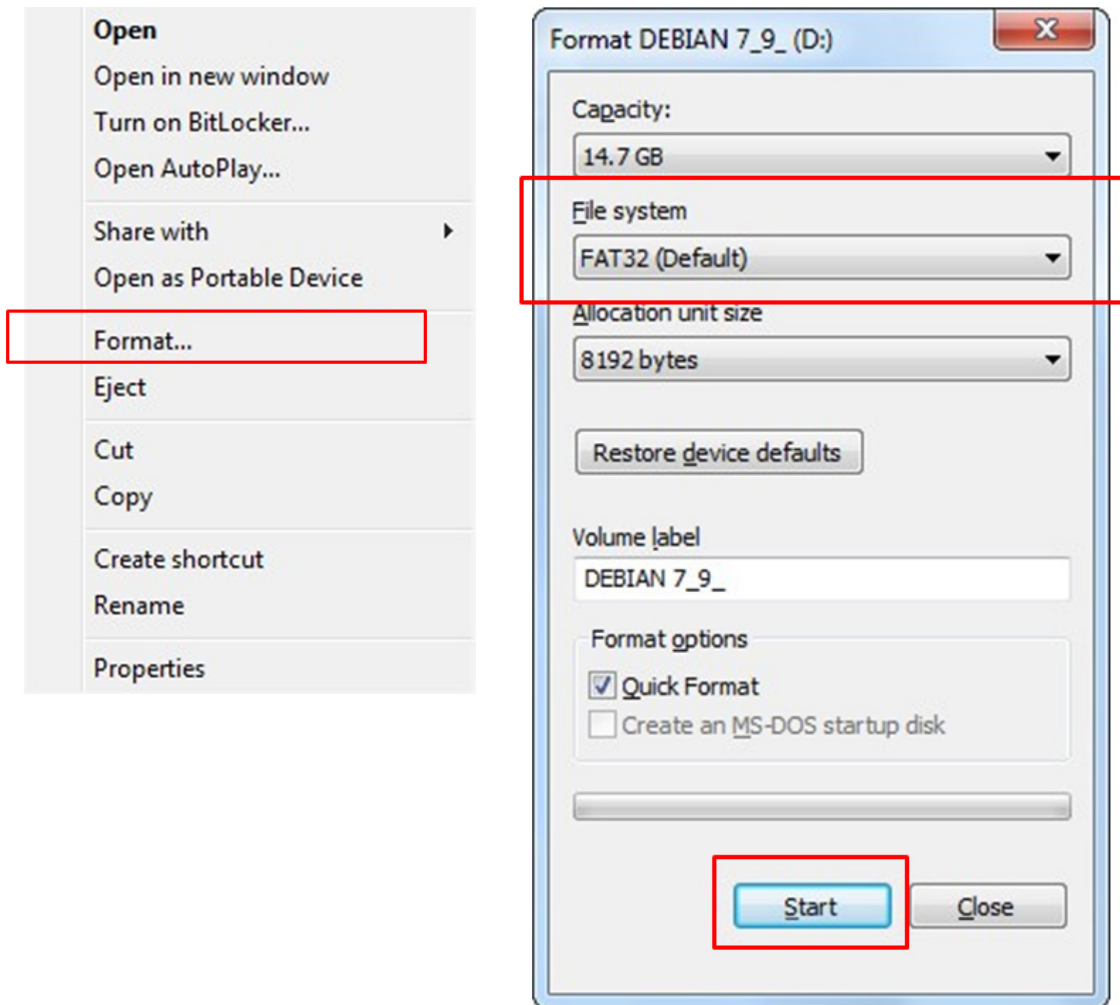

5. Copy the image file from your computer onto the SD card and then follow the steps to update the firmware.

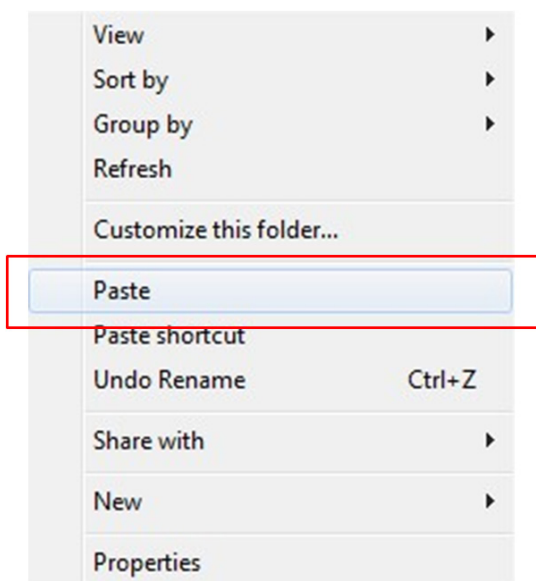

Update the Firmware

1. To update the firmware, log in to the product through the serial console. Instructions on how to connect to the serial console can be found in the UC-8100 Hardware Manual.
2. After powering on the UC-8112-ME computer, press to enter the bootloader configuration settings.

If you cannot enter the bootloader menu by pressing , replace putty by Tera Term terminal console tool.

(Detailed information is available on the following website: <https://ttssh2.osdn.jp/index.html.en>)

```
-----
Model: UC-8112-ME-T-LX
Boot Loader Version 1.0.0S09      CPU TYPE: 1GHz
Build date: Jan 30 2016 - 14:44:07  Serial Number: TAFBB1064329
LAN1 MAC: 00:90:E8:55:46:33      LAN2 MAC: 00:90:E8:55:46:34
-----

(0) Extend USB Port Control      (1) Firmware Update by SD Card
(2) Firmware Update by Tftp      (3) Select Boot Device
(4) Go To OS                     (5) Auto update ThingsPro from SD card
-----

Command>>
```

3. Enter 1 to choose an *.img file.

```
Command>>1

Firmware File Name (firmware.img):
```

4. Enter the img filename.

```
Firmware File Name (firmware.img): FWR_UC-8112-ME-T-LX_V1.0.0_Build_16030911.img
```

5. After updating the firmware, enter 4 to open the OS command line.

```
Firmware File Name (firmware.img): FWR_UC-8112-ME-T-LX_V1.0.0_Build_16030911.img
mmc2(part 0) is current device
MMC write: dev # 2, block # 0, count 393216 ... 393216 blocks write: OK
mmc2(part 0) is current device
MMC write: dev # 2, block # 393216, count 393216 ... 393216 blocks write: OK
mmc2(part 0) is current device
MMC write: dev # 2, block # 786432, count 237568 ... 237568 blocks write: OK
-----

Model: UC-8112-ME-T-LX
Boot Loader Version 1.0.0S09      CPU TYPE: 1GHz
Build date: Jan 30 2016 - 14:44:07  Serial Number: TAFBB1064329
LAN1 MAC: 00:90:E8:55:46:33      LAN2 MAC: 00:90:E8:55:46:34
-----

(0) Extend USB Port Control      (1) Firmware Update by SD Card
(2) Firmware Update by Tftp      (3) Select Boot Device
(4) Go To OS                     (5) Auto update ThingsPro from SD card
-----

Command>> 4
```

Firmware Update using TFTP Server

Preparing the TFTP Server

1. Set up a TFTP server.
2. Make sure the image (*.img) file is in your TFTP server directory.

Updating the Firmware

1. To update the firmware, log in to the product through the serial console. Instructions on how to connect to the serial console can be found in the UC-8100 Hardware Manual.
2. After powering on the UC-8112-ME computer, press to enter the bootloader configuration settings.

If you cannot enter the bootloader menu by pressing , replace putty by Tera Term terminal console tool.

(Detailed information is available on the following website: <https://tssh2.osdn.jp/index.html.en>)

```

-----
Model: UC-8112-ME-T-LX
Boot Loader Version 1.0.0S09          CPU TYPE: 1GHz
Build date: Jan 30 2016 - 14:44:07   Serial Number: TAFBB1064329
LAN1 MAC: 00:90:E8:55:46:33         LAN2 MAC: 00:90:E8:55:46:34
-----
(0) Extend USB Port Control          (1) Firmware Update by SD Card
(2) Firmware Update by Tftp         (3) Select Boot Device
(4) Go To OS                        (5) Auto update ThingsPro from SD card
-----
Command>>

```

3. Enter 2 to update the firmware by Tftp server. If you want to set up the TFTP IP address, enter 1 to set up the target machine's IP address and the Tftp server IP address and then choose an img file.

```

Command>> 2

Current IP Address
Local IP Address : ipaddr=192.168.31.134
Server IP Address : serverip=192.168.31.132
Do you set your ip address?
0 - No, 1 - Yes (0-1,enter for abort): 1
Local IP Address : 192.168.31.134
Server IP Address : 192.168.31.132
Saving Environment to SPI Flash...
SF: Detected MX25L6405D with page size 64 KiB, total 8 MiB
Erasing SPI flash...Writing to SPI flash...done

Firmware File Name (firmware.img): FWR_UC-8112-ME-T-LX_V1.0.0_Build_16030911.img

```

4. After updating the firmware, enter 4 to open the OS command line.

```

-----
Model: UC-8112-ME-T-LX
Boot Loader Version 1.0.0S09          CPU TYPE: 1GHz
Build date: Jan 30 2016 - 14:44:07   Serial Number: TAFBB1064329
LAN1 MAC: 00:90:E8:55:46:33         LAN2 MAC: 00:90:E8:55:46:34
-----

(0) Extend USB Port Control          (1) Firmware Update by SD Card
(2) Firmware Update by Tftp          (3) Select Boot Device
(4) Go To OS                          (5) Auto update ThingsPro from SD card
-----

Command>> 4
    
```

Push Button and LED Indicators

The push button is used to diagnose device failure or to perform firmware restoration. Pay attention to the indicators and release the button at the appropriate time to enter the correct mode to either diagnose your device or restore your device to the default configuration. See the figure and description for the indications.

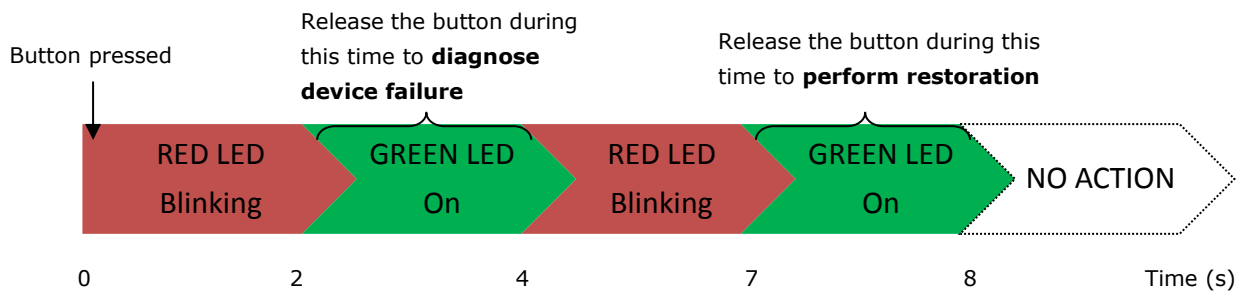

The LED indicators have different behaviors when diagnosing for device failure and for performing firmware restoration as listed in the table below:

Status	Red LED	Yellow LED	Green LED
Executing diagnostic program	Blink	Off	On
Resetting to default configuration	Blink	Blink	On

Diagnosing Device and Subsystem Failures

The red LED will start blinking once you press the push button. Keep the button pressed until the green LED is lit for the first time and then release the button to enter diagnostic mode to check which peripherals are available on the UC-8100-LX. When diagnostic program is running, the red LED will be blinking.

Status	Red LED	Yellow LED	Green LED
Execution of diagnostic program	Blinking	Off	On

The following two tables describe the diagnostic results related to hardware defects and system operation.

Hardware Defects

If you observe any of these hardware issues, contact Moxa for further instructions.

Status	Red LED	Yellow LED	Green LED
UART1 device issue	On	On	Off
UART2 device issue (except UC-8131)	On	On	Blinking
LAN 1 device issue	On	Off	Off
LAN 2 device issue	On	Off	Blinking
Button device issue	On	Blinking	Off
TPM device issue	On	Blinking	Blinking
LED device issue	On	Off	Off

System Operation

If you observe any of the following issues, check the item indicated by the LEDs.

Status	Red LED	Yellow LED	Green LED
CPU usage (over 90%)	Blinking	On	Off
RAM usage (over 90%)	Off	On	Off
Disk usage (over 90%)	Off	On	Blinking
File system corrupted	Blinking	On	Blinking

Restoring the Firmware to Factory Default

Keep the push button pressed until the green LED lights up for the second time and then release the button. The UC-8100-LX will enter the restoration process and reset the computer to factory defaults. The green LED will light up, and the red and yellow LED indicators will blink as the root filesystem is reset to default values.

Status	Red LED	Yellow LED	Green LED
Resetting to defaults	Blinking	Blinking	On

You can also use the `setdef` command to restore the computer to factory defaults:

```
moxa@moxa:~$ sudo setdef
```



ATTENTION

Reset-to-default will erase all the data stored on the boot storage

Please back up your files before resetting the system to factory defaults. All the data stored in the UC-8100-LX's boot storage will be destroyed after resetting to factory defaults.

Using Cellular Modules

UC-8100-LX computers have a mini PCIe socket for installing a cellular module. Contact your sales representative for more information about available modules.

Cellular Signal Strength

The following table shows how cellular signal strength is indicated by the signal indicators.

Signal Indicator	Value	RSSI dbm	Condition
3 LEDs on (red, yellow, green)	20 to 30	-73 to -53	Excellent
2 LEDs on (red, yellow)	10 to 19	-93 to -74	Good
1 LED on (red)	2 to 9	-109 to -94	Marginal
No LED on	Else	Else	No signal

Cellular Dial-Up Mode

For the modules provided below, we suggest dialing up from QMI interface with QMI commands instead of using AT commands from the AT ports.

Module	MC7304	MC7354	MC9090
Dial Up mode	QMI /dev/cdc-wdm0	QMI /dev/cdc-wdm0	QMI /dev/cdc-wdm0
AT Port	/dev/ttyUSB2	/dev/ttyUSB2	/dev/ttyUSB2
Default mode	7	7	8

Cellular GPS Port

Module	MC7304	MC7354	MC9090
Device node	/dev/ttyUSB1	/dev/ttyUSB1	/dev/ttyUSB1

Configuring MC7304/MC7354 Cellular Modules

The MC7304 and MC7354 cellular modules can be used with the UC-8100-LX. Refer to product datasheet for detailed specifications. You can use the UC-8100-LX's cellular connection utility, **cell_mgmt**, to initiate a cellular connection.

GPS

The GPS function of the MC7304/MC7354 is disabled by default. You can get raw GPS data by just listening to the GPS port /dev/ttyUSB1.

```
moxa@moxa:~# cat /dev/ttyUSB1
```

Verizon

Verizon users should use the following commands to switch to the corresponding Verizon profile:

```
moxa@moxa:~# sudo cell_mgmt switch_carrier Verizon
-----switch_carrier-----
cmd=AT!GOBIIMPREF="05.05.58.01","VZW","VZW_005.029_000"

OK

OK

OK
wait for power cycle...
Network already stopped
Clearing state...
```

The **cell_mgmt** command will re-initialize the cellular module.

AT&T

AT&T users should use the following commands to switch to the corresponding AT&T profile:

```
moxa@moxa:~# sudo cell_mgmt switch_carrier ATT
-----switch_carrier-----
cmd=AT!GOBIIMPREF="05.05.58.01","ATT","ATT_005.014_000"

OK

OK

OK
wait for power cycle...
Network already stopped
Clearing state...
```

The `cell_mgmt` command will re-initialize the cellular module.

Sprint

Sprint users should run the following commands to switch to the corresponding Sprint profile:

```
moxa@moxa:~# sudo cell_mgmt switch_carrier Sprint
-----switch_carrier-----
cmd=AT!GOBIIMPREF="05.05.58.01","SPRINT","SPRINT_005.019_000"

OK

OK

OK
wait for power cycle...
Network already stopped
Clearing state...
```

The `cell_mgmt` command will re-initialize the cellular module.

Generic

General users should run the following command:

```
moxa@moxa:~# sudo cell_mgmt switch_carrier Generic
-----switch_carrier-----
cmd=AT!GOBIIMPREF="05.05.58.01","GENNA-UMTS","GENNA-UMTS_005.013_000"

OK

OK

OK
wait for power cycle...
Network already stopped
Clearing state...
```

The `cell_mgmt` command will re-initialize the cellular module.

Power On/Off Module

The `cell_mgmt` command can be used to re-initialize the module without rebooting the UC-8100-LX. To power off and power on the module, run the following command:

```
moxa@moxa:~# sudo cell_mgmt power_cycle
```

NOTE Additional information about `qmi` utilities can be found at the following link.
<http://www.freedesktop.org/wiki/Software/libqmi/>

Configuring the Wireless LAN

You can configure the Wi-Fi connection on the UC-8100 using a configuration file or the `wpa_supplicant` command (recommended).

NOTE You might encounter compatibility issues if you configure Wi-Fi settings using commands other than the `wpa_supplicant` command.

Use the following command to list the available wireless network IDs:

```
#iwlist wlan0 scanning
```

```
root@moxa:~# iwlist wlan0 scanning
wlan0 Scan completed :
Cell 01 - Address: 50:67:F0:61:2D:7A
Protocol:802.11b/g
ESSID:"MIS-WAP-1"
Mode:Managed
Frequency:2.412 GHz (Channel 1)
Quality=81/100 Signal level=-58 dBm Noise level=-92 dBm
Encryption key:on
Bit Rates:54 Mb/s
```

Configuring WPA2 Settings

The UC-8100 series computer supports WPA2 security using the `/sbin/wpa_supplicant` program. Refer to the following table for configuration options. The **Key required before joining network** column specifies whether an encryption and/or authentication key must be configured before associating with a network.

Infrastructure mode	Authentication mode	Encryption status	Manual Key required?	IEEE 802.1X enabled?	Key required before joining network?
ESS	Open	None	No	No	No
ESS	Open	WEP	Optional	Optional	Yes
ESS	Shared	None	Yes	No	Yes
ESS	Shared	WEP	Optional	Optional	Yes
ESS	WPA	WEP	No	Yes	No
ESS	WPA	TKIP	No	Yes	No
ESS	WPA2	AES	No	Yes	No
ESS	WPA-PSK	WEP	Yes	Yes	No
ESS	WPA-PSK	TKIP	Yes	Yes	No
ESS	WPA2-PSK	AES	Yes	Yes	No

Wi-Fi Module

You can configure the Wi-Fi connection using the **wpa_supplicant** configuration file or program.

In this section we show you how to connect to an 802.11 access point using the connection program **wpa_supplicant**. You can use the **wifi_mgmt** command provided by Moxa.

wifi_mgmt Command

Manual Page

The **wifi_mgmt** utility manages the behavior of the Wi-Fi module.

```
moxa@Moxa:~$ sudo wifi_mgmt help
[sudo] password for moxa:
Usage:
  /sbin/wifi_mgmt [OPTIONS]

OPTIONS
  start Type=[type] SSID=[ssid] Password=[password]
      Insert an AP information to the managed AP list and then connect to the
      AP.

      [type]          open/wep/wpa/wpa2
      [ssid]          access point's SSID
      [password]      access point's password

      example:
      wifi_mgmt start Type=wpa SSID=moxa_ap Password=moxa
      wifi_mgmt start Type=open SSID=moxa_ap

  start [num]
      Connect to AP by the managed AP list number.

  start
      Connect to the last time AP that was used.

  scan -d
      Scan all the access points information and show the detail message.

  scan
      Scan all the access points information.

  signal
      Show the AP's signal.

  list
      Show the managed AP list.

  insert Type=[type] SSID=[ssid] Password=[password]
      Insert a new AP information to the managed AP list.

      [type]          open/wep/wpa/wpa2
      [ssid]          access point's SSID
      [password]      access point's password

      example:
      wifi_mgmt insert Type=wpa SSID=moxa_ap Password=moxa

  select [num]
      Select an AP num to connect which is in the managed AP list.

  stop
```

```

        Stop network.
status
        Query network connection status.
interface [num]
        Switch to another wlan[num] interface.

        [num]    interface number
example:
        wifi_mgmt interface 0
interface
        Get the current setting interface.
reconnect
        Reconnect to the access point.
restart
        Stop wpa_supplicant then start it again.
version
        Wifi management version.

```

Connecting to an AP

There are three ways to connect to an AP. The DNS and default gateway will be configured automatically. If you want to use the wireless interface's gateway, be sure to clean up your computer's default gateway first.

wifi_mgmt start Type=[type] SSID=[ssid] Password=[password]

Insert the AP information in the managed AP list and then connect to an AP.

```

root@Moxa:~# wifi_mgmt start Type=wpa SSID=moxa_ap Password=moxa
wpa_state=COMPLETED
*** Get DHCP IP address from AP ***
*** Get DHCP IP from AP! ***

```

wifi_mgmt start [num]

Connect to the AP using the managed AP list number. If you have inserted AP information before, some AP information will still be in the managed AP list. Check the managed AP list with the `wifi_mgmt list` command.

```

root@Moxa:~# wifi_mgmt list
network id / ssid / bssid / flags
0    MOXA_AP1 any    [LAST USED]
1    MOXA_AP2 any    [DISABLED]
2    MOXA_AP3 any    [DISABLED]

```

Choose an AP number to start.

```

root@Moxa:~# wifi_mgmt start 1
wpa_state=COMPLETED
*** Get DHCP IP address from AP ***
*** Get DHCP IP from AP! ***

```

wifi_mgmt start

Connect to the previous AP that was used.

```

root@Moxa:~# wifi_mgmt list
network id / ssid / bssid / flags
0    MOXA_AP1 any    [LAST USED]
1    MOXA_AP2 any    [DISABLED]
2    MOXA_AP3 any    [DISABLED]

```

Use the `wifi_mgmt` command to connect to the AP "MOXA_AP1" that was used the previous time.

```
root@Moxa:~# wifi_mgmt start
wpa_state=COMPLETED
*** Get DHCP IP address from AP ***
*** Get DHCP IP from AP! ***
```

Stop or Restart a Network Connection

wifi_mgmt stop

```
root@Moxa:~# wifi_mgmt stop
wpa_supplicant is closed!!
```

wifi_mgmt restart

```
root@Moxa:~# wifi_mgmt restart
wpa_supplicant is closed!!
wpa_state=COMPLETED
*** Get DHCP IP address from AP ***
*** Get DHCP IP from AP! ***
```

Inserting an AP or Choosing Another AP to Connect to

If you want to use another AP to connect, use the `wifi_mgmt select` command to switch to another AP.

```
root@Moxa:~# wifi_mgmt insert Type=wpa2 SSID=MOXA_AP3 Password=moxa
root@Moxa:~# wifi_mgmt list
network id / ssid / bssid / flags
0 MOXA_AP1 any [CURRENT]
1 MOXA_AP2 any [DISABLED]
2 MOXA_AP3 any [DISABLED]
```

If you want to use another AP to connect, use the `wifi_mgmt select` command to switch to another AP.

```
root@Moxa:~# wifi_mgmt list
network id / ssid / bssid / flags
0 MOXA_AP1 any [DISABLED]
1 MOXA_AP2 any [CURRENT]
2 MOXA_AP3 any [DISABLED]
root@Moxa:~# wifi_mgmt select 2
wpa_state=COMPLETED
*** Get DHCP IP address from AP ***
*** Get DHCP IP from AP! ***
```

Other Functions

wifi_mgmt scan

Scan all of the access point information.

```

root@Moxa:~# wifi_mgmt scan
bssid / frequency / signal level / flags / ssid
b0:b2:dc:dd:c9:e4      2462   -57   [WPA-PSK-TKIP][ESS]   WES_AP
fc:f5:28:cb:8c:23     2412   -57   [WPA2-EAP-CCMP-preauth][ESS]   MHQ-NB
fe:f0:28:cb:8c:23     2412   -59   [WPA2-EAP-CCMP-preauth][ESS]   MHQ-Mobile
fc:f5:28:cb:39:08     2437   -79   [WPA2-EAP-CCMP-preauth][ESS]   MHQ-NB
fe:f0:28:cb:39:08     2437   -81   [WPA2-EAP-CCMP-preauth][ESS]   MHQ-Mobile
fc:f5:28:cb:5d:a8     2462   -83   [WPA2-EAP-CCMP-preauth][ESS]   MHQ-NB
2c:54:cf:fd:5a:cf     2437   -83   [WPA-PSK-TKIP][ESS]   5566fans
fe:f0:28:cb:5d:a8     2462   -87   [WPA2-EAP-CCMP-preauth][ESS]   MHQ-Mobile
fe:f0:28:cb:5d:78     2462   -89   [WPA2-EAP-CCMP-preauth][ESS]   MHQ-Mobile
fe:f0:28:cb:39:11     2437   -89   [WPA2-EAP-CCMP-preauth][ESS]   MHQ-Mobile
fc:f5:28:cb:39:11     2437   -91   [WPA2-EAP-CCMP-preauth][ESS]   MHQ-NB
fe:f0:28:cb:39:0b     2412   -91   [WPA2-EAP-CCMP-preauth][ESS]   MHQ-Mobile
02:1a:11:f1:dc:a1     2462   -91   [WPA2-PSK-CCMP][ESS]   M9 Davidoff
fc:f5:28:cb:5d:78     2462   -93   [WPA2-EAP-CCMP-preauth][ESS]   MHQ-NB
fe:f0:28:cb:5d:b7     2462   -93   [WPA2-EAP-CCMP-preauth][ESS]   MHQ-Mobile
fc:f5:28:cb:39:0b     2412   -93   [WPA2-EAP-CCMP-preauth][ESS]   MHQ-NB
fc:f5:28:cb:5d:b7     2462   -95   [WPA2-EAP-CCMP-preauth][ESS]   MHQ-NB
fc:f5:28:cb:5d:93     2462   -97   [WPA2-EAP-CCMP-preauth][ESS]   MHQ-NB

```

wifi_mgmt scan -d

Scan all of the access point information and show a detailed message.

```

root@Moxa:~# wifi_mgmt scan -d
wlan0      Scan completed :
    Cell 01 - Address: FC:F5:28:CB:8C:23
              Channel:1
              Frequency:2.412 GHz (Channel 1)
              Quality=51/70  Signal level=-59 dBm
              Encryption key:on
              ESSID:"MHQ-NB"
                    9 Mb/s; 12 Mb/s; 18 Mb/s
              Mode:Master
                    Group Cipher : CCMP
                    Pairwise Ciphers (1) : CCMP
                    Authentication Suites (1) : 802.1x
              Preauthentication Supported
    Cell 02 - Address: FE:F0:28:CB:5D:A8
              Channel:11
              Frequency:2.462 GHz (Channel 11)
              Quality=25/70  Signal level=-85 dBm
              Encryption key:on
              ESSID:"MHQ-Mobile"
                    9 Mb/s; 12 Mb/s; 18 Mb/s
              Mode:Master
                    Group Cipher : CCMP
                    Pairwise Ciphers (1) : CCMP
                    Authentication Suites (1) : 802.1x
              Preauthentication Supported
More.. . . .

```

wifi_mgmt signal

Show the AP's signal.

```
root@Moxa:~# wifi_mgmt signal
level=-59 dBm
```

wifi_mgmt delete

```
root@Moxa:~# wifi_mgmt list
network id / ssid / bssid / flags
0    MOXA_AP1 any    [CURRENT]
1    MOXA_AP1 any    [DISABLED]
2    MOXA_AP3 any    [DISABLED]
root@Moxa:~# wifi_mgmt delete 2
***** WARNING *****
Are you sure that you want to delete network id 2 (y/n)y
network id / ssid / bssid / flags
0    MOXA_AP1 any
1    MOXA_AP2 any    [DISABLED]
```

wifi_mgmt status

```
root@Moxa:~# wifi_mgmt status
bssid=b0:b2:dc:dd:c9:e4
ssid=MOXA_AP1
id=0
mode=station
pairwise_cipher=TKIP
group_cipher=TKIP
key_mgmt=WPA-PSK
wpa_state=COMPLETED
ip_address=192.168.1.36
address=00:0e:8e:4c:13:5e
```

wifi_mgmt interface [num]

If there is more than one Wi-Fi interface, you can change the interface.

```
root@Moxa:~# wifi_mgmt interface
There is (are) 2 interface(s):
wlan0    [Current]
wlan1
root@Moxa:~# wifi_mgmt interface 1
Now is setting the interface as wlan1.
```

wifi_mgmt reconnect

```
root@Moxa:~# wifi_mgmt reconnect
wpa_state=SCANNING
wpa_state=SCANNING
wpa_state=COMPLETED
*** Get DHCP IP address from AP ***
*** Get DHCP IP from AP! ***
```

wifi_mgmt version

```
root@Moxa:~# wifi_mgmt version
wifi_mgmt version 1.0 Build 15050223
```

Configuring the Wireless LAN Using the Configuration File

You can edit the `/etc/wpa_supplicant/wpa_supplicant.conf` file to configure a Wi-Fi connection. The following is an example of the configuration file for an OPEN/WEP/WPA/WPA2 access point.

```
ctrl_interface=/var/run/wpa_supplicant
ctrl_interface_group=wheel

update_config=1

### Open system ###
#network={
#    ssid="Open"
#    key_mgmt=NONE
#}
#####

##### WEP #####
#network={
#    ssid="WEP-ssid"
#    bssid=XX:XX:XX:XX:XX:XX
#    key_mgmt=NONE
#    wep_key0=KEY
#}
#####

##### WPA/WPA2 PSK #####
#network={
#    ssid="WPA-ssid"
#    proto=WPA WPA2 RSN
#    key_mgmt=WPA-PSK
#    pairwise=TKIP CCMP
#    group=TKIP CCMP
#    psk="KEY"
#}
#####
```

The basic command to connect for WPA-supPLICANT is:

```
root@Moxa:~# wpa_supplicant -i <interface> -c <configuration file> -B
```

The `-B` option should be included because it forces the supplicant to run in the background.

1. Connect with the following command after editing `wpa_supplicant.conf`:

```
root@Moxa:~# wpa_supplicant -i wlan0 -c /etc/wpa_supplicant/wpa_supplicant.conf -B
```

2. Use `iwconfig` to check the connection status. The response you receive should be similar to the following:

```
wlan0 IEEE 802.11abgn ESSID:"MOXA_AP"
Mode:Managed Frequency:2.462 GHz Access Point: 00:1F:1F:8C:0F:64
Bit Rate=36 Mb/s Tx-Power=27 dBm
Retry min limit:7 RTS thr:off Fragment thr:off
Encryption key:1234-5678-90 Security mode:open
Power Management:off
Link Quality=37/70 Signal level=-73 dBm
Rx invalid nwid:0 Rx invalid crypt:0 Rx invalid frag:0
Tx excessive retries:0 Invalid misc:0 Missed beacon:0
```

**WARNING**

You can edit the **wpa_supplicant.conf** file dynamically using the **wifi_mgmt** command instead of directly editing the file. However, you might encounter compatibility issues if you configure Wi-Fi settings using the **wifi_mgmt** command instead of directly editing the **wpa_supplicant.conf** file.

For detailed information on the `wpa_supplicant.conf` file, go to the following websites:

http://www.daemon-systems.org/man/wpa_supplicant.conf.5.html

http://linux.die.net/man/5/wpa_supplicant.conf

Moxa strongly advises against using the WEP and WPA encryption standards. Both are now officially deprecated by the Wi-Fi Alliance, and are considered insecure. To guarantee good Wi-Fi encryption and security, use WPA2 with the AES encryption algorithm.

UC-8100-LX Security

The UC-8100-LX series offers better security by introducing Moxa's innovative secure boot feature, and the integration of a Trusted Platform Module gives the user more solid protection of the platform.

The following topics are covered in this chapter:

- ❑ **Secure Boot**
- ❑ **Sudo Mechanism**

Secure Boot

Secure boot is a novel authentication algorithm, developed by Moxa, designed to make platform integration more secure. Only trusted Linux kernels and bootloaders can be executed, and malicious or un-authenticated kernels will not be able to boot up the UC-8100-LX. All UC-8100-LX computers support this feature by default.

For the UC-8100-LX, the kernel file will be stored on the SD card in cipher text. This is the first protection for a secure platform. Even if someone copies the kernel file, it will be extremely difficult for them to understand or make malicious modifications to the code.

Next, during boot up, the ciphered kernel will be checked and decrypted into plain kernel format. If the kernel is being replaced by malicious code, the predefined decryption will not make the kernel code executable.

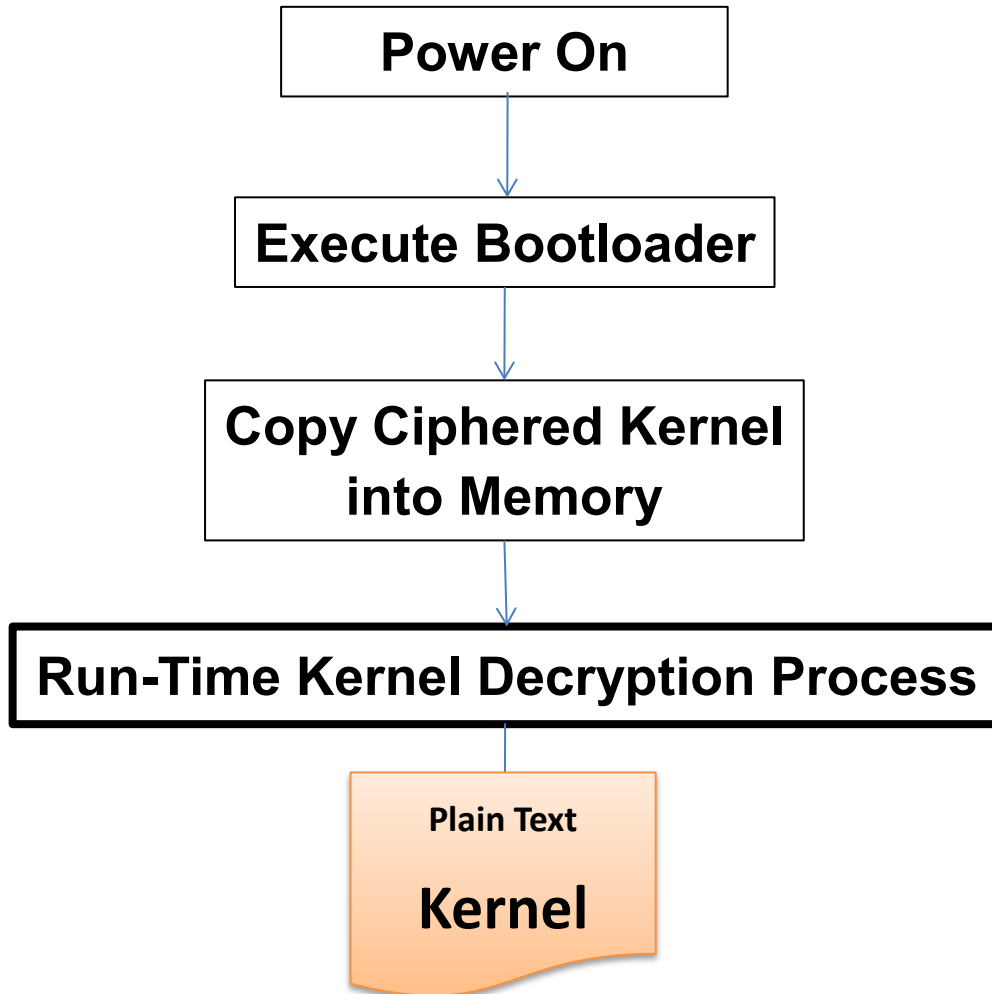

 **ATTENTION** Do NOT arbitrarily replace the kernel or bootloader, or the computer will not be able to boot up.

NOTE Secure Boot is only provided with the UC-8100-LX standard image. The source code provided on Moxa’s website does not include source code for the Secure Boot feature.

Sudo Mechanism

In the UC-8100-LX, the root account is disabled for better security. Sudo is a program designed to let system administrators allow some users to execute some commands as root (or another user). The basic philosophy is to give as few privileges as possible but still allow people to get their work done. Using sudo is better (safer) than opening a session as root for a number of reasons, including:

- Nobody needs to know the root password (sudo prompts for the current user's password). Extra privileges can be granted to individual users temporarily, and then taken away without the need for a password change.
- It is easy to run only the commands that require special privileges via sudo; the rest of the time, you work as an unprivileged user, which reduces the damage that mistakes can cause.
- The code below shows that some system level commands are not available to user moxa directly.

```
moxa@moxa:~$ ifconfig
-bash: ifconfig: command not found

moxa@moxa:~$ sudo ifconfig
eth0      Link encap:Ethernet  HWaddr 00:90:e8:00:00:07
          inet addr:192.168.3.127  Bcast:192.168.3.255  Mask:255.255.255.0
          UP BROADCAST ALLMULTI MULTICAST  MTU:1500  Metric:1
          RX packets:0 errors:0 dropped:0 overruns:0 frame:0
          TX packets:0 errors:0 dropped:0 overruns:0 carrier:0
          collisions:0 txqueuelen:1000
          RX bytes:0 (0.0 B)  TX bytes:0 (0.0 B)

eth1      Link encap:Ethernet  HWaddr 00:90:e8:00:00:08
          inet addr:192.168.4.127  Bcast:192.168.4.255  Mask:255.255.255.0
          UP BROADCAST ALLMULTI MULTICAST  MTU:1500  Metric:1
          RX packets:0 errors:0 dropped:0 overruns:0 frame:0
          TX packets:0 errors:0 dropped:0 overruns:0 carrier:0
          collisions:0 txqueuelen:1000
          RX bytes:0 (0.0 B)  TX bytes:0 (0.0 B)

lo        Link encap:Local Loopback
          inet addr:127.0.0.1  Mask:255.0.0.0
          inet6 addr: ::1/128 Scope:Host
          UP LOOPBACK RUNNING  MTU:16436  Metric:1
          RX packets:32 errors:0 dropped:0 overruns:0 frame:0
          TX packets:32 errors:0 dropped:0 overruns:0 carrier:0
          collisions:0 txqueuelen:0
          RX bytes:2592 (2.5 KiB)  TX bytes:2592 (2.5 KiB)
```

General Debian Package

In this chapter, we explain how to configure the UC-8100-LX's functions.

The following topics are covered in this chapter:

- ❑ **NTP Client**
- ❑ **Executing Scheduled Commands Using Cron**
 - Updating System Time and RTC
- ❑ **Rocket-Fast System for Log Processing: rsyslog**
 - Rsyslog's Configuration File
 - Syntax of the Selector
- ❑ **OpenSSL**
 - Ciphers
 - Cryptographic Hash Functions
 - Public-Key Cryptography
- ❑ **The Apache Web Server**
 - Editing the Server Name in the Configuration File
- ❑ **SFTP**
- ❑ **DNS**
 - /etc/hosts
 - /etc/resolv.conf
 - /etc/nsswitch.conf
- ❑ **iptables**
 - Observing and Erasing Chain Rules
 - Defining a Policy for Chain Rules
 - Append or Delete Rules
- ❑ **rsync**
 - Using rsync for External Backups
 - Automating rsync Backups
- ❑ **NAT**
 - NAT Example
 - Enabling NAT at Bootup
- ❑ **NFS (Network File System)**
 - Setting Up the UC-8100-LX as an NFS Client
- ❑ **SNMP**
- ❑ **OpenVPN**
 - Static-Key VPN
- ❑ **Package Management**
 - apt-get
 - apt-cache
 - List All Available Packages

- Find Package Name and Software Description
- Check Package Information
- Check Dependencies for Specific Packages
- Check Cache Statistics
- Update System Packages
- Install or Upgrade Specific Packages
- Upgrade All Software Packages
- Install Multiple Packages
- Install Packages without Upgrading
- Upgrade Specific Packages
- Install Specific Package Version
- Remove Packages Without Configuration
- Completely Remove Packages
- Clean Up Disk Space
- Download Only Source Code of Package
- Download and Unpack a Package
- Download, Unpack, and Compile a Package
- Download a Package Without Installing
- Check the Package Change Log
- Check Broken Dependencies
- Search and Build Dependencies

- Auto Clean Apt-Get Cache
- Auto Remove Installed Packages

NTP Client

The UC-8100-LX has a built-in NTP (Network Time Protocol) client that is used to initialize a time request to a remote NTP server. Use `#ntpdate <this client utility>` to update the system time.

```
ntpdate 192.168.1.97
hwclock -w
```

Visit <http://www.ntp.org> for more information about NTP and NTP server addresses.

```
192.168.4.127 - PuTTY
moxa@moxa:~$ sudo ntpdate 192.168.50.33
6 May 03:55:10 ntpdate[4511]: step time server 192.168.50.33 offset 78338115.278119
sec
moxa@moxa:~$ sudo hwclock -w
moxa@moxa:~$ sudo hwclock
Tue 06 May 2014 03:56:14 AM UTC -0.846314 seconds
```

NOTE Before using the NTP client utility, check your IP and DNS settings to make sure that an Internet connection is available. Refer to Chapter 2 for instructions on how to configure the Ethernet interface, and see Chapter 4 for DNS setting information.

Executing Scheduled Commands Using Cron

The `cron` daemon reads `/etc/crontab` to retrieve scripts and other commands to be run at regularly scheduled times.

The cron daemon wakes up every minute and checks each command listed in the crontab file to see if it should be run at that time. Whenever the `cron` daemon executes a command, a report is automatically mailed to the owner of the crontab (or to the user named in the MAILTO environment variable in the crontab, if such a user exists).

Modify the file `/etc/crontab` to schedule an application. The crontab entries follow the format illustrated below:

mm	h	dom	mon	dow	user	command
minute	hour	date	month	week	user	<command>
0-59	0-23	1-31	1-12	0-6 (0 is Sunday)		

For example, run the following command if you want to launch a program at 8:00 every day:

```
#minute hour date month dow user command
* 8 * * * root /path/to/your/program
```

Every column in a crontab entry must be marked with a character. The asterisk indicates “every possible unit,” so that setting an asterisk in the day-of-week column will configure cron to run the command on every day of the week. If you wish to run a command “every X minutes” or “every X hours”, then use the format `*/X`.

Updating System Time and RTC

Take the following steps to use cron to update the system time and RTC:

1. Write a shell script named `fixtime.sh` and save it to the `/home` directory.

```
#!/bin/sh
ntpdate time.stdtime.gov.tw
hwclock -w
exit 0
```

2. Reset the access permissions for `fixtime.sh`

```
moxa@Moxa:~# sudo chmod 755 fixtime.sh
```

3. Modify the `/etc/crontab` file to run `fixtime.sh` every 10 minutes (i.e.: `*/10`) by adding this line:

```
*/10 * * * * root /home/fixtime.sh
```

NOTE Click the following link for more information on cron.
<http://www.debian-administration.org/articles/56>

Rocket-Fast System for Log Processing: rsyslog

Rsyslog is an enhanced, multi-threaded log reporting utility with a focus on security and reliability. It offers support for on-demand disk buffering, log reports and alarms delivered over TCP, SSL, TLS, and RELP, writing to databases, and email alerting. It is a drop-in replacement for `syslogd`.

Rsyslog is installed but disabled by default.

Enable rsyslog manually	<code>/etc/init.d/rsyslog start</code>
Disable rsyslog manually	<code>/etc/init.d/rsyslog stop</code>
Enable rsyslog	<code>insserv -d rsyslog</code>
Disable rsyslog	<code>insserv -r rsyslog</code>

Rsyslog's Configuration File

The syntax of the `/etc/rsyslog.conf` file is detailed in the `rsyslog.conf(5)` manual page, but there is also HTML documentation available in the `rsyslog-doc` package (`/usr/share/doc/rsyslog-doc/html/index.html`). The overall principle is to write "selector" and "action" pairs. The selector defines all relevant messages, and the action describes how to deal with them.

Each message is associated with an application, called a facility in rsyslog documentation:	
auth and authpriv	for authentication
cron	comes from task scheduling services, cron and atd
daemon	affects a daemon without any special classification (DNS, NTP, etc.)
ftp	concerns the FTP server
kern	message coming from the kernel
lpr	comes from the printing subsystem
mail	comes from the e-mail subsystem
news	Usenet subsystem message (especially from an NNTP — Network News Transfer Protocol — server that manages newsgroups)
syslog	messages from the syslogd server, itself
user	user messages (generic)
uucp	messages from the UUCP server (Unix to Unix Copy Program, an old protocol notably used to distribute e-mail messages)
local0 to local7	reserved for local use
Each message is also associated with a priority level. Here is the list in decreasing order:	

emerg	Help! There's an emergency, the system is probably unusable.
alert	hurry up, any delay can be dangerous, action must be taken immediately
crit	conditions are critical
err	error
warn	warning (potential error)
notice	conditions are normal, but the message is important
info	informative message
debug	debugging message

Syntax of the Selector

The selector is a semicolon-separated list of *subsystem.priority* pairs (example: **auth.notice;mail.info**). An asterisk represents all subsystems or all priorities (examples: ***.alert** or **mail.***). Several subsystems can be grouped, by separating them with a comma (example: **auth,mail.info**). The priority indicated also covers messages of equal or higher priority; thus **auth.alert** indicates the auth subsystem messages of alert or emerg priority. Prefixed with an exclamation point (!), it indicates the opposite, in other words the strictly lower priorities; **auth.!notice**, indicates messages issued from auth, with info or debug priority. Prefixed with an equal sign (=), it corresponds to precisely and only the priority indicated (**auth.=notice** only concerns messages from auth with notice priority).

Each element in the list on the selector overrides previous elements. It is thus possible to restrict a set or to exclude certain elements from it. For example, **kern.info;kern.!err** means messages from the kernel with priority between info and warn. The none priority indicates the empty set (no priorities), and excludes a subsystem from a set of messages. Thus, ***.crit;kern.none** indicates all the messages of priority equal to or higher than crit not coming from the kernel.

NOTE Click the following link for more information on rsyslog.

<https://wiki.debian.org/Rsyslog>

<http://www.rsyslog.com/doc/>

OpenSSL

The UC-8100 supports hardware accelerator with openssl. Type **lsmod** to make sure the **cryptodev** module is loaded.

```
Module                Size Used by
cryptodev             30504  1
```

Check the version of openssl; it should indicate that it was modified by Moxa.

```
moxa@Moxa:~$ dpkg -l | grep openssl
ii  openssl                    1.0.1e-2+deb7u7+uc8100 armhf      Secure Socket
Layer (SSL) binary and related cryptographic tools on MOXA uc8100
```

Before enabling hardware accelerator:

```
root@Moxa:/home# openssl speed -evp aes-128-cbc
Doing aes-128-cbc for 3s on 16 size blocks: 5625719 aes-128-cbc's in 2.95s
Doing aes-128-cbc for 3s on 64 size blocks: 1769561 aes-128-cbc's in 2.94s
Doing aes-128-cbc for 3s on 256 size blocks: 498367 aes-128-cbc's in 2.99s
Doing aes-128-cbc for 3s on 1024 size blocks: 125670 aes-128-cbc's in 2.95s
Doing aes-128-cbc for 3s on 8192 size blocks: 16023 aes-128-cbc's in 2.99s
OpenSSL 1.0.1e 11 Feb 2013
built on: Mon Apr  7 03:26:32 UTC 2014
options:bn(64,32) rc4(ptr,char) des(idx,cisc,16,long) aes(partial) idea(int) blowfish(ptr)

compiler: gcc -fPIC -DOPENSSL_PIC -DOPENSSL_THREADS -D_REENTRANT -DDSO_DLFCN -DHAVE_DLFCN
_H -DHAVE_CRYPTODEV -DUSE_CRYPTDEV_DIGESTS -march=armv7-a -Wa,--noexecstack -DTERMIO -O3 -W
all -DOPENSSL_BN_ASM_MONT -DOPENSSL_BN_ASM_GF2m -DSHA1_ASM -DSHA256_ASM -DSHA512_ASM -DAES
_ASM -DGHASH_ASM
The 'numbers' are in 1000s of bytes per second processed.
type                16 bytes    64 bytes    256 bytes    1024 bytes    8192 bytes
aes-128-cbc         30512.37k   38521.06k   42669.55k   43622.40k   43899.80k
```

After enabling hardware accelerator:

```
moxa@moxa:~$ sudo openssl speed -evp aes-128-cbc
[sudo] password for moxa:
Doing aes-128-cbc for 3s on 16 size blocks: 261302 aes-128-cbc's in 0.14s
Doing aes-128-cbc for 3s on 64 size blocks: 222033 aes-128-cbc's in 0.13s
Doing aes-128-cbc for 3s on 256 size blocks: 139516 aes-128-cbc's in 0.16s
Doing aes-128-cbc for 3s on 1024 size blocks: 48524 aes-128-cbc's in 0.09s
Doing aes-128-cbc for 3s on 8192 size blocks: 8126 aes-128-cbc's in 0.00s
OpenSSL 1.0.1e 11 Feb 2013
built on: Mon Apr 21 06:14:54 UTC 2014
options:bn(64,32) rc4(ptr,char) des(idx,cisc,16,long) aes(partial) idea(int)
blowfish(ptr)
compiler: gcc -fPIC -DOPENSSL_PIC -DOPENSSL_THREADS -D_REENTRANT -DDSO_DLFCN
-DHAVE_DLFCN_H -DHAVE_CRYPTODEV -DUSE_CRYPTDEV_DIGESTS -march=armv7-a
-Wa,--noexecstack -DTERMINO -O3 -Wall -DOPENSSL_BN_ASM_MONT -DOPENSSL_BN_ASM_GF2m
-DSHA1_ASM -DSHA256_ASM -DSHA512_ASM -DAES_ASM -DGHASH_ASM
The 'numbers' are in 1000s of bytes per second processed.
type          16 bytes    64 bytes    256 bytes    1024 bytes    8192 bytes
aes-128-cbc    29863.09k    109308.55k    223225.60k    552095.29k      infk
```

OpenSSL supports a number of different cryptographic algorithms, described in the following subsections.

Ciphers

Ciphers support the following cryptographic methods:

AES, Blowfish, Camellia, SEED, CAST-128, DES, IDEA, RC2, RC4, RC5, Triple DES, GOST 28147-89

Cryptographic Hash Functions

MD5, MD4, MD2, SHA-1, SHA-2, RIPEMD-160, MDC-2, GOST R 34.11-94

Public-Key Cryptography

RSA, DSA, Diffie-Hellman key exchange, Elliptic curve, GOST R 34.10-2001

NOTE Make sure that the version of openssl was built by Moxa, or the hardware accelerator function will not work with other versions.

The Apache Web Server

The Apache HTTP Server Project is an effort to develop and maintain an open-source HTTP server for modern operating systems, including UNIX and Windows NT. The goal of this project is to provide a secure, efficient, and extensible server that provides HTTP services in sync with the current HTTP standards.

APACHE is installed but disabled by default.

To	Use
Enable apache manually	sudo /etc/init.d/apache2 start
Disable apache manually	sudo /etc/init.d/apache2 stop
Enable apache	insserv -d apache2
Disable apache	insserv -r apache2

Editing the Server Name in the Configuration File

Editing the apache2.conf file:

```
moxa@Moxa:~$ sudo vi /etc/apache2/apache2.conf
```

Adding a server name for this device in the `apache2.conf` file:

```
ServerName xxx
```

Restarting the Apache2 server:

```
moxa@Moxa:~$ sudo /etc/init.d/apache2 restart
```

NOTE Click the following links for more information on apache.

<https://wiki.debian.org/Apache>

<http://httpd.apache.org/>

SFTP

The default SFTP daemon will start when the system boots up. The login and password used are the same as the system login and password (**moxa/moxa**). You can also configure the SFTP account using the following steps:

1. Create a user & group for SFTP access, without a shell.

```
moxa@Moxa:~$ sudo adduser sftp
[sudo] password for moxa:
Adding user `sftp' ...
Adding new group `sftp' (1003) ...
Adding new user `sftp' (1001) with group `sftp' ...
Creating home directory `/home/sftp' ...
Copying files from `/etc/skel' ...
Enter new UNIX password:
Retype new UNIX password:
passwd: password updated successfully
Changing the user information for sftp
Enter the new value, or press ENTER for the default
  Full Name []:
  Room Number []:
  Work Phone []:
  Home Phone []:
  Other []:
Is the information correct? [Y/n]
```

To block the user account "sftp" from being used for normal Linux logins, and only available for sftp programs, we need to assign a special shell for the account. In the example shown below, we assign the shell "/bin/false" to the user account "sftp" and change account's folder and owner.

```
moxa@moxa:~$ sudo usermod -s /bin/false sftp
```

```
moxa@moxa:~$ sudo mkdir /home/sftp/upload/
moxa@moxa:~$ sudo chown root:root /home/sftp
moxa@moxa:~$ sudo chown sftp:sftp /home/sftp/upload/
```

2. Use the following command to append SSHD-related configuration to the `/etc/ssh/sshd_config` file.

```
Subsystem sftp internal-sftp
#Subsystem sftp /usr/lib/openssh/sftp-server
```

```
Match User sftp
ChrootDirectory /home/%u
ForceCommand internal-sftp
```

3. Restart the SSHD Daemon:

```
moxa@moxa:~$ sudo /etc/init.d/sshd restart
```

4. At this point, the account and its default path should be configured.

NOTE Click the following link for more information on SSH.

<https://wiki.debian.org/SSH>

DNS

The UC-8100-LX supports DNS client (but not DNS server). To set up DNS client, you need to edit three configuration files: `/etc/hosts`, `/etc/resolv.conf`, and `/etc/nsswitch.conf`.

`/etc/hosts`

This is the first file that the Linux system reads to resolve the host name and IP address.

`/etc/resolv.conf`

This is the most important file that you need to edit when using DNS for the other programs. For example, before using the `#ntpdate time.nist.gov` command to update the system time, you will need to add the DNS server address to the file. Ask your network administrator which DNS server address you should use. The DNS server's IP address is specified using the `nameserver` command. For example, add the following line to the `/etc/resolv.conf` file if the DNS server's IP address is 168.95.1.1:

```
nameserver 168.95.1.1
```

```
10.120.53.100 - PuTTY
moxa@moxa:~$ sudo cat /etc/resolv.conf
#
# resolv.conf This file is the resolver configuration file
# See resolver(5).
#
#nameserver 192.168.1.16
nameserver 168.95.1.1
nameserver 140.115.1.31
nameserver 140.115.236.10
```

/etc/nsswitch.conf

This file defines the sequence to resolve the IP address by using /etc/hosts file or /etc/resolv.conf.

iptables

The **iptables** tool is an administrative tool for setting up, maintaining, and inspecting the Linux kernel's IP packet filter rule tables. Several different tables are defined, with each table containing built-in chains and user-defined chains.

Each chain is a list of rules that apply to a certain type of packet. Each rule specifies what to do with a matching packet. A rule (such as a jump to a user-defined chain in the same table) is called a **target**.

The UC-8100-LX supports the following three iptables: **Filter** tables, **NAT** tables, and **Mangle** tables

Filter Table—includes three chains:

- INPUT chain
- OUTPUT chain
- FORWARD chain

NAT Table—includes three chains:

- PREROUTING chain—transfers the destination IP address (DNAT)

- POSTROUTING chain—works after the routing process and before the Ethernet device process to transfer the source IP address (SNAT)

- OUTPUT chain—produces local packets

sub-tables

- Source NAT (SNAT)—changes the first source packet IP address

- Destination NAT (DNAT)—changes the first destination packet IP address

- MASQUERADE—a special form for SNAT. If one host can connect to internet, then other computers that connect to this host can connect to the Internet when it the computer does not have an actual IP address.

- REDIRECT—a special form of DNAT that re-sends packets to a local host independent of the destination IP address.

Mangle Table—includes two chains, and it has three extensions—TTL, MARK, TOS.

- PREROUTING chain—pre-processes packets before the routing process.

- OUTPUT chain—processes packets after the routing process.

The following figure shows the iptables hierarchy:

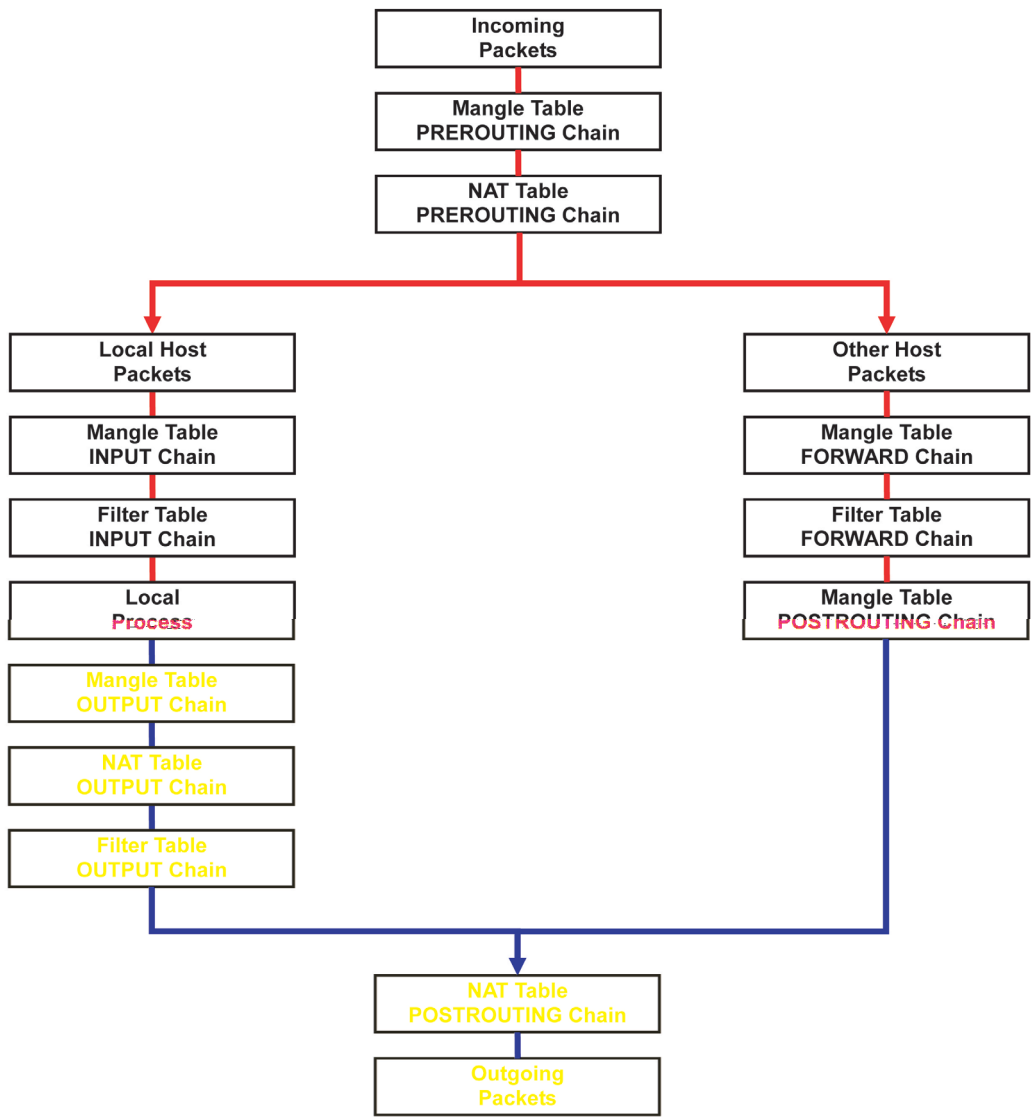
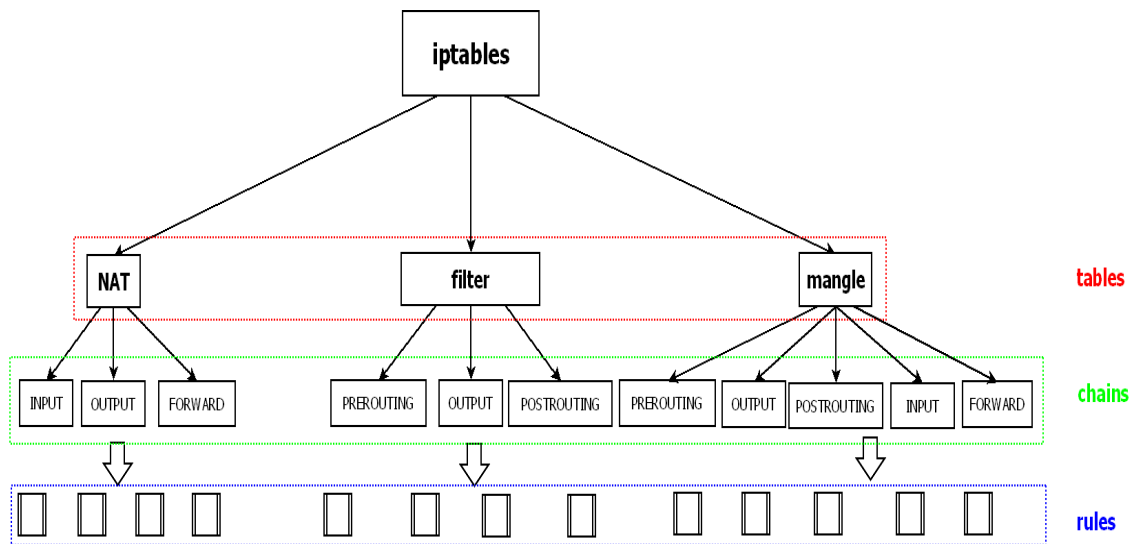

Table	Chain	Rule
NAT (Network translation translation)	PREROUTING	Types of rule <ul style="list-style-type: none"> • Policy • Self-defined
	POSTROUTING	
	OUTPUT	
Filter (Default) (Packet filtering)	INPUT	Targets of rule <ul style="list-style-type: none"> • ACCEPT • DROP • REJECT • LOG • SNAT • DNAT • MASQUERADE
	OUTPUT	
	FORWARD	
Mangle (Packet header modification)	PREROUTING	
	INPUT	
	FORWARD	
	OUTPUT	
	POSTROUTING	



The UC-8100-LX supports the following sub-modules. Be sure to use the module that matches your application.

The most common modules are already built in to the kernel:

ip6t_eui64.ko	ip6t_ipv6header.ko	nf_contrack_ipv6.ko	xfrm4_mode_tunnel.ko
ip6t_rt.ko	ip6t_LOG.ko	xfrm6_mode_beet.ko	ah4.ko
ip6table_security.ko	ip6t_ah.ko	sit.ko	xfrm4_mode_beet.ko
ip6table_filter.ko	ip6_tables.ko	ipv6.ko	xfrm4_mode_transport.ko
ip6t_frag.ko	ip6table_raw.ko	xfrm6_mode_tunnel.ko	esp4.ko
ip6t_hbh.ko	nf_defrag_ipv6.ko	xfrm6_mode_transport.ko	ipcomp.ko
ip6t_REJECT.ko	ip6t_mh.ko	xfrm_ipcomp.ko	tcp_diag.ko
inet_lro.ko	xfrm4_tunnel.ko	inet_diag.ko	

The basic syntax to enable and load an iptables module is as follows:

Use `lsmod` to check if the `ip_tables` module has already been loaded in the UC-8100-LX series. Use the `modprobe` command to insert and enable the module.

Use the following command to load the modules (`iptables_filter`, `iptables_mangle`, and `iptables_nat`):

```
#modprobe iptable_filter
```

Use the `iptables`, `iptables-restore`, `iptables-save` command to maintain the database.

NOTE The `iptables` tool plays the role of packet filtering or NAT. Take care when setting up the iptables rules. If the rules are not correct, remote hosts that connect via a LAN or PPP might be denied access. We recommend using the serial console to set up the iptables tool.

Click on the following links for more information on iptables:

<http://www.linuxguruz.com/iptables/>

<http://www.netfilter.org/documentation/HOWTO//packet-filtering-HOWTO.html>

<https://wiki.debian.org/DebianFirewall>

<https://wiki.debian.org/iptables>

Since the `iptables` command is very complex, we have divided our discussion of the syntax rules into three categories: **Observe and erase chain rules**, **Define policy rules**, and **Append or delete rules**.

Observing and Erasing Chain Rules

Commands

```
# iptables [-t tables] [-I] [-n]
-t tables:      Table to manipulate (default: 'filter'); example: nat or filter.
-L [chain]:     List all rules in selected chains. If no chain is selected, all chains are listed.
-n:            Numeric output of addresses and ports.

# iptables [-t tables] [-FXZ]
-F:           Flush the selected chain (all the chains in the table if none is listed).
-X:           Delete the specified user-defined chain.
-Z:           Set the packet and byte counters in all chains to zero.
```

Examples

```
# iptables -L -n
```

In this example, since we do not use the `-t` parameter, the system uses the default `'filter'` table. Three chains are included: `INPUT`, `OUTPUT`, and `FORWARD`. `INPUT` chains are accepted automatically, and all connections are accepted without being filtered.

```
#iptables -F
#iptables -X
#iptables -Z
```

Defining a Policy for Chain Rules

Command

```
# iptables [-t tables] [-P] [INPUT, OUTPUT, FORWARD, PREROUTING, OUTPUT, POSTROUTING]
[ACCEPT, DROP]
-P:           Set the policy for the chain to the given target.
INPUT:       For packets coming into the UC-8100-LX series.
OUTPUT:     For locally-generated packets.
FORWARD:    For packets routed out through the UC-8100-LX series.
PREROUTING: To alter packets as soon as they come in.
POSTROUTING: To alter packets as they are about to be sent out.
```

Examples

```
#iptables -P INPUT DROP
#iptables -P OUTPUT ACCEPT
#iptables -P FORWARD ACCEPT
#modprobe iptable_nat
#iptables -t nat -P PREROUTING ACCEPT
#iptables -t nat -P OUTPUT ACCEPT
#iptables -t nat -P POSTROUTING ACCEPT
```

In this example, the policy accepts outgoing packets and denies incoming packets.

Append or Delete Rules

Command

```
# iptables [-t table] [-AI] [INPUT, OUTPUT, FORWARD] [-io interface] [-p tcp, udp,
icmp, all] [-s IP/network] [--sport ports] [-d IP/network] [--dport ports] -j [ACCEPT.
DROP]
```

-A: Append one or more rules to the end of the selected chain.
-I: Insert one or more rules in the selected chain as the given rule number.
-i: Name of an interface via which a packet is going to be received.
-o: Name of an interface via which a packet is going to be sent.
-p: The protocol of the rule or of the packet to check.
-s: Source address (network name, host name, network IP address, or plain IP address).
--sport: Source port number.
-d: Destination address.
--dport: Destination port number.
-j: Jump target. Specifies the target of the rules; i.e., how to handle matched packets.
For example, ACCEPT the packet, DROP the packet, or LOG the packet.

Examples:

Example 1: Accept all packets from lo interface.

```
# iptables -A INPUT -i lo -j ACCEPT
```

Example 2: Accept TCP packets from 192.168.0.1.

```
# iptables -A INPUT -i eth0 -p tcp -s 192.168.0.1 -j ACCEPT
```

Example 3: Accept TCP packets from Class C network 192.168.1.0/24.

```
# iptables -A INPUT -i eth0 -p tcp -s 192.168.1.0/24 -j ACCEPT
```

Example 4: Drop TCP packets from 192.168.1.25.

```
# iptables -A INPUT -i eth0 -p tcp -s 192.168.1.25 -j DROP
```

Example 5: Drop TCP packets addressed for port 21.

```
# modprobe xt_tcpudp
# iptables -A INPUT -i eth0 -p tcp --dport 21 -j DROP
```

Example 6: Accept TCP packets from 192.168.0.24 to UC-8100 series's port 137, 138, 139

```
# iptables -A INPUT -i eth0 -p tcp -s 192.168.0.24 --dport 137:139 -j ACCEPT
```

Example 7: Log TCP packets that visit UC-8100 series's port 25.

```
# iptables -A INPUT -i eth0 -p tcp --dport 25 -j LOG
```

Example 8: Drop all packets from MAC address 01:02:03:04:05:06.

```
# modprobe xt_mac
# iptables -A INPUT -i eth0 -p all -m mac --mac-source 01:02:03:04:05:06 -j DROP
```

NOTE: In *Example 8* above, run the `#modprobe ipt_mac` command first to load the `ipt_mac` module.

rsync

rsync is a utility software and network protocol that synchronizes files and directories from one location to another while minimizing data transfer by using delta encoding when appropriate. It also has the option to provide encrypted transfer by use of SSH. SSL encrypted transfer can be done via Stunnel wrapping. rsync uses the 'rsync algorithm', which provides a very fast method for bringing remote files into sync. rsync can copy or display directory contents and copy files, optionally using compression and recursion.

The **rsync** command can be used to back up data to the destination location with encryption. The following example illustrates how to back up data backup from directory1 to directory2:

```
moxa@Moxa:~$ sudo rsync -avP /Directory1/ /Directory2/
```

-v, --verbose	increase verbosity
-a, --archive	archive mode; equals -r-lptgoD (no -H,-A,-X)
-P --progress	show progress during transfer
--partial	keep partially transferred files

Using rsync for External Backups

rsync can be configured in several different ways for external backups, but we will go over the most practical (also the easiest and most secure) method of tunneling rsync through SSH. Most servers and even many clients already have SSH, and it can be used for your rsync backups. We will show you the process to get one Linux machine to back up to another on a local network. The process would be exactly the same if one host was somewhere on the Internet; just note that port 22 (or whatever port you have SSH configured on), would need to be forwarded on any network equipment on the server's side of things.

Other than installing SSH and rsync on the server, all that really needs to be done is to set up the repositories on the server where you would like the files backed up, and make sure that SSH is locked down. Make sure the user you plan on using has a complex password. For additional security, you might also want to switch the port (default port is 22) that SSH listens on.

We will run the same command that we did for using rsync on a local computer, but include the necessary additions for tunneling rsync through SSH to a server on my local network. For user "user" connecting to "192.168.1.1" and using the same switches as above (-avP) we will run the following:

```
moxa@Moxa:~$ sudo rsync -avP -e ssh /Directory1/ user@192.168.1.1:/Directory2/
```

Automating rsync Backups

Cron can be used on Linux to automate the execution of commands, such as **rsync**. Using cron, we can have our Linux system run nightly backups, or however often you would like them to run.

To edit the cron table file for the user you are logged in as, run:

```
moxa@Moxa:~$ sudo crontab -e
```

You will need to be familiar with the **vi** editor to edit this file. Type "I" for insert, and then begin editing the cron table file.

The cron syntax has the following structure:

```
<minute of the hour>.<hour of the day>.<day of the month>. <month of the year>.<day of the week>.<command>
```

The following command will run the **rsync** command every night at 10 PM:

```
0 22 * * * rsync -avP /Directory1/ /Directory2/
```

The first "0" specifies the minute of the hour, and "22" specifies 10 PM. Since we want this command to run daily, we will leave the rest of the fields with asterisks and then paste the **rsync** command.

NOTE Click the following link for more information on iptables and rsync:
<http://rsync.samba.org/>

NAT

The NAT (Network Address Translation) protocol translates IP addresses used on one network into IP addresses used on a connecting network. One network is designated the inside network and the other is the outside network. Typically, the UC-8100 series connects several devices on a network and maps local inside network addresses to one or more global outside IP addresses, and un-maps the global IP addresses on incoming packets back into local IP addresses.



ATTENTION

Click on the following link for more information about NAT:

<http://www.netfilter.org/documentation/HOWTO//packet-filtering-HOWTO.html>

NAT Example

In this example, the IP addresses of all packets leaving LAN1 are changed to **192.168.3.127** (you will need to load the module `ipt_MASQUERADE`):

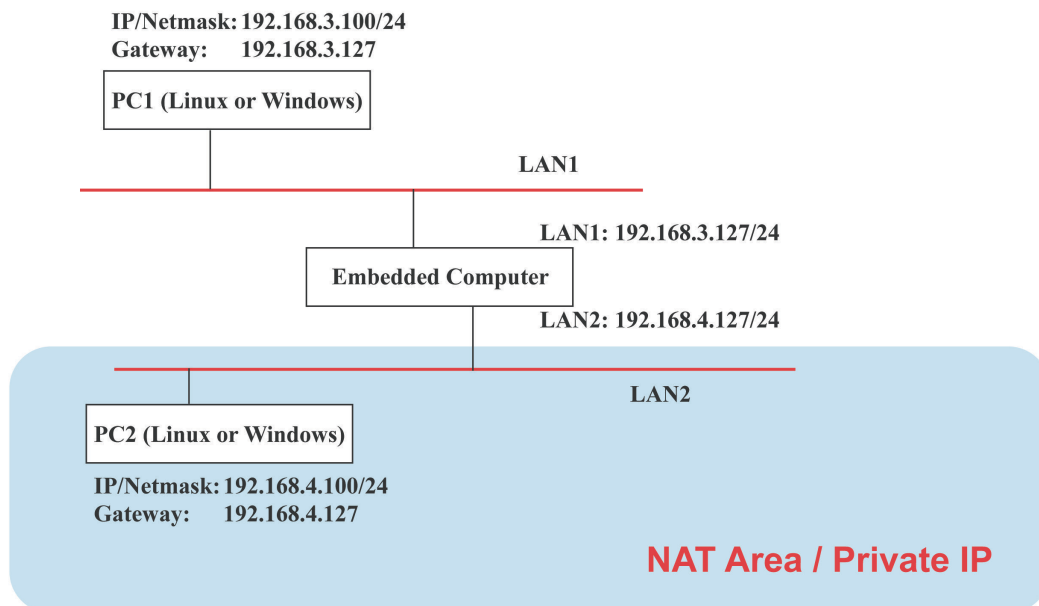

Enabling NAT at Bootup

In most real world situations, you will want to use a simple shell script to enable NAT when the device boots up. The following script is an example.

```
#!/bin/bash
# If you put this shell script in the /home/nat.sh
# Remember to chmod 744 /home/nat.sh
# Edit the rc.local file to make this shell startup automatically
# vi /etc/rc.local
# Add a line in the end of rc.local /home/nat.sh
EXIF= "eth0" #This is an external interface for setting up a valid IP address.
EXNET= "192.168.4.0/24" #This is an internal network address.
# Step 1. Insert modules.
# Here 2> /dev/null means the standard error messages will be dump to null device.
modprobe ip_tables 2> /dev/null
modprobe ip_nat_ftp 2> /dev/null
modprobe ip_nat_irc 2> /dev/null
modprobe ip_contrack 2> /dev/null
modprobe ip_contrack_ftp 2> /dev/null
modprobe ip_contrack_irc 2> /dev/null
# Step 2. Define variables, enable routing and erase default rules.
PATH=/bin:/sbin:/usr/bin:/usr/sbin:/usr/local/bin:/usr/local/sbin
export PATH
echo "1" > /proc/sys/net/ipv4/ip_forward
/sbin/iptables -F
/sbin/iptables -X
/sbin/iptables -Z
/sbin/iptables -F -t nat
/sbin/iptables -X -t nat
/sbin/iptables -Z -t nat
/sbin/iptables -P INPUT ACCEPT
/sbin/iptables -P OUTPUT ACCEPT
/sbin/iptables -P FORWARD ACCEPT
/sbin/iptables -t nat -P PREROUTING ACCEPT
/sbin/iptables -t nat -P POSTROUTING ACCEPT
/sbin/iptables -t nat -P OUTPUT ACCEPT
# Step 3. Enable IP masquerade.
#ehco 1 > /proc/sys/net/ipv4/ip_forward
#modprobe ipt_MASQUERADE
#iptables -t nat -A POSTROUTING -o eth0 -j MASQUERADE
```

NFS (Network File System)

The Network File System (NFS) is used to mount a disk partition on a remote machine, as if it were on a local hard drive, allowing fast, seamless sharing of files across a network. NFS allows users to develop applications for the UC-8100 series without worrying about the amount of disk space that will be available. The UC-8100 series supports NFS protocol for clients.

The NFS function is installed but disabled by default. Check the following table for details on commands to enable/disable NFS:

To	use the commands
enable NFS manually	<code>sudo /etc/init.d/nfs-common start</code> <code>sudo /etc/init.d/nfs-kernel-server start</code> <code>sudo /etc/init.d/rpcbind start</code>
disable NFS manually	<code>sudo /etc/init.d/nfs-common stop</code> <code>sudo /etc/init.d/nfs-kernel-server stop</code> <code>sudo /etc/init.d/rpcbind stop</code>
enable NFS	<code>insserv -d nfs-common</code> <code>insserv -d nfs-kernel-server</code> <code>insserv -d /etc/init.d/rpcbind</code>
disable NFS	<code>insserv -r nfs-common</code> <code>insserv -r nfs-kernel-server</code> <code>insserv -r /etc/init.d/rpcbind</code>

Setting Up the UC-8100-LX as an NFS Client

The following procedure is used to mount a remote NFS Server.

Step 1: Create a folder to link a mount point on the NFS Client site.

```
#mkdir -p /home/nfs/public
```

Step 2: Mount the remote directory to a local directory.

```
#mount -t nfs NFS_Server(IP):/directory /mount/point
```

Example

```
: #mount -t nfs 192.168.3.100/home/public /home/nfs/public
```

NOTE Click the following links for more information on NFS:

<http://www.tldp.org/HOWTO/NFS-HOWTO/index.html>

<http://nfs.sourceforge.net/nfs-howto/client.html>

<http://nfs.sourceforge.net/nfs-howto/server.html>

SNMP

The UC-8100 series has SNMP (Simple Network Management Protocol) agent software built in. It supports RFC1317 RS-232 like group and RFC 1213 MIB-II. SNMP daemon is installed but disabled by default. You can activate the daemon manually or set it to be enabled by default.

To start/stop the service, use the following commands:

To	use the command
start the snmpd agent manually	<code>sudo /etc/init.d/snmpd start</code>
stop the snmpd agent manually	<code>sudo /etc/init.d/snmpd stop</code>
enable the snmpd agent	<code>insserv -d snmpd</code>
disable the snmpd agent	<code>insserv -r snmpd</code>

The following example shows how to use an SNMP browser on the host site to query the UC-8100 series, which is the SNMP agent. The UC-8100 will respond as follows:

```

debian:~# snmpwalk -v 2c -c public -Cc 192.168.27.115
iso.3.6.1.2.1.1.1.0 = STRING: "Linux Moxa 3.2.0_UC81XX #3 Thu Apr 24 10:38:04 CST 2014
armv7l"
iso.3.6.1.2.1.1.2.0 = OID: iso.3.6.1.4.1.8691.12.8100
iso.3.6.1.2.1.1.3.0 = Timeticks: (201692) 0:33:36.92
iso.3.6.1.2.1.1.4.0 = STRING: "Moxa Inc., Embedded Computing Business. <www.moxa.com>"
iso.3.6.1.2.1.1.5.0 = STRING: "Moxa"
iso.3.6.1.2.1.1.6.0 = STRING: "Fl.4, No.135, Lane 235, Baoquao Rd., Xindian Dist.,
New Taipei City, Taiwan, R.O.C.\""
iso.3.6.1.2.1.1.7.0 = INTEGER: 72
iso.3.6.1.2.1.1.8.0 = Timeticks: (4) 0:00:00.04
iso.3.6.1.2.1.1.9.1.2.1 = OID: iso.3.6.1.6.3.10.3.1.1
iso.3.6.1.2.1.1.9.1.2.2 = OID: iso.3.6.1.6.3.11.3.1.1
iso.3.6.1.2.1.1.9.1.2.3 = OID: iso.3.6.1.6.3.15.2.1.1
iso.3.6.1.2.1.1.9.1.2.4 = OID: iso.3.6.1.6.3.1
iso.3.6.1.2.1.1.9.1.2.5 = OID: iso.3.6.1.2.1.49
iso.3.6.1.2.1.1.9.1.2.6 = OID: iso.3.6.1.2.1.4
iso.3.6.1.2.1.1.9.1.2.7 = OID: iso.3.6.1.2.1.50
iso.3.6.1.2.1.1.9.1.2.8 = OID: iso.3.6.1.6.3.16.2.2.1
iso.3.6.1.2.1.1.9.1.3.1 = STRING: "The SNMP Management Architecture MIB."
iso.3.6.1.2.1.1.9.1.3.2 = STRING: "The MIB for Message Processing and Dispatching."
iso.3.6.1.2.1.1.9.1.3.3 = STRING: "The management information definitions for the SNMP
User-based Security Model."
iso.3.6.1.2.1.1.9.1.3.4 = STRING: "The MIB module for SNMPv2 entities"
iso.3.6.1.2.1.1.9.1.3.5 = STRING: "The MIB module for managing TCP implementations"
iso.3.6.1.2.1.1.9.1.3.6 = STRING: "The MIB module for managing IP and ICMP
implementations"
iso.3.6.1.2.1.1.9.1.3.7 = STRING: "The MIB module for managing UDP implementations"
iso.3.6.1.2.1.1.9.1.3.8 = STRING: "View-based Access Control Model for SNMP."
iso.3.6.1.2.1.1.9.1.4.1 = Timeticks: (3) 0:00:00.03
iso.3.6.1.2.1.1.9.1.4.2 = Timeticks: (3) 0:00:00.03
iso.3.6.1.2.1.1.9.1.4.3 = Timeticks: (3) 0:00:00.03
iso.3.6.1.2.1.1.9.1.4.4 = Timeticks: (4) 0:00:00.04
iso.3.6.1.2.1.1.9.1.4.5 = Timeticks: (4) 0:00:00.04
iso.3.6.1.2.1.1.9.1.4.6 = Timeticks: (4) 0:00:00.04
iso.3.6.1.2.1.1.9.1.4.7 = Timeticks: (4) 0:00:00.04
iso.3.6.1.2.1.1.9.1.4.8 = Timeticks: (4) 0:00:00.04
iso.3.6.1.2.1.25.1.1.0 = Timeticks: (2866708) 7:57:47.08
iso.3.6.1.2.1.25.1.2.0 = Hex-STRING: 07 DE 05 0D 0A 12 15 00 2B 00 00
iso.3.6.1.2.1.25.1.3.0 = INTEGER: 1536
iso.3.6.1.2.1.25.1.4.0 = STRING: "mac=00:90:e8:00:00:07 sd=0 ver=1.0.0S11
console=ttyO0,115200n8 root=/dev/mmcblk0p2 rootfstype=ext4 rootwait"
iso.3.6.1.2.1.25.1.5.0 = Gauge32: 1
iso.3.6.1.2.1.25.1.6.0 = Gauge32: 58
iso.3.6.1.2.1.25.1.7.0 = INTEGER: 0
iso.3.6.1.2.1.25.1.7.0 = No more variables left in this MIB View (It is past the end
of the MIB tree)

```

NOTE Click the following links for more information on MIB II:

<http://www.faqs.org/rfcs/rfc1213.html>

<https://wiki.debian.org/SNMP>

OpenVPN

The OpenVPN package is installed on the computer but disabled by default. Use the `insserv -d openvpn` command to enable OpenVPN on next bootup. You can also use `/etc/init.d/openvpn start` to enable OpenVPN service immediately.

OpenVPN supports user/pass, pre-shared key, certificates, etc., to authenticate users. To begin with, check to make sure that the system has a virtual device `/dev/net/tun`.

An Ethernet bridge is used to connect different Ethernet networks together. The Ethernets are bundled into one bigger, "logical" Ethernet. Each Ethernet corresponds to one physical interface (or port) that is connected to the bridge. Type the following command to load driver "tun".

```
# modprobe tun
```

On each OpenVPN machine, you should generate a working directory, such as `/etc/openvpn`, where script files and key files reside. Once established, all operations will be performed in that directory.

The OpenVPN daemon is installed but disabled by default.

Enable openvpn manually	<code>sudo /etc/init.d/openvpn start</code>
Disable openvpn manually	<code>sudo /etc/init.d/openvpn stop</code>
Enable openvpn	<code>insserv -d openvpn</code>
Disable openvpn	<code>insserv -r openvpn</code>

Static-Key VPN

Run the following command in the `/etc/openvpn` directory to generate a static key:

```
moxa@moxa:/etc/openvpn$ sudo openvpn --genkey --secret static.key
```

Copy this static key to the clients `/etc/openvpn` directory using a secure channel like scp or sftp.

On the server, create a new `/etc/openvpn/tun0.conf` file and add the following:

```
dev tun0
ifconfig 10.9.8.1 10.9.8.2
secret /etc/openvpn/static.key
```

This is where 10.9.8.x is your VPN subnetwork, 10.9.8.1 is the IP of the server, and 10.9.8.2 the IP of the client.

On the client, copy `/etc/openvpn/static.key` from the server and create a new `/etc/openvpn/tun0.conf` file, and then add the following to the file:

```
remote your-server.org
dev tun0
ifconfig 10.9.8.2 10.9.8.1
secret /etc/openvpn/static.key
```

Start OpenVPN using the following command:

```
moxa@moxa:/etc/openvpn$ sudo openvpn --config /etc/openvpn/tun0.conf --verb 6 //
verbose output.
```

**ATTENTION**

When using an OpenVPN-related application, you need to create a firewall policy.

On the server's firewall, open UDP 1194 (default port). If you are using shorewall on both devices, add a new VPN zone to represent tun0 and create a default policy for it. This means adding something to the following files in /etc/shorewall:

```
zone
interfaces
policy
```

Bear in mind that 90% of all connection problems encountered by new OpenVPN users are firewall-related.

NOTE Click the following links for more information on OpenVPN:

<https://wiki.debian.org/OpenVPN>

<http://openvpn.net/>

Package Management

In this section, we explain how you can quickly learn to install, remove, update, and search for software packages using the `apt-get` and `apt-cache` commands from the command line. Some useful commands that will help you handle package management in Debian/Ubuntu based systems are provided in this section.

apt-get

The `apt-get` utility is a powerful and free command line package management program that is used with Ubuntu's APT (Advanced Packaging Tool) library to install new software packages, remove existing software packages, upgrade existing software packages, and even upgrade the entire operating system.

apt-cache

The `apt-cache` command line tool is used to search for apt software package cache. That is, the tool is used to search for software packages, collect package information, and search for which available packages are ready for installation on Debian or Ubuntu based systems.

List All Available Packages

Use the following command to list all available packages.

```
moxa@Moxa:~$ sudo apt-cache pkgnames
```

Find Package Name and Software Description

To find the package name and description, use the "search" flag. Using "search" with `apt-cache` will display a list of matched packages with short descriptions. For example, if you would like to find the description of package "vim", use the following command:

```
moxa@Moxa:~$ sudo apt-cache search vim
```

To find and list all packages starting with "vim", use the following command:

```
moxa@Moxa:~$ sudo apt-cache pkgnames vim
```

Check Package Information

To get more detailed package information (e.g., version number, check sums, size, installed size, and category) along with a short description of the package, use the **show** sub command as illustrated below:

```
moxa@Moxa:~$ sudo apt-cache show vim
```

Check Dependencies for Specific Packages

Use the **showpkg** sub command to check the dependencies for particular software packages, and whether those dependent packages are installed or not. For example, use the **showpkg** command along with the package-name as follows:

```
moxa@Moxa:~$ sudo apt-cache showpkg vim
```

Check Cache Statistics

The **stats** sub command displays the overall statistics of the cache. For example, the following command will show the complete package information of all packages found in the cache:

```
moxa@Moxa:~$ sudo apt-cache stats
```

Update System Packages

The **update** command is used to resynchronize the package index files with their sources specified in the **/etc/apt/sources.list** file. The updated commands will fetch the packages from their locations and update the packages to the newer version.

```
moxa@Moxa:~$ sudo apt-get update
```

Install or Upgrade Specific Packages

Use the **install** sub command to install or upgrade one or more packages.

```
moxa@Moxa:~$ sudo apt-get install vim
```

Upgrade All Software Packages

The **upgrade** command is used to upgrade all software packages currently installed on the system.

```
moxa@Moxa:~$ sudo apt-get upgrade
```

Install Multiple Packages

You can add more than one package name along with the command in order to install multiple packages at the same time. For example, the following command will install the packages **vim** and **goaccess**.

```
moxa@Moxa:~$ sudo apt-get install vim goaccess
```

Install Packages without Upgrading

Use the **--no-upgrade** sub command to prevent the installed packages from being upgraded.

```
moxa@Moxa:~$ sudo apt-get install packageName --no-upgrade
```

Upgrade Specific Packages

Use the `--only-upgrade` sub command to NOT install new packages, but only upgrade already installed packages.

```
moxa@Moxa:~$ sudo apt-get install packageName --only-upgrade
```

Install Specific Package Version

To install a specific version of a package, use "=" with the package name and append the desired version.

```
moxa@Moxa:~$ sudo apt-get install wget=1.13.4-3+deb7u2
```

Remove Packages Without Configuration

To uninstall software packages without removing their configuration files (for reusing the same configuration later), use the `remove` command:

```
moxa@Moxa:~$ sudo apt-get remove wget
```

Completely Remove Packages

To remove the software packages and their configuration files, use the `purge` sub command:

```
moxa@Moxa:~$ sudo apt-get remove --purge wget
```

Clean Up Disk Space

Use the `clean` command to free up the disk space by cleaning retrieved (downloaded) `.deb` files (packages) from the local repository.

```
moxa@Moxa:~$ sudo apt-get clean
```

Download Only Source Code of Package

To download only the source code of a particular package, use the option "`--download-only source`" with "package-name", as shown here:

```
moxa@Moxa:~$ sudo apt-get --download-only source wget
```

Download and Unpack a Package

To download and unpack the source code of a package to a specific directory, type the following command:

```
moxa@Moxa:~$ sudo apt-get source wget
```

Download, Unpack, and Compile a Package

You can also download, unpack, and compile the source code at the same time, using the "`--compile`" option, as shown below:

```
moxa@Moxa:~$ sudo apt-get --compile source wget
```

Download a Package Without Installing

Use the `download` sub command to download any given package without installing it. For example, the following command will only download the `nethogs` package to the current working directory.

```
moxa@Moxa:~$ sudo apt-get download wget
```

Check the Package Change Log

The `changelog` sub command is used to download the change log for a package and show the version information for the package.

```
moxa@Moxa:~$ sudo apt-get changelog wget
```

Check Broken Dependencies

The `check` command is a diagnostic tool used to update a package cache and check for broken dependencies.

```
moxa@Moxa:~$ sudo apt-get check
```

Search and Build Dependencies

The `build-dep` command searches the local repositories in the system and installs the build dependencies for a package. If the package does not exist in the local repository, it will return an error code.

```
moxa@Moxa:~$ sudo apt-get build-dep wget
```

Auto Clean Apt-Get Cache

The `autoclean` command deletes all `.deb` files from `/var/cache/apt/archives` to free up a significant volume of disk space.

```
moxa@Moxa:~$ sudo apt-get autoclean
```

Auto Remove Installed Packages

The `autoremove` sub command is used to automatically remove packages that were installed to satisfy dependencies on other packages, but are no longer required. For example, the following command will remove the package `wget` and all dependent packages:

```
moxa@Moxa:~$ sudo apt-get autoremove wget
```

Programmer's Guide

In this chapter, we briefly introduce the tool-chain and teach you how to program the UC-8100-LX. The programming example package can be downloaded from Moxa's website.

The following topics are covered in this chapter:

- ❑ **Linux Tool Chain Introduction**
 - Native Compilation
 - Cross Compilation
 - Cross Compiling Applications and Libraries
- ❑ **Test Program—Developing Hello.c**
 - Compiling Hello.c Using Native Compilation
 - Compiling Hello.c Using Cross Compilation
- ❑ **Makefile Example**
- ❑ **Modbus**
- ❑ **RTC (Real Time Clock)**
- ❑ **WDT (Watchdog Timer)**
- ❑ **Cryptographic Hardware Accelerator**
- ❑ **Diagnostic LED**
 - Turning on the LEDs
 - Turning off the LEDs
 - Blinking the LEDs
- ❑ **Using cell_mgmt**
 - Manual Page
 - Automatic Dial-Up
 - Cellular Module
 - cell_mgmt at ['AT_COMMAND']
 - SIM Card
 - Switching Between Carrier Frequency Bands
 - GPS
 - Cellular Management

Linux Tool Chain Introduction

Linux Tool-Chain contains the necessary libraries and compilers for developing your programs. The UC-8100 series supports both native and cross-compiling. Native compiling is more straightforward since all the coding and compilation can be done directly on the UC-8100-LX, but since you will be constrained by the UC-8100's ARM CPU resources, the compilation speed is slower. On the other hand, cross compiling can be done on any Linux machine with the correct tool-chain, and the compilation speed is much faster.

Native Compilation

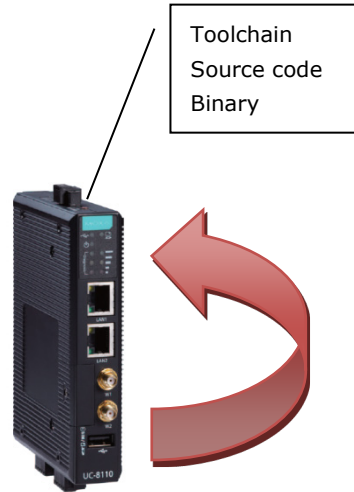

Follow these steps to update the package menu.

1. Make sure network connection is available.
2. Use **apt-get update** to update the Debian package list.

```
moxa@moxa:~$ sudo apt-get update
```

3. Install the native compiler and necessary packages

```
moxa@moxa:~$ sudo apt-get install gcc build-essential flex bison automake
```

Cross Compilation

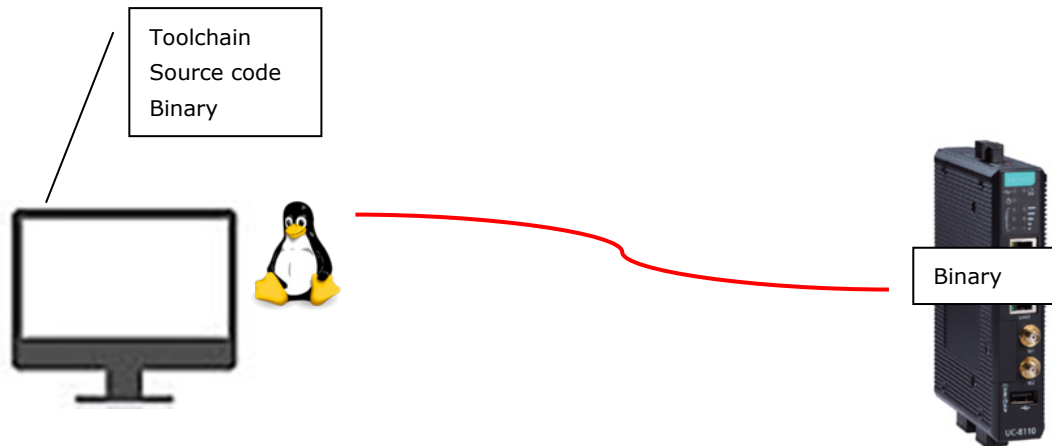

To ensure that an application will be able to run correctly when installed on the UC-8100-LX, you must ensure that it is compiled and linked to the same libraries that will be present on the UC-8100-LX computer. This is particularly true when the RISC Cortex processor architecture of the UC-8100 differs from the CISC x86 processor architecture of the host system, but it is also true if the processor architecture is the same.

The host tool chain that comes with the UC-8100-LX contains a suite of cross compilers and other tools, as well as the libraries and headers that are necessary to compile applications for the UC-8100. The host environment must be running Linux to install the UC-8100 GNU Tool Chain. We have confirmed that the following Linux distributions can be used to install the tool chain:

Debian 8/9 on 32/64-bit platforms.

The Tool Chain will need about 300 MB of hard disk space on your PC. To install the tool-chain, download the tool-chain file from Moxa's website.

After you **untar** the package, run the install script and follow the on-screen instructions.

```
user@Linux: /home#sh arm-linux-gnueabihf_4.9_Build_i386_16062000.sh

Welcome to MOXA ARM Linux platform toolchain installer.
This toolchain built with arm-linux-gnueabihf compiler v4.7.3 and glibc v2.15.
Any problem please contact support@moxa.com

Press the number:
1.Install Linux cross compiler tool.
2.Uninstall Linux cross compiler tool.
3.Exit or CTRL+C
1
...
...

-----
arm-linux-gnueabihf install complete
Please export these environment variables before using toolchain:
export PATH=$PATH: /usr/local/arm-linux-gnueabihf-4.9/usr/bin/
```

Wait for a few minutes while the Tool Chain is installed automatically on your Linux PC. Once the host environment has been installed, add the directory `/usr/local/arm-linux-gnueabihf-4.9/bin` to your path and the directory `/usr/local/arm-linux-gnueabihf-4.9/man` to your manual path.

You can do this temporarily for the current login session by issuing the following commands:

```
#export PATH="/usr/local/arm-linux-gnueabihf-4.9/bin:$PATH"
#export MANPATH="/usr/local/arm-linux-gnueabihf-4.9/man:$MANPATH"
```

Alternatively, you can add the same commands to `$HOME/.bash_profile` to cause it to take effect for all login sessions initiated by this user.

NOTE The toolchain will be installed at `/usr/local/arm-linux-gnueabihf-4.9/`. This means that the original content in this path will be overwritten. If you have an old version of the arm-linux toolchain installed, you will need to rename the original folder before installing the new one.

Cross Compiling Applications and Libraries

To compile a simple C application, use the cross compiler instead of the regular compiler:

```
#arm-linux-gnueabi-gcc -o example -Wall -g -O2 example.c
#arm-linux-gnueabi-strip -s example
#arm-linux-gnueabi-gcc -ggdb -o example-debug example.c
```

Test Program—Developing Hello.c

In this section, we use the standard “Hello” programming example to illustrate how to develop a program for the UC-8100-LX.

```
#include <stdio.h>
int main()
{
    printf("Hello World\n");
    return 0;
}
```

The following compiler tools are provided:

Tool	Description
ar	Manage archives (static libraries)
as	Assembler
c++, g++	C++ compiler
cpp	C preprocessor
gcc	C compiler
ld	Linker
nm	Lists symbols from object files
objcopy	Copies and translates object files
objdump	Displays information about object files
ranlib	Generates indexes to archives (static libraries)
readelf	Displays information about ELF files
size	Lists object file section sizes
strings	Prints strings of printable characters from files (usually object files)
strip	Removes symbols and sections from object files (usually debugging information)

Compiling Hello.c Using Native Compilation

Follow these steps for native compilation.

```
apt-get install build-essential
sudo gcc -o hello-release hello.c
sudo strip -s hello-release
```

After compiling the program, use the following command to execute the program:

```
moxa@moxa:~$ ./hello-release
Hello World
```

Compiling Hello.c Using Cross Compilation

Follow these steps for cross compilation.

1. Connect the UC-8100-LX series to a Linux PC.
2. Install Tool Chain (GNU Cross Compiler & glibc).
3. Set the cross compiler and glibc environment variables.
4. Code and compile the program.
5. Download the program to the UC-8100 series via SFTP, NFS, SCP, or RSYNC.
6. Debug the program
 - If bugs are found, return to Step 4.
 - If no bugs are found, continue with Step 7
7. Back up the user directory (distribute the program to additional UC-8100 series units if needed).

The UC-8100 product page contains several example programs. Here we use **Hello.c** as an example to show you how to compile and run your applications.

To compile the program, go to the **Hello** subdirectory in the sample programs that you downloaded from the product page and use the following commands:

```
#cd ../example/hello
#make
```

You should receive the following response:

```
[root@localhost hello]# make
arm-linux-gnueabi-gcc -o hello-release hello.c
arm-linux-gnueabi-strip -s hello-release
```

hello-release—an ARM platform execution file (created specifically to run on the UC-8100 series)

Uploading and Running the “Hello” Program

The program can be uploaded via SFTP, NFS, SCP, or RSYNC.

Use the following command to upload **hello-release** to the UC-8100 series via SFTP.

From the PC, type:

```
#ftp 192.168.3.127
```

Use the **put** command to initiate the file transfer.

```
sftp> put hello-release
Uploading hello-release to /home/moxa/hello-release
hello-release
```

From the UC-8100-LX, type:

```
# chmod +x hello-release
# ./hello-release
```

The word **Hello** will be printed on the screen.

```
moxa@moxa:~$ ./hello-release
Hello World
```

Makefile Example

The following **makefile** script is copied from the Hello example on the UC-8100-LX's example package and used for cross compilation of code.

```
CC = arm-linux-gnueabi-gcc
CPP = arm-linux-gnueabi-g++
SOURCES = hello.c
OBJS = $(SOURCES:.c=.o)
all:    hello
hello:  $(OBJS)
        $(CC) -o $@ $^ $(LDFLAGS) $(LIBS)
clean:
        rm -f $(OBJS) hello core *.gdb
```

For native compilation make the following changes:

```
CC = gcc
CPP = g++
```

Modbus

The Modbus protocol is a messaging structure used to establish master-slave/client-server communication between intelligent devices. It is a de facto standard, truly open, and the most widely used network protocol in industrial manufacturing environments. It has been implemented by hundreds of vendors on thousands of different devices to transfer discrete/analog I/O and register data between control devices.

We use libmodbus as our modbus package. Download the source and example code from the following link.

<https://github.com/downloads/stephane/libmodbus/libmodbus-3.0.3.tar.gz>

NOTE Click the following link for more information about libmodbus:
<http://libmodbus.org/>

RTC (Real Time Clock)

The device node is located at **/dev/rtc0**. The UC-8100-LX series supports Linux standard simple RTC control. You must **include** `<linux/rtc.h>` in your program to use the following functions.

Function	RTC_RD_TIME
Description	Reads time information from the RTC; returns the value of argument 3.
Usage	<code>struct rtc_time rtc_tm;</code> <code>ioctl(fd, RTC_RD_TIME, &rtc_tm);</code>
Function	RTC_SET_TIME
Description	Sets the RTC time. Argument 3 will be passed to the RTC.
Usage	<code>struct rtc_time rtc_tm;</code> <code>ioctl(fd, RTC_SET_TIME, &rtc_tm);</code>
Function	RTC_ALM_SET
Description	Sets the alarm time.
Usage	<code>struct rtc_time rtc_tm;</code> <code>ioctl(fd, RTC_ALM_SET, &rtc_tm);</code>
Function	RTC_ALM_READ
Description	Reads the alarm time.
Usage	<code>struct rtc_time rtc_tm;</code> <code>ioctl(fd, RTC_ALM_READ, &rtc_tm);</code>

Function	RTC_IRQP_SET
Description	Sets the IRQ rate
Usage	<pre>unsigned long tmp = 2; int ioctl(fd, RTC_IRQP_SET, tmp); value : {2, 4, 8, 16, 32, 64}Hz</pre>
Function	RTC_IRQP_READ
Description	Reads the IRQ rate.
Usage	<pre>unsigned long tmp; int ioctl(fd, RTC_IRQP_READ, &tmp);</pre>
Function	RTC_ALM_SET
Description	Sets the alarm time.
Usage	<pre>struct rtc_time rtc_tm; ioctl(fd, RTC_ALM_SET, &rtc_tm);</pre>
Function	RTC_PIE_ON
Description	Periodic int. enable on
Usage	<pre>int ioctl(fd, RTC_PIE_ON, 0);</pre>
Function	RTC_PIE_OFF
Description	Periodic int. enable off.
Usage	<pre>int ioctl(fd, RTC_PIE_OFF, 0);</pre>
Function	RTC_UIE_ON
Description	Update int. enable on.
Usage	<pre>int ioctl(fd, RTC_UIE_ON, 0);</pre>
Function	RTC_UIE_OFF
Description	Update int. enable off
Usage	<pre>int ioctl(fd, RTC_UIE_OFF, 0);</pre>
Function	RTC_AIE_ON
Description	Periodic int. enable on
Usage	<pre>int ioctl (fd, RTC_AIE_ON, 0);</pre>
Function	RTC_AIE_OFF
Description	Alarm int. enable off
Usage	<pre>int ioctl (fd, RTC_AIE_OFF, 0);</pre>

Refer to the examples in the example package to see how to use these functions

WDT (Watchdog Timer)

The WDT works like a watch dog function. You can enable it or disable it. When the WDT is enabled, but the application does not acknowledge it, the system will reboot. You can set the acknowledge time from a minimum of 1 sec to a maximum of 1 day. The default timer is 60seconds and the NO WAY OUT is enabled by default; there is no way to disable the watchdog once it has been started. For this reason, if the watchdog daemon crashes, the system will reboot after the timeout has passed.

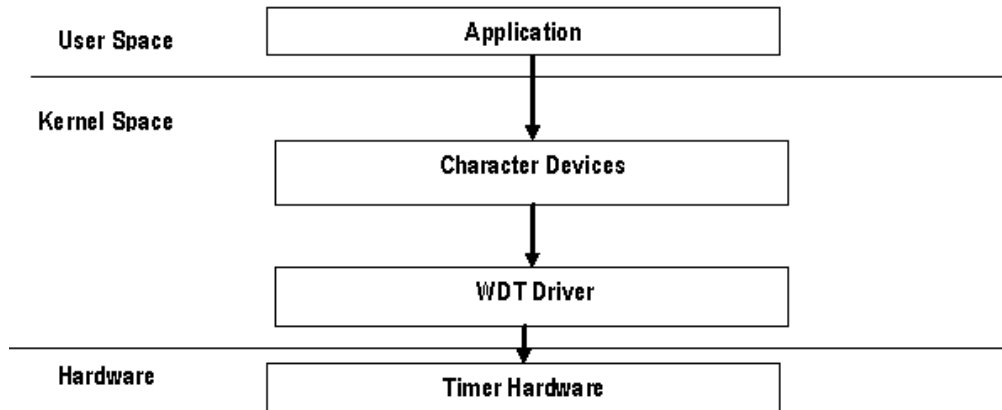

Function	WDIOC_KEEPALIVE
Description	Writes to the watchdog device to keep the watchdog alive.
Usage	<code>int ioctl(fd, WDIOC_KEEPALIVE, 0);</code>
Function	WDIOC_SETTIMEOUT
Description	Modifies the watchdog timeout Min: 1second. Max: 1day; Default: 60seconds
Usage	<code>int timeout = 60;</code> <code>ioctl(fd, WDIOC_SETTIMEOUT, &timeout);</code>
Function	WDIOC_GETTIMEOUT
Description	Queries the current timeout
Usage	<code>int timeout;</code> <code>ioctl(fd, WDIOC_GETTIMEOUT, &timeout);</code>
Function	WDIOC_GETSTATUS
Description	Asks for the current status
Usage	<code>int flags;</code> <code>ioctl(fd, WDIOC_GETSTATUS, &flags);</code>
Function	WDIOC_GETBOOTSTATUS
Description	Asks for the status at the last reboot
Usage	<code>int flags;</code> <code>ioctl(fd, WDIOC_GETBOOTSTATUS, &flags);</code>
Function	WDIOC_GETSUPPORT
Description	Asks what the device can do
Usage	<code>struct watchdog_info ident;</code> <code>ioctl(fd, WDIOC_GETSUPPORT, &ident);</code>

Cryptographic Hardware Accelerator

The purpose of cryptographic hardware accelerator is to load off the intensive encryption/decryption and compression/decompression tasks from CPU. You can use the cryptographic hardware accelerator when your application needs to do cryptographic calculations. To use it, you need to make sure that the cryptodev driver is loaded.

Moxa provides examples to show how to use this cryptographic accelerator. Go to the example/cryptodev/ folder for more information.

Diagnostic LED

A diagnostic LEDs library named libmx_led.so is provided to show the status of device, but we also provide a diagnostic LED API to let your own application use these LEDs.

Turning on the LEDs

Return code: 0 for OK; a nonzero number indicates an error.

Turn on GREEN LED	onoff_led ("GREEN", 1);
Turn on YELLOW LED	onoff_led ("YELLOW", 1);
Turn on RED LED	onoff_led ("RED", 1);
Turn on all LED	on_all_led();

Turning off the LEDs

Return code: 0 for OK; a nonzero number indicates an error.

Turn off GREEN LED	onoff_led ("GREEN", 0);
Turn off YELLOW LED	onoff_led ("YELLOW", 0);
Turn off RED LED	onoff_led ("RED", 0);
Turn off ALL LED	off_all_led();

Blinking the LEDs

Return code: 0 for OK; a nonzero number indicates an error.

Blink GREEN LED	blink_led ("GREEN");
Blink YELLOW LED	blink_led ("YELLOW");
Blink RED LED	blink_led ("RED");
Blink all LED	blink_all_led();



ATTENTION

Be careful when using the diagnostic LEDs

Do not use the diagnostic function while own application is controlling the LEDs.

Using cell_mgmt

The **cell_mgmt** utility is used to manage the cellular module in the UC-8100-LX.

Manual Page

```
moxa@moxa:~$ sudo cell_mgmt help
Usage:
  /usr/sbin/cell_mgmt [-i <module id>] [-s <slot id>] <OPTIONS>

OPTIONS
  -i <module id>
      Module identifier, start from 0 and default to 0.
  -s <slot id>
      Slot identifier, start from 1 and default value depends
      on module interface.
      example: module 0 may in slot 2
modules
      Shows module numbers supported.
slot
      Shows module slot id
interface [interface id]
      Switching and checking module interface(s)
start [OPTIONS]
      Start network.

      OPTIONS:
      APN - Access point name
      PIN - PIN code
      Phone - Phone number (especially for AT based modules)
      Username
      Password

      example:
      cell_mgmt start
      cell_mgmt start APN=internet
      cell_mgmt start APN=internet PIN=0000
      cell_mgmt start APN=internet PIN=0000 Phone=*99#

stop
      Stop network.
Restart
      Restart network.
power_on
      Power ON.
power_off
      Power OFF.
power_cycle
      Power cycle the module slot.
switch_sim <1|2>
      Switch SIM slot.
gps_on
      GPS ON.
gps_off
      GPS OFF.
```

```
attach_status
    Query network registration status.
status
    Query network connection status.
signal
    Get signal strength.
at <'AT_COMMAND'>
    Input AT Command.
    Must use SINGLE QUOTATION to enclose AT Command.
sim_status
    Query sim card status.
unlock_pin <PIN>
    Unlock PIN code and save to configuration file.
pin_retries
    Get PIN code retry remain times.
pin_protection <enable|disable> <current PIN>
    Set PIN protection in the UIM.
set_flight_mode <0|1>
    Set module into flight mode (1) or online mode (0).
get_profiles
    Get profile list.
    format:
        <id>,<APN>,<PDP Type>
    example:
        1,internet,IPV4V6
set_profile <id> [APN [PDP Type]]
    Update PDP profile.
set_apn <APN>
    Set APN to configuration file.
check_carrier
    Check current carrier.
switch_carrier <Verizon|ATT|Sprint|Generic>
    Switching between US carrier frequency bands.
m_info
    Module/SIM information.
module_info
    Module information.
module_ids
    Get device IDs (ex: IMEI and/or ESN).
iccid
    Get SIM card ID
imsi
    Get IMSI (International Mobile Subscriber Identity).
location_info
    Get cell location information.
operator
    Telecommunication operator.
vzwauto
    Verizon Private Network auto dialup.
version
    Cellular management version.
```

Automatic Dial-Up

The automatic dial-up function will automatically set the DNS and default gateway of the UC-8100-LX.

IMPORTANT Before using the cellular gateway settings, remove the default gateway configuration that you might have set in your UC-8100-LX.

`cell_mgmt start`

Starts a network connection using the cellular module of the UC-8100-LX.

When you run the `cell_mgmt start` command, the APN, Username, Password, and PIN details are written to the configuration file `/etc/qmi-network.conf`. This information is then used when you run the command without specifying the command options.

Syntax:

```
cell_mgmt start APN=[APN] Username=[user] Password=[pass] PIN=[pin_code]
```

```
moxa@moxa:~$ sudo /sbin/cell_mgmt start APN="internet"
[sudo] password for moxa:
PIN code:Verified
Starting network with '/usr/bin/qmicli -d /dev/cdc-wdm0 --wds-start-network=internet --client-no-release-cid --device-open-net=net-802-3|net-no-qos-header -p'...
Saving state... (CID: 8)
Saving state... (PDH: 1205387176)
Network started successfully
```

`cell_mgmt stop`

Stops/disables the network connection on the cellular module of the UC-8100-LX.

```
moxa@moxa:~$ sudo /sbin/cell_mgmt stop
Stopping network with '/usr/bin/qmicli -d /dev/cdc-wdm0 --wds-stop-network=1205387176 --client-cid=8 -p'...
Network stopped successfully
Clearing state...
```

`cell_mgmt restart`

Restarts the network connection on the cellular module of the UC-8100-LX.

```
moxa@moxa:~$ sudo /sbin/cell_mgmt restart
Network already stopped
Clearing state...
PIN code:Verified
Starting network with '/usr/bin/qmicli -d /dev/cdc-wdm0 --wds-start-network=internet --client-no-release-cid --device-open-net=net-802-3|net-no-qos-header -p'...
Saving state... (CID: 8)
Saving state... (PDH: 1205640384)
Network started successfully
```

Cellular Module

`cell_mgmt power_on`

Turns on the power to the cellular module in the UC-8100-LX.

```
moxa@moxa:~$ sudo /sbin/cell_mgmt power_on
```

`cell_mgmt power_off`

Turns off the power to the cellular module in the UC-8100-LX.

```
moxa@moxa:~$ sudo /sbin/cell_mgmt power_off
```

`cell_mgmt status`

Provides information on the status of the network connection.

```
moxa@moxa:~$ sudo /sbin/cell_mgmt status
Status: disconnected
```

`cell_mgmt signal`

Provides the cellular signal strength.

```
moxa@moxa:~$ sudo /sbin/cell_mgmt signal
Signal strength: -84 dbm
```

`cell_mgmt m_info`

Provides information on the cellular module (AT Port, GPS Port, Eth Port, and Module Name).

```
moxa@moxa:~$ sudo cell_mgmt m_info
Module=MC7354
WWAN_node=wwan0
AT_port=/dev/ttyUSB2
GPS_port=/dev/ttyUSB1
```

`cell_mgmt operator`

Provides information on the cellular service provider.

```
moxa@moxa:~$ sudo cell_mgmt operator
Chunghwa Telecom
```

`cell_mgmt interface`

Used to switch the module slot and check the status after the switch.

```
moxa@moxa:~$ sudo cell_mgmt interface 0
set interface=0
moxa@moxa:~$
moxa@moxa:~$ sudo cell_mgmt interface
[0] wwan0 <Current>
```

cell_mgmt at ['AT_COMMAND']

Used to input an `at` command. For example, use the `at` command to run `AT+CSQ`, as follows:

```
moxa@moxa:~$ sudo /sbin/cell_mgmt at 'AT+CSQ\r\n'
please wait...

--- AT COMMAND: AT+CSQ
---
ATE0

OK

OK

+CSQ: 13,99

OK
```

You can use the following table to interpret the response to the command "AT+CSQ".

Value	RSSI (dBm)	Condition	Value	RSSI (dBm)	Condition
0	-113 or less	Marginal	17	-79	Good
1	-111	Marginal	18	-77	Good
2	-109	Marginal	19	-75	Good
3	-107	Marginal	20	-73	Excellent
4	-105	Marginal	21	-71	Excellent
5	-103	Marginal	22	-69	Excellent
6	-101	Marginal	23	-67	Excellent
7	-99	Marginal	24	-65	Excellent
8	-97	Marginal	25	-63	Excellent
9	-95	Marginal	26	-61	Excellent
10	-93	OK	27	-59	Excellent
11	-91	OK	28	-57	Excellent
12	-89	OK	29	-55	Excellent
13	-87	OK	30	-53	Excellent
14	-85	OK	31	-51 or higher	Excellent
15	-83	Good	99	Not known or not detectable	
16	-81	Good			

SIM Card

`cell_mgmt sim_status`

Provides information on the SIM card status.

```
moxa@moxa:~$ sudo /sbin/cell_mgmt sim_status
[/dev/cdc-wdm0] UIM state retrieved:
State: 'initialization-completed'
```

`cell_mgmt pin_protection [PIN|PIN2] [enable|disable] [current_PIN]`

Enables or disables PIN protection in the UIM.

`enable PIN protection`

```
moxa@moxa:~$ sudo /sbin/cell_mgmt pin_protection PIN enable 0000
[/dev/cdc-wdm0] PIN protection updated
```

`disable PIN protection`

```
moxa@moxa:~$ sudo /sbin/cell_mgmt pin_protection PIN disable 0000
[/dev/cdc-wdm0] PIN protection updated
```

Switching Between Carrier Frequency Bands



IMPORTANT!

Check the version of the cellular management utility using the `cell_mgmt version` command to ensure that it is V1.7.4 or higher. If not, upgrade to the latest firmware available on the Moxa website. If the correct version of the cellular management utility is not used, the carrier switch might not work properly.

`cell_mgmt switch_carrier [Name of the carrier]`

```
moxa@moxa:~$ sudo /sbin/cell_mgmt switch_carrier ATT
-----switch_carrier-----
cmd=AT!GOBISETIMAGEPREF="05.05.16.03", "ATT", "ATT_005.014_000"\r\n
wait for power Off...
Network already stopped
Clearing state...
[ 234.727492] usb 1-1: USB disconnect, device number 2
[ 234.733204] GobiSerial driver ttyUSB0: GobiSerial converter now disconnected from ttyUSB0
[ 234.741905] GobiSerial 1-1:1.0: device disconnected
[ 234.747411] GobiSerial driver ttyUSB1: GobiSerial converter now disconnected from ttyUSB1
[ 234.756098] GobiSerial 1-1:1.2: device disconnected
[ 234.761618] GobiSerial driver ttyUSB2: GobiSerial converter now disconnected from ttyUSB2
[ 234.770275] GobiSerial 1-1:1.3: device disconnected
[ 234.775657] qmi_wwan 1-1:1.8: wwan0: unregister 'qmi_wwan' usb-musb-hdrc.0-1, WWAN/QMI device
wait for power on...
done
```

GPS

Automatically enables or disables GPS, when the module's device node is opened or closed. You can get raw GPS data by just listening on the GPS port: /dev/ttyUSB1.

```
moxa@moxa:~$ sudo cat /dev/ttyUSB1
```

Cellular Management

```
cell_mgmt version
```

Provides the cellular management version.

```
moxa@moxa:~$ sudo /sbin/cell_mgmt version
cell_mgmt
version:1.7
```

A

Extending the Lifetime of the SD Card

In this appendix, we describe how to extend the lifetime of the SD card.

The following topics are covered in this appendix:

□ **Overview**

- SD Flash Types

□ **Tips for Running GNU/Linux on an SD Card**

- Choosing an SLC SD Card
- Using a Larger Capacity SD Card
- Tweaking GNU/Linux to Write to RAM Instead of the SD card
- Setting the SD Card to Read-only Mode

Overview

The UC-8100-LX comes with an SD socket that can provide storage expansion, and you can even store the operating system on the SD card, making it important to choose the best SD card for the UC-8100-LX. Here is some general information about SD cards that are currently available on the market.

SD Flash Types

Single-Level-Cell (SLC)

Single-level-cell (SLC) cards have the simplest operation of all flash type cards, in the sense that there is only one bit per cell, and the firmware does not need to negotiate with the data in different levels and states. SLC cards have a longer lifetime than other flash types.

Multi-Level Cell (MLC)

Multi-level cell (MLC) cards, as the name suggests, can store multiple bits per cell. The primary benefit of MLC flash memory is the lower cost per unit of storage due to the higher data density.

Triple-Level Cell (TLC)

TLC flash (triple level cell flash) is a type of solid-state NAND flash memory that stores three bits of data per cell. TLC flash is less expensive than single-level cell (SLC) and multi-level cell (MLC) solid-state flash memory, and is commonly used in various consumer devices that use solid-state storage.

Comparison Table for Flash Types

Flash type	SLC, Single Level Cell (1 bit)	MLC, Multilevel Cell (2 bits)	TLC, Triple Level Cell (3 bits)
Bits per cell	1	2	3
Program/Erase cycles	Generally 100000 write/erase cycles	Anywhere from 3000 to 15000 write/erase cycles	Anywhere from 1000 to 5000 write/erase cycles
Erase time	Erase time: 1.5-2 ms	Erase time: 2.5-3.5 ms	Erase time: 4-5 ms
Operation scenario	Industrial	Commercial	Commercial

We strongly recommend using SLC SD cards in the UC-8100-LX computer.

Tips for Running GNU/Linux on an SD Card

Choosing an SLC SD Card

We strongly recommend using SLC SD cards in the UC-8100-LX computer, since this type of card will usually last longer than other types of cards.

Using a Larger Capacity SD Card

Using a larger capacity SD card provides more space for reading and writing data, and reduces the chance that the same area of the card will be written over multiple times. Most GNU/Linux distributions for the UC-8100-LX can fit on a 4 GB card, but it is more advisable to use an 8 GB or even a 16 GB card.

Tweaking GNU/Linux to Write to the RAM Instead of the SD card

"tmpfs" is a useful GNU/Linux function. "tmpfs" can be used to write to RAM as if it were an ordinary file system, and is fast, efficient, and easy to use.

tmpfs can write to RAM instead of the local disk (in this case, the SD card). All you need to do is add an entry to the `/etc/fstab` file (to mount the folder you wish to have written to RAM) and reboot (so that each mount is cleanly mounted before services start writing files).

The kernel will do the rest for you by managing the writes to the RAM on this virtual file system. In addition, the kernel will only use the amount of RAM required for writing files, and not the entire size of the mount. If, for example, we add the following line to the `/etc/fstab` file, the kernel will mount `/var/log` to RAM.

```
tmpfs /var/log tmpfs defaults,noatime,nosuid,mode=0755,size=100m 0 0
```

However, it will not use any RAM until the files are written to `/var/log`. When files are written to `/var/log`, the kernel will only save them to RAM. When files are removed from `/var/log`, the RAM used to store the files will be freed up.

This means it only uses the RAM it needs to store the files, making the process very efficient.

You can also specify the total size to allocate for each mount in `/etc/fstab`. In the above example, we set "size=100m" so that `/var/log` can use up to 100 MB of space and no more. This prevents the file system from using up all of the RAM space, which can cause the system to slow down or even crash. By running the `mount` command, we can see in the example above that `/var/log` is mounted as a tmpfs volume to RAM, 100 MB in size.

```
Filesystem      Size  Used Avail Use% Mounted on
tmpfs           100M  596K  100M   1% /var/log
```

GNU/Linux uses a variety of locations to make frequent writes. The following list of entries can be used as a starting point for most distributions.

```
tmpfs /tmp tmpfs defaults,noatime,nosuid,size=100m 0 0
tmpfs /var/tmp tmpfs defaults,noatime,nosuid,size=30m 0 0
tmpfs /var/log tmpfs defaults,noatime,nosuid,mode=0755,size=100m 0 0
tmpfs /var/run tmpfs defaults,noatime,nosuid,mode=0755,size=2m 0 0
tmpfs /var/spool/mqueue tmpfs defaults,noatime,nosuid,mode=0700,gid=12,size=30m 0 0
```

Use "size=" parameter to avoid using up huge amounts of RAM in case something tries to save a huge amount of data. The "noatime" and "nosuid" parameters are also recommended for security and performance, and "mode=" together with "gid=" match the permissions and group of the original file system to what was originally located on the SD card.

The tmpfs function can also handle permissions. As usual, entries in `/etc/fstab` mount over the top of what is on the SD card, as standard Unix/Linux types do. So if for some reason the mounts fail, writes will still work to the SD card.

One additional point to keep in mind is that anything mounted with tmpfs will be lost on a reboot. So, logs in `/var/log` in the example above will be wiped out if the computer is shut down or rebooted. For this reason, do not use tmpfs to save any files that need to be preserved during reboots.

Setting the SD Card to Read-Only Mode

Setting the SD card to read-only mode essentially makes GNU/Linux run in read-only mode, similar to how it works when booting from a live CD. This way, you can avoid writing to the SD card, which in theory will extend its life. However, there are some drawbacks to this strategy.

NOTE Click the following link for more information on minicom:
http://www.gnu.org/software/coreutils/manual/html_node/dd-invocation.html

B

Copying Images from an SD/MicroSD Card (UC-8131-LX, UC-8132-LX, UC-8162-LX, UC-8112-LX, and UC-8112-LX1 Only)

In this appendix, we show you how to copy an image from an SD or MicroSD card.

The following topics are covered in this appendix:

- **Using Win32 Disk Imager**
- **Using the dd command**

Using Win32 Disk Imager

1. Remove the SD or microSD card from the UC-8100 and insert it into another computer.
2. Start Win32 Disk imager and complete the following steps:
 - a. From the **Device** drop-down list, select the drive letter for the SD card (for example, L:\).
 - b. In the **Image File** field, enter the location for the image file. Alternatively, you can click the folder icon to locate the image file (for example, D:\Temp\backup.imp).

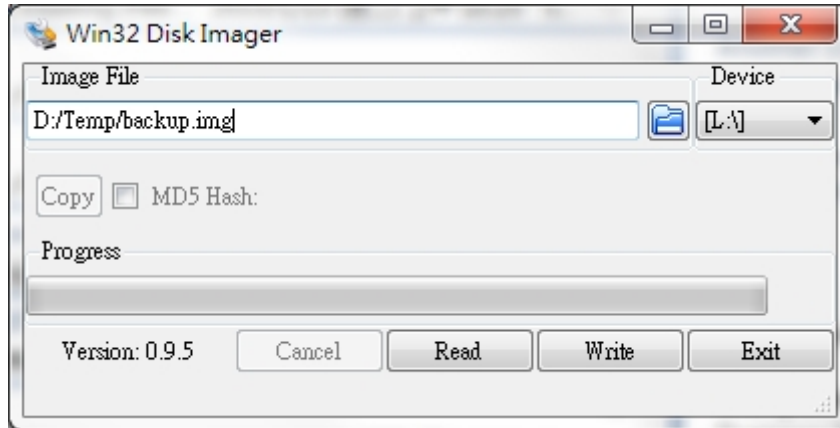

3. Click **Read**.

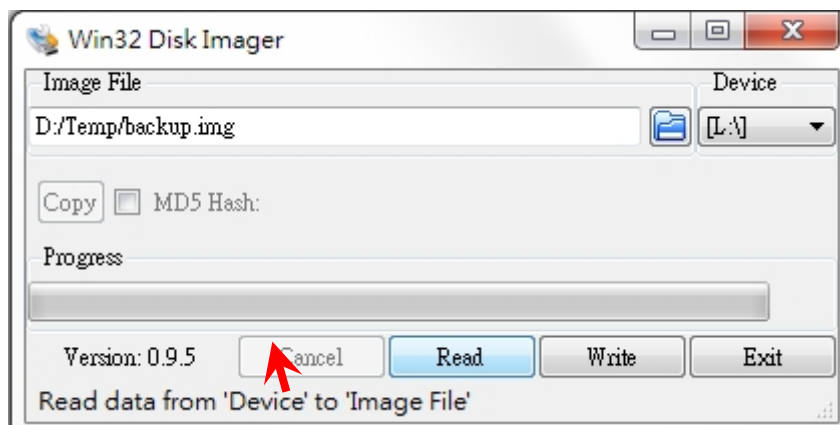

4. Wait until the file copy process is complete. Click **OK** to close the window.

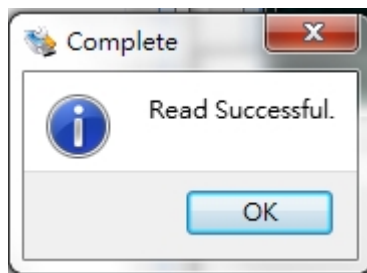
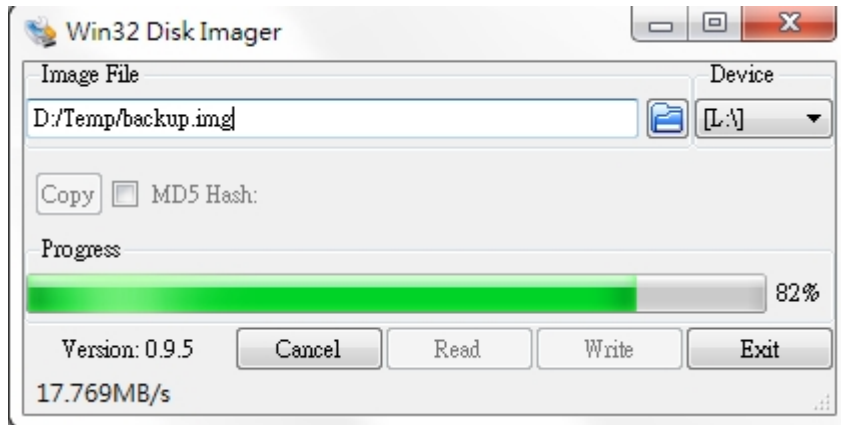

5. Click **Exit** to exit the utility.
6. Eject the SD card from the computer. At this point, you can start using the image.

Using the dd Command

1. Insert the SD or microSD card into another computer.
2. Check the device folder for the SD or microSD card (for example, /dev/sdd) and the directory and file name of the image file (for example, /home/backup.img).
3. Run the `dd` command. For example:

```
#dd if=/dev/sdd of=/home/backup.img bs=512k
```