

MPC-2000 Series Hardware User's Manual

Edition 2.0, February 2017

www.moxa.com/product



© 2017 Moxa Inc. All rights reserved.

MPC-2000 Series Hardware User's Manual

The software described in this manual is furnished under a license agreement and may be used only in accordance with the terms of that agreement.

Copyright Notice

© 2015 Moxa Inc. All rights reserved.

Trademarks

The MOXA logo is a registered trademark of Moxa Inc.
All other trademarks or registered marks in this manual belong to their respective manufacturers.

Disclaimer

Information in this document is subject to change without notice and does not represent a commitment on the part of Moxa.

Moxa provides this document as is, without warranty of any kind, either expressed or implied, including, but not limited to, its particular purpose. Moxa reserves the right to make improvements and/or changes to this manual, or to the products and/or the programs described in this manual, at any time.

Information provided in this manual is intended to be accurate and reliable. However, Moxa assumes no responsibility for its use, or for any infringements on the rights of third parties that may result from its use.

This product might include unintentional technical or typographical errors. Changes are periodically made to the information herein to correct such errors, and these changes are incorporated into new editions of the publication.

Technical Support Contact Information

www.moxa.com/support

Moxa Americas

Toll-free: 1-888-669-2872
Tel: +1-714-528-6777
Fax: +1-714-528-6778

Moxa Europe

Tel: +49-89-3 70 03 99-0
Fax: +49-89-3 70 03 99-99

Moxa India

Tel: +91-80-4172-9088
Fax: +91-80-4132-1045

Moxa China (Shanghai office)

Toll-free: 800-820-5036
Tel: +86-21-5258-9955
Fax: +86-21-5258-5505

Moxa Asia-Pacific

Tel: +886-2-8919-1230
Fax: +886-2-8919-1231

Table of Contents

| | |
|--|------------|
| 1. Introduction | 1-1 |
| Overview | 1-2 |
| Package Checklist | 1-2 |
| Product Features | 1-3 |
| Hardware Specifications | 1-3 |
| MPC-2260 Models..... | 1-3 |
| MPC-2240 Models..... | 1-5 |
| MPC-2190 Models..... | 1-7 |
| Optional Features for the MPC-2000 Series..... | 1-9 |
| Hardware Block Diagram | 1-9 |
| 2. Hardware Overview | 2-1 |
| Appearance..... | 2-2 |
| Front View..... | 2-2 |
| Bottom View..... | 2-2 |
| Dimensions | 2-3 |
| MPC-2260 | 2-3 |
| MPC-2240 | 2-3 |
| MPC-2190 | 2-4 |
| SavvyTouch Display Control Buttons | 2-4 |
| Real Time Clock..... | 2-5 |
| 3. Hardware Installation and Connection | 3-1 |
| Installation and Handling Notes | 3-2 |
| Desktop Mounting | 3-3 |
| Panel Mounting | 3-5 |
| VESA Mounting | 3-5 |
| Wiring Requirements..... | 3-9 |
| Grounding the MPC-2000 Series Panel Computer | 3-9 |
| Powering On the MPC-2000 Series | 3-10 |
| Powering Off the MPC-2000 Series..... | 3-10 |
| SavvyTouch Display Controls | 3-10 |
| Connecting Data Transmission Cables | 3-12 |
| Connecting to the Network | 3-12 |
| Connecting Serial Devices | 3-13 |
| Connecting NMEA 0183 Devices | 3-14 |
| Connecting Speakers or Headphones..... | 3-14 |
| Connecting a PS/2 Keyboard and Mouse | 3-15 |
| Connecting to USB Devices | 3-15 |
| Installing a SATA Storage Drive | 3-16 |
| On the MPC-2260 or MPC-2240..... | 3-16 |
| On the MPC-2190..... | 3-17 |
| 4. Driver Installation and Configure | 4-1 |
| Installing the VGA Driver | 4-2 |
| Setting Display Resolution | 4-5 |
| Installing the Touch Screen Driver | 4-7 |
| Performing Screen Calibration | 4-12 |
| MPC-2260 MxGeneralIo Driver Installation | 4-13 |
| Installing the MxGeneralIo Driver | 4-13 |
| MPC-2260 UART Driver Installation | 4-15 |
| Installing the UART Driver | 4-15 |
| 5. BIOS Setup | 5-1 |
| Starting the BIOS Setup Utility | 5-2 |
| Main Information | 5-3 |
| Advanced Settings | 5-3 |
| Boot Configuration | 5-4 |
| Peripheral Configuration..... | 5-4 |
| HDC Configuration..... | 5-5 |
| Video Configuration | 5-6 |
| Chipset Configuration | 5-8 |
| Hardware Monitor..... | 5-9 |
| Security Settings | 5-9 |
| Set Supervisor Password | 5-10 |
| Power Settings | 5-10 |
| Boot Settings | 5-11 |
| Boot Type..... | 5-11 |
| PXE Boot to LAN..... | 5-11 |
| Add Boot Options | 5-11 |
| USB Boot | 5-11 |

| | |
|---|------------|
| EFI Device First | 5-12 |
| Boot Delay Time | 5-12 |
| Legacy | 5-12 |
| Exit Settings | 5-13 |
| Exit Saving Changes | 5-13 |
| Save Change without Exit | 5-13 |
| Exit Discarding Changes | 5-13 |
| Load Optimal Defaults | 5-13 |
| Load Custom Defaults | 5-13 |
| Save Custom Defaults | 5-14 |
| Discard Changes | 5-14 |
| Upgrading the BIOS | 5-14 |
| A. Regulatory Approval Statement | A-1 |

Introduction

The MPC-2000 series of panel computers features advanced Intel processors—3rd generation Ivy Bridge Core or Celeron—matched with 4 GB of system memory, delivering a reliable, high-performance platform of wide versatility for use in industrial marine environments. With its RS-232/422/485 serial, NMEA 0183, and Gigabit Ethernet LAN ports, the MPC-2000 series supports a wide variety of serial and marine-specific interfaces for high-speed network communications, all with native network redundancy.

The MPC-2000 series comes with a range of standard display enhancements useful in industrial environments (including 0 to 100% full range dimming, 178°/178° wide viewing angles, optional optical bonding, and/or a multi-touch touch screen), as well as Moxa's innovative SavvyTouch display controls.

The MPC-2000 series panel computers are compliant with key industrial marine standards, such as IEC 60945-4, IEC 61174, IEC 61162, DNV2.4, and IACS E10, validating their resilient durability in marine operations. An optional IP65-rated unibody housing provides added protection against the harsh conditions found in marine environments. The MPC-2000 series delivers a rugged, type-approved, high performance and user friendly panel computer perfect for ECDIS navigation systems and other marine IBS applications.

The following topics are covered in this chapter:

- ❑ **Overview**
- ❑ **Package Checklist**
- ❑ **Product Features**
- ❑ **Hardware Specifications**
 - MPC-2260 Models
 - MPC-2240 Models
 - MPC-2190 Models
 - Optional Features for the MPC-2000 Series
- ❑ **Hardware Block Diagram**

Overview

The MPC-2000 series panel computer range is a flexible all-in-one computer and monitor solution, designed for type approved use in industrial marine environments where reliability and durability are key requirements.

The MPC-2000 series features Smart OSD Control, LED backlight technology, full dimming and multi-power. In addition, you can select options such as SSD storage devices, multiple interface configurations, and operating systems.

The models available in the MPC-2000 series are listed below:

- MPC-2260X: 26-inch fanless panel computer with Intel Celeron 1047UE 1.4 GHz processor, NMEA 0183, RS-232/422/485 serial ports, Gigabit Ethernet LAN ports, USB 2.0 ports, dual AC/DC power inputs, and tape bonding
- MPC-2267X: 26-inch fanless panel computer with Intel Core i7 3517UE 1.7 GHz processor, NMEA 0183, RS-232/422/485 serial ports, Gigabit Ethernet LAN ports, USB 2.0 ports, dual AC/DC power inputs, and tape bonding
- MPC-2240X: 24-inch fanless panel computer with Intel Celeron 1047UE 1.4 GHz processor, NMEA 0183, RS-232/422/485 serial ports, Gigabit Ethernet LAN ports, USB 2.0 ports, dual AC/DC power inputs, and tape bonding
- MPC-2240Z: 24-inch fanless panel computer with Intel Celeron 1047UE 1.4 GHz processor, NMEA 0183, RS-232/422/485 serial ports, Gigabit Ethernet LAN ports, USB 2.0 ports, dual AC/DC power inputs, tape bonding, and projected capacitive touchscreen
- MPC-2247X: 24-inch fanless panel computer with Intel Core i7 2610UE 1.5 GHz processor, NMEA 0183, RS-232/422/485 serial ports, Gigabit Ethernet LAN ports, USB 2.0 ports, dual AC/DC power inputs, and tape bonding
- MPC-2190X: 19-inch fanless panel computer with Intel Celeron 1047UE 1.4 GHz processor, NMEA 0183, RS-232/422/485 serial ports, Gigabit Ethernet LAN ports, USB 2.0 ports, dual AC/DC power inputs, and tape bonding
- MPC-2190Z: 19-inch fanless panel computer with Intel Celeron 1047UE 1.4 GHz processor, NMEA 0183, RS-232/422/485 serial ports, Gigabit Ethernet LAN ports, USB 2.0 ports, dual AC/DC power inputs, tape bonding, and projected capacitive touchscreen
- MPC-2197X: 19-inch fanless panel computer with Intel Core i7 3517UE 1.7 GHz processor, NMEA 0183, RS-232/422/485 serial ports, Gigabit Ethernet LAN ports, USB 2.0 ports, dual AC/DC power inputs, and tape bonding

Package Checklist

The MPC-2000 series package is shipped with the following items:

- 1 MPC-2000 series panel computer
- 2 keys for the removable storage trays
- 1 terminal block for DC power input
- 4 5-pin Euroblock terminals for NMEA 0183 v2 interfaces
- Documentation and driver DVD
- Quick installation guide (printed)
- Warranty card

Optional accessories are also available upon request:

- Desktop mounting kit
- Wall mounting clamps
- VESA mounting kit

NOTE Please notify your sales representative if any of the above items are missing or damaged.

Product Features

- 19-inch, 24-inch, or 26-inch display screen
- Color calibration for ECDIS compliance
- Fanless design
- SavvyTouch display controls
- 3rd Generation Intel® Core™ (Default: Celeron® 1047UE, 1.40 GHz with Intel® HD Graphics)
- Built-in NMEA 0183 and software selectable RS-232/422/485 interfaces
- Dual AC/DC power supply units

Hardware Specifications

MPC-2260 Models

Computer

CPU: Intel Celeron® Processor 1047UE (2M Cache, 1.40GHz)

OS: Windows 7 Professional, Windows XP Embedded, Windows Embedded Standard 7, Windows XP SP3

System Chipset: Intel HM65

System Memory: 8 GB capacity, 4 GB pre-installed: 1 slot of 4 GB DDR3-1600 204 pin SO-DIMM SDRAM

USB: 4 bootable USB 2.0 hosts, type A connectors

Storage: 2 SATA III interfaces: 6 Gbps, 2.5" removable storage trays

BIOS: 64 Mbit Flash BIOS with SPI, ACPI

Graphics Controller: Intel HM65 Express chipset built in

Video Outputs: DVI-D x 1, VGA x 1 (female)

Other Peripherals

Audio: line in/out, 3.5 mm mini jack

KB/MS: 2 PS/2 interfaces supporting standard PS/2 keyboard and mouse

Display

Panel Size: 26" viewable image size

Panel Type: MVA

Aspect Ratio: 16:10

Pixels: 1920 x 1200 (WUXGA)

Pixel Pitch (RGB): 0.2865 (H) x 0.2865 (V) mm

Response Time: 15 ms (gray to gray)

Contrast Ratio: 1500:1

Light Intensity: 300 cd/m²

Viewing Angles: 176°/176°

Active Display Area: 550.08 (H) x 343.8 (V) mm

Max Colors: 16.7M (8 bit color)

Resolution:

- VGA: 640 x 480
- SVGA: 800 x 600
- XGA: 1024 x 768
- SXGA: 1280 x 1024
- WSXGA+: 1920 x 1080
- WUXGA: 1920 x 1200

Ethernet Interface

LAN: 2 auto-sensing 10/100/1000 Mbps ports (RJ45)

Magnetic Isolation Protection: 1.5 kV built in

Serial Interface

Serial Standards: 2 RS-232/422/485 ports, software-selectable (DB9 male)

Serial Communication Parameters

Data Bits: 5, 6, 7, 8

Stop Bits: 1, 1.5, 2

Parity: None, Even, Odd, Space, Mark

Flow Control: RTS/CTS, XON/XOFF, ADDC® (automatic data direction control) for RS-485

Baudrate: 50 bps to 115.2 Kbps (supports non-standard baudrates; see user's manual for details)

Serial Signals

RS-232: TxD, RxD, DTR, DSR, RTS, CTS, DCD, GND

RS-422: TxD+, TxD-, RxD+, RxD-, GND

RS-485-4w: TxD+, TxD-, RxD+, RxD-, GND

RS-485-2w: Data+, Data-, GND

NMEA Interface

Serial Standards: 8 NMEA 0183 ports

Base Serial Standard: RS-422

Optical Isolation Protection: ±6 kV contact discharge, ±8 kV air discharge

Voltage Differential: -15 V to +15 V

Baudrate: 4800 bps

Data Bits: 8

Stop Bits: 1, 1.5, 2

Parity: None

Handshake: None

LEDs

System: Storage, Power

LAN: 100M/Link x 2, 1000M/Link x 2 (on connector)

Front Panel

LEDs: Storage

SavvyTouch Display Control Buttons: ECDIS, INFO, Brightness (+, -), MENU

Physical Characteristics

Housing: Aluminum sheet metal

Weight: 16.6 kg

Dimensions: 621 x 444 x 90 mm (24.45 x 17.48 x 3.57 in)

Mounting: VESA, panel, and desktop mounting

Environmental Limits

Operating Temperature: -15 to 55°C (5 to 131°F)

Storage Temperature: -20 to 60°C (-4 to 140°F)

Ambient Relative Humidity: 5 to 95% (non-condensing)

Note: If you expect the storage temperature to exceed 40°C, please ensure that the ambient relative humidity remains below 60%.

IP Rating:

- Front: IP54
- Rear: IP22

Anti-Vibration:

- 0.7 g @ DNV2.4 (Class A), sine wave, 2-100 Hz, 1 Oct./min., 1.5 hr per axis
- 1 g @ DNV2.4, random wave, 3-100 Hz, 2.5 hr per axis
- 2.1 g @ DNV2.4 (Class C), sine wave, 2-50 Hz, 1 Oct./min., 1.5 hr per axis

Power Requirements

Input Voltage:

- 24 VDC (18 to 36 VDC), screw-type terminal block
- 100 to 240 VAC, AC power inlet

Power Consumption: 40 to 75 W

Standards and Certifications

Safety: UL 60950-1**EMC:** EN 55032 Class B, EN 55024-4-2, EN 55024-4-3, EN 55024-4-4, FCC Part 15 Subpart B Class A**Marine:** IEC 60945 4th, IEC 61174, IEC 61162, DNV2.4, IACS E10**Green Product:** RoHS, cRoHS, WEEE

Reliability

Automatic Reboot Trigger: Built-in WDT (watchdog timer) supporting 1-255 levels for time interval system reset, software programmable

Warranty

Warranty Period:

3 years for computer systems,
1 year for LCD panels

Details: See www.moxa.com/warranty

MPC-2240 Models

Computer

CPU: Intel Celeron® Processor 1047UE (2M Cache, 1.40GHz), TDP 17 watts (standard)**OS:** Windows 7 Professional, Windows Embedded Standard 7, Windows XP Embedded, Windows XP SP3**System Chipset:** Intel HM65**System Memory:** 8 GB capacity, 4 GB pre-installed: 1 slot of 4 GB DDR3-1600 204 pin SO-DIMM SDRAM**USB:** 4 bootable USB 2.0 hosts, type A connectors**Storage:** 2 SATA III interfaces: 6 Gbps, 2.5" removable storage trays**BIOS:** 64 Mbit Flash BIOS with SPI, ACPI**Graphics Controller:** Intel HM65 Express chipset built-in**Video Output:** 2 outputs: 1 DVI-D, 1 VGA (female)

Other Peripherals

Audio: line in/out, 3.5 mm mini jack**KB/MS:** 2 PS/2 interfaces supporting standard PS/2 keyboard and mouse

Display

Panel Size: 24" viewable image size**Panel Type:** MVA**Aspect Ratio:** 16:9**Pixels:** 1920 x 1080 (WSXGA+)**Pixel Pitch (RGB):** 0.276 (H) x 0.276 (V) mm**Response Time:** 25 ms (gray to gray)**Contrast Ratio:** 5000:1**Light Intensity:** 300 cd/m²**Viewing Angles:** 178°/178°**Active Display Area:** 531.36 (H) x 298.89 (V) mm**Max Colors:** 16.7M (8 bit color)**Resolution:**

- VGA: 640 x 480
- SVGA: 800 x 600
- XGA: 1024 x 768
- SXGA: 1280 x 1024
- WSXGA+: 1920 x 1080 (benchmarked setting)

Ethernet Interface

LAN: 2 auto-sensing 10/100/1000 Mbps ports (RJ45)

Magnetic Isolation Protection: 1.5 kV built-in

Serial Interface

Serial Standards: 2 RS-232/422/485 ports, software-selectable (DB9 male)

Serial Communication Parameters

Data Bits: 5, 6, 7, 8

Stop Bits: 1, 1.5, 2

Parity: None, Even, Odd, Space, Mark

Flow Control: RTS/CTS, XON/XOFF, ADDC® (automatic data direction control) for RS-485

Baudrate: 50 bps to 921.6 Kbps (supports non-standard baudrates; see user's manual for details)

Serial Signals

RS-232: TxD, RxD, DTR, DSR, RTS, CTS, DCD, GND

RS-422: TxD+, TxD-, RxD+, RxD-, GND

RS-485-4w: TxD+, TxD-, RxD+, RxD-, GND

RS-485-2w: Data+, Data-, GND

NMEA Interface

Serial Standards: 8 NMEA 0183 ports

Base Serial Standard: RS-422

Optical Isolation Protection: ±6 kV contact discharge, ±8 kV air discharge

Voltage Differential: -15 V to + 15 V

Baudrate: 4800 bps

Data Bits: 8

Stop Bits: 1, 1.5, 2

Parity: None

Handshake: None

LEDs

System: Storage, Power

LAN: 100M/Link x 2, 1000M/Link x 2 (on connector)

Front Panel

LEDs: Storage

SavvyTouch Display Control Buttons: ECDIS, INFO, Brightness (+, -), Power

Physical Characteristics

Housing: Aluminum sheet metal

Weight: 12.4 kg

Dimensions: 595 x 393 x 75 mm (23.44 x 15.48 x 2.95 in)

Mounting: Flush mounting

Environmental Limits

Operating Temperature: -15 to 55°C (5 to 131°F)

Storage Temperature: -20 to 60°C (-4 to 140°F)

Ambient Relative Humidity: 5 to 95% (non-condensing)

IP Rating: IP22 (IP65 models available on request)

Anti-Vibration:

- 0.7 g @ DNV 2.4 (Class A), sine wave, 2-100 Hz, 1 Oct./min., 1.5 hr per axis
- 1 g @ DNV 2.4, random wave, 3-100 Hz, 2.5 hr per axis
- 2.1 g @ DNV 2.4 (Class C), sine wave, 2-50 Hz, 1 Oct./min., 1.5 hr per axis

Power Requirements

Input Voltage:

- 24 VDC (18 to 36 VDC), screw-type terminal block
- 100 to 240 VAC, AC power inlet

Power Consumption: 40 to 75 W

Standards and Certifications

Safety: UL 60950-1, CCC

EMC: EN 55032 Class B, EN 55024-4-2, EN 55024-4-3, EN 55024-4-4, FCC Part 15 Subpart B Class A

Marine: IEC 60945 4th, IEC 61174, IEC 61162, DNV2.4, IACS E10

Green Product: RoHS, cRoHS, WEEE

Reliability

Automatic Reboot Trigger: Built-in watchdog timer (WDT), configurable for resets following 1-255 second hang intervals; software programmable

Warranty

Warranty Period: 1 year

Details: See www.moxa.com/warranty

MPC-2190 Models

Computer

CPU: Intel Celeron® Processor 1047UE (2M Cache, 1.4 GHz)

OS: Windows 7 Professional, Windows XP Embedded, Windows Embedded Standard 7, Windows XP SP3 (models with OS pre-installed available by request)

System Chipset: Intel BD82HM65 platform controller hub

System Memory: 4 GB pre-installed: 1 slots of 4 GB DDR3-1066 204 pin SO-DIMM SDRAM

USB: USB 2.0 hosts x 4, type A connectors, supporting system boot up

Storage: 2 SATA-III connectors

BIOS: 64 Mbit Flash BIOS SPI type, ACPI function supported

Graphics Controller: Intel HM65 Express chipset built-in

Video Output: DVI-D x 1, VGA x 1 (female)

Digital Input/Output: 4 DIs, 4 DOs, or 8 DIs, 8 DOs (optional)

LPT Port: 1 (available on request)

Buzzer: 75 to 85 db (IEC 60945 compliant)

Other Peripherals

Audio: Line-in and line-out interface, with 3.5 mm mini jack

KB/MS: 2 PS/2 interface supporting standard PS/2 keyboard and mouse

Display

Panel Size: 19 inch wide viewable image size

Panel Type: MVA

Aspect Ratio: 5:4

Pixels: 1280 x 1024 (SXGA)

Response Time: 20 ms

Contrast Ratio: 2000:1

Light Intensity: 300 cd/m²

Viewing Angles: 178°/178°

Active Display Area: 376.32 (H) x 301.06 (V) mm

Max Colors: 16.7M (8 bits/color)

Display Interface: Dual channel LVDS

Resolution:

- VGA: 640 x 480
- SVGA: 800 x 600
- XGA: 1024 x 768
- SXGA: 1280 x 1024

Ethernet Interface

LAN: 2 auto-sensing 10/100/1000 Mbps ports (RJ45)

Magnetic Isolation Protection: 1.5 kV built-in

Serial Interface

Serial Standards: 2 RS-232/422/485 ports, software-selectable (DB9 male)

Serial Communication Parameters

Data Bits: 5, 6, 7, 8

Stop Bits: 1, 1.5, 2

Parity: None, Even, Odd, Space, Mark

Flow Control: RTS/CTS, XON/XOFF, ADDC® (automatic data direction control) for RS-485

Baudrate: 50 bps to 115.2 Kbps (supports non-standard baudrates; see user's manual for details)

Serial Signals

RS-232: TxD, RxD, DTR, DSR, RTS, CTS, DCD, GND

RS-422: TxD+, TxD-, RxD+, RxD-, GND

RS-485-4w: TxD+, TxD-, RxD+, RxD-, GND

RS-485-2w: Data+, Data-, GND

NMEA Interface

Serial Standards: 4 NMEA 0183 ports

Base Serial Standard: RS-422

Optical Isolation Protection: ±6kV contact discharge, ±8kV air discharge

Voltage Differential: -15 V to + 15 V

Baudrate: 4800 bps

Data Bits: 8

Stop Bits: 1, 1.5, 2

Parity: None

Handshake: None

LEDs

System: Storage, Power

LAN: 100M/Link x 2, 1000M/Link x 2 (on connector)

Front Panel

LEDs: MENU, Brightness, INFO, ECDIS, Day/Dusk/Night, Storage

Smart OSD: Yes

Physical Characteristics

Housing: Aluminum sheet metal

Weight: 7.8 kg

Dimensions: 429 x 387 x 74.5 mm (16.89 x 15.24 x 2.93 in)

Mounting: Flush mounting

System Cooling: Fanless thermal design

Environmental Limits

Operating Temperature: -15 to 55°C (5 to 131°F)

Storage Temperature: -20 to 60°C (-4 to 140°F)

Ambient Relative Humidity: 5 to 95% (non-condensing)

IP Rating:

- Front: IP 54
- Rear: IP 22

Anti-Vibration:

- 0.7 g @ DNV 2.4 (Class A), sine wave, 2-100 Hz, 1 Oct./min., 1.5 hr per axis
- 1 g @ DNV 2.4, random wave, 3-100 Hz, 2.5 hr per axis
- 1 g @ DNV 2.4 (Class C), sine wave, 2-50 Hz, 1 Oct./min., 1.5 hr per axis

Power Requirements

Input Voltage: 115 to 230 VAC, 50/60 Hz, 24 VDC

Power Consumption: 40 W to 125 W (max.)

Standards and Certifications

Safety: UL 60950-1, CCC

EMC: EN 55032 Class B, EN 55024-4-2, EN 55024-4-3, EN 55024-4-4, FCC Part 15 Subpart B Class A

Marine Standard: IEC-60945 4th, IEC-61162, IEC-61174

Marine Type Approval: DNV 2.4 and IACS E10, ABS, MR-A003

Green Product: RoHS, cRoHS, WEEE

Reliability

MTBF (mean time between failures): 202,309 hrs

Automatic Reboot Trigger: Built-in WDT (watchdog timer) supporting 1-255 levels for time interval system reset, software programmable

Warranty

Warranty Period: 1 year

Details: See www.moxa.com/warranty

Optional Features for the MPC-2000 Series

| | | |
|------------------------|--|--|
| CPU | Default | Intel Celeron® processor 1047UE (2M Cache, 1.40GHz), TDP 17 watts |
| | Options | <ul style="list-style-type: none"> Intel Core™ i3 processor 3217UE (3M Cache, 1.60GHz), TDP 17 watts Intel Core™ i7 processor 3517UE (4M Cache, 2.80GHz), TDP 17 watts |
| RAM | Default | 4 GB |
| | Option | 8 GB (max.) |
| OS | Default | N/A |
| | Options | <ul style="list-style-type: none"> Windows 7 Professional Windows XP Embedded Windows Embedded Standard 7 Windows XP SP3 |
| Factory Options | <ul style="list-style-type: none"> (For MPC-2190 and MPC-2240) Projected capacitive touch screen (multi-touch, USB interface) Optical bonding Color calibrated for ECDIS Customized options for SSD drives | |

Hardware Block Diagram

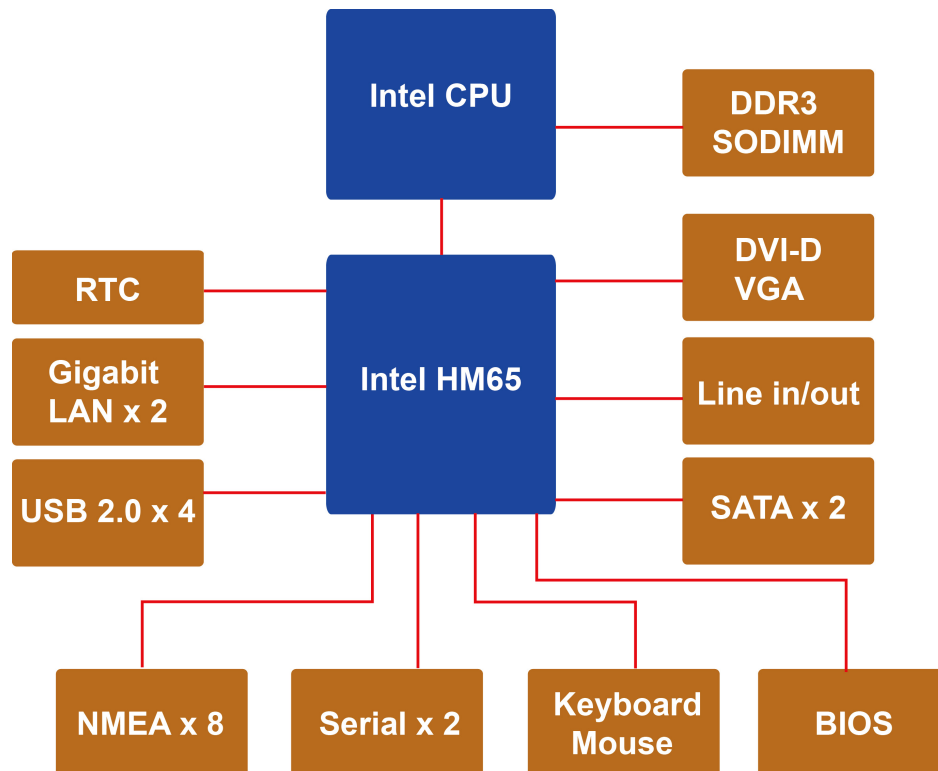

Hardware Overview

The MPC-2000 series is compact, well-designed, and hardened for industrial marine applications. The intelligent SavvyTouch display control buttons allow you to easily locate and manipulate control buttons in low light environments, or to receive immediate system hardware reports for troubleshooting. The MPC-2000 series features a reliable and stable hardware platform with multiple serial ports, for connecting a wide variety of data devices.

The following topics are covered in this chapter:

- ❑ **Appearance**
 - Front View
 - Bottom View
- ❑ **Dimensions**
 - MPC-2260
 - MPC-2240
 - MPC-2190
- ❑ **SavvyTouch Display Control Buttons**
- ❑ **Real Time Clock**

Appearance

Front View

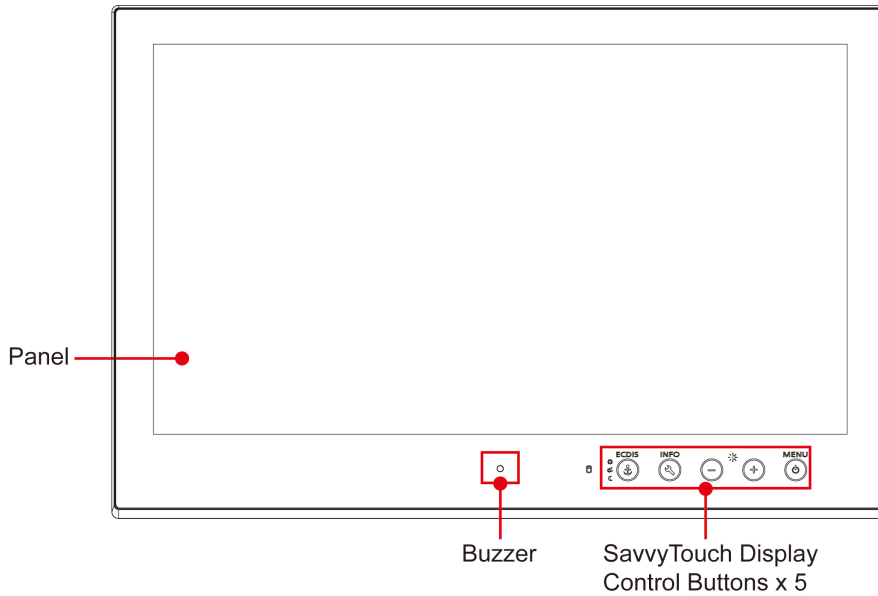

Bottom View

MPC-2240/MPC-2260

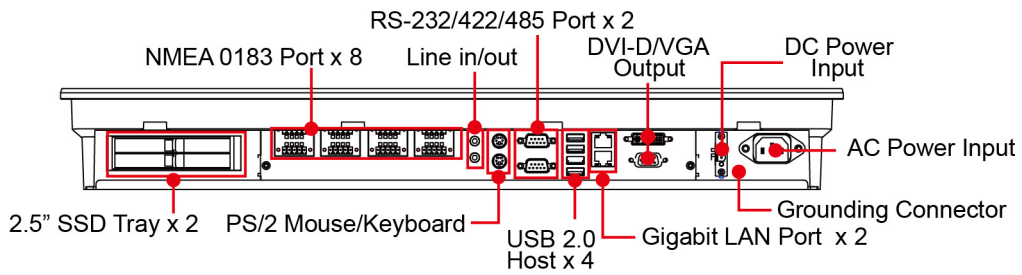

MPC-2190

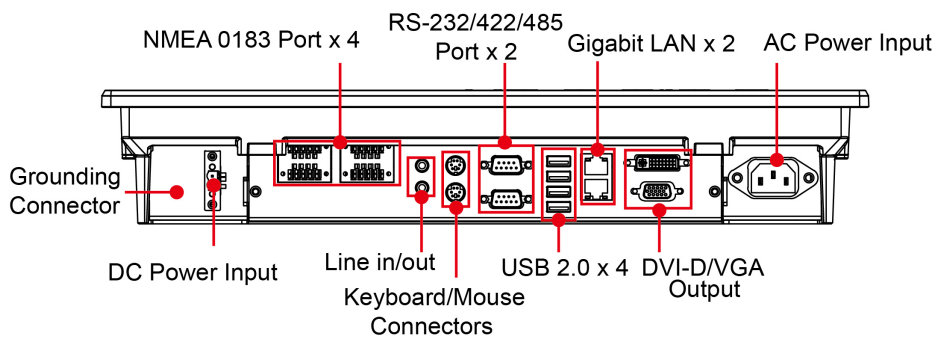

Dimensions

MPC-2260

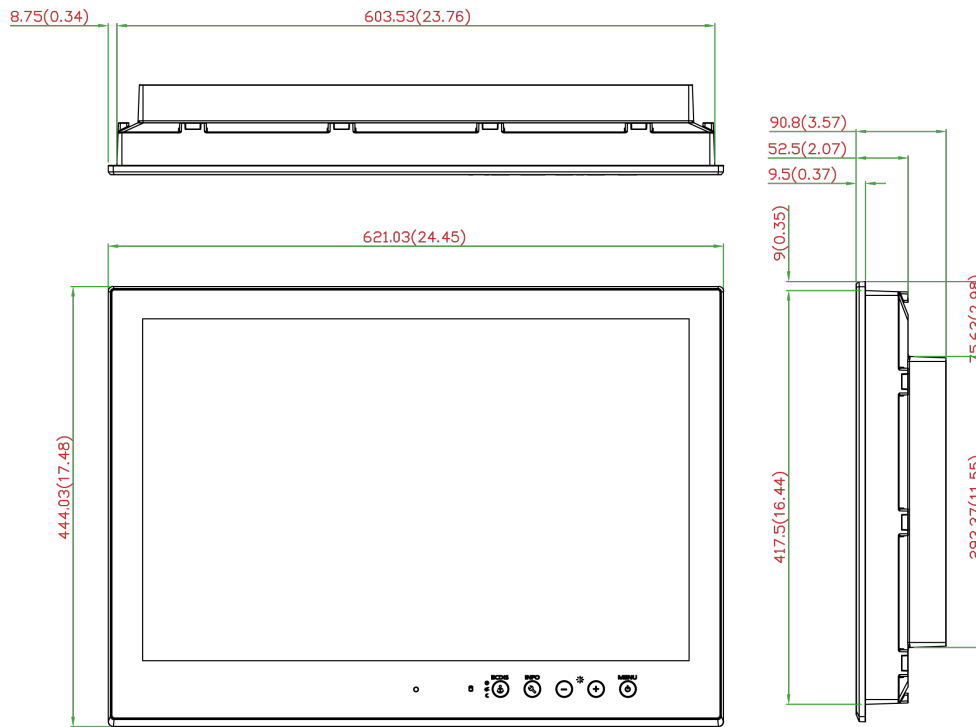

MPC-2240

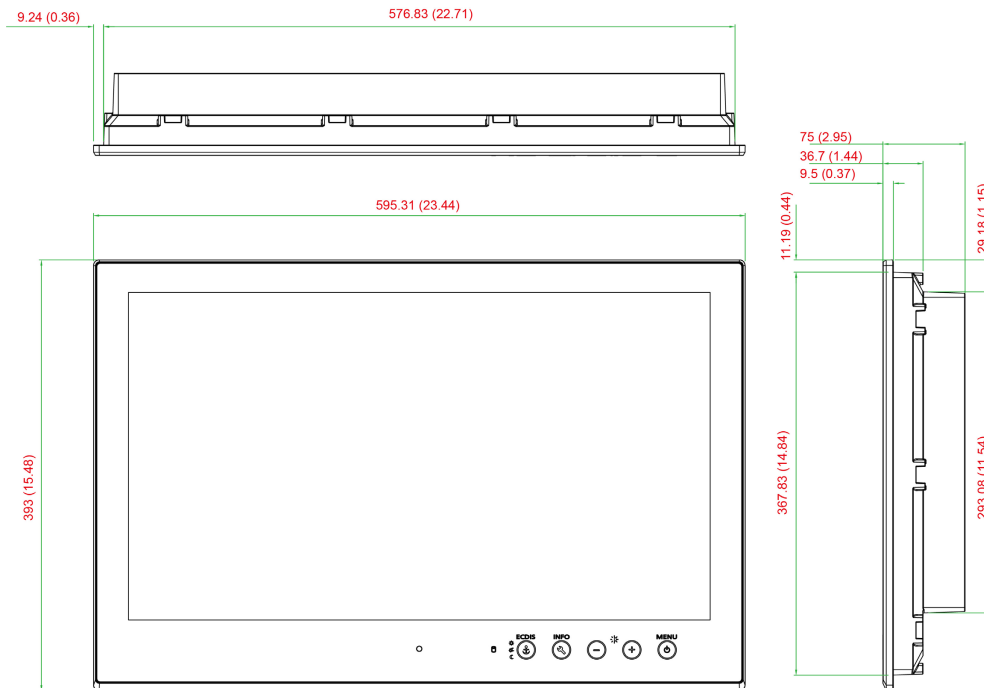



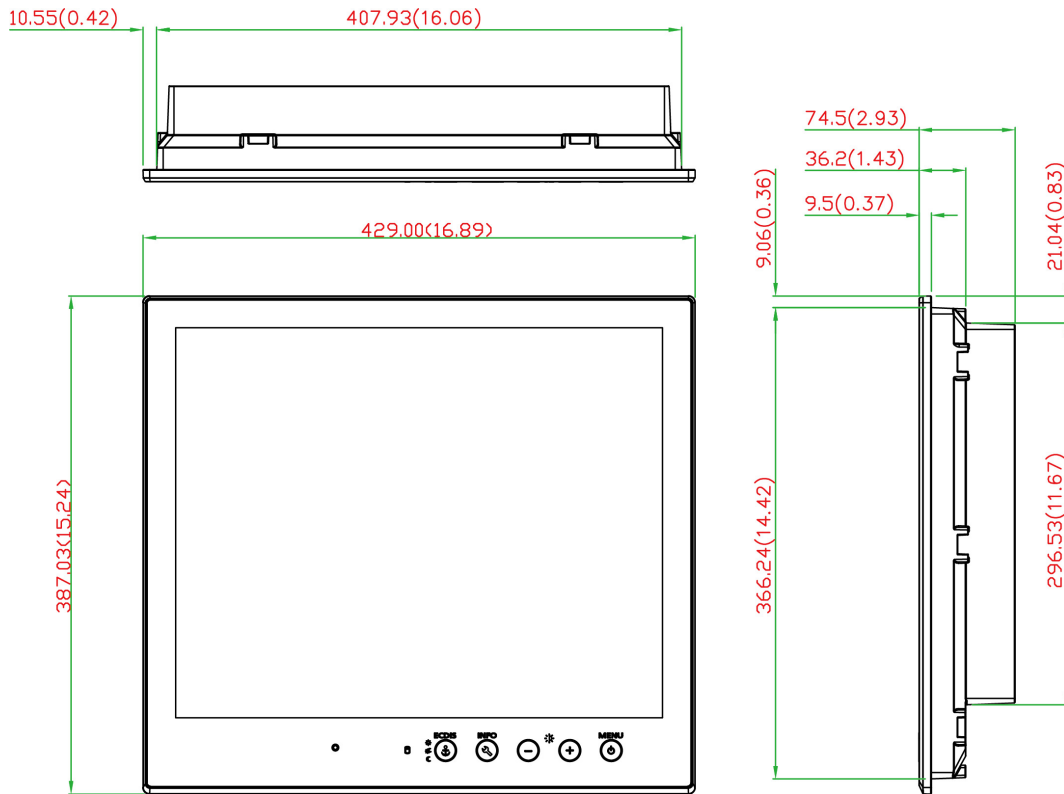

MPC-2190



SavvyTouch Display Control Buttons

The MPC-2000 series comes with SavvyTouch display controls situated in the lower right corner of the screen. These intelligent buttons will light up automatically when your fingers draw near. Refer to the following table for more information on each button.

| Name | Color | Control Function / Color Legend |
|---|----------------|--|
|  Power | Green | Computer is powered on and functioning normally. |
| | Red | Power on standby and system is shut down. |
| | Off | Power is off. |
|  Brightness | White | + : To increase brightness of display panel. - : To decrease brightness of display panel. |
| | Off | System is functioning normally. |
|  Info | Red | System hardware error has occurred. |
| | Off | System is functioning normally. |
|  Display mode (ECDIS models only) | White | Displays the brightness mode. |
| | Off | Brightness of display panel is out of ECDIS standard range. |
|  Storage | Red (on) | Storage drive is functioning properly. |
| | Red (blinking) | Accessing or writing data to storage drive. |
| | Off | Storage drive is offline. |

Real Time Clock

The real-time clock in the MPC-2000 series is powered by a lithium battery. Do **NOT** replace the lithium battery on your own. If the battery needs to be changed, please contact the Moxa RMA service team.



ATTENTION

There is a risk of explosion if the wrong type of battery is used. To avoid this potential danger, always use the correct type of battery. Contact the Moxa RMA service team if you need to replace the battery.

Hardware Installation and Connection

This chapter describes how to connect the MPC-2000 series to the network and to other devices.

The following topics are covered in this chapter:

- ❑ **Installation and Handling Notes**
 - Desktop Mounting
 - Panel Mounting
 - VESA Mounting
- ❑ **Wiring Requirements**
- ❑ **Grounding the MPC-2000 Series Panel Computer**
- ❑ **Powering On the MPC-2000 Series**
- ❑ **Powering Off the MPC-2000 Series**
 - SavvyTouch Display Controls
- ❑ **Connecting Data Transmission Cables**
 - Connecting to the Network
 - Connecting Serial Devices
 - Connecting NMEA 0183 Devices
- ❑ **Connecting Speakers or Headphones**
- ❑ **Connecting a PS/2 Keyboard and Mouse**
- ❑ **Connecting to USB Devices**
- ❑ **Installing a SATA Storage Drive**
 - On the MPC-2260 or MPC-2240
 - On the MPC-2190

Installation and Handling Notes

Before installing or mounting the MPC-2000 series panel computer, read the following notes:

1. The MPC-2000 series is designed for mounting on a **desktop, wall**, or an **FDMI /VESA interface**. Refer to the illustrations in the related sections for detailed instructions.
2. To prolong product lifespan, good ventilation must be maintained around the machinery. The chassis' heat-sink area **MUST** be kept clear from other heat generating items; otherwise, damage to the system motherboard may occur. The minimal distance that must be maintained between the heat sink and another heat source is 150 mm.
3. Do **NOT** install the unit horizontally (for example, lying down on its back), as heat cannot be dissipated effectively and may cause damage to the LCD panel. To ensure adequate heat dissipation, install the unit vertically or within a ± 40 degrees slope off the vertical.
4. Exposure to extreme direct sunlight may cause a considerable increase in the temperature of the unit, and under certain circumstances might lead to overheating. Take this into consideration when bridge equipment is being planned (for example, sun shades, distance from the windows, and ventilation.)
5. Exposure to strong vibration or loud, chronic noise might affect functionality and/or product lifespan. It is advised to take vibration and noise into consideration during system assembly and installation, so that the mount point may be carefully selected to avoid exposure to undue vibration.
6. For maximum safety, at least two persons should work together to lift, place, and fasten the computer at its mount point. Before you lift or move the computer, make sure that the system is turned off and no power is being supplied to the system. In addition, make sure that you have prepared the correct screws for mounting.

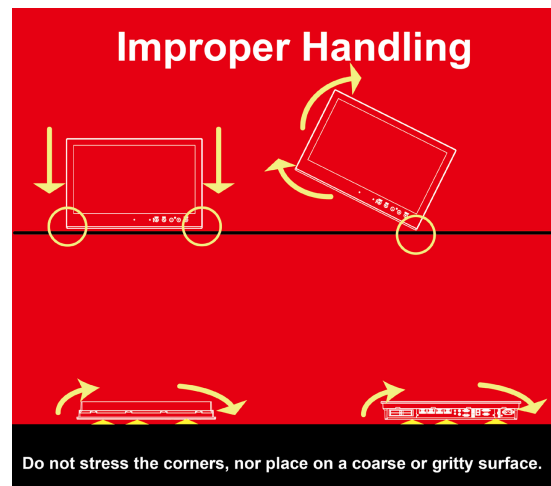
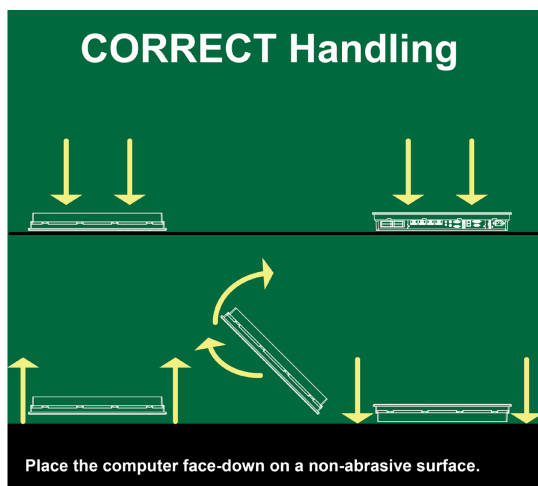

Desktop Mounting

The MPC-2000 series display comes with optional brackets that allow you to install the unit on a horizontal surface, such as a desktop. Three round screws are required for each bracket. See the following figures for detailed screw specifications and the torque values.

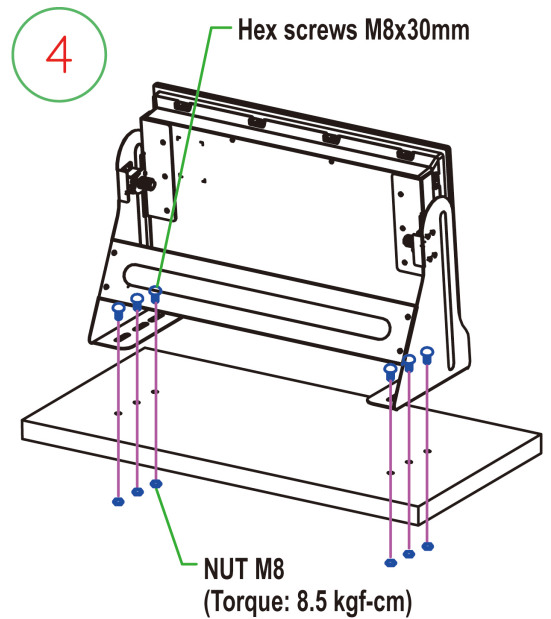
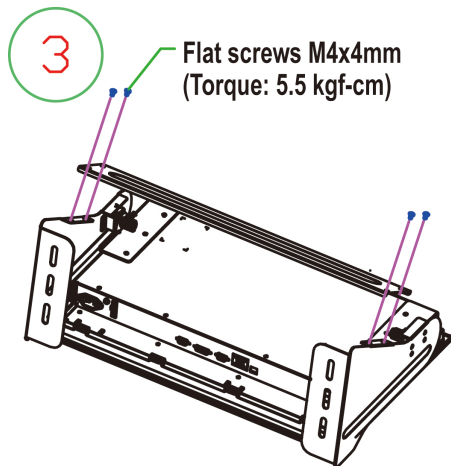
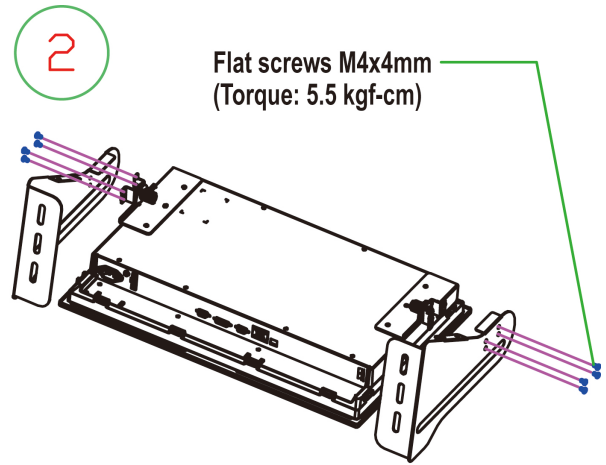
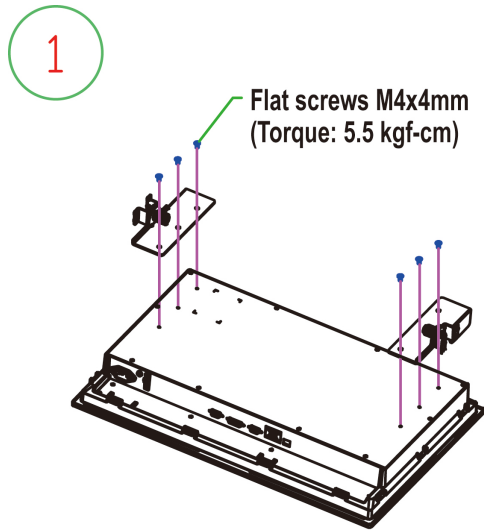

MPC-2260 and MPC-2240

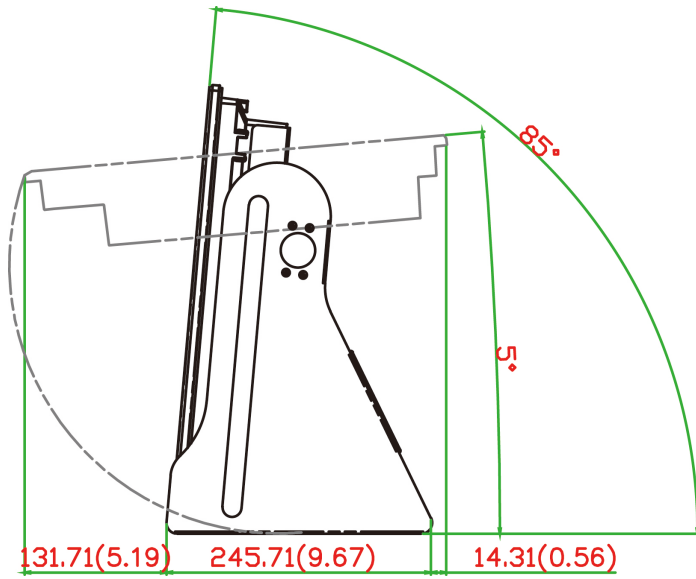

MPC-2190

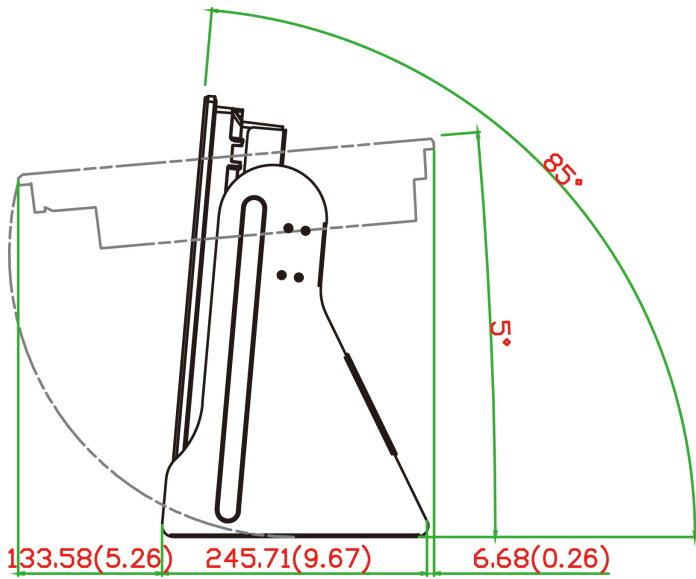

Place your MPC-2000 series display on a clean, flat, well-ventilated desktop. For proper ventilation, leave some space between the MPC-2000 series display and other equipment.

Do NOT place equipment or objects on top of the MPC-2000 series display. Doing so might damage internal components.

Panel Mounting

The MPC-2000 series display comes with 14 optional clamp mounts that enable you to install the unit onto a wall (where space has been cut out to accommodate the rest of the hardware) or into computing stations where a flush mount is needed.

The maximum thickness of the surface to which the unit can be clamped is 11 mm.

For a secure mounting, use all 14 clamps (for MPC-2260 and MPC-2240 models) or 10 clamps (for MPC-2190 models). The clamp arms are fastened into slots on all four sides of the MPC-2000 series display.

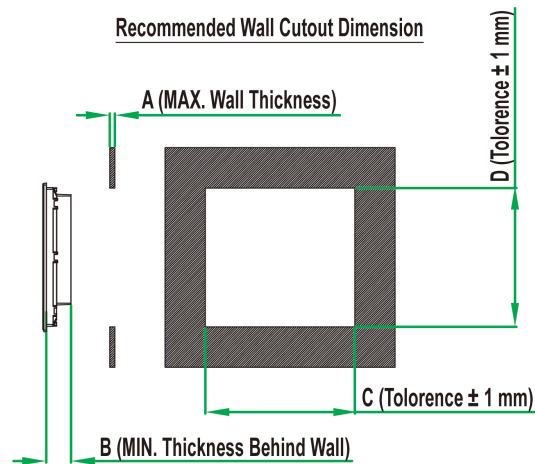

| Model | A | B | C | D | Mounting Kits (pcs) |
|----------|---------|---------|----------|----------|---------------------|
| MPC-2260 | 14.0 mm | 81.3 mm | 609.0 mm | 423.0 mm | 14 |
| MPC-2240 | 11.0 mm | 65.0 mm | 581.0 mm | 374.0 mm | 14 |
| MPC-2190 | 12.0 mm | 65.0 mm | 411.0 mm | 368.0 mm | 10 |

To fasten the clamp arms to the MPC-2240 mounting slots as shown in the following figure, use the short M4 SUS (stainless) screws. Then, use the clamps to fasten the display to its mounting point. Note the torque values shown in the figure.

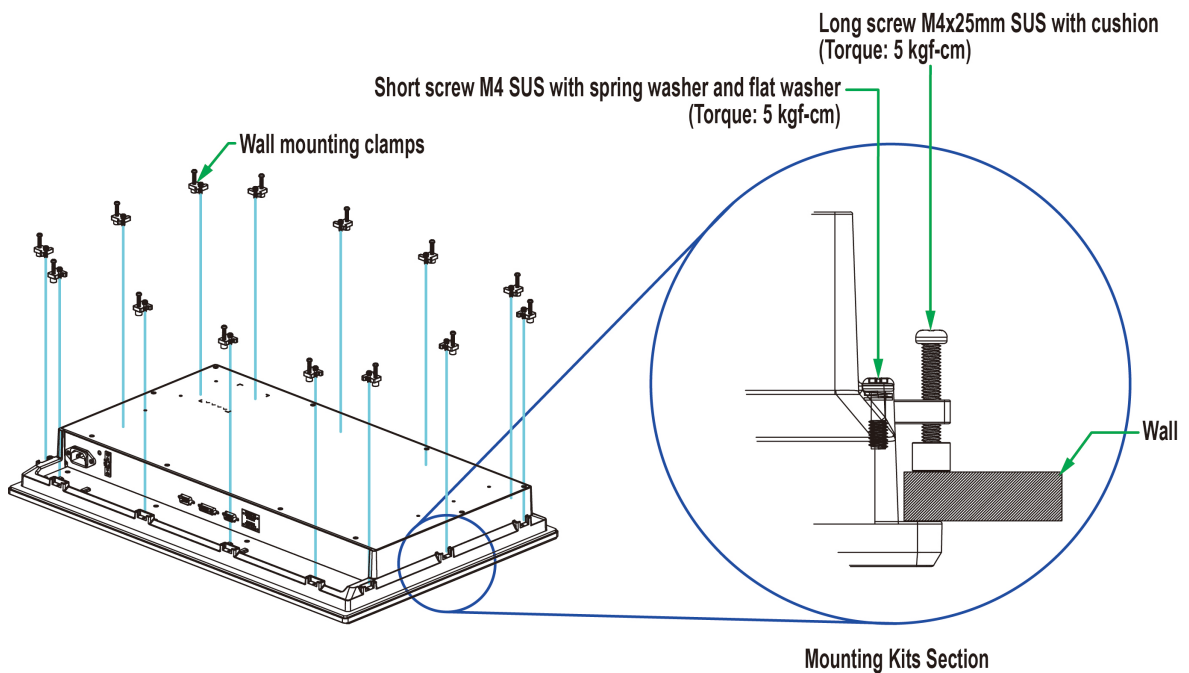

VESA Mounting

The MPC-2000 series also comes with an optional VESA mounting kit. Six flat-headed screws and four round screws are required to fasten the VESA mounting bracket. See the following figure for detailed screw specifications and torque values.

Four additional screws (not included in the kit) are required to mount the unit on a VESA rack. Use M6 screws with a length between 10 and 12 mm.

MPC-2260

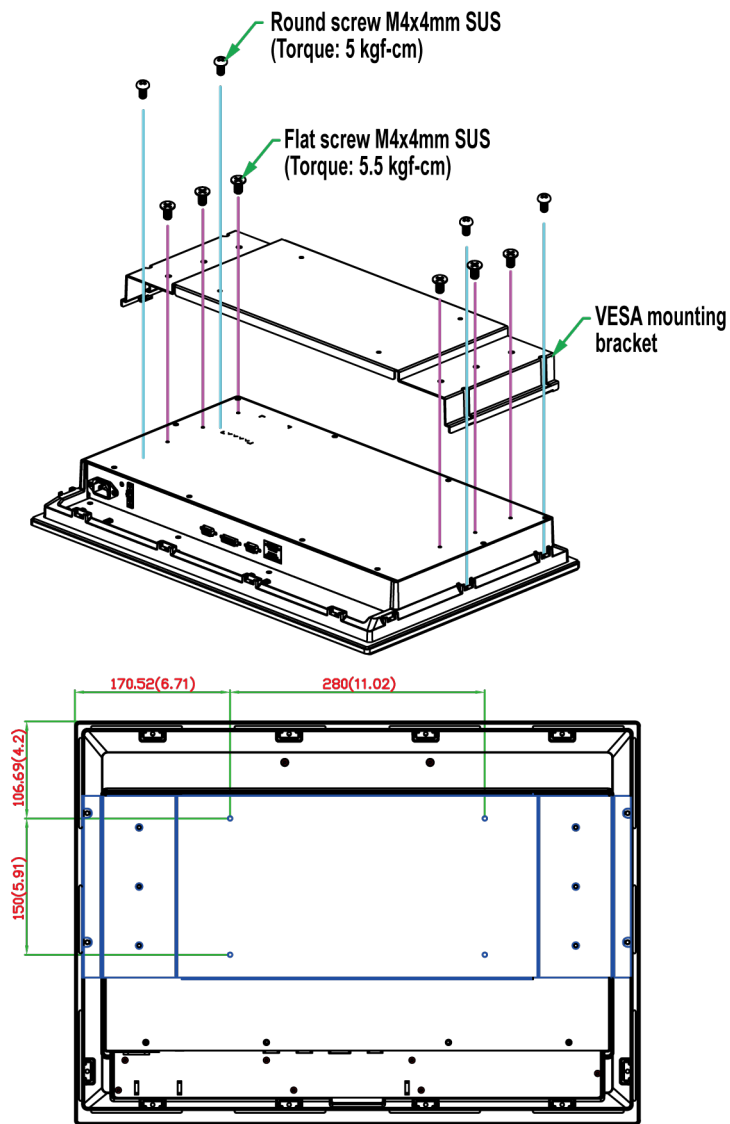

VESA Mounting Kit
4xM6 max. 10 mm deep mounting holes

MPC-2240

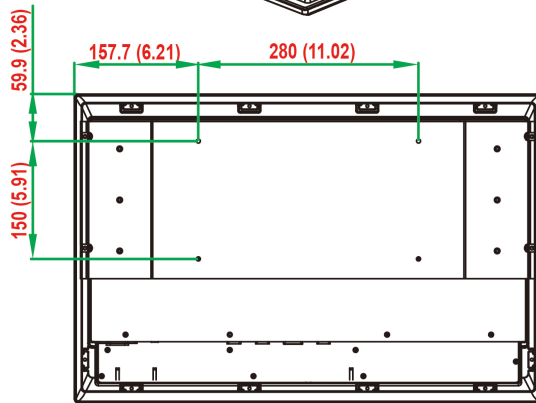
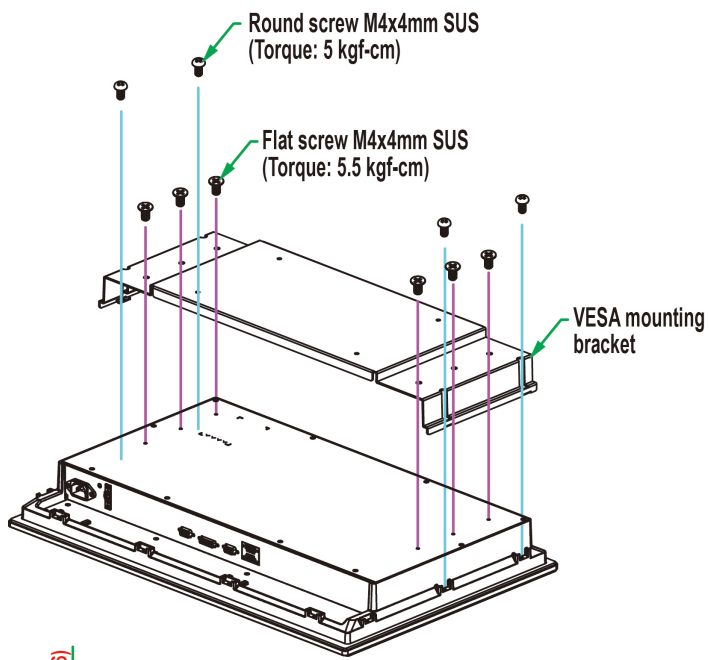

VESA Mounting Kit
4xM6 max. 10 mm deep mounting holes

MPC-2190

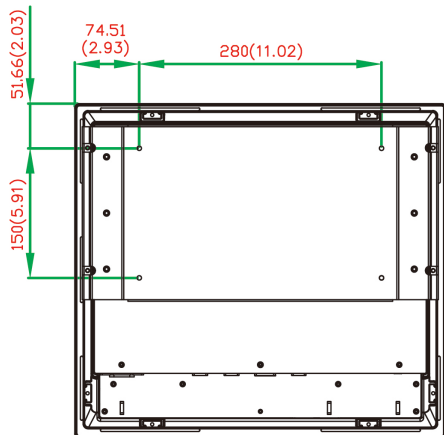
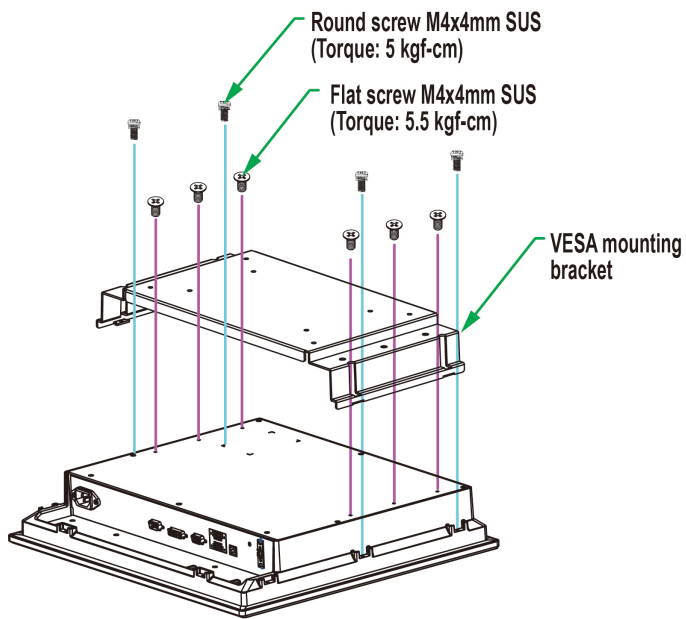

VESA Mounting Kit
4xM6 max. 10 mm deep mounting holes

Wiring Requirements

This section describes how to connect serial devices to the MPC-2000 series.

Read and follow these safety precautions before proceeding with the installation of any electronic devices:

- Use separate paths to route wiring for power and devices. If power wiring and device wiring paths must cross, make sure the wires are perpendicular at the intersection point.

NOTE Do NOT run signal or communications wires together with power wires in the same conduit. To avoid interference, wires with different signal characteristics should be routed separately.

- Based on the type of signal transmitted through a wire, determine which wires should be kept separate and which bundled together. The rule of thumb is that wiring that shares similar electrical characteristics can be bundled together.
- Keep input wiring and output wiring separate.
- It is advisable to label all wires used in the system.



ATTENTION

Safety First!

Be sure to disconnect the power cord before installing and/or wiring your MPC-2000 series panel computer.

Wiring Caution!

Calculate the maximum possible current in each power wire and common wire. Observe all electrical codes dictating the maximum current allowable for each wire size.

If the current goes above the maximum ratings, the wiring could overheat, causing serious damage to your equipment.

Temperature Caution!

Be careful when handling the unit. When the unit is plugged in, the internal components generate heat, and consequently the outer casing may feel hot to the touch.

We recommend taking the following precautions to minimize heat build-up within the display:

- Position the display within $\pm 40^\circ$ of the vertical.
- Install an external fan to increase airflow upwards through the display if (a) the display is not positioned within $\pm 40^\circ$ of the vertical, (b) the ambient temperature exceeds 25°C, or (c) the display is used in a location with minimal ventilation.

Important Safety Precaution

Even though the display is rated to operate within the IEC 60945 standard of -15 to 55°C for marine applications, it is best to ensure that the ambient temperature does not exceed 25°C. Doing so will increase the life of your display and minimize service costs.

Grounding the MPC-2000 Series Panel Computer

Before you power on the MPC-2000 series, first ground it. Proper grounding and wire routing help limit the effects of noise due to electromagnetic interference (EMI). Run the ground connection from the ground screw to the grounding surface prior to connecting the power.

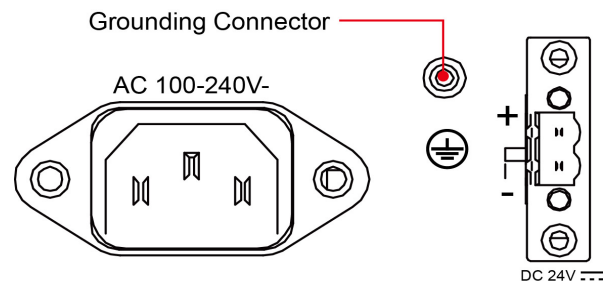

ATTENTION

This unit is intended to be mounted to a well-grounded mounting surface, such as a metal panel.

Powering On the MPC-2000 Series

1. Connect the MPC-2000 series display to a power source, do one of the following:
 - Connect the terminal block to the MPC-2000 Series DC Euroblock terminal (located on the bottom panel).
 - Connect the MPC-2000 series to a power source using the AC power cord provided.
2. Touch the **MENU** button (on the lower right hand corner of the display panel) for about one second to turn on the MPC-2000 series.

NOTE It takes between 10 – 30 seconds for the system to complete the start-up process.

Powering Off the MPC-2000 Series

To power off the MPC-2000 series panel computer, touch the **MENU** button for about four seconds. Depending on the power management settings you configure in the operating system, the MPC-2000 series may enter the **standby**, **hibernation**, or **system shutdown** mode.

To force the MPC-2000 series to shut down, touch the **MENU** button for about 10 seconds.

NOTE If the MPC-2000 series is powered using a DC converter, the INFO dialog displays the **Error** status for AC input power (as shown in the following figure). This does not affect the normal operation of the MPC-2000 series.

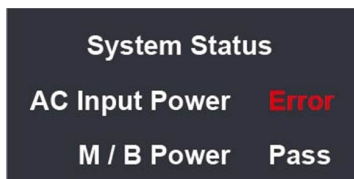

SavvyTouch Display Controls

The MPC-2000 series comes with five SavvyTouch display controls on the front panel. These intelligent controls turn on as your hand draws near the area of the panel where they are located.

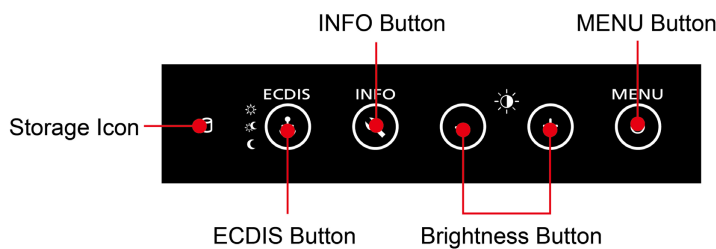

MENU/Power Control

On the MPC-2000 series, the **MENU** button also serves as the power button. To turn on or turn off the MPC-2000 series, press the **Menu** button for about four seconds. After the system is powered up, the MENU button turns green. To power off the MPC-2000 Series, press the MENU button for about four seconds, and then choose to enter **standby**, **hibernation**, or **system shutdown** mode (the available choices may be configured using your operating system's power management settings). If you encounter technical problems, press and hold the MENU button for 10 seconds to force a hard shutdown.

Brightness

You can use the two brightness buttons to set the brightness of the screen. Press the plus (+) button to increase screen brightness, and the minus (-) button to decrease screen brightness.

INFO

The **INFO** button displays a status report (shown at right) of the AC power supply, main board, CPU, memory, the motherboard chipset, and VGA subsystems and components.

When the panel computer is working properly, the screen displays **Pass** for each subsystem/component (as shown in the figure). The screen displays Error to indicate that a faulty component.

The CPU, memory, chipset and VGA components are detected only during the boot process. The AC and motherboard power components are being monitored continuously.

| System Status | |
|----------------|------|
| AC Input Power | Pass |
| M / B Power | Pass |
| CPU | Pass |
| Memory | Pass |
| Chipset | Pass |
| VGA | Pass |

NOTE If the MPC-2000 series is powered using a DC converter, the systems displays Error for the AC power status in the System Status screen. This does not affect the operation of the MPC-2000 series.

| System Status | |
|----------------|-------|
| AC Input Power | Error |
| M / B Power | Pass |

ECDIS Mode Brightness Adjustment

For ECDIS-approved models, you can use the ECDIS button to select an ECDIS display mode (DAY, DUSK, or NIGHT). The ECDIS mode setting overwrites the custom display settings you specified.

The ECDIS button and ECDIS-related functions are disabled on standard MPC-2000 series models.

| ECDIS Mode |
|------------|
| DAY |
| DUSK |
| NIGHT |

 (Storage)

The storage icon blinks red when data is been accessed on the MPC-2000 series.

NOTE You can also control the MPC-2000 series using commands over the UART interface. For detailed UART command description, see [Appendix B: UART Commands for Display Control](#).

Connecting Data Transmission Cables

This section describes how to connect the MPC-2000 series to serial devices and the network.

Connecting to the Network

To connect the MPC-2000 series to a network, connect an Ethernet cable to an Ethernet port on the bottom panel of the MPC-2000 series. The LED on the Ethernet port on the MPC-2000 series turns on to indicate that an Ethernet connection has been established.

The following figures indicate the location of the Gigabit Ethernet ports.

MPC-2240/MPC-2260

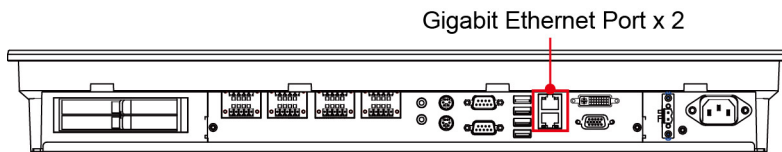

MPC-2190

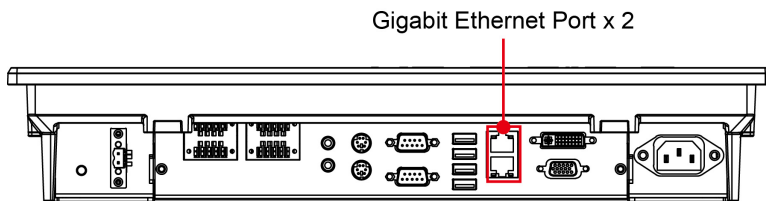

The 10/100/1000 Mbps Ethernet LAN port uses 8-pin RJ45 connectors. The following diagram shows the pinouts and the descriptions for these ports.

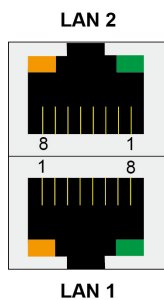

| | |
|--------|--------------------------------------|
| Green | 100 Mbps Ethernet mode |
| Yellow | 1000 Mbps (Gigabit) Ethernet mode |
| Off | No activity or 10 Mbps Ethernet mode |

| Pin | 100 Mbps | 1000 Mbps |
|-----|----------|-----------|
| 1 | ETx+ | TRD(0)+ |
| 2 | ETx- | TRD(0)- |
| 3 | ERx+ | TRD(1)+ |
| 4 | - | TRD(2)+ |
| 5 | - | TRD(2)- |
| 6 | ERx- | TRD(1)- |
| 7 | - | TRD(3)+ |
| 8 | - | TRD(3)- |

Connecting Serial Devices

You can configure the serial ports 1 and 2 (male DB9) RS-232, RS-422, or RS-485 communications. See the figure below for the location of the serial ports.

MPC-2240/MPC-2260

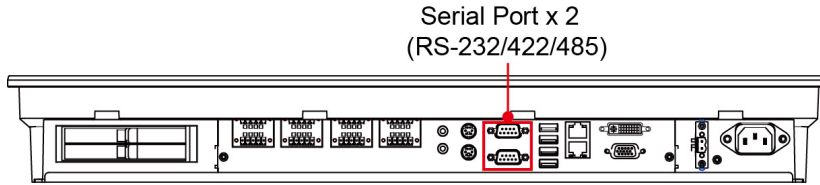

MPC-2190

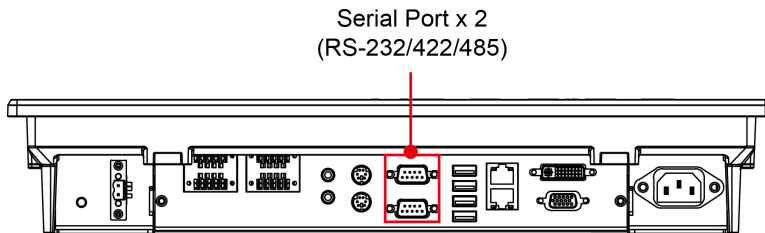

The following table shows the pin assignments.

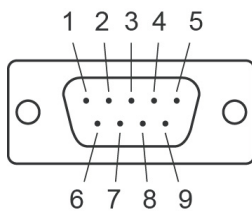

| Pin | RS-232 | RS-422 | RS-485 (4-wire) | RS-485 (2-wire) |
|-----|--------|---------|-----------------|-----------------|
| 1 | DCD | TxDA(-) | TxDA(-) | - |
| 2 | RxD | TxDB(+) | TxDB(+) | - |
| 3 | TxD | RxDB(+) | RxDB(+) | DataB(+) |
| 4 | DTR | RxDA(-) | RxDA(-) | DataA(-) |
| 5 | GND | GND | GND | GND |
| 6 | DSR | - | - | - |
| 7 | RTS | - | - | - |
| 8 | CTS | - | - | - |

Configuring the Serial Ports

For instructions on how to set the serial port for RS-232/422/485 communications, refer to the examples in one of the following folders on the software CD.

- For Windows 32-bit platforms:
 <Software DVD>\MPC-2000 Series\Example\X86\Release
- For Windows 64-bit platforms:
 <Software DVD>\MPC-2000 Series\Example\x64\Release

Connecting NMEA 0183 Devices

The MPC-2000 series comes with either eight NMEA 0183 ports (MPC-2240 and MPC-2260 models) or eight NMEA 0183 ports (MPC-2190 models) on the bottom panel.

The following figures show the location of the NMEA ports and the pin assignments.

MPC-2240/MPC-2260

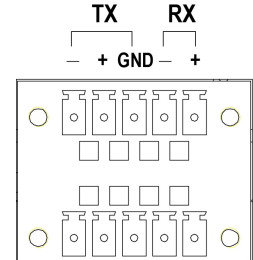
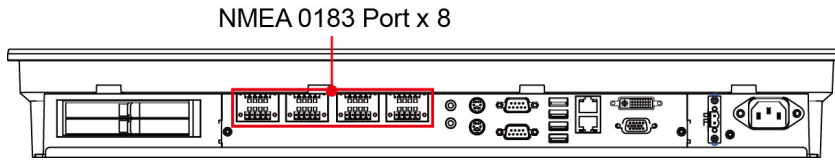

MPC-2190

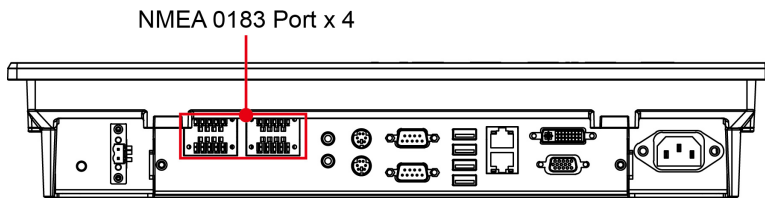

Connecting Speakers or Headphones

The MPC-2000 series comes with standard 3.5 mm monaural line-in and line-out ports for connecting microphone, speakers, and headphones. See the following figure for detailed location.

MPC-2240/MPC-2260

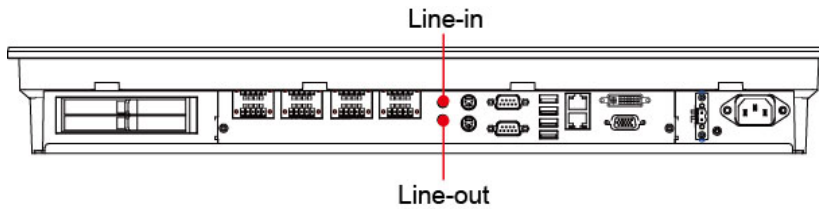

MPC-2190

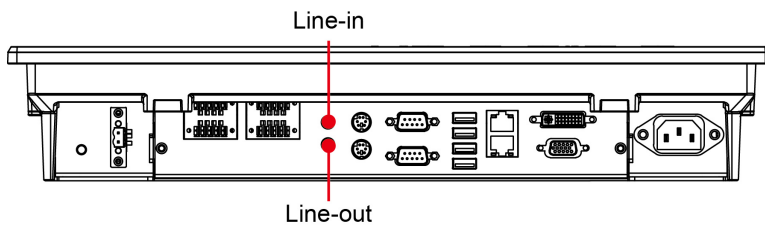

Connecting a PS/2 Keyboard and Mouse

Your MCP-2240-MP computer comes with two PS/2 connectors to connect to a PS/2 keyboard (upper connector) and PS/2 mouse (lower connector). See the following figure for the detailed location.

MPC-2240/MPC-2260

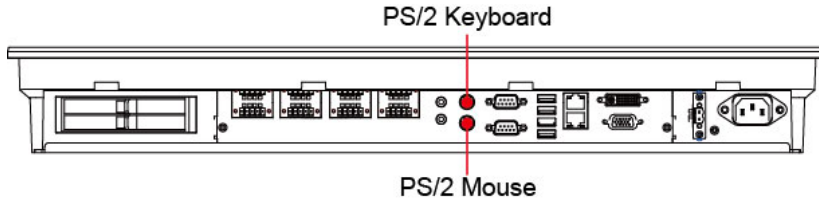

MPC-2190

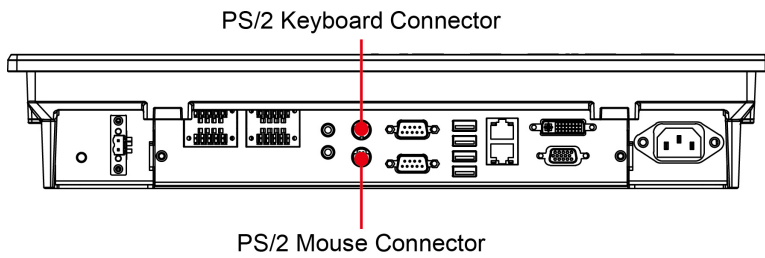

Connecting to USB Devices

The MPC-2000 series comes with four USB 2.0 ports on the bottom panel. You can connect USB devices (such as a mouse or keyboard) or an external storage drive to the USB ports.

MPC-2240/MPC-2260

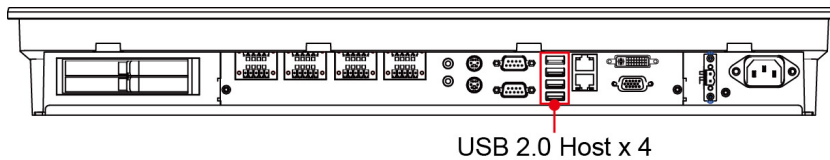

MPC-2190

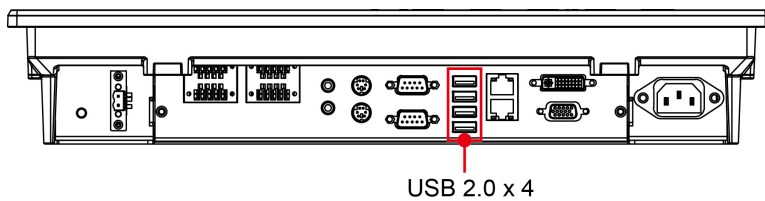

Installing a SATA Storage Drive

You can install a SATA hard disk drive (HDD) or solid state drive (SSD) in the MPC-2000 series. For added reliability, we recommend that you install an SSD in the MPC-2000 series.

The procedure to install a SATA storage drive varies depending on your MPC-2000 series model.

On the MPC-2260 or MPC-2240

To install a SATA storage drive in an MPC-2260 or MPC-2240 panel computer, complete the following steps:

1. Locate the storage trays on the bottom panel of the computer. For ease of installation, we recommend that you place the MPC-2260 or MPC-2240 on a non-abrasive surface with its display panel facing down.
2. Use the protection key to unlock the storage tray cover.
3. Lift the lever to open the storage tray cover.
4. Orient the SATA storage (face up) drive and insert it into the slot.
5. Push the lever to close the storage tray cover.

Protection Lock



NOTE If you are unable to properly secure the SATA storage drive in the storage tray, check that you have inserted the SATA storage drive correctly.

6. Use the protection key to lock the storage tray cover and secure the SATA storage drive in place.
7. To install the second SATA storage drive, repeat steps 1 to 6. Make sure that you have securely fastened the door lever.

If you are installing only one SATA storage drive in the MPC-2000 series, install the storage drive in the slot nearer to the display panel. If you are installing two SATA storage drives, install the first storage drive in the slot nearer to the display panel and the second storage drive in the other slot.

8. To remove a storage drive, pull out the lever and push the tray door to the side to eject the SATA storage drive from the slot; then, remove the SATA storage drive from the computer.



On the MPC-2190

To install a SATA storage drive in an MPC-2190 panel computer, complete the following steps:

1. Remove the seven screws on the back of the MPC-2190.

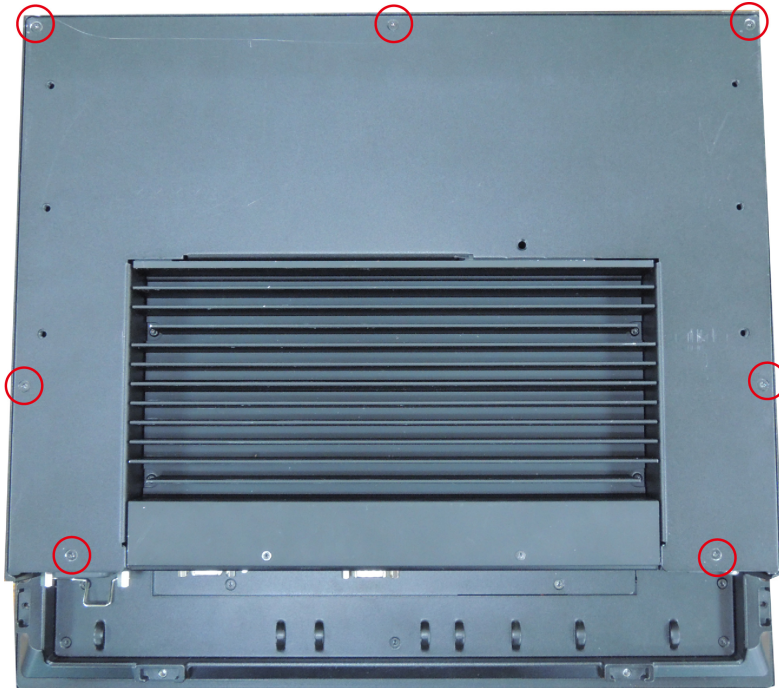

2. Remove the back cover of the MPC-2190 and locate the four screw holes (as indicated in the following figure) for the storage drive.

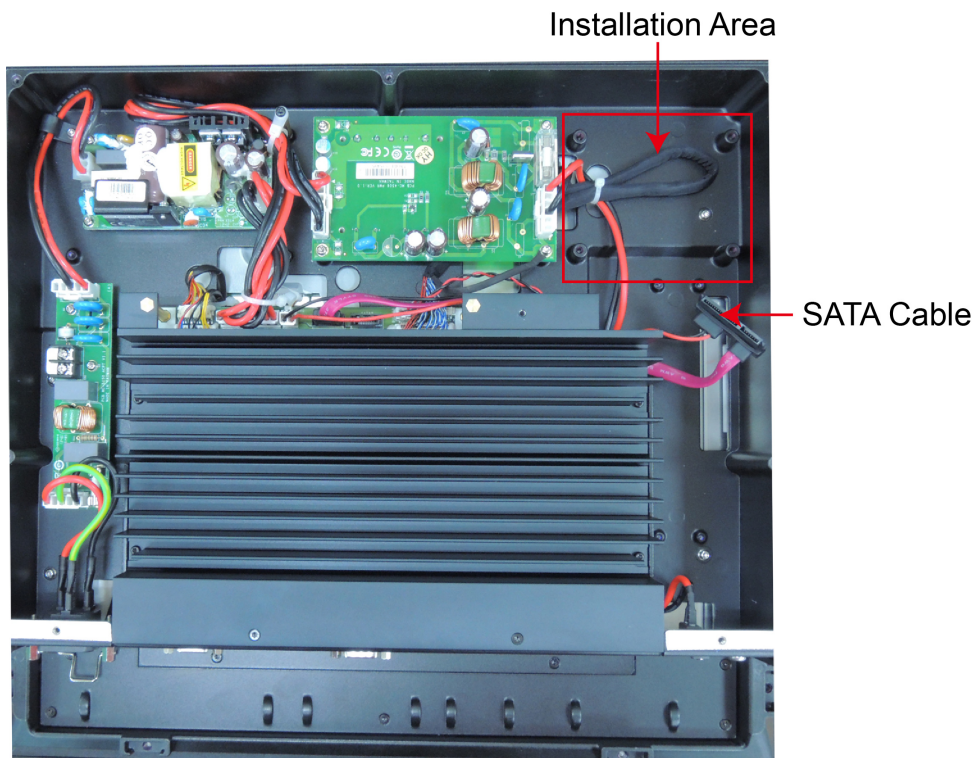

3. Use the screws to attach the brackets to the sides of the storage drive (HDD or SSD).

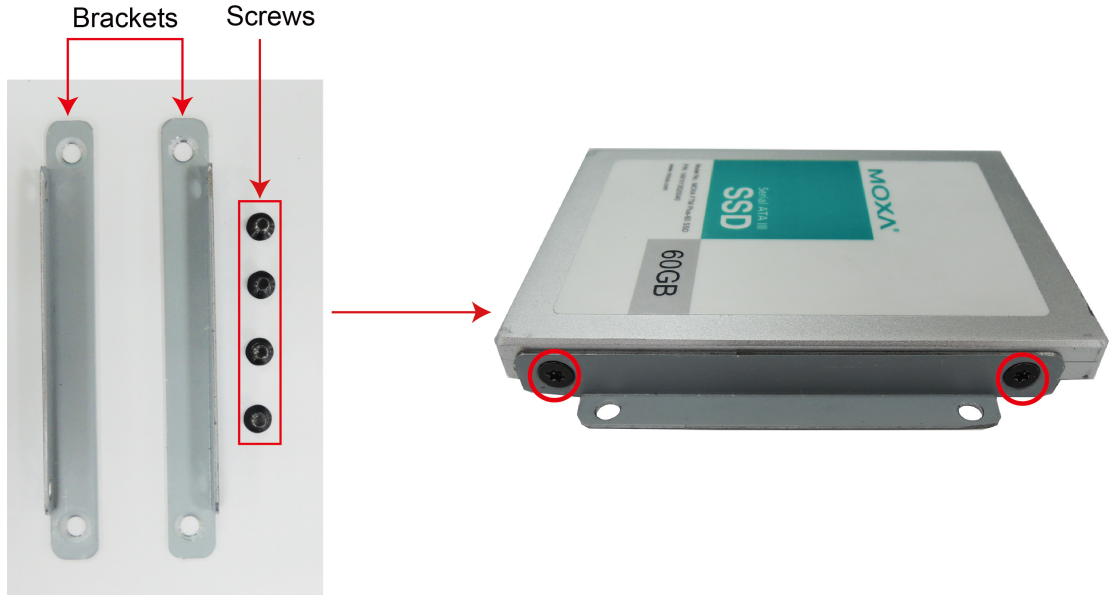

4. Align the screw holes on the brackets with the screw holes in the installation area; then, install the screws to secure the storage drive in place as shown in the following figure.
5. Connect the SATA cable to the storage drive.



6. Re-install the cover of the MPC-2000 series and fasten the screws to secure the cover in place.

NOTE To fasten the screws on the cover of the MPC-2000 series, we recommend that you use a T10 Trox (Star) screwdriver with a torque of 4.5 kgf-cm.

Driver Installation and Configure

This chapter describes how to install the VGA driver and the touch screen driver for touch screen models. After installing the drivers, you can use the software tools to adjust display resolution and touch screen features on the MPC-2000 series.

The following topics are covered in this chapter:

- ❑ **Installing the VGA Driver**
- ❑ **Setting Display Resolution**
- ❑ **Installing the Touch Screen Driver**
- ❑ **Performing Screen Calibration**
- ❑ **MPC-2260 MxGeneralIo Driver Installation**
 - Installing the MxGeneralIo Driver
- ❑ **MPC-2260 UART Driver Installation**
 - Installing the UART Driver

Installing the VGA Driver

The steps below describe how to install the MPC-2000 series VGA driver for Windows Embedded Standard 7. After you install the VGA driver, you can configure the display resolution settings using the utility provided by Intel.

1. On the software CD that came with your MPC-2000 series, go to the [CD drive]\Driver\Win7\[32-bit or 64-bit]\2.VGA folder.

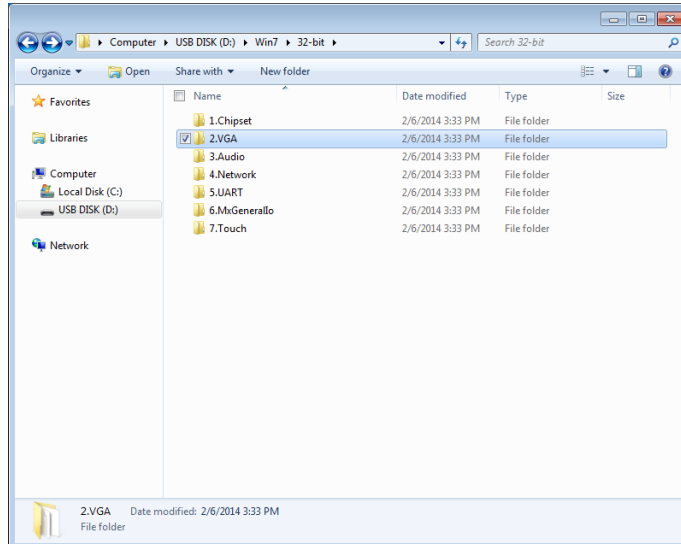

2. Double-click **Win32_15319**.

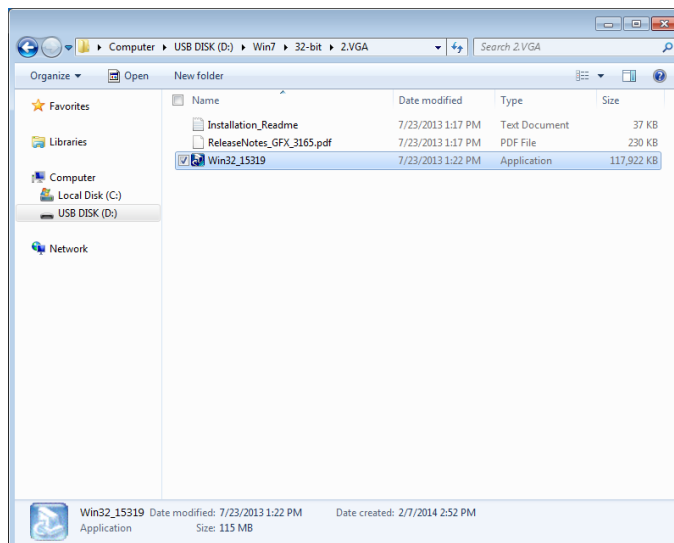

3. The installation wizard screen appears. Click **Next** to continue.

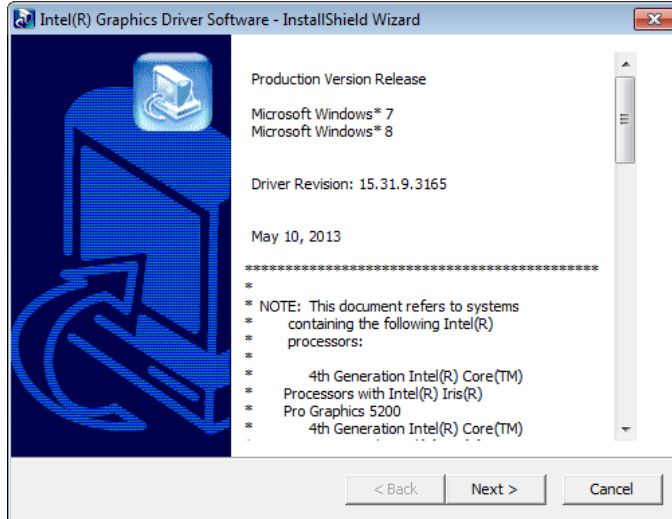

4. Click **Next** to start the installation.

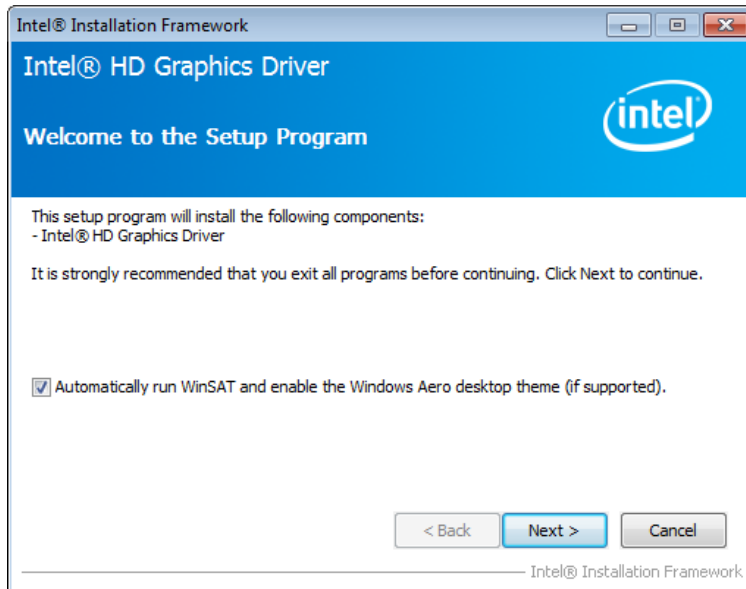

5. Click **Yes** for the license agreement.

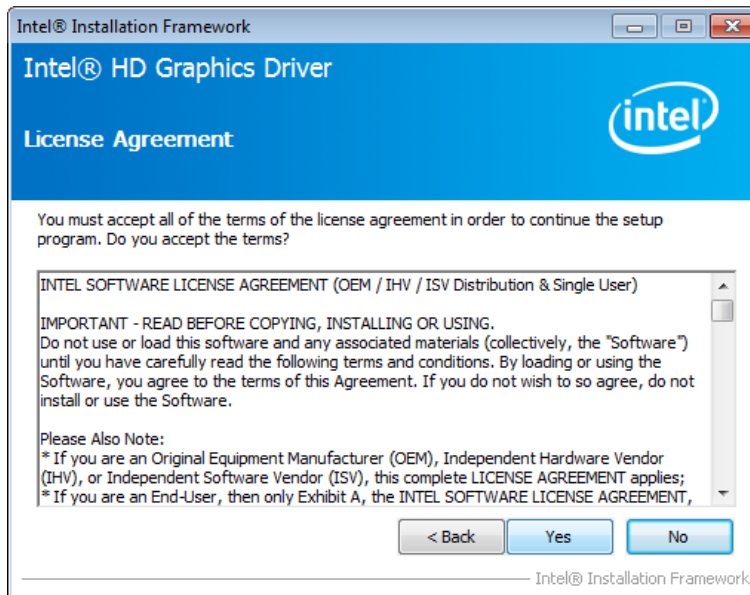

- 6. Click **Next** to continue.

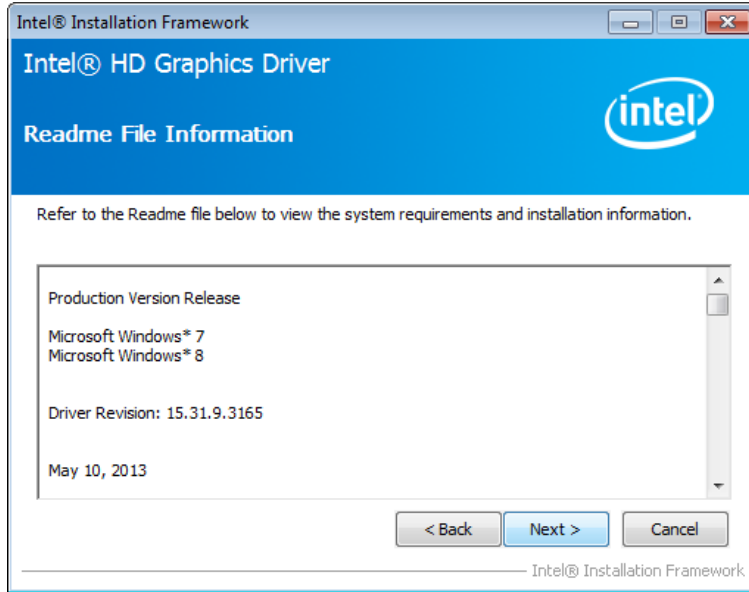

- 7. Wait until the installation process is complete.

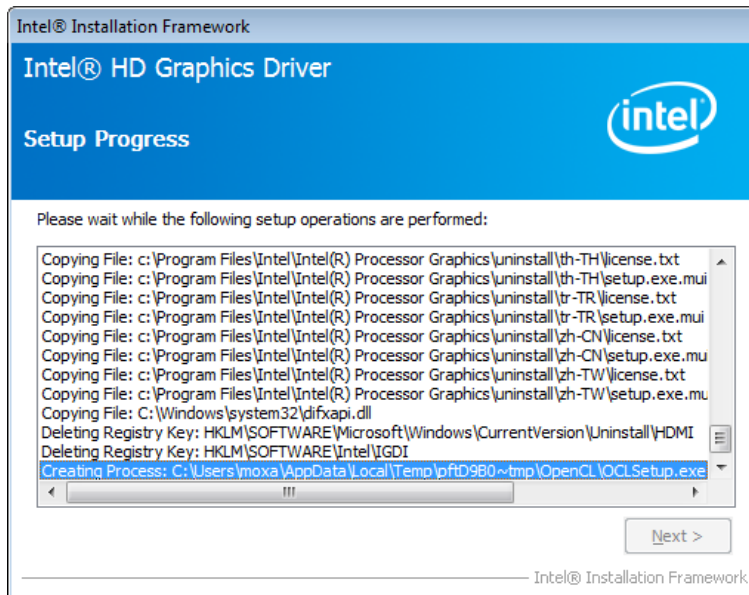
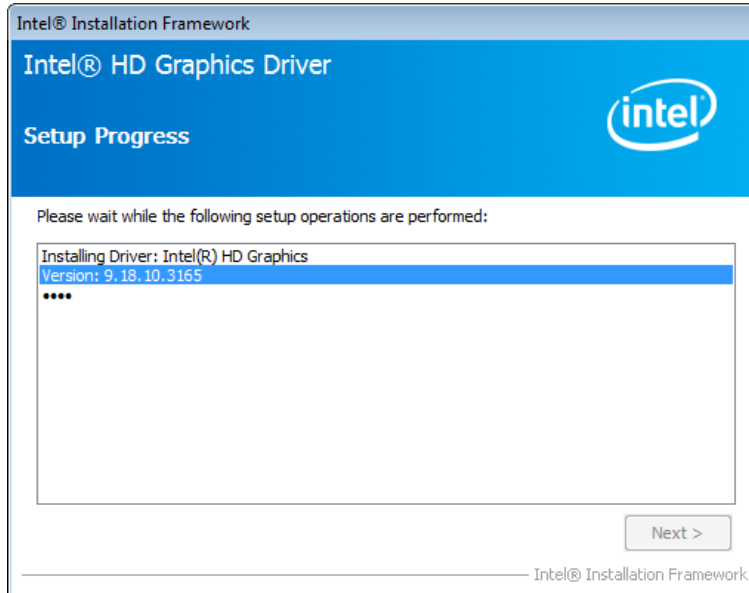

8. Click **Next** to continue.

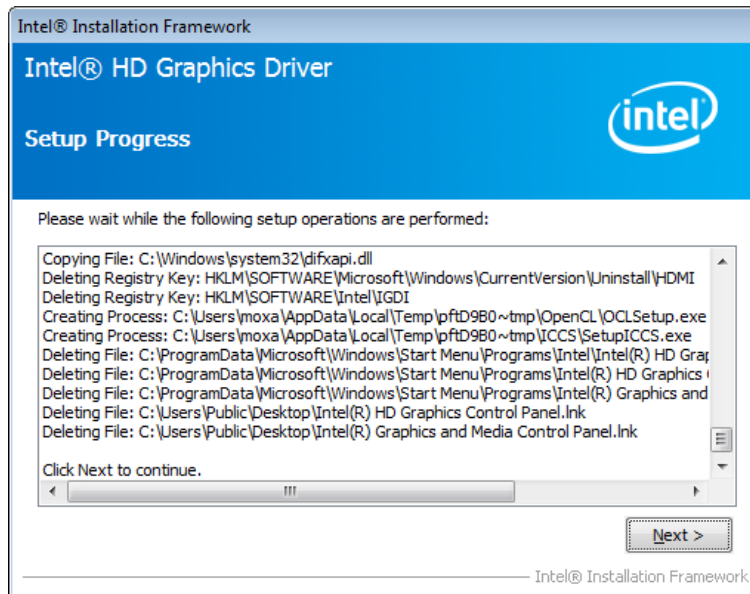

9. Select **Yes** to restart the computer and click **Finish** to complete the VGA driver installation.

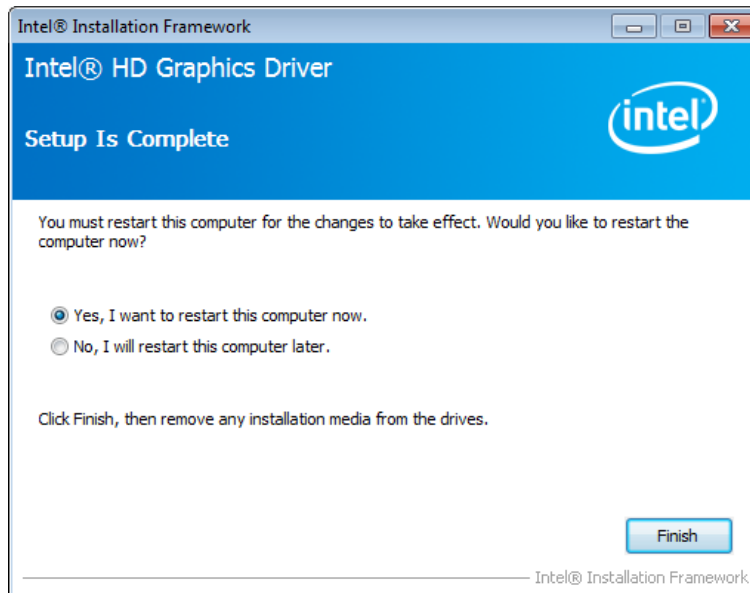

10. The MPC-2000 series will automatically restart.

Setting Display Resolution

Follow these steps to adjust the display resolution.

1. Right-click the **Intel HD Graphics Control Panel** icon on the taskbar and select **Graphics Properties**.

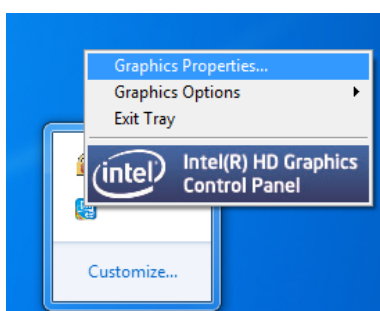

- 2. Select **Display**.

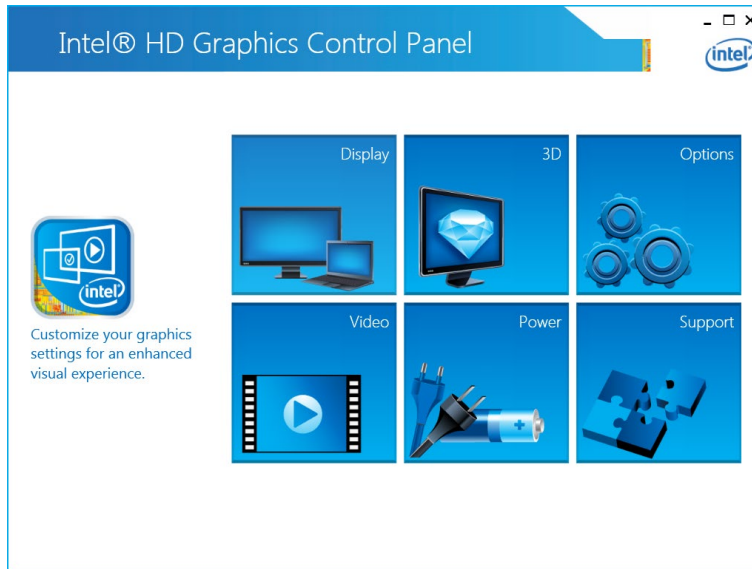

- 3. You can make changes to the screen resolution, refresh rate, and image rotation. Make sure that you select **Maintain Display Scaling** to maximize the display to fit the screen. Click **Apply** to save the changes.

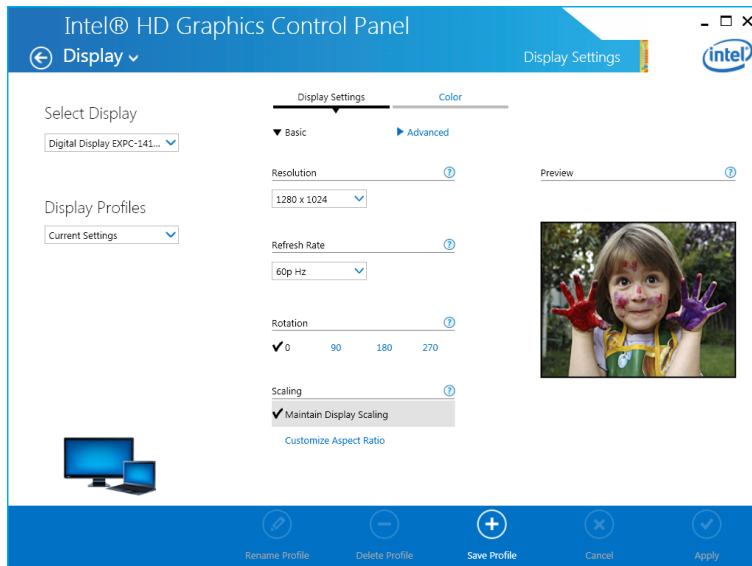

- Click **Customize Aspect Ratio** to set the aspect ratio. To configure, adjust the image by moving the scrolling bars.

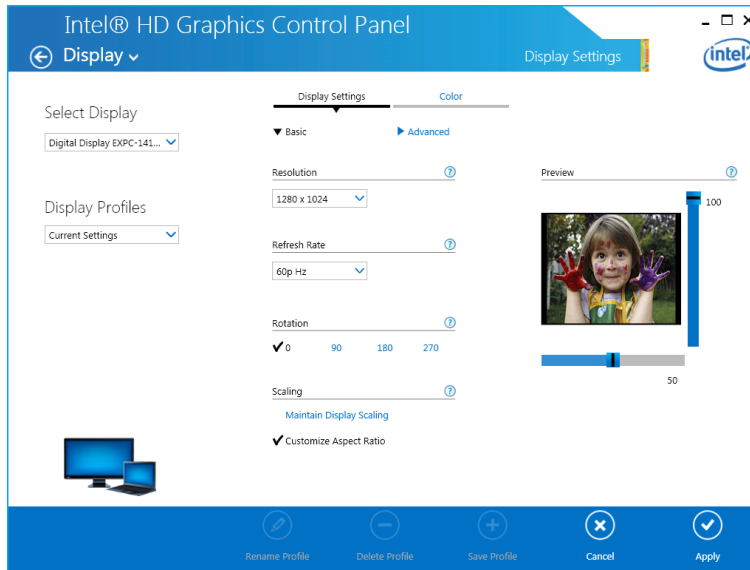

- Click **Apply** to save the changes.

Installing the Touch Screen Driver

For touch screen models, you must install the driver for the touch function.

- On the software CD, go to the [CD drive]\Driver\7.Touch**eGalaTouch_7_Vista_XP_2K_5.11.0.9126\eGalaxTouch_5.11.0.9126** folder.

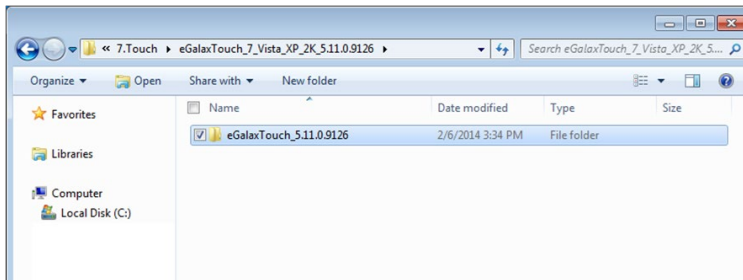

- Double-click **setup** to start the installation.

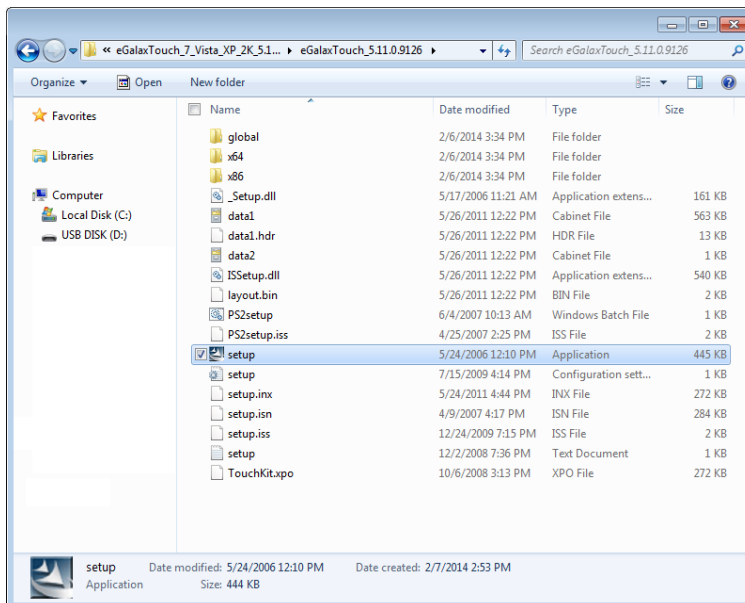

3. Click **Next** to continue.

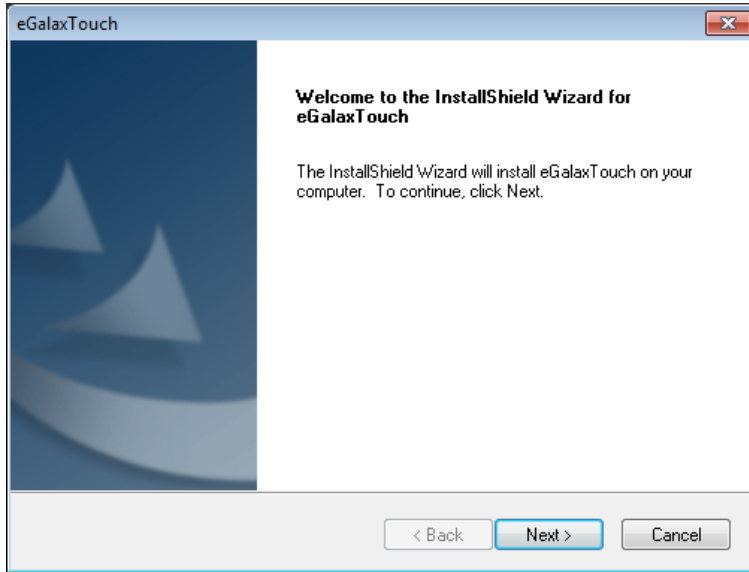

4. Clear the **Install PS/2 interface driver** check box and click **Next**.

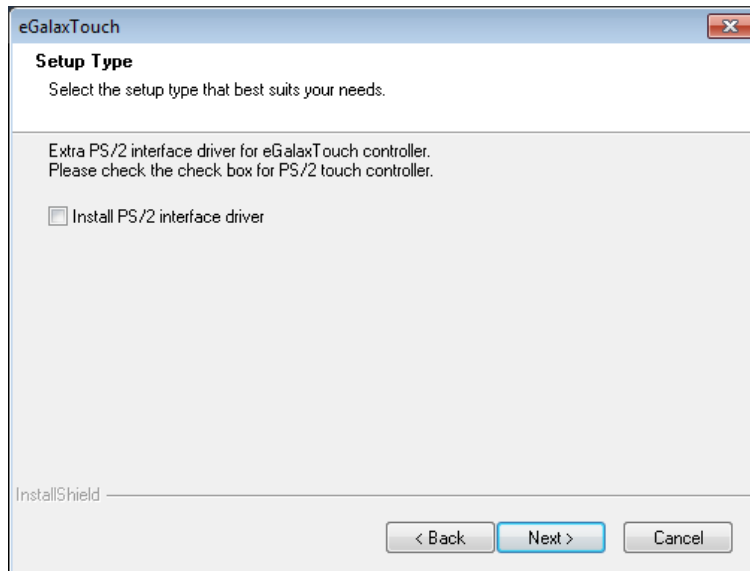

5. Select **Install RS232 interface drive** and click **Next**.

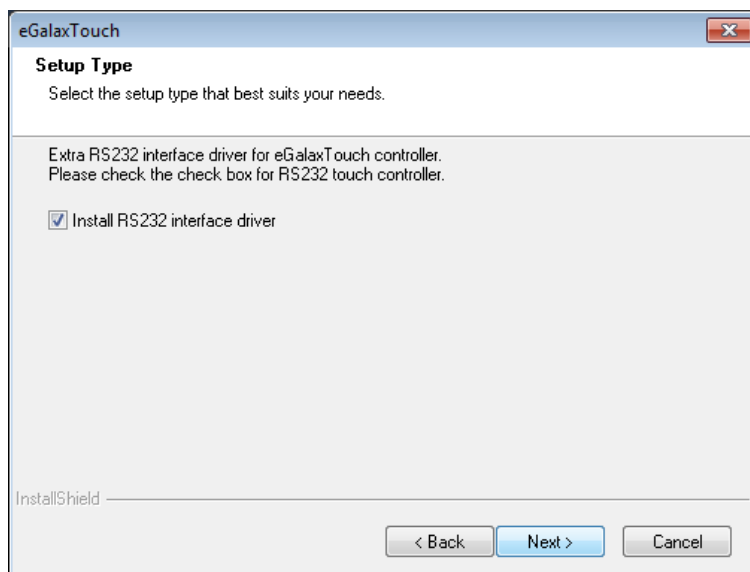

6. Select a calibration option and click **Next**.

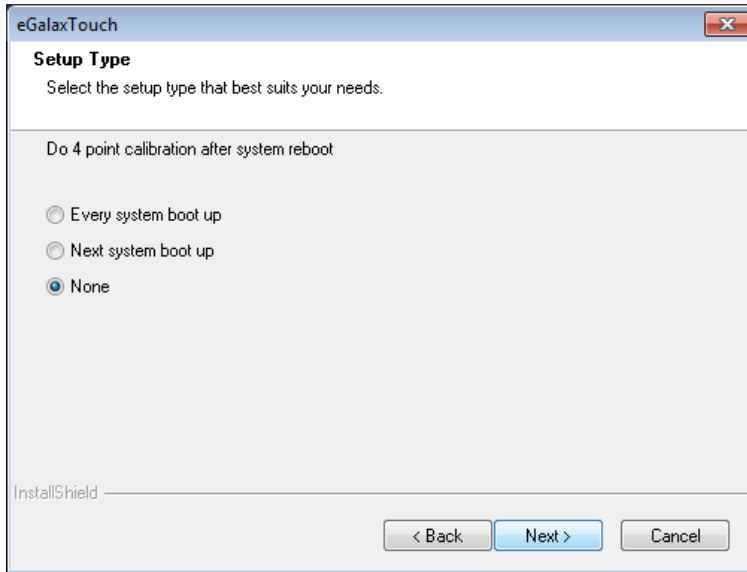

7. To enable the touch screen function, make sure that your touch controller's USB cable is connected to the MPC-2000 series. Click **OK** to continue.

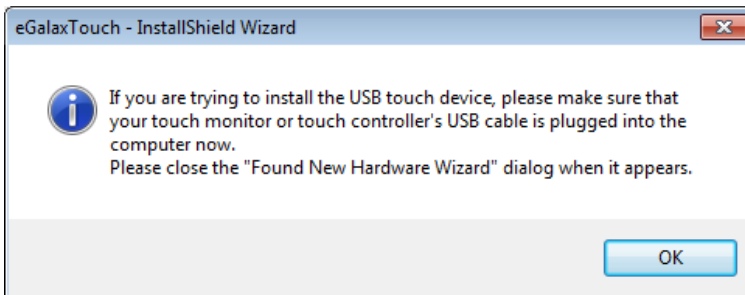

8. If required, select **Support Multit-Monitor System**. Click **Next** to continue.

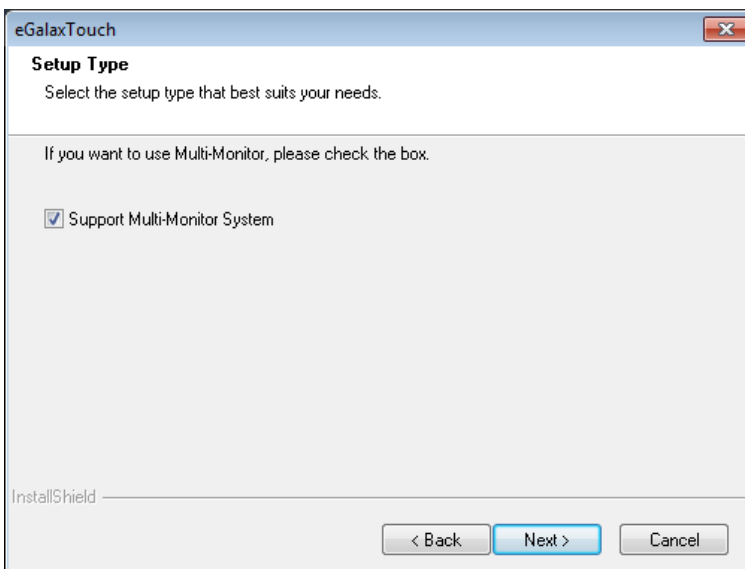

9. Accept the default destination folder or click **Browse** to choose one; then, click **Next**.

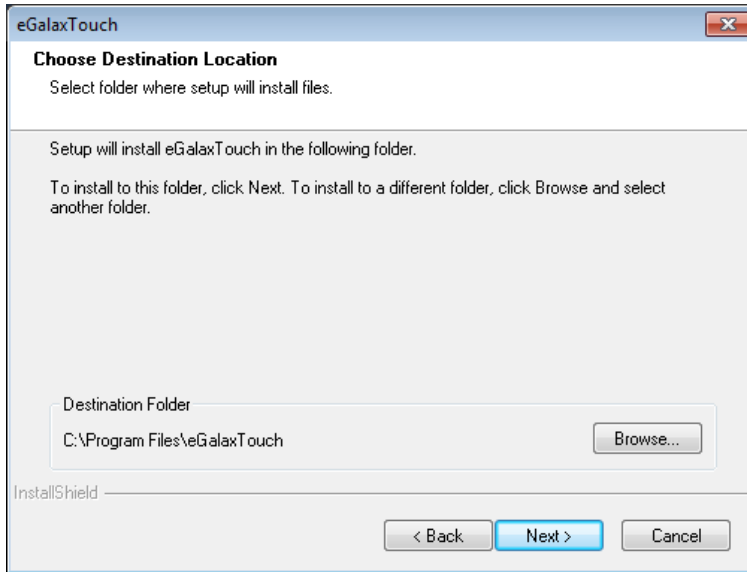

10. Click **Next** to continue.

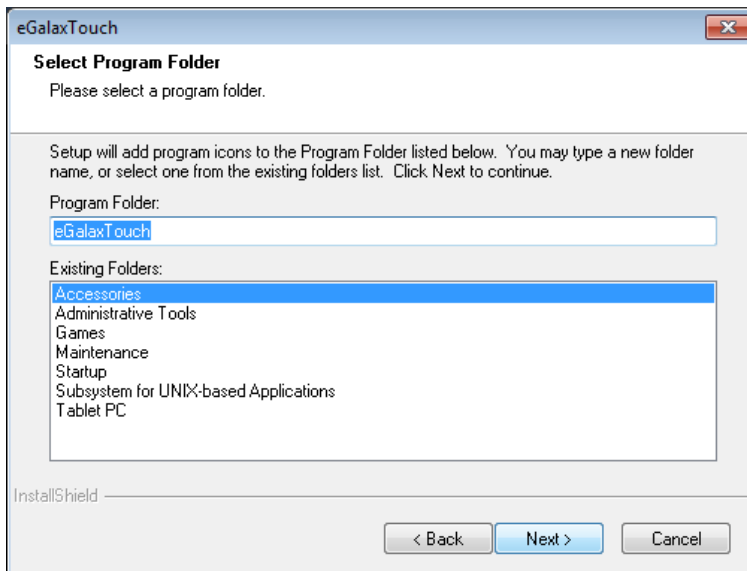

11. If you want, select **Create a eGalaxTouch Utility shortcut on desktop**. Click **Next** to continue.

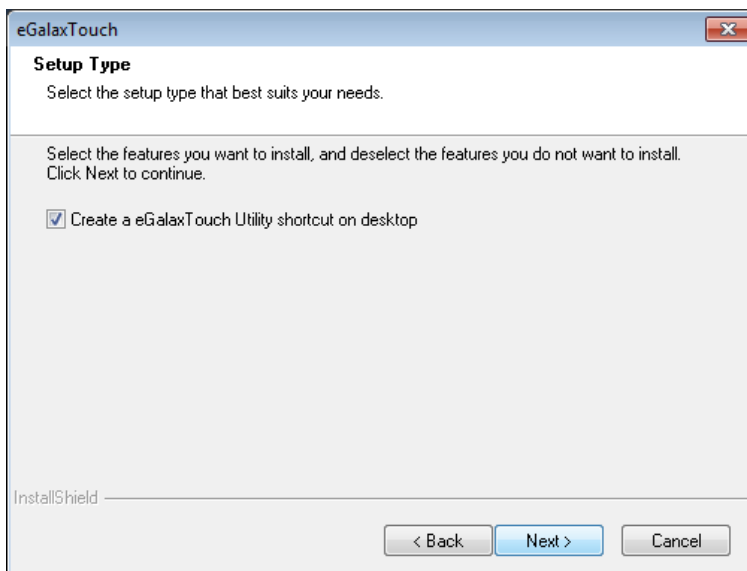

12. Wait until the installation is complete.

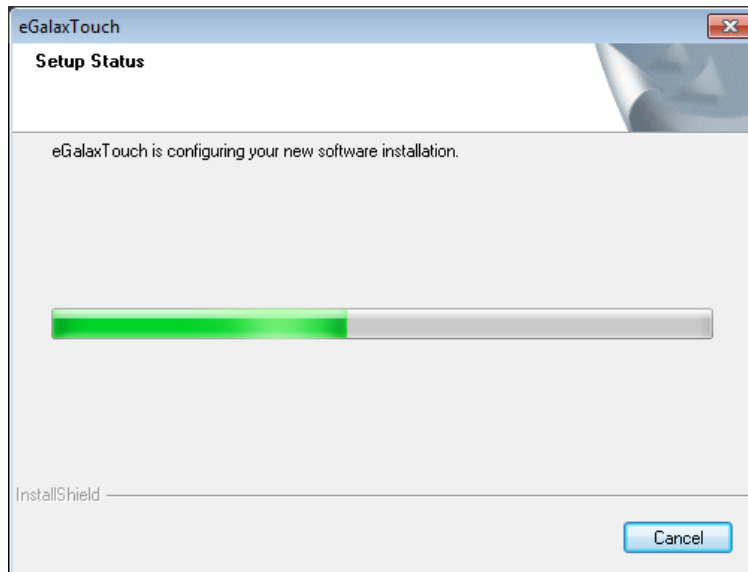

13. Click **Yes** to perform 4 points calibration.

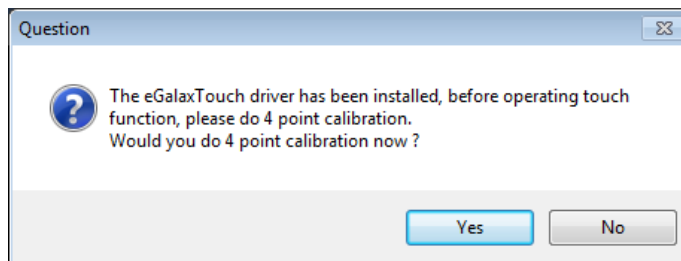

14. The system displays a circle at each corner of the screen. Touch the center of the circle until the screen displays **OK**. Repeat this step until you have touched a circle in each corner.

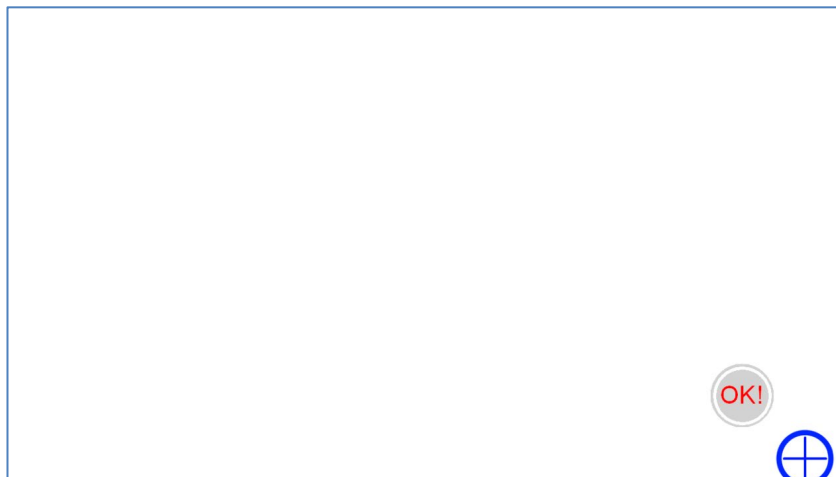

15. Click **OK**.

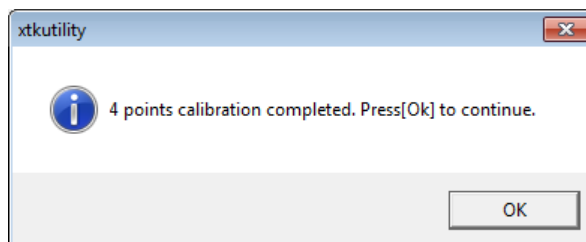

Performing Screen Calibration

Note that you have to do 4 points calibration each time you change the display resolution. This enables the touch function to work properly.

To perform 4 points calibration, complete the following steps:

1. Double-click the **eGalaxTouch** icon on the desktop.



2. The **eGalaxTouch** screen appears. Select the **Tools** tab and click **4 Points Calibration**.

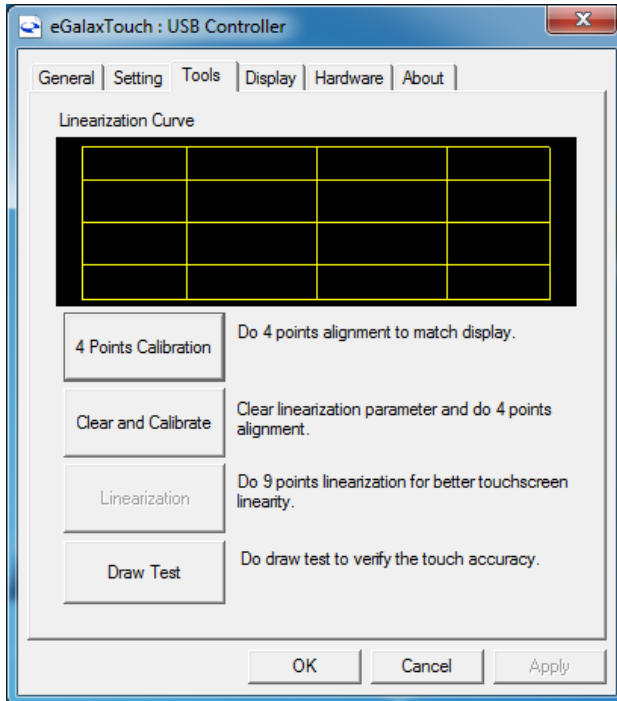

3. The system displays a circle at each corner of the screen. Touch the center of the circle until the screen displays **OK**. Repeat this step until you have touched a circle in each corner.



4. Click **OK** to complete the calibration.

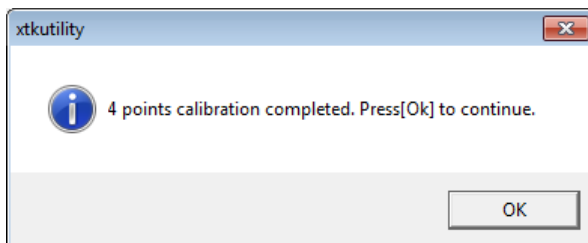

MPC-2260 MxGeneralIo Driver Installation

Installing the MxGeneralIo Driver

1. Run the executable program **MxGeneralIo_W7_x64.exe**.

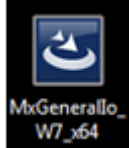

2. Click **Next**.

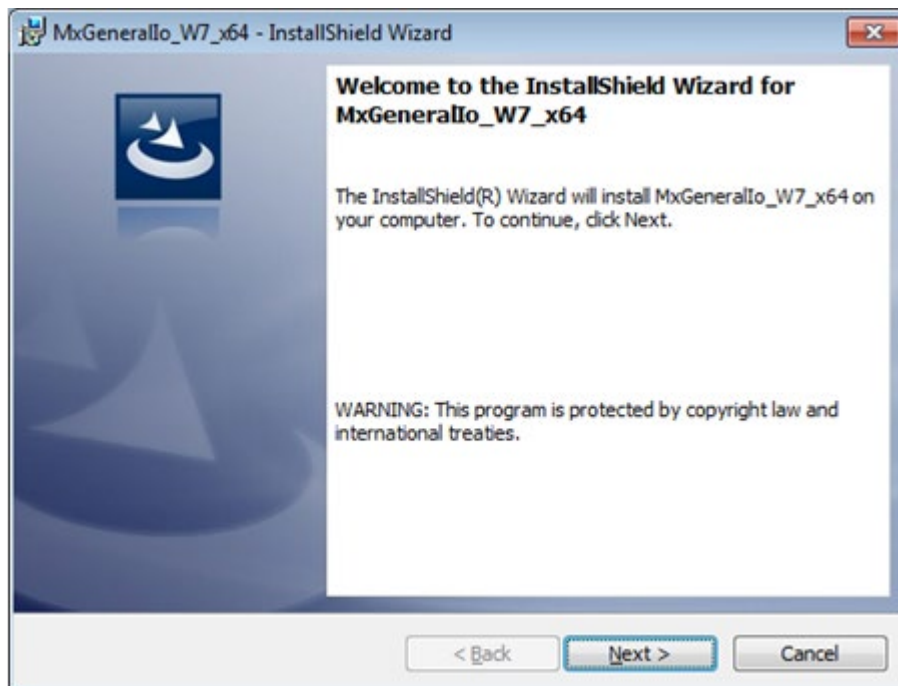

3. Click **Install**.

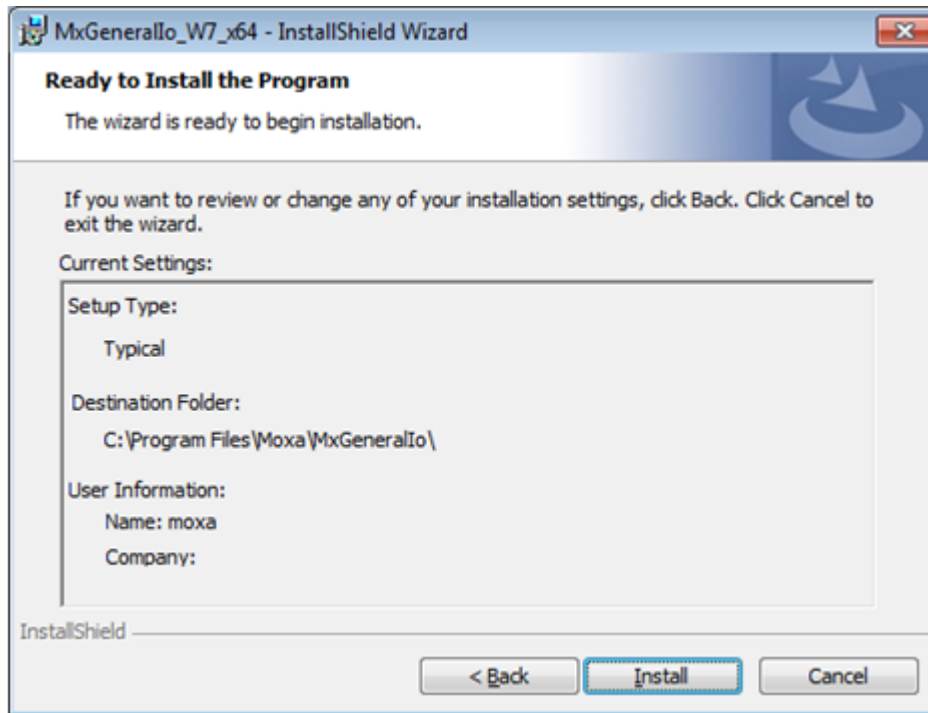

4. Click **Finish**.

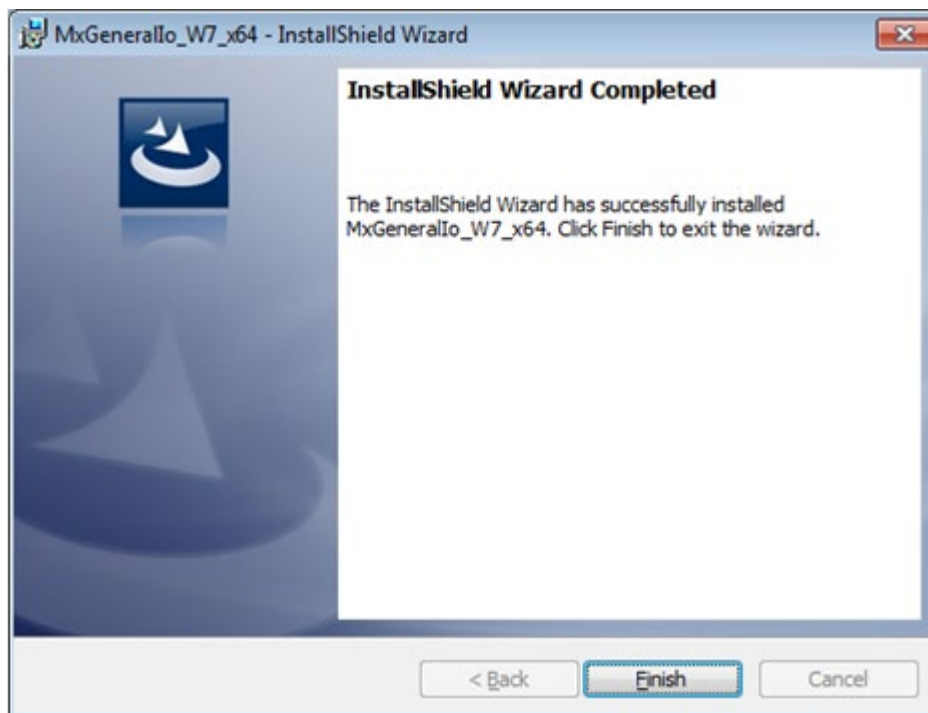

5. Check your computer’s Device Manager to verify that **MxGeneralIo PortIO Driver (KMDF)** was installed correctly.

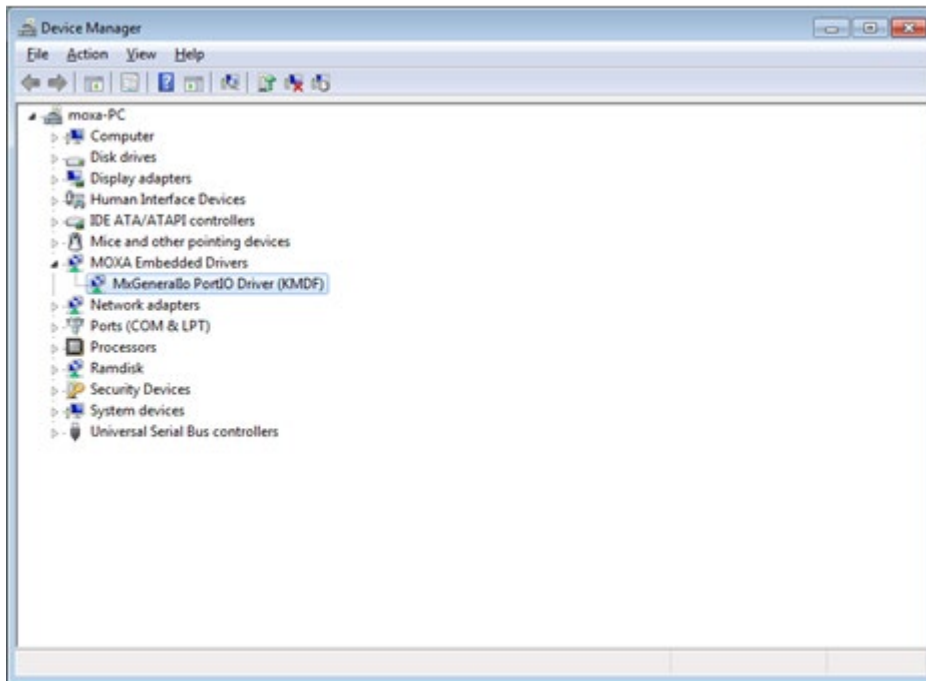

MPC-2260 UART Driver Installation

Installing the UART Driver

1. Run the executable file **MSSetup_QUADPORT.exe**, located in the **MCS7840_7820_Win7_64bit_driver_v1.4.7.19_WHQL** folder.

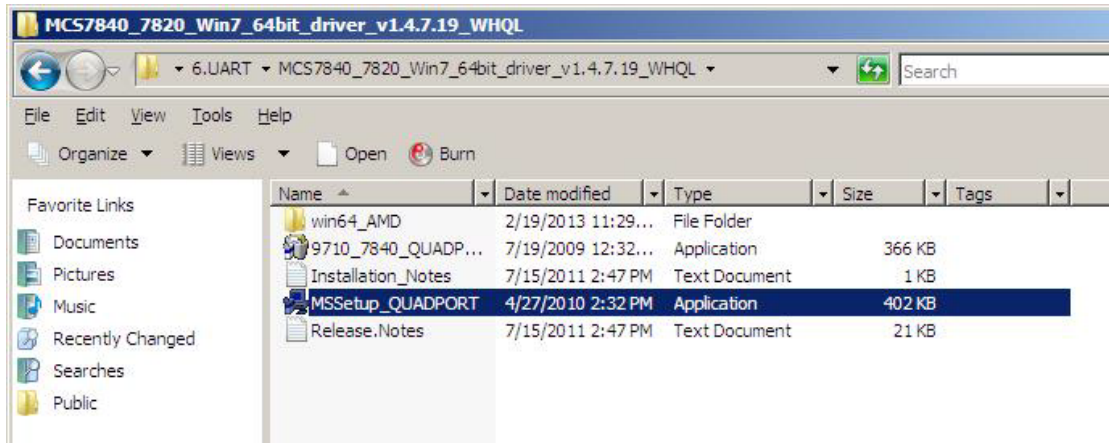

2. Click **Install**.



3. Click **Exit**.



4. Right-click **Unknown device** and select **Update Driver Software....**

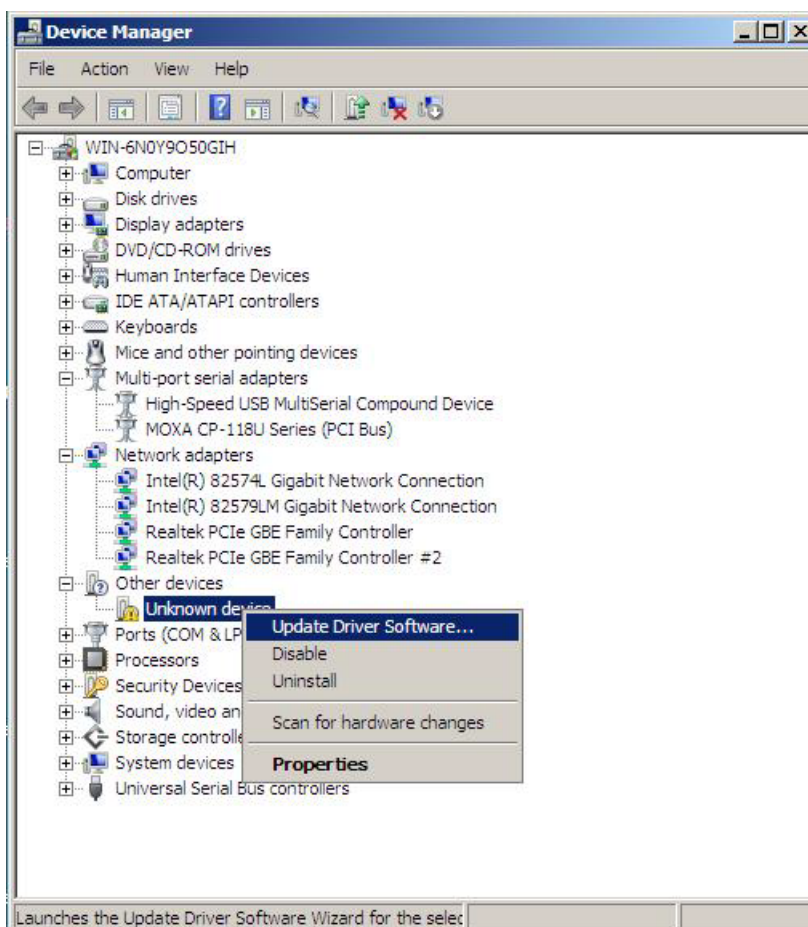

5. Select **Search automatically for updated driver software**.

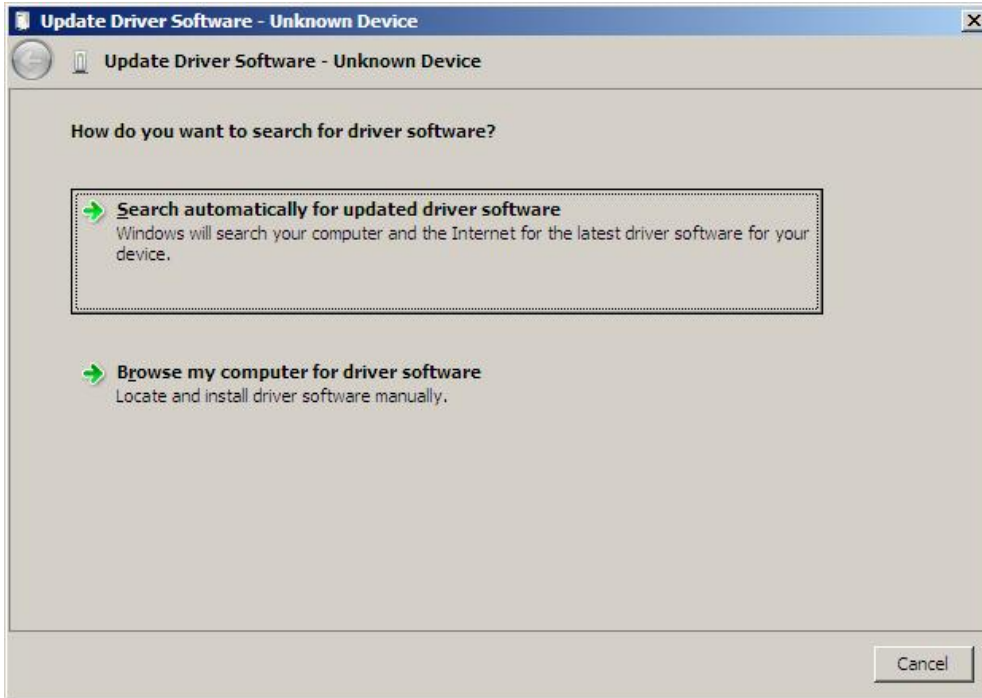

6. Select **Don't Search online**.

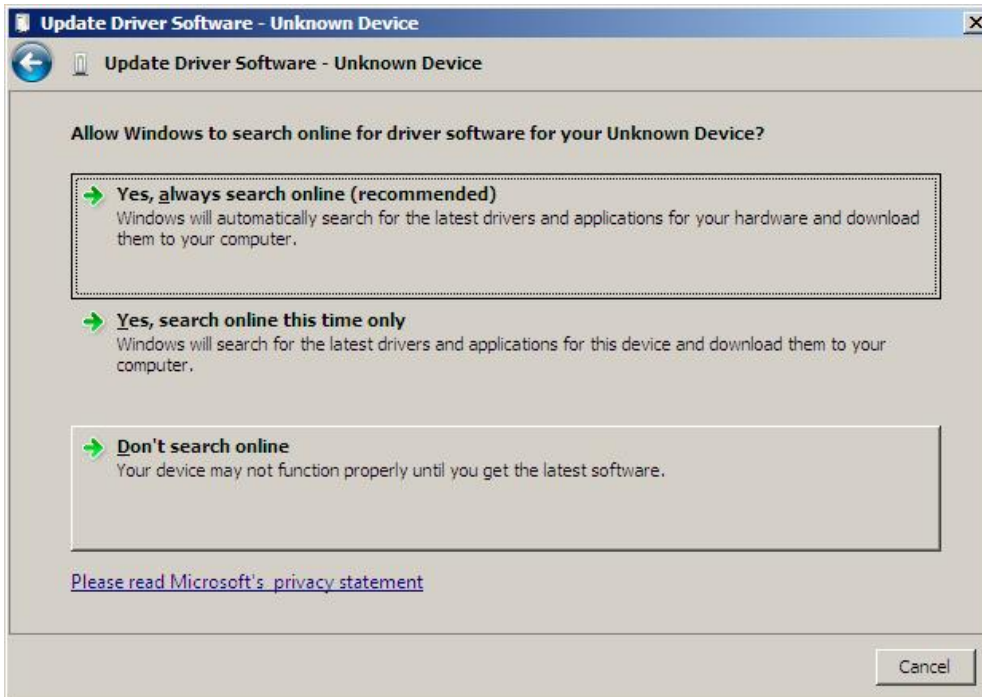

7. Click **Close**.



This chapter describes the BIOS settings of the MPC-2000 series marine panel computer. The BIOS is used to initialize basic peripherals and helps boot the operating system before the operating system is loaded. You can access the BIOS setup screens to change the configurations of these basic input/output peripherals. The configuration information is stored in the battery-backed up CMOS RAM, which retains the system information after the system reboots or when the power is disconnected.

The following topics are covered in this chapter:

❑ **Entering the BIOS Setup Utility**

❑ **Main Information**

❑ **Advanced Settings**

- Boot Configuration
- Peripheral Configuration
- HDC Configuration
- Video Configuration
- Chipset Configuration
- Hardware Monitor

❑ **Security Settings**

- Set Supervisor Password

❑ **Power Settings**

❑ **Boot Settings**

- Boot Type
- EFI Device First
- Boot Delay Time
- Legacy

❑ **Exit Settings**

- Exit Saving Changes
- Save Change Without Exit
- Exit Discarding Changes
- Load Optimal Defaults
- Load Custom Defaults
- Save Custom Defaults
- Discard Changes

❑ **Upgrading the BIOS**

Starting the BIOS Setup Utility

To start the BIOS setup utility, press the **F2** key while the system is booting up. The main **BIOS Setup** screen appears. Select **SCU** to access the **BIOS Configuration** screen.

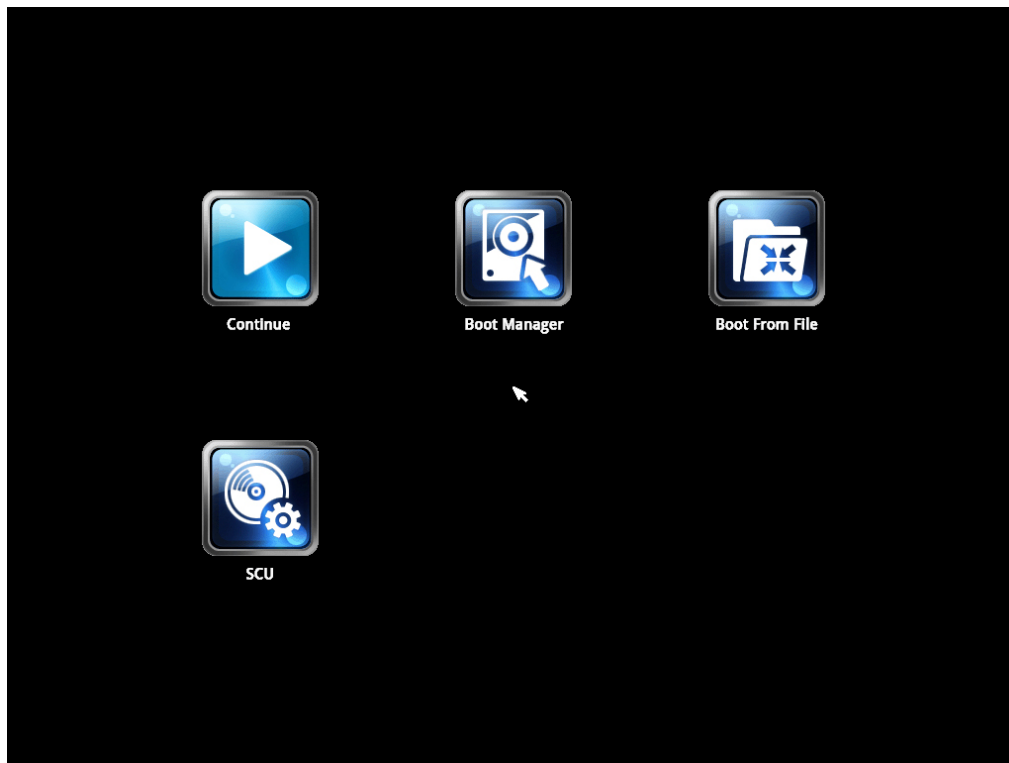

NOTE The BIOS does not support the touch screen function. You must connect a keyboard to the MPC-2000 series to configure the BIOS.

A short description of each function key is displayed at the bottom of the screen.

F1: General Help

F5/F6: Change Values

F9: Setup Defaults

F10: Save and Exit

↑ ↓: Select Item

← →: Select Menu

ESC: Exit

ENTER: Select or go to Submenu.

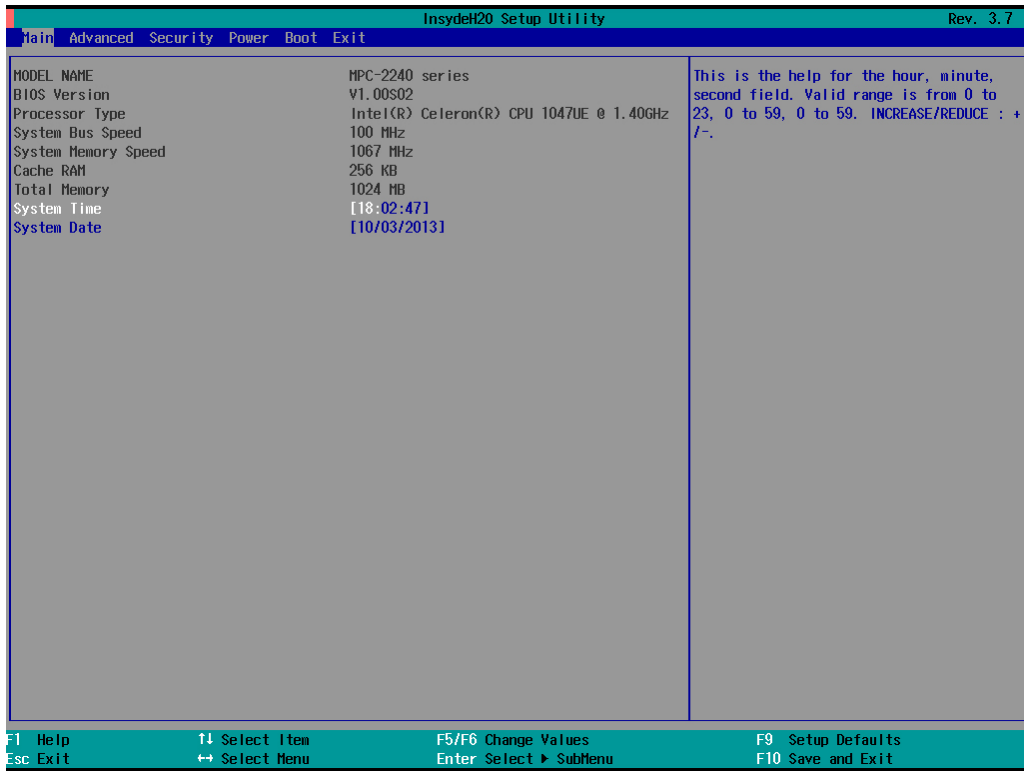

Main Information

The main page displays the system hardware information (such as the model name, BIOS version, and CPU type)

Advanced Settings

Select the Advanced tab to display the Advanced screen as shown in the following figure.

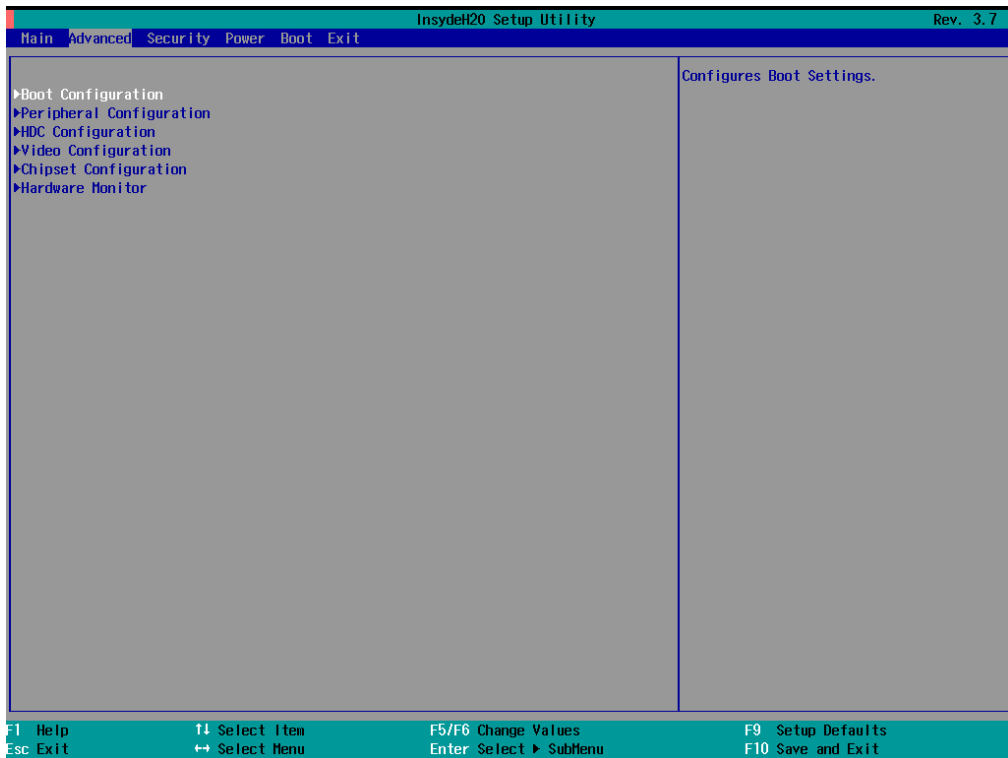

Boot Configuration

You can configure the numlock values in the Boot Configuration screen.

Option: On (default), Off.

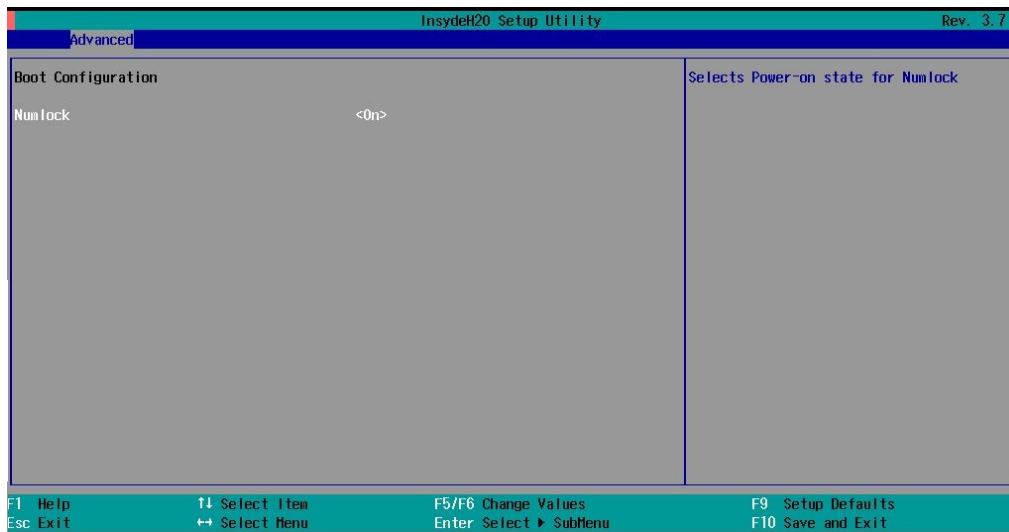

Peripheral Configuration

Use this screen to configure the parallel port.

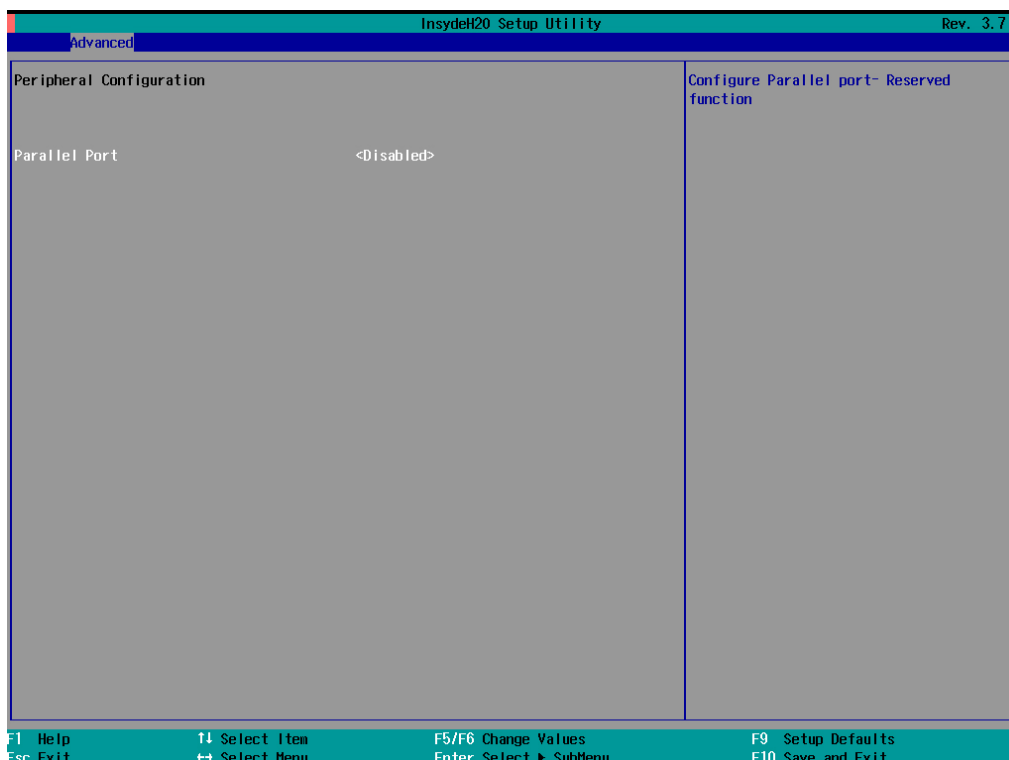

Parallel Port

This item allows you to configure the parallel port.

Options: Disabled (default), 378/IRQ7.

Mode

This setting allows you to configure the mode for the parallel port.

Options: SPP (default), EPP, ECP, EPP+ECP.

HDC Configuration

You can set the host drive controller in IDE (legacy default) or AHCI mode.

The following screen appears when you select the legacy IDE mode.

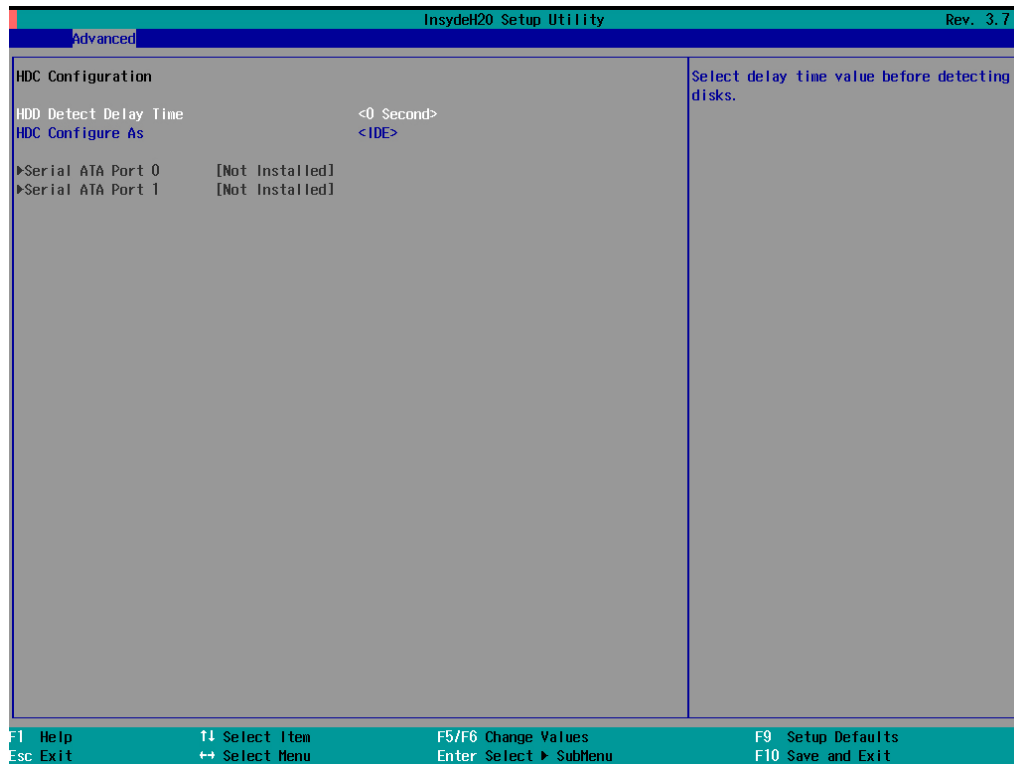

HDD Detect Delay Time

This setting allows you to set the time delay when detecting hard disks.

Option: 0 (default), 1, 2, 3 seconds.

Serial ATA Port 0 to 1

This setting allows you to display information about the installed drives.

AHCI SALP

Note that AHCI SALP only appears when you select the AHCI mode. This setting allows you to enable **Aggressive Link Power Management** (SALP) in AHCI for the host bus adapter to conserve power by detecting when a SATA drive is no longer processing information and then immediately setting it to suspended or sleep mode without waiting for the software to initiate power-down processes. Host Capability Register bit 26.

Options: Enabled (default), Disabled.

SATA Port 0 to 1 - HotPlug

This item allows you to enable/disable hotplug capabilities (the ability to remove the drive while the computer is running) for installed storage drives.

Options: Disable (default), Enabled.

Video Configuration

This item allows you to configure the internal graphics device (IGD) for things like memory allocation (**DVMT**) and monitor types (**Boot Type**).

Internal Graphics Device

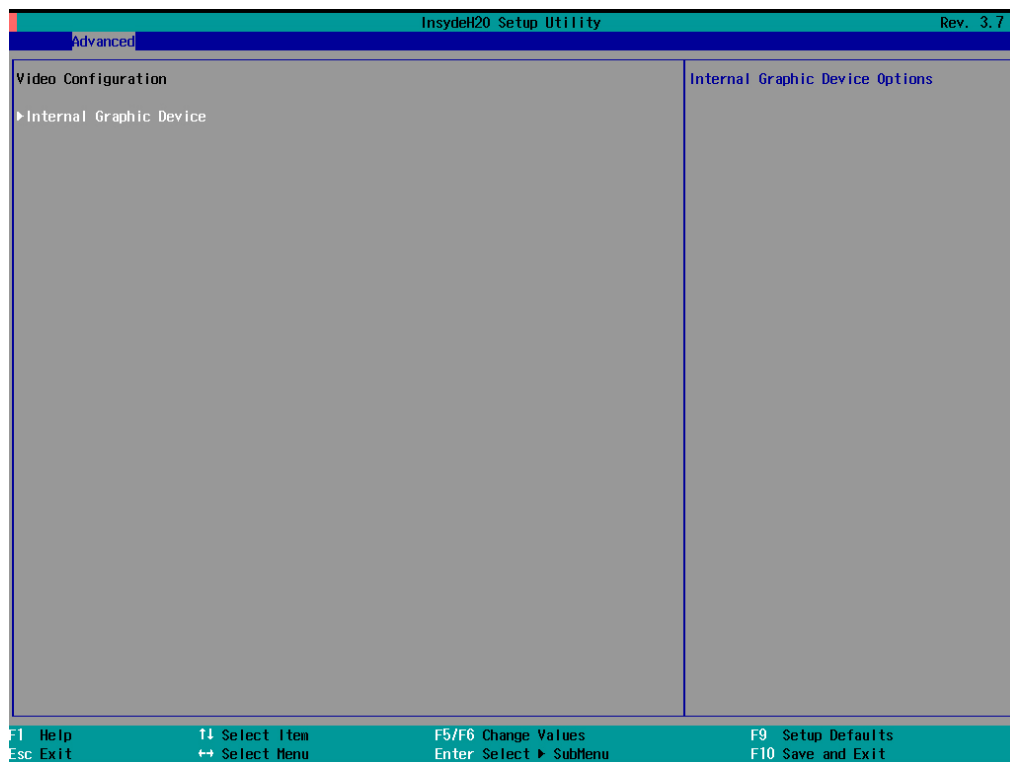

IGD—DVMT Pre-Allocated

This item allows you to configure pre-allocated memory capacity for the IGD. Pre-allocated graphics memory is invisible to the operating system.

Options: 64 MB (default), 32 MB, 96 MB, 128 MB, 256 MB, 512 MB.

DVMT is a BIOS solution where “the optimum amount of memory is dynamically allocated and de-allocated as needed for balanced graphics and system performance, through Intel® Direct AGP and a highly efficient memory utilization scheme. DVMT ensures the most efficient use of available system memory resources for maximum 2D/3D graphics performance.

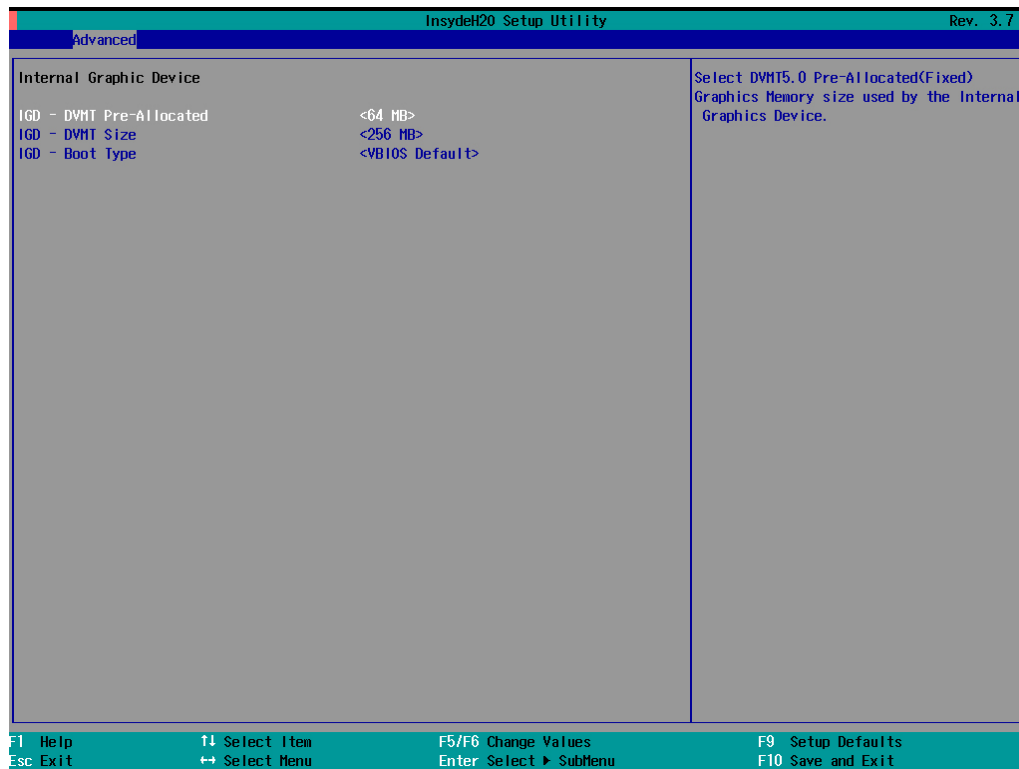

IGD—DVMT Size

This item allows you to configure the maximum amount of memory DVMT will use when allocating additional memory for the internal graphics device.

Options: 256 MB (default), 128 MB, Max.

IGD – Boot Type

This item allows you to select the video device which will be activated during POST.

Options: VBIOS Default (default), VGA, DVI, Integrated Panel.

Chipset Configuration

This item allows you to configure the chipset settings.

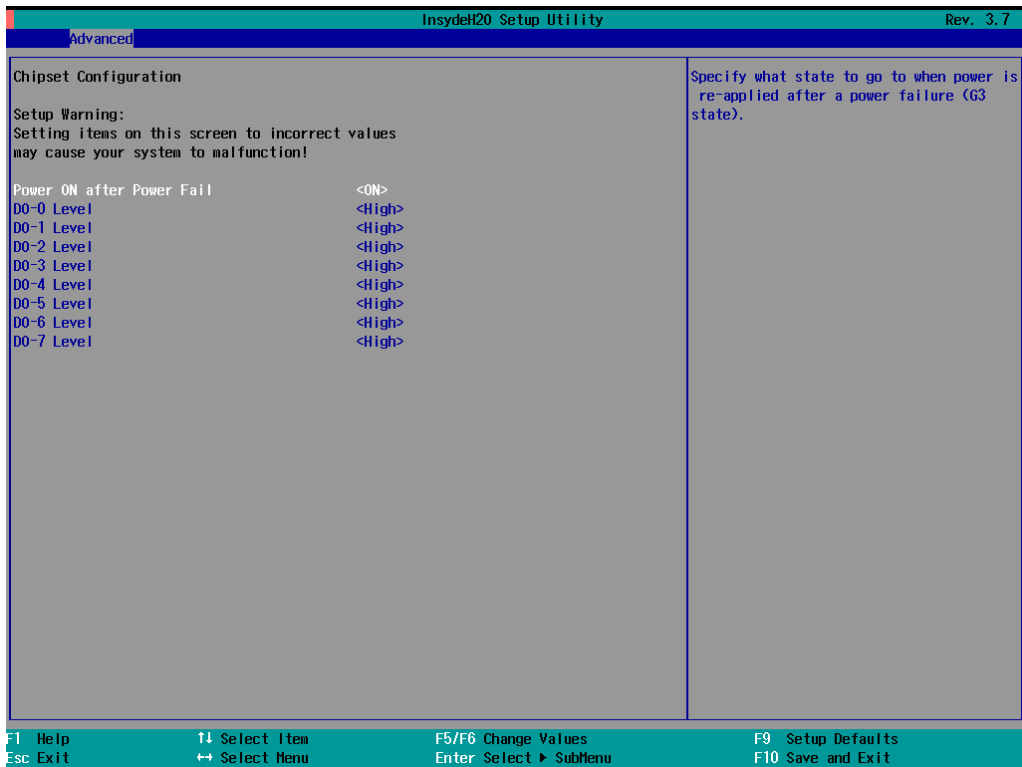

Power ON after Power Fail

This item allows you to enable/disable the computer from automatically powering up after a system crash.

Options: ON (default), OFF, Last State.

DO Level

This item allows you to set the DO default level.

Hardware Monitor

This item allows you to view stats like CPU and system temperature, voltage levels, and other chipset information.

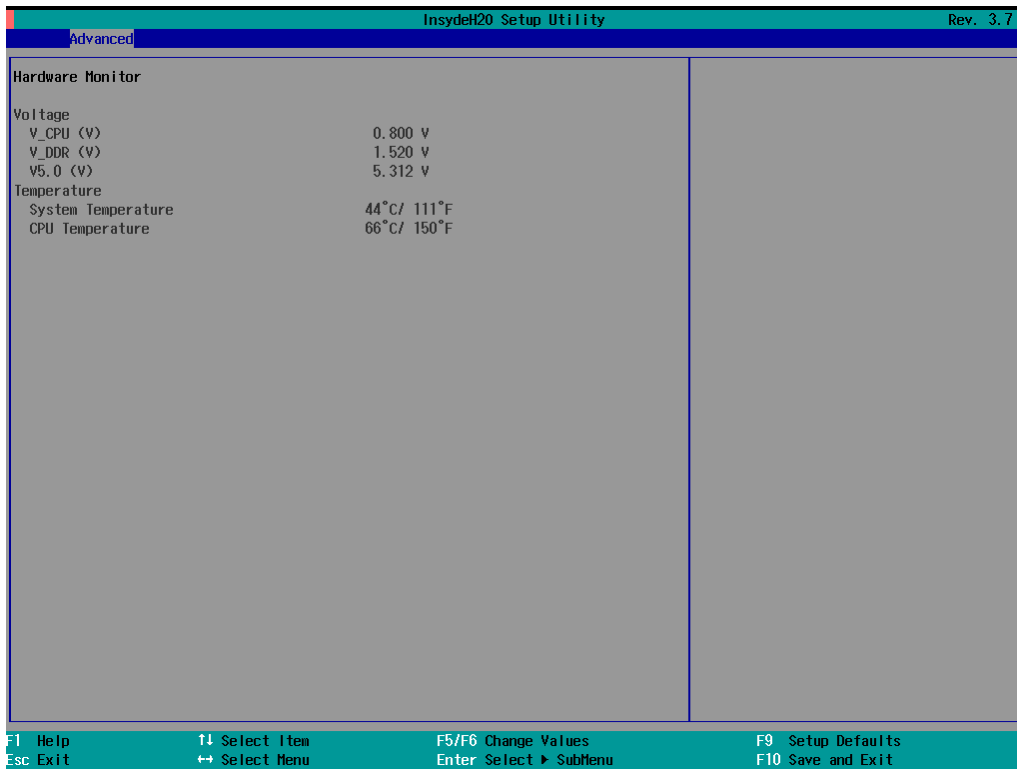

Security Settings

This section allows users to configure security settings with a supervisor password.

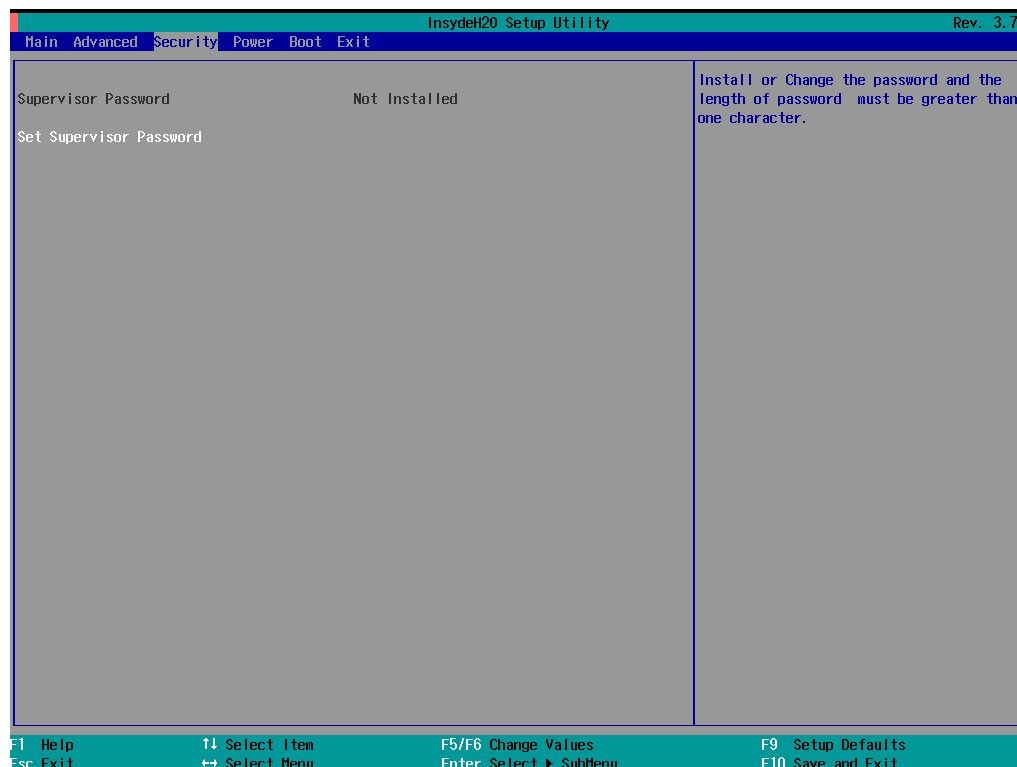

Set Supervisor Password

This item allows you set the supervisor password. Select and then enter the password, and then confirm the password again.

To delete the password, enter **Set Supervisor Password** and then enter the old password; then, leave the new password fields blank, and press enter.

Power Settings

The section allows users to configure power settings.

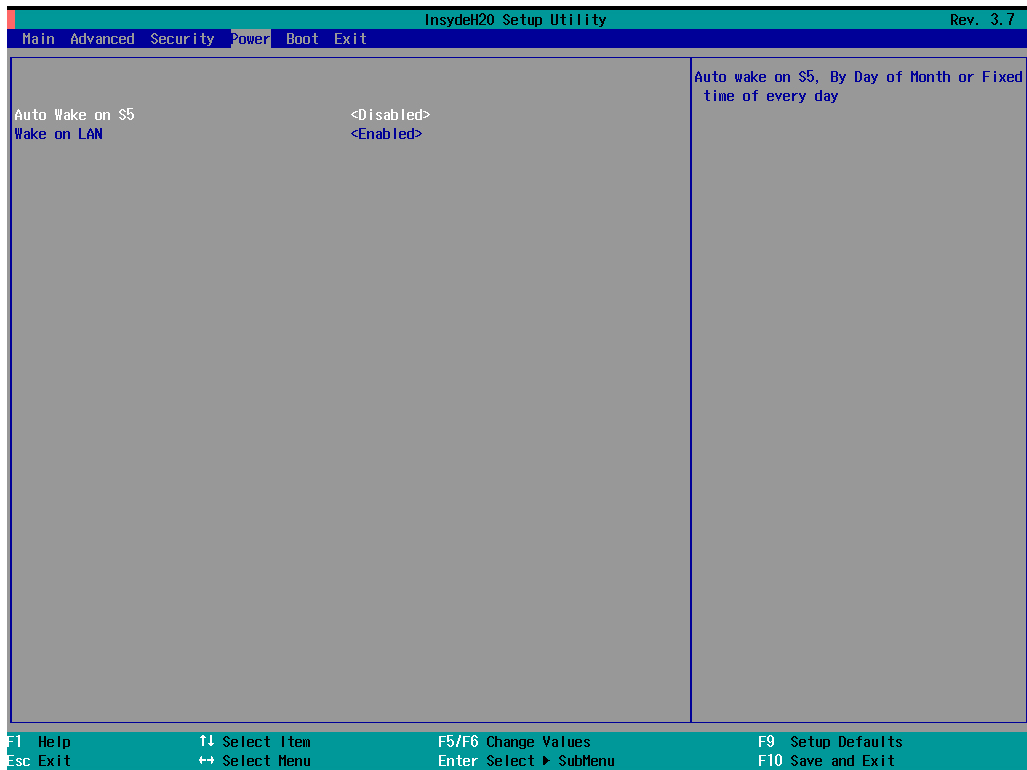

Boot Settings

This item allows you to select the BIOS support boot device type.

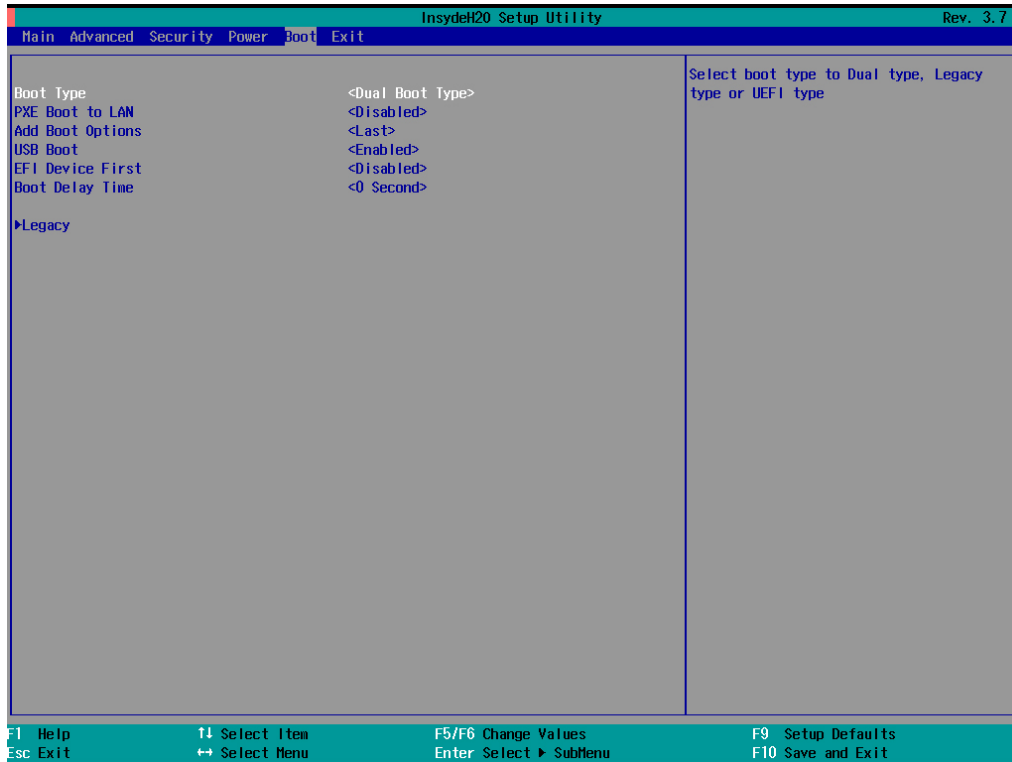

Boot Type

This item allows you to enable/disable quick boot function.

Options: Dual Boot Type (default), Legacy Boot Type, UEFI Boot Type.

PXE Boot to LAN

This item allows you to enable/disable PXE boot to LAN function.

Options: Disabled (default), Enabled.

Add Boot Options

This item allows you to add the boot order options for shell, network and Removables.

Options: Last (default), First.

USB Boot

This item allows you to enable/disable USB boot function..

Options: Enabled (default), Disabled.

EFI Device First

This item allows you to determine EFI device first or legacy device first. If enabled, EFI device will be the first; if disabled, legacy device will be the first.

Options: Disabled (default), Enabled.

Boot Delay Time

This item allows you to configure the delay time value for users to input hot key during POST time.

Options: 0 Second (default), 3 Seconds, 5 Seconds, 10 Seconds.

Legacy

Normal Boot Menu

This item allows you to configure the boot menu.

Options: Normal (default), Advance.

Boot Type Order

This item allows you to select the boot order. Use F5/F6 to change values.

Options: Hard Disk Drive (default), CD/DVD-ROM Drive, USB, Others.

Hard Disk Drive/USB Drive

This item allows you to view installed devices such as hard disk drives, USB drives, or CD-ROMs. For example, if you have inserted a USB drive into the computer, it will appear here.

Exit Settings

The section allows users to exit the BIOS environment.

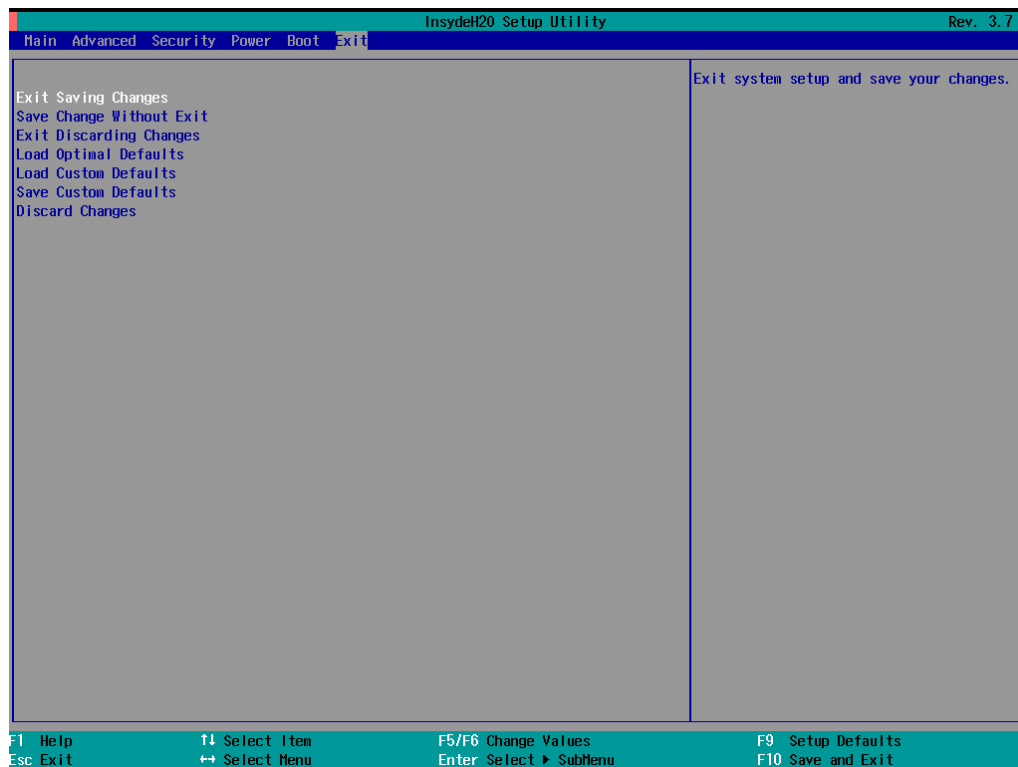

Exit Saving Changes

This item allows you to exit the BIOS environment and save the values you have just configured.

Options: Yes (default), No.

Save Change without Exit

This item allows you to save changes without exiting the BIOS environment.

Options: Yes (default), No.

Exit Discarding Changes

This item allows you to exit without saving any changes that might have been made to the BIOS.

Options: Yes (default), No.

Load Optimal Defaults

This item allows you to revert to the factory default BIOS values.

Options: Yes (default), No.

Load Custom Defaults

This item allows you to load custom default values for the BIOS settings.

Options: Yes (default), No.

Save Custom Defaults

This item allows you to save the current BIOS values as a “custom default” that may be reverted to at any time by the “load custom defaults” selection just above.

Options: Yes (default), No.

Discard Changes

This item allows you to discard all settings you have just configured.

Options: Yes (default), No.

Upgrading the BIOS

This section describes how to upgrade the BIOS. However, note that an improper BIOS update may damage the mainboard, leaving the computer unable to boot. We strongly recommend that you contact Moxa’s technical support staff to obtain the necessary tools and the most current advice before attempting to upgrade the BIOS on any Moxa devices.

Step 1: Create a Bootable USB Storage Drive

Before upgrading the BIOS, you must first create a bootable USB storage drive for system upgrade.

You may use any software that to create a bootable USB drive. We use Rufus as an example in this section.

1. Start Rufus and select the USB device from the **Device** drop-down list.
2. Select **MBR partition scheme for BIOS or UEFI computers** to boot from legacy BIOS or UEFI.
3. Select **FAT (Default)** from the **File system** drop-down list.
4. Select **16 kilobytes (Default)** from the **Cluster size** drop-down list.
5. Enter a drive name in the **New volume label** field.
6. Check **Quick format**, **Create a bootable disk using FreeDOS**, and **Create extended label and icon files**.
7. Click **Start** to format and create the bootable USB drive.

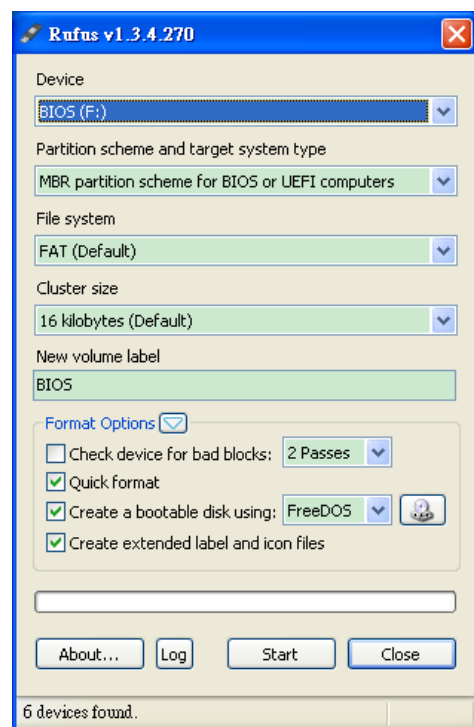

ATTENTION

We recommend that you use a USB drive with less than 2 GB of storage capacity. A USB drive with bigger storage capacity may not support FAT file format and, consequently, may fail to boot.

Step 2: Prepare the Upgrade File

You must use the BIOS upgrade installation file to upgrade the BIOS. Contact Moxa's technical department for assistance.

1. Get the BIOS upgrade installation file. The file name should have following format: **2000xxSx.exe** (xx refers to version numbers).
2. Copy the file to the bootable USB drive.

Step 3: Run the upgrade program on the MPC-2000 Series

1. Reboot the computer, press F2 while during the boot process to access the Boot Manager.
2. Select Generic USB Flash Disk as the first boot source. Press [Enter] to continue.

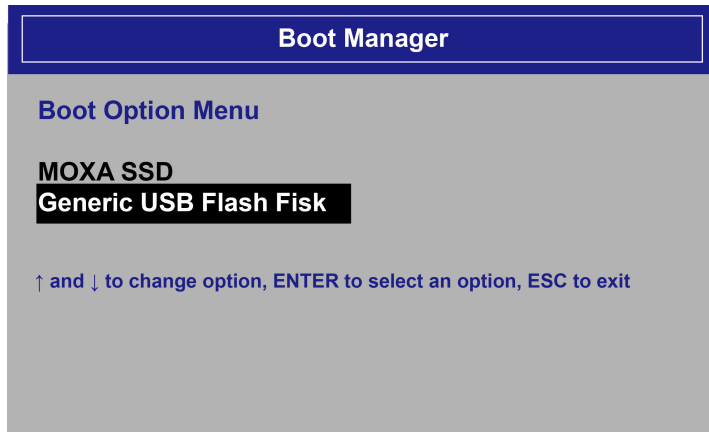

3. When the boot process is complete, a command screen appears. Go to the directory where the upgrade file is located. For example, if the upgrade file is stored in the MPC2240 folder, type **cd MPC2240**.

```
C:\>cd MPC2240
```

4. Run the upgrade program by typing **22410S02.exe**. Note that the upgrade filename may vary depending on the versions.

```
C:\MPC2240>22410S02.exe
```

5. The system automatically executes the upgrade program. Wait until the upgrade process is complete.



6. After the upgrade process is complete, the computer automatically restarts. Access the BIOS Setup screen to verify the BIOS version on Main page. The following figure shows an example.

| | |
|----------------|---|
| MODEL NAME | MPC-2240 |
| BIOS Version | V1.00S02 |
| Processor Type | Intel (R) Celeron (R) CPU 1047UE @ 1.40GHz |

**ATTENTION**

Do NOT turn off the power supply during the BIOS upgrade process. Doing so may interrupt the upgrade process and cause damage to the mainboard.

A

Regulatory Approval Statement



This device complies with part 15 of the FCC Rules. Operation is subject to the following two conditions: (1) This device may not cause harmful interference, and (2) this device must accept any interference received, including interference that may cause undesired operation.

Class A: FCC Warning! This equipment has been tested and found to comply with the limits for a Class A digital device, pursuant to part 15 of the FCC Rules. These limits are designed to provide reasonable protection against harmful interference when the equipment is operated in a commercial environment. This equipment generates, uses, and can radiate radio frequency energy and, if not installed and used in accordance with the instruction manual, may cause harmful interference to radio communications. Operation of this equipment in a residential area is likely to cause harmful interference in which case the user will be required to correct the interference at his/her own expense.



European Community

Warning:

This is a class A product. In a domestic environment this product may cause radio interference in which case the user may be required to take adequate measures.