

# EDS-308/309 Series Quick Installation Guide

---

**Moxa EtherDevice Switch**

**Edition 11.1, March 2018**

## **Technical Support Contact Information** **[www.moxa.com/support](http://www.moxa.com/support)**

### Moxa Americas:

Toll-free: 1-888-669-2872

Tel: 1-714-528-6777

Fax: 1-714-528-6778

### Moxa China (Shanghai office):

Toll-free: 800-820-5036

Tel: +86-21-5258-9955

Fax: +86-21-5258-5505

### Moxa Europe:

Tel: +49-89-3 70 03 99-0

Fax: +49-89-3 70 03 99-99

### Moxa Asia-Pacific:

Tel: +886-2-8919-1230

Fax: +886-2-8919-1231

### Moxa India:

Tel: +91-80-4172-9088

Fax: +91-80-4132-1045

The logo for Moxa, featuring the word "MOXA" in a bold, teal, sans-serif font. A registered trademark symbol (®) is located to the upper right of the letter "A".

© 2018 Moxa Inc. All rights reserved.

**P/N: 1802003083015**



## Overview

Moxa EtherDevice™ EDS-308/309 Series, which consists of 9-, and 8-port smart Ethernet switches, provides an economical solution for your Ethernet connections. As an added bonus, the built-in smart alarm function helps system maintainers monitor the health of your Ethernet network.

EDS-308/309 switches have a wide operating temperature range of -40 to 75°C, and are designed to withstand a high degree of vibration and shock. The rugged hardware design makes EDS-308/309 Series perfect for ensuring that your Ethernet equipment can withstand critical industrial applications, and complies with FCC and CE Standards.

**NOTE** Throughout this Hardware Installation Guide, we use **EDS** as an abbreviation for Moxa EtherDevice Switch:

**EDS = Moxa EtherDevice Switch**

## Package Checklist

Moxa EDS-308/309 is shipped with the following items. If any of these items is missing or damaged, please contact your customer service representative for assistance.

- Moxa EtherDevice™ Switch
- Quick installation guide (printed)
- Warranty card
- Protective caps for unused ports

## Features

### **High Performance Network Switching Technology**

- 10/100BaseT(X) (RJ45), 100BaseFX (SC/ST-type, Multi/Single mode)
- IEEE802.3/802.3u/802.3x
- Store and Forward switching process type, with 1024 address entries
- 10/100M, Full/Half-Duplex, MDI/MDIX auto-sensing

### **Industrial Grade Reliability**

- Power failure, port break alarm by relay output
- Redundant dual DC power inputs

### **Rugged Design**

- Operating temperature range from 0 to 60°C, or extended operating temperature from -40 to 75°C for "-T" models
- IP30, rugged high-strength case
- DIN-rail or panel mounting ability



## **WARNING**

The power for this product is intended to be supplied by a Listed Power Supply, with output marked LPS, and rated to deliver 12 to 48 VDC at a maximum of 0.6A.

The DC jack should be used with an LPS unit that is rated to deliver 12 to 48 VDC at a minimum of 1.1A. The product should not be disassembled by operators or service people.

# EDS-308 Panel Layout

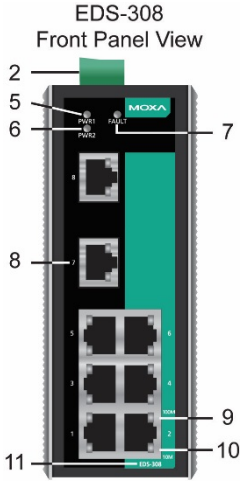

1. Grounding screw
2. Terminal block for power inputs PWR1/PWR2 and relay output
3. Heat dissipation orifices
4. DIP switches
5. Power input PWR1 LED
6. Power input PWR2 LED
7. Fault LED
8. 10/100BaseT(X) Port
9. TP port's 100 Mbps LED
10. TP port's 10 Mbps LED
11. Model Name
12. Screw holes for wall mounting kit
13. DIN-Rail Kit

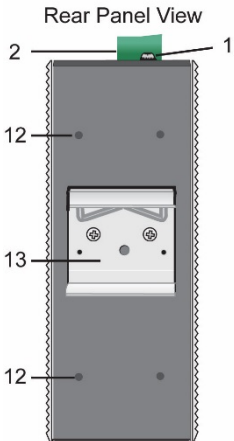
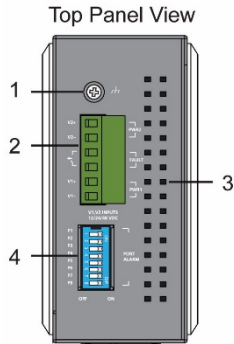

## EDS-308 Panel Layout (SC-type)

EDS-308-M-SC  
Front Panel View

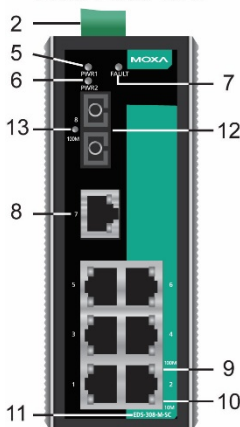

EDS-308-MM-SC  
Front Panel View

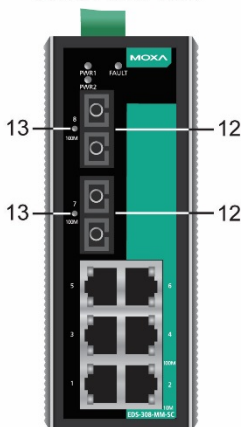

Top Panel View

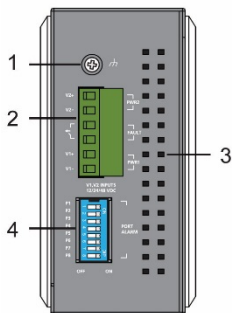

Rear Panel View

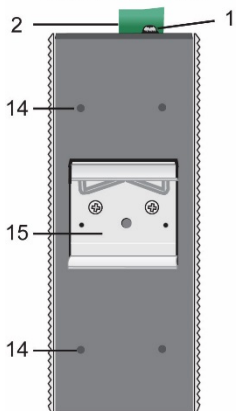

NOTE: The appearance of EDS-308-S-SC is identical to EDS-308-M-SC, and the appearance of EDS-308-SS-SC is identical to EDS-308-MM-SC.

1. Grounding screw
2. Terminal block for power inputs PWR1/PWR2 and relay output
3. Heat dissipation orifices
4. DIP switches
5. Power input PWR1 LED
6. Power input PWR2 LED
7. Fault LED
8. 10/100BaseT(X) Port
9. TP port's 100 Mbps LED
10. TP port's 10 Mbps LED
11. Model Name
12. 100BaseFX Port
13. FX port's 100 Mbps LED
14. Screw holes for wall mounting kit
15. DIN-Rail Kit

## EDS-309 Panel Layout (SC-type)

EDS-309-3M-SC  
Front Panel View

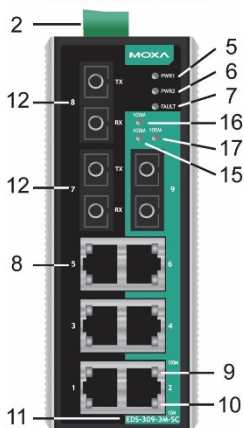

1. Grounding screw
2. Terminal block for power inputs PWR1/PWR2 and relay output
3. Heat dissipation orifices
4. DIP switches
5. Power input PWR1 LED
6. Power input PWR2 LED
7. Fault LED
8. 10/100BaseT(X) Port
9. TP port's 100 Mbps LED
10. TP port's 10 Mbps LED
11. Model Name
12. 100BaseFX Port
13. Screw holes for wall mounting kit
14. DIN-Rail Kit
15. 100 Mbps LED for FX port 7
16. 100 Mbps LED for FX port 8
17. 100 Mbps LED for FX port 9

Top Panel View

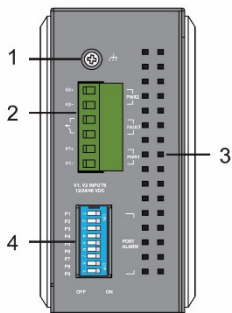

Rear Panel View

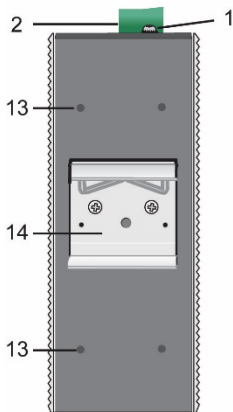

## EDS-308/309 Panel Layout (ST-type)

EDS-308-MM-ST  
Front Panel View

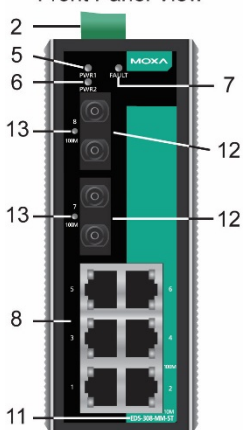

Top Panel View

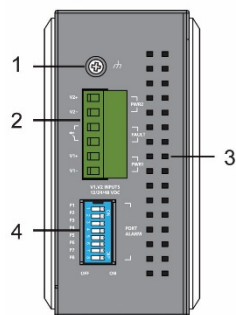

Rear Panel View

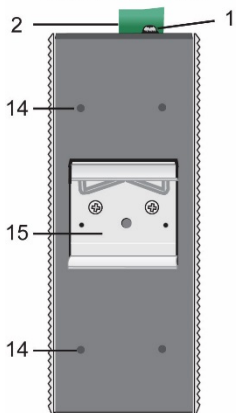

EDS-309-3M-ST  
Front Panel View

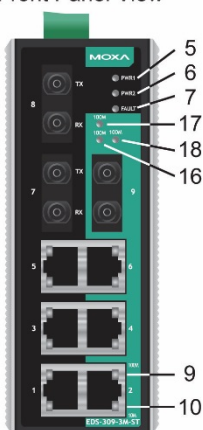

1. Grounding screw
2. Terminal block for power input PWR1/PWR2 and relay output
3. Heat dissipation orifices
4. DIP switches
5. Power input PWR1 LED
6. Power input PWR2 LED
7. Fault LED
8. 10/100BaseT(X) Port
9. TP port's 100 Mbps LED
10. TP port's 10 Mbps LED
11. Model Name
12. 100BaseFX Port
13. 100 Mbps LED for FX port
14. Screw hole for wall mounting kit
15. DIN-Rail Kit
16. 100 Mbps LED for FX port 7
17. 100 Mbps LED for FX port 8
18. 100 Mbps LED for FX port 9

# Mounting Dimensions

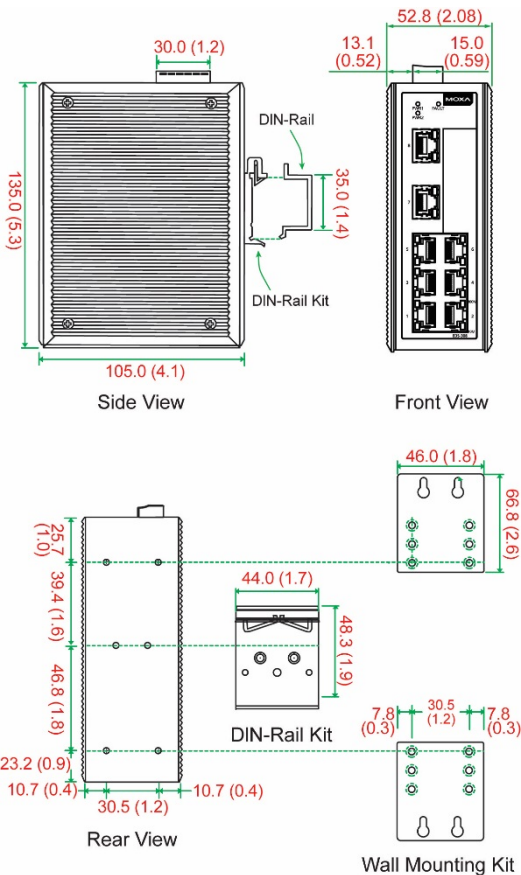

Unit = mm (inch)

## DIN-Rail Mounting

The aluminum DIN-Rail attachment plate should already be fixed to the back panel of EDS-308/309 when you take it out of the box. If you need to reattach the DIN-Rail attachment plate, make sure the stiff metal spring is situated towards the top, as shown in the figures below.

### STEP 1:

Insert the top of the DIN-Rail into the slot just below the stiff metal spring.

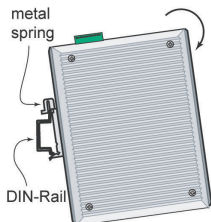

### STEP 2:

The DIN-Rail attachment unit will snap into place as shown below.

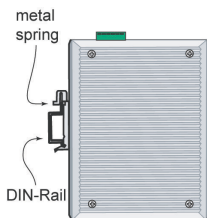

To remove Moxa EtherDevice Switch from the DIN-Rail, simply reverse Steps 1 and 2 above.

## Wall Mounting (optional)

For some applications, you will find it convenient to mount EDS-308/309 on the wall, as illustrated below.

### STEP 1:

Remove the aluminum DIN-Rail attachment plate from EDS-308/309's rear panel, and then attach the wall mount plates, as shown in the diagram below.

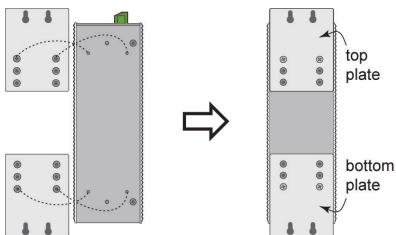

### STEP 2:

Mounting EDS-308/309 on the wall requires 4 screws. Use the switch, with wall mount plates attached, as a guide to mark the correct locations of the 4 screws. The heads of the screws should be less than 6.0 mm in diameter, and the shafts should be less than 3.5 mm in diameter, as shown in the figure at the right.

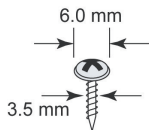

**NOTE** Before tightening screws into the wall, make sure the screw head and shank size are suitable by inserting the screw into one of the keyhole-shaped apertures of the Wall Mounting Plates.

Do not screw the screws in all the way—leave about 2 mm to allow room for sliding the wall mount panel between the wall and the screws.



### STEP 3:

Once the screws are fixed in the wall, insert the four screw heads through the large parts of the keyhole-shaped apertures, and then slide EDS-308/309 downwards, as indicated. Tighten the four screws for added stability.

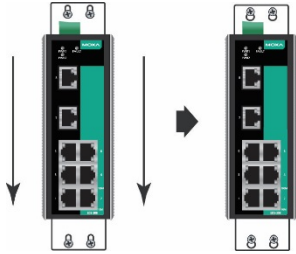

## ATEX Information



1. Certificate number DEMKO 08 ATEX 0717913X
2. Ambient range:  $-40^{\circ}\text{C} \leq T_{\text{amb}} \leq 75^{\circ}\text{C}$
3. Certification string: Ex nA nC IIC T4 Gc
4. Standards covered:  
EN 60079-0:2012+A11:2013 / IEC 60079-0 Ed.6 , EN 60079-15:2010 / IEC 60079-15 Ed.45.
5. The conditions of safe usage:
  - These products must be mounted in an IP54 enclosure.
  - Install in an area of pollution degree 2 or less.
  - Provisions shall be made either in the equipment or external to the equipment to provide the transient protection device to be set at a level not exceeding 140% of the peak rated voltage.
  - A 4 mm conductor must be used when a connection to an external grounding screw is utilized.
  - Supply Terminal Block (JP2) – Cat. No. 5EHDR-06P mating with Cat. No. 5ESDV-06P, manufactured by Dinkle Enterprise Co., Ltd. Rated 300 V, 15 A, suitable for 0.8-3.31 mm<sup>2</sup> (28-12 AWG) wire size, torque value 0.51 N-m (4.5 lb-in). The Terminal Block(J1) is suitable for 28-12 AWG (0.0804-3.31 mm<sup>2</sup>). The input terminal cable size 14 AWG( 2.1 mm<sup>2</sup>).
  - Conductors suitable for use in an ambient temperature of 101°C must be used for the Power Supply Terminal. Provisions must be made to prevent the rated voltage being exceeded by transient disturbances of more than 40%.



### WARNING

EXPLOSION HAZARD – Do not disconnect equipment unless power has been removed or the area is known to be non-hazardous.

## Wiring Requirements



### WARNING

Do not disconnect modules or wires unless the power supply has been switched off or the area is known to be non-hazardous. The devices may only be connected to the supply voltage shown on the type plate.

The devices are designed for operation with a Safety Extra-Low Voltage. Thus, they may only be connected to the supply voltage connections and to the signal contact with the Safety Extra-Low Voltages (SELV) in compliance with IEC950/ EN60950/ VDE0805.



### WARNING

Substitution of components may impair suitability for Class I, Division 2, and Zone 2. These devices must be supplied by an SELV source as defined in Low Voltage Directive 73/23/EEC and 93/68/EEC.



### WARNING

This unit is a built-in type. When the unit is installed in another piece of equipment, the equipment enclosing the unit must comply with fire enclosure regulation IEC 60950/EN60950 (or similar regulation).



### WARNING

#### **Safety First!**

Be sure to disconnect the power cord before installing and/or wiring your Moxa EtherDevice Switch.

Calculate the maximum possible current in each power wire and common wire. Observe all electrical codes dictating the maximum current allowable for each wire size.

If the current goes above the maximum ratings, the wiring could overheat, causing serious damage to your equipment.

You should also pay attention to the following items:

- Use separate paths to route wiring for power and devices. If power wiring and device wiring paths must cross, make sure the wires are perpendicular at the intersection point.  
**NOTE:** Do not run signal or communications wiring and power wiring in the same wire conduit. To avoid interference, wires with different signal characteristics should be routed separately.
- You can use the type of signal transmitted through a wire to determine which wires should be kept separate. The rule of thumb is that wiring that shares similar electrical characteristics can be bundled together.

- Keep input wiring and output wiring separated.
- It is strongly advised that you label wiring to all devices in the system when necessary.

## Grounding Moxa EtherDevice Switch

Grounding and wire routing help limit the effects of noise due to electromagnetic interference (EMI). Run the ground connection from the ground screw to the grounding surface prior to connecting devices.



### ATTENTION

This product is intended to be mounted to a well-grounded mounting surface, such as a metal panel.

## Wiring the Alarm Contact

The Alarm Contact consists of the two middle contacts of the terminal block on EDS's top panel. You may refer to the next section for detailed instructions on how to connect the wires to the terminal block connector, and how to attach the terminal block connector to the terminal block receptor. In this section, we explain the meaning of the two contacts used to connect the Alarm Contact.

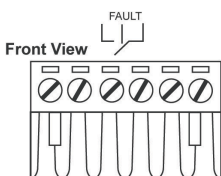
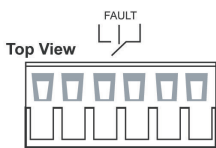

**FAULT:** The two middle contacts of the 6-contact terminal block connector are used to detect both power faults and port faults. The two wires attached to the Fault contacts form an open circuit when:

1. The EDS has lost power from one of the DC power inputs.  
OR
2. One of the ports for which the corresponding PORT ALARM DIP Switch is set to ON is not properly connected.

If neither of these two conditions is satisfied, the Fault circuit will be closed.

## Wiring the Redundant Power Inputs

The top two contacts and the bottom two contacts of the 6-contact terminal block connector on the EDS's top panel are used for the EDS's two DC inputs. Top and front views of one of the terminal block connectors are shown here. Only use copper conductors that can withstand 101°C.

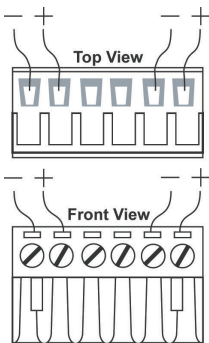

**STEP 1:**

Insert the negative/positive DC wires into the V-/V+ terminals.

**STEP 2:**

To keep the DC wires from pulling loose, use a small flat-blade screwdriver to tighten the wire-clamp screws on the front of the terminal block connector.

**STEP 3:**

Insert the plastic terminal block connector prongs into the terminal block receptor, which is located on the EDS's top panel.



**ATTENTION**

Before connecting the EDS to the DC power inputs, make sure the DC power source voltage is stable.

**Communication Connections**

**10/100BaseT(X) Ethernet Port Connection**

The 10/100BaseT(X) ports located on the EDS's front panel are used to connect to Ethernet-enabled devices.

Below we show pinouts for both MDI (NIC-type) ports and MDI-X (HUB/Switch-type) ports, and also show cable wiring diagrams for straight-through and cross-over Ethernet cables.

**10/100Base T(x) RJ45 Pinouts**

**MDI Port Pinouts**

Pin	Signal
1	Tx+
2	Tx-
3	Rx+
6	Rx-

**MDI-X Port Pinouts**

Pin	Signal
1	Rx+
2	Rx-
3	Tx+
6	Tx-

**8-pin RJ45**

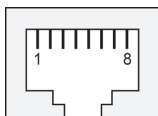

**RJ45 (8-pin) to RJ45 (8-pin) Straight-Through Cable Wiring**

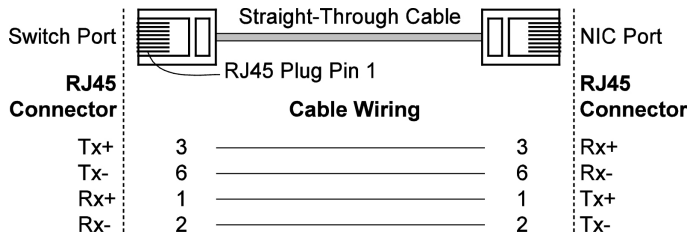

## RJ45 (8-pin) to RJ45 (8-pin) Cross-Over Cable Wiring

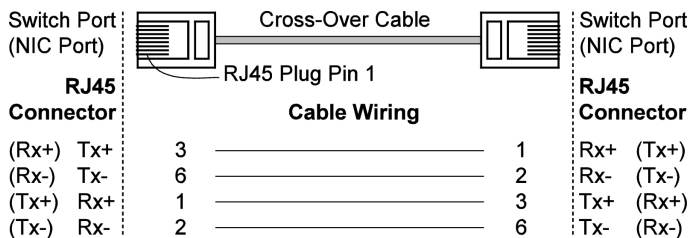

## 100BaseFX Ethernet Port Connection

The concept behind the SC/ST port and cable is quite straightforward. Suppose you are connecting devices I and II. Contrary to electrical signals, optical signals do not require a circuit in order to transmit data. Consequently, one of the optical lines is used to transmit data from device I to device II, and the other optical line is used to transmit data from device II to device I, for full-duplex transmission.

All you need to remember is to connect the Tx (transmit) port of device I to the Rx (receive) port of device II, and the Rx (receive) port of device I to the Tx (transmit) port of device II. If you make your own cable, we suggest labeling the two sides of the same line with the same letter (A-to-A and B-to-B, as shown below, or A1-to-A2 and B1-to-B2).

### SC-Port Pinouts

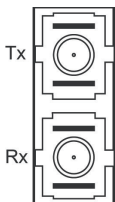

### SC-Port to SC-Port Cable Wiring

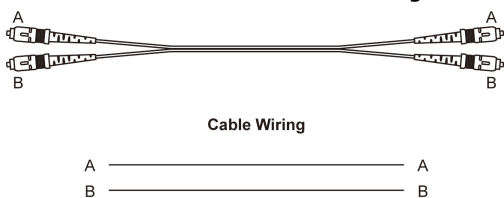

### ST-Port Pinouts



### ST-Port to ST-Port Cable Wiring

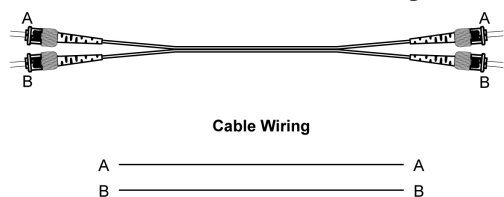

## ATTENTION

This is a Class 1 Laser/LED product. To avoid causing serious damage to your eyes, do not stare directly into the Laser Beam.

## Redundant Power Inputs

Both power inputs can be connected simultaneously to live DC power sources. If one power source fails, the other live source acts as a backup, and automatically supplies all of EDS-308/309's power needs.

## Alarm Contact

The Moxa EtherDevice Switch has one Alarm Contact located on the top panel. For detailed instructions on how to connect the Alarm Contact power wires to the two middle contacts of the 6-contact terminal block connector, see the Wiring the Alarm Contact section on page 8. A typical scenario would be to connect the Fault circuit to a warning light located in the control room. The light can be set up to switch on when a fault is detected.

The Alarm Contact has two terminals that form a Fault circuit for connecting to an alarm system. The two wires attached to the Fault contacts form an open circuit when (1) EDS has lost power from one of the DC power inputs, or (2) one of the ports for which the corresponding PORT ALARM DIP Switch is set to ON is not properly connected.

If neither of these two conditions occurs, the Fault circuit will be closed.

## DIP Switch Settings

### EDS-308 Series DIP Switches

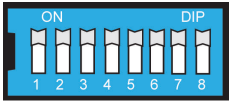

### EDS-309 Series DIP Switches

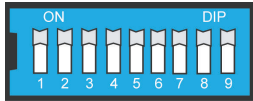

**ON:** Enables the corresponding PORT Alarm. If the port's link fails, the relay will form an open circuit and the fault LED will light up.

**Off:** Disables the corresponding PORT Alarm. The relay will form a closed circuit and the Fault LED will never light up.

## LED Indicators

The front panel of the Moxa EtherDevice Switch contains several LED indicators. The function of each LED is described in the table below.

LED	Color	State	Description
<b>PWR1</b>	AMBER	On	Power is being supplied to power input PWR1
		Off	Power is <b>not</b> being supplied to power input PWR1
<b>PWR2</b>	AMBER	On	Power is being supplied to power input PWR2
		Off	Power is <b>not</b> being supplied to power input PWR2
<b>FAULT</b>	RED	On	When the corresponding PORT alarm is enabled, and the port's link is inactive.
		Off	When the corresponding PORT alarm is enabled and the port's link is active, or when the corresponding PORT alarm is disabled.
<b>10M</b>	GREEN	On	TP port's 10 Mbps link is active
		Blinking	Data is being transmitted at 10 Mbps
		Off	TP Port's 10 Mbps link is inactive
<b>100M (TP)</b>	GREEN	On	TP port's 100 Mbps link is active
		Blinking	Data is being transmitted at 100 Mbps
		Off	100BaseTX Port's link is inactive
<b>100M</b>	GREEN	On	FX port's 100 Mbps is active

<b>(FX)</b>		Blinking	Data is being transmitted at 100 Mbps
		Off	100BaseFX port is inactive

## Auto MDI/MDI-X Connection

The Auto MDI/MDI-X function allows users to connect EDS-308's 10/100BaseTX ports to any kind of Ethernet device, without needing to pay attention to the type of Ethernet cable being used for the connection. This means that you can use either a straight-through cable or cross-over cable to connect EDS-308/309 to Ethernet devices.

## Switching, Filtering, and Forwarding

Each time a packet arrives at one of the switched ports, a decision is made to either filter or forward the packet. Packets with source and destination addresses belonging to the same port segment will be filtered, constraining those packets to one port, and relieving the rest of the network from the need to process them. A packet with destination address on another port segment will be forwarded to the appropriate port, and will not be sent to the other ports where it is not needed. Packets that are used in maintaining the operation of the network (such as the occasional multi-cast packet) are forwarded to all ports. EDS-308/309 operates in the store-and-forward switching mode, which eliminates bad packets and enables peak performance to be achieved when there is heavy traffic on the network.

## Switching and Address Learning

Moxa EDS-308/309 has an address table that can hold up to 2K node addresses, which makes it suitable for use with large networks. The address tables are self-learning, so that as nodes are added or removed, or moved from one segment to another, EDS-308/309 automatically keeps up with new node locations. An address-aging algorithm causes the least-used addresses to be deleted in favor of newer, more frequently used addresses. To reset the address buffer, power down the unit and then power it back up.

## Auto-Negotiation and Speed Sensing

All of EDS-308/309's RJ45 Ethernet ports independently support auto-negotiation for speeds in the 10BaseT and 100BaseTX modes, with operation according to the IEEE 802.3u standard. This means that some nodes could be operating at 10 Mbps, while at the same time, other nodes are operating at 100 Mbps.

Auto-negotiation takes place when an RJ45 cable connection is made, and then each time a LINK is enabled. EDS-308/309 advertises its capability for using either 10 Mbps or 100 Mbps transmission speeds, with the device at the other end of the cable expected to similarly advertise. Depending on what type of device is connected, this will result in agreement to operate at a speed of either 10 Mbps or 100 Mbps.

If an EDS-308/309 RJ45 Ethernet port is connected to a non-negotiating device, it will default to 10 Mbps speed and half-duplex mode, as required by the IEEE 802.3u standard.

## Specifications

Technology				
Standards	IEEE802.3, 802.3u, 802.3x			
Forward and Filtering Rate	148810 pps			
Packet Buffer Memory	EDS-308: 768 KB and EDS-309: 512 KB			
Processing Type	Store and Forward, with IEEE802.3x full duplex, back pressure flow control			
Address Table Size	EDS-308: 2K uni-cast addresses EDS-309: 1k uni-cast addresses			
Latency	Less than 5 $\mu$ s			
Interface				
RJ45 Ports	10/100BaseT(X) auto negotiation speed, F/H duplex mode, and auto MDI/MDI-X connection			
Fiber Ports	100BaseFX ports (SC/ST connector)			
LED Indicators	Power, Fault, 10/100			
DIP Switch	Port break alarm mask			
Alarm Contact	One relay output with current carrying capacity of 1A @ 24 VDC			
Optical Fiber				
		100Base FX		
		Multi-mode	Single-mode 40 km	Single-mode 80 km
Fiber Cable Type	OM1	50/125 $\mu$ m 800 MHz*Km	G.652	G.652
Typical Distance	4 km	5 km	40 km	80 km
Wavelength	Typical (nm)	1300	1310	1550
	TX Range (nm)	1260 to 1360	1280 to 1340	1530 to 1570
	RX Range (nm)	1100 to 1600	1100 to 1600	1100 to 1600
Optical Power	TX Range (dBm)	-10 to -20	0 to -5	0 to -5
	RX Range (dBm)	-3 to -32	-3 to -34	-3 to -34
	Link Budget (dB)	12	29	29
	Dispersion Penalty (dB)	3	1	1
<p>Note: When connecting 40 km or 80 km single-mode fiber over a short distance, we recommend putting an attenuator to prevent the transceiver from being damaged by excessive optical power.</p> <p>Typical Distance: To reach the typical distance of a specified fiber transceiver, please refer to the following formula: Link budget(dB) &gt; dispersion penalty(dB) + total link loss(dB).</p>				
Power				
Input Voltage	12/24/48 VDC, redundant inputs			
Input Current @ 24 VDC	0.07 A (EDS-308) 0.11 A (EDS-308-M) 0.12 A (EDS-308-S) 0.15 A (EDS-308-MM/SS) 0.26 A (EDS-309)			
Connection	Removable "6-pin" Terminal Block			
Inrush Current	EDS-308: Max. 6.96A @ 24VDC (0.1 - 1ms) EDS-309: Max. 6.34A @ 24VDC (0.1 - 1ms)			
Overload Current Protection	Present			



Reverse Polarity Protection	Present
<b>Mechanical</b>	
Casing	IP30 protection, metal case
Dimensions	53.6 x 135 x 105 mm (W x H x D)
Weight	0.63 kg
Installation	DIN-Rail, Wall Mounting

<b>Environmental</b>	
Operating Temperature	0 to 60°C (32 to 140°F) -40 to 75°C (-40 to 167°F) for -T models
Storage Temperature	-40 to 85°C (-40 to 185°F)
Ambient Relative Humidity	5 to 95% (non-condensing)
<b>Regulatory Approvals</b>	
Safety	UL 60950, UL 508, CSA C22.2 No. 60950, EN 60950
Hazardous Location	UL/cUL Class I, Division 2, Groups A, B, C and D ATEX Zone 2, Ex nA nC IIC T4 Gc
EMI	FCC Part 15, CISPR (EN 55032) class A
EMS	EN 61000-4-2 (ESD), Level 3 EN 61000-4-3 (RS), Level 3 EN 61000-4-4 (EFT), Level 3 EN 61000-4-5 (Surge), Level 3 EN61000-4-6 (CS), Level 3
Shock	IEC60068-2-27
Free Fall	IEC60068-2-32
Vibration	IEC60068-2-6
Warranty	5 years
Address of Manufacturer	FL.4, No.135, Lane 235, Baoqiao Rd. Xindian Dist., New Taipei City, Taiwan



## WARNING

This equipment is intended to be used in a Restricted Access Location.

WARNING: HOT SURFACE!! Before touching it, special attention or protection is required.