

EDS-516A Series Hardware Installation Guide

Moxa EtherDevice™ Switch

Sixth Edition, April 2014



© 2014 Moxa Inc. All rights reserved.

P/N: 1802005160014

Package Checklist

Moxa EtherDevice™ Switch is shipped with the following items. If any of these items are missing or damaged, please contact your customer service representative for assistance.

- 1 Moxa EtherDevice Switch EDS-516A
- Hardware Installation Guide
- CD-ROM with User's Manual and Windows Utility
- Moxa Product Warranty Booklet
- RJ45 to DB9 Console port cable
- Protective caps for unused ports
- Panel mounting kit (optional—must order separately)

Optional Accessories

- **DR-4524**—45W/2A DIN-Rail 24 VDC Power Supply with 85 to 264 VAC input
- **DR-75-24**—75W/3.2A DIN-Rail 24 VDC Power Supply with 85 to 264 VAC input
- **DR-120-24**—120W/5A DIN-Rail 24 VDC Power Supply with 88 to 132 VAC/176 to 264 VAC input by switch
- **EDS-SNMP OPC Server Pro**—CD with EDS-SNMP OPC Server Software and manual
- **WK-46**—Wall Mounting Kit
- **RK-4U**—4U-high 19" rack mounting kit

Panel Views of EDS-516A

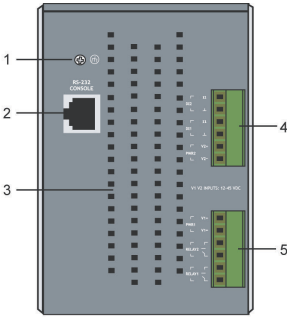

1. Grounding screw
2. Console port
3. Heat dissipation orifices
4. 6-pin terminal block for DI 1, DI 2, and PWR 2
5. 6-pin terminal block for PWR1, Relay 1, and Relay 2
6. 10/100BaseT(X), ports 1 to 16
7. PWR 1: LED for power input 1
8. PWR 2: LED for power input 2
9. Fault LED
10. MSTR/HEAD LED
11. CPLR/TAIL LED
12. TP port's 100 Mbps LED
13. TP port's 10 Mbps LED
14. Model Name
15. Screw hole for Wall Mounting Kit
16. DIN-Rail Kit

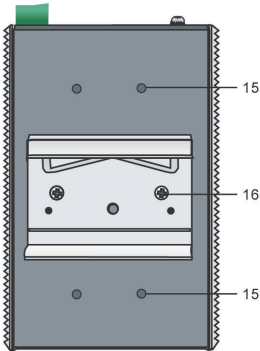
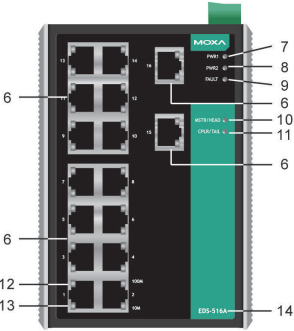

Panel Views of EDS-516A (SC/ST Type)

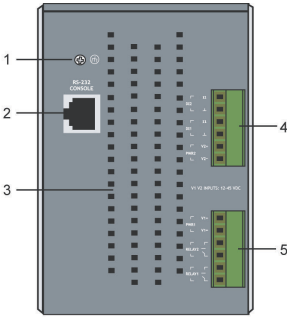

NOTE:

The appearance of EDS-516A-MM-ST is identical to EDS-516A-MM-SC.

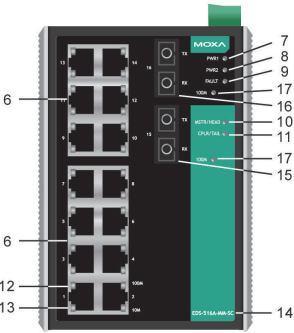

1. Grounding screw
2. Console port
3. Heat dissipation orifices
4. 6-pin terminal block for DI 1, DI 2, and PWR 2
5. 6-pin terminal block for PWR1 Relay 1, and Relay 2
6. 10/100BaseT(X), ports 1 to 14
7. PWR 1: LED for power input 1
8. PWR 2: LED for power input 2
9. Fault LED
10. MSTR/HEAD LED
11. CPLR/TAIL LED
12. TP port's 100 Mbps LED
13. TP port's 10 Mbps LED
14. Model Name
15. 100BaseFX Port 15
16. 100BaseFX Port 16
17. 100BaseFX LEDs
18. Screw hole for Wall Mounting Kit
19. DIN-Rail Kit

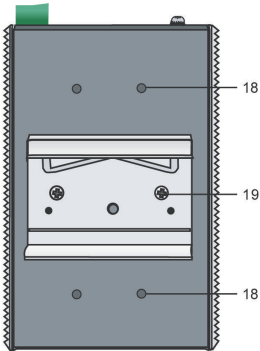

Mounting Dimensions

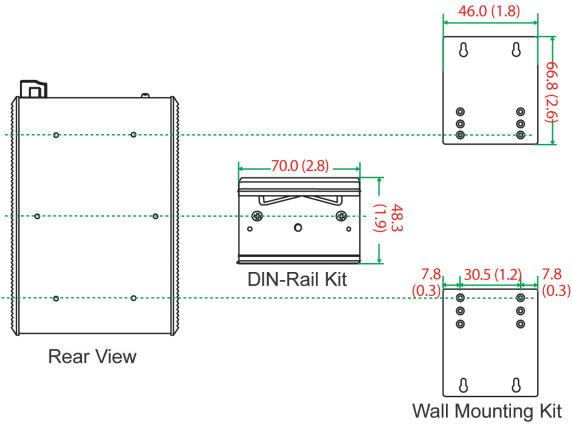
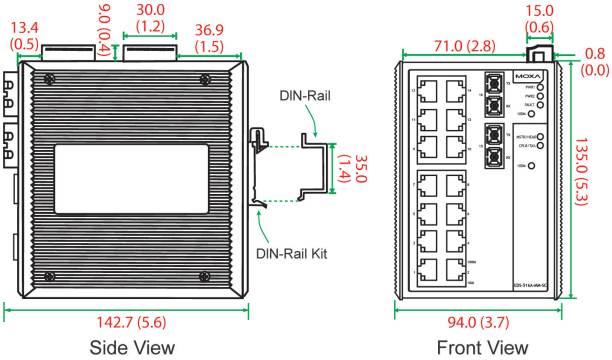

Unit = mm (inch)

DIN-Rail Mounting

The aluminum DIN-Rail attachment plate should already be fixed to the back panel of EDS-516A when you take it out of the box. If you need to reattach the DIN-Rail attachment plate to EDS-516A, make sure the stiff metal spring is situated towards the top, as shown by the following figures.

STEP 1—Insert the top of the DIN-Rail into the slot just below the stiff metal spring.

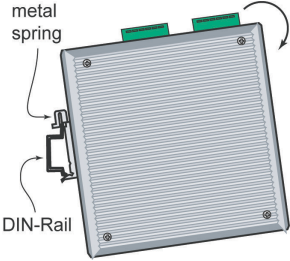

STEP 2—The DIN-Rail attachment unit will snap into place as shown in the following illustration.

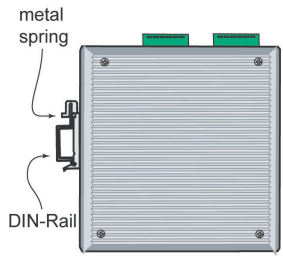

To remove the EDS-516A from the DIN-Rail, simply reverse Steps 1 and 2 above.

Wall Mounting (Optional)

For some applications, you will find it convenient to mount Moxa EDS-516A on the wall, as shown by the following illustrations:

STEP 1—Remove the aluminum DIN-Rail attachment plate from the Moxa EDS-516A rear panel, and then attach the wall mount plates with M3 screws, as shown by the figure on the right.

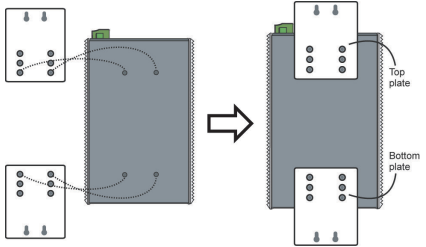

STEP 2—Mounting Moxa EDS-516A on the wall requires 4 screws. Use the EDS-516A, with wall mount plates attached, as a guide to mark the correct locations of the 4 screws. The heads of the screws should be less than 6.0 mm in diameter, and the shafts should be less than 3.5 mm in diameter, as shown by the figure on the right.

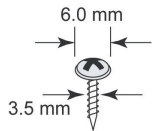

NOTE Before tightening the screws into the wall, make sure the screw head and shank size are suitable by inserting the screw through one of the keyhole-shaped apertures of the Wall Mounting Plates.

Do not screw the screws in all the way—leave about 2 mm to allow room for sliding the wall mount panel between the wall and the screws.

STEP 3—Once the screws are fixed to the wall, insert the four screw heads through the wide parts of the keyhole-shaped apertures, and then slide the EDS-516A downwards, as indicated in the figure at the right. Tighten the four screws for more stability.

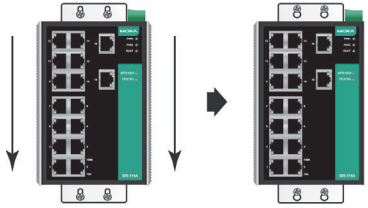

II 3G

ATEX Information

1. Certification number DEMKO 09 ATEX 0812123X
2. Ambient range ($-40^{\circ}\text{C} \leq T_{\text{amb}} \leq 75^{\circ}\text{C}$)
3. Certification string (Ex nA nC IIC T4 Gc)
4. Standards covered (EN60079-0:2012, EN 60079-15:2010)
5. The conditions of safe usage:



- The Ethernet Communication Devices are to be mounted in an IP54 enclosure and used in an area of not more than pollution degree 2 as defined by IEC60664-1.
- A 4mm² conductor must be used when connection to the external grounding screw is utilized.
- Conductors suitable for use in an ambient temperature of 93°C must be used for the Power Supply Terminal.
- Provisions shall be made, either in external to the apparatus, to prevent the rated voltage being exceeded by the transients disturbances of more than 40%.

Wiring Requirements



WARNING

Do not disconnect modules or wires unless power has been switched off or the area is known to be non-hazardous. The devices may only be connected to the supply voltage shown on the type plate. The devices are designed for operation with a Safety Extra-Low Voltage. Thus, they may only be connected to the supply voltage connections and to the signal contact with the Safety Extra-Low Voltages (SELV) in compliance with IEC950/ EN60950/ VDE0805.



ATTENTION

This unit is a built-in type. When the unit is installed in another piece of equipment, the equipment enclosing the unit must comply with fire enclosure regulation IEC 60950/EN60950 (or similar regulation).



ATTENTION

Safety First!

Be sure to disconnect the power cord before installing and/or wiring your Moxa EtherDevice Switch.

Calculate the maximum possible current in each power wire and common wire. Observe all electrical codes dictating the maximum current allowable for each wire size.

If the current goes above the maximum ratings, the wiring could overheat, causing serious damage to your equipment.

You should also pay attention to the following points:

- Use separate paths to route wiring for power and devices. If power wiring and device wiring paths must cross, make sure the wires are perpendicular at the intersection point
NOTE: Do not run signal or communications wiring and power wiring through the same wire conduit. To avoid interference, wires with different signal characteristics should be routed separately
- You can use the type of signal transmitted through a wire to determine which wires should be kept separate. The rule of thumb is that wiring that shares similar electrical characteristics can be bundled together
- Separate input wiring and output wiring
- We advise that you label wiring to all devices in the system when necessary.

Grounding the Moxa EDS-516A

Grounding and wire routing help limit the effects of noise due to electromagnetic interference (EMI). Run the ground connection from the ground screw to the grounding surface prior to connecting devices.



ATTENTION

This product is intended to be mounted to a well-grounded mounting surface such as a metal panel.

Wiring the Relay Contact

EDS-516A has two sets of relay outputs—relay 1 and relay 2. Each Relay Contact consists of the two contacts of the terminal block on EDS-516A’s top panel. You can refer to the next section for detailed instructions on how to connect the wires to the terminal block connector, and how to attach the terminal block connector to the terminal block receptor.

In this section, we will explain the meaning of the two contacts used to connect the Relay Contact.

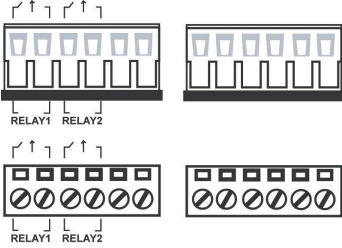

FAULT:

The two sets of relay contacts of the 6-pin terminal block connector are used to detect user-configured events. The two wires attached to the fault contacts form an open circuit when a user-configured event is triggered. If a user-configured event does not occur, the fault circuit remains closed.

Wiring the Redundant Power Inputs

EDS-516A has two sets of power inputs—power input 1 and power input 2. The top two contacts and the bottom two contacts of the 6-pin terminal block connector on EDS’ top panel are used for EDS’ two digital inputs. The top and front views of one of the terminal block connectors are shown here.

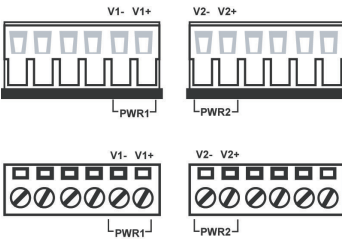

STEP 1:

Insert the negative/positive DC wires into the V-/V+ terminals, respectively.

STEP 2:

To keep the DC wires from pulling loose, use a small flat-blade screwdriver to tighten the wire-clamp screws on the front of the terminal block connector.

STEP 3:

Insert the plastic terminal block connector prongs into the terminal block receptor, which is located on the EDS-516A’s top panel.

Wiring the Digital Inputs

EDS-516A has two sets of digital inputs, DI 1 and DI 2. Each DI consists of two contacts of the 6-pin terminal block connector on EDS's top panel, which are used for EDS's two DC inputs. The top and front views of one of the terminal block connectors are shown here.

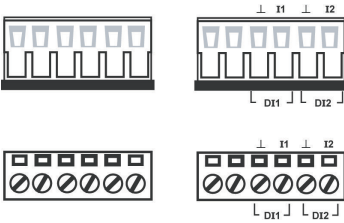

STEP 1: Insert the negative (ground)/positive DI wires into the \perp /I1 terminals, respectively.

STEP 2: To keep the DI wires from pulling loose, use a small flat-blade screwdriver to tighten the wire-clamp screws on the front of the terminal block connector.

STEP 3: Insert the plastic terminal block connector prongs into the terminal block receptor, which is located on the EDS-516A's top panel.

Communication Connections

All models of EDS-516A have one RJ45 console port (RS-232 interface), between 14 and 16 10/100BaseTX Ethernet ports. Some models also have 2 100BaseFX (SC/ST-type connector) fiber ports.

In this section, we present two types of diagrams—Pinout Diagrams and Cable Wiring Diagrams—to convey information about the ports and the cables used to connect Moxa EDS-516A to other devices:

Pinouts—The meaning of the "Pinouts" diagrams is straightforward. The diagrams simply display the type of signal passing through each of the port's pins.

Cable Wiring—Diagrams labeled "Cable Wiring" present standard cable wiring schemes for cables used to connect Moxa EtherDevice Switch's ports to other devices. These diagrams display three pieces of information:

1. When building your own cable, refer to the "**pin-to-pin**" Cable Wiring information displayed between the two vertical dashed lines to see which pin of the connector on the left should be connected to which pin of the connector on the right.
2. The information to the left of the left vertical dashed lines gives the pinouts of the relevant Moxa EtherDevice Switch port.
3. The information to the right of the right vertical dashed line gives the pinouts of the opposing device's port.

- NOTE**
1. The pin numbers for male DB9 and DB25 connectors, and hole numbers for female DB9 and DB25 connectors are labeled on the connector. However, the numbers are typically quite small, so you may need to use a magnifying glass to see the numbers clearly.
 2. The pin numbers for both 8-pin and 10-pin RJ45 connectors (and ports) are typically not labeled on the connector (or port). Refer to the following Pinout and Cable Wiring diagrams to see how RJ45 pins are numbered.

RS-232 Connection

Moxa EDS-516A has one RS-232 (10-pin RJ45) console port, located on the top panel. Use either an RJ45-to-DB9 or RJ45-to-DB25 cable (see the cable following wiring diagrams) to connect Moxa EDS-516A's console port to your PC's COM port. You may then use a console terminal program, such as Moxa PComm Terminal Emulator, to access Moxa EDS-516A's console configuration utility.

RJ45 (10-pin) Console Port Pinouts

Pin	Description
1	---
2	DSR
3	RTS
4	---
5	TxD
6	RxD
7	GND
8	CTS
9	DTR
10	---

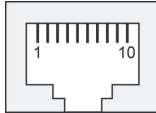

RJ45 (10-pin) to DB9 (F) Cable Wiring

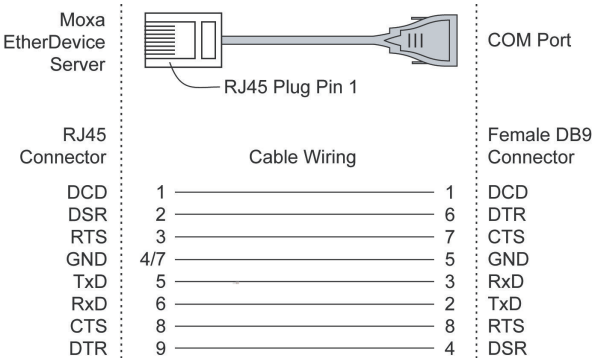

RJ45 (10-pin) to DB25 (F) Cable Wiring

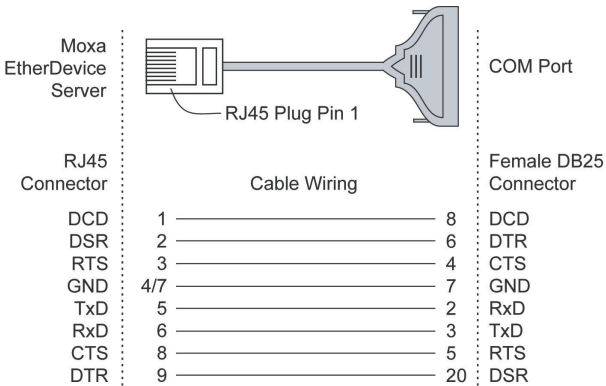

10/100BaseT(X) Ethernet Port Connection

The 10/100BaseT(X) ports located on Moxa EtherDevice Switch's front panel are used to connect to Ethernet-enabled devices. Most users will choose to configure these ports for Auto MDI/MDI-X mode, in which case the port's pinouts are adjusted automatically depending on the type of Ethernet cable used (straight-through or cross-over), and the type of device (NIC-type or HUB/Switch-type) connected to the port.

In what follows, we give pinouts for both MDI (NIC-type) ports and MDI-X (HUB/Switch-type) ports. We also give cable wiring diagrams for straight-through and cross-over Ethernet cables.

10/100Base T(x) RJ45 Pinouts

MDI Port Pinouts

Pin	Signal
1	Tx+
2	Tx-
3	Rx+
6	Rx-

MDI-X Port Pinouts

Pin	Signal
1	Rx+
2	Rx-
3	Tx+
6	Tx-

8-pin RJ45

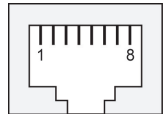

RJ45 (8-pin) to RJ45 (8-pin) Straight-through Cable Wiring

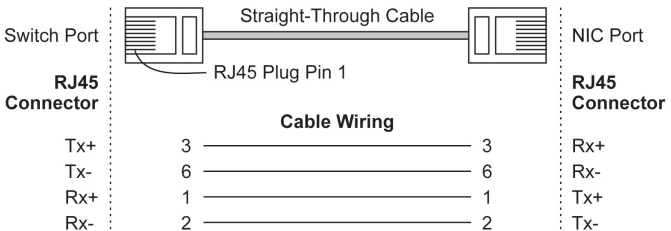

RJ45 (8-pin) to RJ45 (8-pin) Cross-Over Cable Wiring

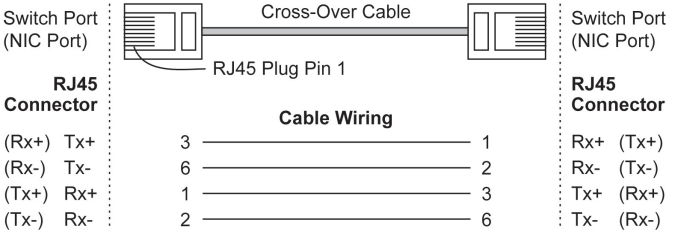

100BaseFx Ethernet Port Connection

The concept behind the SC/ST port and cable is quite straightforward. Suppose you are connecting devices I and II. As opposed to electrical signals, optical signals do not require a circuit in order to transmit data. Consequently, one of the optical lines is used to transmit data from device I to device II, and the other optical line is used transmit data from device II to device I, for full-duplex transmission.

All you need to remember is to connect the Tx (transmit) port of device I to the Rx (receive) port of device II, and the Rx (receive) port of device I to the Tx (transmit) port of device II. If you are making your own cable, we suggest labeling the two sides of the same line with the same letter (A-to-A and B-to-B, as shown by the following illustration, or A1-to-A2 and B1-to-B2).

SC-Port Pinouts

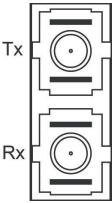

SC-Port to SC-Port Cable Wiring

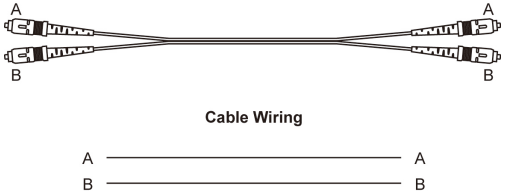

ST-Port Pinouts

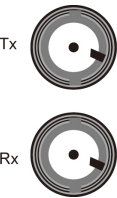

ST-Port to ST-Port Cable Wiring

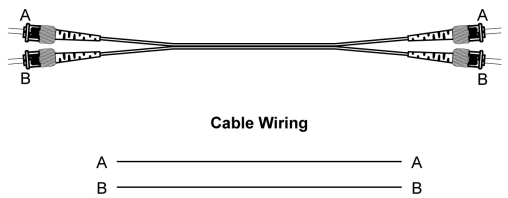

ATTENTION

This is a Class 1 Laser/LED product. To prevent damage to your eyes, do not stare directly into the laser beam.

LED Indicators

The front panel of Moxa EDS-516A contains several LED indicators. The function of each LED is described in the following table:

LED	Color	State	Description
PWR1	AMBER	On	Power is being supplied to power input P1.
		Off	Power is not being supplied to power input P1.
PWR2	AMBER	On	Power is being supplied to power input P2.
		Off	Power is not being supplied to power input P2.
FAULT	RED	On	When the corresponding PORT alarm is enabled, and a user-configured event is triggered.
		Off	When the corresponding PORT alarm is enabled and a user-configured event is not triggered, or when the corresponding PORT alarm is disabled.
MSTR/HEAD	GREEN	On	When the EDS-516A is set as the Master of the Turbo Ring, or as the Head of the Turbo Chain.
		Blinking	The EDS-516A has become the Ring Master of the Turbo Ring, or the Head of the Turbo Chain, after the Turbo Ring or the Turbo Chain is down.
		Off	When the EDS-516A is not the Master of this Turbo Ring or is set as the Member of the Turbo Chain.
CPLR/TAIL	GREEN	On	When the EDS-516A coupling function is enabled to form a back-up path, or when it's set as the Tail of the Turbo Chain.
		Blinking	When the Turbo Chain is down.
		Off	When the EDS-516A disables the coupling function.
10M (TP)	GREEN	On	TP port's 10 Mbps link is active.
		Blinking	Data is being transmitted at 10 Mbps.
		Off	TP port's 10 Mbps link is inactive.
100M (TP)	GREEN	On	TP port's 100 Mbps link is active.
		Blinking	Data is being transmitted at 100 Mbps.
		Off	TP port's 100 Mbps link is inactive.

Specifications

Technology	
Standards	IEEE 802.3 for 10BaseT, IEEE 802.3u for 100BaseT(X) and 100Base FX, IEEE 802.3x for Flow Control, IEEE 802.1D for Spanning Tree Protocol, IEEE 802.1w for Rapid STP, IEEE 802.1Q for VLAN Tagging, IEEE 802.1p for Class of Service, IEEE 802.1X for Authentication, IEEE 802.3ad for Port Trunk with LACP
Protocols	IGMPv1/v2, GMRP, GVRP, SNMPv1/v2c/v3, DHCP Server/Client, DHCP Option 66/67/82, BootP, TFTP, SNTF, SMTP, RARP, RMON, HTTP, HTTPS, Telnet, SSH, Syslog, IPv6, LLDP, IEEE 1588 PTP, Modbus/TCP, SNMP Inform
MIB	MIB-II, Ethernet-like MIB, P-BRIDGE MIB, Q-BRIDGE MIB, Bridge MIB, RSTP MIB, RMON MIB Group 1,2,3,9
Interface	
RJ45 Ports	10/100BaseT(X) auto negotiation speed, F/H duplex mode, and auto MDI/MDI-X connection
Fiber Ports	optional 100BaseFX (SC/ST connector)
Console Port	RS-232 (10-pin RJ45)
LED Indicators	PWR1, PWR2, FAULT, 10/100M (TP port), MSTR/HEAD and CPLR/TAIL
Alarm Contact	Two relay outputs with current carrying capacity of 1A @ 24 VDC
Digital Input	Two inputs with the same ground, but electrically isolated from the electronics <ul style="list-style-type: none"> • For state "1": +13 to +30V • For state "0": -30 to +3V • Max. input current: 8 mA
Power	
Input Voltage	24 VDC (12 to 45 VDC), redundant inputs
Input Current (@24V)	0.44A: (EDS-516A) 0.51A: (EDS-516A-MM-SC/ST)
Connection	Two removable 6-pin terminal blocks
Overload Current Protection	Present
Reverse Polarity Protection	Present
Mechanical	
Casing	IP30 protection, metal case
Dimensions	95 × 135 × 140 mm (W × H × D)
Weight	1.586 kg
Installation	DIN-Rail, Wall Mounting (optional kit)
Environment	
Operating Temperature	0 to 60°C (32 to 140°F) -40 to 75°C (-40 to 167°F) for -T models
Storage Temperature	-40 to 85°C (-40 to 185°F)
Ambient Relative Humidity	5% to 95% (non-condensing)

Regulatory Approvals	
Safety	UL 508, UL 60950-1 CSA C22.2 No. 60950-1, EN 60950-1
Hazardous Location	UL/cUL Class I, Division 2, Groups A, B, C, and D, ATEX Zone 2, Ex nA nC IIC T4 Gc
EMI	FCC Part 15, CISPR (EN 55022) class A
EMS	EN 61000-4-2 (ESD), Level 2 EN 61000-4-3 (RS), Level 3 EN 61000-4-4 (EFT), Level 2 EN 61000-4-5 (Surge), Level 3 EN 61000-4-6 (CS), Level 3 EN 61000-4-8 EN 61000-4-11 EN 61000-4-12
Shock	IEC 60068-2-27
Freefall	IEC 60068-2-32
Vibration	IEC 60068-2-6
WARRANTY	5 years

Technical Support Contact Information
www.moxa.com/support

Moxa Americas:

Toll-free: 1-888-669-2872

Tel: 1-714-528-6777

Fax: 1-714-528-6778

Moxa China (Shanghai office):

Toll-free: 800-820-5036

Tel: +86-21-5258-9955

Fax: +86-21-5258-5505

Moxa Europe:

Tel: +49-89-3 70 03 99-0

Fax: +49-89-3 70 03 99-99

Moxa Asia-Pacific:

Tel: +886-2-8919-1230

Fax: +886-2-8919-1231