

# NPort 5000AI-M12

## Quick Installation Guide

---

Edition 3.0, February 2017

### Technical Support Contact Information

[www.moxa.com/support](http://www.moxa.com/support)

Moxa Americas:

Toll-free: 1-888-669-2872

Tel: 1-714-528-6777

Fax: 1-714-528-6778

Moxa China (Shanghai office):

Toll-free: 800-820-5036

Tel: +86-21-5258-9955

Fax: +86-21-5258-5505

Moxa Europe:

Tel: +49-89-3 70 03 99-0

Fax: +49-89-3 70 03 99-99

Moxa Asia-Pacific:

Tel: +886-2-8919-1230

Fax: +886-2-8919-1231

Moxa India:

Tel: +91-80-4172-9088

Fax: +91-80-4132-1045



© 2017 Moxa Inc. All rights reserved.

P/N: 1802051503012



## Overview

NPort 5000AI-M12 device servers are designed to make serial devices instantly network-ready. They are compliant with EN 50155/EN 50121-4, making them suitable for rolling stock and wayside applications that are usually subject to high levels of vibration. Use Moxa's NPort 5000AI-M12 device servers to give your PC software direct access to serial devices from anywhere on a network.

## Package Checklist

Before installing an NPort 5000AI-M12 series device server, verify that the package contains the following items:

- 1 NPort 5000AI-M12 series device server
- Documentation and software CD
- Quick installation guide (printed)
- Warranty Card

### **Optional Accessories**

- DR-45-24: 45W/2A DIN-rail 24 VDC power supply with universal 85 to 264 VAC input
- DR-75-24: 75W/3.2A DIN-rail 24 VDC power supply with universal 85 to 264 VAC input
- DR-120-24: 120W/5A DIN-rail 24 VDC power supply with 88 to 132 VAC/176 to 264 VAC input
- DK-TN-5308: DIN-rail kit

*Note: Notify your sales representative if any of the above items are missing or damaged.*

## Hardware Introduction

The NPort 5150AI-M12 series has a 3-in-1 (RS-232/422/485) DB9 serial port for serial data communication, the NPort 5250AI-M12 series has two 3-in-1 (RS-232/422/485) DB9 serial ports for serial data communication, and the NPort 5450AI-M12 has four 3-in-1 (RS-232/422/485) DB9 serial ports for serial data communication.

### NPort 5150AI-M12 Appearance

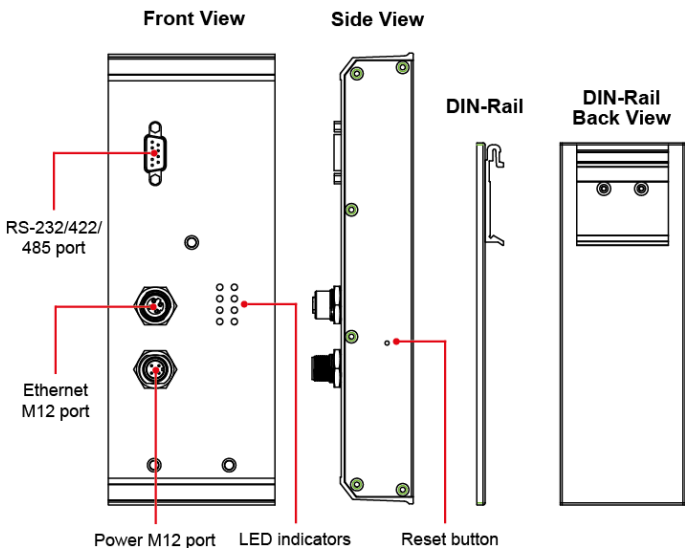

### NPort 5250AI-M12 Appearance

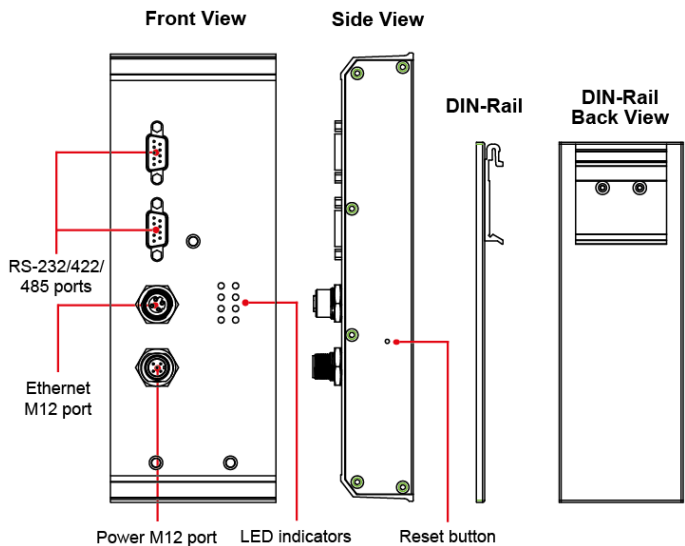

## NPort 5450AI-M12 Appearance

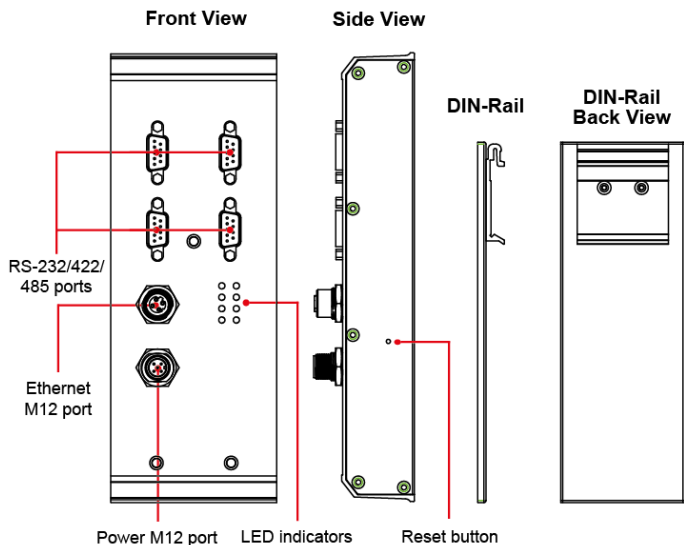

**The Reset to Default Button**—Press the reset button to default button for five seconds continuously to load the factory default settings. Use a pointed object, such as a straightened paper clip or toothpick, to press the reset button to default button. This will cause the Ready LED to blink on and off. The factory default settings are loaded once the Ready LED stops blinking (after about five seconds). At this point, you can release the reset button to default button.

### **NPort 5000AI-M12 LED Indicators (front panel)**

Name	Color	Function
PWR	green	Power is being supplied to the power input.
Ready	red	Steady on: Power is on, and NPort is booting up.
		Blinking: Indicates an IP conflict, or the DHCP/BOOTP server did not respond properly.
	green	Steady on: Power is on, and NPort is functioning normally.
		Blinking: The NPort has been located by NPort Administrator's Location function.
	off	Power is off, or a power error condition exists.
10M, 100M	orange	10 Mbps Ethernet connection.
	green	100 Mbps Ethernet connection.
	off	Ethernet cable is disconnected.
P1, P2, P3, P4	orange	Serial port is receiving data.
	green	Serial port is transmitting data.
	off	No data is being transmitted or received through the serial port.

## Hardware Installation Procedure

### Panel/Wall Mounting

Mounting the NPort 5000AI-M12 on the wall requires three screws. Please use the three screws provided in the product package.

**STEP 1:** Use the device to mark the positions of the three screw holes on the wall, as shown in the mounting dimensions diagram.

**STEP 2:** Use one screw to go through the top-middle screw hole on the device server and screw it into the wall.

**STEP 3:** Screw in the remaining two screws through the bottom-left and bottom-right holes on the device server to the wall.

**NOTE** Please use the screws (M3 x 40 mm) included.

### DIN-Rail Mounting (optional)

You may use the optional DIN-rail mounting kit (DK-TN-5308; must be purchased separately) to mount the NPort 5000AI-M12 on a 35 mm DIN rail.

**STEP 1:** Fix the DIN-rail attachment plate onto the rear panel of the device server as shown in the figure below.

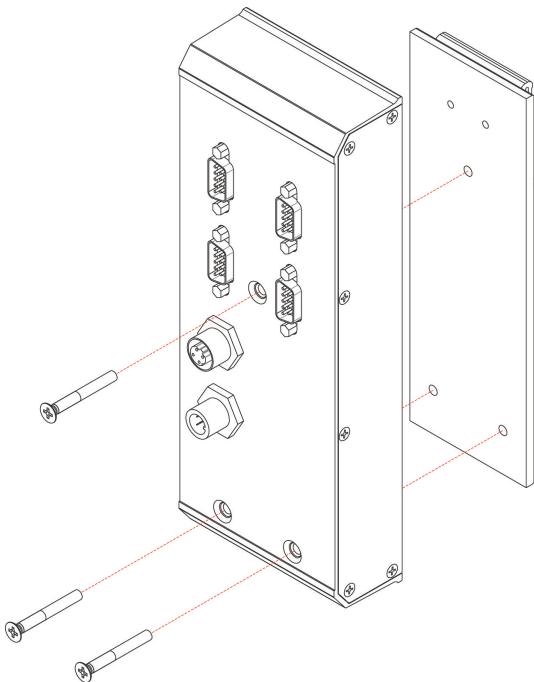

**STEP 2:** Position the NPort 5000AI-M12 on the DIN rail and tilt it to hook the clamps over the top edge of the rail.

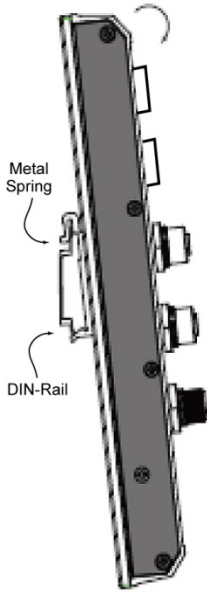

**STEP 3:** Swing the device server down onto the DIN rail until both clamps latch on completely.

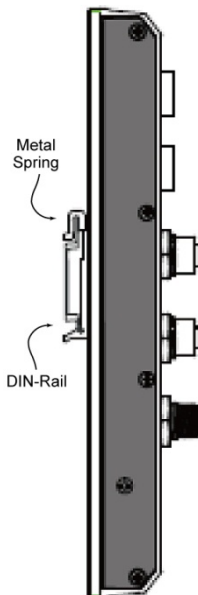

## Software Installation Information

To install **NPort Administration Suite**, insert the **Document & Software CD** into your computer's CD-ROM drive. Once the installation window opens, click on the **Installation Administration Suite** button and follow the instructions on the screen. To view detailed information about the **NPort Administration Suite**, click on the **Documents** button and select the NPort 5000AI-M12 series User's Manual to open the pdf version of this user's manual.

**NOTE** NPort 5000AI-M12 is supported with NPort Administrator in version 1.18.

## Pin Assignments and Cable Wiring

### Ethernet M12 D-coded 4-pin female connector:

PIN	TX
1	TD+
2	RD+
3	TD-
4	RD-

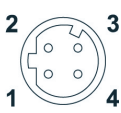

Housing: shield

### Power M12 5-pin male connector:



PIN	Description
1	Input V+
2	Not assigned
3	Input V-
4	Not assigned
5	Functional ground

### RS-232/422/485 (Male DB9) Pinouts

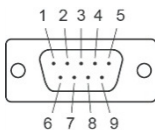

PIN	RS-232	RS-422/ RS-485 (4W)	RS-485 (2W)
1	DCD	TxD-(A)	-
2	RXD	TxD+(B)	-
3	TXD	RxD+(B)	Data+(B)
4	DTR	RxD-(A)	Data-(A)
5	GND	GND	GND
6	DSR	-	-
7	RTS	-	-
8	CTS	-	-
9	-	-	-

Four cables are available as optional accessories that can be used to connect the NPort 5000AI-M12 series to RS-232 serial devices. The pin assignments for both connector types are shown below.

### Female DB9 to Male DB9

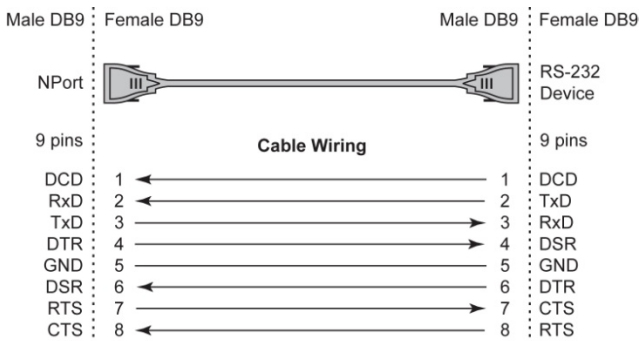

## Specifications

Physical Characteristics	
Housing	Metal, IP40 protection
Dimensions	80 x 216.6 x 52.9 mm (3.14 x 8.53 x 2.08 in)
Environmental Limits	
Operating Temperature	<ul style="list-style-type: none"> <li>Standard Models: -25 to 55°C (32 to 140°F)</li> <li>Wide Temperature Models: -40 to 75°C (-40 to 167°F)</li> </ul>
Operating Humidity	5 to 95% RH
Storage Temperature	-40 to 85°C (-40 to 185°F)
Conformal coating	
Available on –CT models	
Power Input (Need to modularize)	
Input Voltage	12/24/36/48 VDC (8.4 to 60 VDC)
Power Consumption	NPort 5150AI-M12: 310 mA @12V NPort 5150AI-M12-CT: 310 mA @12V NPort 5150AI-M12-T: 310 mA @12V NPort 5250AI-M12: 360 mA @12V NPort 5250AI-M12-CT: 360 mA @12V NPort 5250AI-M12-T: 360 mA @12V NPort 5450AI-M12: 440 mA @12V NPort 5450AI-M12-CT: 440 mA @12V NPort 5450AI-M12-T: 440 mA @12V
Connector	M12 5-pin male connector
Power Line Protection	Meets EN 50155 certification
Regulatory Approvals	
EMC	CE (EN 55032 Class A, EN 55024) (EMI), FCC Part 15 Subpart B Class A (EMS)
Safety	UL (UL60950-1)
Rail Traffic	EN 50155*, EN 50121-4
<b>*Complies with a portion of EN 50155 specifications. Please contact Moxa or a Moxa distributor for details.</b>	
Shock	IEC 61373
Vibration	IEC 61373



Freefall	IEC 60068-2-32
<b>Reliability</b>	
Alert Tools	Built-in buzzer and RTC
Automatic Reboot Trigger	Built-in WDT (watchdog timer)
MTBF (mean time between failures)	NPort 5150AI-M12: 789,341 hrs. NPort 5250AI-M12: 639,622 hrs. NPort 5450AI-M12: 467,777 hrs.
<b>Warranty</b>	
Warranty Period	5 years
Details	See <a href="http://www.moxa.com/warranty">www.moxa.com/warranty</a>
For railway rolling stock applications, the device must use a galvanically isolated power supply that is compliant with the EN 50155 standard.	