

# **NPort S8000 Series User's Manual**

---

**Edition 7.0, November 2017**

[www.moxa.com/product](http://www.moxa.com/product)

**MOXA<sup>®</sup>**

© 2017 Moxa Inc. All rights reserved.

# NPort S8000 Series User's Manual

The software described in this manual is furnished under a license agreement and may be used only in accordance with the terms of that agreement.

## Copyright Notice

© 2017 Moxa Inc. All rights reserved.

## Trademarks

The MOXA logo is a registered trademark of Moxa Inc.  
All other trademarks or registered marks in this manual belong to their respective manufacturers.

## Disclaimer

Information in this document is subject to change without notice and does not represent a commitment on the part of Moxa.

Moxa provides this document as is, without warranty of any kind, either expressed or implied, including, but not limited to, its particular purpose. Moxa reserves the right to make improvements and/or changes to this manual, or to the products and/or the programs described in this manual, at any time.

Information provided in this manual is intended to be accurate and reliable. However, Moxa assumes no responsibility for its use, or for any infringements on the rights of third parties that may result from its use.

This product might include unintentional technical or typographical errors. Changes are periodically made to the information herein to correct such errors, and these changes are incorporated into new editions of the publication.

## Technical Support Contact Information

[www.moxa.com/support](http://www.moxa.com/support)

### **Moxa Americas**

Toll-free: 1-888-669-2872  
Tel: +1-714-528-6777  
Fax: +1-714-528-6778

### **Moxa Europe**

Tel: +49-89-3 70 03 99-0  
Fax: +49-89-3 70 03 99-99

### **Moxa India**

Tel: +91-80-4172-9088  
Fax: +91-80-4132-1045

### **Moxa China (Shanghai office)**

Toll-free: 800-820-5036  
Tel: +86-21-5258-9955  
Fax: +86-21-5258-5505

### **Moxa Asia-Pacific**

Tel: +886-2-8919-1230  
Fax: +886-2-8919-1231

# Table of Contents

<b>1. Introduction</b>	<b>1-1</b>
Overview	1-2
Industrial Communications and Automation	1-2
Industrial vs. Commercial	1-2
Informative vs. Passive	1-2
Package Checklist	1-2
Product Features	1-3
<b>2. Getting Started</b>	<b>2-1</b>
Panel Layout	2-2
Dimensions	2-3
NPort S8455 Series	2-3
NPort S8458 Series	2-4
Connecting the Hardware	2-4
Wiring Requirements	2-5
Connecting the Power	2-5
Connecting to the Network	2-6
Connecting to a Serial Device	2-6
LED Indicators	2-6
Adjustable Pull High/low Resistors and Terminators for the RS-485 Port (NPort S8455I Series only)	2-6
Wiring the Relay Contact	2-7
Wiring the Digital Inputs	2-8
<b>3. Initial IP Address Configuration</b>	<b>3-1</b>
Static and Dynamic IP Addresses	3-2
Factory Default IP Address	3-2
Configuration Options	3-2
Device Search Utility	3-2
Web Console	3-2
ARP	3-2
SSH Console	3-3
Serial Console	3-7
<b>4. Choosing the Serial Operation Mode</b>	<b>4-1</b>
Overview	4-2
Real COM Mode	4-2
RFC2217 Mode	4-3
TCP Server Mode	4-3
TCP Client Mode	4-3
UDP Mode	4-4
Disabled Mode	4-4
<b>5. Use Real COM Mode to Communicate with Serial Devices</b>	<b>5-1</b>
Overview	5-2
Device Search Utility	5-2
Installing the Device Search Utility	5-2
Find a Specific NPort on the Ethernet Network via the DSU	5-5
Opening Your Browser	5-6
Configure Operation Mode to Real COM Mode	5-8
NPort Windows Driver Manager	5-9
Installing the NPort Windows Driver Manager	5-9
Using NPort Windows Driver Manager	5-12
Linux Real TTY Drivers	5-19
Basic Procedures	5-19
Hardware Setup	5-20
Installing Linux Real TTY Driver Files	5-20
Mapping TTY Ports	5-20
Removing Mapped TTY Ports	5-21
Removing Linux Driver Files	5-21
The UNIX Fixed TTY Driver	5-21
Installing the UNIX Driver	5-21
Configuring the UNIX Driver	5-22
<b>6. Basic Settings and Device Server Configuration</b>	<b>6-1</b>
Basic Settings	6-2
General Settings	6-2
Time Settings	6-3
Network Settings	6-4
Serial Settings	6-7
Operation Modes	6-7
Serial Parameters	6-22

Serial ToS Settings .....	6-24
<b>7. Switch Featured Functions .....</b>	<b>7-1</b>
Ethernet Settings.....	7-2
Port Settings.....	7-2
Port Trunking.....	7-3
Communication Redundancy .....	7-5
STP/RSTP .....	7-15
The STP/RSTP Concept .....	7-15
Configuring STP/RSTP.....	7-19
Configuration Limits of STP/RSTP .....	7-20
Bandwidth Management .....	7-21
Using Bandwidth Management .....	7-21
Configuring Bandwidth Management.....	7-21
Line Swap Fast Recovery .....	7-21
Using Line-Swap-Fast-Recovery .....	7-21
Configuring Line-Swap Fast Recovery .....	7-22
Ethernet Advanced Settings .....	7-22
Ethernet Traffic Prioritization .....	7-22
The Traffic Prioritization Concept.....	7-23
Configuring Ethernet Traffic Prioritization .....	7-24
Virtual LAN .....	7-27
Using Virtual LAN .....	7-27
The Virtual LAN (VLAN) Concept.....	7-27
Configuring Virtual LAN .....	7-31
Multicast Filtering .....	7-33
Using Multicast Filtering .....	7-33
The Concept of Multicast Filtering .....	7-33
Configuring IGMP Snooping .....	7-35
IGMP Snooping Settings.....	7-36
Configuring GMRP.....	7-38
Set Device IP .....	7-38
Using Set Device IP .....	7-38
Configuring Set Device IP .....	7-39
System Management.....	7-40
Misc. Network Settings.....	7-40
Syslog Server .....	7-41
Using Syslog.....	7-41
Local User Database .....	7-43
Port Access Control.....	7-43
Configuring Static Port Lock.....	7-45
Configuring IEEE 802.1X .....	7-46
Auto Warning Settings .....	7-47
Configuring E-Mail Alert.....	7-47
Configuring SNMP.....	7-49
SNMP Read/Write Settings.....	7-50
E-mail Event Settings .....	7-51
SNMP Trap .....	7-53
Relay Alarm Settings .....	7-54
System Log Settings.....	7-55
Maintenance .....	7-57
Console Settings .....	7-57
Ping.....	7-57
Update System Files from Local PC.....	7-58
Load Factory Default.....	7-60
Change Password .....	7-61
Mirror Port Settings .....	7-61
TFTP Settings.....	7-62
DIP Switch Settings .....	7-63
System Monitoring .....	7-65
Serial Status.....	7-65
System Status .....	7-67
Ethernet Status.....	7-68
Restart.....	7-73
Restart System .....	7-73
Restart Serial Port.....	7-74
<b>A. Pinouts and Cable Wiring .....</b>	<b>A-1</b>
Port Pinout Diagrams .....	A-2
Ethernet Port Pinouts.....	A-2
Serial Port Pinouts.....	A-2
Cable Wiring Diagrams .....	A-3
Ethernet Cables.....	A-3

<b>B. Well-Known Port Numbers .....</b>	<b>B-1</b>
<b>C. SNMP Agents with MIB II &amp; RS-232 Like Groups .....</b>	<b>C-1</b>
<b>D. Switch MIB Groups.....</b>	<b>D-1</b>
<b>E. Compliance Note .....</b>	<b>E-1</b>

# Introduction

---

The Moxa NPort S8000 is an advanced industrial serial device server integrated with a fully managed redundant Ethernet switch, which enables easy network operation for your serial devices and connects Ethernet-enabled devices in industrial field applications.

The NPort S8000 Series includes seven models:

- **NPort S8455I**  
Combination switch / device server with 4 RS-232/422/485 ports, 5 10/100M Ethernet ports, RJ45 connector, 12–48 VDC, 0 to 60°C operating temperature
- **NPort S8455I-T**  
Combination switch / device server with 4 RS-232/422/485 ports, 5 10/100M Ethernet ports, RJ45 connector, 12–48 VDC, -40 to 75°C operating temperature
- **NPort S8455I-MM-SC**  
Combination switch / device server with 4 RS-232/422/485 ports, 3 10/100M Ethernet ports, 2 100M multimode fiber ports, SC connector, 12–48 VDC, 0 to 60°C operating temperature
- **NPort S8455I-MM-SC-T**  
Combination switch / device server with 4 RS-232/422/485 ports, 3 10/100M Ethernet ports, 2 100M multimode fiber ports, SC connector, 12–48 VDC, -40 to 75°C operating temperature
- **NPort S8455I-SS-SC**  
Combination switch / device server with 4 RS-232/422/485 ports, 3 10/100M Ethernet ports, 2 100M single-mode fiber ports, SC connector, 12–48 VDC, 0 to 60°C operating temperature
- **NPort S8455I-SS-SC-T**  
Combination switch / device server with 4 RS-232/422/485 ports, 3 10/100M Ethernet ports, 2 100M single-mode fiber ports, SC connector, 12–48 VDC, -40 to 75°C operating temperature
- **NPort S8458-4S-SC-T**  
4 RS-232/422/485 ports, 4 10/100M Ethernet ports, 4 100M single-mode fiber ports with SC connector, combo switch serial device server, 12-48 VDC, -40 to 85°C operating temperature

The following topics are covered in this chapter:

- **Overview**
  - Industrial Communications and Automation
  - Industrial vs. Commercial
  - Informative vs. Passive
- **Package Checklist**
- **Product Features**

# Overview

The NPort S8000 is an industrial device server that integrates a managed Ethernet switch with a fully functional serial device server. The NPort S8000 device servers are designed to make your industrial serial devices instantly Internet-ready.

The NPort S8458 offers four fiber Ethernet ports, four Ethernet ports, and four RS-232/422/485 serial ports in a single device. Its design not only saves cabinet space and reduces power consumption, but also saves money since you don't need to purchase separate switches and serial device servers.

The compact size of the NPort S8000 device servers makes them the ideal choice for connecting RS-232/422/485 serial devices, such as PLCs, meters, and sensors, to an IP-based Ethernet LAN, making it possible for your software to access serial devices anywhere over a LAN or the Internet.

The NPort S8000 is a fully equipped managed Ethernet Switch with a suite of useful maintenance and monitoring functions, and it is designed to provide smooth and reliable operation in harsh industrial environments. It is ideal for keeping automation systems running continuously, sending status reports to help prevent system damage and losses, and managing your industrial Ethernet networks and serial devices.

## Industrial Communications and Automation

As the world's networking and information technology becomes more complex, Ethernet has become the major communications interface in many industrial communications and automation applications. In fact, a whole new industry has sprung up to provide Ethernet products that comply with the requirements of demanding industrial applications.

## Industrial vs. Commercial

Users have found that when transplanting Ethernet from comfortable office environments to harsh and less predictable industrial environments, commercial Ethernet equipment available in today's market simply cannot meet the high-reliability requirements demanded by industrial applications. This means that more robust networking equipment, commonly referred to as industrial Ethernet equipment, is required for these applications.

## Informative vs. Passive

Since industrial Ethernet devices are often located at the endpoints of a system, such devices cannot always know what's happening elsewhere on the network. This means that industrial Ethernet communication equipment that connects these devices must provide system administrators with real-time alarm messages.

## Package Checklist

The Moxa NPort S8000 Series products are shipped with the following items:

### **Standard Accessories**

- 1 NPort S8000 serial device server
- NPort Document & Software CD
- NPort S8000 Series Quick Installation Guide
- Product warranty statement
- RJ45-to-DB9 console port cable

### **Optional Accessories**

- Wall-mounting kit

**NOTE: Notify your sales representative if any of the above items is missing or damaged.**

# Product Features

The NPort S8000 Series products enjoy the following features:

- Make your serial devices Internet ready
- Versatile socket operation modes, including TCP Server, TCP Client, and UDP
- Easy-to-use Windows Utility for mass installation
- Supports 10/100 Mbps Ethernet—auto detectable
- Supports SNMP MIB-II for network management
- Configuration auto-restore by LLDP (Link Layer Discovery Protocol)
- Configurable serial data transmission priority
- Multiport managed Ethernet switch
- Ethernet redundancy by Turbo Ring (recovery time < 20 ms), RSTP/STP (IEEE 802.1w/D)
- QoS, IGMP snooping/GMRP, VLAN, LACP, SNMPv1/v2c/v3, RMON supported
- 4 serial ports device server, support RS-232/422/RS-485
- 2k VDC isolation protection for serial port (the NPort S8455I Series only)
- Surge protection for serial/power/Ethernet
- Adjustable pull high/low resistor and terminators for the RS-485 port (the NPort S8455I Series only)
- 2- or 4-wire RS-485 with patented ADDC™ (Automatic Data Direction Control)



## Getting Started

---

This chapter details the installation of the NPort S8000 series device servers. Note that the manual uses the NPort S8455 Series as an example to illustrate the functionality of the NPort S8000 Series in chapters 2, 3, 4, 6 and 7.

The following topics are covered in this chapter:

▣ **Panel Layout**

▣ **Dimensions**

- NPort S8455 Series
- NPort S8458 Series

▣ **Connecting the Hardware**

- Wiring Requirements
- Connecting the Power
- Connecting to the Network
- Connecting to a Serial Device
- LED Indicators
- Adjustable Pull High/low Resistors and Terminators for the RS-485 Port (NPort S8455I Series only)
- Wiring the Relay Contact
- Wiring the Digital Inputs

# Panel Layout

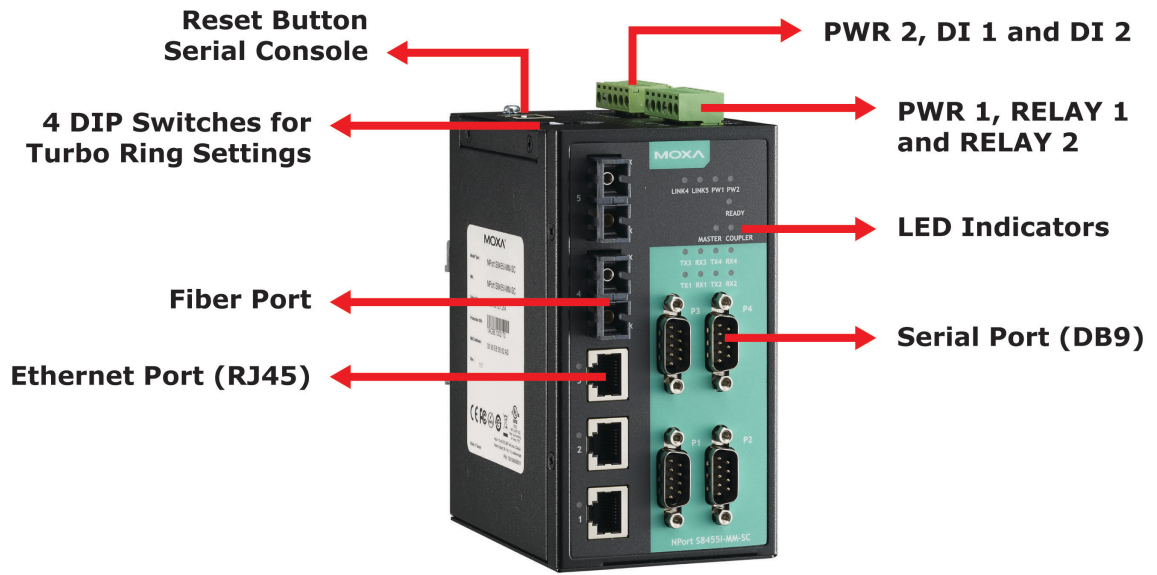

**NPort S8455 Series**

# Dimensions

## NPort S8455 Series

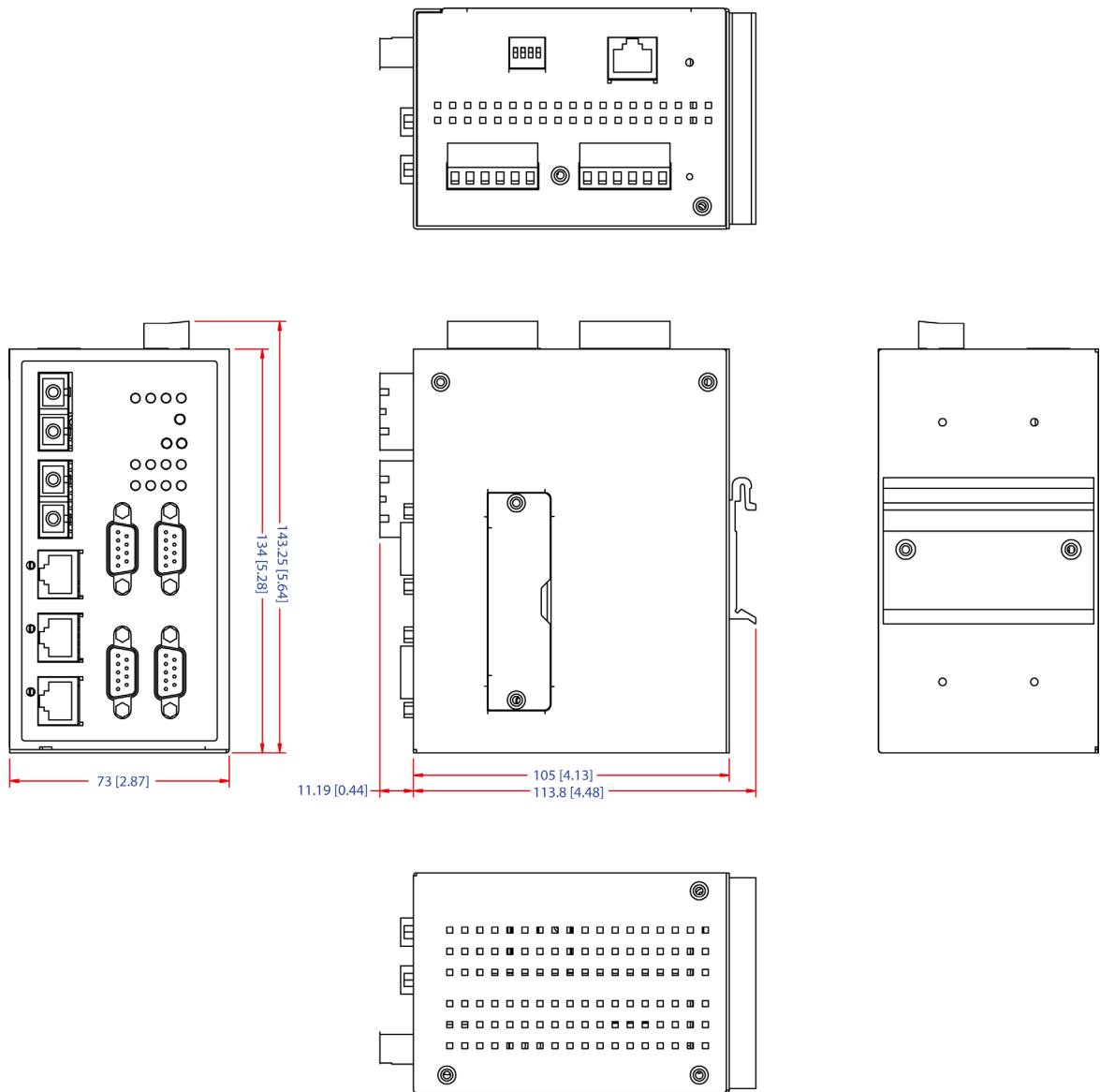

# NPort S8458 Series

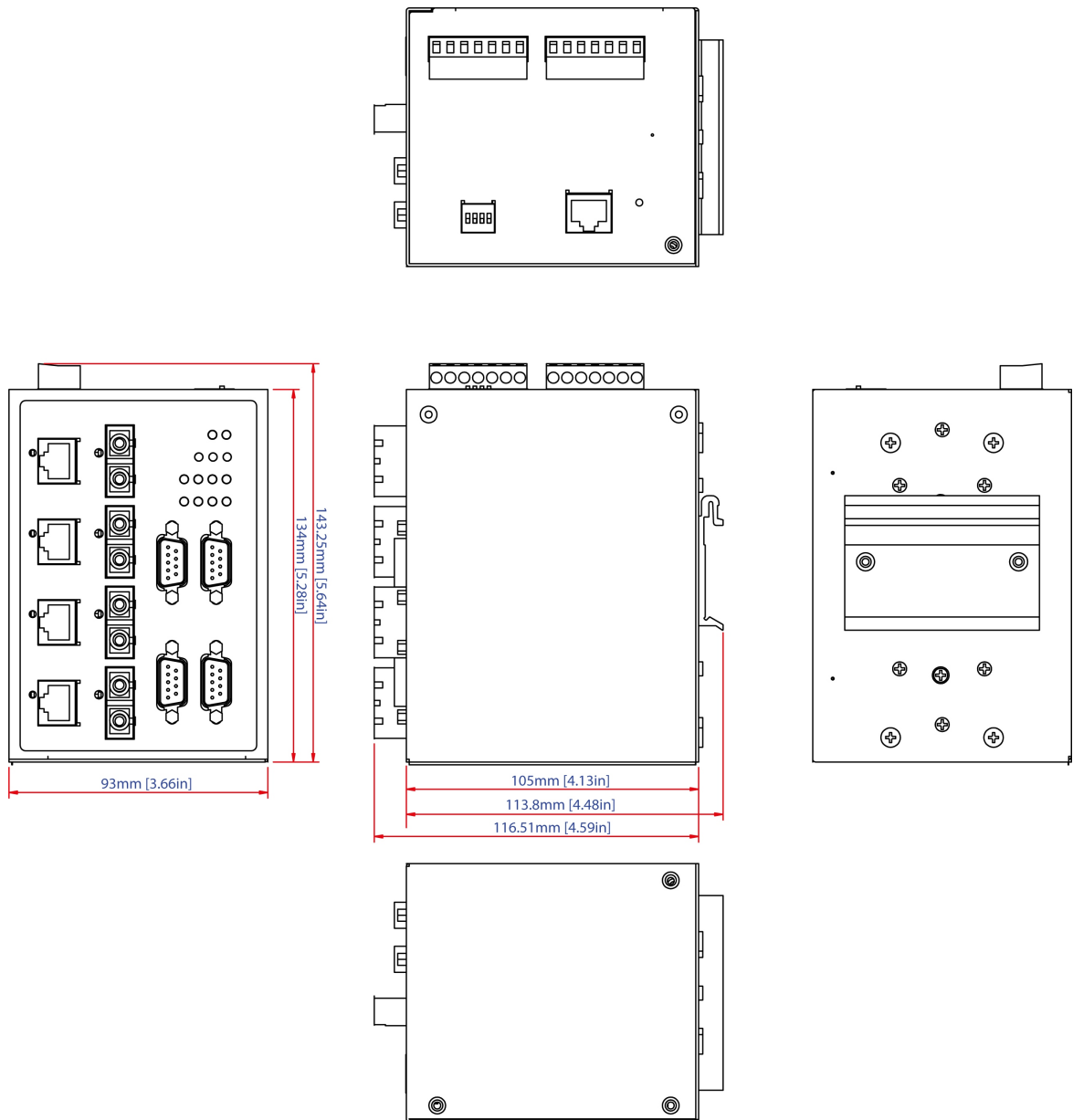

## Connecting the Hardware

This section describes how to connect the NPort S8000 to serial devices for initial testing purposes. We cover **Wiring Requirements**, **Connecting the Power**, **Grounding the NPort S8000**, **Connecting to the Network**, **Connecting to a Serial Device**, and **LED Indicators**.

## Wiring Requirements



### ATTENTION

#### Safety First!

Be sure to disconnect the power cord before installing and/or wiring your NPort S8000.

#### Wiring Caution!

Calculate the maximum possible current in each power wire and common wire. Observe all electrical codes dictating the maximum current allowable for each wire size.

If the current goes above the allowed maximum, the wiring could overheat, causing serious damage to your equipment.

#### Temperature Caution!

Please take care when handling the NPort S8000. When plugged in, the NPort S8000's internal components generate heat; consequently, the casing may be too hot to touch.

You should heed the following:

- Use separate paths to route wiring for power and devices. If power wiring and device wiring paths must cross, make sure the wires are perpendicular at the intersection point.  
NOTE: Do not run signal or communication wiring and power wiring in the same wire conduit. To avoid interference, wires with different signal characteristics should be routed separately.
- You can use the type of signal transmitted through a wire to determine which wires should be kept separate. The rule of thumb is that wiring that shares similar electrical characteristics can be bundled together.
- Keep input wiring and output wiring separate.
- Where necessary, it is strongly advised that you label wiring to all devices in the system.

## Connecting the Power

Connect the 12-48 VDC power line with the NPort S8000's terminal block. If the power is properly supplied, the "Ready" LED will show a solid red color until the system is ready, at which time the "Ready" LED will change to a green color.

Take the following steps to wire the redundant power inputs:

1. Insert the negative/positive DC wires into the V-/V+ terminals.
2. To keep the DC wires from pulling loose, use a small flat-blade screwdriver to tighten the wire-clamp screws on the front of the terminal block connector.
3. Insert the plastic terminal block connector prongs into the terminal block receptor, which is located on the EDS's top panel.

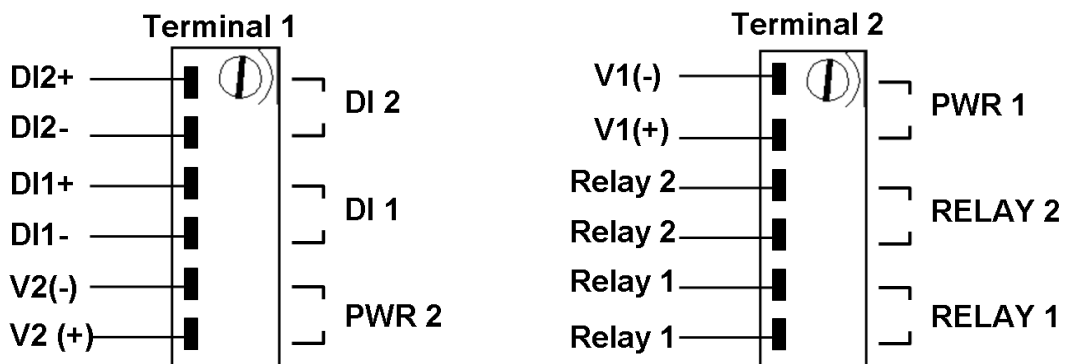

## Connecting to the Network

Connect one end of the Ethernet cable to the NPort S8000's 10/100M Ethernet port and the other end of the cable to the Ethernet network. If the cable is properly connected, the NPort S8000 will indicate a valid connection to the Ethernet in the following ways:

- The Ethernet LED maintains a solid green color when connected to a 100 Mbps Ethernet network.
- The Ethernet LED will flash when Ethernet packets are being transmitted or received.

## Connecting to a Serial Device

Connect the serial data cable between the NPort S8000 and the serial device.

## LED Indicators

The LED indicators of the NPort S8000 Series are described in the following table.

Type	Color	Meaning
PWR 1	Green	Power 1 input
PWR 2	Green	Power 2 input
LINK (FX)	Green	FX port 100 Mbps is active
	Blinking	Data is being transmitted/received at 100 Mbps
LINK	Green	100 Mbps Ethernet connection
	Blinking	10 Mbps Ethernet connection
Master	Green	When the NPort is the Master of this Turbo Ring
	Yellow	When the NPort is the Ring Master of this Turbo Ring and the Turbo Ring is broken
Coupler	Green	When the NPort enables the coupling function to form a backup path
Serial Port TX	Green	The serial port is transmitting data.
Serial Port RX	Yellow	The serial port is receiving data.
Ready	Red	Steady On: Power is on, and NPort is booting up. Blinking: Indicates an LAN-IP conflict, or the DHCP or BOOTP server did not respond properly.
	Green	Steady On: Power is on, and NPort is functioning normally. Blinking: The device server has been located by Administrator's Location function.
	Off	Power is off, or power error condition exists.

## Adjustable Pull High/low Resistors and Terminators for the RS-485 Port (NPort S8455I Series only)

In some critical environments, you may need to add termination resistors to prevent the reflection of serial signals. When using termination resistors, it is important to set the pull high/low resistors correctly so that the electrical signal is not corrupted. Since there is no resistor value that works for every environment, DIP switches are used to set the pull high/low resistor values for each RS-485 port.

**To set the pull high/low resistors to 150 K $\Omega$** , make sure both of the assigned DIP switches are in the OFF position. This is the default setting.

**To set the pull high/low resistors to 1 K $\Omega$** , make sure both of the assigned DIP switches are in the ON position.

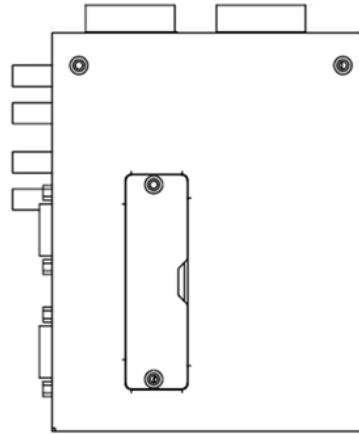

SW	1	2	3	4	3 & 4
	Pull High	Pull Low	Terminator	Terminator	Terminator
ON	1 K $\Omega$	1 K $\Omega$	120 $\Omega$	100 $\Omega$	55 $\Omega$
Default OFF	150 K $\Omega$	150 K $\Omega$	-	-	-



**ATTENTION**

Do not set the resistors to 1 K $\Omega$ . When using RS-232. Doing so will degrade the RS-232 signals and reduce the effective communication distance.

## Wiring the Relay Contact

The NPort 8455I Series has two sets of relay output: relay 1 and relay 2. Each relay contact consists of two contacts of the terminal block on the NPort 8455I's top panel. Refer to the next section for detailed instructions on how to connect the wires to the terminal block connector and how to attach the terminal block connector to the terminal block receptor. The two contacts used to connect the relay contacts work as follow (illustrated below):

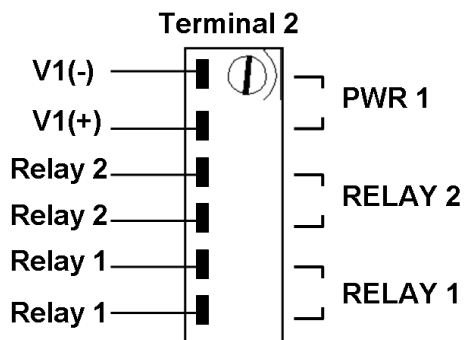

The fault circuit will open if

1. A relay warning event is triggered,  
OR
2. The NPort S8000 is the Master of this Turbo Ring, and the Turbo Ring is broken,  
OR
3. Start-up failure.

If none of these three conditions are met, the fault circuit will remain closed.

## Wiring the Digital Inputs

The NPort 8455I unit has two sets of digital inputs, DI 1 and DI 2. Each DI consists of two contacts of the 6-pin terminal block connector on the NPort 8455I's top panel. The remaining contacts are used for the NPort 8455I's two DC inputs. The top and front views of one of the terminal block connectors are shown below.

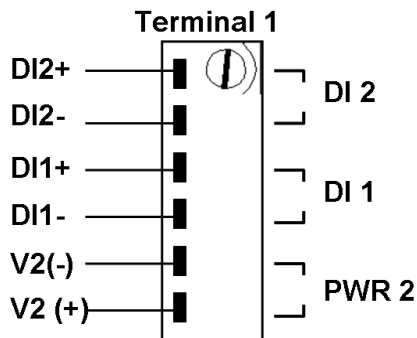

Take the following steps to wire the digital inputs:

1. Insert the negative (ground)/positive DI wires into the  $\pm$ /I1 terminals.
2. To keep the DI wires from pulling loose, use a small flat-blade screwdriver to tighten the wire-clamp screws on the front of the terminal block connector.
3. Insert the plastic terminal block connector prongs into the terminal block receptor, which is located on the NPort 8455I's top panel.



# Initial IP Address Configuration

---

When setting up the NPort S8000 for the first time, the first thing you should do is configure its IP address. This chapter introduces the different methods that can be used.

The following topics are covered in this chapter:

- ❑ **Static and Dynamic IP Addresses**
- ❑ **Factory Default IP Address**
- ❑ **Configuration Options**
  - Device Search Utility
  - Web Console
  - ARP
  - SSH Console
  - Serial Console

# Static and Dynamic IP Addresses

Determine whether your NPort S8000 needs to use a static IP or dynamic IP address (either DHCP or BOOTP application).

- **If your NPort S8000 is used in a static IP environment**, you will assign a specific IP address using one of the tools described in this chapter.
- **If your NPort S8000 is used in a dynamic IP environment**, the IP address will be assigned automatically over the network. In this case, set the IP configuration mode to DHCP, BOOTP.



## ATTENTION

Consult your network administrator on how to reserve a fixed IP address for your NPort S8000 in the MAC-IP mapping table when using a DHCP server or BOOTP server. For most applications, you should assign a fixed IP address to your NPort S8000.

## Factory Default IP Address

The NPort S8000 is configured with the following default private IP address:

**192.168.127.254**

Note that IP addresses that begin with "192.168" are referred to as private IP addresses. Devices configured with a private IP address are not directly accessible from a public network. For example, you would not be able to ping a device with a private IP address from an outside Internet connection. If your application requires sending data over a public network, such as the Internet, your NPort S8000 will need a valid public IP address, which can be leased from a local ISP.

## Configuration Options

### Device Search Utility

You may configure your NPort S8000 with the bundled Device Search Utility (DSU) for Windows platform. Note that you will be asked to enter the username and password to access the NPort S8000 device. The default username is **admin** and the default password is **moxa**. Please refer to Chapter 5, "Use Real COM Mode to Communicate with Serial Devices", for details on how to install and use the DSU.

### Web Console

You may configure your NPort S8000 using a standard web browser. Note that you will be asked to enter the username and password to access the NPort S8000 device. The default username is **admin** and the default password is **moxa**. Please refer to Chapter 6, "Basic Settings and Device Server Configuration", for details on how to access and use the NPort S8000 web console.

### ARP

You may use the Address Resolution Protocol (ARP) command to set up an IP address for your NPort S8000. The ARP command tells your computer to associate the NPort S8000's MAC address with an IP address. Afterwards, use Telnet to access the NPort S8000 and its IP address will be reconfigured.



**ATTENTION**

In order to use the ARP setup method, both your computer and the NPort S8000 must be connected to the same LAN. Alternatively, you may use a crossover Ethernet cable to connect the NPort S8000 directly to your computer's Ethernet card. Before executing the ARP command, your NPort S8000 must be configured with the factory default IP address (192.168.127.254), and your computer and the NPort S8000 must be on the same subnet.

To use ARP to configure the IP address, complete the following:

1. Obtain a valid IP address for your NPort S8000 from your network administrator.
2. Obtain your NPort S8000's MAC address from the label on the bottom panel.
3. Execute the arp -s command from your computer's MS-DOS prompt (for Windows 7 or newer OS, please ensure you have the administrator authority to execute the MS-DOS prompt) as follows:

```
arp -s <IP address> <MAC address>
```

For example,

```
C:\> arp -s 192.168.200.100 00-90-E8-04-00-11
```

4. Next, execute a special Telnet command by entering the following exactly:

```
telnet 192.168.200.100 6000
```

When you enter this command, a **Connect failed** message will appear, as shown below.

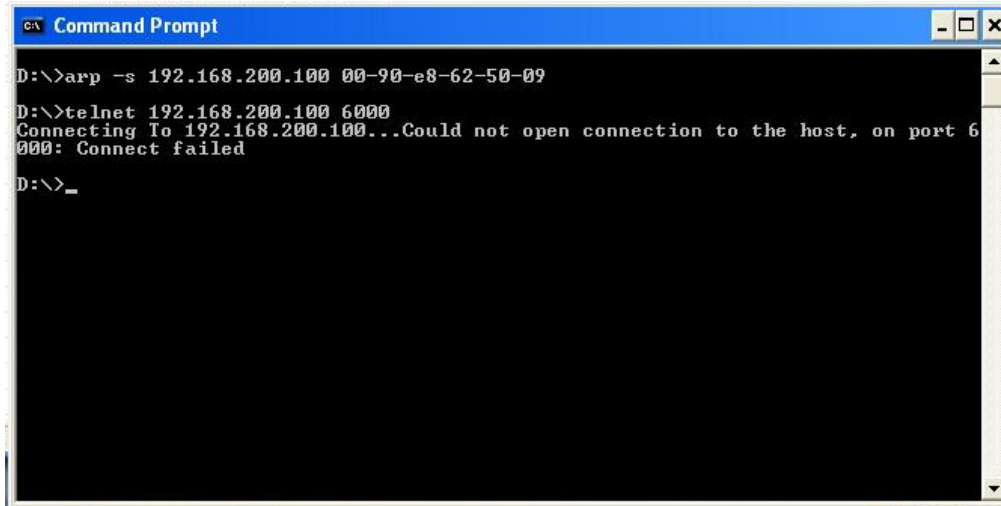

5. After the NPort S8000 reboots, its IP address will be assigned to the new address, and you can reconnect using Telnet to verify that the update was successful.

## SSH Console

Depending on how your computer and network are configured, you may find it convenient to use network access to set up your NPort S8000's IP address. This can be done using Telnet/SSH. The instructions below will be introduced by using SSH, which offers security mechanisms that protect users against any malicious behavior.

1. It's easy to find SSH client software on the Internet. Please download, install, and execute it and input the destination NPort's IP and the TCP port to accept the SSH session.

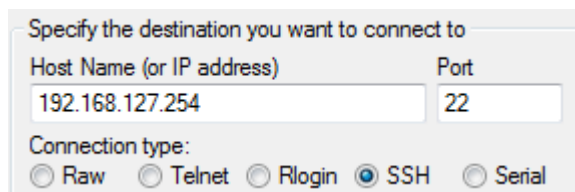

- The console terminal type selection is displayed as shown. Enter the username and password to log in to the SSH console. The default username and password are **admin** and **moxa**, respectively.

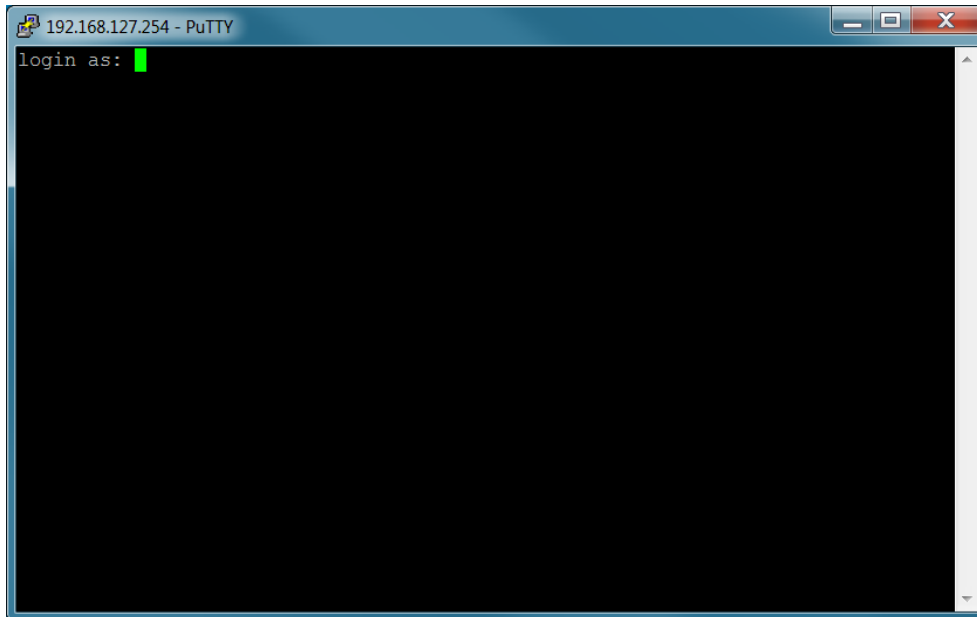

- Enter **1** for **ansi/vt100** and press **ENTER** to continue.

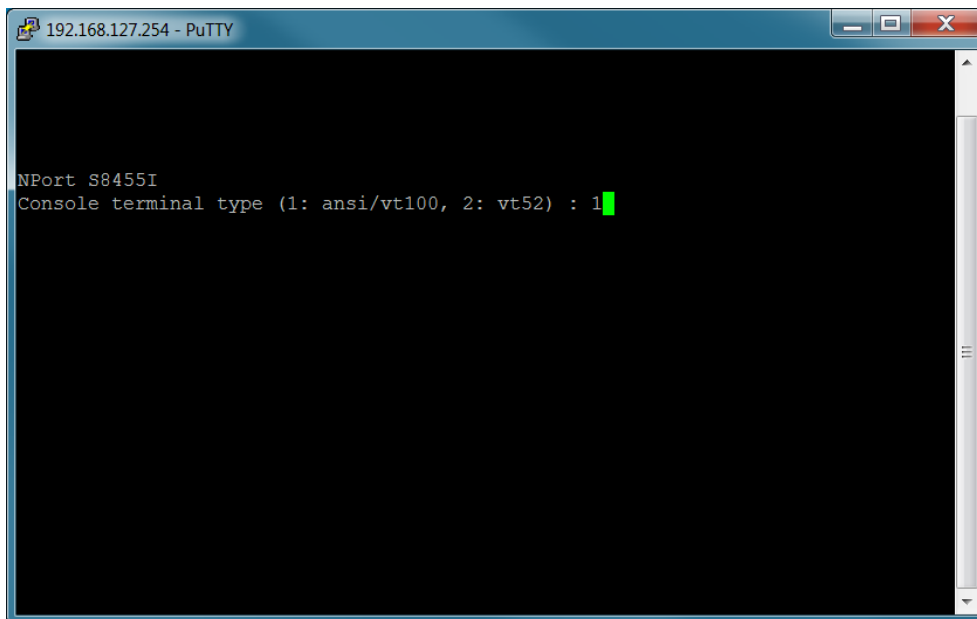

4. Press **B**, or use the arrow keys to select **Basic** and then press **ENTER** to configure Basic settings.

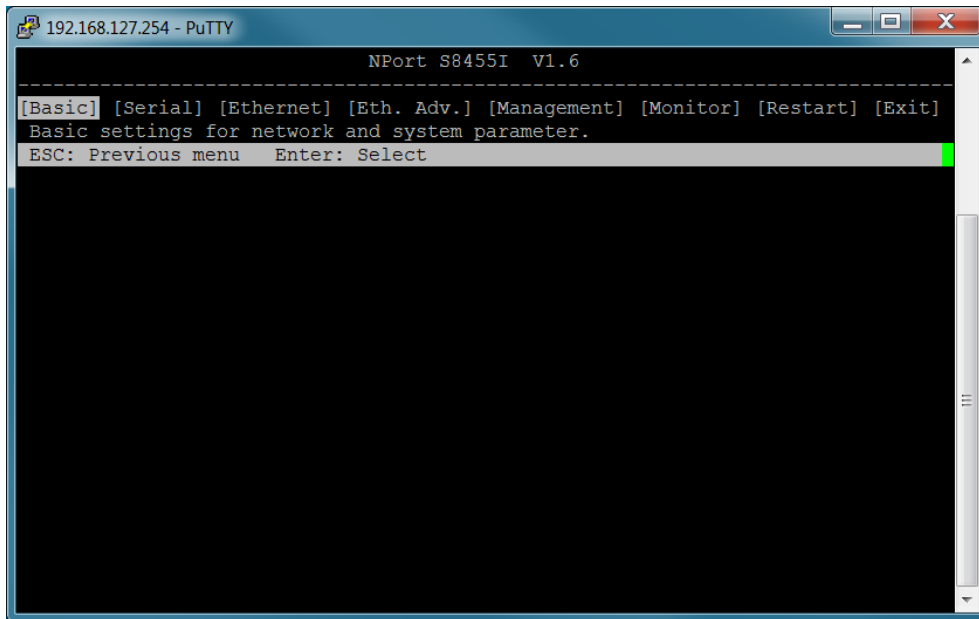

5. Press **N**, or use the arrow keys to select **Network** and then press **ENTER** to configure **Network parameters**.

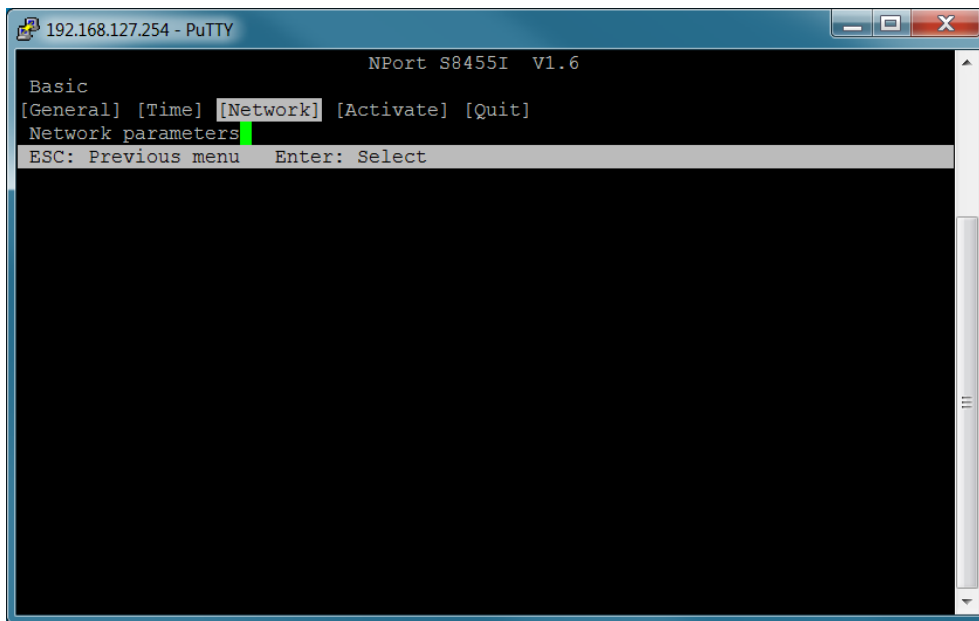

- Use the arrow keys to move the cursor to System IP address. Use the **Delete**, **Backspace**, or **Space** key to erase the current IP address, and then type in the new IP address and press **Enter**. If you are using a dynamic IP configuration (BOOTP or DHCP), you will need to go to the Auto IP configuration field and press **Enter** to select the appropriate configuration.

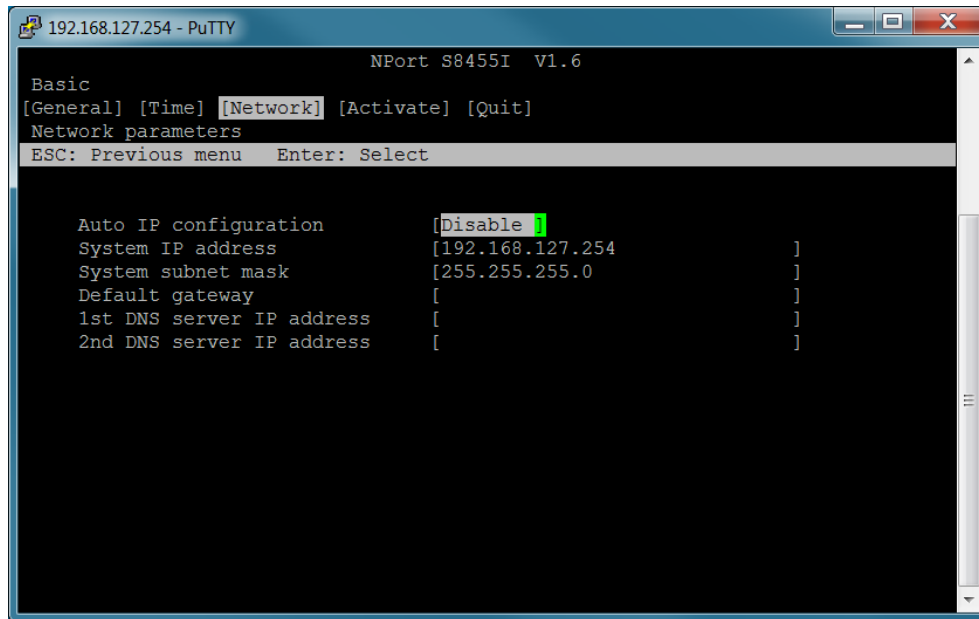

- Press **Esc** to return to the previous page. Select **Activate** and press **Y** to confirm the modification and activate the new settings.

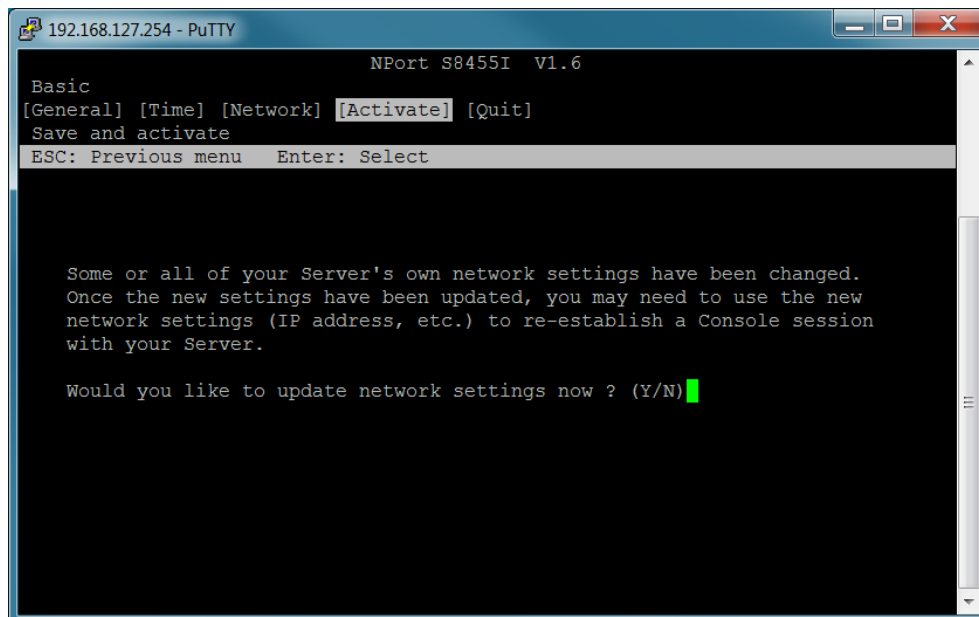

## Serial Console

The NPort S8000 supports configuration through the serial console, which is the same as the Telnet console but accessed through the RS-232 console port rather than through the network. Once you have entered the serial console, the configuration options and instructions are the same as if you were using the Telnet console.

The following instructions and screenshots show how to enter the serial console using PComm Terminal Emulator, which is available free of charge as part of the PComm Lite suite. You may use a different terminal emulator utility, although your actual screens and procedures may vary slightly from the following instructions.

1. Use a serial cable to connect the NPort S8000's serial console port to your computer's male RS-232 serial port.



### ATTENTION

The NPort S8000 has a dedicated serial console port.

2. From the Windows desktop select **Start → All Programs → PComm Lite → Terminal Emulator**.
3. The PComm Terminal Emulator window should appear. From the **Port Manager** menu, select **Open**, or simply click the **Open icon** as shown below:

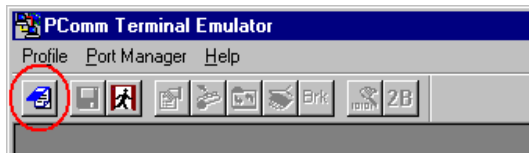

4. The Property window opens automatically. Select the **Communication Parameter** tab, then select the appropriate COM port for the connection (COM1 in this example). Configure the parameters for **19200, 8, N, 1** (**19200** for Baud Rate, **8** for Data Bits, **None** for Parity, and **1** for Stop Bits).

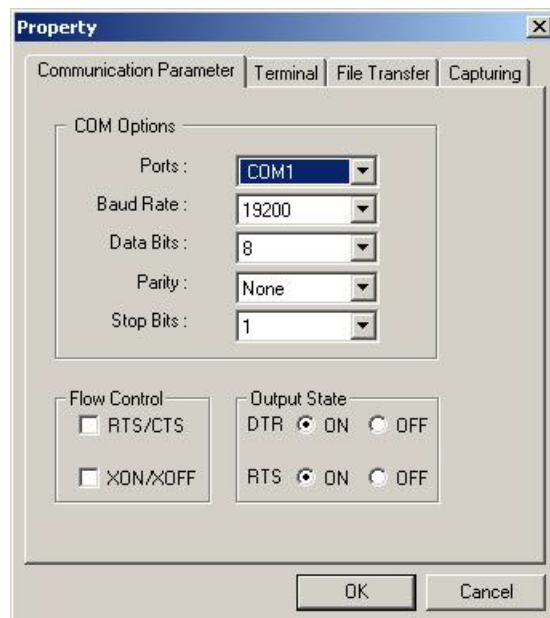

5. From the Property window's Terminal page, select **ANSI** or **VT100** for **Terminal Type** and click **OK**. The NPort S8000 will then automatically switch from data mode to console mode.

- After you enter the password, or if password protection was not enabled, you will be prompted to select the terminal mode. Press **1** for **ansi/vt100** and then press **ENTER**.

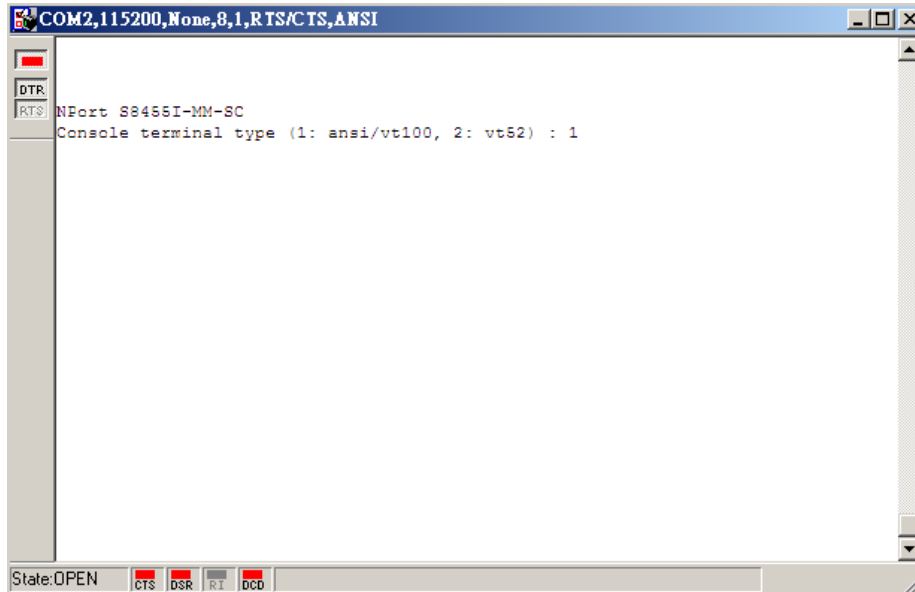

- Enter the username and password to login to the console. The default username and password are **admin** and **moxa**, respectively. The main menu should come up. Once you are in the console, you may configure the IP address through the **Network** menu item, just as with the Telnet console. Please refer to steps 4 to 8 in the *Telnet Console* section to complete the initial IP configuration.

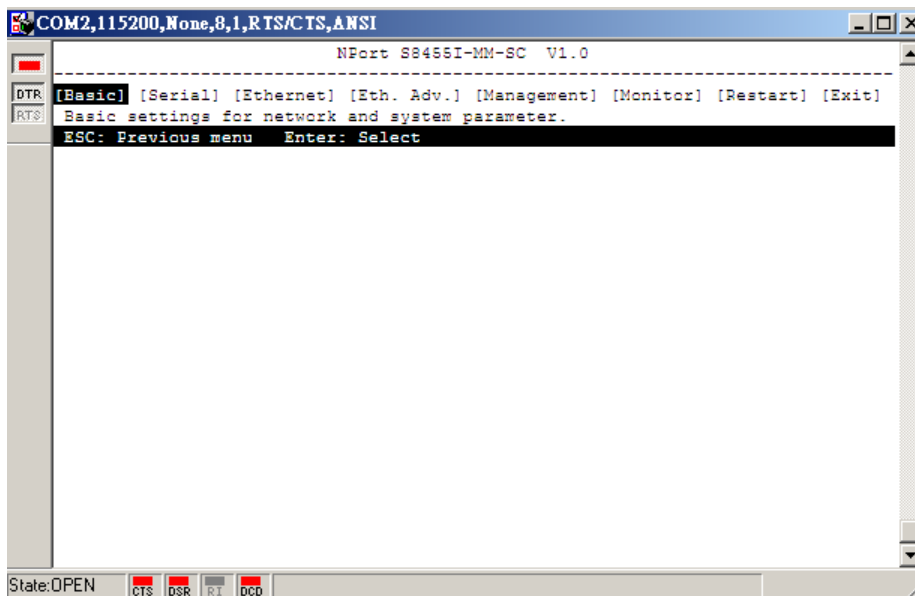



## Choosing the Serial Operation Mode

---

In this chapter, we describe the various serial operation modes of the NPort S8000. The options include an operation mode that uses a driver installed on the host computer and operation modes that rely on TCP/IP socket programming concepts. After choosing the proper operation mode in this chapter, refer to Chapter 6 for detailed configuration parameter definitions.

The following topics are covered in this chapter:

- ❑ **Overview**
- ❑ **Real COM Mode**
- ❑ **RFC2217 Mode**
- ❑ **TCP Server Mode**
- ❑ **TCP Client Mode**
- ❑ **UDP Mode**
- ❑ **Disabled Mode**

## Overview

The device server function of the NPort S8000 enables network operation of traditional RS-232/422/485 devices, in which a device server is a tiny computer equipped with a CPU, real-time OS, and TCP/IP protocols that can bi-directionally translate data between the serial and Ethernet formats. Your computer can access, manage, and configure remote facilities and equipment over the Internet from anywhere in the world.

Traditional SCADA and data collection systems rely on serial ports (RS-232/422/485) to collect data from various kinds of instruments. Since the NPort S8000 networks instruments equipped with an RS-232/422/485 communication port, your SCADA and data collection system will be able to access all instruments connected to a standard TCP/IP network, regardless of whether the devices are used locally or at a remote site.

The NPort S8000 is an external IP-based network device that allows you to expand the number of serial ports for a host computer on demand. As long as your host computer supports the TCP/IP protocol, you won't be limited by the host computer's bus limitation (such as ISA or PCI), or lack of drivers for various operating systems.

In addition to providing socket access, the NPort also comes with a Real COM/TTY driver that transmits all serial signals intact. This means that your existing COM/TTY-based software can be preserved, without needing to invest in additional software.

Three different socket modes are available: TCP Server, TCP Client, and UDP Server/Client. The main difference between the TCP and UDP protocols is that TCP guarantees delivery of data by requiring the recipient to send an acknowledgement to the sender. UDP does not require this type of verification, making it possible to offer a speedier delivery. UDP also allows multicasting of data to groups of IP addresses.

## Real COM Mode

The NPort S8000 comes equipped with COM drivers that work with Windows 9x/NT/2000/XP/2003/Vista/2008/7/8/8.1/10 (all x86/x64) systems, and also TTY drivers for Linux and Unix systems. The driver establishes a transparent connection between the host and serial device by mapping the IP port of the NPort's serial port to a local COM/TTY port on the host computer. This operation mode also supports up to 8 simultaneous connections, so that multiple hosts can collect data from the same serial device at the same time.

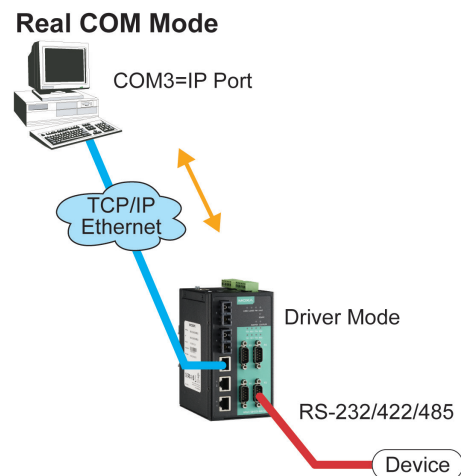

The important point is that Real COM Mode allows users to continue using RS-232/422/485 serial communications software that was written for pure serial communications applications. The driver intercepts data sent to the host's COM port, packs it into a TCP/IP packet, and then redirects it through the host's Ethernet card. At the other end of the connection, the NPort accepts the Ethernet frame, unpacks the TCP/IP packet, and then transparently sends it to the appropriate serial device attached to one of the NPort's serial ports.



### ATTENTION

Real COM Mode allows several hosts to have access control over the same NPort. The driver that comes with your NPort controls the host's access to attached serial devices by checking the host's IP address. Modify the Accessible IP Setting table when the legal IP address is required in your application

# RFC2217 Mode

RFC-2217 mode is similar to Real COM mode. That is, a driver is used to establish a transparent connection between a host computer and a serial device by mapping the serial port on the NPort S8000 to a local COM port on the host computer. RFC2217 defines general COM port control options based on the Telnet protocol. Third-party drivers supporting RFC-2217 are widely available on the Internet and can be used to implement Virtual COM mapping to your NPort S8000 serial port(s).

# TCP Server Mode

In TCP Server mode, the NPort S8000 provides a unique IP port address on a TCP/IP network. The NPort S8000 waits passively to be contacted by the host computer, allowing the host computer to establish a connection with and get data from the serial device. This operation mode also supports up to 8 simultaneous connections, so that multiple hosts can collect data from the same serial device—at the same time.

As illustrated in the figure, data transmission proceeds as follows:

1. The host requests a connection from the NPort configured for TCP Server Mode.
2. Once the connection is established, data can be transmitted in both directions—from the host to the NPort, and from the NPort to the host.

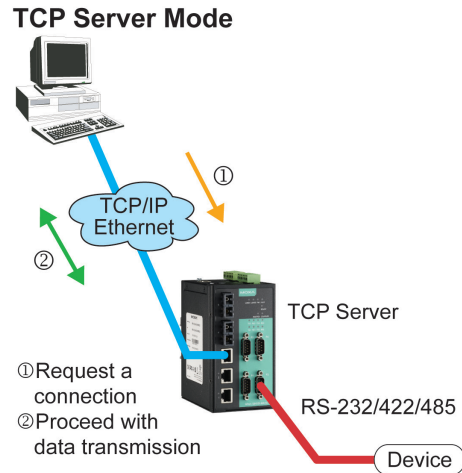

# TCP Client Mode

In TCP Client mode, the NPort S8000 can actively establish a TCP connection to a predefined host computer when serial data arrives.

After the data has been transferred, the NPort S8000 can automatically disconnect from the host computer by using the **TCP alive check time** or **Inactivity time** settings. Refer to chapter 6 for more details.

As illustrated in the figure, data transmission proceeds as follows:

1. The NPort configured for TCP Client Mode requests a connection from the host.
2. Once the connection is established, data can be transmitted in both directions—from the host to the NPort, and from the NPort to the host.

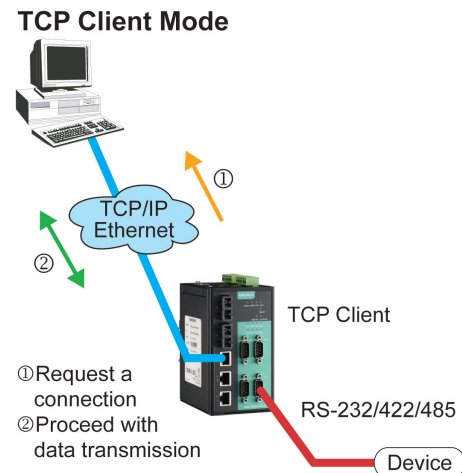

## UDP Mode

Compared to TCP communication, UDP is faster and more efficient. In UDP mode, you can multicast data from the serial device to multiple host computers, and the serial device can also receive data from multiple host computers, making this mode ideal for message display applications.

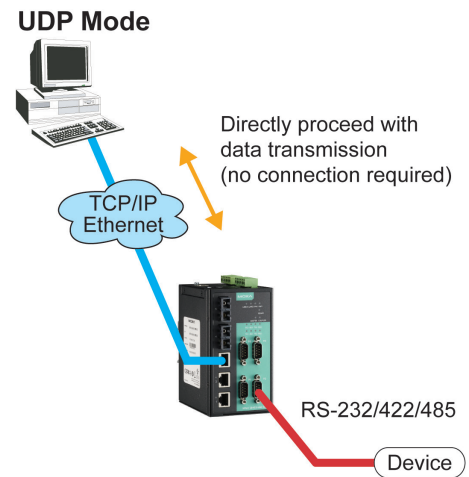

## Disabled Mode

When the Operation Mode for a particular port is set to **Disabled**, that port will be disabled.

# Use Real COM Mode to Communicate with Serial Devices

---

The following topics are covered in this chapter:

## □ **Overview**

### □ **Device Search Utility**

- Installing the Device Search Utility
- Find a Specific NPort on the Ethernet Network via the DSU
- Opening Your Browser
- Configure Operation Mode to Real COM Mode

### □ **NPort Windows Driver Manager**

- Installing the NPort Windows Driver Manager
- Using NPort Windows Driver Manager

### □ **Linux Real TTY Drivers**

- Basic Procedures
- Hardware Setup
- Installing Linux Real TTY Driver Files
- Mapping TTY Ports
- Removing Mapped TTY Ports
- Removing Linux Driver Files

### □ **The UNIX Fixed TTY Driver**

- Installing the UNIX Driver
- Configuring the UNIX Driver

## Overview

The Documentation & software CD included with your NPort S8000 is designed to make the installation and configuration procedure easy and straightforward. This auto-run CD includes the Device Search Utility (DSU) (to broadcast search for all NPort S8000 accessible over the network and firmware upgrade), NPort driver for Windows and Linux platforms (for COM mapping), and the NPort S8000 User's Manual.

This chapter will instruct you on how to install the necessary software and provide the steps to mapping virtual COM port to help user's software keep working as usual.

1. Install the Device Search Utility to find the specific NPort on the Ethernet network.
2. Log in to the Web console to configure the device to work on Real COM mode.
3. Install the NPort driver and mapping COM port.
4. The original utility can open the COM port to transmit/receive data to/from the serial device.

## Device Search Utility

### Installing the Device Search Utility

1. Click the **INSTALL UTILITY** button in the NPort Installation CD auto-run window to install the NPort Search Utility. Once the program starts running, click **Yes** to proceed.
2. Click **Settings** when the Welcome screen opens, to proceed with the installation.

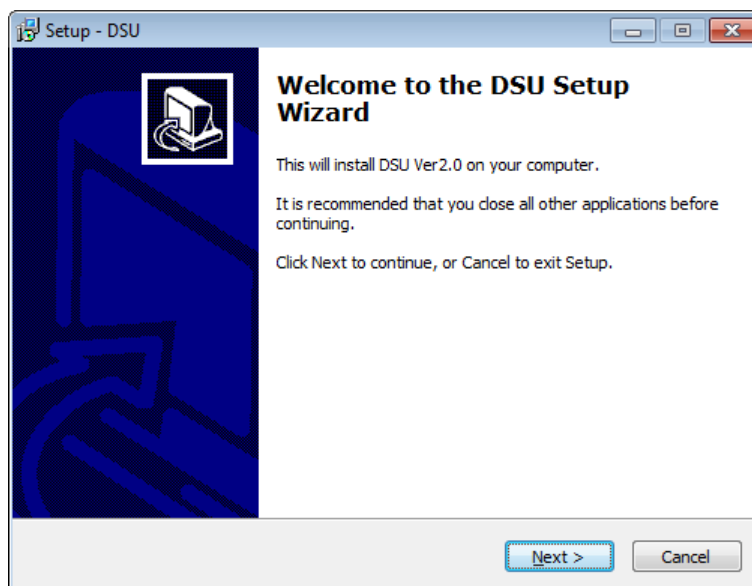

3. Click **Next** to install program files to the default directory, or click **Browse** to select an alternate location.

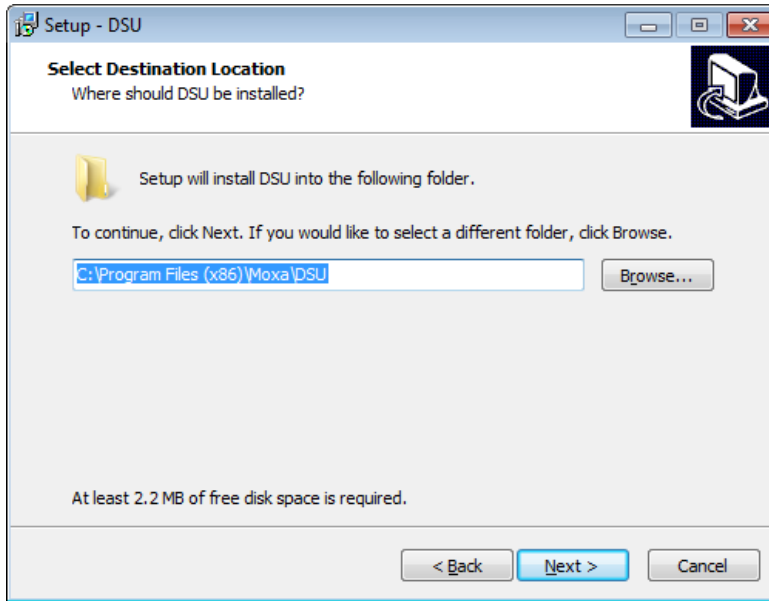

4. Check the checkbox if you want the DSU to create a desktop icon, or just click **Next** to install the program's shortcuts in the appropriate Start Menu folder.

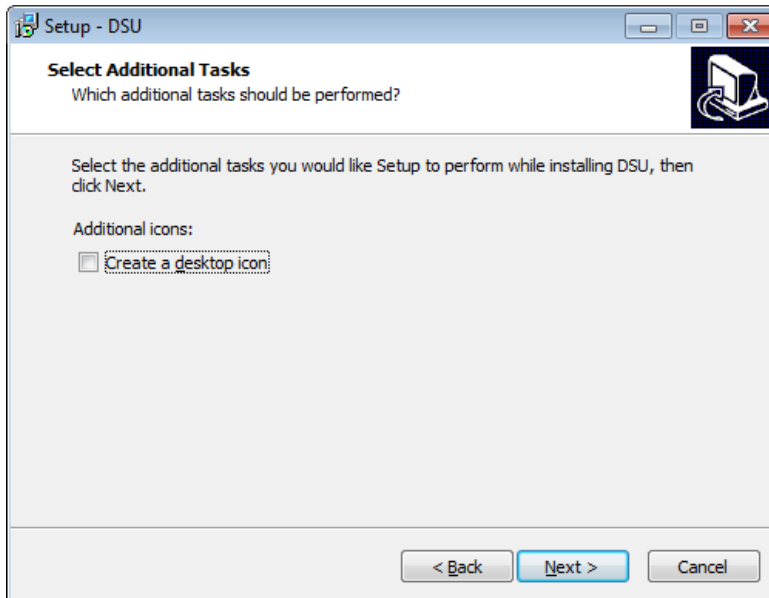

5. Click **Next** to proceed with the installation. The installer then displays a summary of the installation options.

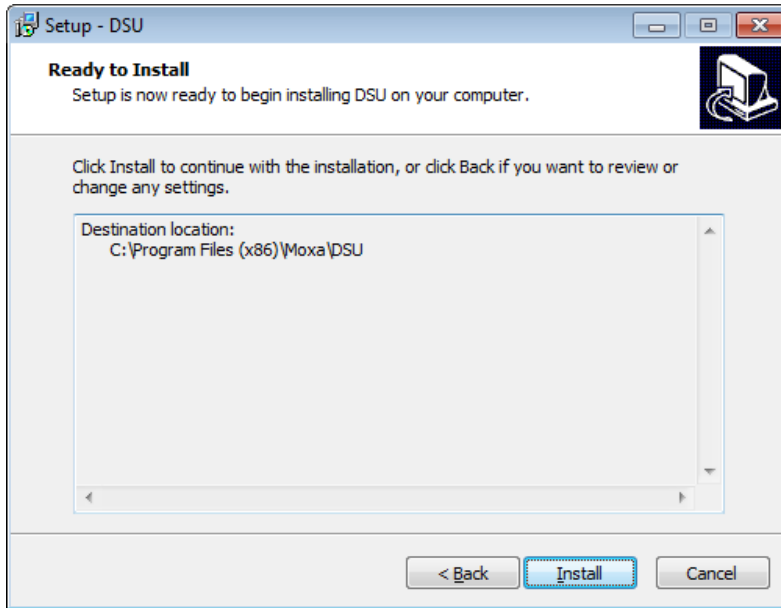

6. Click **Install** to begin the installation. The setup window will report the progress of the installation. To change the installation settings, click **Back** and navigate to the previous screen.
7. Click **Finish** to complete the installation of the NPort Search Utility.

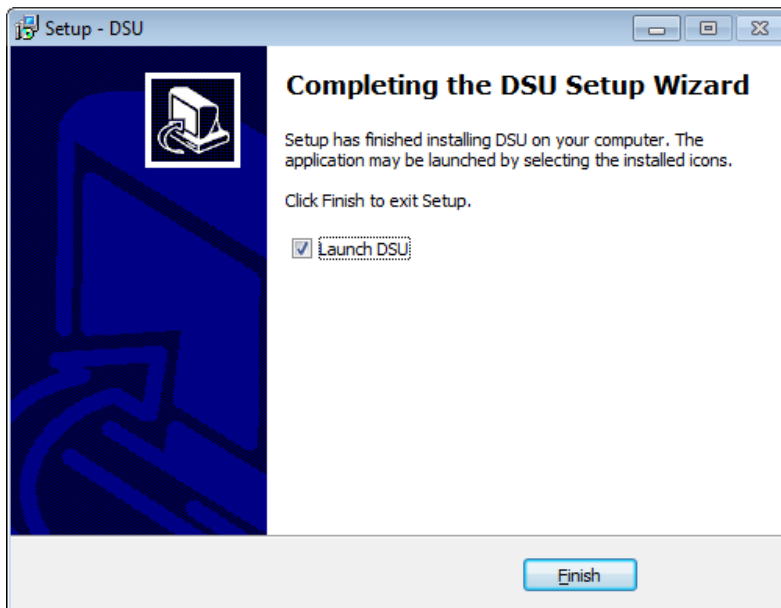



## Find a Specific NPort on the Ethernet Network via the DSU

The Broadcast Search function is used to locate all the NPort S8000 servers that are connected to the same LAN as your computer. After locating an NPort S8000, you will be able to change its IP address.

Since the Broadcast Search function searches by MAC address and not by IP address, all NPort S8000 servers connected to the LAN will be located, regardless of whether or not they are part of the same subnet as the host.

1. Open the DSU and then click the **Search** icon.

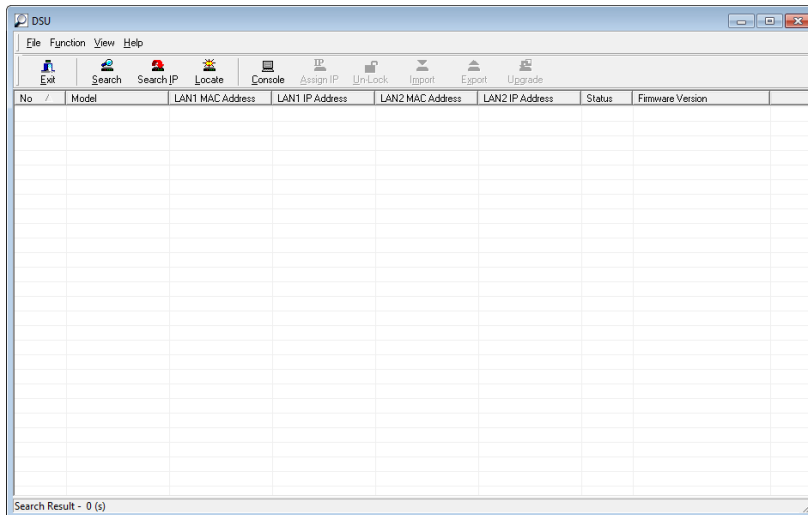

The Searching window indicates the progress of the search.

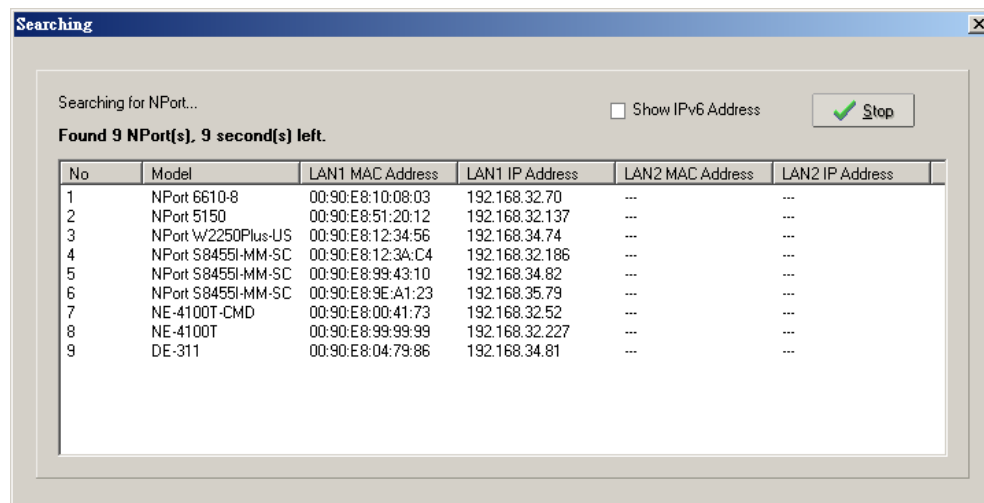

- When the search is complete, all the NPort S8000 servers that were located will be displayed in the DSU window.

No.	Model	LAN1 MAC Address	LAN1 IP Address	LAN2 MAC Address	LAN2 IP Address	Status
1	NPort 6610-8	00:90:E8:10:08:03	192.168.32.70	...	...	
2	NPort 5150	00:90:E8:51:20:12	192.168.32.137	...	...	
3	NPort W2250Plus-US	00:90:E8:12:34:56	192.168.34.74	...	...	
4	NPort S8455I-MM-SC	00:90:E8:12:3A:C4	192.168.32.186	...	...	
5	NPort S8455I-MM-SC	00:90:E8:99:43:10	192.168.34.82	...	...	
6	NPort S8455I-MM-SC	00:90:E8:9E:A1:23	192.168.35.79	...	...	
7	NE-4100T-CMD	00:90:E8:00:41:73	192.168.32.52	...	...	
8	NE-4100T	00:90:E8:99:99:99	192.168.32.227	...	...	
9	DE-311	00:90:E8:04:79:86	192.168.34.81	...	...	

- To modify the configuration of the highlighted NPort S8000, click on the Console icon to open the web console. This will take you to the web console, where you can make all configuration changes. Please refer to Chapter 6, "Configuration with the Web Console", for information on how to use the web console.

## Opening Your Browser

- Open your browser with the cookie function enabled. (To enable your browser for cookies, right-click on your desktop Internet Explorer icon, select **Properties**, click on the Security tab, and then select the three Enable options as shown in the figure below.)

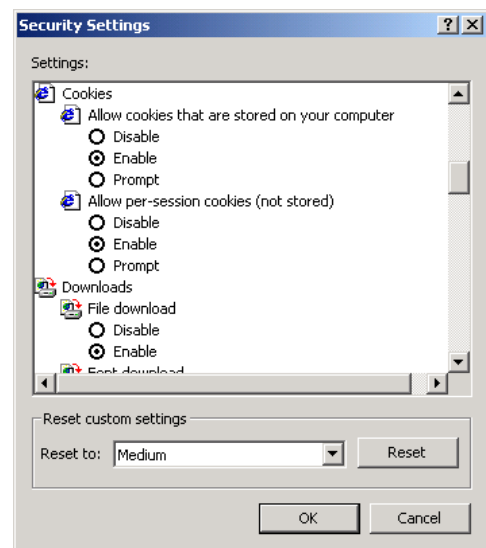
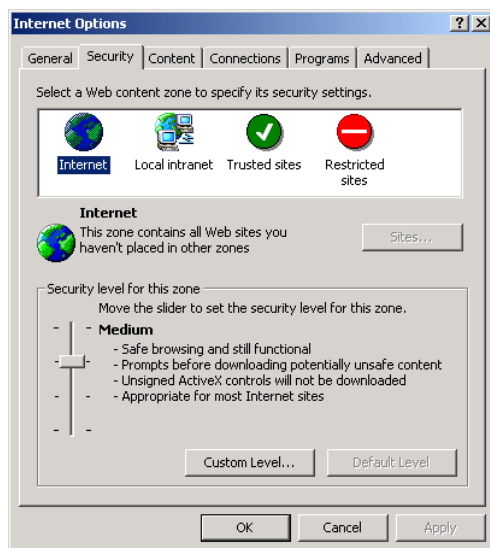

- After using the DSU to find a specific NPort, type the IP address to log in to the web console. If this is the first time you configure the NPort, you may directly type the default IP address, 192.168.127.254 in the Address input box. Use the correct IP address if it is different from the default and then press Enter.

- On the first page of the web console, type **admin** for the default account name and **moxa** for the default password.

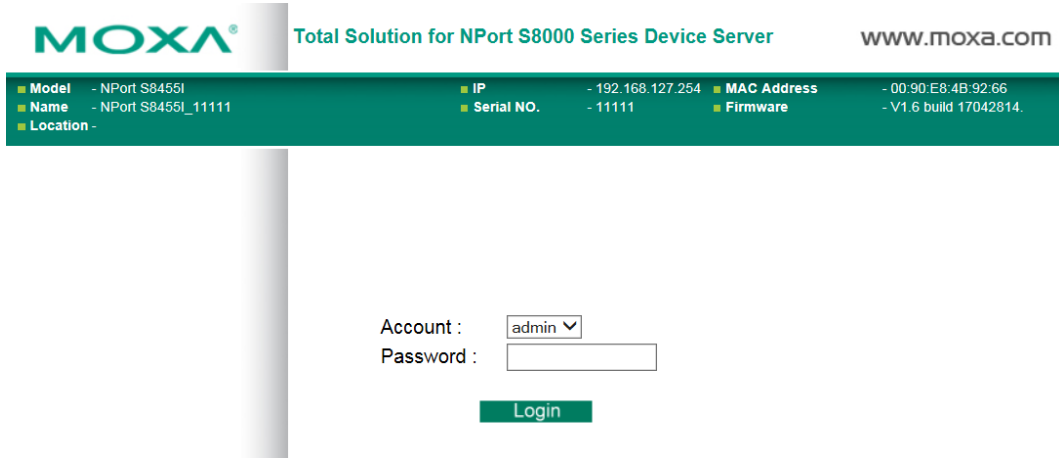

**ATTENTION**

If you use other web browsers, remember to Enable the functions **to allow cookies that are stored on your computer** or **allow per-session cookies**. Device servers use cookies only for “password” transmission.



**ATTENTION**

Refer to Chapter 3, “Initial IP Address Configuration,” to see how to configure the IP address. Examples shown in this chapter use the Factory Default IP address (192.168.127.254).

The NPort S8000 homepage will open. On this page, you can see a brief description of the Web Console

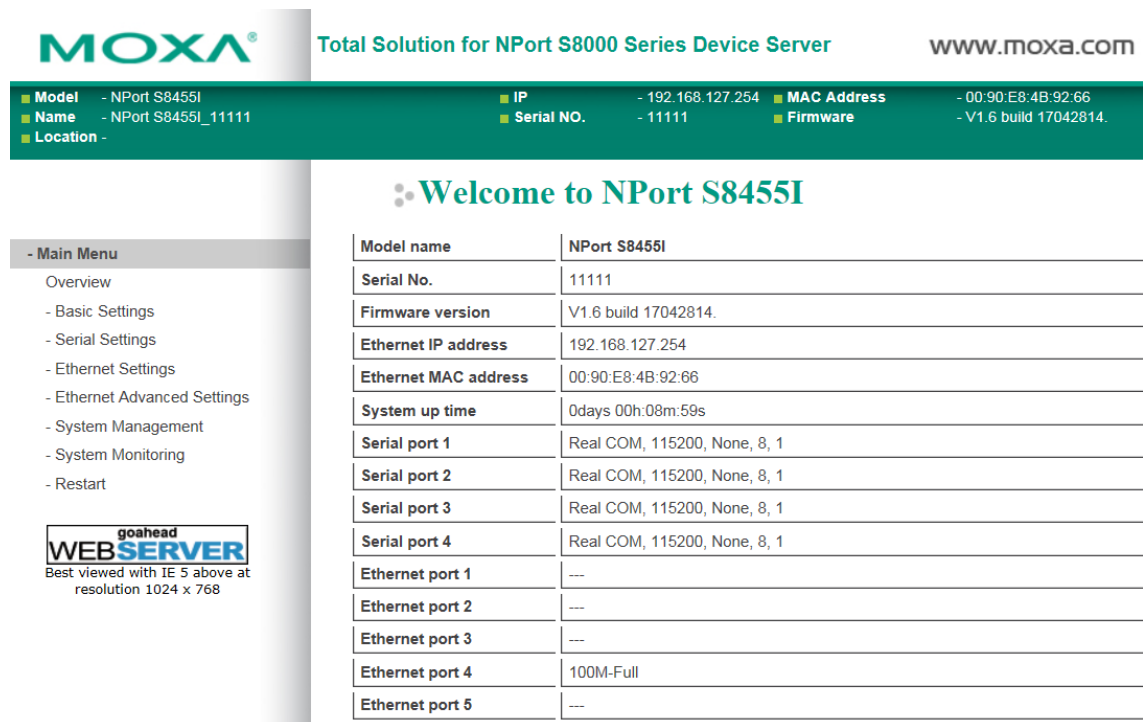

**ATTENTION**

If you forgot the password, the **ONLY** way to start configuring the NPort is to load the factory defaults by using the reset button.



**ATTENTION**

Remember to export the configuration file when you have finished the configuration. After using the reset button to load the factory defaults, your configuration can be easily reloaded into the NPort by using the Import function. Refer to Chapter 7, "Maintenance / Update System Files from Local PC", for more details about using the Export and Import functions.



**ATTENTION**

If your NPort application requires using password protection, you must enable the cookie function in your browser. If the cookie function is disabled, you will not be allowed to enter the Web Console Screen.

## Configure Operation Mode to Real COM Mode

Click on **Operation Modes**, located under Serial Settings, to display the serial port settings for four serial ports. To modify the serial operation mode settings for a particular port, click on **Operation Modes** of the serial port in the window on the right-hand side.



Total Solution for NPort S8000 Series Device Server

www.moxa.com

■ Model - NPort S84551	■ IP - 192.168.127.254	■ MAC Address - 00:90:E8:4B:92:66	
■ Name - NPort S84551_11111	■ Serial NO. - 11111	■ Firmware - V1.6 build 17042814	
■ Location -			

### ⚙️ Operation Modes ?

Port	Operating mode	Packing length	Delimiter 1	Delimiter 2	Delimiter process	Force transmit
1	Real COM	0	00 (Disable)	00 (Disable)	Do nothing	0
		TCP alive check time: 7 Max connection: 1				
2	Real COM	0	00 (Disable)	00 (Disable)	Do nothing	0
		TCP alive check time: 7 Max connection: 1				
3	Real COM	0	00 (Disable)	00 (Disable)	Do nothing	0
		TCP alive check time: 7 Max connection: 1				
4	Real COM	0	00 (Disable)	00 (Disable)	Do nothing	0
		TCP alive check time: 7 Max connection: 1				

**- Main Menu**

- Overview
- Basic Settings
- Serial Settings
  - Operation Modes
  - Serial Parameters
  - Serial ToS
- Ethernet Settings
- Ethernet Advanced Settings
- System Management
- System Monitoring
- Restart

goahead  
**WEBSERVER**  
Best viewed with IE 5 above at resolution 1024 x 768

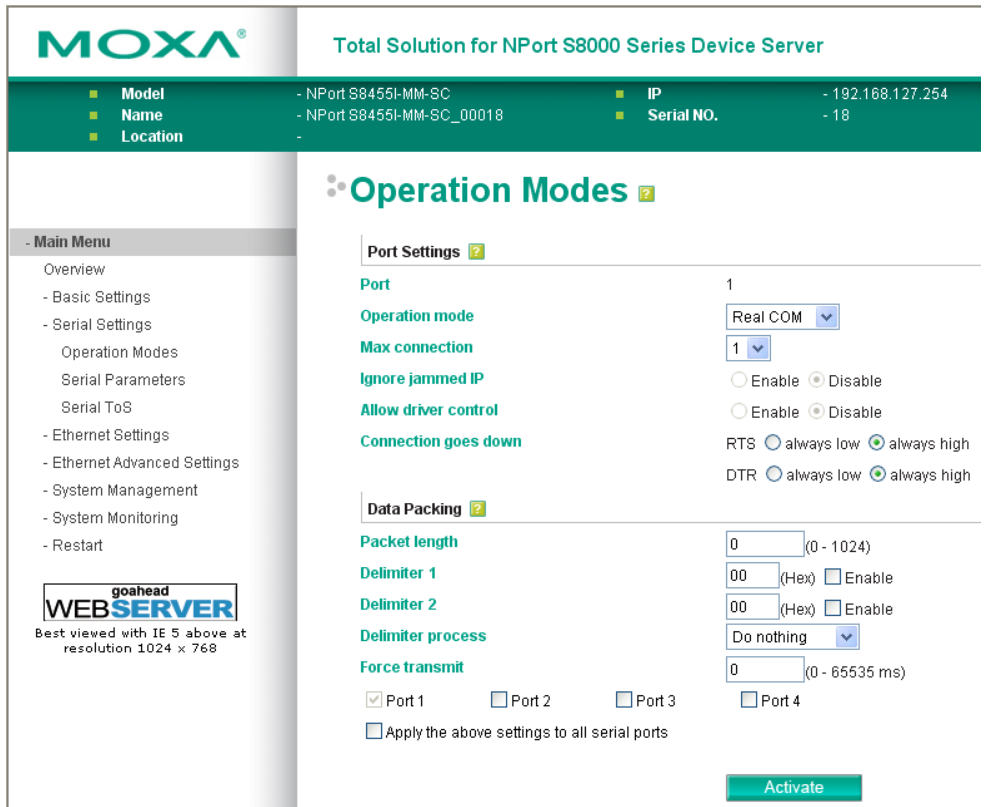

# NPort Windows Driver Manager

## Installing the NPort Windows Driver Manager

The NPort Windows Driver Manager is intended for use with NPort S8000 serial ports that are set to Real COM mode. The software manages the installation of drivers that allow you to map unused COM ports on your PC to serial ports on the NPort S8000. When the drivers are installed and configured, devices that are attached to serial ports on the NPort S8000 will be treated as if they were attached to your PC's own COM ports.

1. Click the **INSTALL COM Driver** button in the NPort Installation CD auto-run window to install the NPort Windows Driver. Once the installation program starts running, click **Yes** to proceed.
2. Click **Next** when the Welcome screen opens, to proceed with the installation.

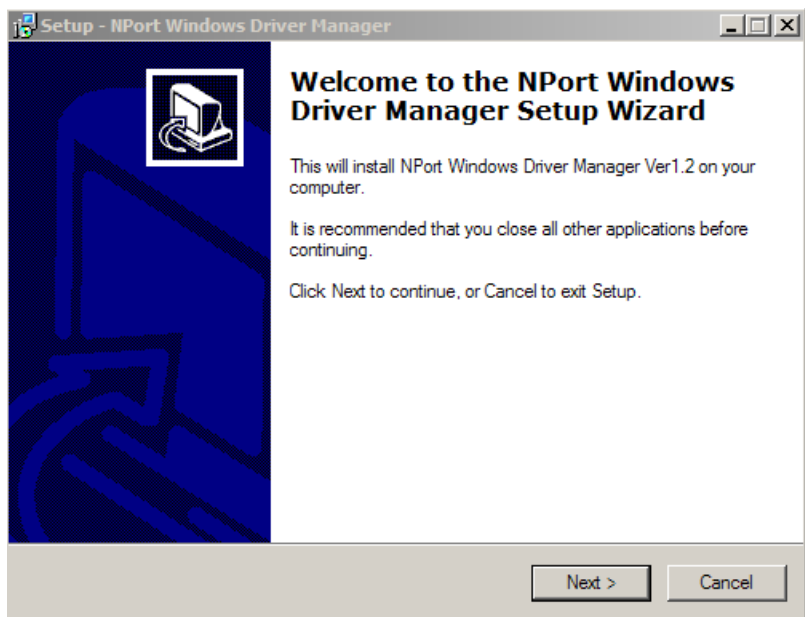

Click **Next** to install program files to the default directory, or click **Browse** to select an alternate location.

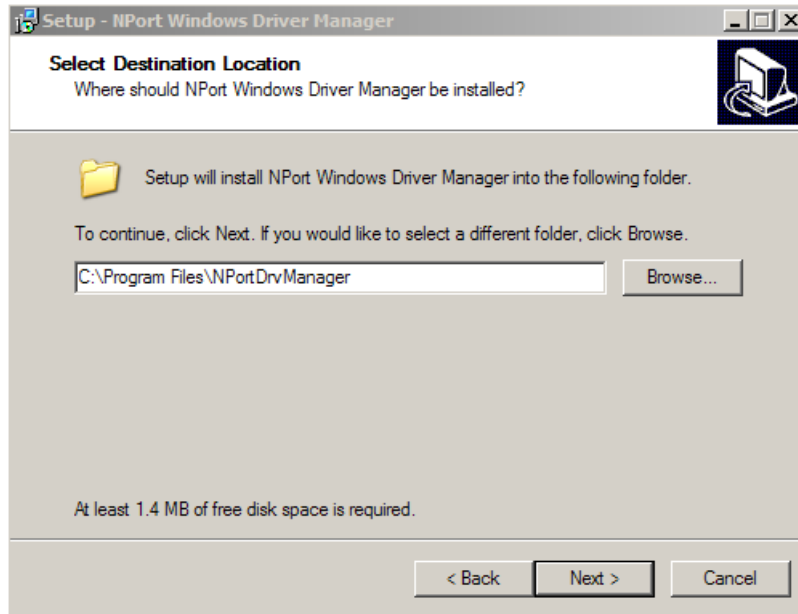

3. Click **Next** to install the program’s shortcuts in the appropriate Start Menu folder.

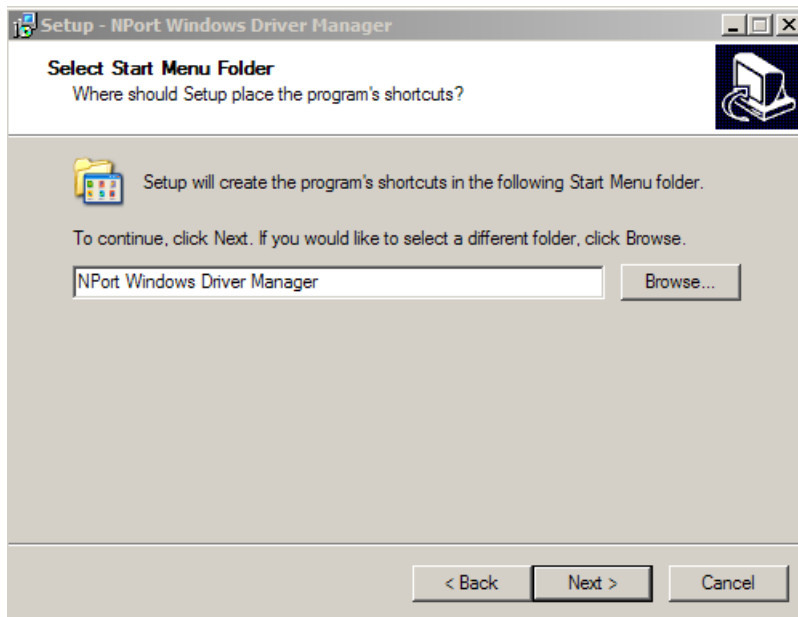

- Click **Next** to proceed with the installation. The installer then displays a summary of the installation options.

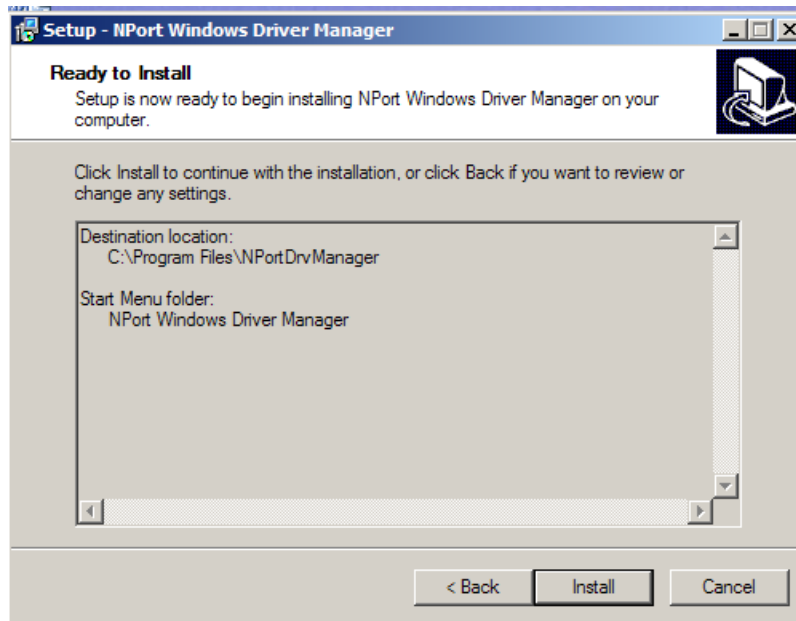

- Click **Install** to begin the installation. The setup window will report the progress of the installation. To change the installation settings, click **Back** and navigate to the previous screen. The installer will display a message that the software has not passed Windows Logo testing. This is shown as follows:

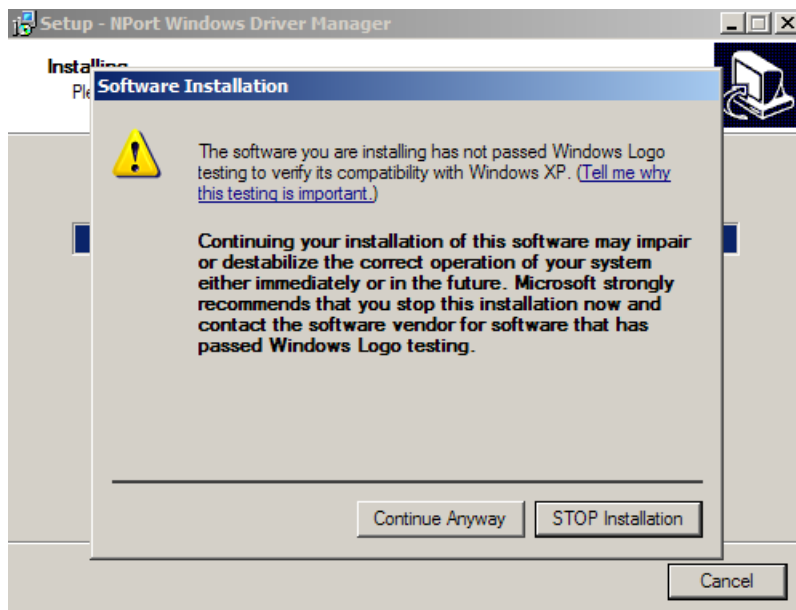

Click **Continue Anyway** to finish the installation.

6. Click **Finish** to complete the installation of the NPort Windows Driver Manager.

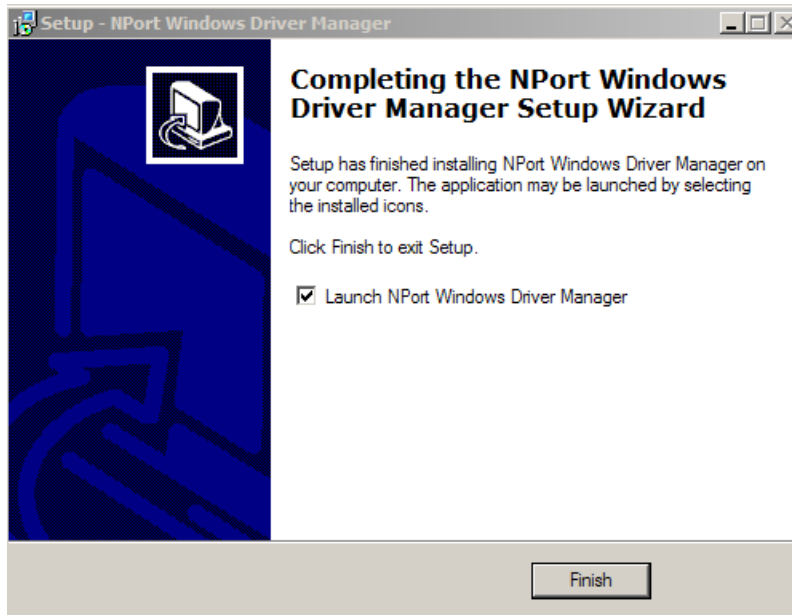

## Using NPort Windows Driver Manager

After you have installed the NPort Windows Driver Manager, you can set up the NPort S8000’s serial ports as remote COM ports for your PC host. Make sure that the serial port(s) on your NPort S8000 are set to Real COM mode before mapping COM ports with the NPort Windows Driver Manager.

1. Go to **Start** → **NPort Windows Driver Manager** → **NPort Windows Driver Manager** to start the COM mapping utility.
2. Click the **Add** icon.

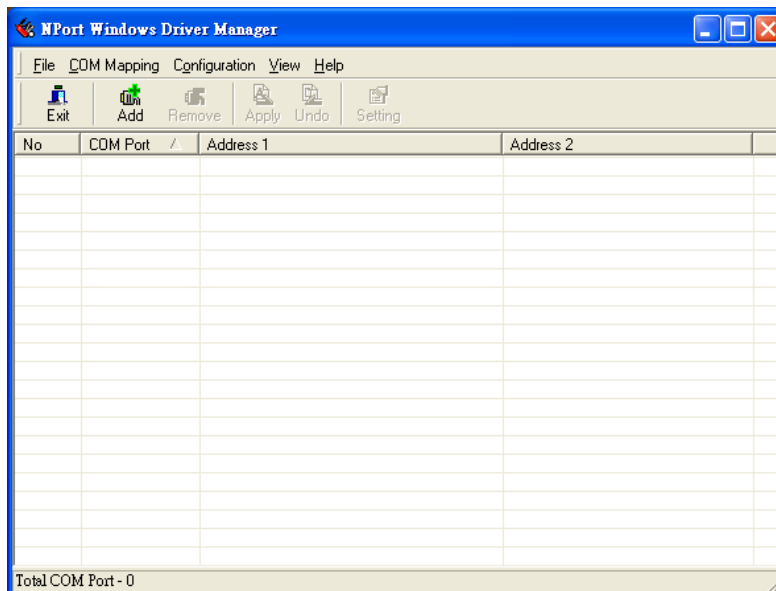



- Click **Search** to search for the NPort device servers. From the list that is generated, select the server to which you will map COM ports, and then click **OK**.

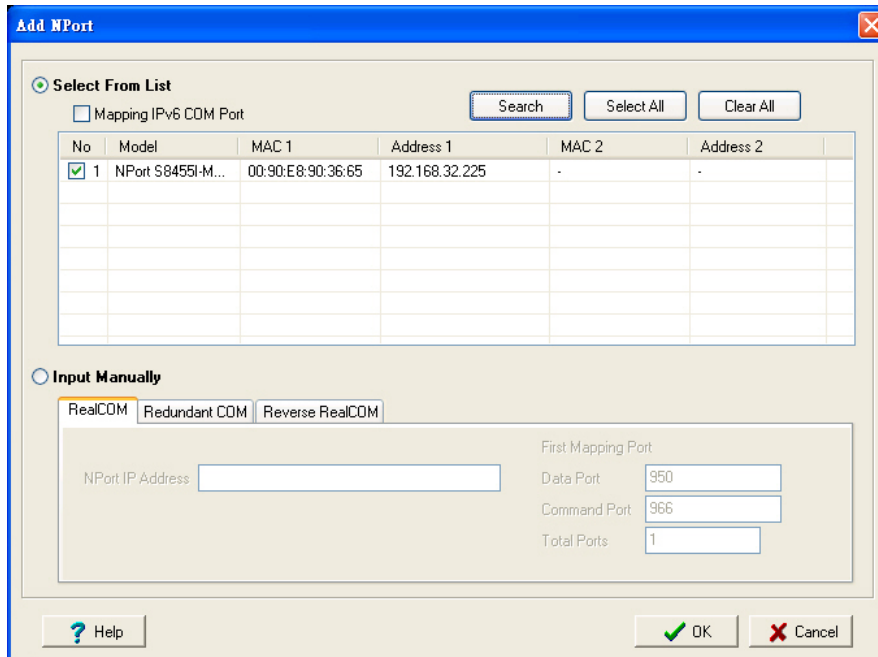

- Alternatively, you can select **Input Manually** and then manually enter the NPort IP Address, 1st Data Port, 1st Command Port, and Total Ports to which COM ports will be mapped. Click **OK** to proceed to the next step. Note that the Add NPort page supports FQDN (Fully Qualified Domain Name), in which case the IP address will be filled in automatically.

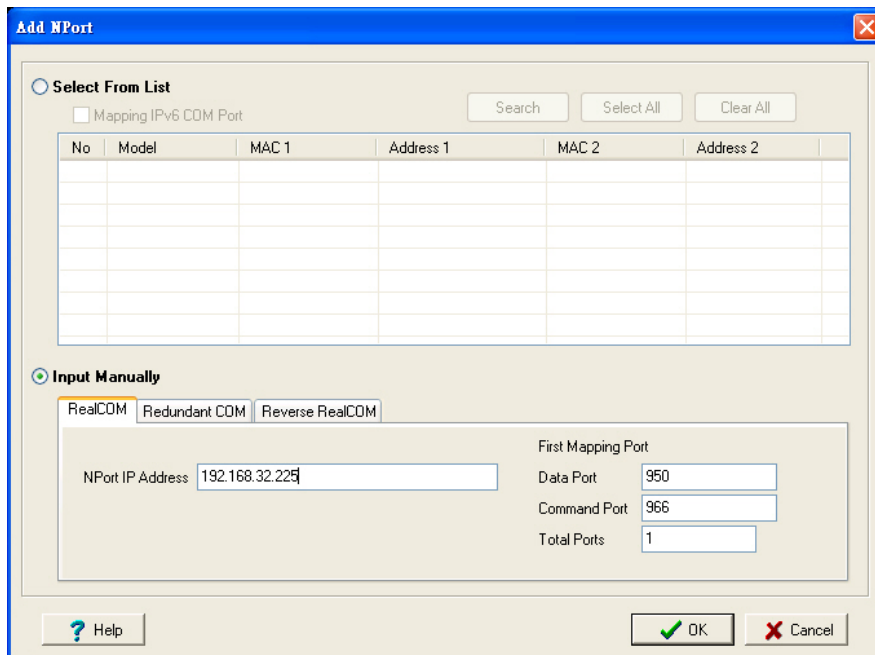

- COM ports and their mappings will appear in blue until they are activated. Activating the COM ports saves the information in the host system registry and makes the COM port available for use. The host computer will not have the ability to use the COM port until the COM ports are activated. Click **Yes** to activate the COM ports at this time, or click **No** to activate the COM ports later.

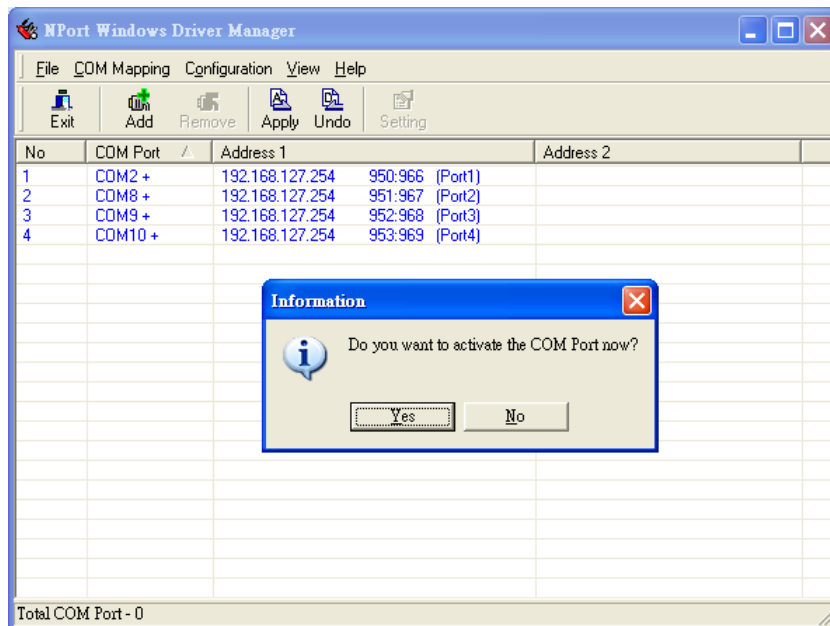

- A message will display during activation of each port, indicating that the software has not passed Windows Logo certification. Click **Continue Anyway** to proceed.



7. Ports that have been activated will appear in black.

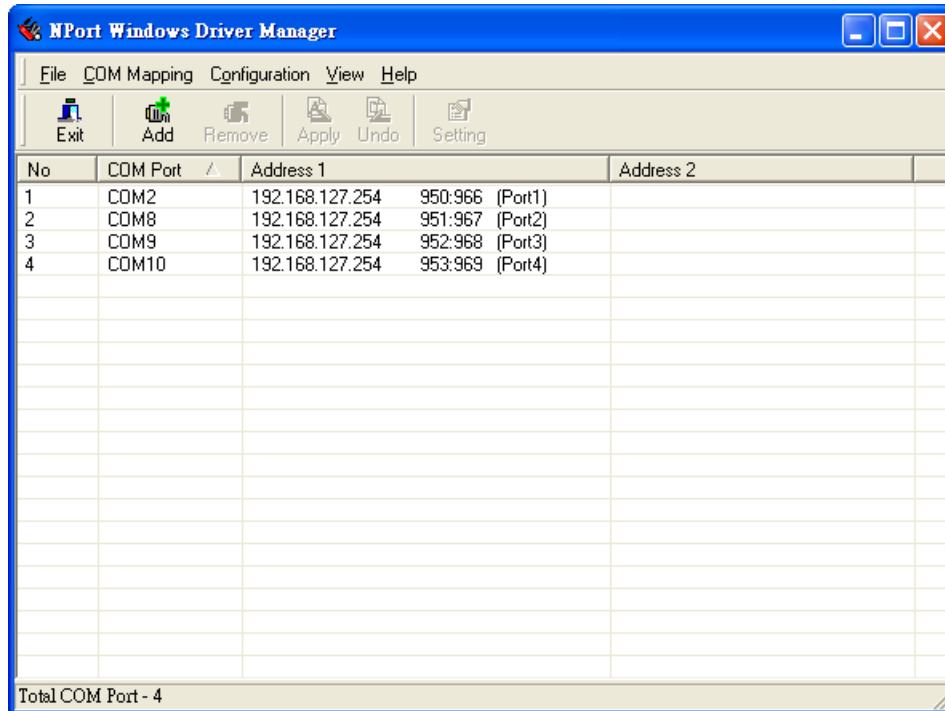

8. Use terminal software to open the mapped COM port to communicate with the serial device. You may download PComm Lite, a useful tool to check the serial communication, from Moxa’s website: <http://www.moxa.com/support/download.aspx?type=support&id=167>

### Configure the mapped COM ports with Advanced Functions

For Real COM Mode, to reconfigure the settings for a particular serial port on the NPort S8000, select the row corresponding to the desired port and then click the **Setting** icon.

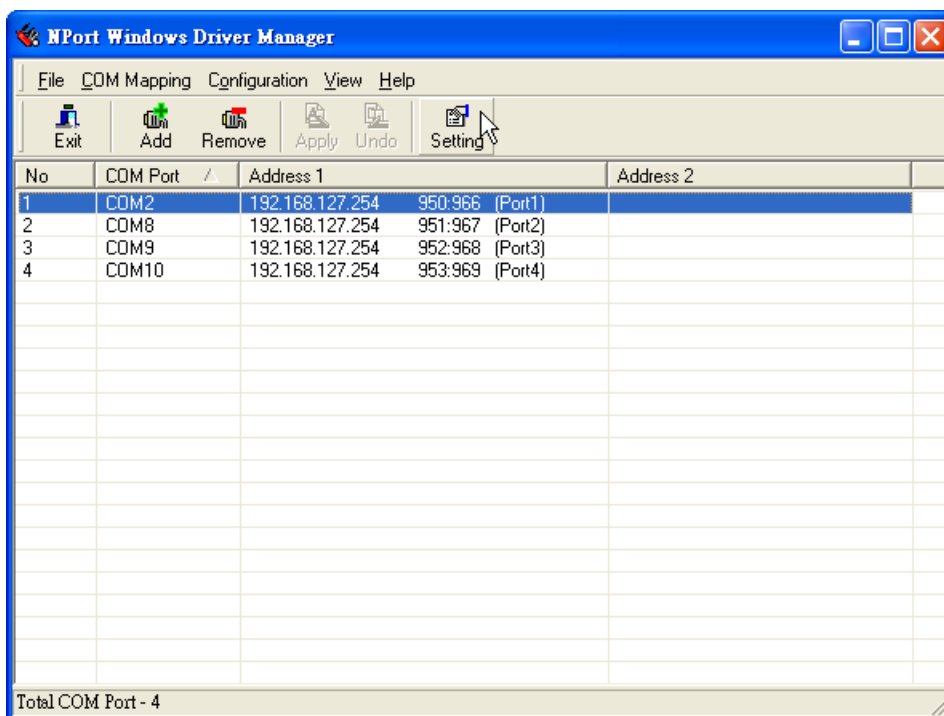

1. On the **Basic Setting** window, use the **COM Number** drop-down list to select a COM number to be assigned to the NPort S8000's serial port that is being configured. Select the **Auto Enumerating COM Number for Selected Ports** option to automatically assign available COM numbers in sequence to selected serial ports. Note that ports that are "in use" will be labeled accordingly.

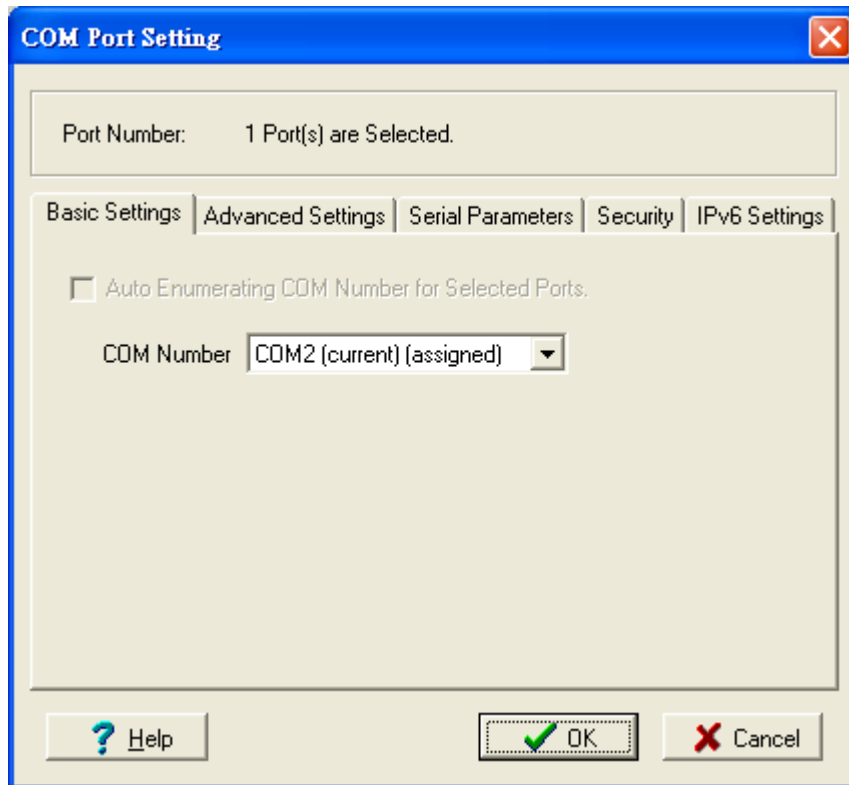

2. Click the **Advanced Settings** tab to modify Tx Mode, FIFO, and Flash Flush.



**Tx Mode**

**Hi-Performance** is the default for Tx mode. After the driver sends data to the NPort S8000, the driver immediately issues a "Tx Empty" response to the program. Under **Classical** mode, the driver will not send the "Tx Empty" response until after confirmation is received from the NPort S8000's serial port. This causes

lower throughput. Classical mode is recommended if you want to ensure that all data is sent out before further processing.

### FIFO

If FIFO is **Disabled**, the NPort S8000 will transmit one byte each time the Tx FIFO becomes empty, and an Rx interrupt will be generated for each incoming byte. This will result in a faster response and lower throughput.

### Network Timeout

You can use this option to prevent blocking if the target NPort is unavailable.

### Auto Network Re-Connection

With this option enabled, the driver will repeatedly attempt to reestablish the TCP connection if the NPort S8000 does not respond to background "check alive" packets.

### Always Accept Open Requests

When the driver cannot establish a connection with the NPort, the user's software can still open the mapped COM port, just like an onboard COM port.

For example, if the NPort is down or the network is broken as described in figure below. At that moment, the terminal software tries to open the mapped COM port, and the driver will respond with the message: "Success" for the terminal software to open the COM port. At the same time, the driver will try to establish the connection to the specific NPort. If the connection is established, then the mapped COM port will work properly.

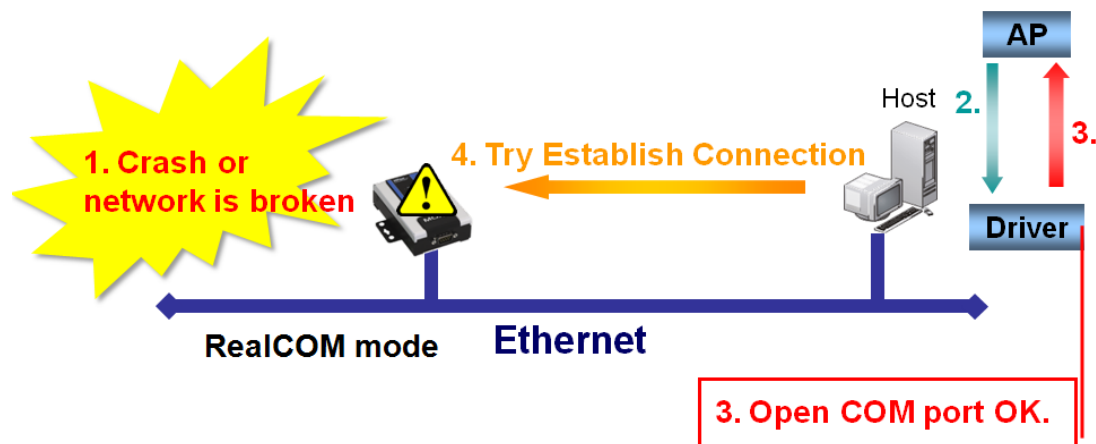

### Return error if network is unavailable

If this option is disabled, the driver will not return any error even when a connection cannot be established with the NPort S8000. With this option enabled, calling the Win32 Comm function will result in the error return code "STATUS\_NETWORK\_UNREACHABLE" when a connection cannot be established to the NPort S8000. This usually means that your host's network connection is down, perhaps due to a cable being disconnected. However, if you can reach other network devices, it may be that the NPort S8000 is not powered on or is disconnected. Note that **Auto Network Re-Connection** must be enabled in order to use this function.

### Fast Flush (only flushes the local buffer)

For some applications, the user's program will use the Win32 "PurgeComm()" function before it reads or writes data. After a program uses this PurgeComm() function, the NPort driver continues to query the NPort's firmware several times to make sure no data is queued in the NPort's firmware buffer, rather than just flushing the local buffer. This design is used to satisfy some special considerations. However, it may take more time (about several hundred milliseconds) than a native COM1 due to the additional time spent communicating across the Ethernet. This is why PurgeComm() works significantly faster with native COM ports on a PC than with mapped COM ports on the NPort S8000. In order to accommodate other applications that require a faster response time, the new NPort driver implements a new Fast Flush option. By default, this function is enabled.

If you have disabled Fast Flush and find that COM ports mapped to the NPort S8000 perform markedly slower than when using a native COM port, try to verify if "PurgeComm()" functions are used in your application. If so, try enabling the Fast Flush function and see if there is a significant improvement in performance.

**Ignore TX Purge**

Applications can use the Win32 API PurgeComm to clear the output buffer. Outstanding overlapping write operations will be terminated. Select the **Ignore TX Purge** checkbox to ignore the effect on output data.

**NOTE** Starting Windows Driver Manager v1.19 supports MOXA OnCell series; the **Enable Auto IP Report** function in the Advance setting only supports OnCell products.

- 3. The **Serial Parameters** window in the following figure shows the default settings when the NPort S8000 is powered on. However, the program can redefine the serial parameters to different values after the program opens the port via Win 32 API.

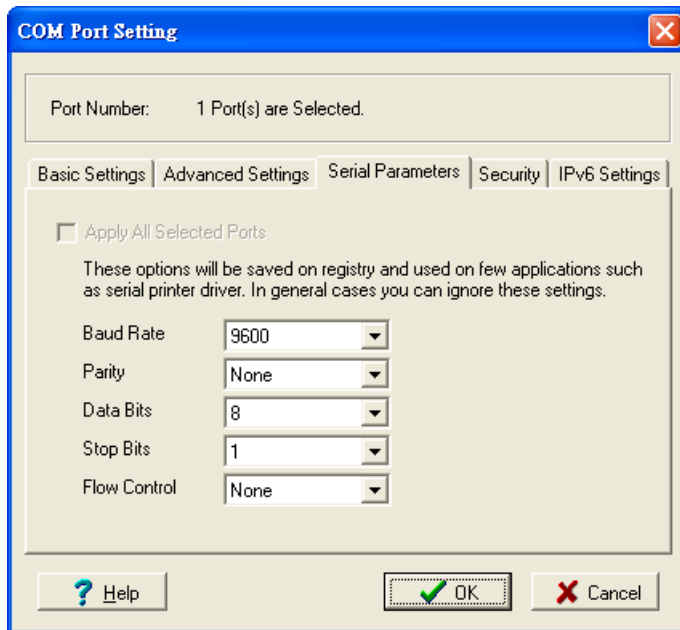

- 4. The Security function is available only for the NPort 6000 Series. The NPort S8000 doesn't support this function.

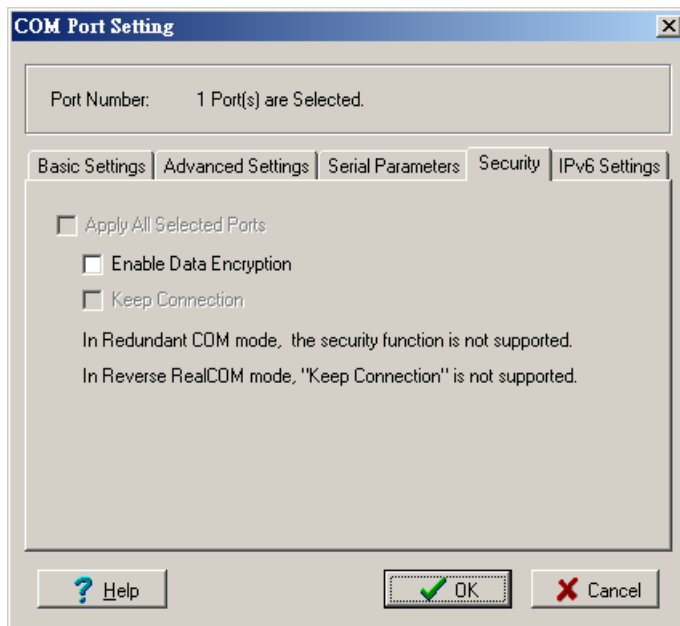

- The IPv6 Settings function is available only for the NPort 6000 series. The NPort S8000 doesn't support this function.

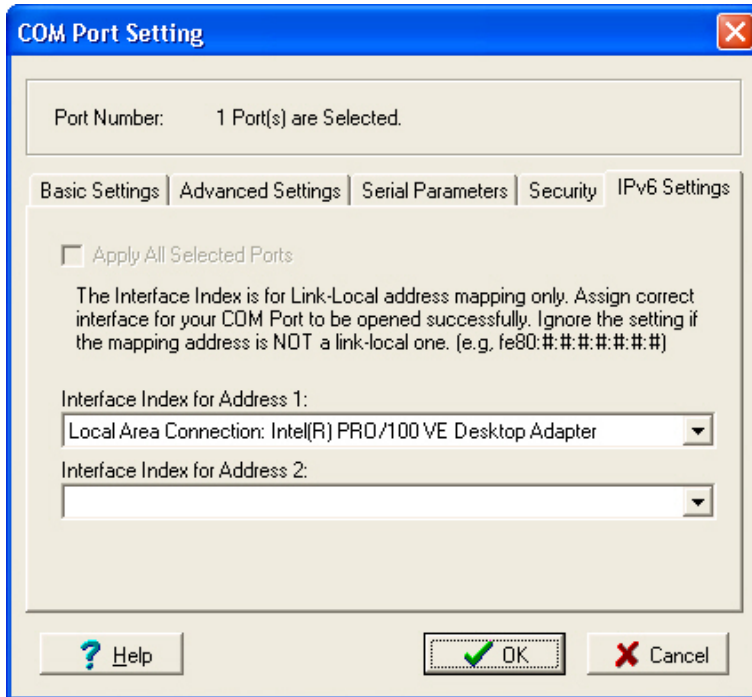

- To save the configuration to a text file, select **Export** from the **COM Mapping** menu. You will then be able to import this configuration file to another host and use the same COM Mapping settings in the other host.

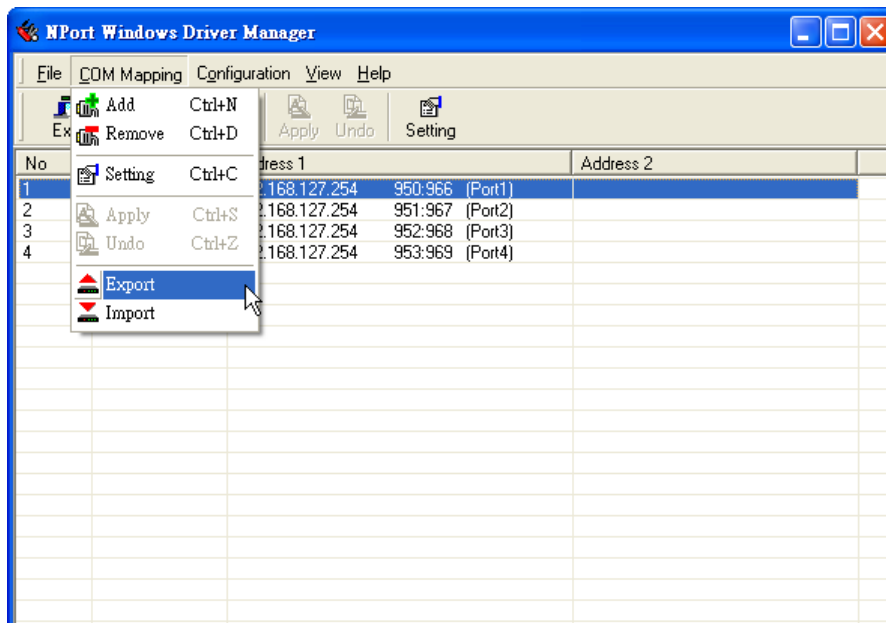

## Linux Real TTY Drivers

### Basic Procedures

To map an NPort S8000 serial port to a Linux host's tty port, follow these instructions:

- Set up the NPort S8000. After verifying that the IP configuration works, and you can access the NPort S8000 (by using ping, telnet, etc.), configure the desired serial port on the NPort S8000 to Real COM mode.
- Install the Linux Real tty driver files on the host
- Map the NPort serial port to the host's tty port

## Hardware Setup

Before proceeding with the software installation, make sure you have completed the hardware installation. Note that the default IP address for the NPort S8000 is **192.168.127.254**, and the default username and password are admin and moxa, respectively.

**NOTE** After installing the hardware, you must configure the operating mode of the serial port on your NPort S8000 to Real COM mode.

## Installing Linux Real TTY Driver Files

1. Obtain the driver file from the included CD-ROM or the Moxa website, at <http://www.moxa.com>.
2. Log in to the console as a superuser (root).
3. Execute **cd /** to go to the root directory.
4. Copy the driver file **npreal2xx.tgz** to the **/** directory.
5. Execute **tar xvzf npreal2xx.tgz** to extract all files into the system.
6. Execute **/tmp/moxa/mxinst**.

For RedHat AS/ES/WS and Fedora Core1, append an extra argument as follows:

**# /tmp/moxa/mxinst SP1**

The shell script will install the driver files automatically.

7. After installing the driver, you will be able to see several files in the **/usr/lib/npreal2/driver** folder:
  - > **mxaddsvr** (Add Server, mapping tty port)
  - > **mxdelsvr** (Delete Server, unmapping tty port)
  - > **mxloadsvr** (Reload Server)
  - > **mxmknod** (Create device node/tty port)
  - > **mxrmnod** (Remove device node/tty port)
  - > **mxuninst** (Remove tty port and driver files)

At this point, you will be ready to map the NPort serial port to the system tty port.

## Mapping TTY Ports

Make sure that you set the operation mode of the desired NPort S8000 serial port to Real COM mode. After logging in as a superuser, enter the directory **/usr/lib/npreal2/driver** and then execute **mxaddsvr** to map the target NPort serial port to the host tty ports. The syntax of **mxaddsvr** is as follows:

```
mxaddsvr [NPort IP Address] [Total Ports] ([Data port] [Cmd port])
```

The **mxaddsvr** command performs the following actions:

1. Modifies **npreal2d.cf**.
2. Creates tty ports in directory **/dev** with major & minor number configured in **npreal2d.cf**.
3. Restarts the driver.

### Mapping tty ports automatically

To map tty ports automatically, you may execute **mxaddsvr** with just the IP address and number of ports, as in the following example:

```
# cd /usr/lib/npreal2/driver  
# ./mxaddsvr 192.168.3.4 16
```

In this example, 16 tty ports will be added, all with IP 192.168.3.4, with data ports from 950 to 965 and command ports from 966 to 981.



## Mapping tty ports manually

To map tty ports manually, you may execute **mxaddsvr** and manually specify the data and command ports, as in the following example:

```
# cd /usr/lib/npreal2/driver
# ./mxaddsvr 192.168.3.4 16 4001 966
```

In this example, 16 tty ports will be added, all with IP 192.168.3.4, with data ports from 4001 to 4016 and command ports from 966 to 981.

## Removing Mapped TTY Ports

After logging in as root, enter the directory **/usr/lib/npreal2/driver** and then execute **mxdelsvr** to delete a server. The syntax of **mxdelsvr** is:

```
mxdelsvr [IP Address]
```

Example:

```
# cd /usr/lib/npreal2/driver
# ./mxdelsvr 192.168.3.4
```

The following actions are performed when executing **mxdelsvr**:

1. Modify `npreal2d.cf`.
2. Remove the relevant tty ports in directory **/dev**.
3. Restart the driver.

If the IP address is not provided in the command line, the program will list the installed servers and number of ports on the screen. You will need to choose a server from the list for deletion.

## Removing Linux Driver Files

A utility is included that will remove all driver files, map tty ports, and unload the driver. To do this, you only need to enter the directory **/usr/lib/npreal2/driver**, and then execute **mxuninst** to uninstall the driver. This program will perform the following actions:

1. Unload the driver.
2. Delete all files and directories in **/usr/lib/npreal2**
3. Delete directory **/usr/lib/npreal2**
4. Modify the system initializing script file.

# The UNIX Fixed TTY Driver

## Installing the UNIX Driver

1. Log in to UNIX and create a directory for the Moxa TTY. To create a directory named `/usr/etc`, execute the command:

```
# mkdir -p /usr/etc
```

2. Copy **moxattyd.tar** to the directory you created. If you created the **/usr/etc** directory above, you would execute the following commands:

```
# cp moxattyd.tar /usr/etc
# cd /usr/etc
```

3. Extract the source files from the tar file by executing the command:

```
# tar xvf moxattyd.tar
```

The following files will be extracted:

**README.TXT**

**moxattyd.c** --- source code

**moxattyd.cf** --- an empty configuration file

**Makefile** --- makefile

**VERSION.TXT** --- fixed tty driver version

**FAQ.TXT**

4. Compile and Link

For SCO UNIX:

```
# make sco
```

For UnixWare 7:

```
# make svr5
```

For UnixWare 2.1.x, SVR4.2:

```
# make svr42
```

## Configuring the UNIX Driver

### Modify the configuration

The configuration used by the **moxattyd program** is defined in the text file **moxattyd.cf**, which is in the same directory that contains the program **moxattyd**. You may use **vi**, or any text editor to modify the file, as follows:

```
ttyp1 192.168.1.1 950
```

For more configuration information, view the file **moxattyd.cf**, which contains detailed descriptions of the various configuration parameters.

<b>NOTE</b> The "Device Name" depends on the OS. See the Device Naming Rule section in README.TXT for more information.
---

To start the **moxattyd** daemon after system bootup, add an entry into **/etc/inittab**, with the tty name you configured in **moxattyd.cf**, as in the following example:

```
ts:2:respawn:/usr/etc/moxattyd/moxattyd -t 1
```

### Device naming rule

For UnixWare 7, UnixWare 2.1.x, and SVR4.2, use:

```
pts/[n]
```

For all other UNIX operating systems, use:

```
ttyp[n]
```

### Starting moxattyd

Execute the command **init q** or reboot your UNIX operating system.

## Adding an additional server

1. Modify the text file **moxattyd.cf** to add an additional server. Users may use vi or any text editor to modify the file. For more configuration information, look at the file **moxattyd.cf**, which contains detailed descriptions of the various configuration parameters.
2. Find the process ID (PID) of the program **moxattyd**.  
**# ps -ef | grep moxattyd**
3. Update configuration of **moxattyd** program.  
**# kill -USR1 [PID]**  
(e.g., if moxattyd PID = 404, **kill -USR1 404**)  
This completes the process of adding an additional server.

# 6

## Basic Settings and Device Server Configuration

---

In the following chapters, we will explain how to access the NPort S8000's various configuration, monitoring, and administration functions. There are multiple ways to access these functions: RS-232 console, Telnet/SSH console, and web browser. The serial console connection method, which requires using a serial cable to connect the NPort S8000 to a PC's COM port, can be used if you do not know the NPort S8000's IP address. The Telnet/SSH console and web browser connection methods can be used to access the NPort S8000 over an Ethernet LAN or over the Internet.

The Web Console is the most user-friendly way to configure the NPort S8000. In this chapter, we use the Web Console interface to introduce the functions that focus on the Basic Settings and Device Server Configuration.

This chapter covers the following topics:

### □ **Basic Settings**

- General Settings
- Time Settings
- Network Settings

### □ **Serial Settings**

- Operation Modes
- Serial Parameters
- Serial ToS Settings

# Basic Settings

## General Settings

### Server name

Setting	Factory Default	Necessity
1 to 40 characters	[model name]_[Serial No.]	Optional

This column is useful for specifying the application of this NPort device server.

### Server Location

Setting	Factory Default	Necessity
1 to 80 characters	Empty	Optional

This column is useful for specifying the location of this NPort device server.

### Server Description

Setting	Factory Default	Necessity
1 to 40 characters	Empty	Optional

This column is useful for specifying more detailed description of this NPort S8000, such as the serial devices connected to the NPort S8000.

### Maintainer contact info

Setting	Factory Default	Necessity
1 to 40 characters	Empty	Optional

This column is useful for specifying the contact information of the administrator responsible for maintaining this NPort S8000.

## Time Settings

**MOXA** Total Solution for NPort S8000 Series Device Server

- Model: - NPort S8455I-MM-SC
- Name: - NPort S8455I-MM-SC\_22112
- Location: -
- IP: - 192.168.127.254
- Serial NO.: - 22112
- MAC A: -
- Firmware: -

**Time Settings**

**Current time** 16 : 54 : 46 (ex: 04:00:04)

**Current date** 2009 / 02 / 18 (ex: 2002/11/13)

**Daylight Saving Time**

**Start date** -- -- -- --

**End date** -- -- -- --

**Offset** 0 hour(s)

**Time zone** (GMT)Greenwich Mean Time: Dublin, Edinburgh, Lisbon, London

**1st time server IP/name**

**2nd time server IP/name**

**Time server query period** 600 sec

**Activate**

### Time

The NPort S8000 Series uses SNTP (RFC-1769) for automatic time-calibration, based on information from a time server or user-specified Time and Date information. Functions such as Auto warning "Email" can add real-time information to the message.



#### ATTENTION

There is a risk of an explosion if the real-time clock battery is replaced with the wrong type! The NPort S8000's real-time clock is powered by a rechargeable battery. We strongly recommend that you do not attempt replacement of the rechargeable battery without help from a qualified Moxa support engineer. If you need to change the battery, please contact the Moxa RMA service team.

#### Current Time

Setting	Description	Factory Default
User adjustable time.	The time parameter allows configuration of the local time in local 24-hour format.	None (hh:mm:ss)

#### Current Date

Setting	Description	Factory Default
User adjustable date.	The date parameter allows configuration of the local date in yyyy/mm/dd format.	None (yyyy/mm/dd)

### Daylight Saving Time

Daylight saving time (also known as **DST** or **summer time**) involves advancing clocks (usually 1 hour) during the summer time to provide an extra hour of daylight in the afternoon.

#### Start Date

Setting	Description	Factory Default
User adjustable date.	The Start Date parameter allows users to enter the date that daylight saving time begins.	None

**End Date**

Setting	Description	Factory Default
User adjustable date.	The End Date parameter allows users to enter the date that daylight saving time ends.	None

**Offset**

Setting	Description	Factory Default
User adjustable hour.	The offset parameter indicates how many hours forward the clock should be advanced.	None

## Time Settings

**Time Zone**

Setting	Description	Factory Default
User selectable time zone.	The time zone setting allows conversion from GMT (Greenwich Mean Time) to local time.	GMT (Greenwich Mean Time)

**NOTE** Changing the time zone will automatically correct the current time. You should configure the time zone before setting the time.

**Time Server IP/Name**

Setting	Description	Factory Default
1st Time Server IP/Name	IP or Domain address (e.g., 192.168.1.1 or time.stdtime.gov.tw or time.nist.gov).	None
2nd Time Server IP/Name	The NPort S8450I-MM-SC will try to locate the 2nd time server if the 1st time server fails to connect.	

**Time Server Query Period**

Setting	Description	Factory Default
Query Period	This parameter determines how frequently the time is updated from the time server.	600 seconds

## Network Settings

The screenshot shows the MOXA web interface for an NPort S8000 Series Device Server. The top header includes the MOXA logo and the text "Total Solution for NPort S8000 Series Device Server". Below this, a green bar displays system information: Model (NPort S8455I-MM-SC), Name (NPort S8455I-MM-SC\_22112), Location (-), IP (192.168.127.254), and Serial NO. (22112). The main content area is titled "Network Parameters" and contains a "Base Network Settings" section. This section includes a dropdown menu for "Auto IP configuration" set to "Disable", and input fields for "IP address" (192.168.127.254), "Subnet mask" (255.255.255.0), "Default gateway", "1st DNS server IP address", and "2nd DNS server IP address". A "TCP alive check time" is set to 7 (0-99 min). An "Activate" button is located at the bottom of the settings area. A left-hand navigation menu lists various settings categories, with "Network Parameters" currently selected.

You must assign a valid IP address to the NPort S8000 before it will work in your network environment. Your network system administrator should provide you with an IP address and related settings for your network. The IP address must be unique within the network (otherwise, the NPort S8000 will not have a valid connection to the network). First time users can refer to Chapter 3, "Initial IP Address Configuration", for more information.

You can choose from four possible IP Configuration modes—**Disable (Static)**, **DHCP**, and **BOOTP**—located under the web console screen's IP configuration drop-down box.

**Auto IP Configuration**

Setting	Description	Factory Default
Disable	Set up the NPort S8000's IP address manually.	Disable
By DHCP	The NPort S8000's IP address will be assigned automatically by the network's DHCP server.	
By BOOTP	The NPort S8000's IP address will be assigned automatically by the network's BOOTP server.	



**ATTENTION**

In Dynamic IP environments, the firmware will retry three times every 30 seconds until network settings are assigned by the DHCP or BOOTP server. The timeout for each try increases from 1 second, to 3 seconds, to 5 seconds.

If the DHCP/BOOTP Server is unavailable, the firmware will use the default IP address (192.168.127.254), Netmask, and Gateway for IP settings.

**IP Address**

Setting	Description	Factory Default
IP Address of the NPort S8000	Identifies the NPort S8000 on a TCP/IP network.	192.168.127.254

An IP address is a number assigned to a network device (such as a computer) as a permanent address on the network. Computers use the IP addresses to identify and talk to each other over the network. Choose a proper IP address which is unique and valid in your network environment.

**Subnet Mask**

Setting	Description	Factory Default
Subnet mask of the NPort S8000	Identifies the type of network to which the NPort S8000 is connected (e.g., 255.255.0.0 for a Class B network, or 255.255.255.0 for a Class C network).	255.255.255.0

A subnet mask represents all the network hosts at one geographic location, in one building, or on the same local area network. When a packet is sent out over the network, the NPort will use the subnet mask to check whether the desired TCP/IP host specified in the packet is on the local network segment. If the address is on the same network segment as the NPort, a connection established directly from the NPort. Otherwise, the connection is established through the given default gateway.

**Default Gateway**

Setting	Description	Factory Default
Default Gateway of the NPort S8000	The IP address of the router that connects the LAN to an outside network.	None

A gateway is a network gateway that acts as an entrance to another network. Usually, the computers that control traffic within the network or at the local Internet service provider are gateway nodes. The NPort needs to know the IP address of the default gateway computer in order to communicate with the hosts outside the local network environment. For the correct gateway IP address information, consult the network administrator.



**DNS IP Address**

<b>Setting</b>	<b>Description</b>	<b>Factory Default</b>
1st DNS Server's IP Address	The IP address of the DNS Server used by your network. After entering the DNS Server's IP address, you can input the NPort S8000's URL (e.g., www.NPortS8000.company.com) in your browser's address field, instead of entering the IP address.	None
2nd DNS Server's IP Address	The IP address of the DNS Server used by your network. The NPort S8000 will try to locate the 2nd DNS Server if the 1st DNS Server fails to connect.	None

When the user wants to visit a particular website, the computer asks a Domain Name System (DNS) server for the website's correct IP address and the computer user the response to connect to the web server. DNS is the way Internet domain names are identified and translated into IP addresses. A domain name is an alphanumeric name, such as moxa.com, that is usually easier to remember. A DNS server is a host that translates this kind of text-based domain name into the numeric IP address used to establish a TCP/IP connection.

In order to use the NPort's DNS feature, you need to set the IP address of the DNS server to be able to access the host with the domain name. The NPort provides **DNS server 1** and **DNS server 2** configuration items to configure the IP address of the DNS server. DNS Server 2 is included for use when DNS sever 1 is unavailable.

The NPort plays the role of DNS client. Functions that support domain name in the NPort are **Time Server IP Address**, **TCP Client-Destination IP Address**, **Mail Server**, **SNMP Trap IP Address**, and **IP Location Server**.

**TCP alive check time**

<b>Setting</b>	<b>Description</b>	<b>Factory Default</b>
0 to 99 min	This field specifies how long the NPort S8000 will wait for a response to "keep alive" packets before closing the TCP connection. The NPort S8000 checks connection status by sending periodic "keep alive" packets. If the remote host does not respond to the packet within the time specified in this field, the NPort S8000 will force the existing TCP connection to close. For socket and Real COM Mode, the NPort S8000 will listen for another TCP connection from another host after closing the connection. If the TCP alive check time is set to 0, the TCP connection will remain open and will not send any "keep alive" packets.	7 min

All serial ports use the same TCP live check time in the NPort S8000 Series.

# Serial Settings

## Operation Modes

Click on **Operation Modes**, located under **Serial Settings**, to display serial port settings for four serial ports. To modify serial operation mode settings for a particular port, click on **Operation Modes** of the serial port in the window on the right-hand side.

The screenshot shows the Moxa web interface for the NPort S8000 Series Device Server. The top navigation bar includes the Moxa logo, the product name 'Total Solution for NPort S8000 Series Device Server', and the website 'www.moxa.com'. A status bar below the navigation bar displays system information: Model (NPort S8455I-MM-SC), Name (NPort S8455I-MM-SC\_22112), Location, IP (192.168.127.254), Serial NO. (22112), MAC Address (00:90:E8:65:A4:4A), and Firmware (V1.1 build 09020812).

The main content area is titled 'Operation Modes' and contains a table with the following data:

Port	Operating mode	Packing length	Delimiter 1	Delimiter 2	Delimiter process	Force transmit
1	Real COM	0	00 (Disable)	00 (Disable)	Do nothing	0
		Max connection: 1				
2	Real COM	0	00 (Disable)	00 (Disable)	Do nothing	0
		Max connection: 1				
3	Real COM	0	00 (Disable)	00 (Disable)	Do nothing	0
		Max connection: 1				
4	Real COM	0	00 (Disable)	00 (Disable)	Do nothing	0
		Max connection: 1				

A red box highlights the 'Operation Modes' table. The left sidebar contains a 'Main Menu' with options: Overview, Basic Settings, General Settings, Time Settings, Network Parameters, Serial Settings, Operation Modes (highlighted), Serial Parameters, Serial ToS, Ethernet Settings, Ethernet Advanced Settings, System Management, System Monitoring, and Restart. At the bottom of the sidebar is the 'goahead WEB SERVER' logo and the text 'Best viewed with IE 5 above at resolution 1024 x 768'.

## Real COM Mode

The screenshot shows the Moxa web interface for the NPort S8000 Series Device Server, specifically the 'Operation Modes' configuration page for Port 1. The top navigation bar and status bar are identical to the previous screenshot.

The main content area is titled 'Operation Modes' and contains the following configuration options:

- Port Settings**
  - Port: 1
  - Operation mode: Real COM (dropdown)
  - Max connection: 1 (dropdown)
  - Ignore jammed IP:  Enable  Disable
  - Allow driver control:  Enable  Disable
  - Connection goes down:
    - RTS:  always low  always high
    - DTR:  always low  always high
- Data Packing**
  - Packet length: 0 (0 - 1024)
  - Delimiter 1: 00 (Hex)  Enable
  - Delimiter 2: 00 (Hex)  Enable
  - Delimiter process: Do nothing (dropdown)
  - Force transmit: 0 (0 - 65535 ms)

At the bottom, there are checkboxes for 'Port 1', 'Port 2', 'Port 3', and 'Port 4'. The 'Port 1' checkbox is checked. Below these is an option to 'Apply the above settings to all serial ports' (unchecked). An 'Activate' button is located at the bottom right.

The left sidebar contains a 'Main Menu' with options: Overview, Basic Settings, Serial Settings, Operation Modes (highlighted), Serial Parameters, Serial ToS, Ethernet Settings, Ethernet Advanced Settings, System Management, System Monitoring, and Restart. At the bottom of the sidebar is the 'goahead WEB SERVER' logo and the text 'Best viewed with IE 5 above at resolution 1024 x 768'.

**Port Settings**

**Max connection**

Setting	Factory Default	Necessity
1, 2, 3, 4, 5, 6, 7, 8	1	Required

This field is used if you need to receive data from different hosts simultaneously. When set to 1, only one specific host can access this port on the NPort S8000, and the Real COM driver on that host will have full control over the port. When set to 2 or greater, the Real COM drivers for up to the specified number of hosts may open this port at the same time. When multiple hosts' Real COM drivers open the port at the same time, the COM driver only provides a pure data tunnel—no control capability provided. The serial port parameters will use firmware settings instead of your application program (AP) settings.

Application software that is based on the COM driver will receive a driver response of "success" when the software uses any of the Win32 API functions. The firmware will only send data back to the driver on the host.

Data will be sent first-in-first-out when data enters the NPort S8000 from the Ethernet interface.



**ATTENTION**

When Max connection is set to 2 to 8, this means that the NPort use a "multiconnection application" (i.e., 2 to 8 hosts are allowed access to the port at the same time). When using a multiconnection application, the NPort will use the serial communication parameters set in the console. All of the hosts connected to that port must use the same serial settings. If one of the hosts opens the COM port with parameters that are different from the NPort's console setting, data communication may not work properly.

**Ignore jammed IP**

Setting	Factory Default	Necessity
Enable or Disable	Disable	Optional

Previously, if "max connection" was greater than 1, the serial device was transmitting data, and a connected host was not responding, then the NPort would wait until the data was transmitted successfully before transmitting the second group of data to all hosts. Currently, if you select Enable for "Ignore jammed IP," the host that is not responding will be ignored, but the data will still be transmitted to the other hosts.

**Allow driver control**

Setting	Factory Default	Necessity
Enable or Disable	Disable	Optional

If "max connection" is greater than 1, the NPort will ignore driver control commands from all connected hosts. However, if you set "Allow driver control" to YES, control commands will be accepted. Note that since the NPort S8000 may get configuration changes from multiple hosts, the most recent command received will take precedence.

**Connection goes down**

Setting	Factory Default	Necessity
Always High or Always Low	Always High	Optional

You can configure what happens to the RTS and DTR signals when the Ethernet connection goes down. For some applications, serial devices need to know the Ethernet link status through RTS or DTR signals sent through the serial port. Use **always low** if you want the RTS and DTR signals to change their status to low when the Ethernet connection goes down. Use **always high** if you do not want the Ethernet connection status to affect the RTS or DTR signals.

**Data Packing**

**Packet length**

Setting	Factory Default	Necessity
0 to 1024	0	Optional

Default = 0, The Delimiter Process will be followed, regardless of the length of the data packet. If the data length (in bytes) matches the configured value, the data will be forced out. The data length can be configured for 0 to 1024 bytes. Set to 0 if you do not need to limit the length.

**Delimiter 1**

Setting	Factory Default	Necessity
00 to FF	None	Optional

**Delimiter 2**

Setting	Factory Default	Necessity
00 to FF	None	Optional

When Delimiter 1 is enabled, the serial port will clear the buffer and send the data to the Ethernet port when a specific character, entered in a hex format, is received. A second delimiter character may be enabled and specified in the Delimiter 2 field, so that both characters act as the delimiter to indicate when data should be sent.



**ATTENTION**

Delimiter 2 is optional. If left blank, then Delimiter 1 alone trips clearing of the buffer. If the size of the serial data received is greater than 1 KB, the NPort will automatically pack the data and send it to the Ethernet. However, to use the delimiter function, you must at least enable Delimiter 1. If Delimiter 1 is left blank and Delimiter 2 is enabled, the delimiter function will not work properly.

**Delimiter process**

Setting	Factory Default	Necessity
Do nothing Delimiter + 1 Delimiter + 2 Strip Delimiter	Do Nothing	Optional

[Delimiter + 1] or [Delimiter + 2]: The data will be transmitted when an additional byte (for Delimiter +1), or an additional 2 bytes (for Delimiter +2) of data is received after receiving the Delimiter.

[Strip Delimiter]: When the Delimiter is received, the Delimiter is deleted (i.e., stripped), and the remaining data is transmitted.

[Do nothing]: The data will be transmitted when the Delimiter is received.

**Force transmit**

Setting	Factory Default	Necessity
0 to 65535 ms	0 ms	Optional

0: Disable the Force Transmit timeout.

1 to 65535: Forces the NPort's TCP/IP protocol software to try to pack serial data received during the specified time into the same data frame.

This parameter defines the time interval during which the NPort fetches the serial data from its internal buffer. If data is incoming through the serial port, the NPort stores the data in the internal buffer. The NPort transmits data stored in the buffer via TCP/IP, but only if the internal buffer is full, or if the Force Transmit time interval reaches the time specified under Force Transmit timeout.

Optimal Force Transmit timeout differs according to your application, but it must be at least larger than one character interval within the specified baudrate. For example, assume that the serial port is set to 1200 bps, 8 data bits, 1 stop bit, and no parity. In this case, the total number of bits needed to send a character is 10 bits, and the time required to transfer one character is

$$10 \text{ (bits)} / 1200 \text{ (bits/s)} * 1000 \text{ (ms/s)} = 8.3 \text{ ms.}$$

Therefore, you should set Force Transmit timeout to be larger than 8.3 ms. Force Transmit timeout is specified in milliseconds and must be larger than 10 ms.

If the user wants to send the series of characters in a packet, the serial device attached to the NPort should send characters without time delay larger than Force Transmit timeout between characters and the total length of data must be smaller than or equal to the NPort’s internal buffer size. The serial communication buffer size of the NPort is 1 Kbytes per port.

**Parameter Copy**

Apply the above setting to other serial ports, you may use the checkboxes at the bottom of the window to apply the settings to one or more ports.

**RFC2217 Mode**

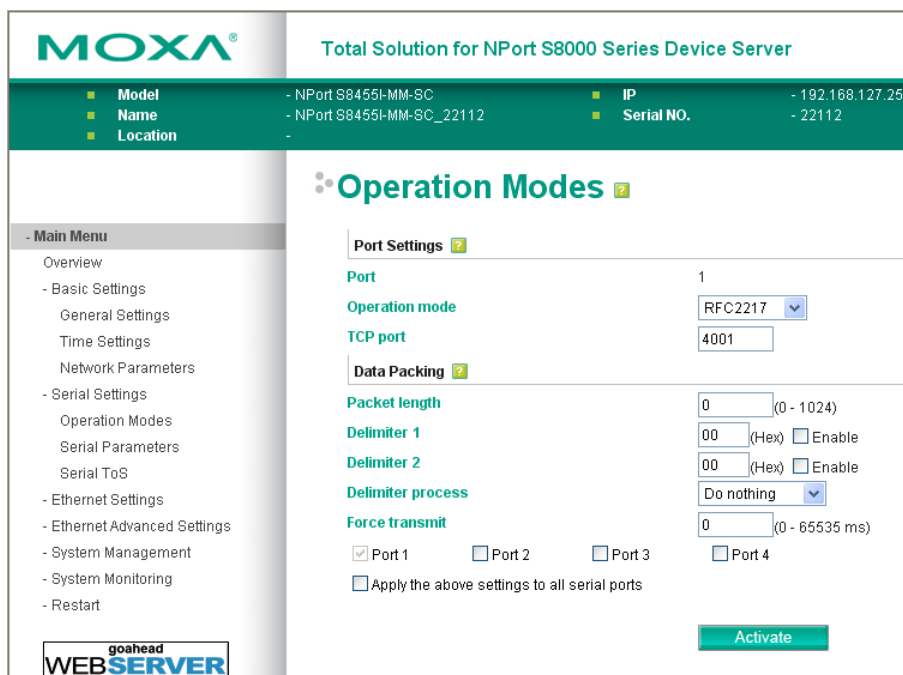

**Port Settings**

**TCP port (default=4001)**

This is the TCP port number assignment for the serial port on the NPort S8000. It is the port number that the serial port uses to listen to connections and that other devices must use to contact the serial port. To avoid conflicts with well-known TCP ports, the default is set to 4001.

**Data Packing**

**Packet length**

Setting	Factory Default	Necessity
0 to 1024	0	Optional

Default = 0, The Delimiter Process will be followed, regardless of the length of the data packet. If the data length (in bytes) matches the configured value, the data will be forced out. The data length can be configured for 0 to 1024 bytes. Set to 0 if you do not need to limit the length.

***Delimiter 1***

<b>Setting</b>	<b>Factory Default</b>	<b>Necessity</b>
00 to FF	None	Optional

***Delimiter 2***

<b>Setting</b>	<b>Factory Default</b>	<b>Necessity</b>
00 to FF	None	Optional

When Delimiter 1 is enabled, the serial port will clear the buffer and send the data to the Ethernet port when a specific character, entered in a hex format, is received. A second delimiter character may be enabled and specified in the Delimiter 2 field, so that both characters act as the delimiter to indicate when data should be sent.



**ATTENTION**

Delimiter 2 is optional. If left blank, then Delimiter 1 alone trips clearing of the buffer. If the size of the serial data received is greater than 1 KB, the NPort will automatically pack the data and send it to the Ethernet. However, to use the delimiter function, you must at least enable Delimiter 1. If Delimiter 1 is left blank and Delimiter 2 is enabled, the delimiter function will not work properly.

***Delimiter process***

<b>Setting</b>	<b>Factory Default</b>	<b>Necessity</b>
Do nothing Delimiter + 1 Delimiter + 2 Strip Delimiter	Do Nothing	Optional

[Delimiter + 1] or [Delimiter + 2]: The data will be transmitted when an additional byte (for Delimiter +1), or an additional 2 bytes (for Delimiter +2) of data is received after receiving the Delimiter.

[Strip Delimiter]: When the Delimiter is received, the Delimiter is deleted (i.e., stripped), and the remaining data is transmitted.

[Do nothing]: The data will be transmitted when the Delimiter is received.

***Force transmit***

<b>Setting</b>	<b>Factory Default</b>	<b>Necessity</b>
0 to 65535 ms	0 ms	Optional

0: Disable the Force Transmit timeout.

1 to 65535: Forces the NPort's TCP/IP protocol software to try to pack serial data received during the specified time into the same data frame.

This parameter defines the time interval during which the NPort fetches the serial data from its internal buffer. If data is incoming through the serial port, the NPort stores the data in the internal buffer. The NPort transmits data stored in the buffer via TCP/IP, but only if the internal buffer is full or if the Force Transmit time interval reaches the time specified under Force Transmit timeout.

Optimal Force Transmit timeout differs according to your application, but it must be at least larger than one character interval within the specified baudrate. For example, assume that the serial port is set to 1200 bps, 8 data bits, 1 stop bit, and no parity. In this case, the total number of bits needed to send a character is 10 bits, and the time required to transfer one character is

$$10 \text{ (bits)} / 1200 \text{ (bits/s)} * 1000 \text{ (ms/s)} = 8.3 \text{ ms.}$$

Therefore, you should set Force Transmit timeout to be larger than 8.3 ms. Force Transmit timeout is specified in milliseconds and must be larger than 10 ms.

If the user wants to send the series of characters in a packet, the serial device attached to the NPort should send characters without time delay larger than Force Transmit timeout between characters and the total length of data must be smaller than or equal to the NPort's internal buffer size. The serial communication buffer size of the NPort is 1 Kbytes per port.

**Parameter Copy**

Apply the above setting to other serial ports; you may use the checkboxes at the bottom of the window to apply the settings to one or more ports.

**TCP Server Mode**



**Port Settings**

**Inactivity time**

Setting	Factory Default	Necessity
0 to 65535 ms	0 ms	Optional

0 ms: TCP connection is not closed due to an idle serial line.

0-65535 ms: The NPort automatically closes the TCP connection if there is no serial data activity for the given time. After the connection is closed, the NPort starts listening for another host's TCP connection.

This parameter defines the maintenances status as Closed or Listen on the TCP connection. The connection is closed if there is no incoming or outgoing data through the serial port during the specific Inactivity time.

If the value of inactivity time is set to 0, the current TCP connection is maintained until there is connection close request. Although inactivity time is disabled, the NPort will check the connection status between the NPort and remote host by sending "keep alive" packets periodically. If the remote host does not respond to the packet, it assumes that the connection was closed down unintentionally. The NPort will then force the existing TCP connection to close.



**ATTENTION**

The Inactivity time should at least be set larger than that of Force Transmit timeout. To prevent the unintended loss of data due to the session being disconnected, it is highly recommended that this value is set large enough so that the intended data transfer is completed.

**Max connection**

Setting	Factory Default	Necessity
1, 2, 3, 4, 5, 6, 7, 8	1	Required

This field is used if you need to receive data from different hosts simultaneously. When set to 1, only one specific host can access this port of the NPort S8000, and the Real COM driver on that host will have full control over the port. When set to 2 or greater, up to the specified number of hosts' Real COM drivers may open this port at the same time. When multiple hosts' Real COM drivers open the port at the same time, the COM driver only provides a pure data tunnel—no control ability. The serial port parameters will use firmware settings instead of depending on your application program (AP).

Application software that is based on the COM driver will receive a driver response of "success" when the software uses any of the Win32 API functions. The firmware will only send data back to the driver on the host.

Data will be sent first-in-first-out when data enters the NPort S8000 from the Ethernet interface.



**ATTENTION**

When Max connection is set to 2 to 8, this means that the NPort will be using a "multiconnection application" (i.e., 2 to 8 hosts are allowed access to the port at the same time). When using a multiconnection application, the NPort will use the serial communication parameters set in the console. All of the hosts connected to that port must use the same serial settings. If one of the hosts opens the COM port with parameters that are different from the NPort's console setting, data communication may not work properly.

**Ignore jammed IP**

Setting	Factory Default	Necessity
Enable or Disable	Disable	Optional

Previously, if "max connection" was greater than 1, the serial device was transmitting data, and a connected host was not responding, the NPort would wait until the data was transmitted successfully before transmitting the second group of data to all hosts. Currently, if you select Enable for "Ignore jammed IP," the host that is not responding will be ignored, but the data will still be transmitted to the other hosts.

**Allow driver control**

Setting	Factory Default	Necessity
Enable or Disable	Disable	Optional

If "max connection" is greater than 1, the NPort will ignore driver control commands from all connected hosts. However, if you set "Allow driver control" to YES, control commands will be accepted. Note that since the NPort S8000 may get configuration changes from multiple hosts, the most recent command received will take precedence.

**Connection goes down**

Setting	Factory Default	Necessity
Always High or Always Low	Always High	Optional

You can configure what happens to the RTS and DTR signals when the Ethernet connection goes down. For some applications, serial devices need to know the Ethernet link status through RTS or DTR signals sent through the serial port. Use **Always Low** if you want the RTS and DTR signal to change their state to low when the Ethernet connection goes down. Use **Always High** if you do not want the Ethernet connection status to affect the RTS or DTR signals.



**Data Packing**

**Packet length**

Setting	Factory Default	Necessity
0 to 1024	0	Optional

Default = 0, The Delimiter Process will be followed, regardless of the length of the data packet. If the data length (in bytes) matches the configured value, the data will be forced out. The data length can be configured for 0 to 1024 bytes. Set to 0 if you do not need to limit the length.

**Delimiter 1**

Setting	Factory Default	Necessity
00 to FF	None	Optional

**Delimiter 2**

Setting	Factory Default	Necessity
00 to FF	None	Optional

When Delimiter 1 is enabled, the serial port will clear the buffer and send the data to the Ethernet port when a specific character, entered in a hex format, is received. A second delimiter character may be enabled and specified in the Delimiter 2 field, so that both characters act as the delimiter to indicate when data should be sent.



**ATTENTION**

Delimiter 2 is optional. If left blank, then Delimiter 1 alone trips clearing of the buffer. If the size of the serial data received is greater than 1 KB, the NPort will automatically pack the data and send it to the Ethernet. However, to use the delimiter function, you must at least enable Delimiter 1. If Delimiter 1 is left blank and Delimiter 2 is enabled, the delimiter function will not work properly.

**Delimiter process**

Setting	Factory Default	Necessity
Do nothing Delimiter + 1 Delimiter + 2 Strip Delimiter	Do Nothing	Optional

[Delimiter + 1] or [Delimiter + 2]: The data will be transmitted when an additional byte (for Delimiter +1), or an additional 2 bytes (for Delimiter +2) of data is received after receiving the Delimiter.

[Strip Delimiter]: When the Delimiter is received, the Delimiter is deleted (i.e., stripped), and the remaining data is transmitted.

[Do nothing]: The data will be transmitted when the Delimiter is received.

**Force transmit**

Setting	Factory Default	Necessity
0 to 65535 ms	0 ms	Optional

0: Disable the Force Transmit timeout.

1 to 65535: Forces the NPort's TCP/IP protocol software to try to pack serial data received during the specified time into the same data frame.

This parameter defines the time interval during which the NPort fetches the serial data from its internal buffer. If data is incoming through the serial port, the NPort stores the data in the internal buffer. The NPort transmits data stored in the buffer via TCP/IP, but only if the internal buffer is full or if the Force Transmit time interval reaches the time specified under Force Transmit timeout.

Optimal Force Transmit timeout differs according to your application, but it must be at least larger than one character interval within the specified baudrate. For example, assume that the serial port is set to 1200 bps, 8 data bits, 1 stop bit, and no parity. In this case, the total number of bits needed to send a character is 10 bits, and the time required to transfer one character is

$$10 \text{ (bits)} / 1200 \text{ (bits/s)} * 1000 \text{ (ms/s)} = 8.3 \text{ ms.}$$

Therefore, you should set Force Transmit timeout to be larger than 8.3 ms. Force Transmit timeout is specified in milliseconds and must be larger than 10 ms.

If the user wants to send the series of characters in a packet, the serial device attached to the NPort should send characters without time delay larger than Force Transmit timeout between characters and the total length of data must be smaller than or equal to the NPort's internal buffer size. The serial communication buffer size of the NPort is 1 Kbytes per port.

**TCP Server Mode**

**Local TCP port**

Setting	Factory Default	Necessity
1 to 65535	4001	Required

The TCP port that the NPort uses to listen to connections and that other devices must use to contact the NPort. To avoid conflicts with well-known TCP ports, the default is set to 4001.

**Command port**

Setting	Factory Default	Necessity
1 to 65535	966	Optional

The Command port is the TCP port for listening to SSDK commands from the host. In order to prevent a TCP port conflict with other applications, the user can adjust the command port to another port if needed. And SSDK Commands will automatically check out the Command Port on the NPort so that the user does not need to configure the program.

**Parameter Copy**

Apply the above setting to other serial ports, you may use the checkboxes at the bottom of the window to apply the settings to one or more ports.

## TCP Client Mode

The screenshot shows the MOXA configuration web interface for an NPort S8000 Series Device Server. The main menu on the left includes Overview, Basic Settings, Serial Settings, Operation Modes, Serial Parameters, Serial ToS, Ethernet Settings, Ethernet Advanced Settings, System Management, System Monitoring, and Restart. The 'Operation Modes' section is active, showing 'Port Settings' for port 1. The 'Operation mode' is set to 'TCP Client'. The 'Inactivity time' is set to 0 ms. The 'Ignore jammed IP' is set to 'Disable'. The 'Data Packing' section includes 'Packet length' (0), 'Delimiter 1' (00), 'Delimiter 2' (00), and 'Force transmit' (0). The 'TCP Client Mode' section includes 'Destination IP Address' (Ports 4001-4004), 'Designated Local Port' (5001-5004), and 'TCP connect on' (Startup/None). There are checkboxes for 'Port 1', 'Port 2', 'Port 3', and 'Port 4', and an 'Apply the above settings to all serial ports' checkbox. An 'Activate' button is at the bottom.

### Port Settings

#### Inactivity time

Setting	Factory Default	Necessity
0 to 65535 ms	0 ms	Optional

0 ms: TCP connection is not closed due to an idle serial line.

0-65535 ms: The NPort automatically closes TCP connection, if there is no serial data activity for the given time.

This parameter defines the maintenance status as Closed or Listen on the TCP connection. The connection is closed if there is no incoming or outgoing data through the serial port during the specific Inactivity time.

If the value of inactivity time is set to 0, the current TCP connection is maintained until there's connection close request. Although the inactivity time is disabled, the NPort will check the connection status between the NPort and remote host by sending "keep alive" packets periodically. If the remote host does not respond to the packets, it treats the connection as being down unintentionally. The NPort will then force the existing TCP connection to close.



### ATTENTION

The Inactivity time should at least be set larger than that of Force transmit timeout. To prevent the unintended loss of data due to the session being disconnected, it is highly recommended that this value is set large enough so that the intended data transfer is completed.



**ATTENTION**

Inactivity time is ONLY active when "TCP connect on" is set to "Any character."

**Ignore jammed IP**

Setting	Factory Default	Necessity
Enable or Disable	Disable	Optional

Previously, if "max connection" was greater than 1, the serial device was transmitting data, and a connected host was not responding, the NPort would wait until the data was transmitted successfully before transmitting the second group of data to all hosts. Currently, if you select Enable for "Ignore jammed IP," the host that is not responding will be ignored, but the data will still be transmitted to the other hosts.

**Data Packing**

**Packet length**

Setting	Factory Default	Necessity
0 to 1024	0	Optional

Default = 0, The Delimiter Process will be followed, regardless of the length of the data packet. If the data length (in bytes) matches the configured value, the data will be forced out. The data length can be configured for 0 to 1024 bytes. Set to 0 if you do not need to limit the length.

**Delimiter 1**

Setting	Factory Default	Necessity
00 to FF	None	Optional

**Delimiter 2**

Setting	Factory Default	Necessity
00 to FF	None	Optional

When Delimiter 1 is enabled, the serial port will clear the buffer and send the data to the Ethernet port when a specific character, entered in a hex format, is received. A second delimiter character may be enabled and specified in the Delimiter 2 field, so that both characters act as the delimiter to indicate when data should be sent.



**ATTENTION**

Delimiter 2 is optional. If left blank, then Delimiter 1 alone trips clearing of the buffer. If the size of the serial data received is greater than 1 KB, the NPort will automatically pack the data and send it to the Ethernet. However, to use the delimiter function, you must at least enable Delimiter 1. If Delimiter 1 is left blank and Delimiter 2 is enabled, the delimiter function will not work properly.

**Delimiter process**

Setting	Factory Default	Necessity
Do nothing	Do Nothing	Optional
Delimiter + 1		
Delimiter + 2		
Strip Delimiter		

[Delimiter + 1] or [Delimiter + 2]: The data will be transmitted when an additional byte (for Delimiter +1), or an additional 2 bytes (for Delimiter +2) of data is received after receiving the Delimiter.

[Strip Delimiter]: When the Delimiter is received, the Delimiter is deleted (i.e., stripped), and the remaining data is transmitted.

[Do nothing]: The data will be transmitted when the Delimiter is received.

**Force transmit**

Setting	Factory Default	Necessity
0 to 65535 ms	0 ms	Optional

0: Disable the Force Transmit timeout.

1 to 65535: Forces the NPort’s TCP/IP protocol software to try to pack serial data received during the specified time into the same data frame.

This parameter defines the time interval during which the NPort fetches the serial data from its internal buffer. If data is incoming through the serial port, the NPort stores the data in the internal buffer. The NPort transmits data stored in the buffer via TCP/IP, but only if the internal buffer is full or if the Force Transmit time interval reaches the time specified under Force Transmit timeout.

Optimal Force Transmit timeout differs according to your application, but it must be at least larger than one character interval within the specified baudrate. For example, assume that the serial port is set to 1200 bps, 8 data bits, 1 stop bit, and no parity. In this case, the total number of bits needed to send a character is 10 bits, and the time required to transfer one character is

$$10 \text{ (bits)} / 1200 \text{ (bits/s)} * 1000 \text{ (ms/s)} = 8.3 \text{ ms.}$$

Therefore, you should set Force Transmit timeout to be larger than 8.3 ms. Force Transmit timeout is specified in milliseconds and must be larger than 10 ms.

If the user wants to send the series of characters in a packet, the serial device attached to the NPort should send characters without time delay larger than Force Transmit timeout between characters and the total length of data must be smaller than or equal to the NPort’s internal buffer size. The serial communication buffer size of the NPort is 1 Kbytes per port.

**TCP Client Mode**

**Destination IP address 1**

Setting	Factory Default	Necessity
IP address or Domain Address (E.g., 192.168.1.1)	None	Required

Allows the NPort to connect actively to the remote host whose address is set by this parameter.

**Destination IP address 2/3/4**

Setting	Factory Default	Necessity
IP address or Domain Address (E.g., 192.168.1.1)	None	Required

Allows the NPort to connect actively to the remote host whose address is set by this parameter.

**TCP port** (default=4001): This is the TCP port number assignment for the serial port on the NPort S8000. It is the port number that the serial port uses to listen to connections and that other devices must use to contact the serial port. To avoid conflicts with well-known TCP ports, the default is set to 4001.



**ATTENTION**

Up to four connections can be established between the NPort and hosts. The connection speed or throughput may be low if one of the four connections is slow, since the slow connection will slow down the other three connections.



**ATTENTION**

The "Destination IP address" parameter can use both IP address and Domain Name. For some applications, the user may need to send the data actively to the remote destination domain name.

**Designated Local Port 1/2/3/4**

Setting	Factory Default	Necessity
TCP Port No.	5001 (Port 1) 5002 (Port 2) 5003 (Port 3) 5004 (Port 4)	Required

**Connection control**

Setting	Factory Default	Necessity
Startup/None, Any Character/None, Any Character/Inactivity Time, DSR ON/DSR OFF, DSR ON/None, DCD ON/DCD OFF, DCD ON/None	Startup/None	Required

The meaning of each of the above settings is given in the table below. In general, both the Connect condition and Disconnect condition are given.

**TCP Connection on**

Connect/Disconnect	Description
Startup/None (default)	A TCP connection will be established on startup, and will remain active indefinitely.
Any Character/None	A TCP connection will be established when any character is received from the serial interface, and will remain active indefinitely.
Any Character/ Inactivity Time	A TCP connection will be established when any character is received from the serial interface, and will be disconnected when the Inactivity time out is reached.
DSR On/DSR Off	A TCP connection will be established when a DSR "On" signal is received, and will be disconnected when a DSR "Off" signal is received.
DSR On/None	A TCP connection will be established when a DSR "On" signal is received, and will remain active indefinitely.
DCD On/DCD Off	A TCP connection will be established when a DCD "On" signal is received, and will be disconnected when a DCD "Off" signal is received.
DCD On/None	A TCP connection will be established when a DCD "On" signal is received, and will remain active indefinitely.

**Parameter Copy**

Apply the above setting to other serial ports, you may use the checkboxes at the bottom of the window to apply the settings to one or more ports.

## UDP Mode

Setting	Factory Default	Necessity
Packing length	0	Optional

Setting	Factory Default	Necessity
Delimiter 1	None	Optional
Delimiter 2	None	Optional

### Data Packing

#### Packing length

Setting	Factory Default	Necessity
0 to 1024	0	Optional

Default = 0, The Delimiter Process will be followed, regardless of the length of the data packet. If the data length (in bytes) matches the configured value, the data will be forced out. The data length can be configured for 0 to 1024 bytes. Set to 0 if you do not need to limit the length.

#### Delimiter 1

Setting	Factory Default	Necessity
00 to FF	None	Optional

#### Delimiter 2

Setting	Factory Default	Necessity
00 to FF	None	Optional

When Delimiter 1 is enabled, the serial port will clear the buffer and send the data to the Ethernet port when a specific character, entered in a hex format, is received. A second delimiter character may be enabled and specified in the Delimiter 2 field, so that both characters act as the delimiter to indicate when data should be sent.



### ATTENTION

Delimiter 2 is optional. If left blank, then Delimiter 1 alone trips clearing of the buffer. If the size of the serial data received is greater than 1 KB, the NPort will automatically pack the data and send it to the Ethernet. However, to use the delimiter function, you must at least enable Delimiter 1. If Delimiter 1 is left blank and Delimiter 2 is enabled, the delimiter function will not work properly.

***Delimiter process***

Setting	Factory Default	Necessity
Do nothing Delimiter + 1 Delimiter + 2 Strip Delimiter	Do Nothing	Optional

[Delimiter + 1] or [Delimiter + 2]: The data will be transmitted when an additional byte (for Delimiter +1), or an additional 2 bytes (for Delimiter +2) of data is received after receiving the Delimiter.

[Strip Delimiter]: When the Delimiter is received, the Delimiter is deleted (i.e., stripped), and the remaining data is transmitted.

[Do nothing]: The data will be transmitted when the Delimiter is received.

***Force transmit***

Setting	Factory Default	Necessity
0 to 65535 ms	0 ms	Optional

0: Disable the Force Transmit timeout.

1 to 65535: Forces the NPort’s TCP/IP protocol software to try to pack serial data received during the specified time into the same data frame.

This parameter defines the time interval during which the NPort fetches the serial data from its internal buffer. If data is incoming through the serial port, the NPort stores the data in the internal buffer. The NPort transmits data stored in the buffer via TCP/IP, but only if the internal buffer is full or if the Force Transmit time interval reaches the time specified under Force Transmit timeout.

Optimal Force Transmit timeout differs according to your application, but it must be at least larger than one character interval within the specified baudrate. For example, assume that the serial port is set to 1200 bps, 8 data bits, 1 stop bit, and no parity. In this case, the total number of bits needed to send a character is 10 bits, and the time required to transfer one character is

**10 (bits) / 1200 (bits/s) \* 1000 (ms/s) = 8.3 ms.**

Therefore, you should set Force Transmit timeout to be larger than 8.3 ms. Force Transmit timeout is specified in milliseconds and must be larger than 10 ms.

If the user wants to send the series of characters in a packet, the serial device attached to the NPort should send characters without time delay larger than Force Transmit timeout between characters and the total length of data must be smaller than or equal to the NPort’s internal buffer size. The serial communication buffer size of the NPort is 1 Kbytes per port.

**UDP Mode**

***Destination IP address 1***

Setting	Factory Default		Necessity
IP address range E.g., Begin: 192.168.1.1 End: 192.168.1.10	Begin:	Empty	Required
	End:	Empty	
	Port:	4001	

***Destination IP address 2/3/4***

Setting	Factory Default		Necessity
IP address range E.g., Begin: 192.168.1.11 End: 192.168.1.20	Begin:	Empty	Optional
	End:	Empty	
	Port:	4001	



**Local listen port**

Setting	Factory Default	Necessity
1 to 65535	4001	Required

The UDP port that the NPort listens to, and that other devices must use to contact the NPort. To avoid conflicts with well-known UDP ports, the default is set to 4001.

**Parameter Copy**

Apply the above setting to other serial ports, you may use the checkboxes at the bottom of the window to apply the settings to one or more ports.

**Disabled Mode**

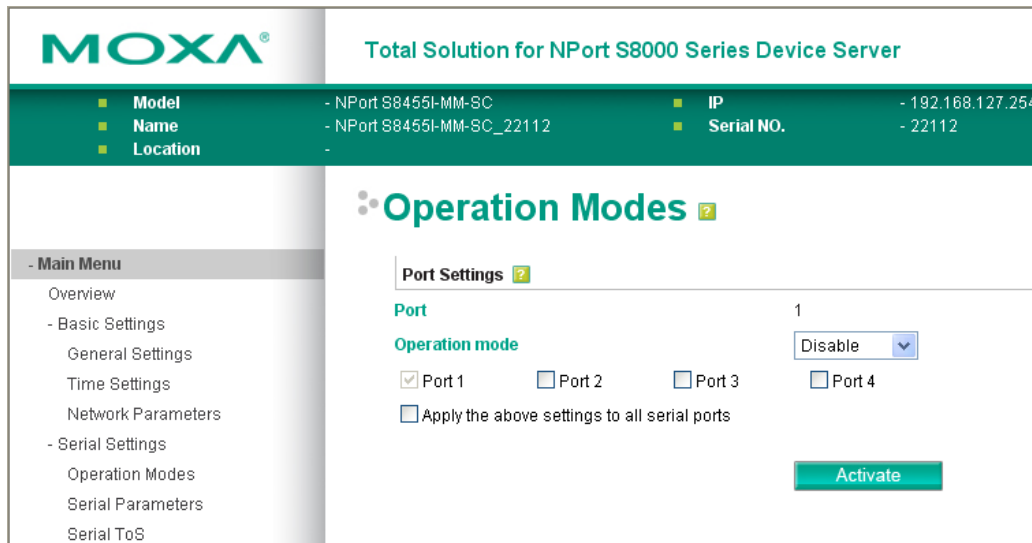

When Operation mode is set to Disabled, that particular port will be disabled. Check the "Apply the above settings to all serial ports" to apply this setting to the other port.

Apply the above setting to other serial ports, you may use the checkboxes at the bottom of the window to apply the settings to one or more ports.

**Serial Parameters**

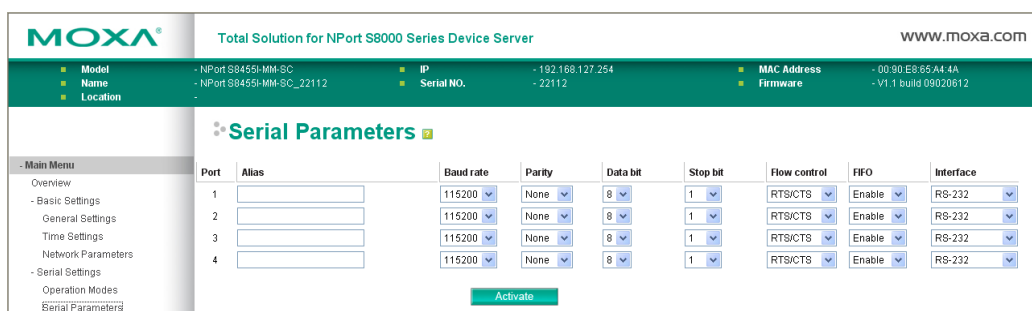

**Port alias**

Setting	Factory Default	Necessity
1 to 16 characters (E.g., PLC-No.1)	None	Optional

Port Alias is specially designed to allow easy identification of the serial devices which are connected to the NPort's serial port.

**Baud rate**

Setting	Factory Default	Necessity
50 bps to 921600 bps	115200 bps	Required

Select one of the standard baudrates from 50 bps to 921.6 Kbps in the dropdown box, or select **Other** and then type the desired baudrate in the input box.



**ATTENTION**

If the port requires a special baudrate that is not listed, such as 500000 bps, you can select the **Other** option and enter the desired baudrate into the text box. The NPort S8000 will automatically calculate the closest supported baudrate. The margin for error will be less than 1.7% for all baudrates under 921600 bps.

**Parity**

Setting	Factory Default	Necessity
None, Even, Odd, Space, Mark	None	Required

**Data bits**

Setting	Factory Default	Necessity
5, 6, 7, 8	8	Required

When the user sets **Data bits** to 5 bits, the stop bits setting will automatically change to 1.5 bits.

**Stop bits**

Setting	Factory Default	Necessity
1, 2	1	Required

Stop bits will be set to 1.5 when **Data bits** is set to 5 bits.

**Flow control**

Setting	Factory Default	Necessity
None, RTS/CTS, Xon/Xoff	RTS/CTS	Required

**FIFO**

Setting	Factory Default	Necessity
Enable, Disable	Enable	Required

The NPort's serial ports provide a 16-byte FIFO both in the Tx and Rx directions. Disable the FIFO setting when your serial device does not have a FIFO to prevent data loss during communication.

**Interface**

Setting	Factory Default	Necessity
RS-232, RS-422, RS-485 2-wire, RS-485 4-wire	RS-232	Required



**ATTENTION**

Check the serial communication parameters in your serial device's user's manual. You should set up the NPort's serial parameters with the same communication parameters used by your serial devices.

# Serial ToS Settings

## Using Serial Traffic Prioritization

The NPort S8000’s traffic prioritization capability provides Quality of Service (QoS) to your network by making data delivery more reliable. You can prioritize traffic from both serial interface and Ethernet interface on your network to ensure that high priority data is transmitted with minimum delay.

Traffic can be controlled by a set of rules to obtain the required Quality of Service for your network. The rules define different types of traffic and specify how each type should be treated as it passes through the NPort S8000. The NPort S8000 can inspect layer 3 TOS information to each serial port to provide consistent classification of the entire network. The NPort S8000’s QoS capability improves the performance and determinism of industrial networks for mission critical applications.

## The Serial Traffic Prioritization Concept

### What is Traffic Prioritization?

Traffic prioritization allows you to prioritize data so that time-sensitive and system-critical data can be transferred smoothly and with minimal delay over a network. The benefits of using traffic prioritization are:

- Improve network performance by controlling a wide variety of traffic and managing congestion.
- Assign priorities to different categories of traffic. For example, set higher priorities for time-critical or business-critical applications.
- Provide predictable throughput for multimedia applications, such as video conferencing or voice over IP, and minimize traffic delay and jitter.
- Improve network performance as the amount of traffic grows. This will save cost by reducing the need to keep adding bandwidth to the network.

Port	Enable ToS	DSCP value
1	<input type="checkbox"/>	0 0
2	<input type="checkbox"/>	0 0
3	<input type="checkbox"/>	0 0
4	<input type="checkbox"/>	0 0

**Activate**

## DiffServ Code Point (DSCP)

### Differentiated Services (DiffServ) Traffic Marking

DiffServ is a Layer 3 marking scheme that uses the DiffServ Code Point (DSCP) field in the IP header to store the packet priority information. DSCP is an advanced intelligent method of traffic marking as you can choose how your network prioritizes different types of traffic. DSCP uses 64 values that map to user-defined service levels, allowing you to establish more control over network traffic. Please reference to "ToS/DiffServ Mapping" setting menu.

#### DSCP Value

00	04	08	0C
10	14	18	1C
20	24	28	2C
30	34	38	3C
40	44	48	4C
50	54	58	5C
60	64	68	6C
70	74	78	7C
80	84	88	8C
90	94	98	9C
A0	A4	A8	AC
B0	B4	B8	BC
C0	C4	C8	CC
D0	D4	D8	DC
0E	E4	E8	EC
F0	F4	F8	FC

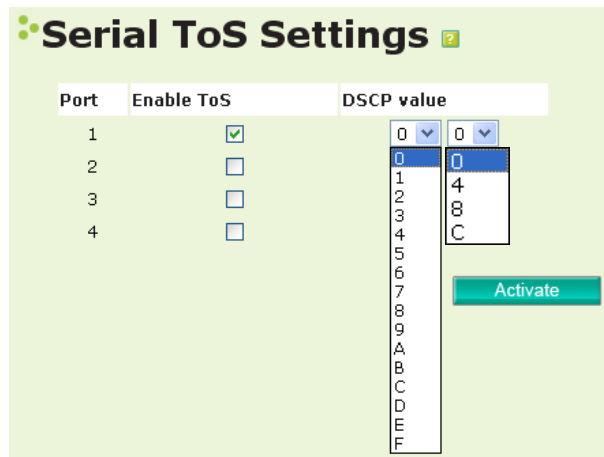

Enter the "ToS/DiffServ Mapping" setting menu to reference or modified the ToS level.

Mapping Table of ToS (DSCP) Value and Priority Queues							
ToS	Level	ToS	Level	ToS	Level	ToS	Level
0x00(1)	Low	0x04(2)	Low	0x08(3)	Low	0x0C(4)	Low
0x10(5)	Low	0x14(6)	Low	0x18(7)	Low	0x1C(8)	Low
0x20(9)	Low	0x24(10)	Low	0x28(11)	Low	0x2C(12)	Low
0x30(13)	Low	0x34(14)	Low	0x38(15)	Low	0x3C(16)	Low
0x40(17)	Normal	0x44(18)	Normal	0x48(19)	Normal	0x4C(20)	Normal
0x50(21)	Normal	0x54(22)	Normal	0x58(23)	Normal	0x5C(24)	Normal
0x60(25)	Normal	0x64(26)	Normal	0x68(27)	Normal	0x6C(28)	Normal
0x70(29)	Normal	0x74(30)	Normal	0x78(31)	Normal	0x7C(32)	Normal
0x80(33)	Medium	0x84(34)	Medium	0x88(35)	Medium	0x8C(36)	Medium
0x90(37)	Medium	0x94(38)	Medium	0x98(39)	Medium	0x9C(40)	Medium
0xA0(41)	Medium	0xA4(42)	Medium	0xA8(43)	Medium	0xAC(44)	Medium
0xB0(45)	Medium	0xB4(46)	Medium	0xB8(47)	Medium	0xBC(48)	Medium
0xC0(49)	High	0xC4(50)	High	0xC8(51)	High	0xCC(52)	High
0xD0(53)	High	0xD4(54)	High	0xD8(55)	High	0xDC(56)	High
0xE0(57)	High	0xE4(58)	High	0xE8(59)	High	0xEC(60)	High
0xF0(61)	High	0xF4(62)	High	0xF8(63)	High	0xFC(64)	High

**Activate**

Setting	Description	Factory Default	Necessity
Enable ToS	Enable the ToS transmitting the video stream with the given priority	Disable	Optional
DSCP Value	Set the mapping table of different TOS values to 4 different egress queues.	0,0	Optional



**ATTENTION**

To configure the ToS values, map to the network environment settings for QoS priority service. Please refer to **Chapter 7, Ethernet Advanced Settings / Configuring Ethernet Traffic Prioritization / CoS Mapping**.

# Switch Featured Functions

---

This chapter explains how to access the NPort S8000's various configuration, monitoring, and administration functions. There are three ways to access these functions: RS-232 console, Telnet/SSH console, and web browser. The serial console connection method, which requires using a short serial cable to connect the NPort S8000 to a PC's COM port, can be used if you do not know the NPort S8000's IP address. The Telnet console and web browser connection methods can be used to access the NPort S8000 over an Ethernet LAN, or over the Internet.

The Web Console is the most user-friendly way to configure the NPort S8000. In this chapter, we use the Web Console interface to introduce the functions. There are only a few differences between the Web Console, Serial Console, and Telnet Console.

The following topics are covered in this chapter:

- ❑ **Ethernet Settings**
- ❑ **STP/RSTP**
- ❑ **Bandwidth Management**
- ❑ **Line Swap Fast Recovery**
- ❑ **Ethernet Advanced Settings**
- ❑ **Virtual LAN**
- ❑ **Multicast Filtering**
- ❑ **Set Device IP**
- ❑ **System Management**
- ❑ **SysLog Server**
- ❑ **Port Access Control**
- ❑ **Configuring E-Mail Alert**
- ❑ **Configuring SNMP**
- ❑ **Maintenance**
- ❑ **System Monitoring**
- ❑ **Restart**

# Ethernet Settings

## Port Settings

**Port Settings** ?

Port	Enable	Description	Name	Speed	FDX flow ctrl	MDI/MDIX
1	<input checked="" type="checkbox"/>	100TX,RJ45.	<input type="text"/>	Auto	Disable	Auto
2	<input checked="" type="checkbox"/>	100TX,RJ45.	<input type="text"/>	Auto	Disable	Auto
3	<input checked="" type="checkbox"/>	100TX,RJ45.	<input type="text"/>	Auto	Disable	Auto
4	<input checked="" type="checkbox"/>	100SC,Multi.	<input type="text"/>	100M-Full	Disable	MDI
5	<input checked="" type="checkbox"/>	100SC,Multi.	<input type="text"/>	100M-Full	Disable	MDI

Activate

**Enable**

Setting	Description	Factory Default
Checked	Allows data transmission through the port.	Enabled
Unchecked	Immediately shuts off port access.	



**ATTENTION**

If a connected device or sub-network is wreaking havoc on the rest of the network, the **Disable** option under **Advanced Settings/Port** gives the administrator a quick way to shut off access through this port immediately.

**Description**

Setting	Description	Factory Default
Media type	Displays the media type for each module's port	N/A

**Name**

Setting	Description	Factory Default
Max. 63 Characters	Specify an alias for each port and assist the administrator in remembering important information about the port. E.g., PLC 1	None

**Speed (Copper Port Only )**

Setting	Description	Factory Default
Auto	Allows the port to use the IEEE 802.3u protocol to negotiate with connected devices. The port and connected devices will determine the best speed for that connection.	Auto
100M-Full	Choose one of these fixed speed options if the opposing Ethernet device has trouble auto-negotiating line speed.	
100M-Half		
10M-Full		
10M-Half		

**FDX Flow Ctrl.**

This setting enables or disables the flow control capability of this port when the **port transmission speed** setting is in auto mode. The final result will be determined by the "auto" process between the NPort S8000 and connected devices.

Setting	Description	Factory Default
Enable	Enables flow control for this port when in auto-negotiate mode.	Disable
Disable	Disables flow control for this port when in auto-negotiate mode.	

**MDI/MDIX**

Setting	Description	Factory Default
Auto	Allows the port to auto detect the port type of the opposing Ethernet device and change the port type accordingly.	Auto
MDI	Choose the MDI or MDIX option if the opposing Ethernet device has trouble auto-negotiating port type.	
MDIX		

## Port Trunking

### Using Port Trunking

Link Aggregation allows one or more links to be aggregated together to form a Link Aggregation Group. A MAC client can treat Link Aggregation Groups as if they were a single link.

NPort S8000's Port Trunking feature allows devices to communicate by aggregating up to two trunk groups on the NPort S8000. If one of the ports fails, the other ports in the same trunk group will provide back up and share the traffic automatically.

### The Port Trunking Concept

Moxa has developed a proprietary Port Trunking protocol that provides the following benefits:

- Gives you more flexibility in setting up your network connections, since the bandwidth of a link can be doubled, tripled, or quadrupled.
- Provides redundancy—if one link is broken, the remaining trunked ports share the traffic within this trunk group.
- Load sharing—MAC Client traffic may be distributed across multiple links.
- To avoid broadcast storms or loops in your network while configuring a trunk, first disable or disconnect all ports that you want to add to the trunk or remove from the trunk. After you finish configuring the trunk, enable or re-connect the ports.

If all ports on both switches are configured as 100BASE-TX and they are operating in full duplex, the potential bandwidth of the connection will be up to 1 Gbps on an NPort S8000- switching device server. This means that users can connect one NPort S8000 to another NPort S8000 by port trunking to double, triple, or quadruple the bandwidth of the connection.

When configuring Port Trunking, note that:

Each NPort S8000 can set a maximum of two Port Trunking groups (designated Trk1, Trk2).

When you activate Port Trunking settings, some advanced functions that you setup with the original ports will either be set to factory default values, or disabled:

- Communication Redundancy will be set to the factory default
- Traffic Prioritization will be set to the factory default
- Port-based VLAN or 802.1Q VLAN will be set to the factory default
- Multicast Filtering will be set to the factory default
- Rate Limiting will be set to the factory default
- Port Access Control will be set to the factory default
- Email and Relay Warning will be set to the factory default
- Set Device IP will be set to the factory default
- Mirror Port will be set to the factory default
- You can setup these features again on your Trunking Port.



The **Port Trunking Settings** page is used to assign ports to a Trunk Group.

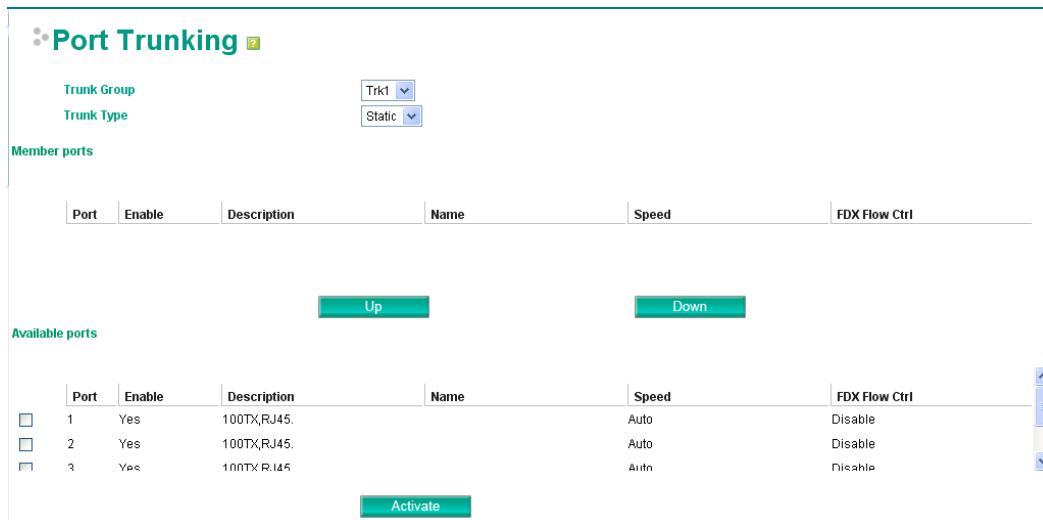

1. Select Trk1, Trk2 from the Trunk Group drop-down box.
2. Select Static, or LACP from the Trunk Type drop-down box.
3. Under Member Ports and Available Ports, select the specific ports.
4. Use the Up / Down buttons to add/remove designated ports to/from a trunk group.

**Trunk Group (Maximum of 2 trunk groups on NPort S8000)**

Setting	Description	Factory Default
Trk1, Trk2 on NPort S8000	Display or designate the Trunk Type and Member Ports for Trunk Groups 1, 2	Trk1

**Trunk Type**

Setting	Description	Factory Default
Static	Designated Moxa proprietary trunking protocol	Static
LACP	Designated LACP (IEEE 802.3ad, Link Aggregation Control Protocol)	Static

**Available Ports/Member Port**

Setting	Description	Factory Default
Member/Available Ports	Use Up/Down buttons to add/remove specific ports from available ports to/from trunk group.	N/A
Check box	Check to designate which ports to add or remove.	Unchecked
Port	Port number	N/A
Port description	Displays the media type for each module's port	N/A
Name	Max. 63 Characters	N/A
Speed	Indicates the transmission speed (100M-Full, 100M-Half, 10M-Full, or 10M-Half)	N/A
FDX Flow Control	Indicates if the FDX flow control of this port is "Enabled" or "Disabled."	N/A
Up	Add designated ports into trunk group from available ports.	N/A
Down	Remove designated ports from trunk group to available port.	N/A

# Communication Redundancy

## Using Communication Redundancy

Setting up Communication Redundancy on your network helps protect critical links against failure, protects against network loops, and keeps network downtime at a minimum.

The Communication Redundancy function allows the user to set up *redundant loops* in the network to provide a backup data transmission route in the event that a cable is inadvertently disconnected or damaged. This feature is particularly important for industrial applications, since it could take several minutes to locate the disconnected or severed cable. For example, if the NPort S8000 is used as a key communications component of a production line, several minutes of downtime could result in a big loss in production and revenue. The NPort S8000 supports three different protocols to support this communication redundancy function— **Rapid Spanning Tree/ Spanning Tree Protocol (IEEE 802.1W/1D)**, **Turbo Ring**, and **Turbo Ring V2**.

When configuring a redundant ring, all NPort S8000s on the same ring must be configured to use the same redundancy protocol. You cannot mix the “Turbo Ring,” “Turbo Ring V2,” and RSTP protocols on the same ring. The following table lists the key differences between each feature. Use this information to evaluate the benefits of each, and then determine which features are most suitable for your network.

	Turbo Ring V2	Turbo Ring	RSTP
Topology	Ring	Ring	Ring, Mesh
Recovery Time	< 20 ms	< 300 ms	Up to 5 sec

**NOTE** Most of Moxa’s managed switches now support two proprietary Turbo Ring protocols: “Turbo Ring” refers to the original version of Moxa’s proprietary redundant ring protocol, which has a recovery time of under 300 ms. “Turbo Ring V2” refers to the new generation Turbo Ring, which has a recovery time of under 20 ms. In this manual, we use the terminology “Turbo Ring” ring and “Turbo Ring V2” ring to differentiate between rings configured for one or the other of these protocols.

## The Turbo Ring Concept

Moxa developed the proprietary Turbo Ring protocol to optimize communication redundancy and achieve a faster recovery time on the network.

The Turbo Ring and Turbo Ring V2 protocols identify one NPort S8000 as the **master** of the network, and then automatically block packets from traveling through any of the network’s redundant loops. In the event that one branch of the ring gets disconnected from the rest of the network, the protocol automatically readjusts the ring so that the part of the network that was disconnected can reestablish contact with the rest of the network.

### Initial setup of a “Turbo Ring” or “Turbo Ring V2” ring

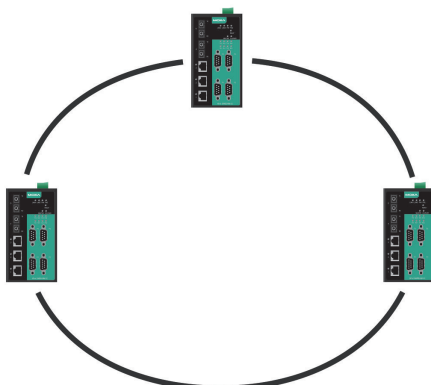

1. For each NPort S8000 in the ring, select any two ports as the redundant ports.
2. Connect redundant ports on neighboring NPort S8000 or switches to form the redundant ring.

The user does not need to configure any of the NPort S8000 or switches as the master to use Turbo Ring or Turbo Ring V2. If none of the NPort S8000 switches in the ring is configured as the master, then the protocol will automatically assign master status to one of the switches. In fact, the master is only used to identify which segment in the redundant ring acts as the backup path. In the following subsections, we explain how the redundant path is selected for rings configured for Turbo Ring and Turbo Ring V2.

### Determining the Redundant Path of a “Turbo Ring” Ring

In this case, the redundant segment (i.e., the segment that will be blocked during normal operation) is determined by the number of NPort S8000 that make up the ring, and where the ring master is located.

#### “Turbo Ring” rings with an even number of NPort S8000

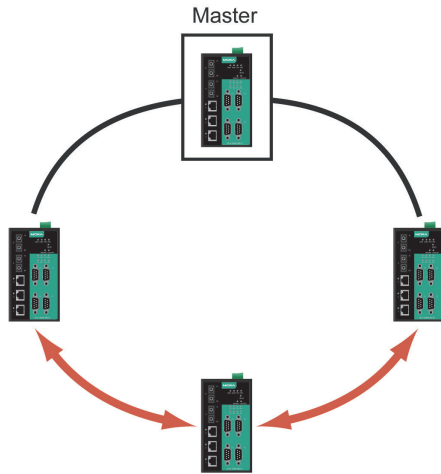

If there are  $2N$  NPort S8000 (an even number) in the “Turbo Ring” ring, then the backup segment is one of the two segments connected to the  $(N+1)$ st NPort S8000 (i.e., the NPort S8000 unit directly opposite the master).

#### “Turbo Ring” rings with an odd number of NPort S8000

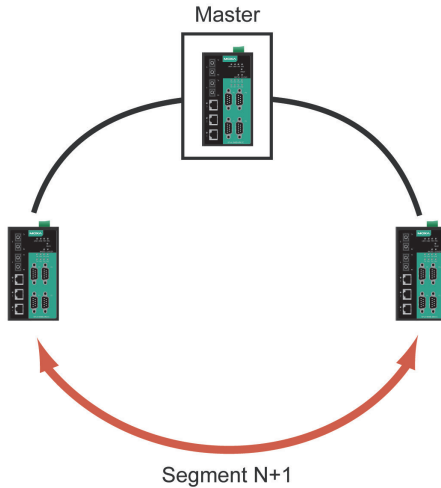

If there are  $2N+1$  NPort S8000 (an odd number) in the “Turbo Ring” ring, with NPort S8000 and segments labeled counterclockwise, then segment  $N+1$  will serve as the backup path.

For the example shown here,  $N=1$ , so that  $N+1=2$ .

### Determining the Redundant Path of a "Turbo Ring V2" Ring

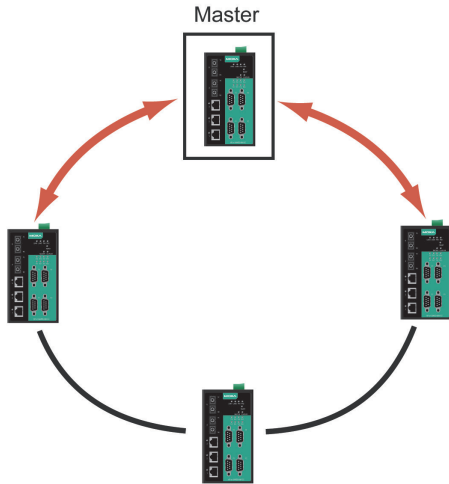

For a "Turbo Ring V2" ring, the backup segment is the segment connected to the second redundant port on the master.

See Configuring "Turbo Ring V2" in the Configuring "Turbo Ring" and "Turbo Ring V2" section below.

### Ring Coupling Configuration

For some systems, it may not be convenient to connect all devices in the system to create one BIG redundant ring, since some devices could be located in a remote area. For these systems, "Ring Coupling" can be used to separate the devices into different smaller redundant rings, but in such a way that they can still communicate with each other.



#### ATTENTION

In a VLAN environment, the user must set "Redundant Port," "Coupling Port," and "Coupling Control Port" to join all VLANs, since these ports act as the "backbone" to transmit all packets of different VLANs to different NPort S8000.

### Ring Coupling for a "Turbo Ring" Ring

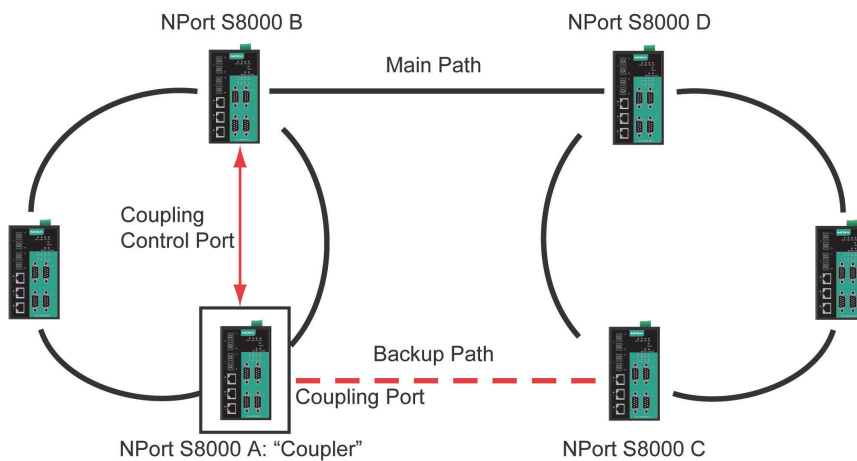

To configure the Ring Coupling function for a "Turbo Ring" ring, select two NPort S8000 (e.g., Switch A and B in the above figure) in the ring, and another two NPort S8000 in the adjacent ring (e.g., Switch C and D).

Decide which two ports in each switch are appropriate to be used as coupling ports, and then link them together. Next, assign one switch (e.g., Switch A) to be the "coupler," and connect the coupler's coupling control port with Switch B (for this example).

The coupler switch (i.e., Switch A) will monitor switch B through the coupling control port to determine whether or not the coupling port's backup path should be recovered.

### Ring Coupling for a "Turbo Ring V2" Ring

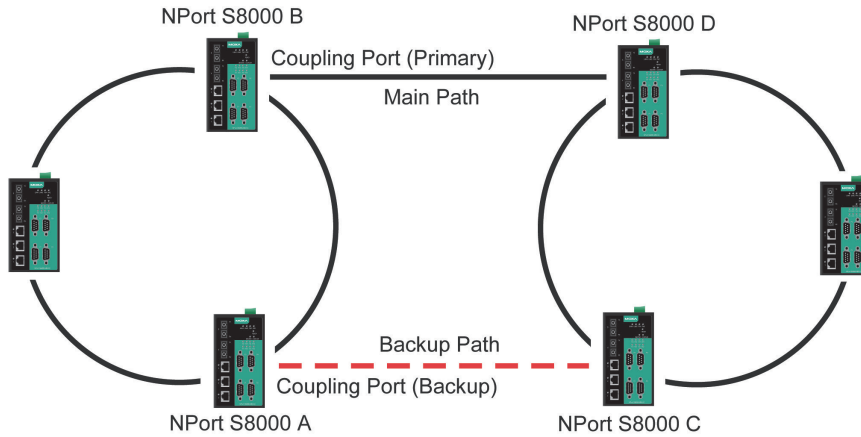

Note that the ring coupling settings for a "Turbo Ring V2" ring are different from a "Turbo Ring" ring. For Turbo Ring V2, Ring Coupling is enabled by configuring the "Coupling Port (Primary)" on Switch B, and the "Coupling Port (Backup)" on Switch A only. You do not need to set up a coupling control port, so that a "Turbo Ring V2" ring does not use a coupling control line.

The "Coupling Port (Backup)" on Switch A is used for the backup path, and connects directly to an extra network port on Switch C. The "Coupling Port (Primary)" on Switch B monitors the status of the main path, and connects directly to an extra network port on Switch D. With ring coupling established, Switch A can activate the backup path as soon as it detects a problem with the main path.



**ATTENTION** Ring Coupling only needs to be enabled on one of the switches serving as the Ring Coupler. The Coupler must designate different ports as the two Turbo Ring ports and the coupling port.

**NOTE** You do not need to use the same NPort S8000 unit for both Ring Coupling and Ring Master.

### Dual-Ring Configuration (applies only to "Turbo Ring V2")

The "dual-ring" option provides another ring coupling configuration, in which two adjacent rings share one switch. This type of configuration is ideal for applications that have inherent cabling difficulties.

#### Dual-Ring for a "Turbo Ring V2" Ring

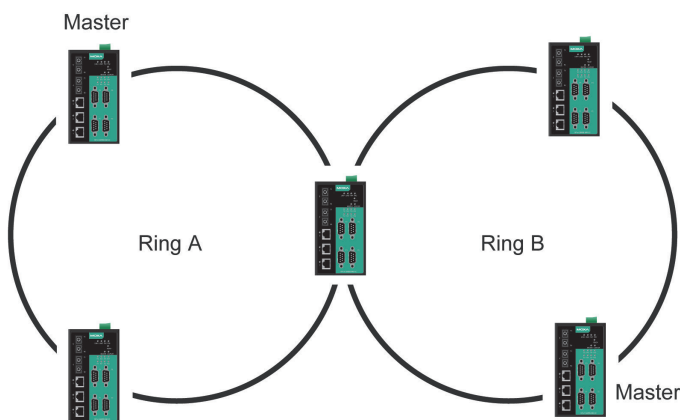

### Dual-Homing Configuration (applies only to "Turbo Ring V2")

The "dual-homing" option uses a single Ethernet switch to connect two networks. The primary path is the operating connection, and the backup path is a backup connection that is activated in the event that the primary path connection fails.

#### Dual-Homing for a "Turbo Ring V2" Ring

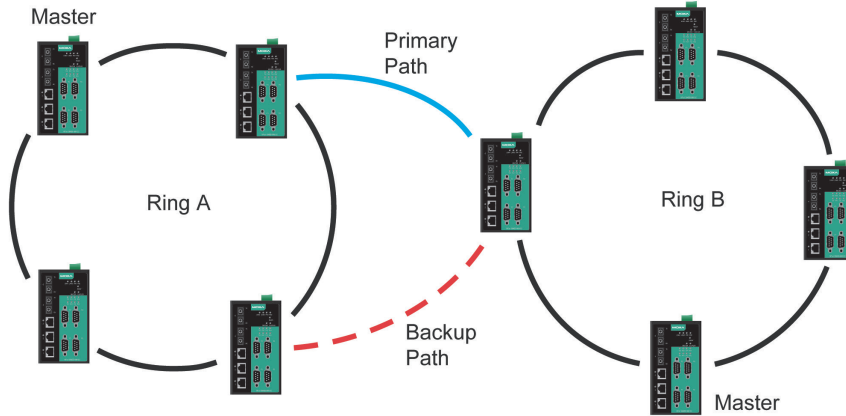

### Configuring "Turbo Ring" and "Turbo Ring V2"

Use the **Communication Redundancy** page to configure select "Turbo Ring" or "Turbo Ring V2." Note that configuration pages for these two protocols are different.

#### Configuring "Turbo Ring"

Total Solution for NPort S8000 Series Device Server

<b>Model</b>	- NPort S8455H-MM-SC	<b>IP</b>	- 192.168.127.254
<b>Name</b>	- NPort S8455H-MM-SC_22112	<b>Serial NO.</b>	- 22112
<b>Location</b>			

**- Main Menu**

- Overview
- Basic Settings
- Serial Settings
- Ethernet Settings
  - Port Settings
  - Port Trunking
- Communication Redundancy
- Bandwidth Management
- Line-Swap Fast Recovery
- Ethernet Advanced Settings
- System Management
- System Monitoring
- Restart

### Communication Redundancy ?

**Settings**

**Redundancy protocol** Turbo Ring v

**Set as Master**

**Redundant ports**

1st ports 4 v

2st ports 5 v

**Enable ring coupling**

**Coupling port** 2 v

**Coupling control port** 3 v

Activate

**NOTE** The user does not need to set the master to use Turbo Ring. If no master is set, the Turbo Ring protocol will assign master status to one of the NPort S8000 in the ring. The master is only used to determine which segment serves as the backup path.

**Redundancy Protocol**

Setting	Description	Factory Default
Turbo Ring	Select this item to change to the Turbo Ring configuration page.	Turbo Ring V2
Turbo Ring V2	Select this item to change to the Turbo Ring V2 configuration page.	
RSTP (IEEE 802.1W/1D)	Select this item to change to the RSTP configuration page.	

**Set as Master**

Setting	Description	Factory Default
Enabled	Select this NPort S8000 as Master	Not checked
Disabled	Do not select this NPort S8000 as Master	

**Redundant Ports**

Setting	Description	Factory Default
1st Port	Select any port of the NPort S8000 to be one of the redundant ports.	Port 4
2nd Port	Select any port of the NPort S8000 to be one of the redundant ports.	Port 5

**Enable Ring Coupling**

Setting	Description	Factory Default
Enable	Select this NPort S8000 as Coupler	Not checked
Disable	Do not select this NPort S8000 as Coupler	

**Coupling Port**

Setting	Description	Factory Default
Coupling Port	Select any port of the NPort S8000 to be the coupling port	port 2

**Coupling Control Port**

Setting	Description	Factory Default
Coupling Control Port	Select any port of the NPort S8000 to be the coupling control port	port 3

**Configuring “Turbo Ring V2”**

The screenshot shows the Moxa web interface for an NPort S8000 Series Device Server. At the top, the status bar displays: Model: NPort S8455H-MM-SC, Name: NPort S8455H-MM-SC\_22112, Location: -, IP: 192.168.127.254, and Serial NO.: 22112. The main menu on the left lists various configuration options, with 'Communication Redundancy' selected. The central panel is titled 'Communication Redundancy' and contains the following settings:

- Redundancy protocol:** Turbo Ring V2 (dropdown menu)
- Enable ring 1:**
- Set as Master:**
- Redundant ports:** 1st port: 4, 2nd port: 5 (dropdown menus)
- Enable ring 2:**
- Set as Master:**
- Redundant ports:** 1st port: 2, 2nd port: 3 (dropdown menus)
- Enable ring coupling:**
- Coupling mode:** Dual Homing (dropdown menu)
- Primary Port:** 2 (dropdown menu)
- Backup Port:** 3 (dropdown menu)

An 'Activate' button is located at the bottom right of the settings area. A 'goahead WEB SERVER' logo is visible in the bottom left corner of the interface.

**NOTE** When using the Dual-Ring architecture, users must configure settings for both Ring 1 and Ring 2. In this case, the status of both rings will appear under "Current Status."

**NOTE** The user does not need to set the master to use Turbo Ring. If no master is set, the Turbo Ring protocol will assign master status to one of the NPort S8000 in the ring. The master is only used to determine which segment serves as the backup path.

### ***Redundancy Protocol***

<b>Setting</b>	<b>Description</b>	<b>Factory Default</b>
Turbo Ring	Select this item to change to the Turbo Ring configuration page.	RSTP
Turbo Ring V2	Select this item to change to the Turbo Ring V2 configuration page.	
RSTP (IEEE 802.1W/1D)	Select this item to change to the RSTP configuration page.	

### ***Enable Ring 1***

<b>Setting</b>	<b>Description</b>	<b>Factory Default</b>
Enabled	Enable the Ring 1 settings	Not checked
Disabled	Disable the Ring 1 settings	

### ***Enable Ring 2\****

<b>Setting</b>	<b>Description</b>	<b>Factory Default</b>
Enabled	Enable the Ring 2 settings	Not checked
Disabled	Disable the Ring 2 settings	

\*You should enable both Ring 1 and Ring 2 when using the Dual-Ring architecture.

### ***Set as Master***

<b>Setting</b>	<b>Description</b>	<b>Factory Default</b>
Enabled	Select this NPort S8000 as Master	Not checked
Disabled	Do not select this NPort S8000 as Master	

### ***Redundant Ports***

<b>Setting</b>	<b>Description</b>	<b>Factory Default</b>
1st Port	Select any port of the NPort S8000 to be one of the redundant ports.	Ring 1: port 4 Ring 2: port 5
2nd Port	Select any port of the NPort S8000 to be one of the redundant ports.	Ring 1: port 2 Ring 2: port 3

### ***Enable Ring Coupling***

<b>Setting</b>	<b>Description</b>	<b>Factory Default</b>
Enable	Select this NPort S8000 as Coupler	Not checked
Disable	Do not select this NPort S8000 as Coupler	

### ***Coupling Mode***

<b>Setting</b>	<b>Description</b>	<b>Factory Default</b>
Dual Homing	Select this item to change to the Dual Homing configuration page	Primary Port: port 2 Backup Port: port 3
Ring Coupling (backup)	Select this item to change to the Ring Coupling (backup) configuration page	Coupling Port : Port 2
Ring Coupling (primary)	Select this item to change to the Ring Coupling (primary) configuration page	Coupling Port : Port 2



**Primary/Backup Port**

Setting	Description	Factory Default
Primary Port	Select any port of the NPort S8000 to be the primary port.	port 2
Backup Port	Select any port of the NPort S8000 to be the backup port.	port 3

## The Turbo Chain Concept

Moxa’s Turbo Chain is an advanced software technology that gives network administrators the flexibility of constructing any type of redundant network topology. When using the chain concept, you first connect the Ethernet switches in a chain and then simply link the two ends of the chain to an Ethernet network, as illustrated in the following figure.

Turbo Chain can be used on industrial networks that have a complex topology. If the industrial network uses a multi-ring architecture, Turbo Chain can be used to create flexible and scalable topologies with a fast media-recovery time.

### Setting up Turbo Chain

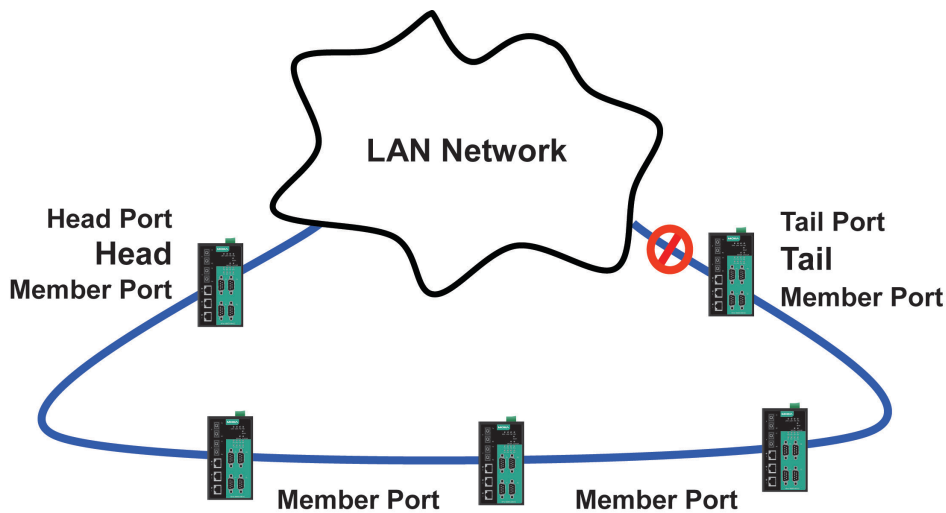

1. Select the Head, Tail, and Member switches.
2. Configure one port as the Head port and one port as the Member port in the Head switch, configure one port as the Tail port and one port as the Member port in the Tail switch, and configure two ports as Member ports in each of the Member switches.
3. Connect the Head, Tail, and Member switches as shown in the diagram.

The path connecting to the Head port is the main path, and the path connecting to the Tail port is the backup path of the Turbo Chain. Under normal conditions, packets are transmitted through the Head Port to the LAN Network. If any Turbo Chain path is disconnected, the Tail Port will be activated to continue packet transmission.

## Configuring “Turbo Chain”

### Head Switch Configuration

**Communication Redundancy**

**Current Status**  
Now Active **None**

**Settings**

Redundancy Protocol: Turbo Chain

Role: Head

Port Role	Port Num	Port Status
Head Port	7	---
Member Port	8	---

**Activate**

### Member Switch Configuration

**Communication Redundancy**

**Current Status**  
Now Active **None**

**Settings**

Redundancy Protocol: Turbo Chain

Role: Member

Port Role	Port Num	Port Status
1st Member Port	7	---
2nd Member Port	8	---

**Activate**

### Tail Switch Configuration

**Communication Redundancy**

**Current Status**  
Now Active **None**

**Settings**

Redundancy Protocol: Turbo Chain

Role: Tail

Port Role	Port Num	Port Status
Tail Port	7	---
Member Port	8	---

**Activate**

**Current Status*****Now Active***

Shows which communication protocol is in use: **Turbo Ring**, **Turbo Ring V2**, **RSTP**, **Turbo Chain** or **None**.

The "Ports Status" indicators show **Forwarding** for normal transmission, **Blocked** if this port is connected to the Tail port as a backup path and the path is blocked, and **Link down** if there is no connection.

**Settings*****Redundancy Protocol***

Setting	Description	Factory Default
Turbo Ring	Select this item to change to the Turbo Ring configuration page.	None
Turbo Ring V2	Select this item to change to the Turbo Ring V2 configuration page.	
Turbo Chain	Select this item to change to the Turbo Chain configuration page	
RSTP (IEEE 802.1W/1D)	Select this item to change to the RSTP configuration page.	
None	Ring redundancy is not active	

***Role***

Setting	Description	Factory Default
Head	Select this EDS as Head Switch	Member
Member	Select this EDS as Member Switch	
Tail	Select this EDS as Tail Switch	

***Head Role***

Setting	Description	Factory Default
Head Port	Select any port of the EDS to be the head port.	EDS-505A: port 4 EDS-508A: port 7
Member Port	Select any port of the EDS to be the member port.	EDS-505A: port 5 EDS-508A: port 8

***Member Role***

Setting	Description	Factory Default
1st Member port	Select any port of the EDS to be the 1st member port	EDS-505A: port 4 EDS-508A: port 7
2nd Member port	Select any port of the EDS to be the 2nd member port	EDS-505A: port 5 EDS-508A: port 8

***Tail Role***

Setting	Description	Factory Default
Tail Port	Select any port of the EDS to be the tail port.	EDS-505A: port 4 EDS-508A: port 7
Member Port	Select any port of the EDS to be the member port.	EDS-505A: port 5 EDS-508A: port 8

# STP/RSTP

## The STP/RSTP Concept

Spanning Tree Protocol (STP) was designed to help reduce link failures in a network and provide protection from loops. Networks that have a complicated architecture are prone to broadcast storms caused by unintended loops in the network. The NPort S8000's STP feature is disabled by default. To be completely effective, you must enable RSTP/STP on every NPort S8000 connected to your network.

Rapid Spanning Tree Protocol (RSTP) implements the Spanning Tree Algorithm and Protocol defined by IEEE Std 802.1w-2001. RSTP provides the following benefits:

- The topology of a bridged network will be determined much more quickly compared to STP.
- RSTP is backward compatible with STP, making it relatively easy to deploy. For example:
  - Defaults to sending 802.1D style BPDUs if packets with this format are received.
  - STP (802.1D) and RSTP (802.1w) can operate on different ports of the same NPort S8000. This feature is particularly helpful when the NPort S8000's ports connect to older equipment, such as legacy switches.

You get essentially the same functionality with RSTP and STP. To see how the two systems differ, see the *Differences between RSTP and STP* section in this chapter.

**NOTE** The STP protocol is part of the IEEE Std 802.1D, 1998 Edition bridge specification. The following explanation uses bridge instead of switch.

## What is STP?

STP (802.1D) is a bridge-based system that is used to implement parallel paths for network traffic. STP uses a loop-detection process to:

- Locate and then disable less efficient paths (i.e., paths that have a lower bandwidth).
- Enable one of the less efficient paths if the most efficient path fails.

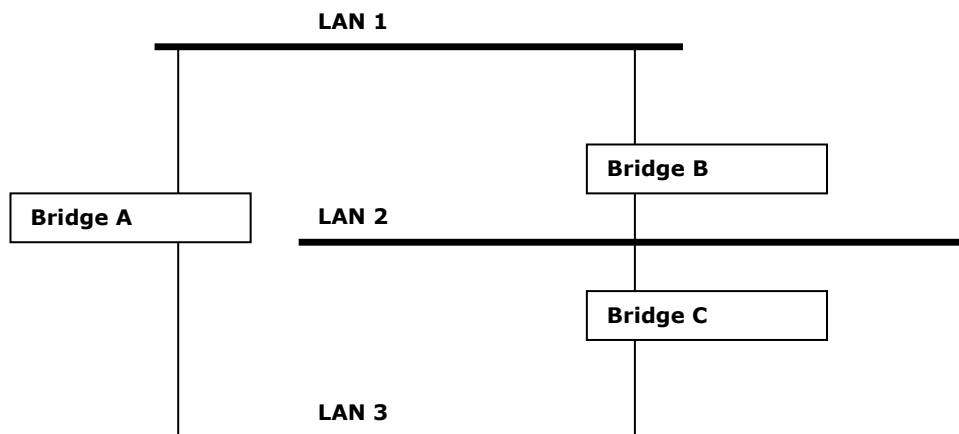

The figure below shows a network made up of three LANs separated by three bridges. Each segment uses at most two paths to communicate with the other segments. Since this configuration can give rise to loops, the network will overload if STP is NOT enabled.

If STP is enabled, it will detect duplicate paths and prevent, or *block*, one of them from forwarding traffic. In the following example, STP determined that traffic from LAN segment 2 to LAN segment 1 should flow through Bridges C and A because this path has a greater bandwidth and is therefore more efficient.

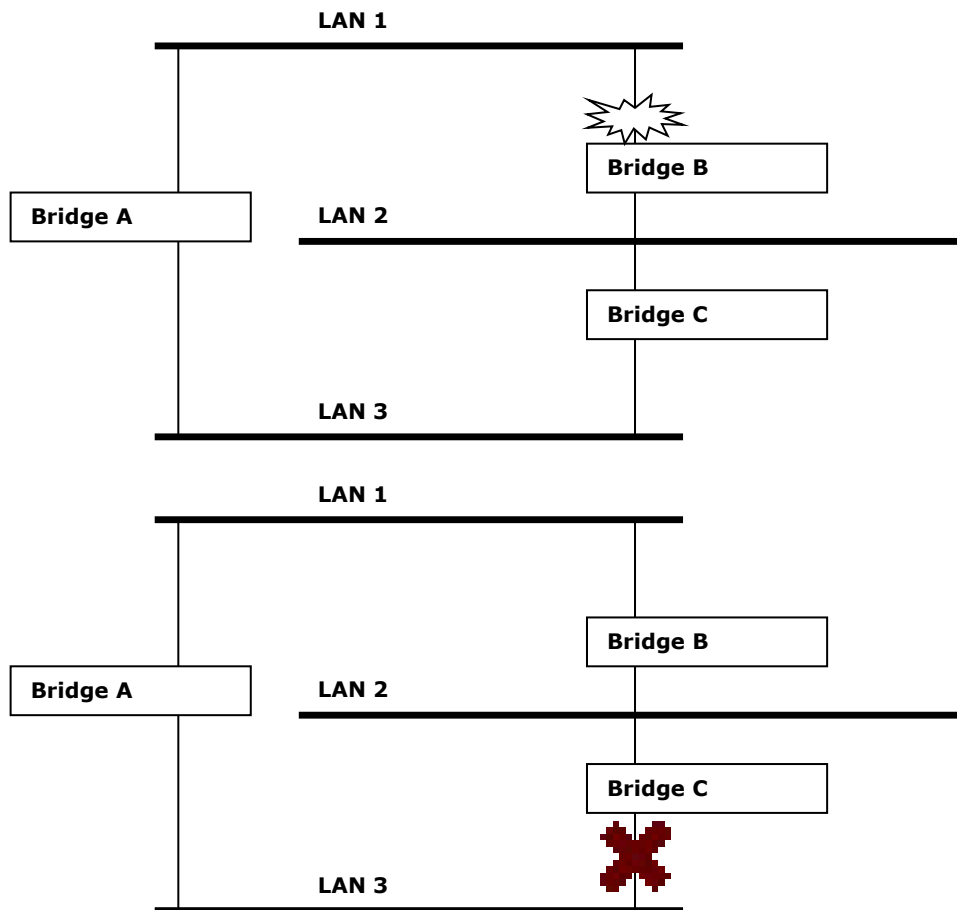

What happens if a link failure is detected? As shown in next figure, the STP process reconfigures the network so that traffic from LAN segment 2 flows through Bridge B.

STP will determine which path between each bridged segment is most efficient, and then assigns a specific reference point on the network. When the most efficient path has been identified, the other paths are blocked. In the previous three figures, STP first determined that the path through Bridge C was the most efficient, and as a result, blocked the path through Bridge B. After the failure of Bridge C, STP re-evaluated the situation and opened the path through Bridge B.

## How STP Works

When enabled, STP determines the most appropriate path for traffic through a network. The way it does this is outlined in the sections below.

### STP Requirements

Before STP can configure the network, the system must satisfy the following requirements:

- Communication between all the bridges. This communication is carried out using Bridge Protocol Data Units (BPDUs), which are transmitted in packets with a known multicast address.
- Each bridge must have a Bridge Identifier that specifies which bridge acts as the central reference point, or Root Bridge, for the STP system—bridges with a lower Bridge Identifier are more likely to be designated as the Root Bridge. The Bridge Identifier is calculated using the MAC address of the bridge and a priority defined for the bridge. The default priority of the NPort S8000 is 32768.
- Each port has a cost that specifies the efficiency of each link. The efficiency cost is usually determined by the bandwidth of the link, with less efficient links assigned a higher cost. The following table shows the default port costs for a switch:

Port Speed	Path Cost 802.1D, 1998 Edition	Path Cost 802.1w, 2001
10 Mbps	100	2,000,000
100 Mbps	19	200,000
1000 Mbps	4	20,000

## STP Calculation

The first step of the STP process is to perform calculations. During this stage, each bridge on the network transmits BPDUs. The following items will be calculated:

- Which bridge should be the Root Bridge. The Root Bridge is the central reference point from which the network is configured.
- The Root Path Costs for each bridge. This is the cost of the paths from each bridge to the Root Bridge.
- The identity of each bridge's Root Port. The Root Port is the port on the bridge that connects to the Root Bridge via the most efficient path. In other words, the port connected to the Root Bridge via the path with the lowest Root Path Cost. The Root Bridge, however, does not have a Root Port.
- The identity of the Designated Bridge for each LAN segment. The Designated Bridge is the bridge with the lowest Root Path Cost from that segment. If several bridges have the same Root Path Cost, the one with the lowest Bridge Identifier becomes the Designated Bridge. Traffic transmitted in the direction of the Root Bridge will flow through the Designated Bridge. The port on this bridge that connects to the segment is called the Designated Bridge Port.

## STP Configuration

After all the bridges on the network agree on the identity of the Root Bridge, and all other relevant parameters have been established, each bridge is configured to forward traffic only between its Root Port and the Designated Bridge Ports for the respective network segments. All other ports are blocked, which means that they will not be allowed to receive or forward traffic.

## STP Reconfiguration

Once the network topology has stabilized, each bridge listens for Hello BPDUs transmitted from the Root Bridge at regular intervals. If a bridge does not receive a Hello BPDU after a certain interval (the Max Age time), the bridge assumes that the Root Bridge, or a link between itself and the Root Bridge, has gone down. This will trigger the bridge to reconfigure the network to account for the change. If you have configured an SNMP trap destination, when the topology of your network changes, the first bridge to detect the change sends out an SNMP trap.

## Differences between RSTP and STP

RSTP is similar to STP, but includes additional information in the BPDUs that allow each bridge to confirm that it has taken action to prevent loops from forming when it decides to enable a link to a neighboring bridge. Adjacent bridges connected via point-to-point links will be able to enable a link without waiting to ensure that all other bridges in the network have had time to react to the change. The main benefit of RSTP is that the configuration decision is made locally rather than network-wide, allowing RSTP to carry out automatic configuration and restore a link faster than STP.

## STP Example

The LAN shown in the following figure has three segments, with adjacent segments connected using two possible links. The various STP factors, such as Cost, Root Port, Designated Bridge Port, and Blocked Port are shown in the figure.

- Bridge A has been selected as the Root Bridge since it was determined to have the lowest Bridge Identifier on the network.
- Since Bridge A is the Root Bridge, it is also the Designated Bridge for LAN segment 1. Port 1 on Bridge A is selected as the Designated Bridge Port for LAN Segment 1.
- Ports 1 of Bridges B, C, X, and Y are all Root Ports since they are nearest to the Root Bridge, and therefore have the most efficient path.
- Bridges B and X offer the same Root Path Cost for LAN segment 2. However, Bridge B was selected as the Designated Bridge for that segment since it has a lower Bridge Identifier. Port 2 on Bridge B is selected as the Designated Bridge Port for LAN Segment 2.
- Bridge C is the Designated Bridge for LAN segment 3, because it has the lowest Root Path Cost for LAN Segment 3:
  - The route through Bridges C and B costs 200 (C to B=100, B to A=100)
  - The route through Bridges Y and B costs 300 (Y to B=200, B to A=100)
- The Designated Bridge Port for LAN Segment 3 is Port 2 on Bridge C.

## Using STP on a Network with Multiple VLANs

IEEE Std 802.1D, 1998 Edition, does not take into account VLANs when calculating STP information—the calculations only depend on the physical connections. Consequently, some network configurations will result in VLANs being subdivided into a number of isolated sections by the STP system. You must ensure that every VLAN configuration on your network takes into account the expected STP topology and alternative topologies that may result from link failures.

The following figure shows an example of a network that contains VLANs 1 and 2. The VLANs are connected using the 802.1Q-tagged link between Switch B and Switch C. By default, this link has a port cost of 100 and is automatically blocked because the other Switch-to-Switch connections have a port cost of 36 (18+18). This means that both VLANs are now subdivided—VLAN 1 on Switch units A and B cannot communicate with VLAN 1 on Switch C, and VLAN 2 on Switch units A and C cannot communicate with VLAN 2 on Switch B.

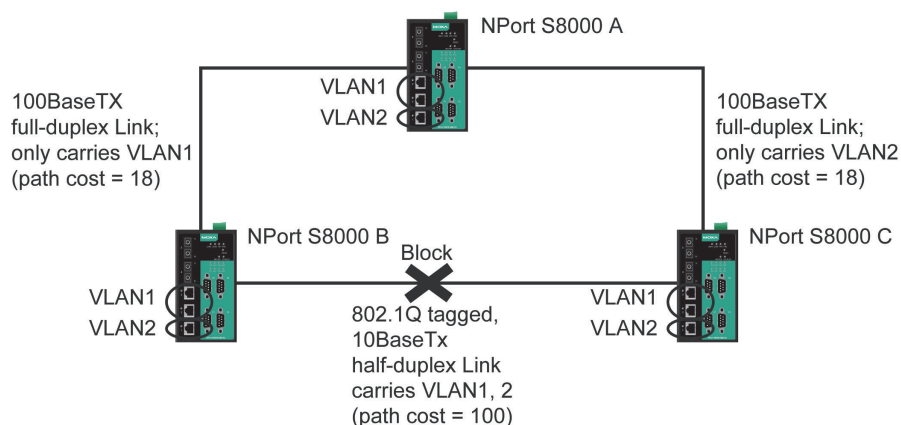

To avoid subdividing VLANs, all inter-switch connections should be made members of all available 802.1Q VLANs. This will ensure connectivity at all times. For example, the connections between Switches A and B, and between Switches A and C should be 802.1Q tagged and carrying VLANs 1 and 2 to ensure connectivity.

See the “Configuring Virtual LANs” section for more information about VLAN Tagging.

# Configuring STP/RSTP

The following figures indicate which Spanning Tree Protocol parameters can be configured. A more detailed explanation of each parameter follows.

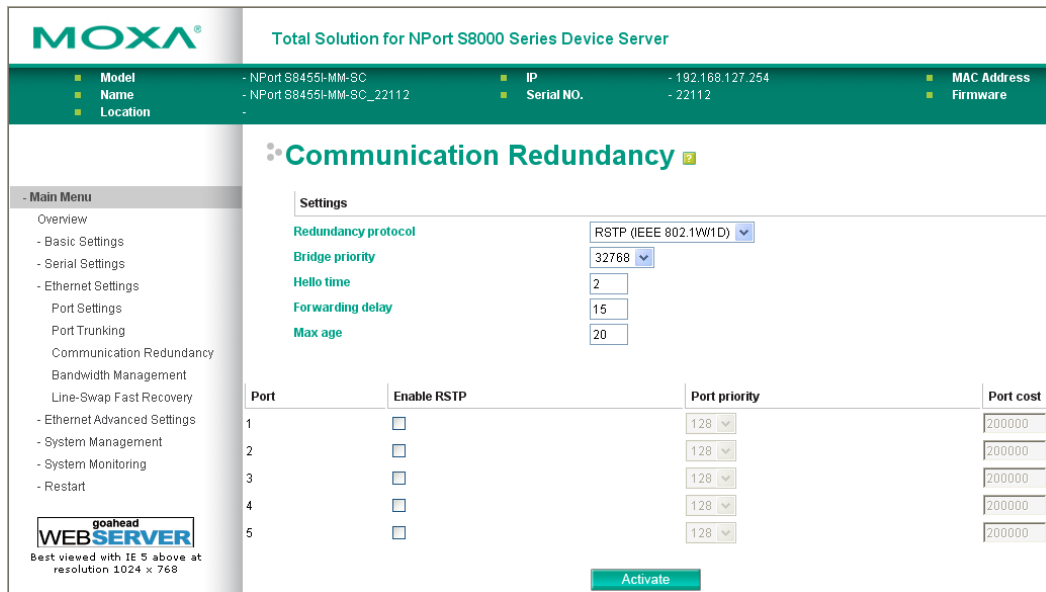

### Redundancy Protocol

Setting	Description	Factory Default
Turbo Ring	Select this item to change to the Turbo Ring configuration page.	
Turbo Ring 2	Select this item to change to the Turbo Ring 2 configuration page.	
RSTP (IEEE 802.1W/1D)	Select this item to change to the RSTP configuration page.	default

### Bridge priority

Setting	Description	Factory Default
Numerical value selected by user	Increase this device’s bridge priority by selecting a lower number. A device with a higher bridge priority has a greater chance of being established as the root of the Spanning Tree topology.	32768

### Hello time (sec.)

Setting	Description	Factory Default
Numerical value input by user	The root of the Spanning Tree topology periodically sends out a “hello” message to other devices on the network to check if the topology is healthy. The “hello time” is the amount of time the root waits between sending hello messages.	2

### Forwarding Delay

Setting	Description	Factory Default
Numerical value input by user	The amount of time this device waits before checking to see if it should change to a different state.	15 (sec.)



**Max. Age (sec.)**

Setting	Description	Factory Default
Numerical value input by user	If this device is not the root, and it has not received a hello message from the root in an amount of time equal to "Max. Age," then this device will reconfigure itself as a root. Once two or more devices on the network are recognized as a root, the devices will renegotiate to set up a new Spanning Tree topology.	20

**Enable RSTP per Port**

Setting	Description	Factory Default
Enable/Disable	Select to enable the port as a node on the Spanning Tree topology.	Disabled

**NOTE** We suggest not enabling the Spanning Tree Protocol once the port is connected to a device (PLC, RTU, etc.) as opposed to network equipment. The reason is that it will cause unnecessary negotiation.

**Port Priority**

Setting	Description	Factory Default
Numerical value selected by user	Increase this port's priority as a node on the Spanning Tree topology by entering a lower number.	128

**Port Cost**

Setting	Description	Factory Default
Numerical value input by user	Input a higher cost to indicate that this port is less suitable as a node for the Spanning Tree topology.	200000

## Configuration Limits of STP/RSTP

The Spanning Tree Algorithm places limits on three of the configuration items described previously:

$$[\text{Eq. 1}]: 1 \text{ sec} \leq \text{Hello Time} \leq 10 \text{ sec}$$

$$[\text{Eq. 2}]: 6 \text{ sec} \leq \text{Max. Age} \leq 40 \text{ sec}$$

$$[\text{Eq. 3}]: 4 \text{ sec} \leq \text{Forwarding Delay} \leq 30 \text{ sec}$$

These three variables are further restricted by the following two inequalities:

$$[\text{Eq. 4}]: 2 * (\text{Hello Time} + 1 \text{ sec}) \leq \text{Max. Age} \leq 2 * (\text{Forwarding Delay} - 1 \text{ sec})$$

The NPort S8000's firmware will alert you immediately if any of these restrictions are violated. For example, setting

Hello Time = 5 sec, Max. Age = 20 sec, and Forwarding Delay = 4 sec does not violate Eqs. 1 through 3, but does violate Eq. 4, since in this case,

$$2 * (\text{Hello Time} + 1 \text{ sec}) = 12 \text{ sec}, \text{ and } 2 * (\text{Forwarding Delay} - 1 \text{ sec}) = 6 \text{ sec}.$$

You can remedy the situation in many ways. One solution is simply to increase the Forwarding Delay value to at least 11 sec.

*HINT:* Perform the following steps to avoid guessing:

**Step 1:** Assign a value to "Hello Time" and then calculate the left most part of Eq. 4 to get the lower limit of "Max. Age".

**Step 2:** Assign a value to "Forwarding Delay" and then calculate the right most part of Eq. 4 to get the upper limit for "Max. Age".

**Step 3:** Assign a value to "Forwarding Delay" that satisfies the conditions in Eq. 3 and Eq. 4.

# Bandwidth Management

## Using Bandwidth Management

In general, one host should not be allowed to occupy unlimited bandwidth, particularly when the device malfunctions. For example, so-called "broadcast storms" could be caused by an incorrectly configured topology, or a malfunctioning device. The NPort S8000 not only prevents broadcast storms, but can also be configured to a different ingress rate for all packets, giving administrators full control of their limited bandwidth to prevent undesirable effects caused by unpredictable faults.

## Configuring Bandwidth Management

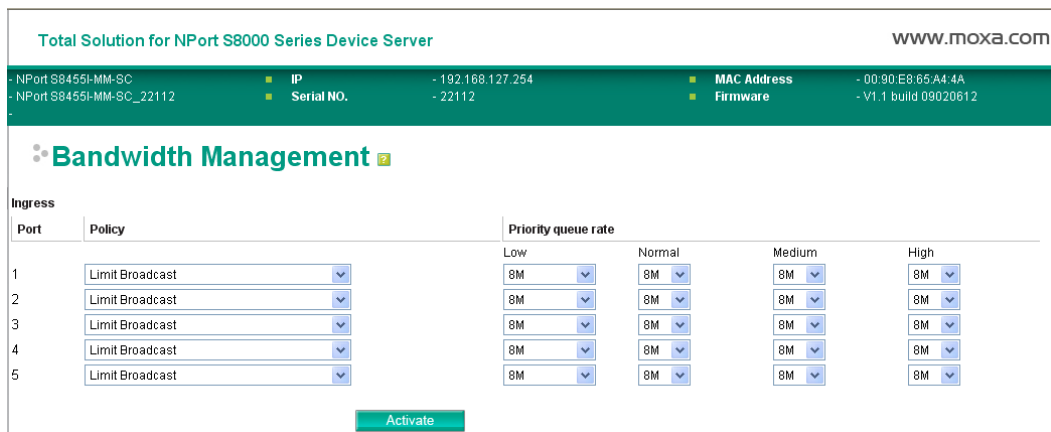

## Traffic Rate Limiting Settings

### Ingress

Setting	Description	Factory Default
Ingress rate	Select the ingress rate for all packets from the following options: not limited, 128K, 256K, 512K, 1M, 2M, 4M, 8M	N/A

# Line Swap Fast Recovery

## Using Line-Swap-Fast-Recovery

The Line-Swap Fast Recovery function, which is enabled by default, allows the NPort S8000 to return to normal operation extremely quickly after devices are unplugged and then re-plugged into different ports. The recovery time is on the order of a few milliseconds (compare this with standard commercial switches for which the recovery time could be on the order of several minutes).

## Configuring Line-Swap Fast Recovery

To disable the Line-Swap Fast Recovery function, or to re-enable the function after it has already been disabled, access either the Console utility’s **Line-Swap recovery** page, or the Web Browser interface’s **Line-Swap fast recovery** page, as the following figure shows:

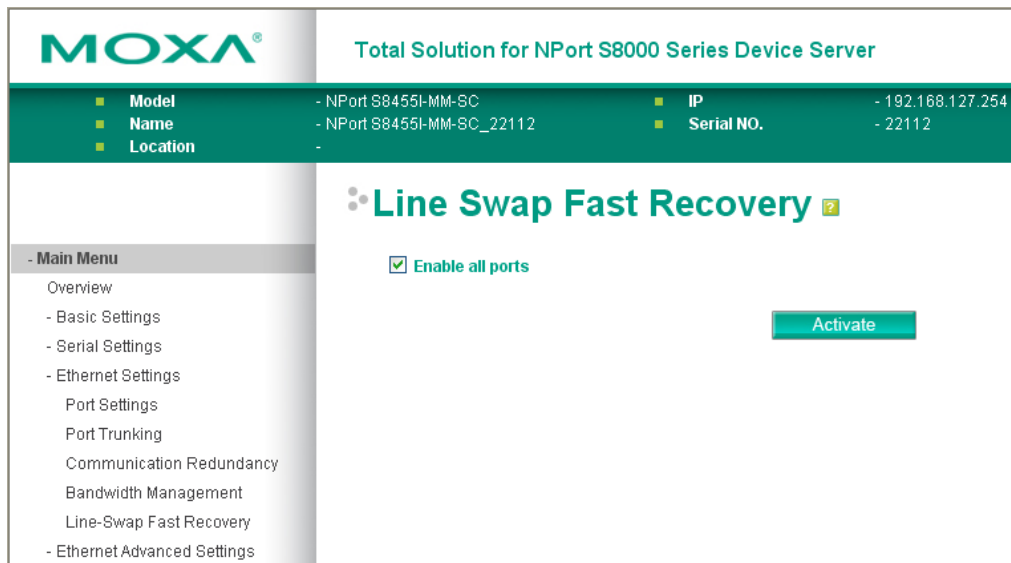

### Enable Line-Swap-Fast-Recovery

Setting	Description	Factory Default
Enable/Disable	Select this option to enable the Line-Swap-Fast-Recovery function	Enable

## Ethernet Advanced Settings

### Ethernet Traffic Prioritization

#### Using Traffic Prioritization

The NPort S8000’s traffic prioritization capability provides Quality of Service (QoS) to your network by making data delivery more reliable. You can prioritize traffic on your network to ensure that high priority data is transmitted with minimum delay. Traffic can be controlled by a set of rules to obtain the required Quality of Service for your network. The rules define different types of traffic and specify how each type should be treated as it passes through the switch. The NPort S8000 can inspect both IEEE 802.1p/1Q layer 2 CoS tags, and even layer 3 TOS information to provide consistent classification of the entire network. The NPort S8000’s QoS capability improves the performance and determinism of industrial networks for mission-critical applications.

# The Traffic Prioritization Concept

## What is Traffic Prioritization?

Traffic prioritization allows you to prioritize data so that time-sensitive and system-critical data can be transferred smoothly and with minimal delay over a network. The benefits of using traffic prioritization are:

- Improve network performance by controlling a wide variety of traffic and managing congestion.
- Assign priorities to different categories of traffic. For example, set higher priorities for time-critical or business-critical applications.
- Provide predictable throughput for multimedia applications, such as video conferencing or voice over IP, and minimize traffic delay and jitter.
- Improve network performance as the amount of traffic grows. This will save cost by reducing the need to keep adding bandwidth to the network.

## How Traffic Prioritization Works

Traffic prioritization uses the four traffic queues that are present in your NPort S8000 to ensure that high-priority traffic is forwarded on a different queue from lower priority traffic. This is what provides Quality of Service (QoS) to your network.

NPort S8000 traffic prioritization depends on two industry-standard methods:

- IEEE 802.1D—a layer 2 marking scheme.
- Differentiated Services (DiffServ)—a layer 3 marking scheme.

### IEEE 802.1D Traffic Marking

The IEEE Std 802.1D, 1998 Edition marking scheme, which is an enhancement to IEEE Std 802.1D, enables Quality of Service on the LAN. Traffic service levels are defined in the IEEE 802.1Q 4-byte tag, which is used to carry VLAN identification as well as IEEE 802.1p priority information. The 4-byte tag immediately follows the destination MAC address and Source MAC address.

The IEEE Std 802.1D, 1998 Edition priority marking scheme assigns an IEEE 802.1p priority level between 0 and 7 to each frame. This determines the level of service that that type of traffic should receive. Refer to the table below for an example of how different traffic types can be mapped to the eight IEEE 802.1p priority levels.

IEEE 802.1p Priority Level	IEEE 802.1D Traffic Type
0	Best Effort (default)
1	Background
2	Standard (spare)
3	Excellent Effort (business critical)
4	Controlled Load (streaming multimedia)
5	Video (interactive media); less than 100 milliseconds of latency and jitter
6	Voice (interactive voice); less than 10 milliseconds of latency and jitter
7	Network Control Reserved traffic

Even though the IEEE 802.1D standard is the most widely used prioritization scheme in the LAN environment, it still has some restrictions:

- It requires an additional 4-byte tag in the frame, which is normally optional in Ethernet networks. Without this tag, the scheme cannot work.
- The tag is part of the IEEE 802.1Q header, so to implement QoS at layer 2, the entire network must implement IEEE 802.1Q VLAN tagging.

It is only supported on a LAN and not routed across WAN links, since the IEEE 802.1Q tags are removed when the packets pass through a router.

## Differentiated Services (DiffServ) Traffic Marking

DiffServ is a Layer 3 marking scheme that uses the DiffServ Code Point (DSCP) field in the IP header to store the packet priority information. DSCP is an advanced intelligent method of traffic marking as you can choose how your network prioritizes different types of traffic. DSCP uses 64 values that map to user-defined service levels, allowing you to establish more control over network traffic.

Advantages of DiffServ over IEEE 802.1D are:

- Configure how you want your switch to treat selected applications and types of traffic by assigning various grades of network service to them.
- No extra tags are required in the packet.
- DSCP uses the IP header of a packet and, therefore, priority is preserved across the Internet.
- DSCP is backward compatible with IPv4 TOS, which allows operation with existing devices that use a layer 3 TOS enabled prioritization scheme.

## Traffic Prioritization

The NPort S8000 classifies traffic based on layer 2 of the OSI 7 layer model, and the switch prioritizes received traffic according to the priority information defined in the received packet. Incoming traffic is classified based upon the IEEE 802.1D frame and is assigned to the appropriate priority queue based on the IEEE 802.1p service level value defined in that packet. Service level markings (values) are defined in the IEEE 802.1Q 4-byte tag, and consequently traffic will only contain 802.1p priority markings if the network is configured with VLANs and VLAN tagging. The traffic flow through the switch is as follows:

1. A packet received by the NPort S8000 may or may not have an 802.1p tag associated with it. If it does not, then it is given a default 802.1p tag (which is usually 0). Alternatively, the packet may be marked with a new 802.1p value, which will result in all knowledge of the old 802.1p tag being lost.
2. As the 802.1p priority levels are fixed to the traffic queues, the packet will be placed in the appropriate priority queue, ready for transmission through the appropriate egress port. When the packet reaches the head of its queue and is about to be transmitted, the device determines whether or not the egress port is tagged for that VLAN. If it is, then the new 802.1p tag is used in the extended 802.1D header.

The NPort S8000 will check a packet received at the ingress port for IEEE 802.1D traffic classification, and then prioritize it based upon the IEEE 802.1p value (service levels) in that tag. It is this 802.1p value that determines to which traffic queue the packet is mapped.

## Traffic Queues

The NPort S8000 hardware has multiple traffic queues that allow packet prioritization to occur. Higher priority traffic can pass through the NPort S8000 without being delayed by lower priority traffic. As each packet arrives in the NPort S8000, it passes through any ingress processing (which includes classification, marking/re-marking), and is then sorted into the appropriate queue. The switch then forwards packets from each queue.

The NPort S8000 supports two different queuing mechanisms:

- **Weight Fair:** This method services all the traffic queues, giving priority to the higher priority queues. Under most circumstances, this method gives high-priority precedence over low-priority, but in the event that high-priority traffic exceeds the link capacity, lower priority traffic is not blocked.
- **Strict:** This method services high-traffic queues first; low-priority queues are delayed until no more high-priority data needs to be sent. This method always gives precedence to high-priority over low-priority.

## Configuring Ethernet Traffic Prioritization

Quality of Service (QoS) provides a traffic prioritization capability to ensure that important data is delivered consistently and predictably. The NPort S8000 can inspect IEEE 802.1p/1Q layer 2 CoS tags, and even layer 3 TOS information, to provide a consistent classification of the entire network. The NPort S8000's QoS capability improves your industrial network's performance and determinism for mission critical applications.

## QoS Classification

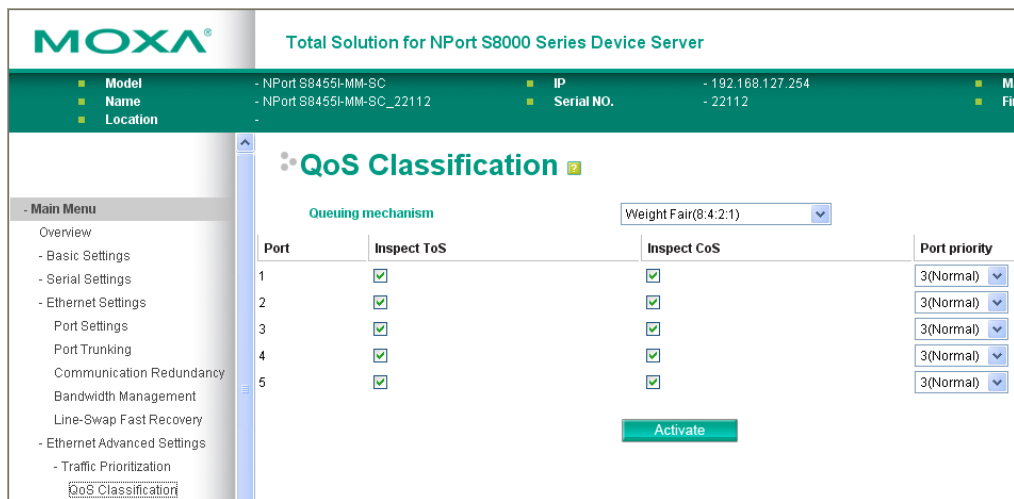

The NPort S8000 supports inspection of layer 3 TOS and/or layer 2 CoS tag information to determine how to classify traffic packets.

### Queuing Mechanism

Setting	Description	Factory Default
Weighted Fair	The NPort S8000 has four priority queues. In the weighted fair scheme, an 8, 4, 2, 1 weighting is applied to the four priorities. This approach prevents the lower priority frames from being starved of opportunity for transmission with only a slight delay to the higher priority frames.	Weight Fair
Strict	In the Strict-priority scheme, all top-priority frames egress a port until that priority's queue is empty, and then the next lower-priority queue's frames egress. This approach can cause the lower priorities to be starved of opportunity for transmitting any frames but ensures all high-priority frames to egress the switch as soon as possible.	

### Inspect TOS

Setting	Description	Factory Default
Enable/Disable	Select the option to enable the NPort S8000 to inspect the Type of Service (TOS) bits in IPV4 frame to determine the priority of each frame.	Enable

### Inspect COS

Setting	Description	Factory Default
Enable/Disable	Select the option to enable the NPort S8000 to inspect the 802.1p COS tag in the MAC frame to determine the priority of each frame.	Enable

### Port Priority

Setting	Description	Factory Default
Numerical value selected by user (from 0 to 7)	Increase this port's priority as a node on the 802.1d priority queue. The higher number the higher priority.	3

**NOTE** The priority of an ingress frame is determined in order by:

1. Inspect TOS
2. Inspect CoS
3. Port Highest Priority

**NOTE** The designer can enable these classifications individually or in combination. For instance, if a 'hot,' higher priority port is required for a network design, "Inspect TOS" and "Inspect CoS" can be disabled. This setting leaves only port default priority active, which results in all ingress frames being assigned the same priority on that port.

## CoS Mapping

The screenshot shows the MOXA web interface for an NPort S8000 Series Device Server. The main menu on the left includes 'CoS Mapping'. The central configuration area is titled 'Mapping Table of CoS Value and Priority Queues' and contains the following table:

CoS	Priority queue
0	Low
1	Low
2	Normal
3	Normal
4	Medium
5	Medium
6	High
7	High

An 'Activate' button is located at the bottom right of the configuration area.

Setting	Description	Factory
Low	Set the mapping table of different CoS values to four different egress queues.	0: Low
Normal		1: Low
Medium		2: Normal
High		3: Normal
		4: Medium
		5: Medium
		6: High
		7: High

## ToS/DiffServ Mapping

The screenshot shows the MOXA web interface for an NPort S8000 Series Device Server. The main menu on the left includes options like Overview, Basic Settings, Serial Settings, Ethernet Settings, Ethernet Advanced Settings, Traffic Prioritization, CoS Classification, CoS Mapping, ToS/DiffServ Mapping (selected), Virtual LAN, Multicast Filtering, Set Device IP, System Management, System Monitoring, and Restart. The main content area is titled 'Mapping Table of ToS (DSCP) Value and Priority Queues' and contains a table with 64 rows. Each row has two columns: 'ToS' and 'Level'. The ToS values range from 0x00(1) to 0xF0(62). The Level dropdown menus are set to Low, Normal, Medium, or High. An 'Activate' button is located at the bottom center of the table.

Setting	Description	Factory Default
Low	Set the mapping table of different TOS values to four different egress queues.	1 to 16: Low
Normal		17 to 32: Normal
Medium		33 to 48: Medium
High		49 to 64: High

## Virtual LAN

### Using Virtual LAN

Setting up Virtual LANs (VLANs) on your NPort S8000 increases the efficiency of your network by dividing the LAN into logical segments, as opposed to physical segments. In general, VLANs are easier to manage.

### The Virtual LAN (VLAN) Concept

#### What is a VLAN?

A VLAN is a group of devices that can be located anywhere on a network, but which communicate as if they are on the same physical segment. With VLANs, you can segment your network without being restricted by physical connections—a limitation of traditional network design. As an example, with VLANs you can segment your network according to:

- **Departmental groups**—You could have one VLAN for the Marketing department, another for the Finance department, and another for the Development department.
- **Hierarchical groups**—You could have one VLAN for directors, another for managers, and another for general staff.
- **Usage groups**—You could have one VLAN for e-mail users, and another for multimedia users.



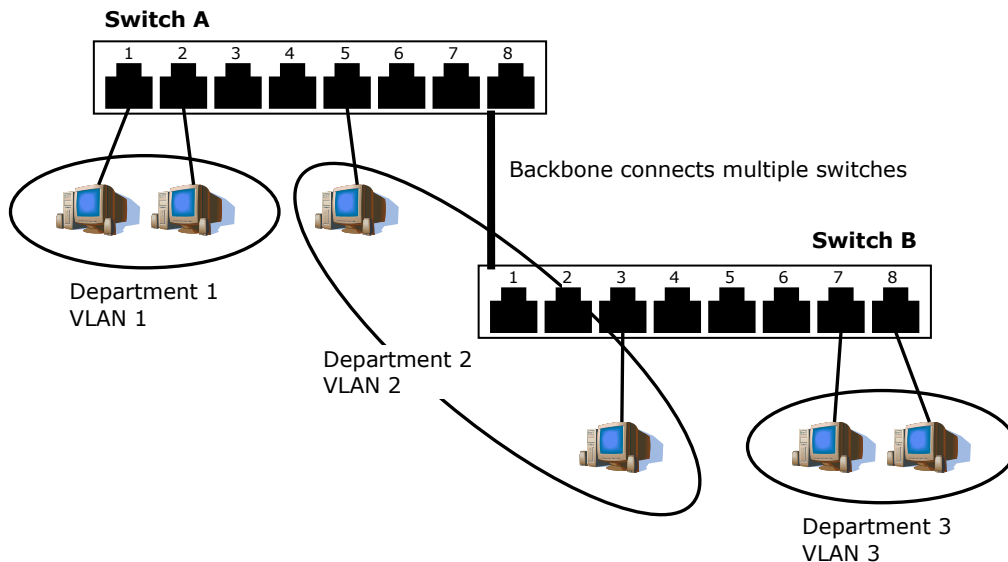

## Benefits of VLANs

The main benefit of VLANs is that they provide a network segmentation system that is far more flexible than traditional networks. Using VLANs also provides you with three other benefits:

- **VLANs ease the relocation of devices on networks:** With traditional networks, network administrators spend most of their time dealing with moves and changes. If users move to a different subnetwork, the addresses of each host must be updated manually. With a VLAN setup, if a host on VLAN Marketing, for example, is moved to a port in another part of the network, and retains its original subnet membership, you only need to specify that the new port is on VLAN Marketing. You do not need to carry out any re-cabling.
- **VLANs provide extra security:** Devices within each VLAN can only communicate with other devices on the same VLAN. If a device on VLAN Marketing needs to communicate with devices on VLAN Finance, the traffic must pass through a routing device or Layer 3 switch.
- **VLANs help control traffic:** With traditional networks, congestion can be caused by broadcast traffic that is directed to all network devices, regardless of whether or not they need it. VLANs increase the efficiency of your network because each VLAN can be set up to contain only those devices that need to communicate with each other.

## VLANs and Moxa EtherDevice Switch

Your NPort S8000 provides support for VLANs using IEEE Std 802.1Q-1998. This standard allows traffic from multiple VLANs to be carried across one physical link. The IEEE Std 802.1Q-1998 standard allows each port on your NPort S8000 to be placed in:

- Any one VLAN defined on the NPort S8000.
- Several VLANs at the same time using 802.1Q tagging.

The standard requires that you define the *802.1Q VLAN ID* for each VLAN on your NPort S8000 before the switch can use it to forward traffic:

## Managing a VLAN

A new or initialized NPort S8000 contains a single VLAN—the Default VLAN. This VLAN has the following definition:

- *VLAN Name*—Management VLAN
- *802.1Q VLAN ID*—1 (if tagging is required)

All the ports are initially placed on this VLAN, and it is the only VLAN that allows you to access the management software of the NPort S8000 over the network.

## Communication Between VLANs

If devices connected to a VLAN need to communicate to devices on a different VLAN, a router or Layer 3 switching device with connections to both VLANs needs to be installed. Communication between VLANs can only take place if they are all connected to a routing or Layer 3 switching device.

## VLANs: Tagged and Untagged Membership

The NPort S8000 supports 802.1Q VLAN tagging, a system that allows traffic for multiple VLANs to be carried on a single physical (backbone, trunk) link. When setting up VLANs, you need to understand when to use untagged and tagged membership of VLANs. Simply put, if a port is on a single VLAN it can be an untagged member, but if the port needs to be a member of multiple VLANs, tagged membership must be defined.

A typical host (e.g., clients) will be untagged members of one VLAN, defined as "Access Port" in the NPort S8000, while inter-switch connections will be tagged members of all VLANs, defined as "Trunk Port" in the NPort S8000.

The IEEE Std 802.1Q-1998 defines how VLANs operate within an open packet-switched network. An 802.1Q compliant packet carries additional information that allows a switch to determine which VLAN the port belongs to. If a frame is carrying the additional information, it is known as a *tagged* frame.

To carry multiple VLANs across a single physical (backbone, trunk) link, each packet must be tagged with a VLAN identifier so that the switches can identify which packets belong to which VLAN. To communicate between VLANs, a router must be used.

The NPort S8000 supports two types of VLAN port settings:

- **Access Port:** The port connects to a single device that is not tagged. The user must define the default port PVID that determines to which VLAN the device belongs. Once the ingress packet of this Access Port egresses to another Trunk Port (the port needs all packets to carry tag information), the NPort S8000 will insert this PVID into this packet to help the next 802.1Q VLAN switch recognize it.
- **Trunk Port:** The port connects to a LAN that consists of untagged devices/tagged devices and/or switches and hubs. In general, the traffic of the Trunk Port must have a Tag. Users can also assign PVID to a Trunk Port. The untagged packet on the Trunk Port will be assigned the port default PVID as its VID.

The following section illustrates how to use these ports to set up different applications.

## Sample Applications of VLANs using the NPort S8000

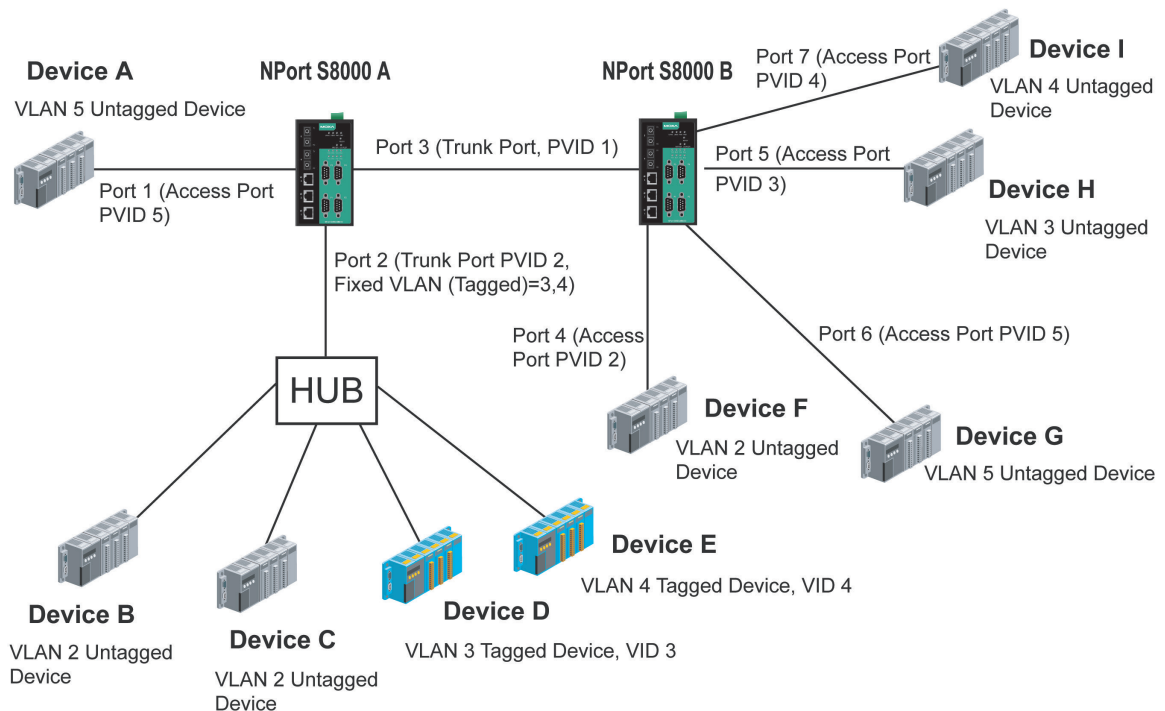

In this application:

- Port 1 connects a single untagged device and assigns it to VLAN 5; it should be configured as "Access Port" with PVID 5.
- Port 2 connects a LAN with two untagged devices belonging to VLAN 2. One tagged device with VID 3 and one tagged device with VID 4. It should be configured as "Trunk Port" with PVID 2 for untagged device and Fixed VLAN (Tagged) with 3 and 4 for tagged device. Since each port can only have one unique PVID, all untagged devices on the same port can only belong to the same VLAN.
- Port 3 connects with another switch. It should be configured as "Trunk Port." GVRP protocol will be used through the Trunk Port.
- Port 4 connects a single untagged device and assigns it to VLAN 2; it should be configured as "Access Port" with PVID 2.
- Port 5 connects a single untagged device and assigns it to VLAN 3; it should be configured as "Access Port" with PVID 3.
- Port 6 connect a single untagged device and assigns it to VLAN 5; it should be configured as "Access Port" with PVID 5.
- Port 7 connects a single untagged device and assigns it to VLAN 4; it should be configured as "Access Port" with PVID 4.

After proper configuration:

- Packets from device A will travel through "Trunk Port 3" with tagged VID 5. Switch B will recognize its VLAN, pass it to port 6, and then remove tags received successfully by device G, and vice versa.
- Packets from device B and C will travel through "Trunk Port 3" with tagged VID 2. Switch B recognizes its VLAN, passes it to port 4, and then removes tags received successfully by device F, and vice versa.
- Packets from device D will travel through "Trunk Port 3" with tagged VID 3. Switch B will recognize its VLAN, pass to port 5, and then remove tags received successfully by device H. Packets from device H will travel through "Trunk Port 3" with PVID 3. Switch A will recognize its VLAN and pass it to port 2, but will not remove tags received successfully by device D.

- Packets from device E will travel through “Trunk Port 3” with tagged VID 4. Switch B will recognize its VLAN, pass it to port 7, and then remove tags received successfully by device I. Packets from device I will travel through “Trunk Port 3” with tagged VID 4. Switch A will recognize its VLAN and pass it to port 2, but will not remove tags received successfully by device E.

## Configuring Virtual LAN

### VLAN Settings 802.1Q VLAN

To configure the NPort S8000’s **802.1Q VLAN**, use the VLAN Setting page to configure the ports.

#### VLAN Mode

Setting	Description	Factory Default
802.1Q VLAN	Set VLAN mode to 802.1Q VLAN	802.1Q VLAN
Port-based VLAN	Set VLAN mode to Port-based VLAN	

#### Management VLAN ID

Setting	Description	Factory Default
VLAN ID ranges from 1 to 4094	Set the management VLAN of this NPort S8000.	1

#### Port Type

Setting	Description	Factory Default
Access	This port type is used to connect single devices without tags.	Access
Trunk	Select “Trunk” port type to connect another 802.1Q VLAN aware switch or another LAN that combines tagged and/or untagged devices and/or other switches/hubs.	



#### ATTENTION

For communication redundancy in the VLAN environment, set “Redundant Port,” “Coupling Port,” and “Coupling Control Port” as “Trunk Port,” since these ports act as the “backbone” to transmit all packets of different VLANs to different NPort S8000 units.

#### Port PVID

Setting	Description	Factory Default
VID range from 1 to 4094	Set the port default VLAN ID for untagged devices that connect to the port.	1

**Fixed VLAN List (Tagged)**

Setting	Description	Factory Default
VID range from 1 to 4094	This field will be active only when selecting the "Trunk" port type. Set the other VLAN ID for tagged devices that connect to the "Trunk" port. Use commas to separate different VID's.	None

**Forbidden VLAN List**

Setting	Description	Factory Default
VID range from 1 to 4094	This field will be active only when selecting the "Trunk" port type. Set the VLAN IDs that will not be supported by this trunk port. Use commas to separate different VID's.	None

**Port-based VLAN**

To configure the NPort S8000's **Port-based VLAN**, use the VLAN Setting page to configure the ports.

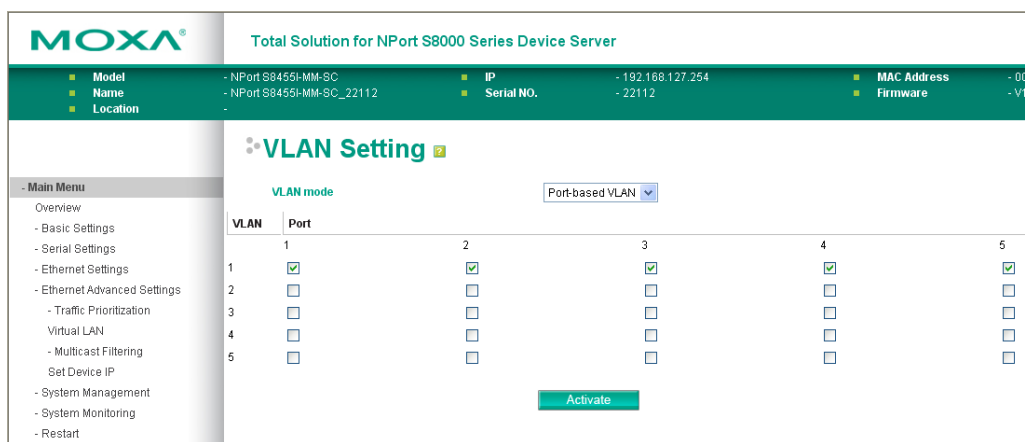

**VLAN Mode**

Setting	Description	Factory Default
802.1Q VLAN	Set VLAN mode to 802.1Q VLAN	802.1Q VLAN
Port-based VLAN	Set VLAN mode to Port-based VLAN	

**Port**

Setting	Description	Factory Default
Enable/Disable	Set port to specific VLAN Group.	Enable (all ports belong to VLAN1)

In 802.1Q VLAN table, you can review the VLAN groups that were created, Joined Access Ports, and Trunk Ports, and in Port-based VLAN table, you can review the VLAN group and Joined port.

**NOTE** The physical network can have a maximum of 64 VLAN settings.

# Multicast Filtering

## Using Multicast Filtering

Multicast filtering improves the performance of networks that carry multicast traffic. This section explains multicasts, multicast filtering, and how multicast filtering can be implemented on your NPort S8000.

## The Concept of Multicast Filtering

### What is an IP Multicast?

A *multicast* is a packet sent by one host to multiple hosts. Only those hosts that belong to a specific multicast group will receive the multicast. If the network is set up correctly, a multicast can only be sent to an end-station or a subset of end-stations on a LAN or VLAN that belong to the multicast group. Multicast group members can be distributed across multiple subnets, so that multicast transmissions can occur within a campus LAN or over a WAN. In addition, networks that support IP multicast send only *one* copy of the desired information across the network until the delivery path that reaches group members diverges. To make more efficient use of network bandwidth, it is only at these points that multicast packets are duplicated and forwarded. A multicast packet has a multicast group address in the destination address field of the packet's IP header.

### Benefits of Multicast

The benefits of using IP multicast are that it:

- Uses the most efficient, sensible method to deliver the same information to many receivers with only one transmission.
- Reduces the load on the source (for example, a server) since it will not need to produce several copies of the same data.
- Makes efficient use of network bandwidth and scales well as the number of multicast group members increases.
- Works with other IP protocols and services, such as Quality of Service (QoS).

Multicast transmission makes more sense and is more efficient than unicast transmission for some applications. For example, multicasts are often used for video-conferencing, since high volumes of traffic must be sent to several end-stations at the same time, but where broadcasting the traffic to all end-stations would cause a substantial reduction in network performance. Furthermore, several industrial automation protocols, such as Allen-Bradley, EtherNet/IP, Siemens Profibus, and Foundation Fieldbus HSE (High Speed Ethernet), use multicast. These industrial Ethernet protocols use publisher/subscriber communications models by multicasting packets that could flood a network with heavy traffic. IGMP Snooping is used to prune multicast traffic so that it travels only to those end destinations that require the traffic, reducing the amount of traffic on the Ethernet LAN.

## Multicast Filtering

Multicast filtering ensures that only end-stations that have joined certain groups receive multicast traffic. With multicast filtering, network devices only forward multicast traffic to the ports that are connected to registered end-stations. The following two figures illustrate how a network behaves without multicast filtering and with multicast filtering.

### **Network without multicast filtering**

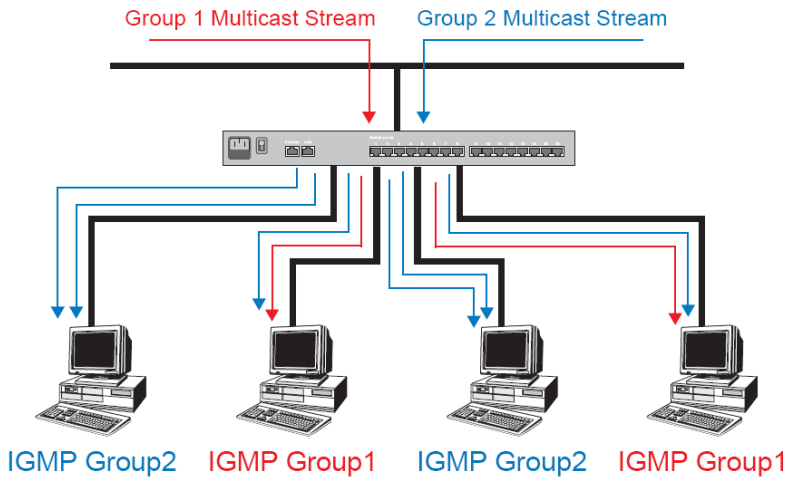

**All hosts receive the multicast traffic, even if they don't need it.**

### **Network with multicast filtering**

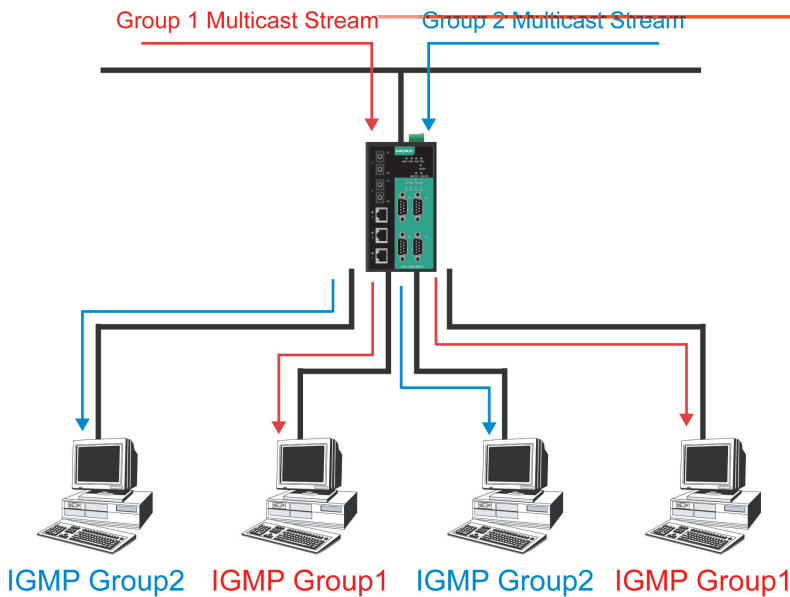

**Hosts only receive dedicated traffic from other hosts belonging to the same group**

## Multicast Filtering and Moxa Switching Device Server

The NPort S8000 has three ways to achieve multicast filtering: IGMP (Internet Group Management Protocol) Snooping, GMRP (GARP Multicast Registration Protocol), and adding a static multicast MAC manually to filter multicast traffic automatically

### IGMP Multicast Filtering

IGMP is used by IP-supporting network devices to register hosts with multicast groups. It can be used on all LANs and VLANs that contain a multicast capable IP router and on other network devices that support multicast filtering. IGMP works as follows:

The IP router (or querier) periodically sends *query* packets to all end-stations on the LANs or VLANs that are connected to it. For networks with more than one IP router, the router with the lowest IP address is the querier. A switch with IP address lower than the IP address of any other IGMP queriers connected to the LAN or VLAN can become the IGMP querier.

When an IP host receives a query packet, it sends a *report* packet back that identifies the multicast group that the end-station would like to join.

When the report packet arrives at a port on a switch with *IGMP Snooping* enabled, the switch knows that the port should forward traffic for the multicast group, and then proceeds to forward the packet to the router.

When the router receives the report packet, it registers that the LAN or VLAN requires traffic for the multicast groups.

When the router forwards traffic for the multicast group to the LAN or VLAN, the switches only forward the traffic to ports that received a report packet.

### IGMP (Internet Group Management Protocol)

#### Snooping Mode

Snooping Mode allows your switch to forward multicast packets only to the appropriate ports. The switch “snoops” on exchanges between hosts and an IGMP device, such as a router, to find those ports that want to join a multicast group, and then configures its filters accordingly.

#### Query Mode

Query mode allows the NPort S8000 to work as the Querier if it has the lowest IP address on the subnetwork to which it belongs. IGMP querying is enabled by default on the NPort S8000 to help prevent interoperability issues with some multicast routers that may not follow the lowest IP address election method. Enable query mode to run multicast sessions on a network that does not contain IGMP routers (or queriers).

**NOTE** The NPort S8000 is compatible with any device that conforms to the IGMP v2 and IGMP v3 device protocol.

## Configuring IGMP Snooping

IGMP Snooping provides the ability to prune multicast traffic so that it travels only to those end destinations that require that traffic, thereby reducing the amount of traffic on the Ethernet LAN.



# IGMP Snooping Settings



### IGMP Snooping Enable

Setting	Description	Factory Default
Enable/Disable	Select the option to enable the IGMP Snooping function globally.	Disabled

### Query Interval

Setting	Description	Factory Default
Numerical value input by user	Set the query interval of the Querier function globally. Valid settings are from 20 to 600 seconds.	125 seconds

### IGMP Snooping

Setting	Description	Factory Default
Enable/Disable	Select the option to enable the IGMP Snooping function per VLAN.	Enabled if IGMP Snooping Enabled Globally

### Querier

Setting	Description	Factory Default
Enable/Disable	Select the option to enable the NPort S8000's querier function.	Enabled if IGMP Snooping is Enabled Globally

### Static Multicast Router Port

Setting	Description	Factory Default
Select/Deselect	Select the option to select which ports will connect to the multicast routers. It's active only when IGMP Snooping is enabled.	Disabled

**NOTE** At least one switch must be designated the Querier or enable IGMP snooping and GMRP when enabling Turbo Ring and IGMP snooping simultaneously.

## Static Multicast MAC

Some devices may only support multicast packets, but not support either IGMP Snooping or GMRP. The NPort S8000 supports adding multicast groups manually to enable multicast filtering.

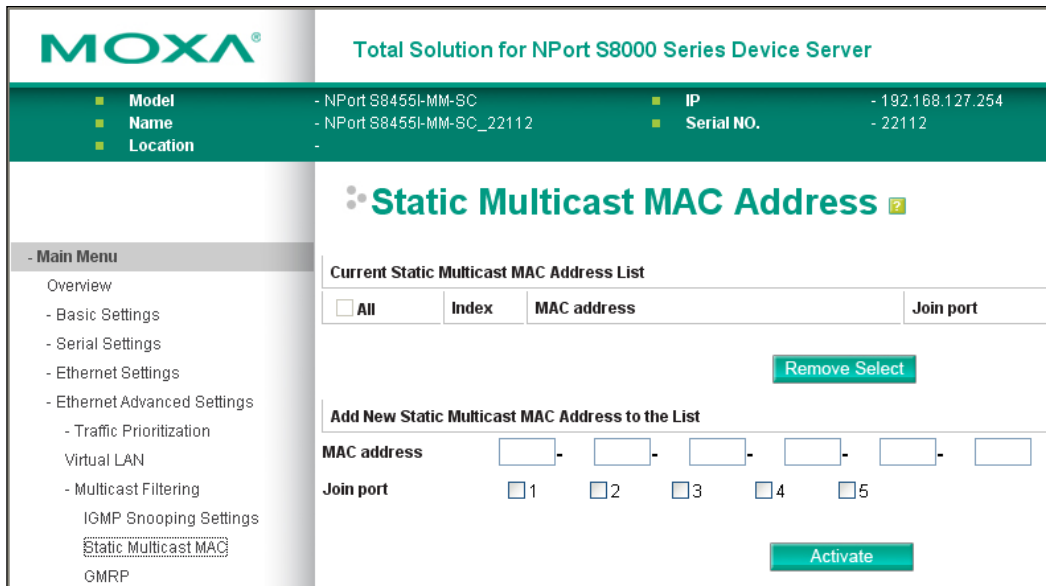

### Add New Static Multicast Address to the List

Setting	Description	Factory Default
MAC Address	Input the multicast MAC address of this host.	None

### Join Port

Setting	Description	Factory Default
Select/Deselect	Select the appropriate options to select the join ports for this multicast group.	None

## GMRP (GARP Multicast Registration Protocol)

The NPort S8000 supports IEEE 802.1D-1998 GMRP (GARP Multicast Registration Protocol), which differs from IGMP (Internet Group Management Protocol). GMRP is a MAC-based multicast management protocol, whereas IGMP is IP-based. GMRP provides a mechanism that allows bridges and end stations to register or deregister Group membership information dynamically. GMRP functions similarly to GVRP, except that GMRP registers multicast addresses on ports. When a port receives a **GMRP-join** message, it will register the multicast address to its database if the multicast address is not registered, and all the multicast packets with that multicast address are able to be forwarded from this port. When a port receives a **GMRP-leave** message, it will deregister the multicast address from its database, and all the multicast packets with this multicast address are not able to be forwarded from this port.

(Please refer to **Chapter 7, System Monitoring / Ethernet Status** for IGMP/GMRP Table)

## Configuring GMRP

GMRP is a MAC-based multicast management protocol, whereas IGMP is IP-based. GMRP provides a mechanism that allows bridges and end stations to register or deregister Group membership information dynamically.

### GMRP enable

Setting	Description	Factory Default
Enable/Disable	Select the option to enable the GMRP function for the port listed in the Port column	Disable

## Set Device IP

### Using Set Device IP

To reduce the effort required to set up IP addresses, the NPort S8000 comes equipped with DHCP/BOOTP server and RARP protocol to set up IP addresses of Ethernet-enabled devices automatically.

When enabled, the **Set device IP** function allows The NPort S8000 to assign specific IP addresses automatically to connected devices that are equipped with *DHCP Client* or *RARP* protocol. In effect, the NPort S8000 acts as a DHCP server by assigning a connected device with a specific IP address stored in its internal memory. Each time the connected device is switched on or rebooted, the NPort S8000 sends the device the desired IP address.

Perform the following steps to use the **Set device IP** function:

1. *set up the connected devices*

Set up those Ethernet-enabled devices connected to the NPort S8000 for which you would like IP addresses to be assigned automatically. The devices must be configured to obtain their IP address automatically.

The devices' configuration utility should include a setup page that allows you to choose an option similar to Obtain an IP address automatically.

For example, Windows' TCP/IP Properties window is shown at the right. Although your device's configuration utility may look quite a bit different, this figure should give you some idea of what to look for.

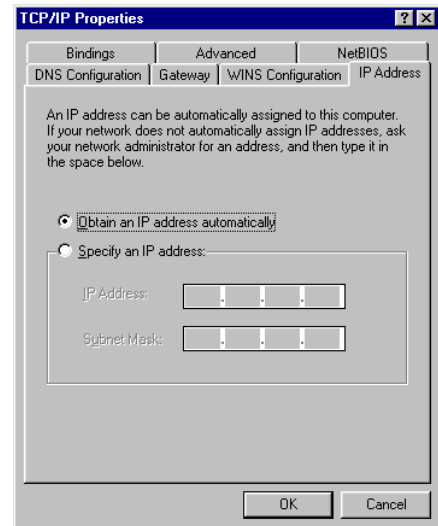

You also need to decide to which of the NPort S8000's ports your Ethernet-enabled devices will be connected. You will need to set up each of these ports separately, as described in the following step.

2. Configure the NPort S8000's Set device IP function, either from the Console utility or from the Web Browser interface. In either case, you simply need to enter the Desired IP for each port that needs to be configured.
3. Be sure to activate your settings before exiting.
  - When using the Web Browser interface, activate by clicking **Activate**.
  - When using the Console utility, activate by first highlighting the **Activate** menu option, and then press **Enter**. You should receive the **Set device IP settings are now active! (Press any key to continue)** message.

## Configuring Set Device IP

### Automatic Set Device IP by DHCP/Bootp/RARP

Port	Device's current IP	Active function	Desired IP address
1	NA	--	<input type="text"/>
2	NA	--	<input type="text"/>
3	NA	--	<input type="text"/>
4	NA	--	<input type="text"/>
5	NA	--	<input type="text"/>

**Activate**

#### Desired IP Address

Setting	Description	Factory Default
IP Address	Set the desired IP of connected devices.	None

The DHCP Relay Agent makes it possible for DHCP broadcast messages to be sent over routers. The DHCP Relay Agent enables DHCP clients to obtain IP addresses from a DHCP server on a remote subnet, or those that are not located on the local subnet.

## DHCP Relay Agent (Option 82)

Option 82 is used by the relay agent to insert additional information into the client's DHCP request. The Relay Agent Information option is inserted by the DHCP relay agent when forwarding client-originated DHCP packets to a DHCP server. Servers can recognize the Relay Agent Information option and use the information to implement IP addresses to Clients.

When Option 82 is enabled on the switch, a subscriber device is identified by the switch port through which it connects to the network (in addition to its MAC address). Multiple hosts on the subscriber LAN can be connected to the same port on the access switch and are uniquely identified.

The Option 82 information contains two sub-options: Circuit ID and Remote ID, which define the relationship between end device IP and the DHCP Option 82 server. The "Circuit ID" is a 4-byte number generated by the Ethernet switch—a combination of physical port number and VLAN ID. The format of the "Circuit ID" is as described below:

**FF-VV-VV-PP**

Where the first byte "FF" is fixed to "01", the second and the third byte "VV-VV" is formed by the port VLAN ID in hex, and the last byte "PP" is formed by the port number in hex. For example,

01-00-0F-03 is the "Circuit ID" of port number 3 with port VLAN ID 15.

The "Remote ID" is to identify the relay agent itself, and it can be one of the following:

1. The IP address of the relay agent.
2. The MAC address of the relay agent.
3. A combination of IP address and MAC address of the relay agent.
4. A user-defined string.

### DHCP Relay Agent ?

**Server IP Address**

1st Server

2nd Server

3rd Server

4th Server

**DHCP Option 82**

Enable Option 82

Type IP ▾

Value

Display

Port	Circuit-ID	Option 82
1	01000101	<input type="checkbox"/> Enable
2	01000102	<input type="checkbox"/> Enable
3	01000103	<input type="checkbox"/> Enable
4	01000104	<input type="checkbox"/> Enable
5	01000105	<input type="checkbox"/> Enable

## System Management

### Misc. Network Settings

#### Accessible IP List

The NPort S8000 uses an IP address-based filtering method to control access to NPort S8000 units.

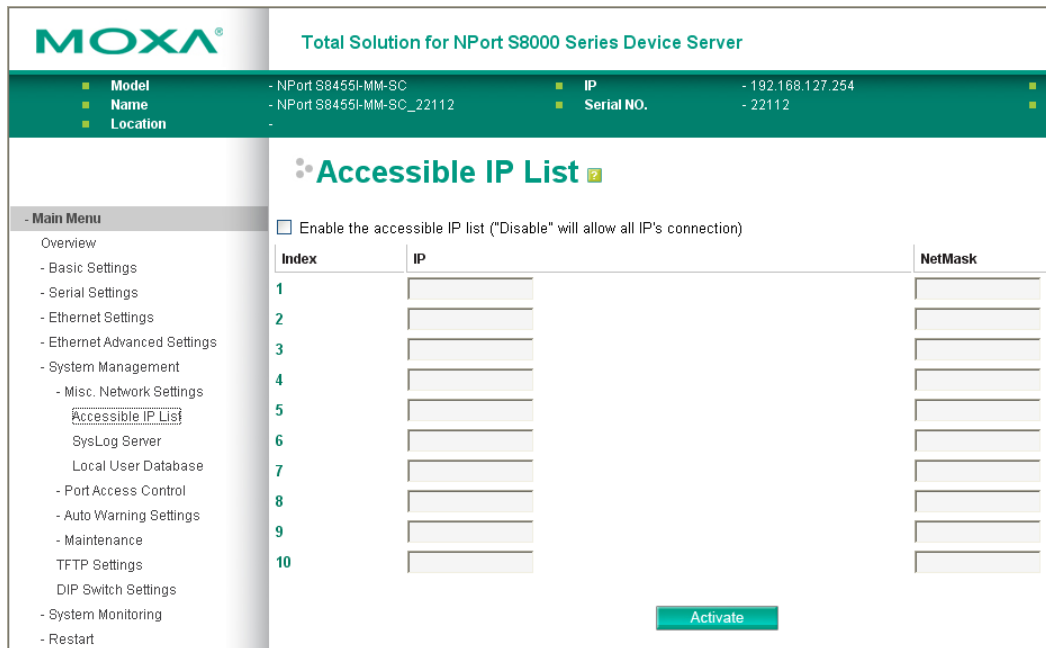

Accessible IP Settings allows you to add or remove “Legal” remote host IP addresses to prevent unauthorized access. Access to the NPort S8000 is controlled by IP address. If a host’s IP address is in the accessible IP table, then the host will be allowed access to the NPort S8000. You can allow one of the following cases by setting this parameter:

- **Only one host with the specified IP address can access the NPort S8000**  
E.g., enter “192.168.1.1/255.255.255.255” to allow access to just the IP address 192.168.1.1.
- **Any host on a specific subnetwork can access the NPort S8000**  
E.g., enter “192.168.1.0/255.255.255.0” to allow access to all IPs on the subnet defined by this IP address/subnet mask combination.
- **Any host can access the NPort S8000**  
Disable this function by deselecting the Enable the accessible IP list option. The following table shows additional configuration examples:

Allowable Hosts	Input format
Any host	Disable
192.168.1.120	192.168.1.120 / 255.255.255.255
192.168.1.1 to 192.168.1.254	192.168.1.0 / 255.255.255.0
192.168.0.1 to 192.168.255.254	192.168.0.0 / 255.255.0.0
192.168.1.1 to 192.168.1.126	192.168.1.0 / 255.255.255.128
192.168.1.129 to 192.168.1.254	192.168.1.128 / 255.255.255.128

## SysLog Server

### Using Syslog

This function provides the event logs for the syslog server. The function supports 3 configurable syslog servers and syslog server UDP port numbers. When an event occurs, the event will be sent as a Syslog UDP packet to the specified syslog servers.

**Syslog Server 1**

Setting	Description	Factory Default
IP Address	Enter the IP address of 1st Syslog Server used by your network.	None
Port Destination (1 to 65535)	Enter the UDP port of 1st Syslog Server.	514

**Syslog Server 2**

Setting	Description	Factory Default
IP Address	Enter the IP address of 2nd Syslog Server used by your network.	None
Port Destination (1 to 65535)	Enter the UDP port of 2nd Syslog Server.	514

**Syslog Server 3**

Setting	Description	Factory Default
IP Address	Enter the IP address of 3rd Syslog Server used by your network.	None
Port Destination (1 to 65535)	Enter the UDP port of 3rd Syslog Server.	514

**NOTE** The following events will be recorded into the NPort S8000-508A/505A's Event Log table, and will then be sent to the specified Syslog Server:

1. Cold start
2. Warm start
3. Configuration change activated
4. Power 1/2 transition (Off ( On), Power 1/2 transition (On ( Off)
5. Authentication fail
6. Topology changed
7. Master setting is mismatched
8. DI 1/2 transition (Off ( On), DI 1/2 transition (On ( Off)
9. Port traffic overload
10. dot1x Auth Fail
11. Port link off / on

# Local User Database

## Local User Database Setup

The User Database may be used for to authenticate users for 802.1x access and is useful if you do not have an external RADIUS server for authentication. The User Table allow to stores up to 32 entries, with fields for User Name, Password, and Description. When setting the Local User Database as the authentication database, set the database first.

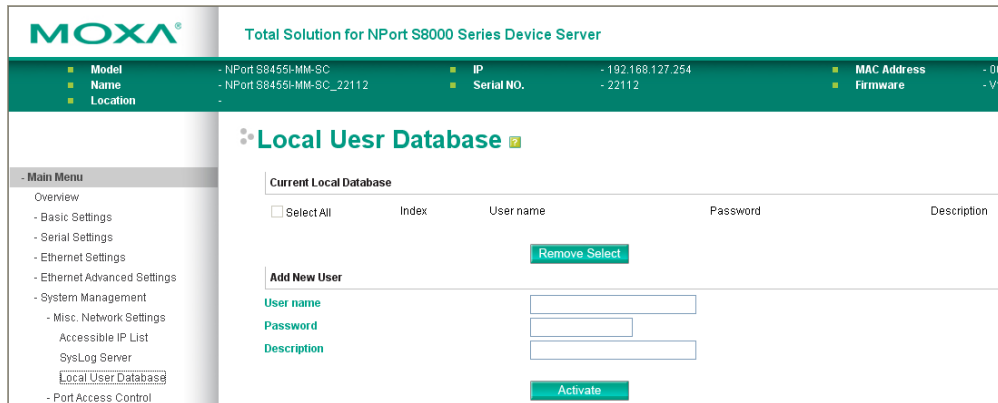

### Local User Database Setup

Setting	Description	Factory Default
User Name (Max. 30 characters)	User Name for Local User Database	None
Password (Max. 16 characters)	Password for Local User Database	None
Description (Max. 30 characters)	Description for Local User Database	None

**NOTE** The user name for the Local User Database is case-insensitive.

# Port Access Control

## Using Port Access Control

The NPort S8000 provides two kinds of Port-Based Access Controls. One is Static Port Lock and the other is IEEE 802.1X.

### Static Port Lock

The NPort S8000 can also be configured to protect static MAC addresses for a specific port. With the Port Lock function, these locked ports will not learn any additional addresses, but they only allow traffic from preset static MAC addresses, helping to block crackers and careless usage.

### IEEE 802.1X

The IEEE 802.1X standard defines a protocol for client/server-based access control and authentication. The protocol restricts unauthorized clients from connecting to a LAN through ports that are open to the Internet, and which otherwise would be readily accessible. The purpose of the authentication server is to check each



client that requests access to the port. The client is only allowed access to the port if the client’s permission is authenticated.

## The IEEE 802.1X Concept

Three components are used to create an authentication mechanism based on 802.1X standards: Client/Supplicant, Authentication Server, and Authenticator.

**Supplicant:** The end station that requests access to the LAN and switch services and responds to the requests from the switch.

**Authentication server:** The server that performs the actual authentication of the supplicant.

**Authenticator:** Edge switch or wireless access point that acts as a proxy between the supplicant and the authentication server, requesting identity information from the supplicant, verifying the information with the authentication server, and relaying a response to the supplicant.

The NPort S8000 acts as an authenticator in the 802.1X environment. A supplicant and an authenticator exchange EAPOL (Extensible Authentication Protocol over LAN) frames with each other. We can either use an external RADIUS server as the authentication server, or implement the authentication server in the NPort S8000 by using a Local User Database as the authentication look-up table. When we use an external RADIUS server as the authentication server, the authenticator and the authentication server exchange EAP frames between each other.

Authentication can be initiated either by the supplicant or the authenticator. When the supplicant initiates the authentication process, it sends an “EAPOL-Start” frame to the authenticator. When the authenticator initiates the authentication process or when it receives an “EAPOL Start” frame, it sends an “EAP Request/Identity” frame to ask for the username of the supplicant. The following actions are described below:

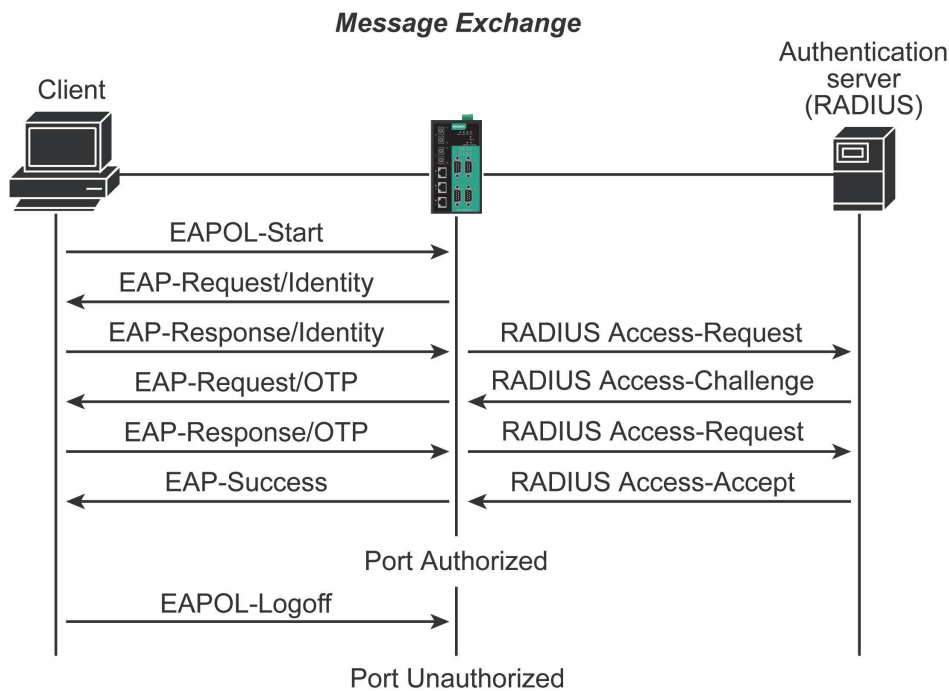

1. When the supplicant receives an “EAP Request/Identity” frame, it sends an “EAP Response/Identity” frame with its username back to the authenticator.
2. If the RADIUS server is used as the authentication server, the authenticator relays the “EAP Response/Identity” frame from the supplicant by encapsulating it into a “RADIUS Access-Request” frame and sends to the RADIUS server. When the authentication server receives the frame, it looks up its database to check if the username exists. If the username is not present, the authentication server replies with a “RADIUS Access-Reject” frame to the authenticator if the server is a RADIUS server or just indicates

- failure to the authenticator if the Local User Database is used. The authenticator sends an "EAP-Failure" frame to the supplicant.
3. The RADIUS server sends a "RADIUS Access-Challenge," which contains an "EAP Request" with an authentication type to the authenticator to ask for the password from the client. RFC 2284 defines several EAP authentication types, such as "MD5-Challenge," "One-Time Password," and "Generic Token Card." Currently, only "MD5-Challenge" is supported. If the Local User Database is used, this step is skipped.
  4. The authenticator sends an "EAP Request/MD5-Challenge" frame to the supplicant. If the RADIUS server is used, the "EAP Request/MD5-Challenge" frame is retrieved directly from the "RADIUS Access-Challenge" frame.
  5. The supplicant responds to the "EAP Request/MD5-Challenge" by sending an "EAP Response/MD5-Challenge" frame that encapsulates the user's password using the MD5 hash algorithm.
  6. If the RADIUS server is used as the authentication server, the authenticator relays the "EAP Response/MD5-Challenge" frame from the supplicant by encapsulating it into a "RADIUS Access-Request" frame along with a "Shared Secret," which must be the same within the authenticator and the RADIUS server, and sends the frame to the RADIUS server. The RADIUS server checks against the password with its database, and replies with "RADIUS Access-Accept" or "RADIUS Access-Reject" to the authenticator. If the Local User Database is used, the password is checked against its database and indicates success or failure to the authenticator.
  7. The authenticator sends "EAP Success" or "EAP Failure" based on the reply from the authentication server.

## Configuring Static Port Lock

The NPort S8000 supports adding unicast groups manually if required.



Setting	Description	Factory Default
MAC Address	Add the static unicast MAC address into the address table.	None
Port	Fix the static address with a dedicated port.	1

# Configuring IEEE 802.1X

### Database Option

Setting	Description	Factory Default
Local (Max. 32 users)	Select this option when setting the Local User Database as the authentication database.	Local
Radius	Select this option to set an external RADIUS server as the authentication database. The authentication mechanism is "EAP-MD5."	Local
Radius, Local	Select this option to make an external RADIUS server as the authentication database with first priority. The authentication mechanism is "EAP-MD5." The second priority is to set the Local User Database as the authentication database.	Local

### Re-Auth

Setting	Description	Factory Default
Enable/Disable	Select to require re-authentication of the client after a preset time period of no activity has elapsed.	Disable

### Radius Server

Setting	Description	Factory Default
IP address or domain name	The IP address or domain name of the RADIUS server	localhost

**Re-Auth Period**

Setting	Description	Factory Default
Numerical (60-65535 sec.)	Specify how frequently the end stations need to reenter usernames and passwords in order to stay connected.	3600

**Server Port**

Setting	Description	Factory Default
Numerical	The UDP port of the RADIUS Server	1812

**Shared Key**

Setting	Description	Factory Default
alphanumeric (Max. 40 characters)	A key to be shared between the external RADIUS server and The NPort S8000. Both ends must be configured to use the same key.	None

**802.1X**

Setting	Description	Factory Default
Enable/Disable	Select the option under the 802.1X column to enable IEEE 802.1X for one or more ports. All end stations must enter usernames and passwords before access to these ports is allowed.	Disable

## Auto Warning Settings

### Using Auto Warning

Since industrial Ethernet devices are often located at the endpoints of a system, these devices will not always know what is happening elsewhere on the network. This means that an industrial Ethernet switch that connects to these devices must provide system maintainers with real-time alarm messages. Even when control engineers are out of the control room for an extended period of time, they can still be informed of the status of devices almost instantaneously when exceptions occur. The NPort S8000 supports different approaches to warn engineers automatically, such as by using email and relay output. It also supports two digital inputs to integrate sensors into your system to automate alarms using email and relay output.

On the Event Settings page, you may configure how administrators are notified of certain system, network, and configuration events. Depending on the event, different options for automatic notification are available, as shown above. **Mail** refers to sending an e-mail to a specified address. **Trap** refers to sending an SNMP Trap.

## Configuring E-Mail Alert

The Auto Email Warning function uses e-mail to alert the user when certain user-configured events take place.

Three basic steps are required to set up the Auto Warning function:

- 1. Configuring Email Event Types**

Select the desired Event types from the Console or Web Browser Event type page (a description of each event type is given later in the Email Alarm Events setting subsection).

- 2. Configuring Email Settings**

To configure the NPort S8000's email setup from the Console interface or browser interface, enter your Mail Server IP/Name (IP address or name), Account Name, Account Password, Retype New Password, and the email address to which warning messages will be sent.

- 3. Activate your settings and if necessary, test the email**

After configuring and activating your NPort S8000's Event Types and Email Setup, you can use the Test Email function to see if your e-mail addresses and mail server address have been properly configured.

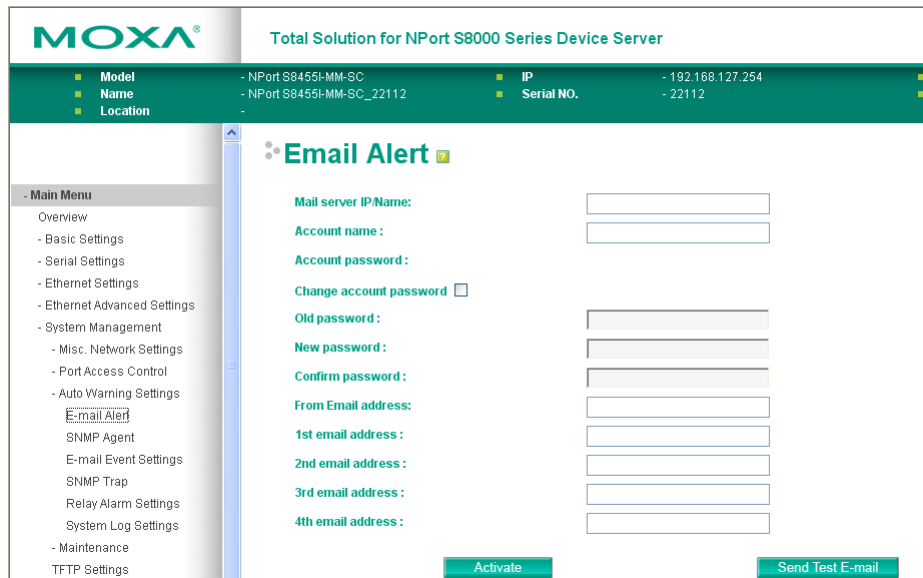

**Mail Server IP/Name**

Setting	Description	Factory Default
IP address	The IP Address of your email server.	None

**Account Name**

Setting	Description	Factory Default
Max. 45 Characters	Your email account name (typically your user name)	None

**Account Password**

Setting	Description	Factory Default
Disable/Enable to change Password	To reset the Password from the Web Browser interface, click the Change password check-box, type the Old Password, type the New Password, retype the New password, and then click Activate; Max. 45 Characters.	Disable
Old Password	Type the current password when changing the password	None
New Password	Type new password when enabled to change password; Max. 45 Characters.	None
Confirm Password	If you type a new password in the Password field, you will be required to retype the password in the Retype new password field before updating the new password.	None

**Email Address**

Setting	Description	Factory Default
Max. 30 characters	You can set up to 4 email addresses to receive alarm emails from the NPort S8000.	None

**Send Test Email**

After configuring the email settings, you should first click **Activate** to activate those settings, and then click **Send Test Email** to verify that the settings are correct.

**NOTE** Auto warning e-mail messages will be sent through an authentication protected SMTP server that supports the CRAM-MD5, LOGIN, and PLAIN methods of SASL (Simple Authentication and Security Layer) authentication mechanism.  
We strongly recommend not entering your Account Name and Account Password if auto warning e-mail messages can be delivered without using an authentication mechanism.

## Configuring SNMP

The NPort S8000 supports SNMP V1/V2c/V3. SNMP V1, and SNMP V2c use a community string match for authentication, which means that SNMP servers access all objects with read-only or read/write permissions using the community string *public/private* (default value). SNMP V3, which requires you to select an authentication level of MD5 or SHA, is the most secure protocol. You can also enable data encryption to enhance data security.

SNMP security modes and security levels supported by the NPort S8000 are shown in the following table. Select the security mode and level that will be used to communicate between the SNMP agent and manager.

Protocol Version	UI Setting	Authentication Type	Data Encryption	Method
SNMP V1, V2c	V1, V2c Read Community	Community string	No	Use a community string match for authentication
	V1, V2c Write/Read Community	Community string	No	Use a community string match for authentication
SNMP V3	No-Auth	No	No	Use account with admin or user to access objects
	MD5 or SHA	Authentication based on MD5 or SHA	No	Provides authentication based on HMAC-MD5, or HMAC-SHA algorithms. 8-character passwords are the minimum requirement for authentication.
	MD5 or SHA	Authentication based on MD5 or SHA	Data encryption key	Provides authentication based on HMAC-MD5 or HMAC-SHA algorithms, and data encryption key. 8-character passwords and a data encryption key are the minimum requirements for authentication and encryption.

These parameters are configured on the SNMP page. A more detailed explanation of each parameter follows.

## SNMP Read/Write Settings



SNMP read/write settings	
SNMP versions	V1, V2c
V1,V2c read community	public
V1,V2c write/read community	private
Read/write user name	
Read/write authentication mode	No-Auth
Read/write password	
Read/write privacy mode	Disable
Read/write privacy	
Read only user name	
Read only authentication mode	No-Auth
Read only password	
Read only privacy mode	Disable
Read only privacy	
Trap settings	
1st trap server IP/Name	
1st trap community	public
2nd trap server IP/Name	
2nd trap community	public
Trap mode	
Mode	Trap
Retries	1 (1~99)
Timeout	1 (1~300s)
Private MIB information	
Server object ID	enterprise.8691.2.12

Activate

**SNMP agent version:** The NPort S8000 supports SNMP V1, V2c, and V3.

**V1, V2c Read community (default=public):** This is a text password mechanism that is used to weakly authenticate queries to agents of managed network devices.

**V1, V2c Write/Read community (default=private):** This is a text password mechanism that is used to weakly authenticate changes to agents of managed network devices.

**Read/write User name:** Use this optional field to identify the user name for the specified level of access.

**Read/write Authentication mode (default=No-Auth):** Use this field to select MD5 or SHA as the method of password encryption for the specified level of access, or to disable authentication

**Read/write Password:** Use this field to set the password for the specified level of access.

**Read/write Privacy mode (default=Disable):** Use this field to enable and disable DES data encryption for the specified level of access.

**Read/write Privacy:** Use this field to define the encryption key for the specified level of access.

**Read only:** Read only authentication mode allows you to configure the authentication mode for read/write access. For each level of access, you may configure the following:

**Read/only User name:** Use this optional field to identify the user name for the specified level of access.

**Read/only Authentication mode (default=No-Auth):** Use this field to select MD5 or SHA as the method of password encryption for the specified level of access, or to disable authentication.

**Read/only Password:** Use this field to set the password for the specified level of access.

**Read/only Privacy mode (default=Disable):** Use this field to enable and disable DES data encryption for the specified level of access.

**Read/only Privacy:** Use this field to define the encryption key for the specified level of access.

**1st Trap Server IP/Name:** Enter the IP address or the name of the 1st Trap Server used by your network.

**1st Trap Community:** Use a community string match for authentication (maximum of 30 characters).

**2nd Trap Server IP/Name:** Enter the IP address or the name of the 2nd Trap Server used by your network.

**2nd Trap Community:** Use a community string match for authentication (maximum of 30 characters).

**Retries (Inform mode select):** Enter the Inform Retry number Enter the numbers of retries before

**Time out (Inform mode select):** Enter Inform Timeout window

## E-mail Event Settings

Event Types can be divided into three basic groups: **System Events**, **Serial Port Events** and **Ethernet Port Events**.

### Email Event Settings ?

**System Events**

<input type="checkbox"/> System cold start	<input type="checkbox"/> System warm start	<input type="checkbox"/> Power transition(On->Off)	<input type="checkbox"/> Power transition(Off->On)
<input type="checkbox"/> DI 1 (Off)	<input type="checkbox"/> DI 1 (On)	<input type="checkbox"/> DI 2 (Off)	<input type="checkbox"/> DI 2 (On)
<input type="checkbox"/> Config. change	<input type="checkbox"/> Auth. failure	<input type="checkbox"/> Comm. redundancy topology changed	

**Serial Port Events**

Port	DCD changed	DSR changed
1	<input type="checkbox"/>	<input type="checkbox"/>
2	<input type="checkbox"/>	<input type="checkbox"/>
3	<input type="checkbox"/>	<input type="checkbox"/>
4	<input type="checkbox"/>	<input type="checkbox"/>

**Ethernet Port Events**

Port	Link-ON	Link-OFF	Traffic-Overload	Traffic-Threshold(%)	Traffic-Duration(s)
1	<input type="checkbox"/>	<input type="checkbox"/>	<input type="checkbox"/>	<input type="text" value="0"/>	<input type="text" value="1"/>
2	<input type="checkbox"/>	<input type="checkbox"/>	<input type="checkbox"/>	<input type="text" value="0"/>	<input type="text" value="1"/>
3	<input type="checkbox"/>	<input type="checkbox"/>	<input type="checkbox"/>	<input type="text" value="0"/>	<input type="text" value="1"/>
4	<input type="checkbox"/>	<input type="checkbox"/>	<input type="checkbox"/>	<input type="text" value="0"/>	<input type="text" value="1"/>
5	<input type="checkbox"/>	<input type="checkbox"/>	<input type="checkbox"/>	<input type="text" value="0"/>	<input type="text" value="1"/>

Activate

System Events	Warning e-mail is sent when...
System Cold Start	Power is cut off and then reconnected.
System Warm Start	The NPort S8000 is rebooted, such as when network parameters are changed (IP address, subnet mask, etc.).
Power Transition (On->Off)	The NPort S8000 is powered down.
Power Transition (Off->On)	The NPort S8000 is powered up.
DI1 (On->Off)	Digital Input 1 is triggered by on to off transition



System Events	Warning e-mail is sent when...
DI1 (Off→On)	Digital Input 1 is triggered by off to on transition
DI2 (On→Off)	Digital Input 2 is triggered by on to off transition
DI2 (Off→On)	Digital Input 2 is triggered by off to on transition
Configuration Change Activated	A configuration item has been changed.
Authentication Failure	An incorrect password is entered.
Comm. Redundancy Topology Changed	Spanning Tree Protocol switches have changed their position (applies only to the root of the tree). The Master of the Turbo Ring has changed or the backup path is activated.

Serial Port Events	Warning e-mail is sent when...
<b>DCD changed</b>	A change in the DCD (Data Carrier Detect) signal indicates that the modem connection status has changed. For example, if the DCD signal changes to low, it indicates that the connection line is down. When the DCD signal changes to low, the NPort S8000 will automatically send a warning to the administrator as configured on the Serial Event Settings page.
<b>DSR changed</b>	A change in the DSR (Data Set Ready) signal indicates that the data communication equipment is powered off. For example, if the DSR signal changes to low, it indicates that the data communication equipment is powered down. When the DSR signal changes to low, the NPort S8000 will automatically send a warning to the administrator as configured on the Serial Event Settings page.

Ethernet Port Events	Warning e-mail is sent when...
Link-ON	The port is connected to another device.
Link-OFF	The port is disconnected (e.g., the cable is pulled out, or the opposing device shuts down).
Traffic-Overload	The port's traffic surpasses the Traffic-Threshold for that port (provided this item is Enabled).
Traffic-Threshold (%)	Enter a non-zero number if the port's Traffic-Overload item is Enabled.
Traffic-Duration (sec.)	A Traffic-Overload warning is sent every Traffic-Duration seconds if the average Traffic-Threshold is surpassed during that time period.

**NOTE** The default "Warning e-mail message" is empty in the sender field. It is recommended to set a message to help you to recognize the Warning e-mail message.

# SNMP Trap

## SNMP Trap ?

**System Events**

<input type="checkbox"/> System cold start	<input type="checkbox"/> System warm start	<input type="checkbox"/> Power transition(On->Off)	<input type="checkbox"/> Power transition(Off->On)
<input type="checkbox"/> DI 1 (Off)	<input type="checkbox"/> DI 1 (On)	<input type="checkbox"/> DI 2 (Off)	<input type="checkbox"/> DI 2 (On)
<input type="checkbox"/> Config. change	<input type="checkbox"/> Auth. failure	<input type="checkbox"/> Comm. redundancy topology changed	

**Serial Port Events**

Port	DCD changed	DSR changed
1	<input type="checkbox"/>	<input type="checkbox"/>
2	<input type="checkbox"/>	<input type="checkbox"/>
3	<input type="checkbox"/>	<input type="checkbox"/>
4	<input type="checkbox"/>	<input type="checkbox"/>

**Ethernet Port Events**

Port	Link-ON	Link-OFF	Traffic-Overload	Traffic-Threshold(%)	Traffic-Duration(s)
1	<input type="checkbox"/>	<input type="checkbox"/>	<input type="checkbox"/>	<input type="text" value="0"/>	<input type="text" value="1"/>
2	<input type="checkbox"/>	<input type="checkbox"/>	<input type="checkbox"/>	<input type="text" value="0"/>	<input type="text" value="1"/>
3	<input type="checkbox"/>	<input type="checkbox"/>	<input type="checkbox"/>	<input type="text" value="0"/>	<input type="text" value="1"/>
4	<input type="checkbox"/>	<input type="checkbox"/>	<input type="checkbox"/>	<input type="text" value="0"/>	<input type="text" value="1"/>
5	<input type="checkbox"/>	<input type="checkbox"/>	<input type="checkbox"/>	<input type="text" value="0"/>	<input type="text" value="1"/>

Activate

System Events	Warning e-mail is sent when...
System Cold Start	Power is cut off and then reconnected.
System Warm Start	The NPort S8000 is rebooted, such as when network parameters are changed (IP address, subnet mask, etc.).
Power Transition (On->Off)	The NPort S8000 is powered down.
Power Transition (Off->On)	The NPort S8000 is powered up.
DI1 (On->Off)	Digital Input 1 is triggered by on to off transition
DI1 (Off->On)	Digital Input 1 is triggered by off to on transition
DI2 (On->Off)	Digital Input 2 is triggered by on to off transition
DI2 (Off->On)	Digital Input 2 is triggered by off to on transition
Configuration Change Activated	A configuration item has been changed.
Authentication Failure	An incorrect password is entered.
Comm. Redundancy Topology Changed	Spanning Tree Protocol switches have changed their position (applies only to the root of the tree). The Master of the Turbo Ring has changed or the backup path is activated.

Serial Port Events	Warning e-mail is sent when...
<b>DCD changed</b>	A change in the DCD (Data Carrier Detect) signal indicates that the modem connection status has changed. For example, if the DCD signal changes to low, it indicates that the connection line is down. When the DCD signal changes to low, the NPort S8000 will automatically send a warning to the administrator as configured on the Serial Event Settings page.
<b>DSR changed</b>	A change in the DSR (Data Set Ready) signal indicates that the data communication equipment is powered off. For example, if the DSR signal changes to low, it indicates that the data communication equipment is powered down. When the DSR signal changes to low, the NPort S8000 will automatically send a warning to the administrator as configured on the Serial Event Settings page.

Ethernet Port Events	Warning e-mail is sent when...
Link-ON	The port is connected to another device.
Link-OFF	The port is disconnected (e.g., the cable is pulled out, or the opposing device shuts down).
Traffic-Overload	The port's traffic surpasses the Traffic-Threshold for that port (provided this item is Enabled).
Traffic-Threshold (%)	Enter a non-zero number if the port's Traffic-Overload item is Enabled.
Traffic-Duration (sec.)	A Traffic-Overload warning is sent every Traffic-Duration seconds if the average Traffic-Threshold is surpassed during that time period.

**NOTE** The default "Warning e-mail message" is empty in the sender field. It is recommended to set a message to help you to recognize the Warning e-mail message.

## Relay Alarm Settings

### Configuring Relay Warning

The Auto Relay Warning function uses relay output to alert the user when certain user-configured events take place. There are two basic steps required to set up the Relay Warning function:

1. **Configuring Relay Event Types**

Select the desired Event types from the Console or Web Browser Event type page (a description of each event type is given later in the Relay Alarm Events setting subsection).

2. **Activate your settings**

After completing the configuration procedure, you will need to activate your NPort S8000's Relay Event Types.

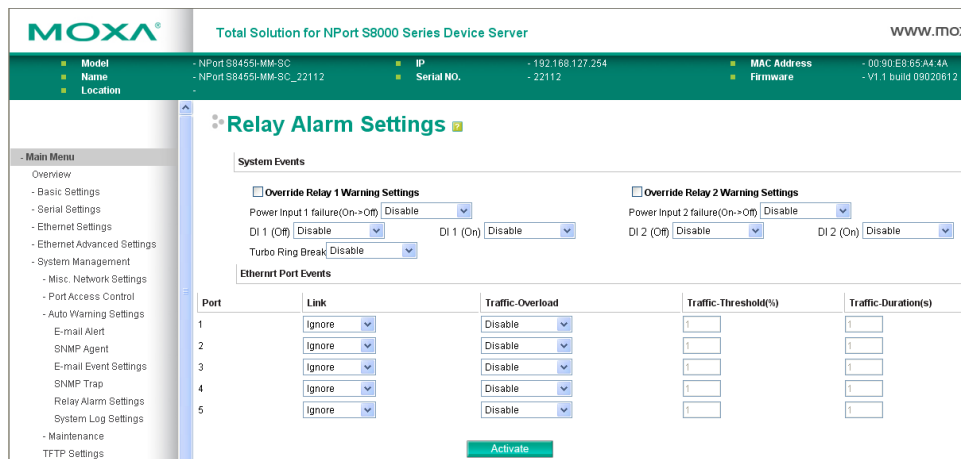

Event Types can be divided into two basic groups: **System Events** and **Ethernet Port Events**. System Events are related to the overall function of the NPort S8000, whereas Ethernet Port Events are related to the activity of a specific port.

The NPort S8000 supports two relay outputs. You can configure which relay output is related to which events. This helps administrators identify the importance of the different events.

## Override relay alarm settings

Select this option to override the relay warning setting temporarily. Releasing the relay output will allow administrators to fix any problems with the warning condition.

System Events	Factory Default
Override relay 1 Warning settings	Non-check
Override relay 2 Warning settings	Non-check

System Events	Warning Relay output is triggered when...	
Power Input 1 failure (On→Off)	Disable	Default
	Relay 1	Relay 1 is triggered by on to off transition
	Relay 2	Relay 2 is triggered by on to off transition
Power Input 2 failure (On→Off)	Disable	Default
	Relay 1	Relay 1 is triggered by on to off transition
	Relay 2	Relay 2 is triggered by on to off transition
DI1 (On→Off)	Disable	Default
	Relay 1	Digital Input 1 is triggered by on to off transition and enable Relay 1
	Relay 2	Digital Input 1 is triggered by on to off transition and enable Relay 2.
DI1 (Off→On)	Disable	Default
	Relay 1	Digital Input 1 is triggered by off to on transition and enable Relay 1
	Relay 2	Digital Input 1 is triggered by off to on transition and enable Relay 2.
DI2 (On→Off)	Disable	Default
	Relay 1	Digital Input 2 is triggered by on to off transition and enable Relay 1
	Relay 2	Digital Input 2 is triggered by on to off transition and enable Relay 2.
DI2 (Off→On)	Disable	Default
	Relay 1	Digital Input 2 is triggered by off to on transition and enable Relay 1
	Relay 2	Digital Input 2 is triggered by off to on transition and enable Relay 2.

Port Events	Warning Relay output is triggered when...
Link-ON	The port is connected to another device.
Link-OFF	The port is disconnected (e.g., the cable is pulled out, or the opposing device shuts down).
Traffic-Overload	The port's traffic surpasses the Traffic-Threshold for that port (provided this item is Enabled).
Traffic-Threshold (%)	Enter a non-zero number if the port's Traffic-Overload item is Enabled.
Traffic-Duration (sec.)	A Traffic-Overload warning is sent every Traffic-Duration seconds if the average Traffic-Threshold is surpassed during that time period.

**NOTE** The **Traffic-Overload**, **Traffic-Threshold (%)**, and **Traffic-Duration (sec)** Port Event items are related. If you Enable the Traffic-Overload event, then be sure to enter a non-zero Traffic-Threshold percentage, as well as a Traffic-Duration between 1 and 300 seconds.

## System Log Settings

System Log Settings allow the administrator to customize which network events are logged by the NPort S8000. Events are grouped into four categories, known as event groups, and the administrator selects which groups to log under Local Log. The actual system events that would be logged for each system group are listed under summary. For example, if **System** was enabled, then System Cold Start events and System Warm Start events would be logged.

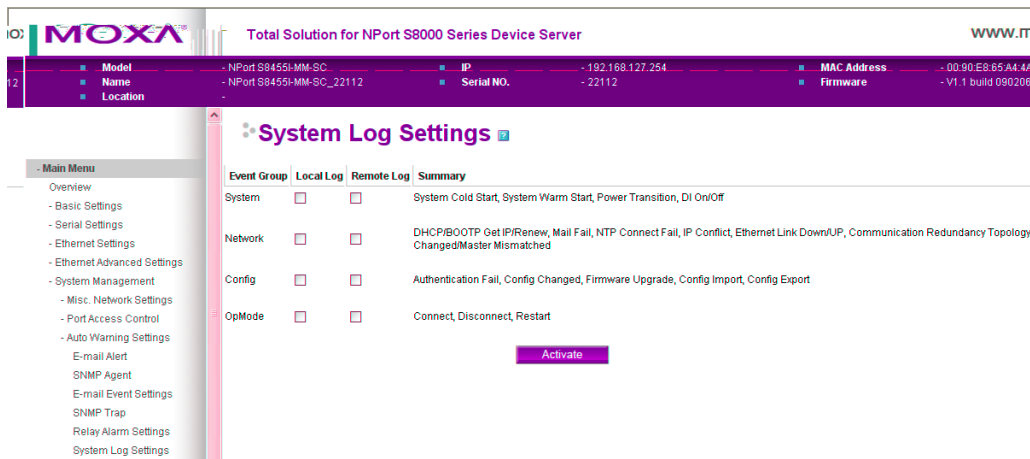

<b>Local Log</b>	<b>Keep the log into the flash of NPort S8000 up to 512 items.</b>
<b>Remote Log</b>	Keep the log into the remote defined Log Server. You will need to assign a remote Log Server in the System Management / Misc. Network Settings / Remote Log Settings if remote log is checked.

**System**

System Cold Start	NPort S8000 cold start.
System Warm Start	NPort S8000 warm start.
Power Transition	The NPort S8000 is powered up or down.
DI On/Off	Digital Input 1 is triggered

**Network**

DHCP/BOOTP/Get IP/Renew	IP of the NPort S8000 is refreshed.
Mail Fail	Failed to deliver the E-mail.
NTP Connect Fail	The NPort S8000 failed to connect to the time server.
IP Conflict	There is an IP conflict on the local network.
Network Link Down/UP	LAN 1 Link is down.
Communication Redundancy Topology Changed/Master Mismatched	When the status of Ring is changed or Master device is mismatched

**Config**

Authentication Fail	
IP Changed	Static IP address was changed.
Config Changed	The NPort S8000's configuration was changed.
Firmware Upgrade	Firmware was upgraded.
Config Import	Config was imported.
Config Export	Config was exported.

**OpMode**

Connect	Op Mode is in used
Disconnect	Op Mode switched from in use to disconnect.
Restart	Serial port was restarted.

# Maintenance

## Console Settings

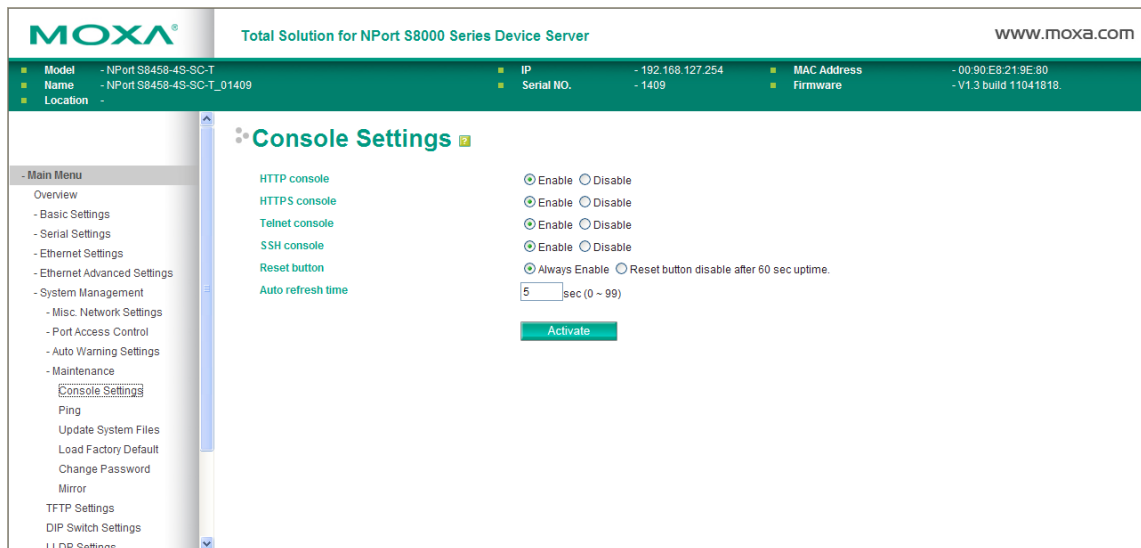

### Config

HTTP console	HTTP console enable/disable
HTTPS console	HTTPS console enable/disable
Telnet console	Telnet console enable/disable
SSH console	SSH console enable/disable
Reset button	Always Enable Reset button disable after 60 sec uptime
Auto refresh time	Monitor page refresh time

## Ping

The **Ping** function uses the *ping* command to give users a simple but powerful tool for troubleshooting network problems. The function’s most unique feature is that even though the ping command is entered from the user’s PC keyboard, the actual ping command originates from NPort S8000 itself. In this way, the user can essentially control the NPort S8000 and send ping commands out through its ports.

To use the Ping function, type in the desired IP address, and then press **Enter** from the Console utility, or click **Ping** when using the Web Browser interface.



## Update System Files from Local PC

The NPort S8000 supports different types of files that can be uploaded to or downloaded from the device. In this section, you will learn the details of the different types of files, such as log file, configuration file or firmware file, and how to import/export them from the NPort S8000. Also, you can input a pre-shared key to protect the configuration file you export.

### Pre-shared Key

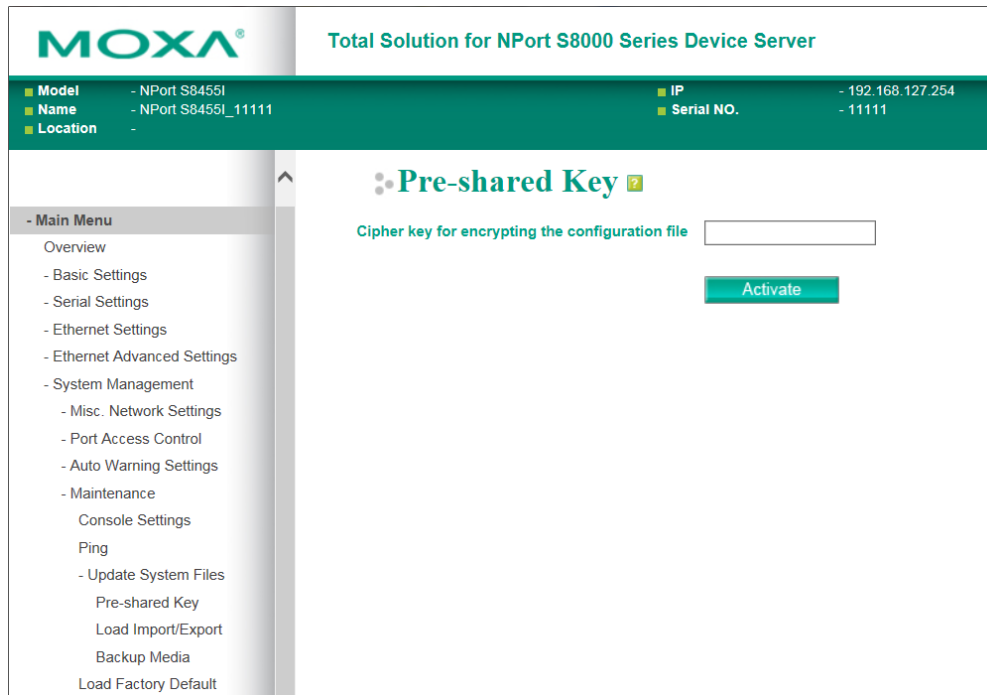

Input the password to protect the configuration file you have exported. The configure file will be encrypted and will not be able to be edited. When you try to import it, you need to provide the pre-shared key before importing it to the same or a new NPort S8000. If you keep this column empty, the exported file will not be protected and can be edited in an editor, such as Notepad.

## Load Import/Export

The screenshot shows the MOXA web interface for an NPort S8000 Series Device Server. At the top, the MOXA logo is on the left, and the text 'Total Solution for NPort S8000 Series Device Server' is on the right. Below this is a green header bar containing system information: Model (NPort S8455I), Name (NPort S8455I\_11111), Location (-), IP (192.168.127.254), Serial NO. (11111), MAC Address, and Firmware. A left sidebar menu lists various settings, with 'Update System Files' selected. The main content area is titled 'Update System Files' and contains four rows of options: 'Configuration file' with an 'Export' button; 'Log file' with an 'Export' button; 'Upgrade firmware' with a 'Browse...' button and an 'Import' button; and 'Upload configure data' with a 'Browse...' button and an 'Import' button.

### **Configuration File**

To export the configuration file of this NPort S8000, click **Export** to save it to the local host.

### **Log File**

To export the Log file of this NPort S8000, click **Export** and save it to the local host.

**NOTE** Some operating systems will open the configuration file and log file directly in the web page. In such cases, right click Export to save as a file.

### **Upgrade Firmware**

To import the firmware file of this NPort S8000, click **Browse** to select the firmware file already saved on your computer. The upgrade procedure will proceed automatically after clicking **Import**.

### **Upload Configuration Data**

To import the configuration file of this NPort S8000, click **Browse** to select the configuration file already saved on your computer. The upgrade procedure will proceed automatically after clicking **Import**.



## Backup Media

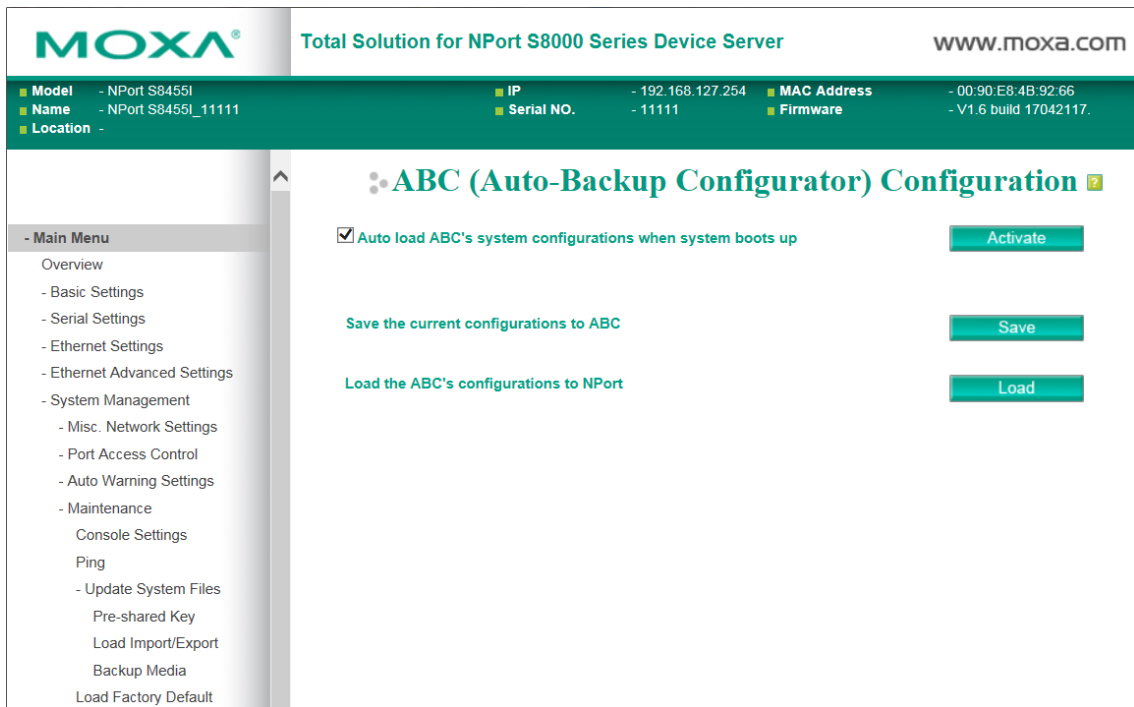

You can use Moxa's Automatic Backup Configurator (ABC-01) to save and load the NPort S8000's configurations through NPort S8000's RS-232 console port. You may find more details about ABC-01 at: [http://www.moxa.com/product/Automatic\\_Backup\\_Configurator\\_ABC-01.htm](http://www.moxa.com/product/Automatic_Backup_Configurator_ABC-01.htm).

## Load Factory Default

This function will reset all of NPort S8000's settings to the factory default values. All previous settings including the console password will be lost. If you wish to keep the NPort S8000 IP address, netmask, and other IP settings, make sure **Keep IP settings** is checked off before loading the factory defaults.

The Factory Default function is included to give users a quick way of restoring the NPort S8000's configuration settings to their factory default values. This function is available in the Console utility (serial or Telnet), and Web Browser interface.

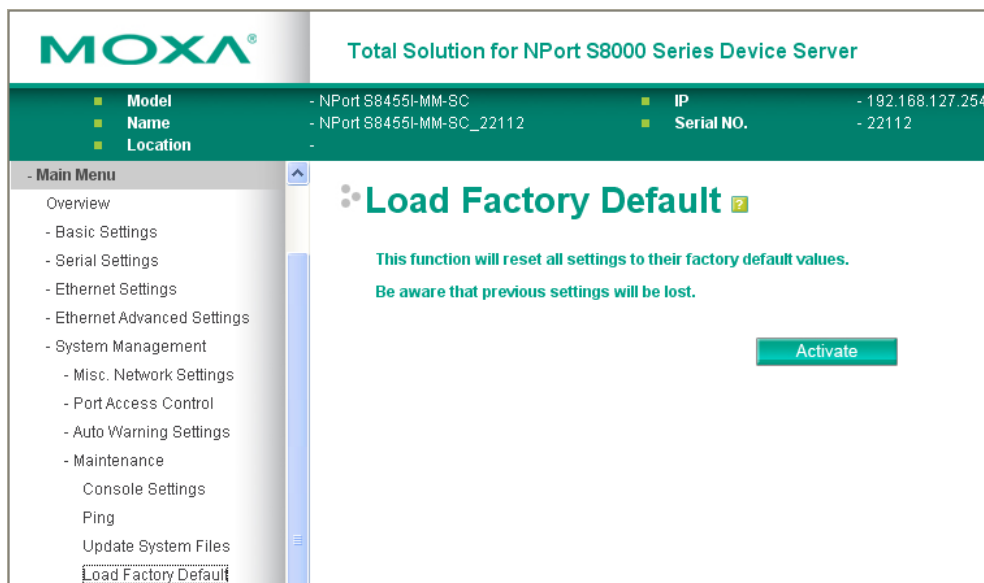

**NOTE** After activating the Factory Default function, you will need to use the default network settings to re-establish a web-browser or Telnet connection with your NPort S8000.

## Change Password

For all changes to the NPort S8000’s password protection settings, you will first need to enter the old password. Leave this blank if you are setting up password protection for the first time. To set up a new password or change the existing password, enter your desired password under both **New password** and **Confirm password**. To remove password protection, leave the **New password** and **Confirm password** boxes blank.

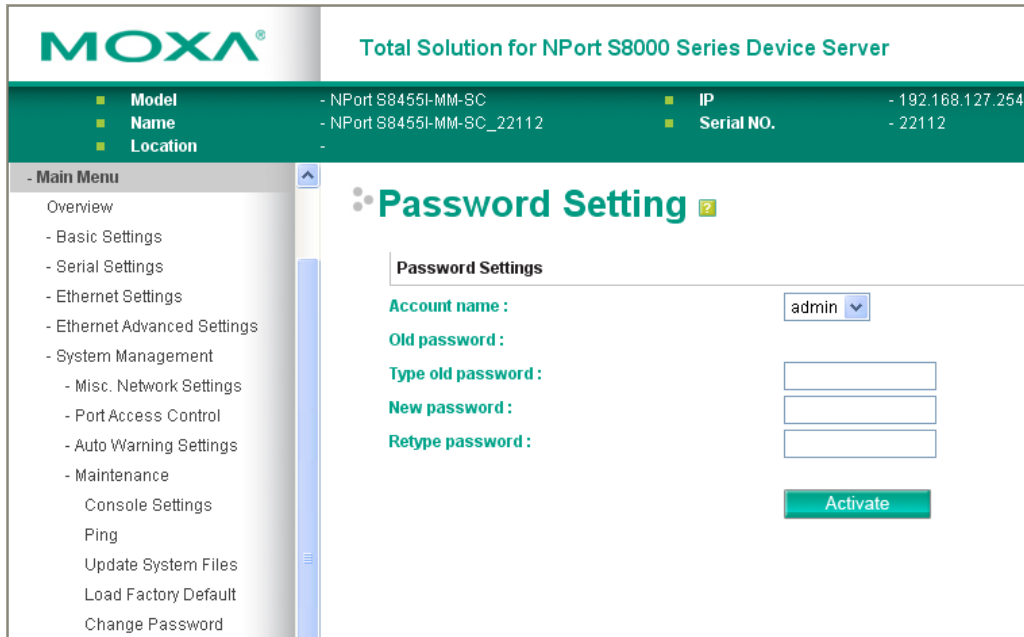

## Mirror Port Settings

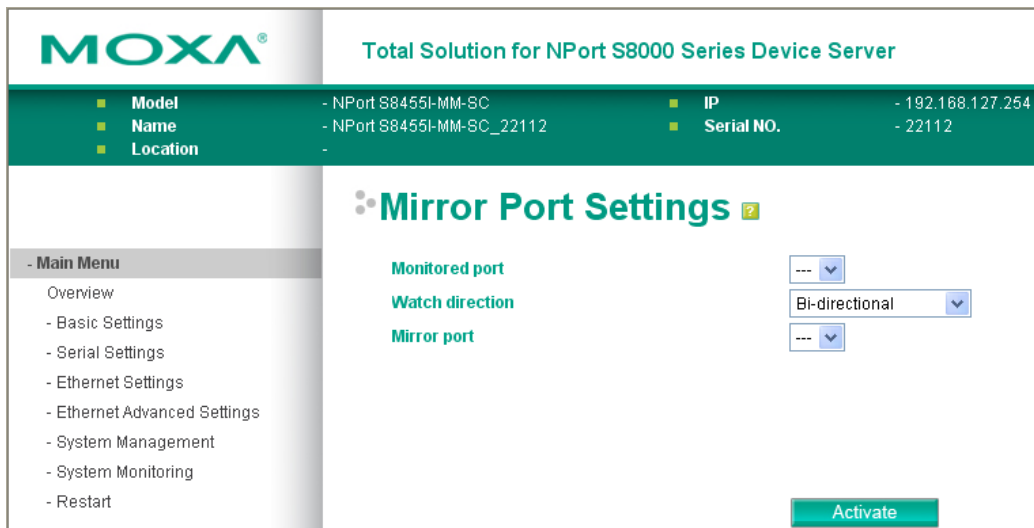

The **Mirror port** function can be used to monitor data being transmitted through a specific port. This is done by setting up another port (the mirror port) to receive the same data being transmitted from, or both to and from, the port under observation. This allows the network administrator to “sniff” the observed port and thus keep tabs on network activity.

Perform the following steps to set up the **Mirror Port** function:

1. Configure the EDS’s Mirror Port function from either the Console utility or Web Browser interface. You will need to configure three settings:

- Monitored Port** Select the port number of the port whose network activity will be monitored.
- Mirror Port** Select the port number of the port that will be used to monitor the activity of the monitored port.
- Watch Direction** Select one of the following three watch direction options:
  - **Input data stream**  
Select this option to monitor only those data packets coming *in through* the EDS’s port.
  - **Output data stream**  
Select this option to monitor only those data packets being sent *out through* the EDS’s port.
  - **Bi-directional**  
Select this option to monitor data packets both coming *into*, and being sent *out through*, the EDS’s port.

2. Be sure to activate your settings before exiting.
  - When using the Web Browser interface, activate by clicking **Activate**.
  - When using the Console utility, activate by first highlighting the Activate menu option, and then press Enter. You should receive the **Mirror port settings are now active! (Press any key to continue)** message.

## TFTP Settings

### System File Update—By Remote TFTP

The NPort S8000 supports saving your configuration file to a remote TFTP server or local host to allow other NPort S8000 switches to use the same configuration at a later time, or saving the Log file for future reference. Loading pre-saved firmware or a configuration file from the TFTP server or local host is also supported for easy upgrading or configuration of the NPort S8000.



#### TFTP Server IP/Name

Setting	Description	Factory Default
IP Address of TFTP Server	The IP or name of the remote TFTP server. Must be set up before downloading or uploading files.	None

#### Configuration Files Path and Name

Setting	Description	Factory Default
Max. 40 Characters	The path and file name of the NPort S8000’s configuration file in the TFTP server.	None

**Firmware Files Path and Name**

Setting	Description	Factory Default
Max. 40 Characters	The path and file name of the NPort S8000's firmware file.	None

**Log Files Path and Name**

Setting	Description	Factory Default
Max. 40 Characters	The path and file name of the NPort S8000's log file	None

After setting up the desired path and file name, click **Activate** to save the setting, and then click **Download** to download the prepared file from the remote TFTP server, or click **Upload** to upload the desired file to the remote TFTP server.

## DIP Switch Settings

### Turbo Ring DIP Switches

The **Turbo Ring DIP Switch** page allows users to disable the four DIP switches located on the NPort S8000's outer casing. When enabled, the DIP switches can be used to configure basic settings for either the "Turbo Ring" protocol or "Turbo Ring V2" protocol. A complete description of the settings is given below.

**NOTE** The proprietary "Turbo Ring" protocol (recovery time < 300 ms) was developed by Moxa in 2003 to provide better network reliability and faster recovery time for redundant ring topologies. The "Turbo Ring V2" protocol (recovery time < 20 ms), which was released in 2007, supports additional redundant ring architectures. In this manual, we use the terminology "Turbo Ring" ring and "Turbo Ring V2" ring to differentiate between rings configured for one or the other of these protocols.

For a detailed description of "Turbo Ring" and "Turbo Ring V2," please refer to the Using Communication Redundancy section later in this chapter.

### How to Enable or Disable the Turbo Ring DIP Switches

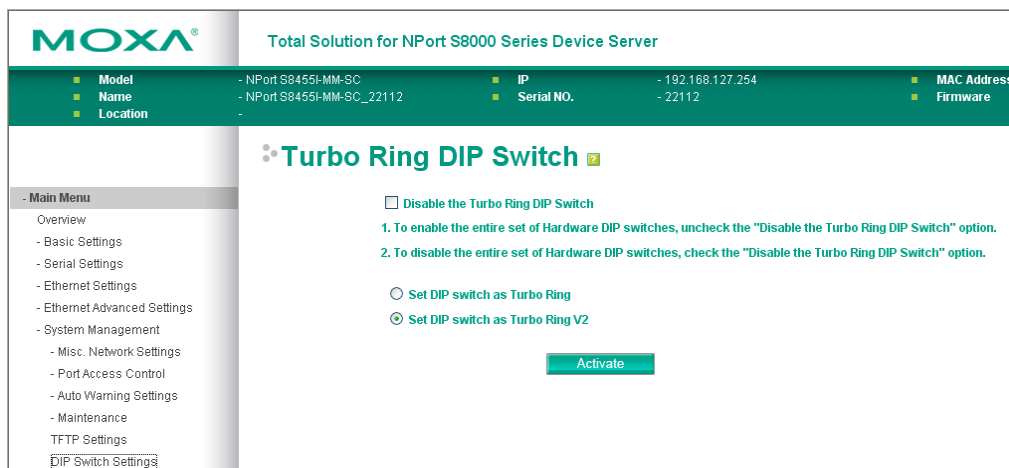

**Disable the Turbo Ring DIP Switch**

Setting	Description	Factory Default
Enable the Turbo Ring DIP Switches	The four DIP switches are enabled when the "Disable the Turbo Ring DIP Switch" box is not checked.	Not checked (i.e., the Turbo Ring DIP Switches are enabled by default)
Disable the Turbo Ring DIP Switches	The four DIP switches are disabled when the "Disable the Turbo Ring DIP Switch" box is checked.	

**Set DIP switch as Turbo Ring / Set DIP switch as Turbo Ring V2**

Setting	Description	Factory Default
Set DIP switch as Turbo Ring	Select this option to enable the Turbo Ring DIP switches to configure the NPort S8000 for a "Turbo Ring" ring.	This is the default if you do NOT reset the switch to factory default settings (provided you upgraded the firmware for Turbo Ring V2).
Set DIP switch as Turbo Ring V2	Select this option to enable the Turbo Ring DIP switches to configure the NPort S8000 for a "Turbo Ring V2" ring.	This is the default if you DO reset the switch to factory default settings (provided you upgraded the firmware for Turbo Ring V2).

## How to Configure the Turbo Ring DIP Switches

The Turbo Ring DIP Switches are set to the OFF position at the factory.

**NOTE** The four DIP Switches are used to configure both the "Turbo Ring" and "Turbo Ring V2" protocols, depending on which protocol is active. To select which protocol the NPort S8000 will use, start the user interface software, and then use the left menu to navigate to the Communication Redundancy page. To use one of the Turbo Ring protocols for the NPort S8000, select either "Turbo Ring" or "Turbo Ring V2" in the Redundancy Protocol drop-down box. See the Configuring "Turbo Ring" and "Turbo Ring V2" section in this chapter for details.

The following tables show how to use the DIP switches to configure the NPort S8000 for "Turbo Ring" or "Turbo Ring V2."

**NOTE** DIP switch 4 must be set to the ON position to enable DIP switches 1, 2, and 3. If DIP switch 4 is set to the "OFF" position, then DIP switches 1, 2, and 3 will all be disabled.

### Turbo Ring" DIP Switch Settings

DIP 1	DIP 2	DIP 3	DIP 4
Reserved for future use.	<u>ON</u> : Enables this NPort S8000 as the Ring Master.	<u>ON</u> : Enables the default "Ring Coupling" ports.	<u>ON</u> : Activates DIP switches 1, 2, 3 to configure "Turbo Ring" settings.
	<u>OFF</u> : This NPort S8000 will not be the Ring Master.	<u>OFF</u> : Do not use this NPort S8000 as the ring coupler.	<u>OFF</u> : DIP switches 1, 2, 3 will be disabled.

### "Turbo Ring V2" DIP Switch Settings

DIP 1	DIP 2	DIP 3	DIP 4
<u>ON</u> : Enables the default "Ring Coupling (backup)" port.	<u>ON</u> : Enables this NPort S8000 as the Ring Master.	<u>ON</u> : Enables the default "Ring Coupling" port.	<u>ON</u> : Activates DIP switches 1, 2, 3 to configure "Turbo Ring V2" settings.
<u>OFF</u> : Enables the default "Ring Coupling (primary)" port.	<u>OFF</u> : This NPort S8000 will not be the Ring Master.	<u>OFF</u> : Do not use this NPort S8000 as a ring coupler.	<u>OFF</u> : DIP switches 1, 2, 3 will be disabled.

**NOTE** The DIP 1 setting will only be active if DIP 3 is in the ON position. If you set DIP 3 to OFF, then the default Ring Coupling port will NOT be enabled, even if DIP 1 is ON.

**NOTE** The Turbo Ring Ports and Coupling Ports will be added automatically to all VLANs if you set DIP Switch 4 to the "ON" position.

**NOTE** If you do not enable any of the NPort S8000 switches to be the Ring Master, the Turbo Ring protocol will automatically choose the NPort S8000 with the smallest MAC address range to be the Ring Master. If you accidentally enable more than one NPort S8000 to be the Ring Master, these NPort S8000 switches will auto-negotiate to determine which one will be the Ring Master.

**NOTE** If you use the browser interface to enable the DIP switches (by un-checking the "Disable the Turbo Ring DIP switch" checkbox), and then flip DIP switch 4 from ON to OFF, the Ring Ports and Coupling Ports that were added to all VLANs will be restored to their previous software settings. (For details, please refer to the "Using Virtual LANs" section of this manual).

# System Monitoring

## Serial Status

### Serial to Network Connection

Go to **Serial to Network Connections** under **Serial Status** to view the operation mode and status of each connection, for each serial port. All monitor functions will refresh automatically every 5 seconds.

Port	OP Mode	Connections
1	Real COM	[ ]
2	Real COM	[ ]
3	Real COM	[ ]
4	Real COM	[ ]

## Serial Port Status

Go to **Serial Port Status** under **Serial Status** to view the current status of each serial port.  
**Serial Port Status → Buffering.**

Port	TxCnt	RxCnt	TxTotalCnt	RxTotalCnt	DSR	DTR	RTS	CTS	DCD
1	0	0	0	0	0	0	0	0	0
2	0	0	0	0	0	0	0	0	0
3	0	0	0	0	0	0	0	0	0
4	0	0	0	0	0	0	0	0	0

Monitor port buffering usage (bytes) of each serial port.

## Serial Port Error Count

Go to **Serial Port Error Count** under **Serial Status** to view the error count for each serial port.

Port	ErrCnt	Frame	Parity	Overrun	Break
1	0	0	0	0	0
2	0	0	0	0	0
3	0	0	0	0	0
4	0	0	0	0	0

**Frame:** Framing error indicates that the received character did not have a valid stop bit.

**Parity:** Parity error indicates that the received data character does not match the parity selected.

**Overrun:** The NPort is unable to hand received data to a hardware buffer because the input rate exceeds the NPort’s ability to handle the data.

**Break:** Break interrupt indicates that the received data input was held low for longer than a full-word transmission time. A full-word transmission time is defined as the total time to transmit the start, data, parity, and stop bits.

## Serial Port Settings

Go to **Serial Port Settings** under **Serial Status** to view a summary of the settings for each serial port.

Port	Baud Rate	Data Bits	Stop Bits	Parity	Flow Control	XON/XOFF	FIFO	Interface
1	115200	8	1	None	RTS/CTS	XON/XOFF	Enable	RS-232
2	115200	8	1	None	ON	OFF	Enable	RS-232
3	115200	8	1	None	ON	OFF	Enable	RS-232
4	115200	8	1	None	ON	OFF	Enable	RS-232

# System Status

## System Information

**MOXA®** Total Solution for NPort S8000 Series Device Server

- Model: - NPort S8455I-MM-SC
- Name: - NPort S8455I-MM-SC\_22112
- Location: -
- IP: - 192.168.127.254
- Serial NO.: - 22112

**System information** ?

Auto refresh

**Power 1** **Power 2**

**Index** **DI**

**DIP Switch status**

**DIP 1** **DIP 2** **DIP 3** **DIP 4**

**Main Menu**

- Overview
- Basic Settings
- Serial Settings
- Ethernet Settings
- Ethernet Advanced Settings
- System Management
- System Monitoring
- Serial Status
- System Status
- System Information**
- Event Log
- Ethernet Status

This page illustrate the status of system

Light	Status	Default
Power	Lighting when power is NO	blind
DI	Lighting when triggered	blind
DIP Switch	Lighting when DIP switch Set to ON	blind

## Network Connections

Go to **Network Connections** under System Status to view network connection information.

**MOXA®** Total Solution for NPort S8000 Series Device Server www.moxa

- Model: - NPort S8455I-MM-SC
- Name: - NPort S8455I-MM-SC\_00018
- Location: -
- IP: - 192.168.127.254
- Serial NO.: - 18
- MAC Address: - 00.90.E9.00.00.28
- Firmware: - V1.2 build 09042213

**Network Connections** ?

Protocol	Recv-Q	Send-Q	Local address	Foreign address	State
TCP	0	1136	192.168.127.254.80	192.168.127.100.3959	ESTAB
TCP	0	0	192.168.127.254.443	**	LISTEN
TCP	0	0	192.168.127.254.80	**	LISTEN
TCP	0	0	192.168.127.254.953	**	LISTEN
TCP	0	0	192.168.127.254.969	**	LISTEN
TCP	0	0	192.168.127.254.952	**	LISTEN
TCP	0	0	192.168.127.254.952	**	LISTEN
TCP	0	0	192.168.127.254.968	**	LISTEN
TCP	0	0	192.168.127.254.951	**	LISTEN
TCP	0	0	192.168.127.254.967	**	LISTEN
TCP	0	0	192.168.127.254.950	**	LISTEN
TCP	0	0	192.168.127.254.966	**	LISTEN
TCP	0	0	192.168.127.254.4900	**	LISTEN
TCP	0	0	192.168.127.254.23	**	LISTEN

**Main Menu**

- Overview
- Basic Settings
- Serial Settings
- Operation Modes
- Serial Parameters
- Serial ToS
- Ethernet Settings
- Ethernet Advanced Settings
- System Management
- System Monitoring
- Serial Status
- System Status
- System Information



## Event Log

Bootstrap	This field shows how many times the NPort S8000 has been rebooted or cold started.
Date	The date is updated based on how the current date is set in the "Basic Setting" page.
Time	The time is updated based on how the current time is set in the "Basic Setting" page.
System Startup Time	The system startup time related to this event.
Events	Events that have occurred.

**NOTE** The following events will be recorded into the NPort S8000's Event Log table:

1. Cold start
2. Warm start
3. Configuration change activated
4. Power 1/2 transition (Off ( On), Power 1/2 transition (On ( Off)
5. Authentication fail
6. Topology changed
7. Master setting is mismatched
8. DI 1/2 transition (Off ( On), DI 1/2 transition (On ( Off)
9. Port traffic overload
10. dot1x Auth Fail
11. Port link off / on

## Ethernet Status

### MAC Address List

This section explains the information provided by the NPort S8000's MAC address table.

The MAC Address table can be configured to display the following NPort S8000 MAC address groups.

ALL	Select this item to show all NPort S8000 MAC addresses
ALL Learned	Select this item to show all NPort S8000 Learned MAC addresses
ALL Static Lock	Select this item to show all NPort S8000 Static Lock MAC addresses
ALL Static	Select this item to show all NPort S8000 Static/Static Lock /Static Multicast MAC addresses
ALL Static Multicast	Select this item to show all NPort S8000 Static Multicast MAC addresses
Port ( 1-5)	Select this item to show all MAC addresses of dedicated ports

The table will display the following information:

MAC	This field shows the MAC address
Type	This field shows the type of this MAC address
Port	This field shows the port that this MAC address belongs to

## IGMP Table

The NPort S8000 displays the current active IGMP groups that were detected.

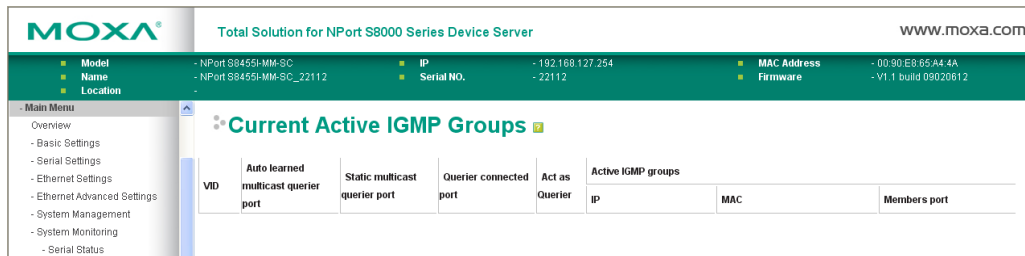

The information includes **VID**, **Auto-learned Multicast Router Port**, **Static Multicast Router Port**, **Querier Connected Port**, and the **IP** and **MAC** addresses of active IGMP groups.

## GMRP Table

The NPort S8000 displays the current active GMRP groups that were detected.

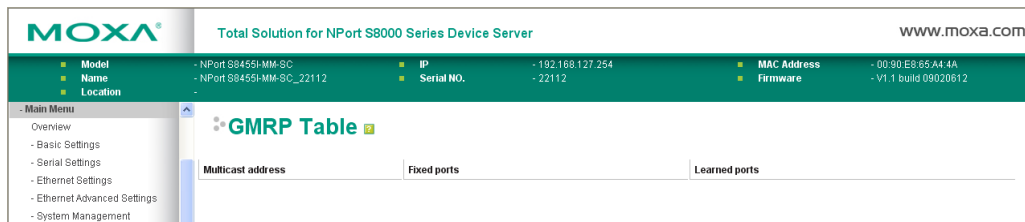

Setting	Description
Fixed Ports	This multicast address is defined by static multicast.
Learned Ports	This multicast address is learned by GMRP.

### 802.1X Reauth

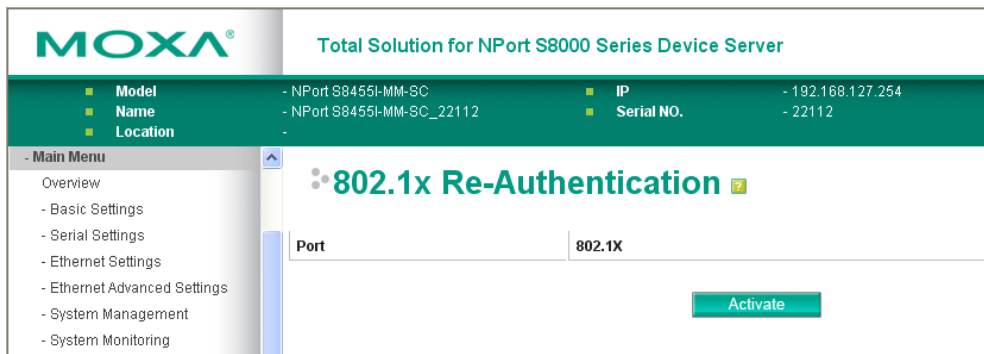

The NPort S8000 can force connected devices to be re-authorized manually.

### Port Access Control Table

The port status will indicate whether the access is authorized or unauthorized.



### Warning List

Use this table to see if any relay alarms have been issued.

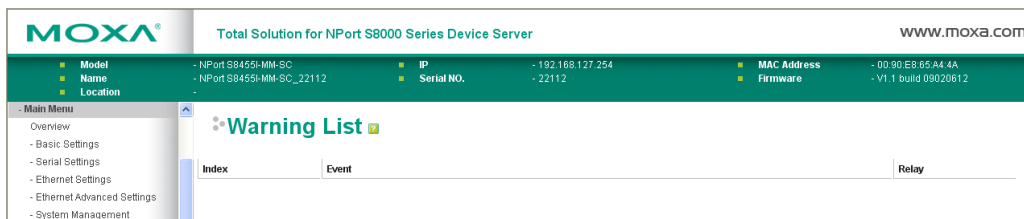

### Ethernet Monitor

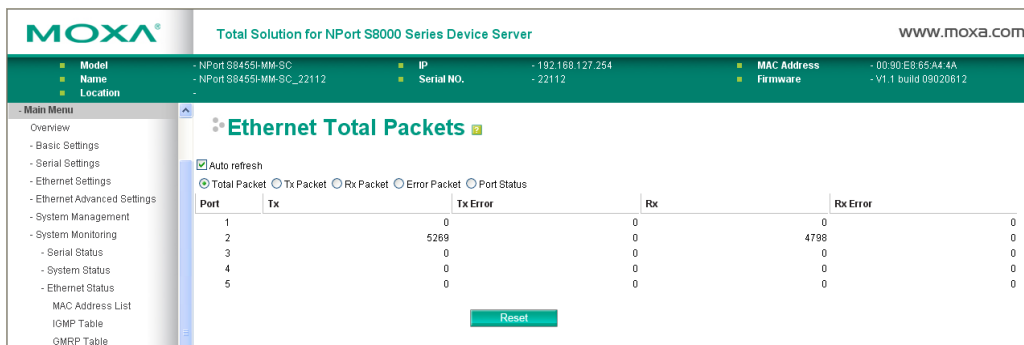

This page illustrates the data transmission status of Ethernet. Check one of the four options, Total Packets, TX Packets, RX Packets, or Error Packets, to show the transmission activity of specific types of packets.

Check the Port Status to show the status of Ethernet port.

## Trunk Table



Setting	Description
Trunk Group	Displays the Trunk Type and Trunk Group.
Member Port	Display which member ports belong to the trunk group.
Status	Success means port trunking is working properly. Fail means port trunking is not working properly. Standby means port trunking is working as a standby port. When there are more than eight ports trunked as a trunking group, the 9th port will be the standby port.

## VLAN Table

In the 802.1Q VLAN table, you can review the VLAN groups that were created, Joined Access Ports, and Trunk Ports. In the Port-based VLAN table, you can review the VLAN group and Joined port.

### VLAN Table

<b>VLAN Mode</b>			
VLAN mode	802.1Q VLAN		
<b>Management VLAN</b>			
Management VLAN	1		
<b>Current 802.1Q VLAN List</b>			
Index	VID	Joined access port	Joined trunk port
1	1	1, 2, 3, 4, 5,	

**NOTE** The physical network can have a maximum of 64 VLAN settings.

## Communication Redundancy Status

This page shows the status of communication redundancy.

### RSTP

### Communication Redundancy Status

<b>Current Status</b>	
Now active	None
Root/Not root	---
Port 1	---
Port 2	---
Port 3	---
Port 4	---
Port 5	---

**Explanation of “Current Status” Items**

**Now Active**

Shows which communication protocol is in use: **Turbo Ring, Turbo Ring V2, RSTP**

**Ring 1/2–Status**

Shows **Healthy** if the ring is operating normally, and shows **Break** if the ring’s backup link is active.

**Ring 1/2–Master/Slave**

Indicates whether or not this NPort S8000 is the Master of the Turbo Ring. (This field appears only when selected to operate in Turbo Ring or Turbo Ring V2 mode.)

Now active	Indicate the in used communication protocol. It may be Turbo Ring, Turbo Ring V2, RSTP, or none.
Root/Not root	Available when Redundancy protocol is set to RSTP mode. Indicate NPort S8000 is in the Root of the Spanning Tree. (The root is determined automatically).
Port 1 / Port 2 Port 3 / Port 4 Port 5	Indicates the current Spanning Tree status of these ports. "Forwarding" for normal transmission "Blocking" to block transmission.

**Turbo Ring**

**Communication Redundancy Status**

<b>Current Status</b>	
<b>Now active</b>	<b>Turbo Ring</b>
<b>Master/Slave</b>	<b>Master</b>
<b>Redundant ports status</b>	1st Port <b>Link down</b> 2nd Port <b>Link down</b>
<b>Ring coupling ports status</b>	<b>Disabled</b>
<b>Coupling port</b>	---
<b>Coupling control port</b>	---

Now active	Indicate the in used communication protocol. It may be Turbo Ring, Turbo Ring V2, RSTP, or none.	
Master/Slave	Indicate NPort S8000 is in the Master mode or Slave mode of the Turbo Ring.	
Redundant Ports Status	Link down	No connection
	Blocked	This port is connected to a backup path and the path is blocked
	Forwarding	Normal transmission
	Learning	Learning
Ring Coupling Ports Status	Enable or disable	
Coupling Port	Indicate which port is used to be coupling port (port 1 to port 5). Available when Ring Coupling in communication redundancy setting page is enabled	
Coupling Control Port	Indicate which port is used to be coupling control port (port 1 to port 5). Available when Ring Coupling in communication redundancy setting page is enabled	

## Turbo Ring 2

### Communication Redundancy Status ?

<b>Current Status</b>	
Now active	Turbo Ring V2
<b>Ring 1</b>	
Status	Break
Master/Slave	Master
1st ring port status	Link down
2nd ring port status	Link down
<b>Ring 2</b>	
Status	--
Master/Slave	--
1st ring port status	--
2nd ring port status	--
<b>Coupling</b>	
Mode	none
Coupling port status	Primary Port-- Backup Port--

Now Active	Indicate the in used communication protocol. It may be Turbo Ring, Turbo Ring V2, RSTP, or none.	
<b>Ring 1/2</b>		
Status	Healthy	The ring is operating normally
	Break	The backup link is active in the Ring.
Master/Slave	Indicate NPort S8000 is in the Master mode or Slave mode of the Turbo Ring 2.	
1st/2nd Ring Port Status	Link down	No connection
	Blocked	This port is connected to a backup path and the path is blocked
	Forwarding	Normal transmission
	Learning	Learning
Coupling Mode	Indicates current coupling mode It may be None, Dual Homing, or Ring Coupling.	
Coupling Port status	Indicate which port is used to be coupling port (port 1 to port 5). Available when Ring Coupling in communication redundancy setting page is enabled	

## Restart

### Restart System

Go to **Restart System** under **Restart** and then click **Restart** to restart the NPort S8000. Ensure that you save all your configuration changes before you restart the system or else these changes will be lost.

Total Solution for NPort S8000 Series Device Server

<b>Model</b>	- NPort S8455I-MM-8C	<b>IP</b>	- 192.168.127.254
<b>Name</b>	- NPort S8455I-MM-8C_22112	<b>Serial NO.</b>	- 22112
<b>Location</b>	-		

### Restart System ?

This function will restart MOXA NPort S8455I-MM-8C

Activate

**Main Menu**

- Overview
- Basic Settings
- Serial Settings
- Ethernet Settings
- Ethernet Advanced Settings
- System Management

## Restart Serial Port

Go to **Restart Ports** under **Restart** and then select the ports to be restarted. Click **Select All** to select all the ports. Click **Submit** to restart the selected ports.

The screenshot shows the MOXA web interface for an NPort S8000 Series Device Server. At the top, the MOXA logo is on the left, and the text 'Total Solution for NPort S8000 Series Device Server' is on the right. Below this is a table with system information:

Model	- NPort S8455I-MM-SC	IP	- 192.168.127.254
Name	- NPort S8455I-MM-SC_22112	Serial NO.	- 22112
Location	-		

On the left side, there is a 'Main Menu' with the following items: Overview, Basic Settings, Serial Settings, Ethernet Settings, Ethernet Advanced Settings, System Management, and System Monitoring. The main content area is titled 'Restart Serial Ports' with a help icon. Below the title, it states: 'This function will restart MOXA NPort S8455I-MM-SC serial ports'. There are four checkboxes for 'Port 1', 'Port 2', 'Port 3', and 'Port 4', all of which are currently unchecked. Below these is a checkbox for 'Apply the above settings to all serial ports', which is also unchecked. An 'Activate' button is located at the bottom right of the configuration area.

# A

## Pinouts and Cable Wiring

---

In this appendix, we cover the following topics.

▣ **Port Pinout Diagrams**

- Ethernet Port Pinouts
- Serial Port Pinouts

▣ **Cable Wiring Diagrams**

- Ethernet Cables



# Port Pinout Diagrams

## Ethernet Port Pinouts

Pin	Signal
1	Tx+
2	Tx-
3	Rx+
6	Rx-

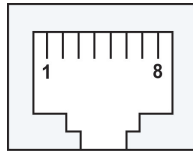

## Serial Port Pinouts

### DB9 Male RS-232 Port Pinouts

Pin	RS-232 Signal
1	DCD (in)
2	RxD (in)
3	TxD (out)
4	DTR (out)
5	GND
6	DSR (in)
7	RTS (out)
8	CTS (in)
9	-

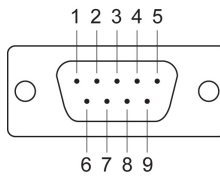

### Serial Console Port Pinouts

Pin	RJ45
1	DCD
2	DSR
3	RTS
4	N.C.
5	Tx
6	Rx
7	GND
8	CTS
9	DTR
10	N.C.

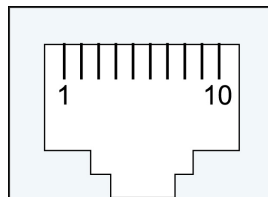

# Cable Wiring Diagrams

## Ethernet Cables

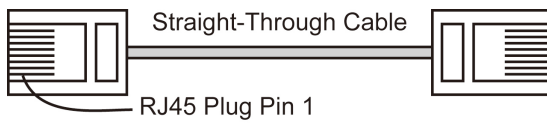

**Cable Wiring**

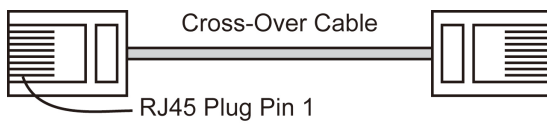
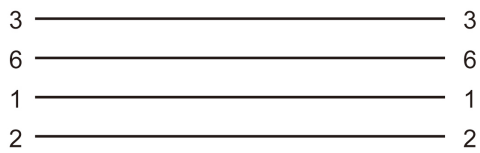

**Cable Wiring**

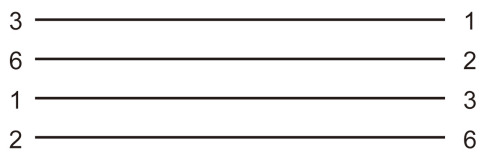

# B

## Well-Known Port Numbers

---

This appendix is for your reference about the Well Known port numbers that may cause network problem if you set the NPort into the same port. Refer to RFC 1700 for Well Known port numbers or refer to the following introduction from the IANA.

The port numbers are divided into three ranges: the Well-known Ports, the Registered Ports, and the Dynamic and/or Private Ports.

The Well-known Ports are those from 0 through 1023.

The Registered Ports are those from 1024 through 49151.

The Dynamic and/or Private Ports are those from 49152 through 65535.

The Well-known Ports are assigned by the IANA, and on most systems, can only be used by system processes or by programs executed by privileged users. The following table shows famous port numbers among the well-known port numbers. For more details, please visit the IANA website:

<http://www.iana.org/assignments/port-numbers>

UDP Socket	Application Service
0	reserved
2	Management Utility
7	Echo
9	Discard
11	Active Users (sysstat)
13	Daytime
35	Any private printer server
39	Resource Location Protocol
42	Host name server (names server)
43	Whois (nickname)
49	(Login Host Protocol) (Login)
53	Domain Name Server (domain)
69	Trivial Transfer Protocol (TFTP)
70	Gopher Protocol
79	Finger Protocol
80	World Wide Web HTTP
107	Remote Telnet Service
111	Sun Remote Procedure Call (Sunrpc)
119	Network News Transfer Protocol (NNTP)
123	Network Time Protocol (ntp)
161	SNMP (Simple Network Mail Protocol)
162	SNMP Traps
213	IPX (Used for IP Tunneling)

TCP Socket	Application Service
0	reserved
1	TCP Port Service Multiplexor
2	Management Utility
7	Echo
9	Discard
11	Active Users (sysstat)
13	Daytime
15	Netstat
20	FTP data port
21	FTP CONTROL port
23	Telnet
25	SMTP (Simple Mail Transfer Protocol)
37	Time (Time Server)
42	Host name server (names server)
43	Whois (nickname)
49	(Login Host Protocol) (Login)
TCP Socket	Application Service
53	Domain Name Server (domain)
79	Finger protocol (Finger)
80	World Wide Web HTTP
119	Network News Transfer Protocol (NNTP)
123	Network Time Protocol
213	IPX
160 – 223	Reserved for future use

# SNMP Agents with MIB II & RS-232 Like Groups

The NPort S8000 has built-in SNMP (Simple Network Management Protocol) agent software. The following table lists the proprietary MIB-II group, as well as the variable implementation for the NPort S8000.

## Moxa-NPort S8000-MIB

overview	basicSetting	portSetting	ethernetSetting
ModelName	generalSettings	opModeSetting	portSettings
SerialNumber	serverName	opMode	portTable
FirmwareVersion	serverLocation	opModePortTable	portEntry
MacAddress	serverDescription	opModePortEntry	portIndex_Eth
Uptime	maintainerContactInfo	portIndex	portEnable
ViewIpAddr	timeSetting	portMode	portDesc
	sysDateTime	application	portName
	daylightSaving	realcom	portSpeed
	startMonth	realComTable	portFDXFlowCtrl
	startWeek	realComEntry	portMDI
	startDay	realcomMaxConnection	
	startHour	realcomAllowDriverControl	portTrunking
	endMonth	realcomConnectionDownRTS	trunkSettingTable
	endWeek	realcomConnectionDownDTR	trunkSettingEntry
	endDay	rfc2217	trunkSettingIndex
	endHour	rfc2217Table	trunkType
	offsetHours	rfc2217Entry	trunkMemberPorts
	timeZone	rfc2217TcpPort	
	timeServer1	tcpServer	commRedundancy
	timeServer2	tcpServerTable	protocolOfRedundancySetup
	calibratePeriod	tcpServerEntry	spanningTree
	networkSettings	tcpServerInactivityTime	spanningTreeBridgePriority
	autoIPConfig	tcpServerMaxConnection	spanningTreeHelloTime
	serverIpAddr	tcpServerAllowDriverControl	spanningTreeMaxAge
	subMask	tcpServerTcpServerConnectionD ownRTS	spanningTreeForwardingDelay
	gateway	tcpServerTcpServerConnectionD ownDTR	spanningTreeTable
	dnsServer1IPAddr	tcpServerTcpPort	spanningTreeEntry
	dnsServer2IPAddr	tcpServerCmdPort	spanningTreeIndex
	tcpAliveChkTime	tcpClient	enableSpanningTree
		tcpClientTable	spanningTreePortPriority
		tcpClientEntry	spanningTreePortCost
		tcpClientInactivityTime	turboRing
		tcpClientDestinationAddress1	turboRingMasterSetup
		tcpClientDestinationPort1	turboRingRdntPort1

<b>overview</b>	<b>basicSetting</b>	<b>portSetting</b>	<b>ethernetSetting</b>
		tcpClientDestinationAddress2	turboRingRdntPort2
		tcpClientDestinationPort2	turboRingEnableCoupling
		tcpClientDestinationAddress3	turboRingCouplingPort
		tcpClientDestinationPort3	turboRingControlPort
		tcpClientDestinationAddress4	turboRingV2
		tcpClientDestinationPort4	turboRingV2Ring1
		tcpClientDesignatedLocalPort1	ringIndexRing1
		tcpClientDesignatedLocalPort2	ringEnableRing1
		tcpClientDesignatedLocalPort3	masterSetupRing1
		tcpClientDesignatedLocalPort4	rdnt1stPortRing1
		tcpClientConnectionControl	rdnt2ndPortRing1
		udp	turboRingV2Ring2
		udpTable	ringIndexRing2
		udpEntry	ringEnableRing2
		udpDestinationAddress1Begin	masterSetupRing2
		udpDestinationAddress1End	rdnt1stPortRing2
		udpDestinationPort1	rdnt2ndPortRing2
		udpDestinationAddress2Begin	turboRingV2Coupling
		udpDestinationAddress2End	couplingEnable
		udpDestinationPort2	couplingMode
		udpDestinationAddress3Begin	coupling1stPort
		udpDestinationAddress3End	coupling2ndPort
		udpDestinationPort3	
		udpDestinationAddress4Begin	rateLimiting
		udpDestinationAddress4End	rateLimitingTable
		udpDestinationPort4	rateLimitingEntry
		udpLocalListenPort	limitMode
		dataPacking	lowPriLimitRate
		dataPackingPortTable	normalPriLimitRate
		dataPackingPortEntry	mediumPriLimitRate
		portPacketLength	highPriLimitRate
		portDelimiter1Enable	
		portDelimiter1	lineSwapFastRecovery
		portDelimiter2Enable	lineSwapRecovery
		portDelimiter2	
		portDelimiterProcess	
		portForceTransmit	
		comParamSetting	
		comParamPortTable	
		comParamPortEntry	
		portAlias	
		portBaudRate	
		portDataBits	
		portStopBits	
		portParity	
		portFlowControl	
		portFIFO	
		portInterface	
		portBaudRateManual	
		serialTosSetting	

overview	basicSetting	portSetting	ethernetSetting
		serialTosTable	
		serialTosEntry	

ethernetAdvSetting	systemManagement
trafficPrioritization	miscNetwork
qosClassification	accessibleIP
queuingMechanism	enableAccessibleIP
qosPortTable	accessibleIpEntry
qosPortEntry	accessibleIpIndex
inspectTos	accessibleIpAddress
inspectCos	accessibleIpNetMask
portPriority	syslogSetting
cosMapping	syslogServer1
cosMappingTable	syslogServer1port
cosMappingEntry	syslogServer2
cosTag	syslogServer2port
cosMappedPriority	syslogServer3
tosMapping	syslogServer3port
tosMappingTable	portAccessControl
tosMappingEntry	staticPortLock
tosClass	staticPortLockAddress
tosMappedPriority	staticPortLockPort
vlan	staticPortLockStatus
vlanType	dot1x
managementVlanId	dataBaseOption
vlanPortSettingTable	radiusServer
vlanPortSettingEntry	radiusPort
portVlanType	radiusSharedKey
portDefaultVid	dot1xReauthEnable
portFixedVid	dot1xReauthPeriod
portForbiddenVid	dot1xSettingTable
portbaseVlanSettingEntry	dot1xSettingEntry
portbaseVlanSettingIndex	enableDot1X
portbaseVlanMemberPorts	autoWarming
multicastFiltering	emailAlert
igmpSnooping	emailWarningMailServer
enableGlobalIgmpSnooping	emailWarningFromEmail
querierQueryInterval	emailWarningFirstEmailAddr
igmpSnoopingSettingTable	emailWarningSecondEmailAddr
igmpSnoopingSettingEntry	emailWarningThirdEmailAddr
enableIgmpSnooping	emailWarningFourthEmailAddr
enableQuerier	snmpAgent
fixedMulticastQuerierPorts	snmpReadCommunity
staticMulticast	trapServerAddr1
staticMulticastTable	snmpTrapCommunity1
staticMulticastEntry	trap2ServerAddr
staticMulticastIndex	snmpTrap2Community
staticMulticastAddress	emailWarningEventType
staticMulticastPorts	emailWarningEventServerColdStart
staticMulticastStatus	emailWarningEventServerWarmStart
gmrp	emailWarningEventPowerOn2Off
gmrpSettingTable	emailWarningEventPowerOff2On

<b>ethernetAdvSetting</b>	<b>systemManagement</b>
gmrpSettingEntry	emailWarningEventDiTable
enableGMRP	emailWarningEventDiEntry
setDeviceIp	emailWarningEventDiInputOn2Off
setDevIpTable	emailWarningEventDiInputOff2On
setDevIpEntry	emailWarningEventConfigChange
setDevIpIndex	emailWarningEventAuthFail
setDevIpCurrentIpofDevice	emailWarningEventTopologyChanged
setDevIpPresentBy	emailWarningEventSerialPortTable
setDevIpDedicatedIp	emailWarningEventSerialPortEntry
	emailWarningEventSerailDCDChange
	emailWarningEventSerailDSRChange
	emailWarningEventEthernetPortTable
	emailWarningEventEthernetPortEntry
	emailWarningEventEthernetPortLinkOn
	emailWarningEventEthernetPortLinkOff
	emailWarningEventEthernetPortTrafficOverload
	emailWarningEventEthernetPortTrafficThreshold
	emailWarningEventEthernetPortTrafficDuration
	snmpWarningEventType
	snmpWarningEventServerColdStart
	snmpWarningEventServerWarmStart
	snmpWarningEventPowerOn2Off
	snmpWarningEventPowerOff2On
	snmpWarningEventDiTable
	snmpWarningEventDiEntry
	snmpWarningEventDiInputOn2Off
	snmpWarningEventDiInputOff2On
	snmpWarningEventConfigChange
	snmpWarningEventAuthFail
	snmpWarningEventTopologyChanged
	snmpWarningEventSerailPortTable
	snmpWarningEventSerailPortEntry
	snmpWarningEventSerailDCDchange
	snmpWarningEventSerailDSRchange
	snmpWarningEventEthernetPortTable
	snmpWarningEventEthernetPortEntry
	snmpWarningEventEthernetPortLinkOn
	snmpWarningEventEthernetPortLinkOff
	snmpWarningEventEthernetPortTrafficOverload
	snmpWarningEventEthernetPortTrafficThreshold
	snmpWarningEventEthernetPortTrafficDuration
	relayWarning
	relayWarningTable
	relayWarningEntry
	relayAlarmIndex
	relayWarningRelayContact
	overrideRelayWarningSetting
	relayWarningPower1Off
	relayWarningPower1OffStatus
	relayWarningPower2Off
	relayWarningPower2OffStatus
	relayWarningTurboRingBreak



<b>ethernetAdvSetting</b>	<b>systemManagement</b>
	relayWarningTurboRingBreakStatus
	portRelayWarningTable
	portRelayWarningEntry
	relayWarningLinkChanged
	relayWarningLinkChangedStatus
	relayWarningTrafficOverload
	relayWarningTrafficOverloadStatus
	relayWarningTrafficThreshold
	relayWarningTrafficDuration
	diRelayWarningTable
	diRelayWarningEntry
	relayWarningDiInputChanged
	relayWarningDiInputChangedStatus
	sysLogSettings
	sysLocalLog
	networkLocalLog
	configLocalLog
	opModeLocalLog
	sysRemoteLog
	networkRemoteLog
	configRemoteLog
	opModeRemoteLog
	maintenance
	consoleSetting
	webConsole
	httpConsole
	telnetConsole
	resetButtonFunction
	autoRefresh
	loadFactoryDefault
	loadFactoryDefaultSetting
	mirroring
	targetPort
	monitorDirection
	mirroringPort
	sysFileUpdate
	tftpServer
	confPathName
	firmwarePathName
	logPathName
	dipSwitchSetting
	dipSwitchEnableTurboRing
	dipSwitchTurboRingType

<b>systemMonitoring</b>	<b>restart</b>
serialStatus	restartSystem
s2eConnections	restartPortNumber
monitorRemoteIpTable	
monitorRemoteIpEntry	
remoteIpIndex	
monitorRemoteIp	
serialPortStatus	

<b>systemMonitoring</b>	<b>restart</b>
monitorSerialPortStatusTable	
monitorSerialPortStatusEntry	
monitorTxCount	
monitorRxCount	
monitorTxTotalCount	
monitorRxTotalCount	
monitorDSR	
monitorDTR	
monitorRTS	
monitorCTS	
monitorDCD	
serialPortErrorCount	
monitorSerialPortErrorCountTable	
monitorSerialPortErrorCountEntry	
monitorErrorCountFrame	
monitorErrorCountParity	
monitorErrorCountOverrun	
monitorErrorCountBreak	
serialPortSettings	
monitorSerialPortSettingsTable	
monitorSerialPortSettingsEntry	
monitorBaudRate	
monitorDataBits	
monitorStopBits	
monitorParity	
monitorRTSCTSFlowControl	
monitorXONXOFFFlowControl	
monitorFIFO	
monitorInterface	
systemStatus	
systemInfo	
power1InputStatus	
power2InputStatus	
monitorDiTable	
monitorDiEntry	
diIndex	
diInputStatus	
dipSwitchTurboRingPole	
dipSwitchRingCouplingPole	
dipSwitchRingMasterPole	
eventLog	
eventLogTable	
eventLogEntry	
eventListIndex	
eventListBootup	
eventListData	
eventListTime	
eventListSysUpTime	
eventListEvent	
eventListClear	
ethernetStatus	
macAddressList	

<b>systemMonitoring</b>	<b>restart</b>
igmpstatus	
igmpSnoopingMulticastGroupTable	
igmpSnoopingMulticastGroupEntry	
learnedMulticastQuerierPorts	
igmpSnoopingIpGroup	
igmpSnoopingMacGroup	
igmpSnoopingJoinedPorts	
gmrpStatus	
gmrpTable	
gmrpEntry	
gmrpMulticastGroup	
gmrpFixedPorts	
gmrpLearnedPorts	
dot1XReauth	
dot1xReauthTable	
dot1xReauthEntry	
dot1xReauthPortIndex	
dot1xReauth	
portAccessControlList	
portAccessControlTable	
portAccessControlEntry	
portAccessControlAddress	
portAccessControlPortNo	
portAccessControlAccessStatus	
portAccessControlStatus	
warningList	
warningListTable	
warningListEntry	
warningListIndex	
warningListEvent	
warningListRelay	
ethernetMonitor	
ethernetMonitorTable	
ethernetMonitorEntry	
ethernetMonitorTxTotal	
ethernetMonitorTxUicast	
ethernetMonitorTxMulticast	
ethernetMonitorTxBroadcast	
ethernetMonitorTxCollision	
ethernetMonitorRxTotal	
ethernetMonitorRxUicast	
ethernetMonitorRxMulticast	
ethernetMonitorRxBroadcast	
ethernetMonitorRxPause	
ethernetMonitorTxErr	
ethernetMonitorTxErrLate	
ethernetMonitorTxErrExcessive	
ethernetMonitorRxErr	
ethernetMonitorRxErrCRC	
ethernetMonitorRxErrDiscard	
ethernetMonitorRxErrUndersize	
ethernetMonitorRxErrFragments	

<b>systemMonitoring</b>	<b>restart</b>
ethernetMonitorRxErrOversize	
ethernetMonitorRxErrJabber	
ethernetMonitorReset	
monitorPortTable	
monitorPortEntry	
monitorLinkStatus	
monitorSpeed	
monitorFDXFlowCtrl	
monitorAutoMDI	
monitorConnectedIP	
monitorTraffic	
trunkTableList	
trunkTable	
trunkEntry	
trunkIndex	
trunkPort	
trunkStatus	
vlanList	
vlanTable	
vlanEntry	
vlanId	
joinedAccessPorts	
joinedTrunkPorts	
commRedStatus	
activeProtocolOfRedundancy	
spanningTreeStatus	
spanningTreeRoot	
spanningTreeStatusTable	
spanningTreeStatusEntry	
spanningTreePortStatus	
turboRingStatus	
turboRingMaster	
turboRingPortTable	
turboRingPortEntry	
turboRingPortIndex	
turboRingPortStatus	
turboRingPortDesignatedBridge	
turboRingPortDesignatedPort	
turboRingDesignatedMaster	
turboRingCouplingPortStatus	
turboRingControlPortStatus	
turboRingBrokenStatus	
turboRingV2Status	
turboRingV2Ring1Status	
masterStatusRing1	
designatedMasterRing1	
rdnt1stPortStatusRing1	
rdnt2ndPortStatusRing1	
brokenStatusRing1	
turboRingV2Ring2Status	
masterStatusRing2	
designatedMasterRing2	

<b>systemMonitoring</b>	<b>restart</b>
rdnt1stPortStatusRing2	
rdnt2ndPortStatusRing2	
brokenStatusRing2	
turboRingV2CouplingStatus	
coupling1stPortStatus	
coupling2ndPortStatus	

# Switch MIB Groups

---

The NPort S8000 comes with built-in SNMP (Simple Network Management Protocol) agent software that supports cold/warm start trap, line up/down trap, and RFC 1213 MIB-II.

The standard MIB groups supported by the NPort S8000 are:

## **MIB II.1 – System Group**

sysORTable

## **MIB II.2 – Interfaces Group**

ifTable

## **MIB II.4 – IP Group**

ipAddrTable  
ipNetToMediaTable  
IpGroup  
IpBasicStatsGroup  
IpStatsGroup

## **MIB II.5 – ICMP Group**

IcmpGroup  
IcmpInputStatus  
IcmpOutputStats

## **MIB II.6 – TCP Group**

tcpConnTable  
TcpGroup  
TcpStats

## **MIB II.7 – UDP Group**

udpTable  
UdpStats

## **MIB II.10 – Transmission Group**

dot3  
dot3StatsTable

## **MIB II.11 – SNMP Group**

SnmpBasicGroup  
SnmpInputStats  
SnmpOutputStats

## **MIB II.17 – dot1dBridge Group**

dot1dBase  
dot1dBasePortTable  
dot1dStp  
dot1dStpPortTable  
dot1dTp  
dot1dTpFdbTable  
dot1dTpPortTable

```
dot1dTpHCPortTable
dot1dTpPortOverflowTable
pBridgeMIB
dot1dExtBase
dot1dPriority
dot1dGarp
qBridgeMIB
dot1qBase
dot1qTp
dot1qFdbTable
dot1qTpPortTable
dot1qTpGroupTable
dot1qForwardUnregisteredTable
dot1qStatic
dot1qStaticUnicastTable
dot1qStaticMulticastTable
dot1qVlan
dot1qVlanCurrentTable
dot1qVlanStaticTable
dot1qPortVlanTable
```

The NPort S8000 also provides a private MIB file, located in the file "Moxa-NPort S8000-MIB.my" or "Moxa-NPort S8000-MIB.my" on the NPort S8000 Series utility CD-ROM.

### Public Traps:

1. Cold Start
2. Link Up
3. Link Down
4. Authentication Failure
5. dot1dBridge New Root
6. dot1dBridge Topology Changed

### Private Traps:

1. Configuration Changed
2. Power On
3. Power Off
4. Traffic Overloaded
5. Turbo Ring Topology Changed
6. Turbo Ring Coupling Port Changed
7. Turbo Ring Master Mismatch

### System Events

1. System cold start
2. System warm start
3. Power transition(On->Off)
4. Power transition(Off->On)
5. DI 1 (Off)
6. DI 1 (On)
7. DI 2 (Off)
8. DI 2 (On)
9. Config. change
10. Auth. failure
11. Comm. redundancy topology changed

**Serial Port Events**

1. DCD changed
2. DSR changed

**Ethernet Port Events**

1. Link-ON
2. Link-OFF
3. Traffic-Overload
4. Traffic-Threshold(%)
5. Traffic-Duration(s)



## Compliance Note

---

This product complies with Chinese RoHS (Restriction of Hazardous Substances) regulations for Electronic Information Products.



### **CE Warning**

This is a Class A product. In a domestic environment, this product may cause radio interference in which case the user may be required to take appropriate measures.

### **Federal Communications Commission Statement**

FCC – This device complies with part 15 of the FCC Rules. Operation is subject to the following two conditions: (1) This device may not cause harmful interference, and (2) this device must accept any interference received, including interference that may cause undesired operation.



### **FCC Warning**

This equipment has been tested and found to comply with the limits for a Class A digital device, pursuant to part 15 of the FCC Rules. These limits are designed to provide reasonable protection against harmful interference when the equipment is operated in a commercial environment. This equipment generates, uses, and can radiate radio frequency energy and, if not installed and used in accordance with the instruction manual, may cause harmful interference to radio communications. Operation of this equipment in a residential area is likely to cause harmful interference in which case the user will be required to correct the interference at his or her own expense.