

PCI Express Board User's Manual

Edition 11.2, October 2017

www.moxa.com/product

MOXA[®]

© 2017 Moxa Inc. All rights reserved.

PCI Express Board User's Manual

The software described in this manual is furnished under a license agreement and may be used only in accordance with the terms of that agreement.

Copyright Notice

© 2017 Moxa Inc. All rights reserved.

Trademarks

The MOXA logo is a registered trademark of Moxa Inc.
All other trademarks or registered marks in this manual belong to their respective manufacturers.

Disclaimer

Information in this document is subject to change without notice and does not represent a commitment on the part of Moxa.

Moxa provides this document as is, without warranty of any kind, either expressed or implied, including, but not limited to, its particular purpose. Moxa reserves the right to make improvements and/or changes to this manual, or to the products and/or the programs described in this manual, at any time.

Information provided in this manual is intended to be accurate and reliable. However, Moxa assumes no responsibility for its use, or for any infringements on the rights of third parties that may result from its use.

This product might include unintentional technical or typographical errors. Changes are periodically made to the information herein to correct such errors, and these changes are incorporated into new editions of the publication.

Technical Support Contact Information

www.moxa.com/support

Moxa Americas

Toll-free: 1-888-669-2872
Tel: +1-714-528-6777
Fax: +1-714-528-6778

Moxa Europe

Tel: +49-89-3 70 03 99-0
Fax: +49-89-3 70 03 99-99

Moxa India

Tel: +91-80-4172-9088
Fax: +91-80-4132-1045

Moxa China (Shanghai office)

Toll-free: 800-820-5036
Tel: +86-21-5258-9955
Fax: +86-21-5258-5505

Moxa Asia-Pacific

Tel: +886-2-8919-1230
Fax: +886-2-8919-1231

Table of Contents

1. Introduction	1-1
Overview	1-2
PCI Express Solution	1-2
ESD Protection	1-2
ADDC™ (Automatic Data Direction Control) for RS-485	1-2
Operating System Support	1-2
Moxa Serial Comm Tool	1-3
Intelligent RS-485	1-3
Applications	1-3
Features	1-3
Package Checklist	1-3
Installation Flowchart	1-4
2. Hardware Installation	2-1
CP-118EL-A Dimensions	2-2
CP-168EL-A Dimensions	2-2
CP-104EL-A Dimensions	2-3
CP-102E Dimensions	2-3
CP-102EL Dimensions	2-4
CP-132EL Dimensions	2-4
CP-132EL-I Dimensions	2-5
CP-114EL Dimensions	2-5
CP-114EL-I Dimensions	2-6
CP-116E-A Dimensions	2-6
CP-134EL-A-I Dimensions	2-7
CP-118E-A-I/138E-A-I Dimensions	2-7
Plugging the Board into an Expansion Slot	2-8
3. Software Installation	3-1
Windows Drivers	3-2
Windows 2000, 2003/ XP/ Vista/ 2008 (x86/x64), 7/8 /8.1/ 10 (x86/x64), Server 2008 R2/ 2012/ 2012 R2/ 2016 (x64)	3-3
Non-Windows Drivers	3-11
DOS	3-11
Linux (32-bit/64-bit)	3-14
SCO	3-15
4. Configuring Intelligent RS-485	4-1
Windows Users	4-2
Linux Users	4-5
5. Serial Programming Tools	5-1
Moxa PComm	5-2
Installing PComm	5-2
PComm Programming Library	5-2
Utilities	5-2
Diagnostics (for Moxa boards only)	5-2
Monitor (for Moxa boards for Windows 2000/XP/2003/Vista/2008/7(x86 and x64)	5-3
Terminal Emulator	5-4
RS-485 Programming	5-4
ADDC™	5-4
6. Programming Guide	6-1
Relative Product List	6-2
Resource Requirement for Moxa Board	6-2
PCI Configuration for Moxa Board	6-2
UART Register Structure for MU860 chip	6-3
UART Register Structure for MUE250, MUE450, and MUE850 chips	6-4
For Baud Rate Setting	6-5
Moxa Board PCI Device ID List	6-6
UART Datasheet	6-6
7. Pin Assignments	7-1
PCIe Board Accessories Table	7-2
CP-118EL-A	7-2
Board Side Pin Assignments-Female SCSI VHDCI68	7-3
Device Side Pin Assignments	7-4
CP-168EL-A	7-5
Board Side Pin Assignments-Female SCSI VHDCI68	7-5
Device Side Pin Assignments	7-5
CP-104EL-A	7-6
Board Side Pin Assignments-Female DB44	7-6

Device Side Pin Assignments	7-7
CP-102E	7-7
Board Side Pin Assignments-Male DB9	7-7
CP-102EL.....	7-8
Board Side Pin Assignments—Female DB25	7-8
Device Side Pin Assignments	7-8
CP-132EL/CP-132EL-I	7-9
Board Side Pin Assignments—Female DB25	7-9
Device Side Pin Assignments	7-9
CP-114EL/CP-114EL-I	7-10
Board Side Pin Assignments—Female DB44	7-10
Device Side Pin Assignments	7-11
CP-118E-A-I/CP-138E-A-I.....	7-12
Board Side Pin Assignments—Female DB78	7-12
Device Side Pin Assignments—Male DB9	7-14
Male DB25 (CBL-M78M25x8-100).....	7-14
CP134EL-A-I	7-15
Board Side Pin Assignments—Female DB44	7-15
Device Side Pin Assignments—Male DB9	7-16
Male DB25 (CBL-M44M25x4-50).....	7-16
CP-116E-A	7-17
Board Side Pin Assignments—Female SCSI VHDCI68	7-17
Device Side Pin Assignments—Male DB9	7-17
Male DB25 (OPT8B+ / CBL-M68M25x8-100)	7-17
Female DB25 (OPT8A+/S+).....	7-18
8. Troubleshooting	8-1
A. Product Specifications.....	A-1
CP-118EL-A Specifications	A-2
CP-168EL-A Specifications	A-3
CP-104EL-A Specifications	A-4
CP-102E Specifications	A-5
CP-102EL Specifications	A-6
CP-132EL Series Specifications	A-7
CP-114EL Series Specifications	A-8
CP-118E-A-I Specifications	A-9
CP-138E-A-I Specifications	A-10
CP-134EL-A-I Specifications.....	A-11
CP-116E-A Specifications.....	A-12

Introduction

Moxa's PCI Express serial boards meet the new slot standard for expansion boards and work with any PCI Express slots. The boards have multiple RS-232/422/485 serial ports to connect data acquisition equipment and other serial devices to a PC.

The following topics are covered in this chapter:

□ Overview

- PCI Express Solution
- ESD Protection
- ADDC™ (Automatic Data Direction Control) for RS-485
- Operating System Support
- Moxa Serial Comm Tool
- Intelligent RS-485

□ Applications

□ Features

□ Package Checklist

□ Installation Flowchart

Overview

Moxa's new PCI Express Multiport Serial Boards are designed for POS and ATM applications and for use by industrial automation system manufacturers and system integrators. The boards are compatible with all popular operating systems, and each of them supports data rates of up to 921.6 kbps and provides full modem control signals, ensuring compatibility with a wide range of serial peripherals. In addition, all models work with PCI Express x1, allowing the boards to be installed in any available PCI Express slot (including x1, x2, x4, x8, x16, x32).

PCI Express Solution

The boards comply with PCI Express Spec. 1.1. The ports' transmission parameters are configured after the boards are installed. The PCI BIOS automatically assigns the IRQ and I/O addresses. For this reason, you must plug the boards into the computer before installing the drivers. For more information about PCI Express, refer to the "Technical Reference" appendix.

ESD Protection

The PCI Express boards come with 15 kV ESD protection built in to prevent damage to the boards from lightning or high potential voltage. The surge protection feature makes the PCI Express boards suitable for industrial, factory-type applications, and for use with applications that are subject to severe weather conditions.

ADDC™ (Automatic Data Direction Control) for RS-485

RS-485 uses differential data transmission over two wires to transmit data from one station to another, and allows multiple transmitters and receivers to be used on the same data line. RS-485 uses half-duplex transmission, which means that transmission and reception share the same data channels. For this reason, only one transmitter can be active at any given time.

Moxa's serial boards have a built-in circuitry to switch transmitters on and off automatically. We call this form of switching ADDC® (Automatic Data Direction Control). ADDC® is much easier to implement than the traditional handshaking method that uses the RTS signal.

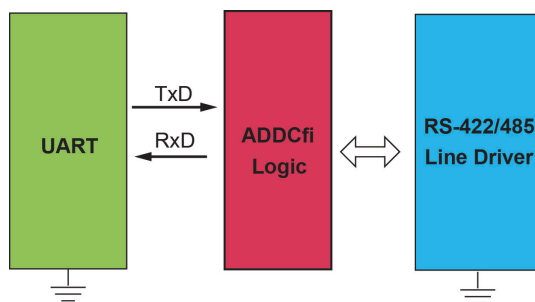

Operating System Support

The PCI Express boards are compatible with all major industrial platforms, including Windows, Windows CE, DOS, Linux, and SCO. Moxa device drivers are provided for smoother installation, configuration, and performance.

Visit Moxa's website at www.moxa.com to download the latest drivers and user's manuals for all of Moxa's products.

Moxa Serial Comm Tool

For application development, Moxa provides an easy-to-use serial communication library called PComm that runs under Windows NT/95/98/2000/XP/2003. Use this library to develop your own applications with Visual Basic, Visual C++, Borland Delphi, to name a few. Utilities such as Data Scope, Monitor, Terminal Emulator, and Diagnostics are included to make it easier to debug, monitor communication status, provide terminal emulation, and transfer files.

Intelligent RS-485

With Intelligent RS-485, you only need one click to automatically tune the Pull High/Low and Termination resistors and get your system ready to go!

Applications

The PCI Express boards are suitable for many different applications, including:

- Internet/Intranet Connections
- Remote Access
- Multi-user Applications
- Industrial Automation
- Office Automation
- Telecommunications
- PC-based Vending Machines and Kiosks
- POS (Point-of-Sale) Systems

Features

The PCI Express boards have the following outstanding features:

- PCI Express ×1 compliant
- Low-profile board for compact-sized PCs
- Data flow LED display onboard
- 128-byte FIFO and on-chip H/W, S/W flow control
- 50 bps to 921.6 kbps transmission speed
- Embedded 15 kV ESD surge protection
- Drivers are provided for Windows, Windows CE, Windows XP Embedded, DOS, Linux (32-bit/64-bit), SCO

Package Checklist

The following items are included in the PCI Express board package:

- PCI Express serial board
- Low-profile bracket
- Documentation and Software CD-ROM
- Quick Installation Guide

NOTE Please notify your sales representative if any of the above items are missing or damaged.

Installation Flowchart

The following flowchart provides a brief summary of the procedure you should follow to install the PCI Express boards, and it provides references to chapters with more detailed information:

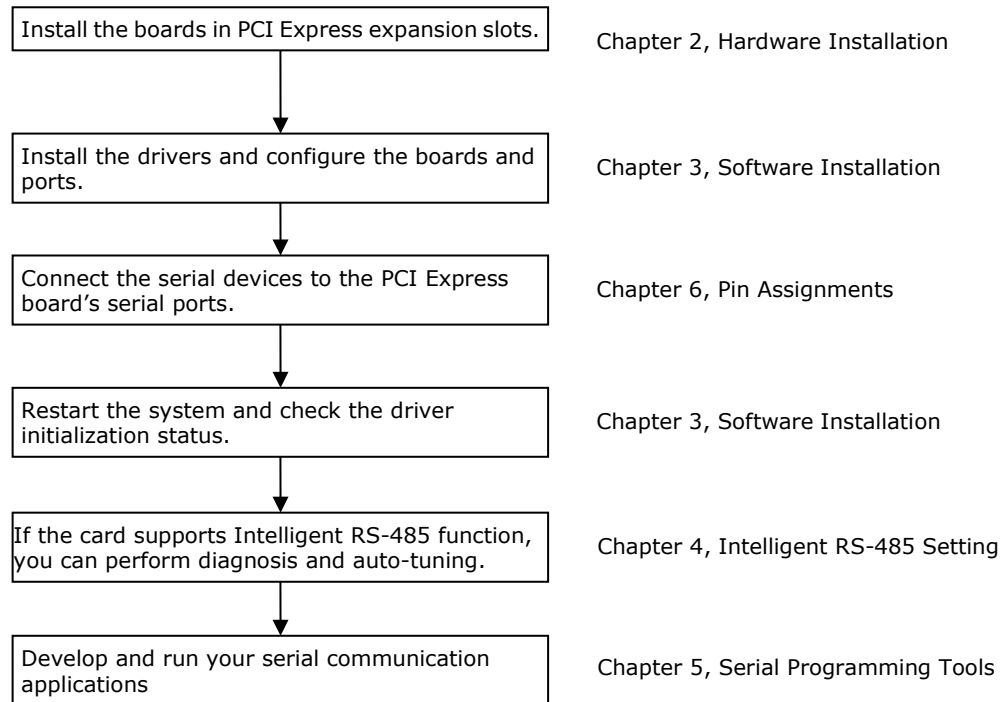

Hardware Installation

In this chapter, we show the dimensions diagrams of all of the boards in the PCI Express Series and describe the hardware installation procedure. Since the BIOS automatically assigns the PCI Express board's IRQ number and I/O addresses, you must plug in the board before installing the driver (driver installation is discussed in Chapter 3).

The following topics are covered in this chapter:

- ❑ **CP-118EL-A Dimensions**
- ❑ **CP-168EL-A Dimensions**
- ❑ **CP-104EL-A Dimensions**
- ❑ **CP-102E Dimensions**
- ❑ **CP-102EL Dimensions**
- ❑ **CP-132EL Dimensions**
- ❑ **CP-132EL-I Dimensions**
- ❑ **CP-114EL Dimensions**
- ❑ **CP-114EL-I Dimensions**
- ❑ **CP-116E-A Dimensions**
- ❑ **CP-134EL-A-I Dimensions**
- ❑ **CP-118E-A-I/138E-A-I Dimensions**
- ❑ **Plugging the Board into an Expansion Slot**

CP-118EL-A Dimensions

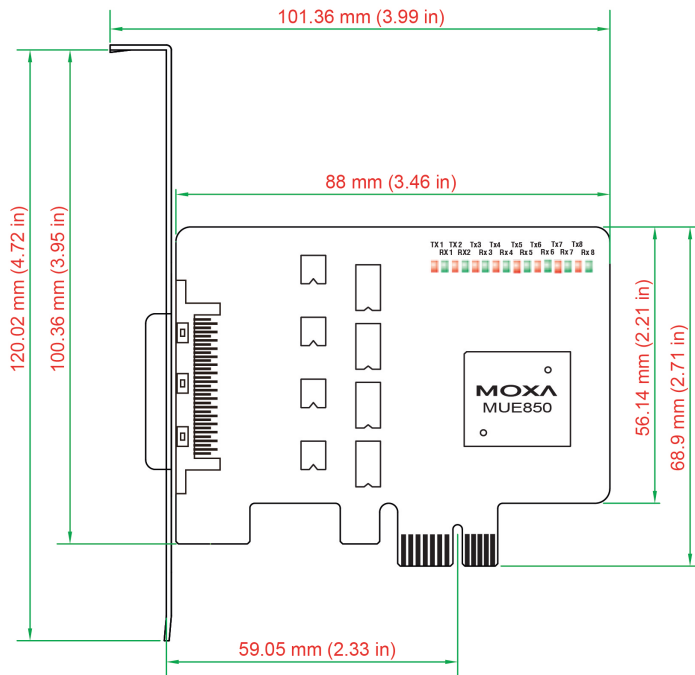

CP-168EL-A Dimensions

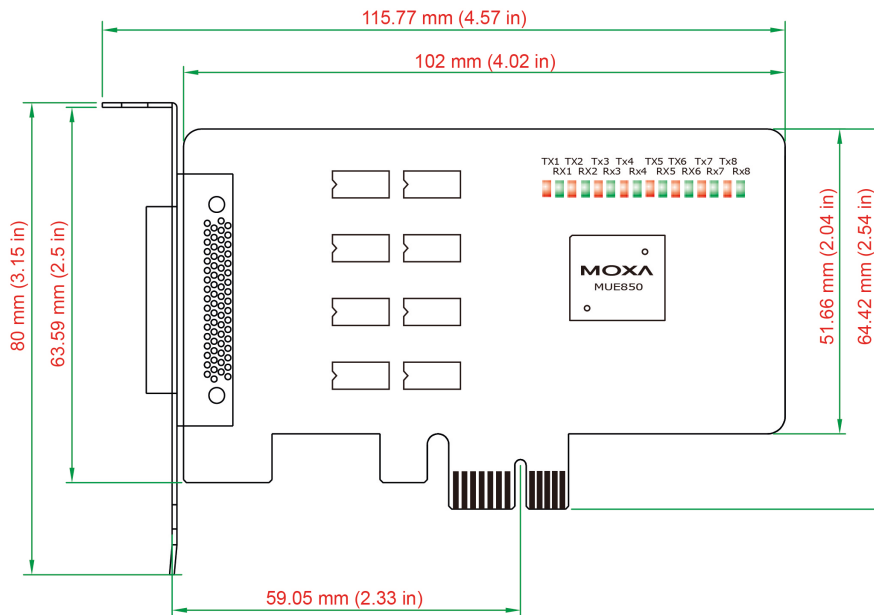

CP-104EL-A Dimensions

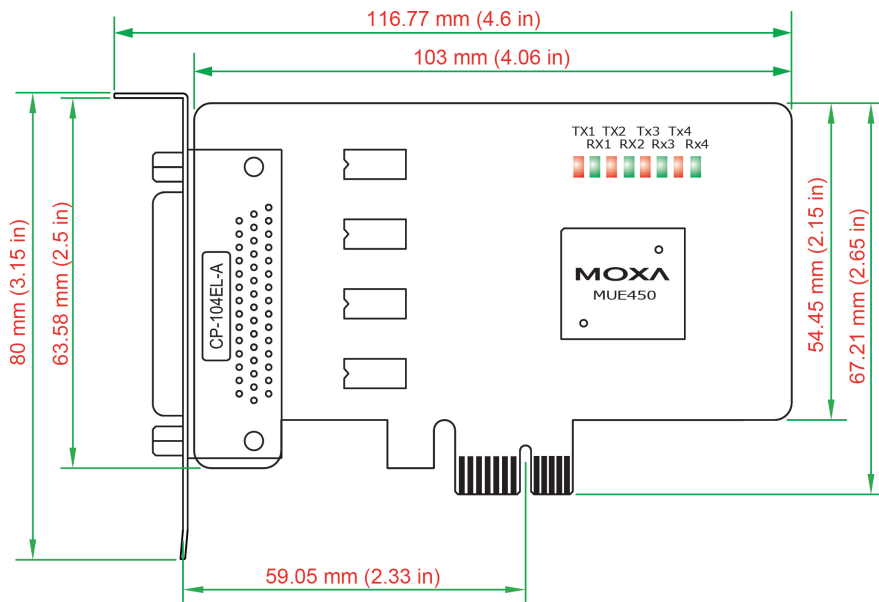

CP-102E Dimensions

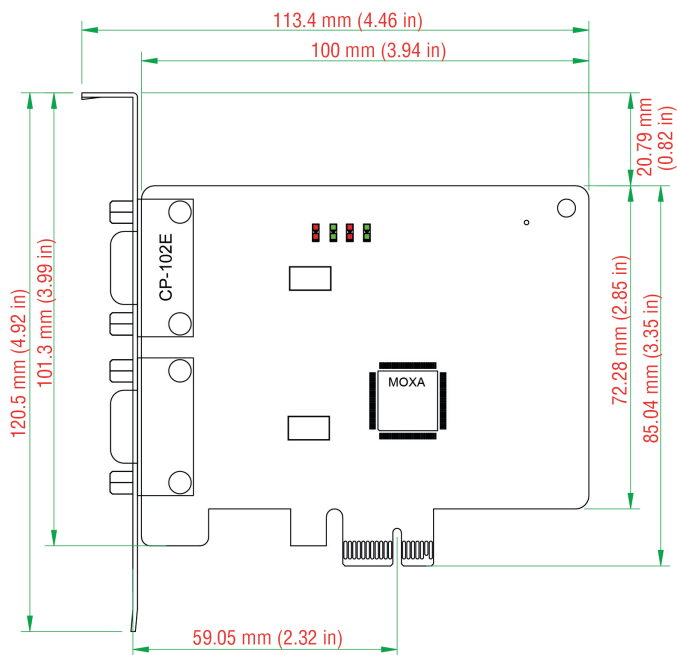

CP-102EL Dimensions

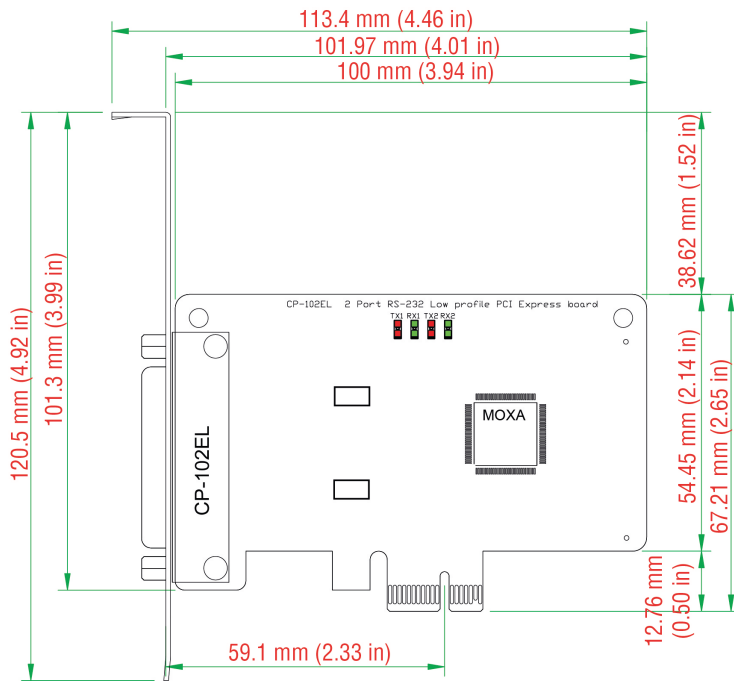

CP-132EL Dimensions

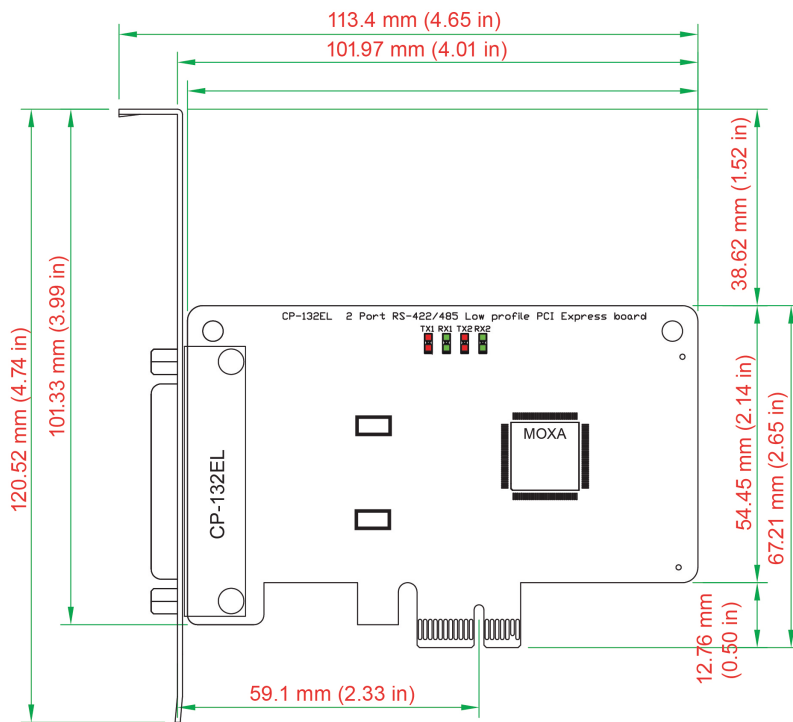

CP-132EL-I Dimensions

CP-114EL Dimensions

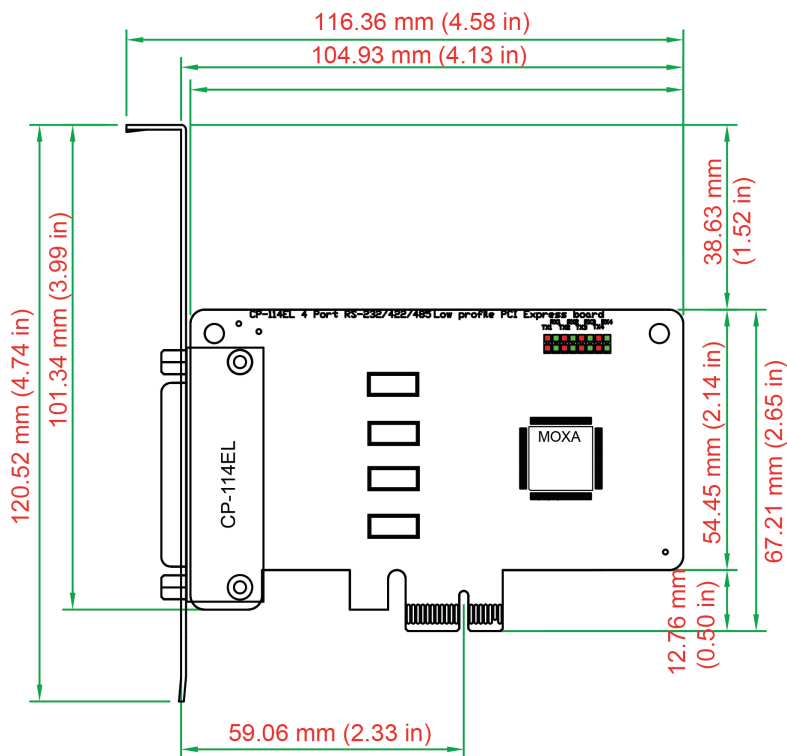

CP-114EL-I Dimensions

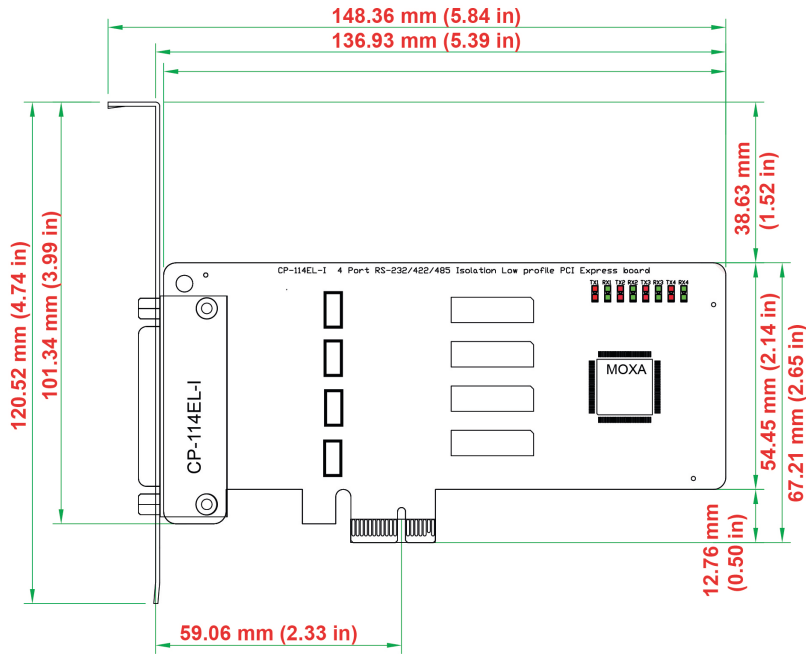

CP-116E-A Dimensions

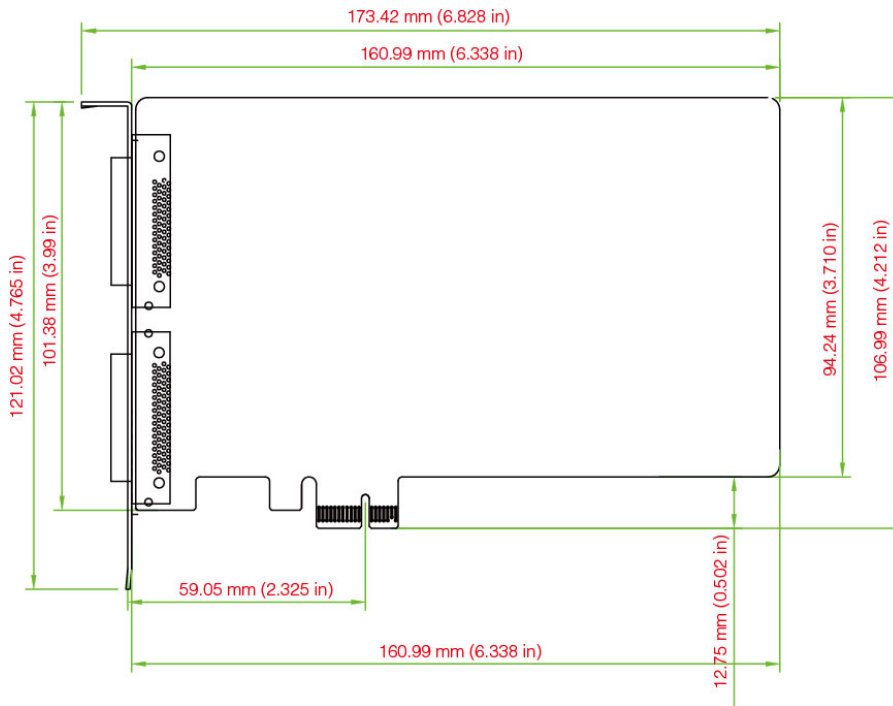

CP-134EL-A-I Dimensions

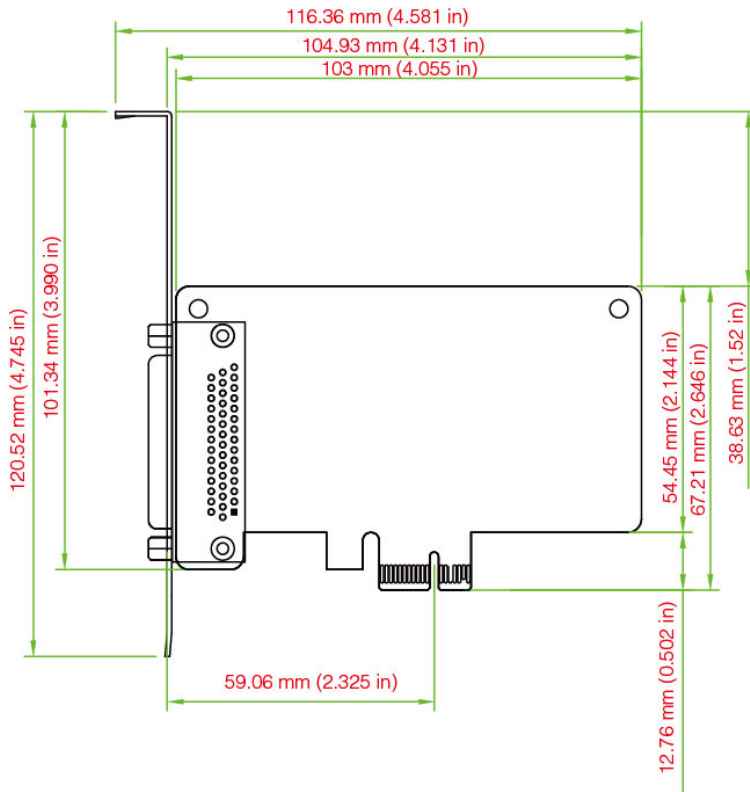

CP-118E-A-I/138E-A-I Dimensions

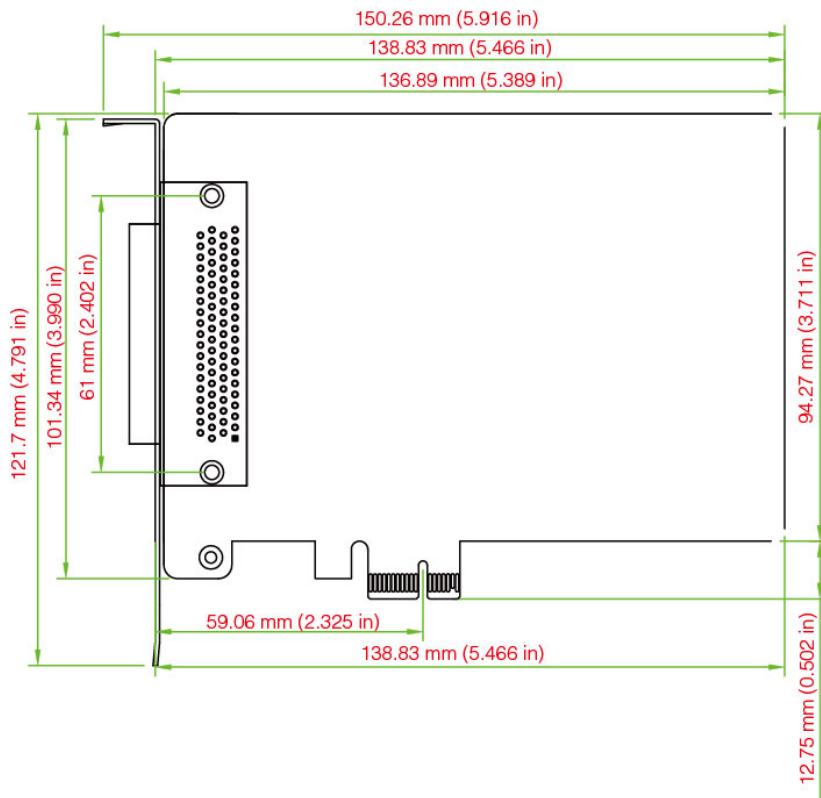

Plugging the Board into an Expansion Slot

Step 1: Power off the PC.



WARNING

To avoid damaging your system and board, make sure you turn off your computer before installing the board.

Step 2: Remove the PC's cover.

Step 3: Remove the slot cover bracket if there is one.

Step 4: Plug the PCI Express board firmly into a free PCI Express slot.

Step 5: Fasten the holding screw to fix the control board in place.

Step 6: Replace the PC's cover.

Step 7: Power on the PC. The BIOS will automatically set the IRQ and I/O address.

NOTE Each Moxa PCI Express board uses one unique IRQ and I/O address, both of which are assigned automatically by the PCI BIOS.

Step 8: Proceed with the software installation discussed in the next chapter, "Software Installation."

Software Installation

In this chapter, we give installation, configuration, and update/removal procedures for the driver for Windows 2000, Windows 2003/XP/Vista/2008 (32-bit/64-bit), Windows 7/8/8.1/10 (32-bit/64-bit), Windows Server 2008 R2/2012/2012 R2/2016 (x64), DOS, Linux (32-bit/64-bit), SCO, and WinCE 5.0. Before proceeding with the software installation, complete the hardware installation discussed in the previous chapter, "Hardware Installation."

Refer to the next chapter, "Serial Programming Tools," for information about developing your own serial programming applications. Note that you can install up to 8 PCI Express boards in one system, provided sufficient I/O address and IRQ number resources are available.

You can download the drivers from the Moxa website.

The following topics are covered in this chapter:

❑ Windows Drivers

- Windows 2000, 2003/ XP/ Vista/ 2008 (x86/x64), 7/8 /8.1/ 10 (x86/x64), Server 2008 R2/ 2012/ 2012 R2/ 2016 (x64)

❑ Non-Windows Drivers

- DOS
- Linux (32-bit/64-bit)
- SCO

Windows Drivers

Moxa provides drivers that allow you to use the PCI Express Series serial boards for various Windows platforms.

The overall procedure for installing the Windows drivers for the PCI Express boards is summarized in the flowchart on the right.

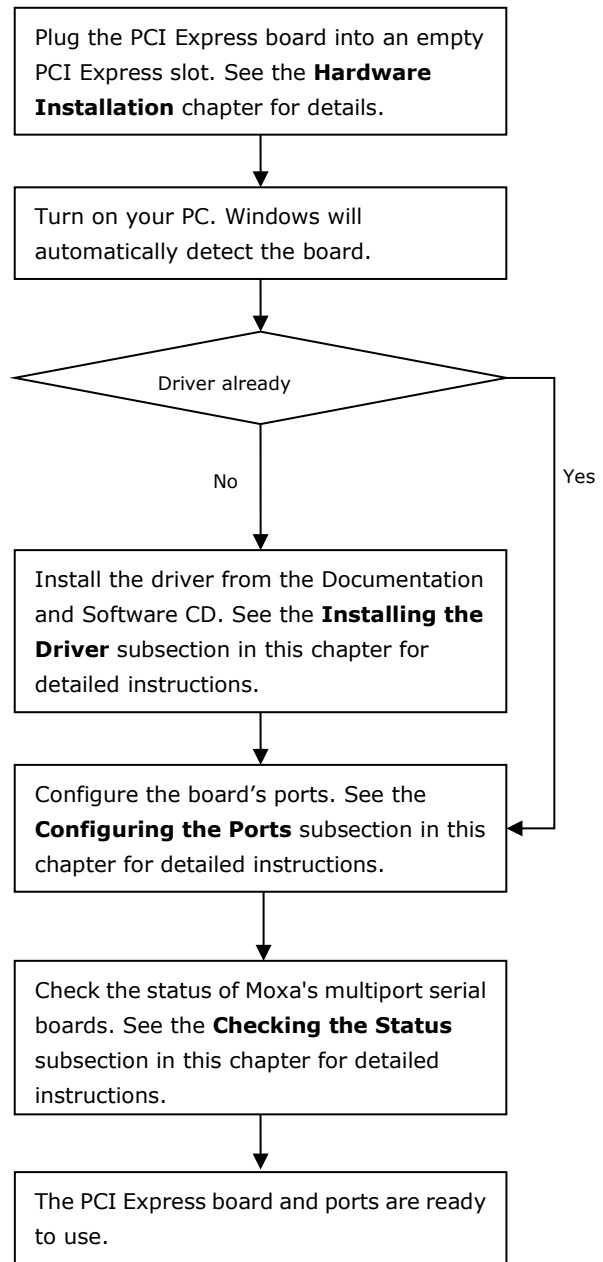

Windows 2000, 2003/ XP/ Vista/ 2008 (x86/x64), 7/8 /8.1/ 10 (x86/x64), Server 2008 R2/ 2012/ 2012 R2/ 2016 (x64)

This section includes the following topics:

- Installing the Driver
- Configuring the Ports
- Checking the Status
- Removing the Driver
- Uninstalling the Driver

We will take Window 7 (x64) as an example. Its procedure is similar to the other Windows platforms with regard to installing, configuring, checking the port status, removing, or uninstalling the PCI Express cards.

Installing the Driver

In this section, we describe how to install the PCI Express cards for the first time with Windows 7. First, make sure that you have already plugged the board or boards into the system's PCI Express slot(s).

NOTE If you have already installed Moxa's PCI Express board in your computer, and you are installing additional boards, Windows 7 will automatically detect and install the new board(s) the next time you boot up the computer. In this case, proceed directly to the next section, "Configuring the Ports," to configure the ports' serial transmission parameters.

Second, you may download the drivers at www.moxa.com. Based on the OS type, choose the corresponding driver.

Follow the following procedures to install the driver.

1. The Setup Wizard will open. Click **Next** to begin installing the driver.

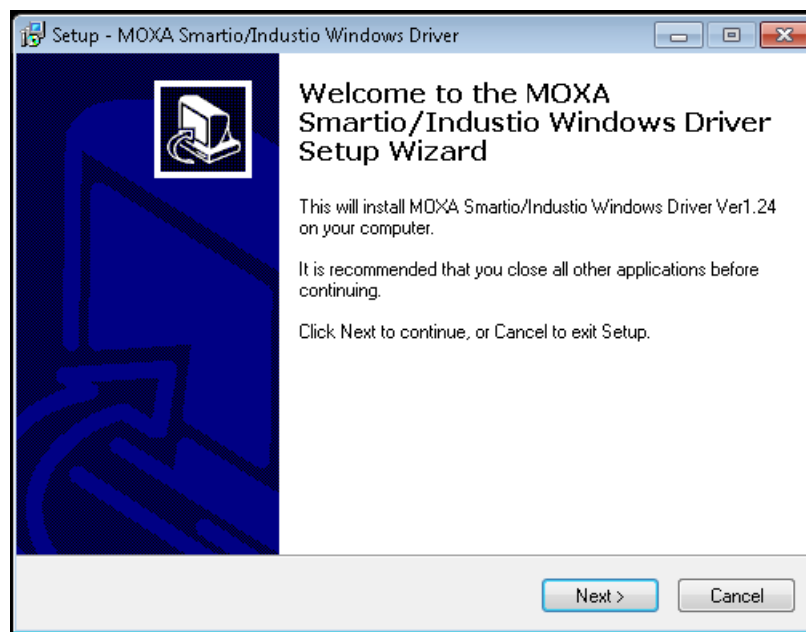

2. Please read the license agreement. If you agree, please click **Next** to move on.

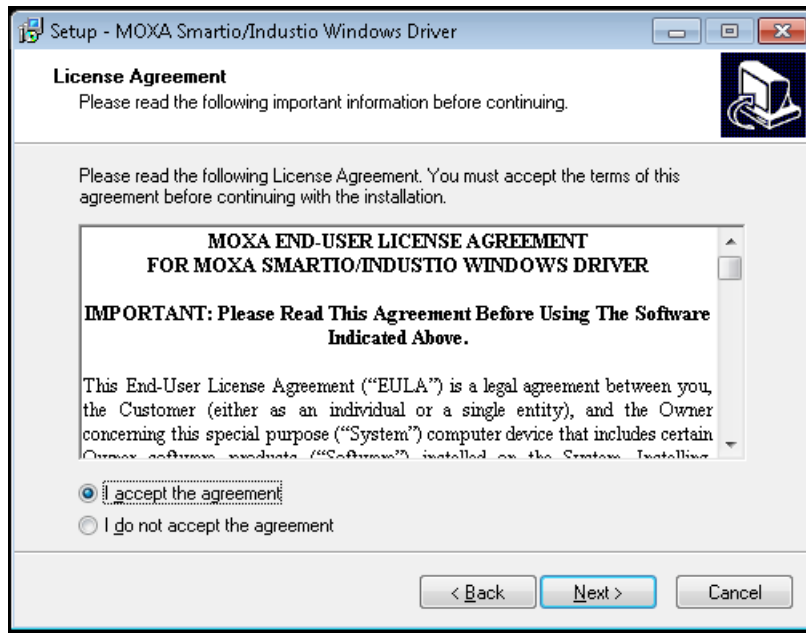

3. Click **Next** to install the driver in the indicated folder, or use the drop-down menu to locate a different folder.

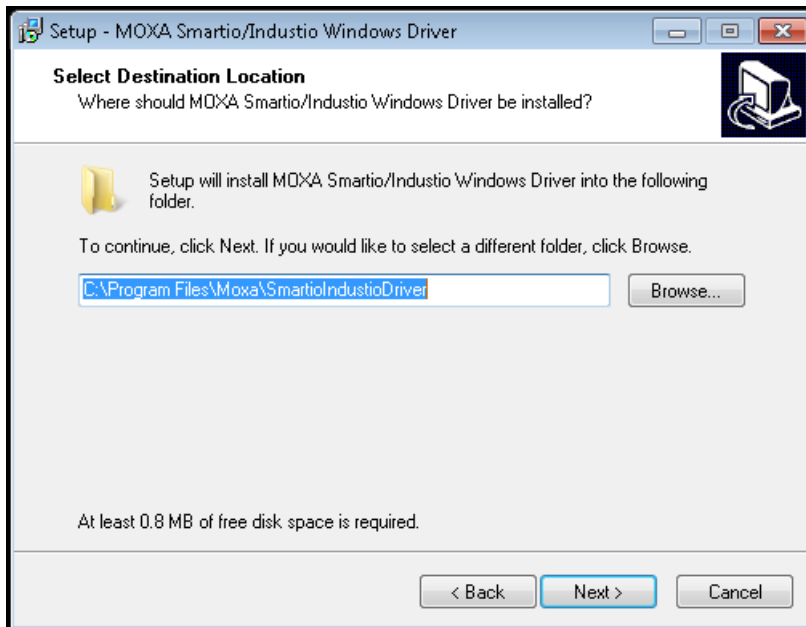

4. Click **Install** to proceed with the installation.

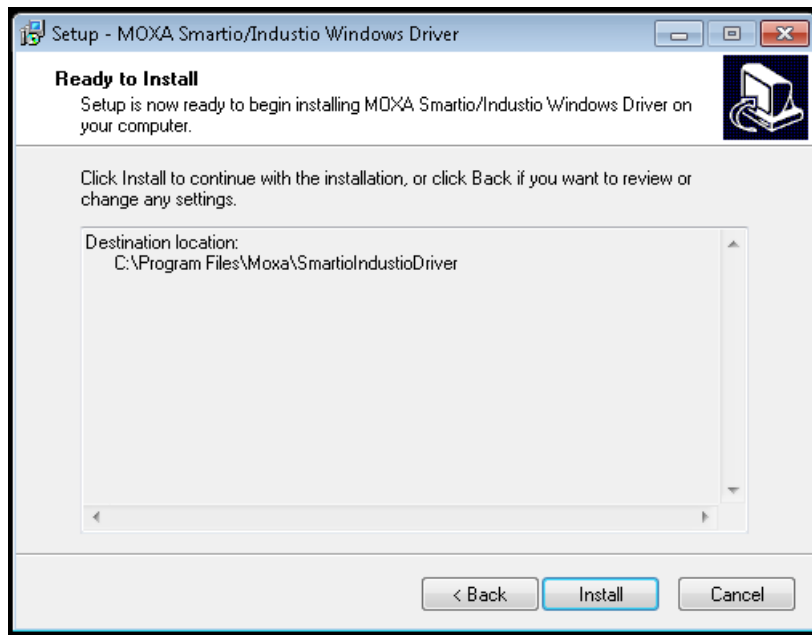

5. Click **Finish** to complete the installation of the driver.

Configuring the Ports

After the driver has been installed, use the Device Manager to configure the serial port of your PCI Express cards (the CP-114EL will be used as an example). In this section, we describe how to access MOXA Smartio/Industio Window Driver and lead you to do the serial port configuration.

- ❑ **Accessing MOXA Smartio/Industio Window Driver**
- ❑ **Configuring Serial Port**
 - Port Number
 - Rx, TX FIFO
 - Interface and Termination Resistor

Accessing MOXA Smartio/Industio Window Driver

Expand the Multi-port serial adapters tab, right click **CP-114EL Series (PCI Express Bus)**, and then click Properties to open the board’s configuration panel.

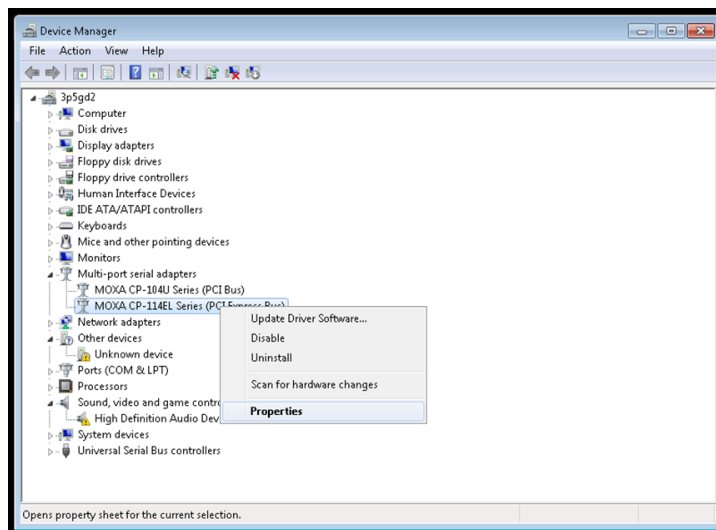

Configuring Serial Port

Port Number

1. Click the port you would like to configure to highlight it and then click **Port Setting**.

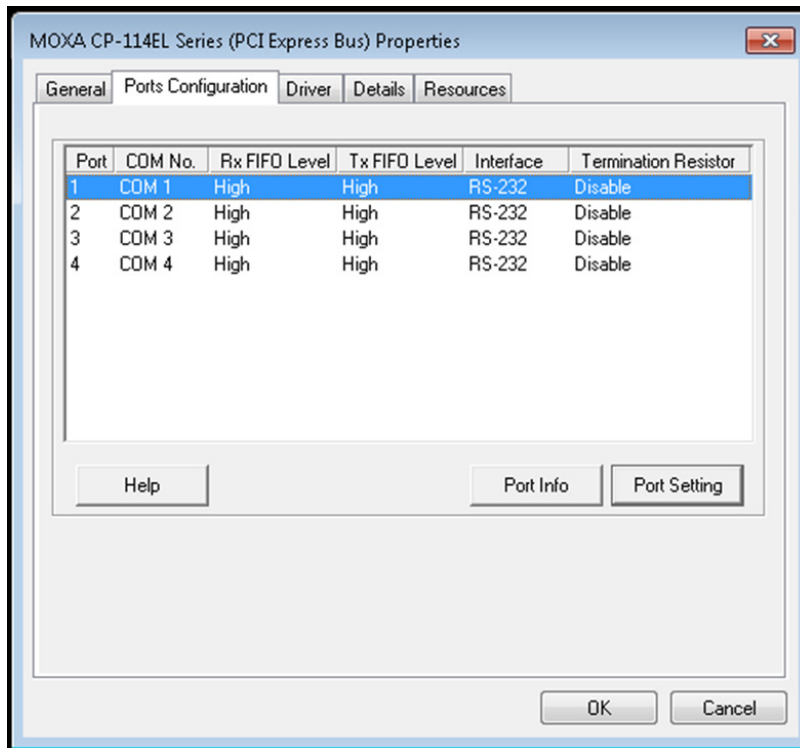

2. Select a COM number for the port from the Port Number pull-down list. Select the **Auto Enumerating COM Number** option to map subsequent ports automatically. The port numbers will be assigned in sequence. For example, if COM 1 is assigned to Port 1, then COM 2 (if not already occupied) will be assigned to Port 2, etc.

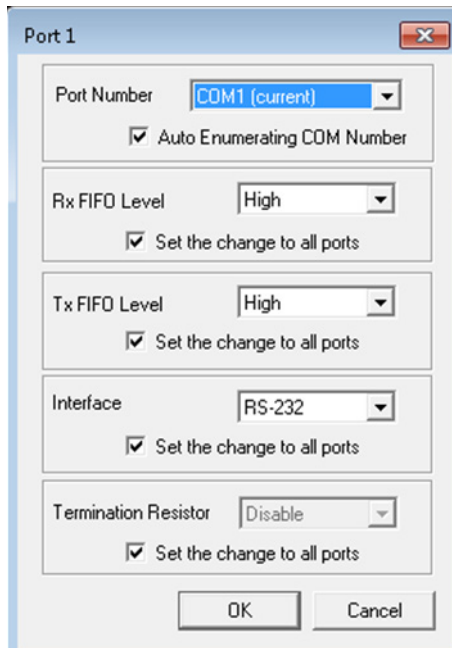

Rx, TX FIFO

1. Select an Rx FIFO Trigger from the Rx FIFO Level pull-down list. Rx FIFO trigger levels of High, Middle, and Low are available, with the default set at High (120 bytes). Select the **Set the change to all ports** option to apply this Rx FIFO Trigger to all ports.

2. Select a Tx FIFO Level from the Tx FIFO Level pull-down list. Tx FIFO Levels of High, Middle, and Low are available, with the default set at High (128 bytes). Select the **Set the change to all ports** option to apply the just defined Tx FIFO Size to all ports.

	Tx FIFO (Byte)	Rx FIFO (Byte)
High	128	120
Middle	64	60
Low	1	1

Interface and Termination Resistor

If you are using CP-118EL-A, CP-114EL, CP-114EL-I, CP-132EL, or CP-132EL-I, select Interface (RS-232, RS-422, RS-485-2W, or RS-485-4W) and Termination Resistor (120Ω, Enable, or Disable) for configuration. For illustration purposes, we use the CP -114EL.

The following figure shows the settings for configuring the port for RS-422 and disabling Termination Resistor.

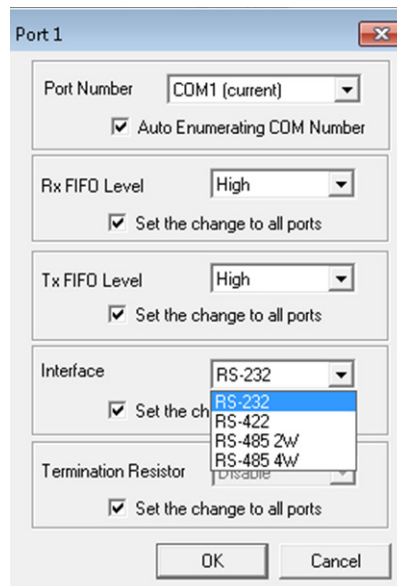

2. Click **OK** to save the port settings and then click **OK** in the Property window to finish the port settings procedure.

Checking the Status

The PComm Diagnostic program is a useful tool for checking the status of Moxa’s multiport serial boards. The program can be used to test internal and external IRQ, TxD/RxD, UART, CTS/RTS, DTR/DSR, etc. Use this program to ensure that your Moxa boards and ports are working properly.

To start the program, click **Start→ Programs→ MOXA→ PComm Lite Version 1.X→ PComm Diagnostic**

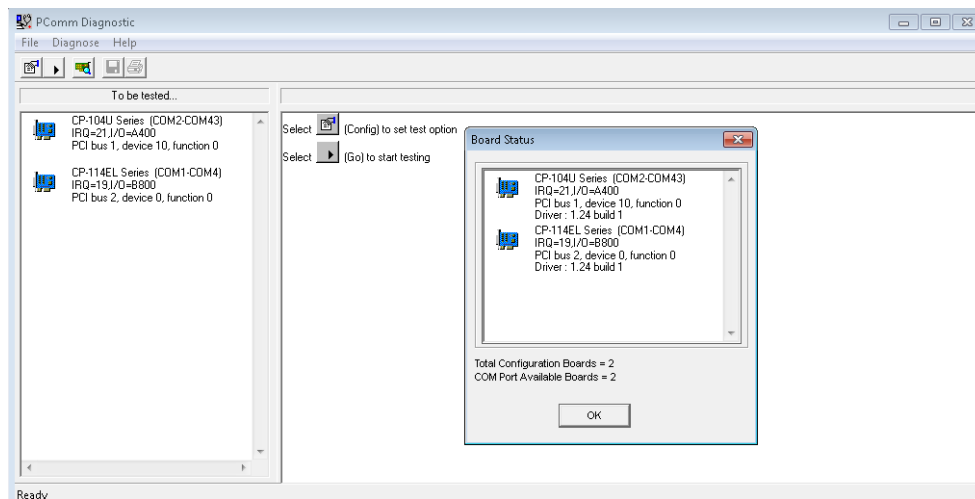
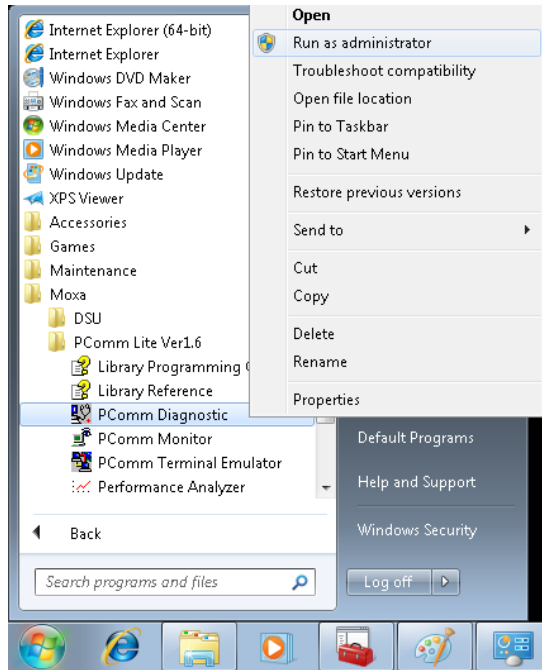

NOTE You can download the PComm Lite software for free from Moxa’s website at www.moxa.com/support/free_downloads.htm

Removing the Driver

1. Open the Device Manager and use the mouse to place the cursor over MOXA CP-114EL Series (PCI Express Bus) under Multi-port serial adapters. Right-click and select the **Uninstall** option.

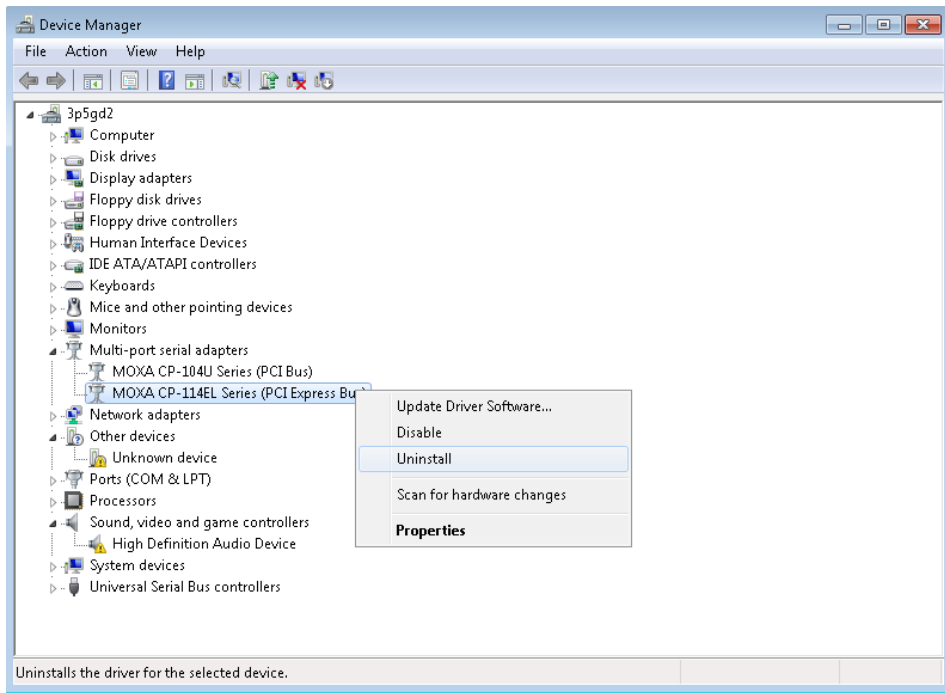

2. Select **Delete the driver software for this device** and click **OK** to proceed with uninstalling the board.

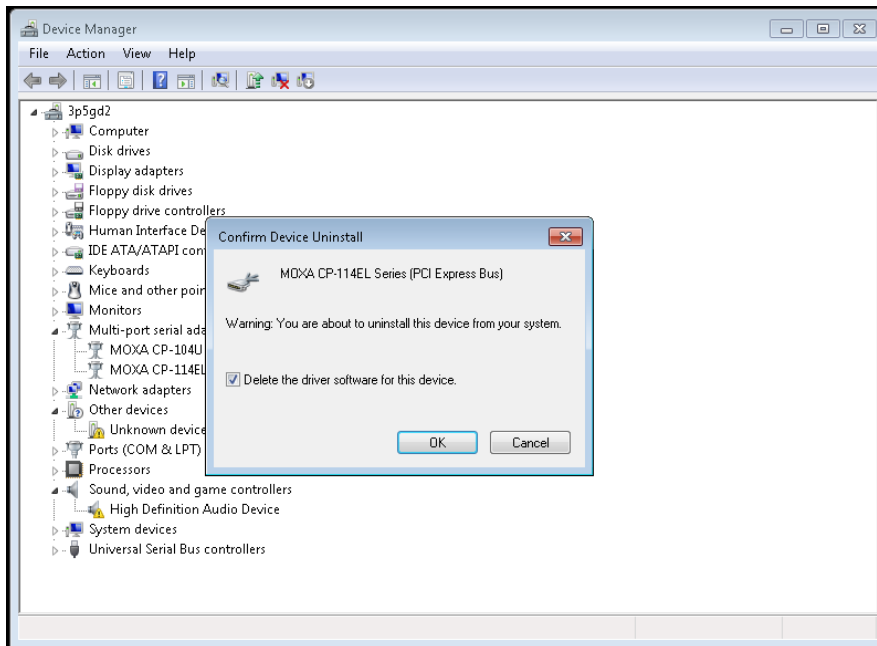

Uninstalling the Driver

The MSB driver may be removed through Add/Remove Programs in the Windows Control Panel. Click **Uninstall** next to MOXA Smartio/Industio Windows Driver Verx.xx

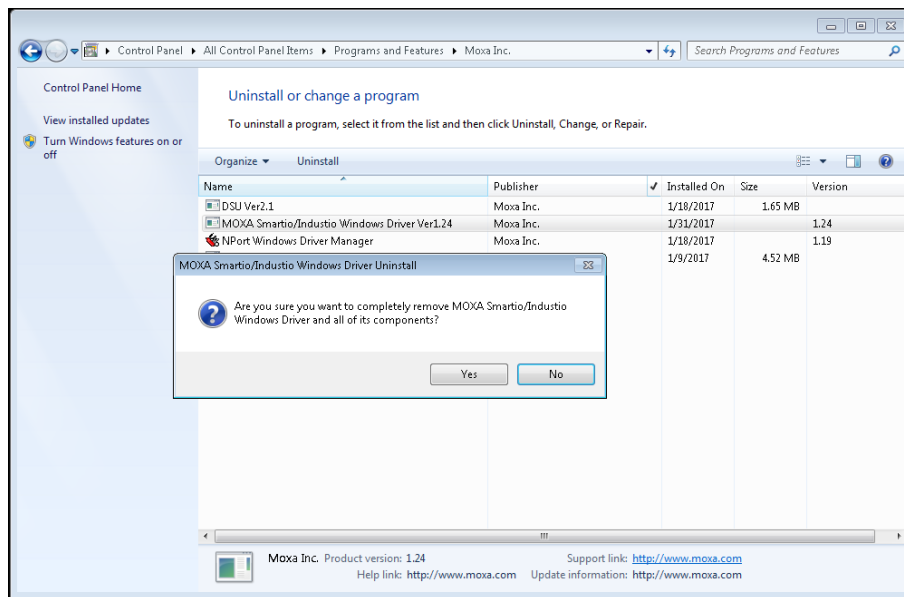
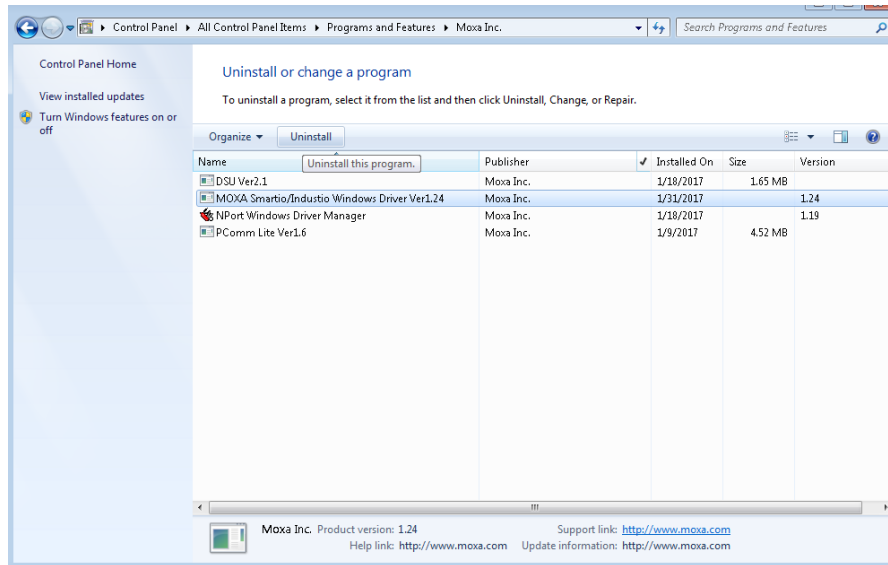

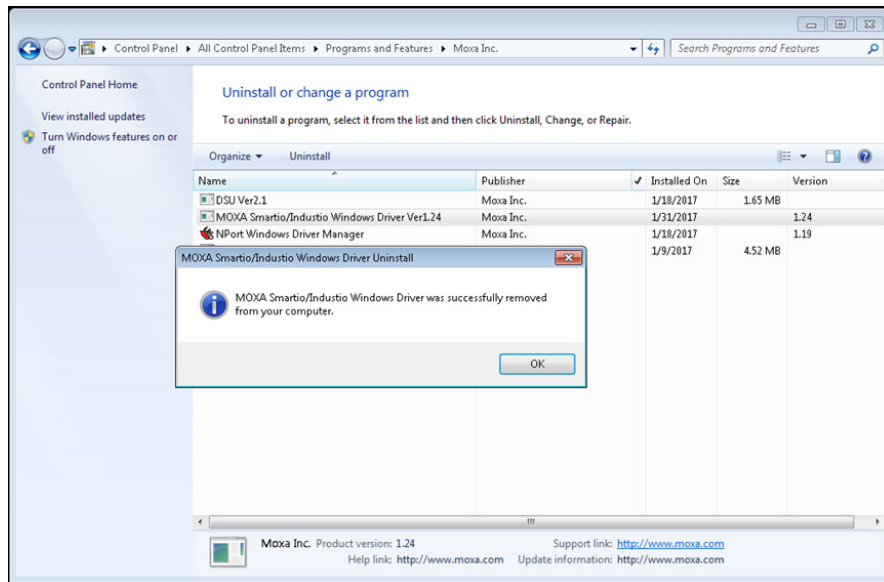

Non-Windows Drivers

Drivers are provided for DOS, Linux, and SCO.

DOS

Moxa DOS API-232 is a software package that assists users in developing new programs, or debugging existing programs for serial communications. This section explains how to install the package, how to set up the driver, and how to load or unload the driver.

Moxa provides drivers that allow you to use the following serial board products for DOS:

- **PCI Express Boards:** CP-102E, CP-102EL, CP-132EL, CP-132EL-I, CP-104EL-A, CP-114EL, CP-114EL-I, CP-118EL-A, CP-168EL-A, CP-118E-A-I, CP-138E-A-I, CP-134EL-A-I, CP-116E-A



WARNING

If you are using a Serial ATA HDD for DOS, the installation process will hang. To prevent the installation process from hanging, change your HDD to an IDE drive.

NOTE The following procedure shows how to install the CP-168EL driver for DOS.

Installing the Driver

1. Run the installation program, **DOSINST.EXE** from the **\Software\DOS** folder on the Documentation and Software CD. Specify the target API-232 directory (e.g., **C:\MOXA**) to which the driver will be copied. Press F2 to start the installation.

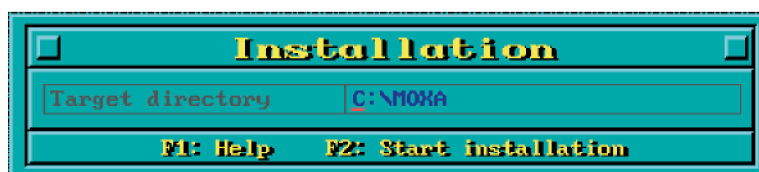

- After the installation is complete, a window will open to ask if you want to run **SETUP.EXE**. Press **Y** to run the program.



Setting up the Driver

This section covers some of the setup program's most frequently used functions. For complete details, press F1 to open the online help file.

- Run **BIN\SETUP.EXE**.
- Press **Enter** to select the model name of the Moxa board you are installing.



- A window will open displaying basic configuration information for all boards of this type currently installed in the system. Press **PgDn** to configure the port settings.

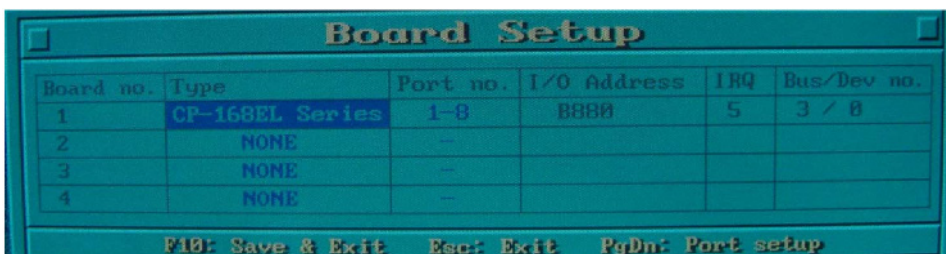

- You may enter or modify the settings of each port at this stage. The values displayed first are the port's initial values that were set up when the driver was installed.

Port Number	01	02	03	04	05	06	07	08
TxD buffer size	1K	1K	1K	1K	1K	1K	1K	1K
RxD buffer size	1K	1K	1K	1K	1K	1K	1K	1K
Baud rate	9600	9600	9600	9600	9600	9600	9600	9600
Character length	8	8	8	8	8	8	8	8
Stop bits	1	1	1	1	1	1	1	1
Parity	None	None	None	None	None	None	None	None
DTR output state	On	On	On	On	On	On	On	On
RTS output state	On	On	On	On	On	On	On	On
CTS flow control	No	No	No	No	No	No	No	No
RTS flow control	No	No	No	No	No	No	No	No
Tx XON/OFF ctrl	No	No	No	No	No	No	No	No
Rx XON/OFF ctrl	No	No	No	No	No	No	No	No

F1: Help F5: Group edit F10: Save Esc: Abort

- Press **F10** to save the changes and exit the SETUP program.

Legends

In this section, we explain the meaning of some of the fields and functions.

Port number

This is the ID of the port. Application software uses port number (ID) when referring to a port. You can set the port numbers to any number between 0 and 255 (inclusive). However, you must ensure that you assign each port a unique port number. If you are developing your own application software, then you may want to select port numbers that take into consideration the structure of the program.

TxD buffer size

The TxD buffer is the transmission (output) buffer allocated by the system for each port.

RxD buffer size

The RxD buffer is the receiving (input) buffer allocated by the system for each port.

F5 Group Edit

This convenient function allows you to edit the configuration of several ports at one time as a group.

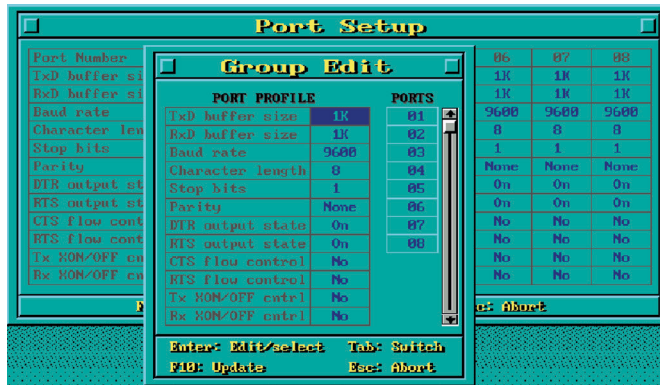

Loading the Driver

After completing the setup procedure, run **BIN\DP-DRV.EXE** from the DOS prompt to load the driver. The driver will automatically detect the boards that have already been installed. If one or more boards are detected, you will see a message similar to the following:

```
Smartio/Industio Family DOS driver Version 1.7
```

```
Setup driver ...
```

```
CP-168EL series (Bus= x ,Dev=y) : OK!
```

```
Device driver setup O.K.
```

This indicates that the CP-168EL Series driver has been installed properly. At this point, you may execute applications that support API-232 functions, or start developing applications using the API-232 library.

Unloading the Driver

To unload (release) the driver from memory, type **DP-DRV/Q** at the DOS prompt and then press **Enter**.

Linux (32-bit/64-bit)

Moxa provides drivers that allow you to use the following serial boards for Linux.

- **PCI Express Boards:** CP-118EL, CP-168EL, CP-104EL, CP-102E, CP-102EL, CP-132EL, CP-132EL-I, CP-114EL, CP-114EL-I, CP-118E-A-I/ CP-138E-A-I/ CP-134EL-A-I/CP-116E-A

NOTE The following procedure shows how to install the CP-114EL driver for Linux.

Execute the following commands from the Linux prompt:

1. #mount /dev/cdrom /mnt/cdrom
#cd /
#mkdir moxa
#cd moxa
#cp /mnt/cdrom/<driver directory>/driv_linux_smart_vx.x_build_yymmddhh.tgz.
#tar -xzf driv_linux_smart_vx.x_build_yymmddhh.tgz.
2. #cd mxser
#make clean; make install
3. #cd /moxa/mxser/driver
#./msmknod
4. #modprobe mxupcie

- For the CP-132EL, CP-132EL-I, CP-114EL, CP-114EL-I, use the Moxa Port Configuration Tool to set Interface and Termination Resistor for the MUE series. The MUE series includes CP-102E, CP-102EL, CP-132EL, CP-132EL-I, CP-114EL and CP-114EL-I.

Usage: `muestty <operation> device`

Device: The MUE series device node

Operation:	-h	Help
	-g	Get interface and terminator type
	-i intf	Set interface type with options below
	-t value	Set termination resistor with options below
intf	RS232	RS-232 mode
	RS422	RS-422 mode
	RS4852W	RS-485 2-wire mode
	RS4854W	RS-485 4-wire mode
value	NONTERM	Non termination resistor
	120TERM	120-ohm termination resistor

For example:

To set the MUE interface

```
# muestty -i RS422 /dev/ttyMUE2
```

To set the MUE termination resistor

```
# muestty -t 120TERM /dev/ttyMUE2
```

- Use the Moxa diagnostics utility to verify the driver status:

```
#cd /moxa/mxser/utility/diag
```

```
#./msdiag
```

- Use the Moxa terminal utility to test the tty ports:

```
#cd /moxa/mxser/utility/term
```

```
#./msterm
```

SCO

- **SCO OpenServer 5**
- **SCO OpenServer 6**
- **SCO UnixWare 7**

Follow the steps given in this section to install the SCO OpenServer 5/6 & SCO UnixWare 7 driver. The installation procedures for SCO UnixWare 7 and SCO OpenServer 5/6 are similar.

- Copy the driver file **.tar** to your host.
- `#tar xvf <driver tar file>`
`#/tmp/moxa/mxinstall`
- The window shown below will open next. Press RETURN to continue.

```
=====
Copyright© 2008 Moxa Inc.
All Rights Reserved.

Moxa Smartio/Industio Family Device Driver Installation (Ver. 1.11)
=====
For SCO UnixWare 7

Tar files, please wait.....O.K.
Press RETURN to continue
```

NOTE If your environment is SCO OpenServer 5/6, you can skip steps 4 and 5.

- When you see the screen below, select "Esc" to exit and reboot your computer.

```
-----
MOXA Smartio/Industio Family Installation Utility (Ver 1.11)
-----
```

Smartio/Industio Family Basic Configuration				
Board No.	Board Type	I/O Address	Interrupt	Bus/Dev No.
1	None	-----	-----	-----
2	None	-----	-----	-----
3	None	-----	-----	-----
4	None	-----	-----	-----
PgDn: getty Setting		Esc: Exit		
Enter: Confirm Input Value		Tab: Change Item		

- After rebooting the computer, type "moxaadm"; when you see MAIN MENU, select **Basic Configuration**.

MAIN MENU
Basic Configuration
Advanced Configuration
Interface Configuration
Port Monitoring
Terminal Emulation
Driver Removal
Exit

- You will see the following screen. Press Enter to select the MOXA Multiport Serial Board you installed by port and by model. For example, if you installed the CP-104EL, select 4 ports and then CP-104EL.

MOXA Smartio/Industio Family Installation Utility (Ver 1.11)				
Smartio/Industio Family Basic Configuration				
Board No.	Board Type	I/O Address	Interrupt	Bus/Dev No.
1	None	-----	-----	-----
2	None	-----	-----	-----
3	None	-----	-----	-----
4	None	-----	-----	-----
PgDn: getty Setting		Esc: Exit		
Enter: Confirm Input Value		Tab: Change Item		

- The board's basic information, such as I/O address, Bus No., and Device No., will be shown. The SCO system will assign the resources automatically to the PCI Express board you selected.
- Next, press "Esc" to exit and reboot your computer.

NOTE Steps 9 and 10 are only for the CP-132EL Series and CP-114EL Series

- After rebooting, type "moxaadm". When you see MAIN MENU, select **Interface Configuration** to set your Resister and Interface. For example, if you want to set one of the CP-114EL ports as RS-422 and 120Ω, you have to select RS-422 and 120Ω.
- Save your Interface Configuration and then reboot the computer again.
- Note that whenever you change a MAIN MENU item, you need to reboot your computer.

Configuring Intelligent RS-485

In this chapter, we describe the use of the "Auto-Tuning" and "Diagnosis" tools, supported by Moxa's Intelligent RS-485 boards, to tune your RS-485 network. The Auto-Tuning tool tests your RS-485 network and then configures certain Moxa boards (CP-118E-A-I, CP-138E-A-I, CP-134EL-A-I, and CP-116E-A) automatically. The Diagnosis tool can tell you how to manually configure other Moxa boards, as well as non-Moxa boards. We use the CP-134EL-A board to demonstrate how to use the Intelligent RS-485 tools for Windows 7/8/8.1.

The basic procedure you should follow is illustrated in the following workflow diagram:

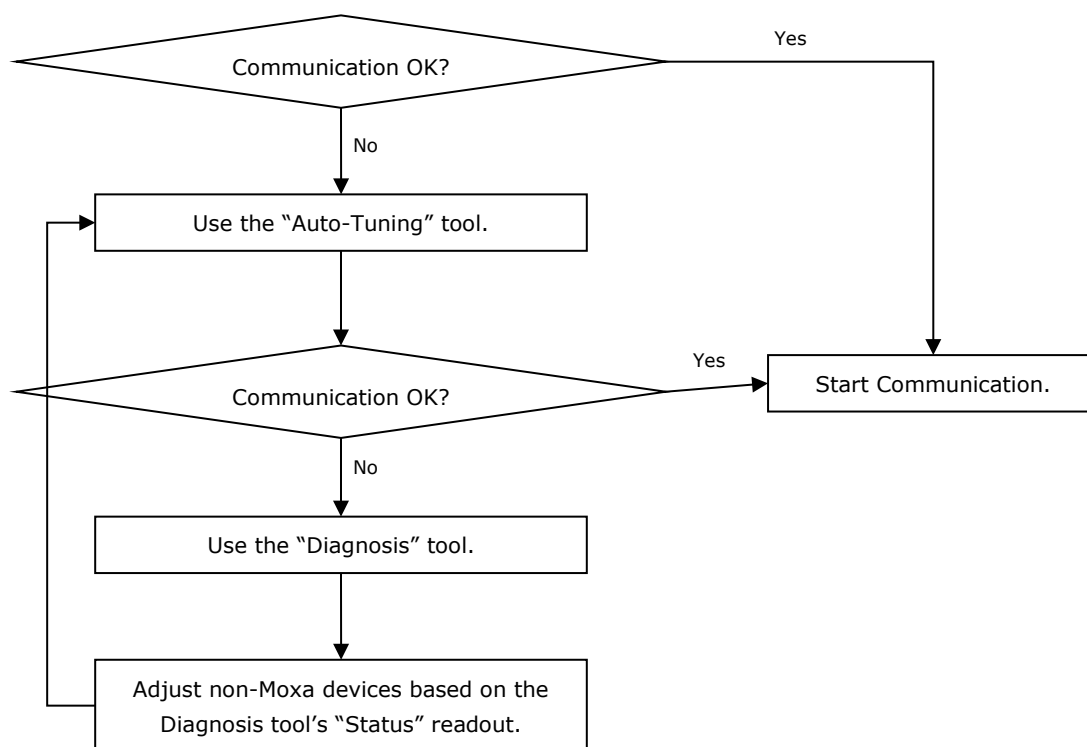

The following topics are covered in this chapter:

- ❑ **Windows Users**
- ❑ **Linux Users**

Windows Users

Take the following steps to use the Intelligent RS-485 function.

1. Expand the **Multi-port serial adapters** tab, right click **MOXA CP-134EL-A Series** (PCI Express Bus), and then click **Properties** to open the configuration panel.

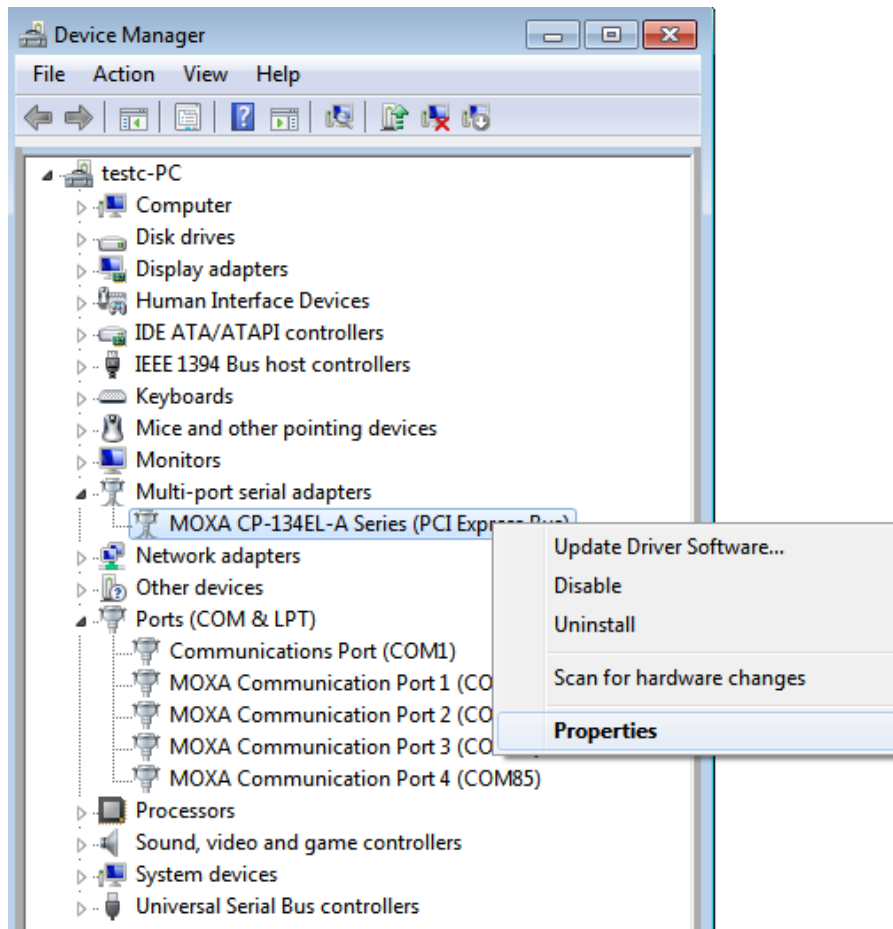

2. Double-click the COM number you wish to configure.

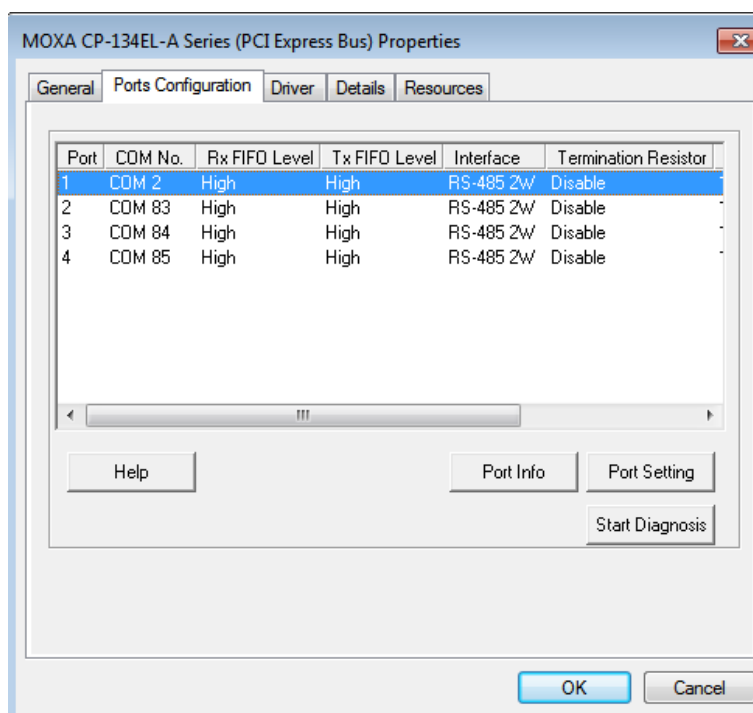

3. Check the **Auto Enumerating COM Number** option to map subsequent ports automatically. The port numbers will be assigned in sequence. Select **Interface** (RS-232, RS-422, RS-485-2W, or RS-485-4W) from the drop-down box. An **Auto Tuning** function is provided with **RS-485-2W**. Click **OK** to save the settings.

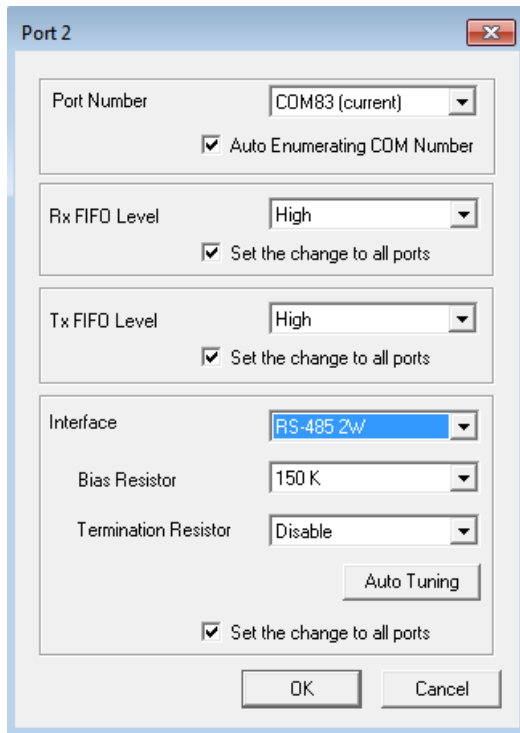

4. Click **OK** on the **Ports Configuration** page to save the settings.
5. Test if the communication is **OK**. If it's not OK, proceed to Step 6.
6. Click on the **COM Number**, click **Auto Tuning** next, and then click **OK**. The PCIe board will automatically detect the RS-485 environment and suggest the correct Bias Resistor and Termination Resistor. Click **OK** to save the setting. To apply the setting, you need to click **OK** on the **Ports Configuration** page.

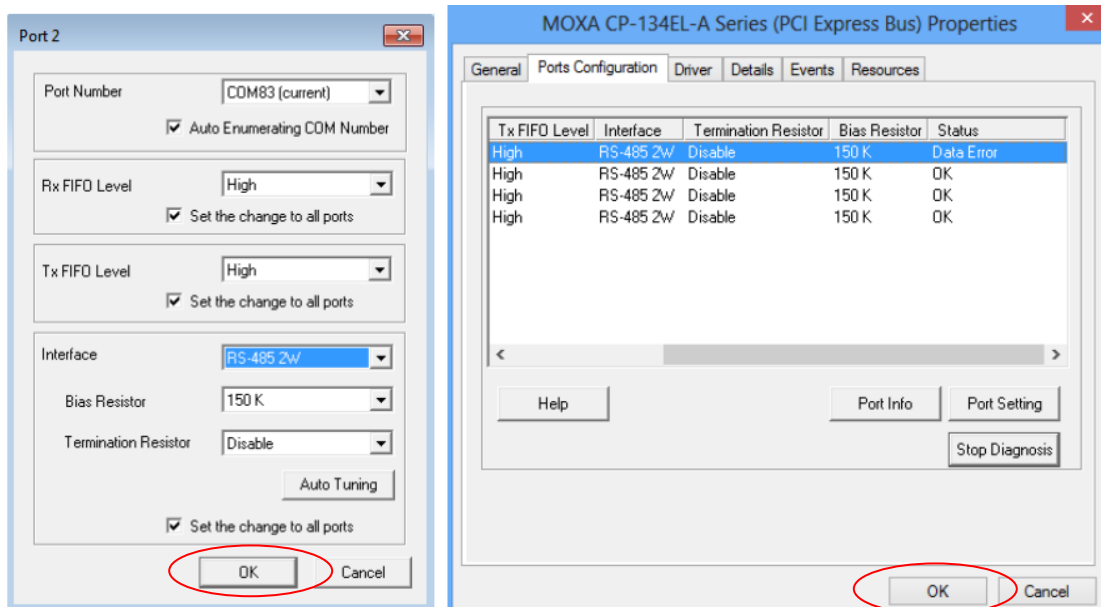

7. Test if the communication is **OK**. If it's not OK, proceed to Step 8.

- Go to the properties screen and select **COM Port needs to be diagnosed**. Click **Start Diagnosis** and when the **CAUTION** message appears, click **OK**.



- Adjust non-MOXA devices according to the **Status**.

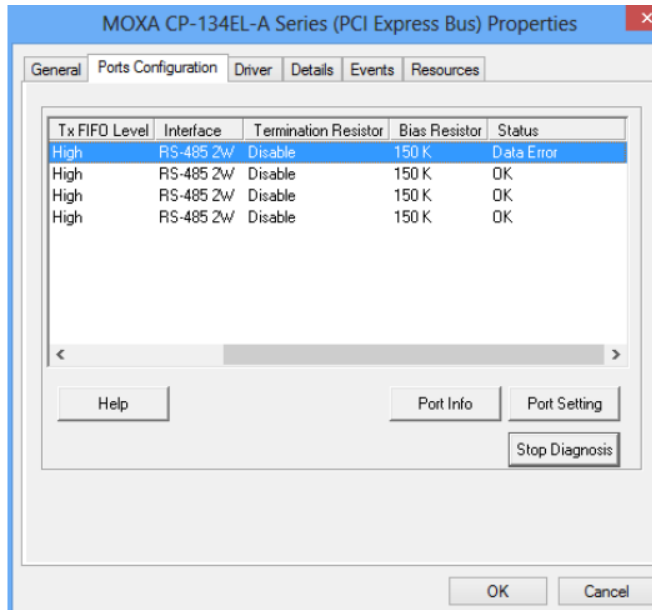

Status	Cause	Adjust Pull-High /Low Resistor	Adjust Terminator Resistor
Waveform Distortion	Too many devices	✓	–
Receive Reflect Signal	Long distance	–	✓
Data Error	Too many devices & long distance	✓	✓

NOTE The Diagnosis tool is extremely sensitive; consequently, it could indicate errors even if the communication status is OK. In this case, you can decide whether or not to make the suggested configuration changes.

- Repeat from Step 6 until the communication is in order.

Linux Users

Take the following steps to configure the Intelligent RS-485 function.

1. Use the following command to do the configuration.

```
#!/muestty -g /dev/ttyMUE1
```

```
root@linux:/moxa/mxser# muestty -g /dev/ttyMUE1
muestty: /dev/ttyMUE1 is set to RS-485 2W mode.
muestty: /dev/ttyMUE1 none terminal resistor.
muestty: /dev/ttyMUE1 disable pull high/low resistor (150K ohm).
```

2. Test if the communication is OK. If it's OK, nothing further needs to be done. If it's not OK, proceed with Step 3.
3. Use the following command for the **Auto-Tuning** process. Enter "Y" to make the value effective immediately.

```
#!/muestty -a (baud rate value) /dev/ttyMUE1
```

```
root@linux:~# muestty -a 115200 /dev/ttyMUE1

Start tuning resistor...

[Status]

Pull High/Low Resistor : 1K
Terminator Resistor    : 120 ohm
Tuning Status          : OK

Note 1. To execute this command again if the serial device
        has been changed on the bus
       2. If the communication is correctly, record the related
          resistor value and init the setting on the rc.mxser file.
          Otherwise, execute the diagnose to get the error status.

Done.

Make these values effective immediately? [Y/n] (Enter for default=Y):
y
The values have been set now.
```

4. Test if the communication is OK. If it's OK, nothing further needs to be done. If it's not OK, proceed with Step 5.
5. Use the following command to run diagnosis.

```
#!/muestty -d (baud rate value) /dev/ttyMUE1
```

```
root@linux:~# muestty -d 115200 /dev/ttyMUE1

Start diagnosing...

[Status]

Notice: Following results are based on correct devices connection.

Pull High/Low Resistor : 1K
Terminator Resistor    : 120 ohm
Alarm Status           : Data Error
```

6. Adjust non-MOXA devices according to the Status

Status	Cause	Adjust Pull-High /Low Resistor	Adjust Terminator Resistor
Waveform Distortion	Too many devices	✓	–
Receive Reflect Signal	Long distance	–	✓
Data Error	Too many devices & long distance	✓	✓

NOTE The Diagnosis tool is extremely sensitive; consequently, it could indicate errors even if the communication status is OK. In this case, you can decide whether or not to make the suggested configuration changes.

7. Repeat from Step 3 until the communication is OK.

Serial Programming Tools

Moxa provides an easy-to-use yet powerful serial programming library as well as utilities for communication troubleshooting for Windows platforms. The following sections provide details about the installation, the library, and the utilities for various platforms.

The following topics are covered in this chapter:

□ **Moxa PComm**

- Installing PComm
- PComm Programming Library

□ **Utilities**

- Diagnostics (for Moxa boards only)
- Monitor (for Moxa boards for Windows 2000/XP/2003/Vista/2008/7(x86 and x64))
- Terminal Emulator

□ **RS-485 Programming**

- ADDC™

Moxa PComm

PComm, a professional serial communication tool for PCs, is a software package that runs under Windows NT95/98/2000/XP/2003/Vista/2008/7(x86 and x64). PComm provides:

- A powerful serial communication library that simplifies serial programming tasks for most popular programming languages. The serial communication library is useful for developing applications for data communications, remote access, data acquisition, and industrial control for Windows NT95/98/2000/XP/2003/Vista/2008/7(x86 and x64), and is a simpler programming solution compared to the more complex Windows Win32 COMM API.
- Useful utilities such as diagnostics, monitor, and terminal emulator.
- Illustrative sample programs.
- Comprehensive online documentation.

Installing PComm

To install PComm, run **\Setup.exe** from the Documentation and Software CD. Note that the PComm diagnostics and monitor utilities are for Moxa boards only. To use these utilities, you must have a Moxa board and the appropriate Windows (NT/95/98/2000/XP/2003/Vista/2008/7(x86 and x64) device driver installed in your system. See the "Software Installation" chapter for instructions on how to install the drivers.

After installing PComm, click **Start**, select **Program Files**, and then the **PComm Lite group** to select from the list of utilities and documents.

PComm Programming Library

The serial communication library helps you develop serial communications programs for any COM port that complies with the Microsoft Win32 API. This library facilitates the implementation of multiprocess, multithread serial communication programs, and greatly reduces the time required to develop applications.

For a complete description of the library functions and sample programs for Visual C++, Visual Basic, and Delphi, check the help file and the sample programs in the PComm directory.

Utilities

In this section, we provide brief descriptions of each utility. For more information about these utilities, read the online help from the Documentation and Software CD.

Diagnostics (for Moxa boards only)

This convenient diagnostics program, which only works with Moxa boards and ports, provides internal and external testing of IRQ, TxD/RxD, UART, CTS/RTS, DTR/DSR, DTR/DCD, etc. The diagnostics program allows the user to check both the hardware and software functions.

To run the diagnostics program, click **Start → Program → PComm Lite → Diagnostic**. A typical test report for a Moxa board is as follows:

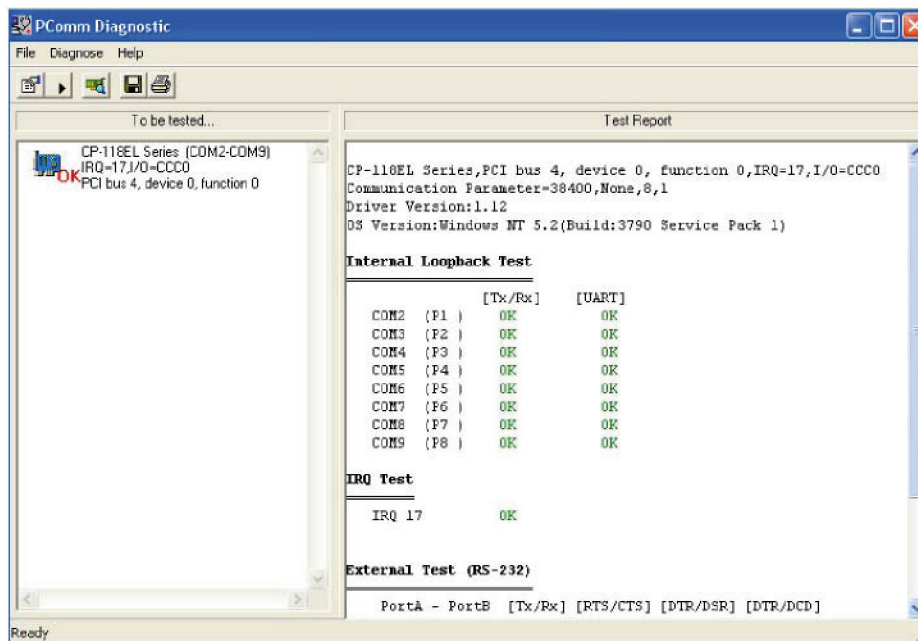

Monitor (for Moxa boards for Windows 2000/XP/2003/Vista/2008/7(x86 and x64))

This useful port status monitoring program allows you to monitor data transmission of selected Moxa COM ports. The program monitors data transmission/reception throughput and communication line status, with data updated and displayed on the screen at regular time intervals. Click a specific port to see a graph of the current communication parameters and status of that port.

To run the Monitor program, click **Start → Program → PComm Lite → Monitor**.

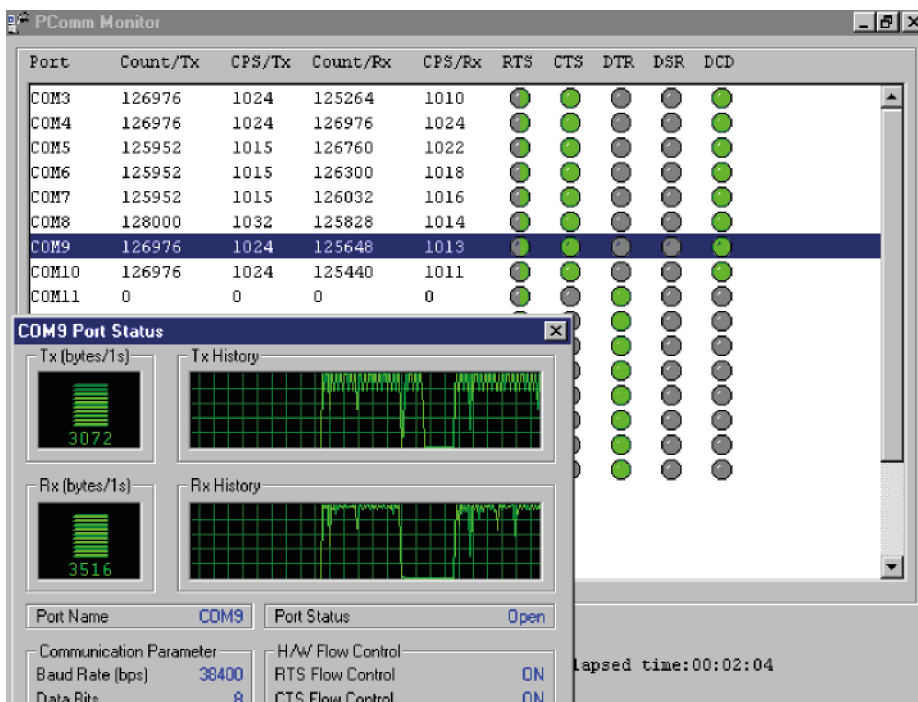

Terminal Emulator

Use Terminal Emulator to connect to your PC’s serial ports to check if data is being transmitted correctly. Terminal Emulator features multi-windows and supports VT100 and ANSI terminal types. You can transfer data interactively, send patterns periodically, and transfer files using ASCII, XMODEM, YMODEM, ZMODEM, and KERMIT protocols.

To run Terminal Emulator, click Start → Program → PComm Lite → Terminal Emulator.

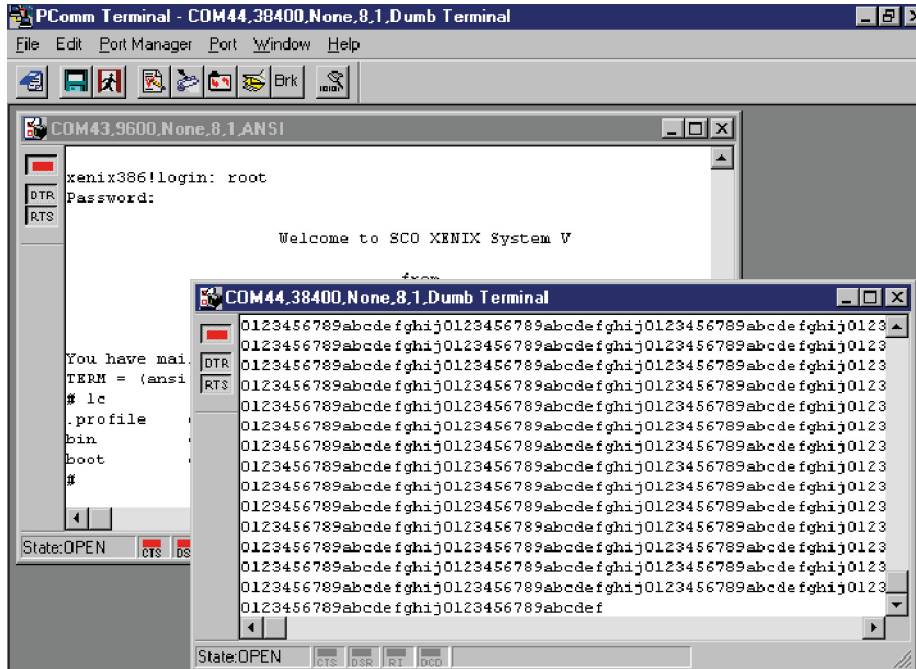

RS-485 Programming

If you are using your CP-118EL Series board for RS-485 applications, in addition to reading this section, you should also refer to the “Connection Cables and Cable Wiring” chapter for more details about using RS-485.

The CP-118EL Series supports 2-wire half-duplex RS-485 and 4-wire full-duplex RS-485 communication. Ports configured for 2-wire RS-485 use the Data+ and Data- pins for both transmitting and receiving data. Moxa’s own ADDC™ (Automatic Data Direction Control) technology is used to switch between transmission and reception.

ADDCTM

ADDCTM is the best method for switching between transmission and reception when using 2-wire RS-485.

When using ADDCTM, an additional code is not required to switch between data transmission and reception, since the board’s built-in intelligent hardware mechanism automatically manages the switching mechanism. RS-485 programming using ADDCTM mode is just as simple and straightforward as RS-232 or RS-422 programming.

6

Programming Guide

If you want to develop your own driver, no matter whether on a Windows or Linux platform, the Moxa Smartio/Industio Programming Guide is a useful instruction. The following topics are covered in this chapter:

❑ **Relative Product List**

- Resource Requirement for Moxa Board
- PCI Configuration for Moxa Board

❑ **UART Register Structure for MU860 chip**

❑ **UART Register Structure for MUE250, MUE450, and MUE850 chips**

❑ **For Baud Rate Setting**

❑ **Moxa Board PCI Device ID List**

❑ **UART Datasheet**

Relative Product List

Resource Requirement for Moxa Board

IRQ * 1

I/O :

UART register : 64 bytes (8 bytes / port * 8port) for MU860
 4096 bytes (512 bytes / port * 8port) for MUE250/450/850

IRQ Vector register : 16 bytes (only 1 byte used)

PCI Configuration for Moxa Board

A. MOXA Vendor ID = 0x1393

B. Device ID = (Please see Moxa Board PCI Device ID List section)

C. Hardware resource on Device Configuration Register of **PCI configuration space**:

Resource Name	Chip	Address Offset		Size
IRQ	All	0x3C		
IRQ Vector Address	MU860	0x1C	BAR3	16 bytes
UART register (I/O Base Address)	MU860	0x18	BAR2	64 bytes
UART register (Memory Base Address)	MUE250, MUE450, MUE850	0x14	BAR1	4096 bytes
Vector Base Address	MUE250, MUE450, MUE850	0x18	BAR2	16 bytes

Byte Offset	0-7	8-15	16-23	24-31
00h	Vendor ID		Device ID	
04h	Command		Status	
08h	...			
0Ch	...			
10h	BAR0			
14h	BAR1			
18h	BAR2			
1Ch	BAR3			
...	...			
3Ch	Interrupt Line	Interrupt Pin	Reserved	

NOTE For MUE250, MUE450, and MUE850 Chips Only: Memory mode is recommended for these chips to access UART. To use memory mode, the driver has to access the memory base address, which is located at BAR1.

UART Register Structure for MU860 chip

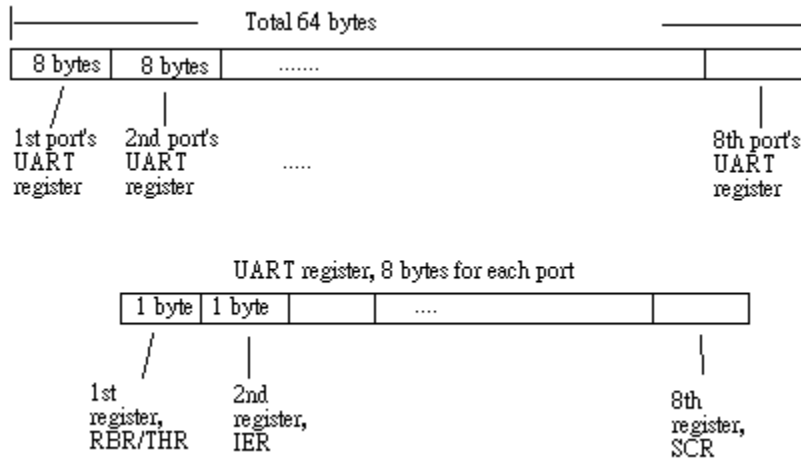

NOTE For detailed UART register description, please see UART Datasheet section.

UART register address = I/O base address + (port-1) * 8

For example, if the base address is 0x180:

The first port's UART register's I/O address is $0x180 + (1-1) * 8 = 0x180$

The first register's I/O address is 0x180,

The second register's I/O address is 0x181,

The second port's UART register's I/O address is $0x180 + (2-1) * 8 = 0x188$

The first register's I/O register is 0x188,

The second register's I/O register is 0x189,

IRQ Vector Register Structure

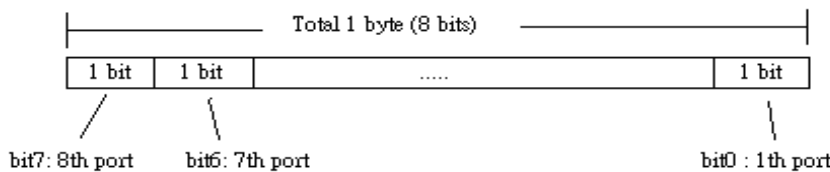

Bit Value	Status
0	Interrupt pending. Please read the UART register to get the detail interrupt information *.
1	No interrupt pending.

All serial ports on the same Moxa board use the same IRQ. Check Vector to know which port issues the interruption. Besides, you can also get the information by querying the IIR of each port.

UART Register Structure for MUE250, MUE450, and MUE850 chips

There are 512 bytes for each UART register and 0x200 offset between each port. However, there is one exception, for the models which are 4-port boards, such as **CP-104EL-A**, **CP-114EL**, **CP-114EL-I**, and **CP-134EL-A**, the offset of the fourth UART register is 0xE00.

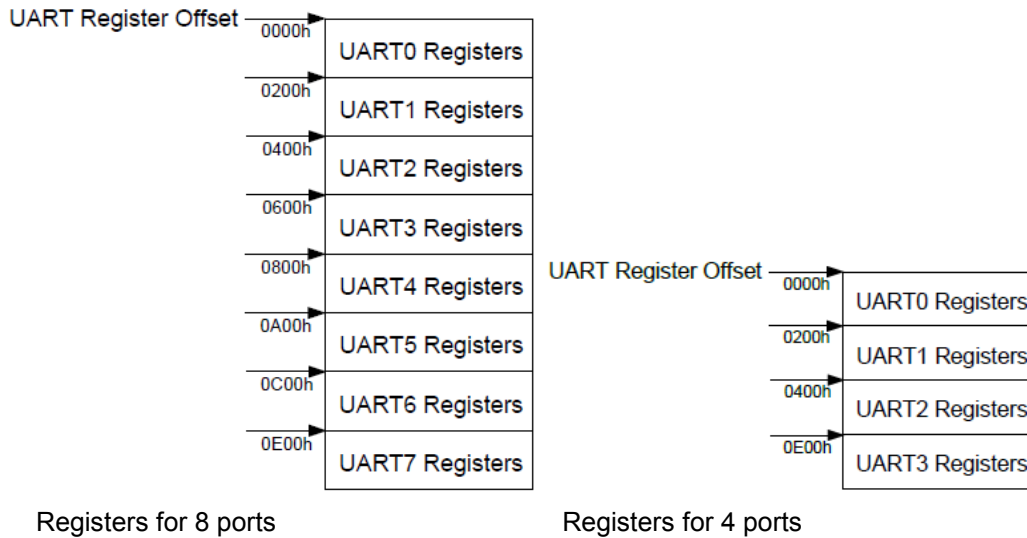

NOTE For a detailed description of the UART register, please see the UART Datasheet section..

UART register address = I/O base address + (port-1) * 0x200

For example, if the base address is 0x200:

The first port's UART register's I/O address is $0x200 + (1-1) * 0x200 = 0x200$

The first register's I/O address is 0x200,

The second register's I/O address is 0x201,

The second port's UART register's I/O address is $0x200 + (2-1) * 0x200 = 0x400$

The first register's I/O register is 0x400,

The second register's I/O register is 0x401,

NOTE For CP-104EL-A, CP-114EL, CP-114EL-I, and CP-134EL-A only:

1st port's UART register address	= I/O base address
2nd port's UART register address	= I/O base address + 1 * 0x200
3rd port's UART register address	= I/O base address + 2 * 0x200
4th port's UART register address	= I/O base address + 7 * 0x200

Control Serial Interface and Termination Resistor for MUE chips

For Moxa boards that use MUE250, MUE450, and MUE850 chips, BAR2, which allocates 16 bytes, is the vector base address that can be used to control serial interface and termination resistors according to the following table.

Offset	Bit	Port #	Parameters
0x4	[3..0]	1	0x0 : RS-232 0x1 : RS-422 0xF : RS-485 2W 0xB : RS-485 4W
	[7..4]	2	
0x5	[3..0]	3	
	[7..4]	4	
0x6	[3..0]	5	
	[7..4]	6	
0x7	[3..0]	7	
	[7..4]	8	
0x8	[7..0]	[8..1]	GPIO – Input
0x9	[7..0]	[8..1]	GPIO direction configuration 0 : Set GPIO direction to input 1 : Set GPIO direction to output
0xA	[7..0]	[8..1]	GPIO – Output (Termination Resistor) 0 : Low (0 Ohm) 1 : High (120 Ohm)

Especially, the interfaces of 4 ports model, such as CP-114EL and CP-114EL-I, are using the following offset to set the interface of port 4.

Offset	Bit	Port #	Parameters
0x4	[3..0]	1	0x0 : RS-232 0x1 : RS-422 0xF : RS-485 2W 0xB : RS-485 4W
	[7..4]	2	
0x5	[3..0]	3	
	[7..4]	-	
0x6	[3..0]	-	
	[7..4]	-	
0x7	[3..0]	4	

For Baud Rate Setting

For General PC Com Port: CLK=1.8432MHz
 $Div = CLK / (Baud \times 16)$

But for Moxa Board: CLK=14.7456MHz
 $Div = CLK / (Baud \times 16)$

Moxa Board PCI Device ID List

Model	Ports	Bus	Chip	Max Baud	Vendor ID	Device ID
CP-102U	2	UPCI	MU860	921.6k	0x1393	0x1022
CP-102UL	2	UPCI	MU860	921.6k	0x1393	0x1021
CP-132UL	2	UPCI	MU860	921.6k	0x1393	0x1321
CP-132UL-I	2	UPCI	MU860	921.6k	0x1393	0x1321
CP-102E	2	PCIe	MUE250	921.6k	0x1393	0x1024
CP-102EL	2	PCIe	MUE250	921.6k	0x1393	0x1025
CP-132EL	2	PCIe	MUE250	921.6k	0x1393	0x1322
CP-132EL-I	2	PCIe	MUE250	921.6k	0x1393	0x1322
CP-104UL	4	UPCI	MU860	921.6k	0x1393	0x1041
CP-104JU	4	UPCI	MU860	921.6k	0x1393	0x1042
CP-114UL	4	UPCI	MU860	921.6k	0x1393	0x1143
CP-114UL-I	4	UPCI	MU860	921.6k	0x1393	0x1143
CP-134U	4	UPCI	MU860	921.6k	0x1393	0x1340
CP-134U-I	4	UPCI	MU860	921.6k	0x1393	0x1340
CP-104EL-A	4	PCIe	MUE450	921.6k	0x1393	0x1045
CP-114EL	4	PCIe	MUE450	921.6k	0x1393	0x1144
CP-114EL-I	4	PCIe	MUE450	921.6k	0x1393	0x1144
CP-134EL-A	4	PCIe	MUE450	921.6k	0x1393	0x1342
CB-114	4	PC/104-Plus	MU860	921.6k	0x1393	0x1142
CB-134I	4	PC/104-Plus	MU860	921.6k	0x1393	0x1341
CP-118U	8	UPCI	MU860	921.6k	0x1393	0x1180
CP-118U-I	8	UPCI	MU860	921.6k	0x1393	0x1180
CP-138U	8	UPCI	MU860	921.6k	0x1393	0x1380
CP-138U-I	8	UPCI	MU860	921.6k	0x1393	0x1380
CP-168U	8	UPCI	MU860	921.6k	0x1393	0x1681
CP-116E-A(A)	8	PCIe	MUE850	921.6k	0x1393	0x1160
CP-116E-A(B)	8	PCIe	MUE850	921.6k	0x1393	0x1161
CP-118EL-A	8	PCIe	MUE850	921.6k	0x1393	0x1182
CP-118E-A-I	8	PCIe	MUE850	921.6k	0x1393	0x1183
CP-138E-A-I	8	PCIe	MUE850	921.6k	0x1393	0x1381
CP-168EL-A	8	PCIe	MUE850	921.6k	0x1393	0x1683
CB-108	8	PC/104-Plus	MU860	921.6k	0x1393	0x1080

UART Datasheet

Moxa's chips are compatible with the following chips. For more details about UART register description, please refer to the links below.

UART	Port	Datasheet
MU-860	2-8	TL16C550C
MUE-250	2	PI7C9X7952
MUE-450	4	PI7C9X7954
MUE-850	8	PI7C9X7958

Pin Assignments

The following topics are covered in this chapter:

- ❑ **PCIe Board Accessories Table**
- ❑ **CP-118EL-A**
 - Board Side Pin Assignments-Female SCSI VHDCI68
 - Device Side Pin Assignments
- ❑ **CP-168EL-A**
 - Board Side Pin Assignments-Female SCSI VHDCI68
 - Device Side Pin Assignments
- ❑ **CP-104EL-A**
 - Board Side Pin Assignments-Female DB44
 - Device Side Pin Assignments
- ❑ **CP-102E**
 - Board Side Pin Assignments-Male DB9
- ❑ **CP-102EL**
 - Board Side Pin Assignments—Female DB25
 - Device Side Pin Assignments
- ❑ **CP-132EL/CP-132EL-I**
 - Board Side Pin Assignments—Female DB25
 - Device Side Pin Assignments
- ❑ **CP-114EL/CP-114EL-I**
 - Board Side Pin Assignments—Female DB44
 - Device Side Pin Assignments
- ❑ **CP-118E-A-I/CP-138E-A-I**
 - Board Side Pin Assignments—Female DB78
 - Device Side Pin Assignments—Male DB9
 - Male DB25 (CBL-M78M25x8-100)
- ❑ **CP134EL-A-I**
 - Board Side Pin Assignments—Female DB44
 - Device Side Pin Assignments—Male DB9
 - Male DB25 (CBL-M44M25x4-50)
- ❑ **CP-116E-A**
 - Board Side Pin Assignments—Female SCSI VHDCI68
 - Device Side Pin Assignments—Male DB9
 - Male DB25 (OPT8B+ / CBL-M68M25x8-100)
 - Female DB25 (OPT8A+/S+)

PCIe Board Accessories Table

To select a PCIe board accessories please refer to the following table:

PCIe Board	Model	Connector Type	Interface
CP-118EL-A	CBL-M68M9x8-100/ OPT8-M9+	DB9 male	RS-232 RS-422/4-wire RS-485
	OPT8B+/ CBL-M68M25x8-100	DB25 male	2-wire RS-485
	OPT8A+/OPT8S+	DB25 female	
CP-168EL-A	CBL-M68M9x8-100/ OPT8-M9+	DB9 male	RS-232
	OPT8B+/OPT8C+	DB25 male	
	OPT8A+/OPT8S+	DB25 female	
CP-104EL-A	CBL-M44M9x4-50	DB9 male	RS-232
	CBL-M44M25x4-50	DB25 male	
CP-102EL	CBL-M25M9x2-50	DB9 male	RS-232
CP-132EL/ CP-132EL-I	CBL-M25M9x2-50	DB9 male	RS-422/4-wire RS-485/ 2-wire RS-485
CP-114EL/ CP-114EL-I	CBL-M44M9x4-50	DB9 male	RS-232
	CBL-M44M25x4-50	DB25 male	RS-422/4-wire RS-485 2-wire RS-485
CP-118E-A-I/ CP-138E-A-I	CBL-M78M9x8-100	DB9 male	RS-232
	CBL-M78M25x8-100	DB25 male	RS-422/4-wire RS-485 2-wire RS-485
CP-134EL-A-I	CBL-M44M9x4-50	DB9 male	RS-422/4-wire RS-485/ 2-wire RS-485
	CBL-M44M25x4-50	DB25 male	
CP-116E-A	OPT8-M9+/ CBL-M68M9x8-100	DB9 male	RS-232 RS-422/4-wire RS-485
	OPT8B+/ CBL-M68M25x8-100	DB25 male	2-wire RS-485
	OPT8A+/OPT8S+	DB25 female	

CP-118EL-A

The CP-118EL-A board has a female SCSI VHDCI68 connector on the board, with various connection options available for connecting from the board to your serial devices. In this chapter, we provide pin assignments for the board side connector, as well as pin assignments for device side connectors for the different connection options.

The CP-118EL-A board supports RS-232, RS-422, 4-wire RS-485, and 2-wire RS-485. Note that the RS-422 standard uses a balanced voltage digital interface to allow 9600 bps communication over cables of up to 4000 feet in length. You can connect ten receivers to one driver for broadcasting systems. The RS-485 standard is an enhanced version of the RS-422 balanced line standard. It allows multiple drivers and receivers to work on a multidrop network. A maximum of 32 drivers and 32 receivers can be set up on a multidrop network. The CP-118EL-A board supports both 2-wire half-duplex and 4-wire full-duplex RS-485 communications. In 2-wire RS-485, Data+/- pins are used for both data transmitting and receiving.

Board Side Pin Assignments-Female SCSI VHDCI68



RS-232

Pin	Signal	Pin	Signal	Pin	Signal	Pin	Signal	Pin	Signal	Pin	Signal
1	RxD6	13	DCD4	25	TxD2	37	RI7	49	RI5	61	TxD1
2	CTS6	14	RTS4	26	GND	38	RTS7	50	CTS5	62	DSR1
3	RI6	15	RI4	27	TxD0	39	DCD7	51	RxD5	63	DTR1
4	RTS6	16	CTS4	28	DSR0	40	DTR7	52	RxD3	64	DCD1
5	DCD6	17	RxD4	29	DTR0	41	DSR7	53	CTS3	65	RTS1
6	DTR6	18	RxD2	30	DCD0	42	TxD7	54	RI3	66	RI1
7	DSR6	19	CTS2	31	RTS0	43	GND	55	RTS3	67	CTS1
8	TxD6	20	RI2	32	RI0	44	TxD5	56	DCD3	68	RxD1
9	GND	21	RTS2	33	CTS0	45	DSR5	57	DTR3		
10	TxD4	22	DCD2	34	RxD0	46	DTR5	58	DSR3		
11	DSR4	23	DTR2	35	RxD7	47	DCD5	59	TxD3		
12	DTR4	24	DSR2	36	CTS7	48	RTS5	60	GND		

RS-422 and 4-wire RS-485

Pin	Signal	Pin	Signal	Pin	Signal	Pin	Signal
1	TxD6+(B)	18	TxD2+(B)	35	TxD7+(B)	52	TxD3+(B)
5	TxD6-(A)	22	TxD2-(A)	39	TxD7-(A)	56	TxD3-(A)
6	RxD6-(A)	23	RxD2-(A)	40	RxD7-(A)	57	RxD3-(A)
8	RxD6+(B)	25	RxD2+(B)	42	RxD7+(B)	59	RxD3+(B)
9	GND	26	GND	43	GND	60	GND
10	RxD4+(B)	27	RxD0+(B)	44	RxD5+(B)	61	RxD1+(B)
12	RxD4-(A)	29	RxD0-(A)	46	RxD5-(A)	63	RxD1-(A)
13	TxD4-(A)	30	TxD0-(A)	47	TxD5-(A)	64	TxD1-(A)
17	TxD4+(B)	34	TxD0+(B)	51	TxD5+(B)	68	TxD1+(B)

2-wire RS-485

Pin	Signal	Pin	Signal	Pin	Signal	Pin	Signal
6	D6-(A)	23	D2-(A)	40	D7-(A)	57	D3-(A)
8	D6+(B)	25	D2+(B)	42	D7+(B)	59	D3+(B)
9	GND	26	GND	43	GND	60	GND
10	D4+(B)	27	D0+(B)	44	D5+(B)	61	D1+(B)
12	D4-(A)	29	D0-(A)	46	D5-(A)	63	D1-(A)

Device Side Pin Assignments

Male DB9 (CBL-M68M9x8-100/OPT8-M9+)

Pin	RS-232	RS-422/RS-485-4W	RS-485-2W
1	DCD	TxD-(A)	-
2	RxD	TxD+(B)	-
3	TxD	RxD+(B)	Data+(B)
4	DTR	RxD-(A)	Data-(A)
5	GND	GND	GND
6	DSR	-	-
7	RTS	-	-
8	CTS	-	-
9	-	-	-

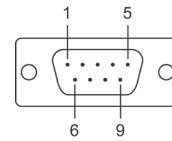

Male DB25 (OPT8B+ / CBL-M68M25x8-100)

Pin	RS-232	RS-422/RS-485-4W	RS-485-2W
2	TxD	RxD+(B)	Data+(B)
3	RxD	TxD+(B)	-
4	RTS	-	-
5	CTS	-	-
6	DSR	-	-
7	GND	GND	GND
8	DCD	TxD-(A)	-
20	DTR	RxD-(A)	Data-(A)

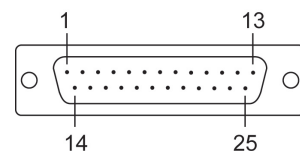

Female DB25 (OPT8A+ / S+)

Pin	RS-232	RS-422/RS-485-4W	RS-485-2W
2	RxD	TxD+(B)	-
3	TxD	RxD+(B)	Data+(B)
4	CTS	-	-
5	RTS	-	-
6	DTR	RxD-(A)	Data-(A)
7	GND	GND	GND
8	DCD	TxD-(A)	-
20	DSR	-	-

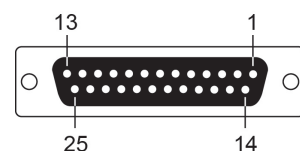

CP-168EL-A

The CP-168EL-A board has a female SCSI VHDCI68 connector on the board, with various connection options available to connect from the board to your serial devices. In this chapter, we give pin assignments for the board side connector, as well as pin assignments for device side connectors for the different connection options. The CP-168EL-A board supports the RS-232 interface onboard.

Board Side Pin Assignments-Female SCSI VHDCI68

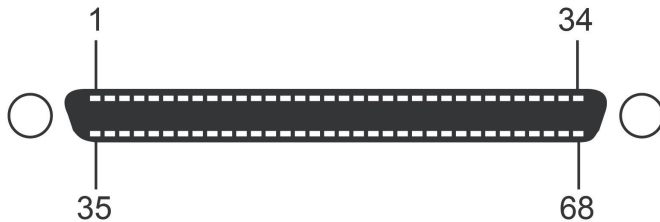

RS-232

Pin	Signal	Pin	Signal	Pin	Signal	Pin	Signal	Pin	Signal	Pin	Signal
1	RxD6	13	DCD4	25	TxD2	37	RI7	49	RI5	61	TxD1
2	CTS6	14	RTS4	26	GND	38	RTS7	50	CTS5	62	DSR1
3	RI6	15	RI4	27	TxD0	39	DCD7	51	RxD5	63	DTR1
4	RTS6	16	CTS4	28	DSR0	40	DTR7	52	RxD3	64	DCD1
5	DCD6	17	RxD4	29	DTR0	41	DSR7	53	CTS3	65	RTS1
6	DTR6	18	RxD2	30	DCD0	42	TxD7	54	RI3	66	RI1
7	DSR6	19	CTS2	31	RTS0	43	GND	55	RTS3	67	CTS1
8	TxD6	20	RI2	32	RI0	44	TxD5	56	DCD3	68	RxD1
9	GND	21	RTS2	33	CTS0	45	DSR5	57	DTR3		
10	TxD4	22	DCD2	34	RxD0	46	DTR5	58	DSR3		
11	DSR4	23	DTR2	35	RxD7	47	DCD5	59	TxD3		
12	DTR4	24	DSR2	36	CTS7	48	RTS5	60	GND		

Device Side Pin Assignments

Male DB9 (CBL-M68M9x8-100/OPT8-M9+)

Pin	RS-232
1	DCD
2	RxD
3	TxD
4	DTR
5	GND
6	DSR
7	RTS
8	CTS
9	-

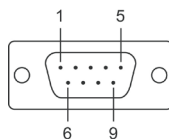

Male DB25 (OPT8B+ / CBL-M68M25x8-100)

Pin	RS-232
2	TxD
3	RxD
4	RTS
5	CTS
6	DSR
7	GND
8	DCD
20	DTR

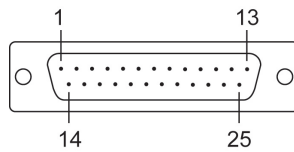

Female DB25 (OPT8A+ / S+)

Pin	RS-232
2	RxD
3	TxD
4	CTS
5	RTS
6	DTR
7	GND
8	DCD
20	DSR

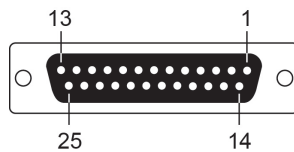

CP-104EL-A

Board Side Pin Assignments-Female DB44

RS-232

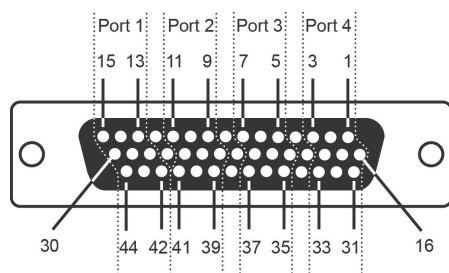

Port 1		Port 2		Port 3		Port 4	
13	TxD	9	TxD	5	TxD	1	TxD
14	RxD	10	RxD	6	RxD	2	RxD
15	RTS	11	RTS	7	RTS	3	RTS
28	CTS	24	CTS	20	CTS	16	CTS
29	DTR	25	DTR	21	DTR	17	DTR
30	DSR	26	DSR	22	DSR	18	DSR
42	DCD	39	DCD	35	DCD	31	DCD
44	GND	41	GND	37	GND	33	GND

Device Side Pin Assignments

Male DB9 (CBL-M44M9x4-50)

Pin	RS-232
1	DCD
2	RxD
3	TxD
4	DTR
5	GND
6	DSR
7	RTS
8	CTS
9	-

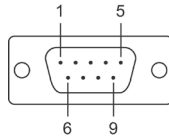

Male DB25 (CBL-M44M25x4-50)

Pin	RS-232
2	TxD
3	RxD
4	RTS
5	CTS
6	DSR
7	GND
8	DCD
20	DTR

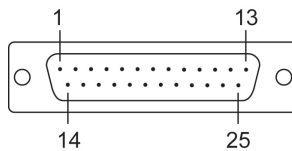

CP-102E

Board Side Pin Assignments-Male DB9

The CP-102E has two male DB9 connectors onboard.

Male DB9

Pin	RS-232
1	DCD
2	RxD
3	TxD
4	DTR
5	GND
6	DSR
7	RTS
8	CTS
9	-

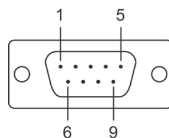

CP-102EL

Board Side Pin Assignments—Female DB25

RS-232

Pin	RS-232	Pin	RS-232
1	–	13	–
2	DCD1	14	–
3	GND	15	DTR1
4	CTS1	16	DSR1
5	RxD1	17	RTS1
6	–	18	TxD1
7	–	19	–
8	–	20	–
9	DTR0	21	DCD0
10	DSR0	22	GND
11	RTS0	23	CTS0
12	TxD0	24	RxD0

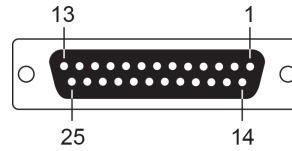

Device Side Pin Assignments

Male DB9 (CBL-M25M9x2-50)

Pin	RS-232
1	DCD
2	RxD
3	TxD
4	DTR
5	GND
6	DSR
7	RTS
8	CTS
9	–

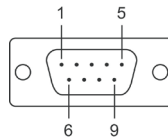

CP-132EL/CP-132EL-I

Board Side Pin Assignments—Female DB25

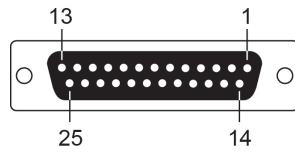

RS-422 & 4-wire RS-485

2-wire RS-485

Pin	Signal	Pin	Signal	Pin	Signal	Pin	Signal
1	-	14	-	1	-	14	-
2	TxD1-(A)	15	RxD1-(A)	2	-	15	Data1-(A)
3	GND1	16	-	3	GND1	16	-
4	-	17	-	4	-	17	-
5	TxD1+(B)	18	RxD1+(B)	5	-	18	Data1+(B)
6	-	19	-	6	-	19	-
7	-	20	-	7	-	20	-
8	-	21	TxD0-(A)	8	-	21	-
9	RxD0-(A)	22	GND0	9	Data0-(A)	22	GND0
10	-	23	-	10	-	23	-
11	-	24	TxD0+(B)	11	-	24	-
12	RxD0+(B)	25	-	12	Data0+(B)	25	-
13	-			13	-		

Device Side Pin Assignments

Male DB9 (CBL-M25M9x2-50)

Pin	RS-422/RS-485-4W	RS-485-2W
1	TxD-(A)	-
2	TxD+(B)	-
3	RxD+(B)	Data+(B)
4	RxD-(A)	Data-(A)
5	GND	GND
6	-	-
7	-	-
8	-	-
9	-	-

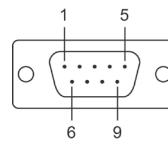

CP-114EL/CP-114EL-I

Board Side Pin Assignments—Female DB44

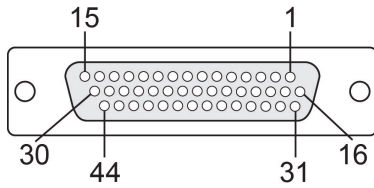

RS-232

Pin	Signal	Pin	Signal	Pin	Signal	Pin	Signal
1	TxD3	13	TxD0	25	DTR1	37	GND
2	RxD3	14	RxD0	26	DSR1	38	-
3	RTS3	15	RTS0	27	-	39	DCD1
4	-	16	CTS3	28	CTS0	40	-
5	TxD2	17	DTR3	29	DTR0	41	GND
6	RxD2	18	DSR3	30	DSR0	42	DCD0
7	RTS2	19	-	31	DCD3	43	-
8	-	20	CTS2	32	-	44	GND
9	TxD1	21	DTR2	33	GND		
10	RxD1	22	DSR2	34	-		
11	RTS1	23	-	35	DCD2		
12	-	24	CTS1	36	-		

RS-422 & 4-wire RS-485

Pin	Signal	Pin	Signal	Pin	Signal	Pin	Signal
1	RxD3(+)	13	RxD0(+)	25	RxD1(-)	37	GND
2	TxD3(+)	14	TxD0(+)	26	-	38	-
3	-	15	-	27	-	39	TxD1(-)
4	-	16	-	28	-	40	-
5	RxD2(+)	17	RxD3(-)	29	RxD0(-)	41	GND
6	TxD2(+)	18	-	30	-	42	TxD0(-)
7	-	19	-	31	TxD3(-)	43	-
8	-	20	-	32	-	44	GND
9	RxD1(+)	21	RxD2(-)	33	GND		
10	TxD1(+)	22	-	34	-		
11	-	23	-	35	TxD2(-)		
12	-	24	-	36	-		

2-wire RS-485

Pin	Signal	Pin	Signal	Pin	Signal
1	Data3+(B)	16	-	31	-
2	-	17	Data3-(A)	32	-
3	-	18	-	33	GND3
4	-	19	-	34	-
5	Data2+(B)	20	-	35	-
6	-	21	Data2-(A)	36	-
7	-	22	-	37	GND2
8	-	23	-	38	-
9	Data1+(B)	24	-	39	-
10	-	25	Data1-(A)	40	-
11	-	26	-	41	GND1
12	-	27	-	42	-
13	Data0+(B)	28	-	43	-
14	-	29	Data0-(A)	44	GND0
15	-	30	-		

Device Side Pin Assignments

Male DB9 (CBL-M44M9x4-50)

Pin	RS-232	RS-422/RS-485-4W	RS-485-2W
1	DCD	TxD-(A)	-
2	RxD	TxD+(B)	-
3	TxD	RxD+(B)	Data+(B)
4	DTR	RxD-(A)	Data-(A)
5	GND	GND	GND
6	DSR	-	-
7	RTS	-	-
8	CTS	-	-
9	-	-	-

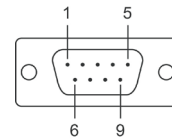

Male DB25 (CBL-M44M25x4-50)

Pin	RS-232	RS-422/RS-485-4W	RS-485-2W
2	TxD	RxD+(B)	Data+(B)
3	RxD	TxD+(B)	-
4	RTS	-	-
5	CTS	-	-
6	DSR	-	-
7	GND	GND	GND
8	DCD	TxD-(A)	-
20	DTR	RxD-(A)	Data-(A)
22	-	-	-

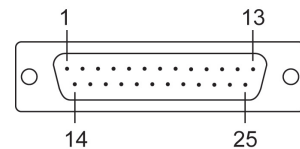

CP-118E-A-I/CP-138E-A-I

Board Side Pin Assignments—Female DB78

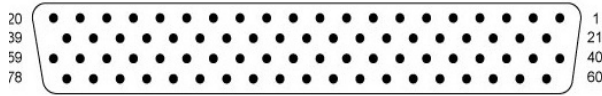

RS-232

Pin	Signal	Pin	Signal	Pin	Signal	Pin	Signal
1	GND7	21	RTS7	40	CTS7	60	DCD7
2	TXD7	22	DTR7	41	DSR7	61	RXD7
3	-	23	RTS6	42	-	62	DCD6
4	GND6	24	DTR6	43	CTS6	63	RXD6
5	TXD6	25	-	44	DSR6	64	-
6	GND5	26	RTS5	45	CTS5	65	DCD5
7	TXD5	27	DTR5	46	DSR5	66	RXD5
8	-	28	RTS4	47	-	67	DCD4
9	GND4	29	DTR4	48	CTS4	68	RXD4
10	TXD4	30	-	49	DSR4	69	-
11	GND3	31	RTS3	50	CTS3	70	DCD3
12	TXD3	32	DTR3	51	DSR3	71	RXD3
13	-	33	RTS2	52	-	72	DCD2
14	GND2	34	DTR2	53	CTS2	73	RXD2
15	TXD2	35	-	54	DSR2	74	-
16	GND1	36	RTS1	55	CTS1	75	DCD1
17	TXD1	37	DTR1	56	DSR1	76	RXD1
18	-	38	RTS0	57	-	77	DCD0
19	GND0	39	DTR0	58	CTS0	78	RXD0
20	TXD0			59	DSR0		

RS-485-4W/RS-422

Pin	Signal	Pin	Signal	Pin	Signal	Pin	Signal
1	GND7	21	-	40	-	60	TXD7-
2	RXD7+	22	RXD7-	41	-	61	TXD7+
3	-	23	-	42	-	62	TXD6-
4	GND6	24	RXD6-	43	-	63	TXD6+
5	RXD6+	25	-	44	-	64	-
6	GND5	26	-	45	-	65	TXD5-
7	RXD5+	27	RXD5-	46	-	66	TXD5+
8	-	28	-	47	-	67	TXD4-
9	GND4	29	RXD4-	48	-	68	TXD4+
10	RXD4+	30	-	49	-	69	-
11	GND3	31	-	50	-	70	TXD3-
12	RXD3+	32	RXD3-	51	-	71	TXD3+
13	-	33	-	52	-	72	TXD2-
14	GND2	34	RXD2-	53	-	73	TXD2+
15	RXD2+	35	-	54	-	74	-
16	GND1	36	-	55	-	75	TXD1-
17	RXD1+	37	RXD1-	56	-	76	TXD1+
18	-	38	-	57	-	77	TXD0-
19	GND0	39	RXD0-	58	-	78	TXD0+
20	RXD0+			59	-		

RS-485-2W

Pin	Signal	Pin	Signal	Pin	Signal	Pin	Signal
1	GND7	21	-	40	-	60	-
2	DATA7+	22	DATA7-	41	-	61	-
3	-	23	-	42	-	62	-
4	GND6	24	DATA6-	43	-	63	-
5	DATA6+	25	-	44	-	64	-
6	GND5	26	-	45	-	65	-
7	DATA5+	27	DATA5-	46	-	66	-
8	-	28	-	47	-	67	-
9	GND4	29	DATA4-	48	-	68	-
10	DATA4+	30	-	49	-	69	-
11	GND3	31	-	50	-	70	-
12	DATA3+	32	DATA3-	51	-	71	-
13	-	33	-	52	-	72	-
14	GND2	34	DATA2-	53	-	73	-
15	DATA2+	35	-	54	-	74	-
16	GND1	36	-	55	-	75	-
17	DATA1+	37	DATA1-	56	-	76	-
18	-	38	-	57	-	77	-
19	GND0	39	DATA0-	58	-	78	-
20	DATA0+			59	-		

Device Side Pin Assignments—Male DB9

PIN	RS-232	RS-422/RS-485-4W	RS-485-2W
1	DCD	TxD-(A)	-
2	RxD	TxD+(B)	-
3	TxD	RxD+(B)	Data+(B)
4	DTR	RxD-(A)	Data-(A)
5	GND	GND	GND
6	DSR	-	-
7	RTS	-	-
8	CTS	-	-

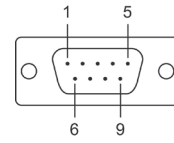

Male DB25 (CBL-M78M25x8-100)

PIN	RS-232	RS-422/RS-485-4W	RS-485-2W
2	TxD	RxD+(B)	Data+(B)
3	RxD	TxD+(B)	-
4	RTS	-	-
5	CTS	-	-
6	DSR	-	-
7	GND	GND	GND
8	DCD	TxD-(A)	-
20	DTR	RxD-(A)	Data-(A)

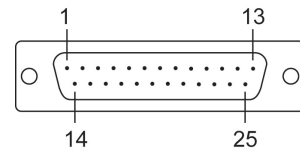

CP134EL-A-I

Board Side Pin Assignments—Female DB44

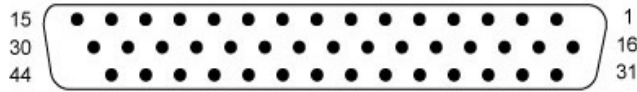

RS-422

Pin	Signal	Pin	Signal	Pin	Signal
1	RXD4+	16	-	31	TXD4-
2	TXD4+	17	RXD4-	32	-
3	-	18	-	33	GND4
4	-	19	-	34	-
5	RXD3+	20	-	35	TXD3-
6	TXD3+	21	RXD3-	36	-
7	-	22	-	37	GND3
8	-	23	-	38	-
9	RXD2+	24	-	39	TXD2-
10	TXD2+	25	RXD2-	40	-
11	-	26	-	41	GND2
12	-	27	-	42	TXD1-
13	RXD1+	28	-	43	-
14	TXD1+	29	RXD1-	44	GND1
15	-	30	-		

RS-485-4W

Pin	Signal	Pin	Signal	Pin	Signal
1	RXD4+	16	-	31	TXD4-
2	TXD4+	17	RXD4-	32	-
3	-	18	-	33	GND4
4	-	19	-	34	-
5	RXD3+	20	-	35	TXD3-
6	TXD3+	21	RXD3-	36	-
7	-	22	-	37	GND3
8	-	23	-	38	-
9	RXD2+	24	-	39	TXD2-
10	TXD2+	25	RXD2-	40	-
11	-	26	-	41	GND2
12	-	27	-	42	TXD1-
13	RXD1+	28	-	43	-
14	TXD1+	29	RXD1-	44	GND1
15	-	30	-		

RS-485-2W

Pin	Signal	Pin	Signal	Pin	Signal
1	DATA4+	16	-	31	-
2	-	17	DATA4-	32	-
3	-	18	-	33	-
4	-	19	-	34	-
5	DATA3+	20	-	35	-
6	-	21	DATA3-	36	-
7	-	22	-	37	-
8	-	23	-	38	-
9	DATA2+	24	-	39	-
10	-	25	DATA2-	40	-
11	-	26	-	41	-
12	-	27	-	42	-
13	DATA1+	28	-	43	-
14	-	29	DATA1-	44	-
15	-	30	-		

Device Side Pin Assignments—Male DB9

PIN	RS-232	RS-422/RS-485-4W	RS-485-2W
1	DCD	TxD-(A)	-
2	RxD	TxD+(B)	-
3	TxD	RxD+(B)	Data+(B)
4	DTR	RxD-(A)	Data-(A)
5	GND	GND	GND
6	DSR	-	-
7	RTS	-	-
8	CTS	-	-

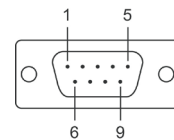

Male DB25 (CBL-M44M25x4-50)

PIN	RS-232	RS-422/RS-485-4W	RS-485-2W
2	TxD	RxD+(B)	Data+(B)
3	RxD	TxD+(B)	-
4	RTS	-	-
5	CTS	-	-
6	DSR	-	-
7	GND	GND	GND
8	DCD	TxD-(A)	-
20	DTR	RxD-(A)	Data-(A)

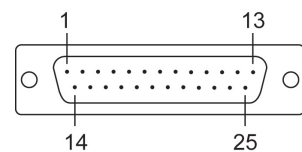

CP-116E-A

Board Side Pin Assignments—Female SCSI VHDCI68



Pin	Signal	Pin	Signal	Pin	Signal	Pin	Signal	Pin	Signal	Pin	Signal
1	RxD6	13	DCD4	25	TxD2	37	-	49	-	61	TxD1
2	CTS6	14	RTS4	26	GND	38	RTS7	50	CTS5	62	DSR1
3	-	15	-	27	TxD0	39	DCD7	51	RxD5	63	DTR1
4	RTS6	16	CTS4	28	DSR0	40	DTR7	52	RxD3	64	DCD1
5	DCD6	17	RxD4	29	DTR0	41	DSR7	53	CTS3	65	RTS1
6	DTR6	18	RxD2	30	DCD0	42	TxD7	54	-	66	-
7	DSR6	19	CTS2	31	RTS0	43	GND	55	RTS3	67	CTS1
8	TxD6	20	-	32	-	44	TxD5	56	DCD3	68	RxD1
9	GND	21	RTS2	33	CTS0	45	DSR5	57	DTR3		
10	TxD4	22	DCD2	34	RxD0	46	DTR5	58	DSR3		
11	DSR4	23	DTR2	35	RxD7	47	DCD5	59	TxD3		
12	DTR4	24	DSR2	36	CTS7	48	RTS5	60	GND		

Device Side Pin Assignments—Male DB9

PIN	RS-232	RS-422/RS-485-4W	RS-485-2W
1	DCD	TxD-(A)	-
2	RxD	TxD+(B)	-
3	TxD	RxD+(B)	Data+(B)
4	DTR	RxD-(A)	Data-(A)
5	GND	GND	GND
6	DSR	-	-
7	RTS	-	-
8	CTS	-	-

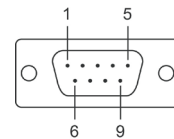

Male DB25 (OPT8B+ / CBL-M68M25x8-100)

PIN	RS-232	RS-422/RS-485-4W	RS-485-2W
2	TxD	RxD+(B)	Data+(B)
3	RxD	TxD+(B)	-
4	RTS	-	-
5	CTS	-	-
6	DSR	-	-
7	GND	GND	GND
8	DCD	TxD-(A)	-
20	DTR	RxD-(A)	Data-(A)

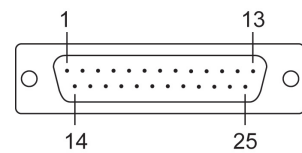

Female DB25 (OPT8A+/S+)

PIN	RS-232	RS-422/RS-485-4W	RS-485-2W
2	RxD	TxD+(B)	-
3	TxD	RxD+(B)	Data+(B)
4	CTS	-	-
5	RTS	-	-
6	DTR	RxD-(A)	Data-(A)
7	GND	GND	GND
8	DCD	TxD-(A)	-
20	DSR	-	-

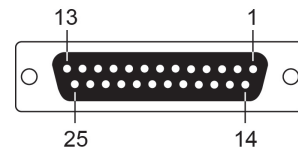

Troubleshooting

In this chapter, we discuss the common PCI Express Series problems and possible solutions. If you still have problems after reading this chapter, contact your dealer or Moxa for help, or use the Problem Report Form at the end of this manual to report problems to your dealer.

1. **The Moxa PCI Express board cannot be detected by the Moxa driver while installing the driver.**

Hardware causes and solutions:

- a. Express slot. It is also possible that a slot has malfunctioned. In this case, try other slots until you find one that works.
- b. The motherboard does not have an available IRQ for the PCI Express board. In this case, enter the BIOS and make sure there is an available IRQ under PCI/PnP settings.

2. **The Moxa PCI Express board and driver are activated but cannot transfer (transmit/receive) data.**

Hardware Causes and Solutions:

- a. Make sure the cable wiring is connected correctly. Refer to the "Pin Assignments" chapter for correct cable connections.
- b. The cable or the board could be defective. Try other ports, cables, or boards to verify this, or use the PComm Diagnostic utility to test the Moxa board and port conditions. If the Diagnostic program reports an error, replace the faulty components.

Software Causes and Solutions:

- a. PCI Express Series boards will check the line status (CTS) before transmitting data if the RTS/CTS flow control feature is set to Enable in the configuration or application program. Refer to the "Connection Cables and Cable Wiring" chapter for proper wiring diagrams; then, check the line status of the suspected port, using the diagnostics LED indicators on the mini tester.
- b. The board control application may not be written correctly according to the corresponding API of the operating system. To check this problem, run another application that you know is correct, or use the utilities provided by Moxa (such as PComm Terminal emulator or HyperTerminal that runs under Windows platform).

A

Product Specifications

The following topics are covered in this appendix:

- **CP-118EL-A Specifications**
- **CP-168EL-A Specifications**
- **CP-104EL-A Specifications**
- **CP-102E Specifications**
- **CP-102EL Specifications**
- **CP-132EL Series Specifications**
- **CP-114EL Series Specifications**
- **CP-118E-A-I Specifications**
- **CP-138E-A-I Specifications**
- **CP-134EL-A-I Specifications**
- **CP-116E-A Specifications**

CP-118EL-A Specifications

Hardware	
Connector	SCSI VHDCI68
Comm. Controller	16C550C compatible
Interface	
Bus Interface	PCI Express × 1
Number of Ports	8
Max No. of Boards	8 (only one IRQ required)
Signals	
RS-232	TxD, RxD, RTS, CTS, DTR, DSR, DCD, GND
RS-422	TxD+(B), TxD-(A), RxD+(B), RxD-(A), GND
4-wire RS-485	TxD+(B), TxD-(A), RxD+(B), RxD-(A), GND
2-wire RS-485	Data+(B), Data-(A), GND
Performance	
Baudrate	50 bps to 921.6 kbps
Configuration	
Data Bits	5, 6, 7, 8
Stop Bits	1, 1.5, 2
I/O address/IRQ	BIOS assigned
Parity	None, Even, Odd, Space, Mark
Flow Control	RTS/CTS, XON/XOFF
Power and Environment	
Power Requirement	1285 mA (3.3V)
Operating Temperature	0 to 55°C (32 to 132°F)
Operating Humidity	5 to 95% RH
Storage Temperature	-20 to 85°C (-4 to 185°F)
ESD Protection	Embedded 15 kV ESD Protection
Standards and Certifications	EN55032, EN55024, EN61000-3-2, EN61000-3-3, IEC 61000-4-2, IEC 61000-4-3, IEC 61000-4-4, IEC 61000-4-5, IEC 61000-4-6, IEC 61000-4-8, IEC 61000-4-11 FCC Part 15 Class B
Warranty	5 years

CP-168EL-A Specifications

Hardware	
Connector	SCSI VHDCI68
Comm. Controller	16C550C compatible
Interface	
Bus Interface	PCI Express × 1
Number of Ports	8
Max No. of Boards	8 (only one IRQ required)
Signals	
RS-232	TxD, RxD, RTS, CTS, DTR, DSR, DCD, GND
Performance	
Baudrate	50 bps to 921.6 kbps
Configuration	
Data Bits	5, 6, 7, 8
Stop Bits	1, 1.5, 2
I/O address/IRQ	BIOS assigned
Parity	None, Even, Odd, Space, Mark
Flow Control	RTS/CTS, XON/XOFF
Power and Environment	
Power Requirement	1225 mA (3.3V)
Operating Temperature	0 to 55°C (32 to 132°F)
Operating Humidity	5 to 95% RH
Storage Temperature	-20 to 85°C (-4 to 185°F)
ESD Protection	Embedded 15 kV ESD Protection
Standards and Certifications	EN55032, EN55024, EN61000-3-2, EN61000-3-3, IEC 61000-4-2, IEC 61000-4-3, IEC 61000-4-4, IEC 61000-4-5, IEC 61000-4-6, IEC 61000-4-8, IEC 61000-4-11 FCC Part 15 Class B
Warranty	5 years

CP-104EL-A Specifications

Hardware	
Connector	Female DB44
Comm. Controller	16C550C compatible
Interface	
Bus Interface	PCI Express × 1
Number of Ports	4
Max No. of Boards	8 (only one IRQ required)
Signals	
RS-232	TxD, RxD, RTS, CTS, DTR, DSR, DCD, GND
Performance	
Baudrate	50 bps to 921.6 kbps
Configuration	
Data Bits	5, 6, 7, 8
Stop Bits	1, 1.5, 2
I/O address/IRQ	BIOS assigned
Parity	None, Even, Odd, Space, Mark
Flow Control	RTS/CTS, XON/XOFF
Power and Environment	
Power Requirement	805 mA (3.3V)
Operating Temperature	0 to 55°C (32 to 132°F)
Operating Humidity	5 to 95% RH
Storage Temperature	-20 to 85°C (-4 to 185°F)
ESD Protection	Embedded 15 kV ESD Protection
Standards and Certifications	EN55032, EN55024, EN61000-3-2, EN61000-3-3, IEC 61000-4-2, IEC 61000-4-3, IEC 61000-4-4, IEC 61000-4-5, IEC 61000-4-6, IEC 61000-4-8, IEC 61000-4-11 FCC Part 15 Class B
Warranty	5 years

CP-102E Specifications

Hardware	
Connector	Male DB9 x 2
Comm. Controller	16C550C compatible
Interface	
Bus Interface	PCI Express x 1
Number of Ports	2
Max No. of Boards	8
Signal	
RS-232	TxD, RxD, RTS, CTS, DTR, DSR, DCD, GND
Performance	
Baudrate	50 bps to 921.6 kbps
Configuration	
Data Bits	5, 6, 7, 8
Stop Bits	1, 1.5, 2
I/O address/IRQ	BIOS assigned
Parity	None, Even, Odd, Space, Mark
Flow Control	RTS/CTS, XON/XOFF
Environment	
Operating Temperature	0 to 55°C (32 to 132°F)
Operating Humidity	5 to 95% RH
Storage Temperature	-20 to 85°C (-4 to 185°F)
ESD Protection	Embedded 15 kV ESD Protection
Standards and Certifications	EN55032, EN55024, EN61000-3-2, EN61000-3-3, EN61000-6-2, IEC-61000-4-2, IEC 61000-4-3, IEC 61000-4-4, IEC 61000-4-5, IEC 61000-4-6, IEC 61000-4-8, IEC 61000-4-11, FCC Part 15 Class B
Warranty	5 years

CP-102EL Specifications

Hardware	
Connector	Female DB25
Comm. Controller	16C550C compatible
Interface	
Bus Interface	PCI Express × 1
Number of Ports	2
Max No. of Boards	8
Signal	
RS-232	TxD, RxD, RTS, CTS, DTR, DSR, DCD, GND
Performance	
Baudrate	50 bps to 921.6 kbps
Configuration	
Data Bits	5, 6, 7, 8
Stop Bits	1, 1.5, 2
I/O address/IRQ	BIOS assigned
Parity	None, Even, Odd, Space, Mark
Flow Control	RTS/CTS, XON/XOFF
Environment	
Operating Temperature	0 to 55°C (32 to 132°F)
Operating Humidity	5 to 95% RH
Storage Temperature	-20 to 85°C (-4 to 185°F)
ESD Protection	Embedded 15 kV ESD Protection
Standards and Certifications	EN55032, EN55024, EN61000-3-2, EN61000-3-3, EN61000-6-2, IEC-61000-4-2, IEC 61000-4-3, IEC 61000-4-4, IEC 61000-4-5, IEC 61000-4-6, IEC 61000-4-8, IEC 61000-4-11, FCC Part 15 Class B
Warranty	5 years

CP-132EL Series Specifications

Hardware	
Connector	Female DB25
Comm. Controller	16C550C compatible
Interface	
Bus Interface	PCI Express × 1
Number of Ports	2
Max No. of Boards	8
Signal	
RS-422	TxD+(B), TxD-(A), RxD+(B), RxD-(A), GND
RS-485 4-Wire	TxD+(B), TxD-(A), RxD+(B), RxD-(A), GND
RS-485 2-Wire	Data+(B), Data-(A), GND
Performance	
Baudrate	50 bps to 921.6 kbps
Configuration	
Data Bits	5, 6, 7, 8
Stop Bits	1, 1.5, 2
I/O address/IRQ	BIOS assigned
Parity	None, Even, Odd, Space, Mark
Flow Control	XON/XOFF
Environment	
Operating Temperature	0 to 55°C (32 to 132°F)
Operating Humidity	5 to 95% RH
Storage Temperature	-20 to 85°C (-4 to 185°F)
ESD Protection	Embedded 15 kV ESD Protection
Optical Isolation	2 kV (only for CP-132EL-I)
Standards and Certifications	EN55032, EN55024, EN61000-3-2, EN61000-3-3, EN61000-6-2, IEC-61000-4-2, IEC 61000-4-3, IEC 61000-4-4, IEC 61000-4-5, IEC 61000-4-6, IEC 61000-4-8, IEC 61000-4-11, FCC Part 15 Class B
Warranty	5 years

CP-114EL Series Specifications

Hardware	
Connector	Female DB44
Comm. Controller	16C550C compatible
Interface	
Bus Interface	PCI Express × 1
Number of Ports	4
Max No. of Boards	8
Signal	
RS-232	TxD, RxD, RTS, CTS, DTR, DSR, DCD, GND
RS-422	TxD+(B), TxD-(A), RxD+(B), RxD-(A), GND
RS-485 4-Wire	TxD+(B), TxD-(A), RxD+(B), RxD-(A), GND
RS-485 2-Wire	Data+(B), Data-(A), GND
Performance	
Baudrate	50 bps to 921.6 kbps
Configuration	
Data Bits	5, 6, 7, 8
Stop Bits	1, 1.5, 2
I/O address/IRQ	BIOS assigned
Parity	None, Even, Odd, Space, Mark
Flow Control	RTS/CTS, XON/XOFF
Environment	
Operating Temperature	0 to 55°C (32 to 132°F)
Operating Humidity	5 to 95% RH
Storage Temperature	-20 to 85°C (-4 to 185°F)
ESD Protection	Embedded 15 kV ESD Protection
Optical Isolation	2 kV (only for CP-114EL-I)
Standards and Certifications	EN55032, EN55024, EN61000-3-2, EN61000-3-3, EN61000-6-2, IEC-61000-4-2, IEC 61000-4-3, IEC 61000-4-4, IEC 61000-4-5, IEC 61000-4-6, IEC 61000-4-8, IEC 61000-4-11, FCC Part 15 Class B
Warranty	5 years

CP-118E-A-I Specifications

Hardware	
Connector	Female DB 78
Comm. Controller	16C550C Compatible
Interface	
Bus Interface	PCI-Express x 1
Number of Ports	8
Max No. of Boards	8
Signal	
RS-232	TxD, RxD, RTS, CTS, DTR, DSR, DCD, GND
RS-422	TxD+(B), TxD-(A), RxD+(B), RxD-(A), GND
4-wire RS-485	TxD+(B), TxD-(A), RxD+(B), RxD-(A), GND
2-wire RS-422	Data+(B), Data-(A), GND
Performance	
Baudrate	50 bps to 921.6 kbps
Configuration	
Data Bits	5, 6, 7, 8
Stop Bits	1, 1.5, 2
I/O Address/IRQ	BIOS assigned
Parity	None, Even, Odd, Space, Mark
Flow Control	RTS/CTS, XON/XOFF
Power and Environment	
Power Requirement	2356 mA (3.3V)
Operating Temperature	0 to 55°C (32 to 132°F)
Operating Humidity	5 to 95% RH
Storage Temperature	-20 to 85°C (-4 to 185°F)
ESD Protection	Embedded 15 kV ESD Protection
Surge Protection	4 kV
Standards and Certifications	EN55032, EN55024, EN61000-3-2, EN61000-3-3, IEC 61000-4-2, IEC 61000-4-3, IEC 61000-4-4, IEC 61000-4-5, IEC 61000-4-6, IEC 61000-4-8, IEC 61000-4-11 FCC Part 15 Class B
Warranty	5 years

CP-138E-A-I Specifications

Hardware	
Connector	Female DB 78
Comm. Controller	16C550C Compatible
Interface	
Bus Interface	PCI-Express x 1
Number of Ports	8
Max No. of Boards	8
Signal	
RS-422	TxD+(B), TxD-(A), RxD+(B), RxD-(A), GND
4-wire RS-485	TxD+(B), TxD-(A), RxD+(B), RxD-(A), GND
2-wire RS-422	Data+(B), Data-(A), GND
Performance	
Baudrate	50 bps to 921.6 kbps
Configuration	
Data Bits	5, 6, 7, 8
Stop Bits	1, 1.5, 2
I/O Address/IRQ	BIOS assigned
Parity	None, Even, Odd, Space, Mark
Flow Control	RTS/CTS, XON/XOFF
Power and Environment	
Power Requirement	2356 mA (3.3V)
Operating Temperature	0 to 55°C (32 to 132°F)
Operating Humidity	5 to 95% RH
Storage Temperature	-20 to 85°C (-4 to 185°F)
ESD Protection	Embedded 15 kV ESD Protection
Surge Protection	4 kV
Standards and Certifications	EN55032, EN55024, EN61000-3-2, EN61000-3-3, IEC 61000-4-2, IEC 61000-4-3, IEC 61000-4-4, IEC 61000-4-5, IEC 61000-4-6, IEC 61000-4-8, IEC 61000-4-11 FCC Part 15 Class B
Warranty	5 years

CP-134EL-A-I Specifications

Hardware	
Connector	Female DB 44
Comm. Controller	16C550C Compatible
Interface	
Bus Interface	PCI-Express x 1
Number of Ports	4
Max No. of Boards	8
Signal	
RS-422	TxD+(B), TxD-(A), RxD+(B), RxD-(A), GND
4-wire RS-485	TxD+(B), TxD-(A), RxD+(B), RxD-(A), GND
2-wire RS-422	Data+(B), Data-(A), GND
Performance	
Baudrate	50 bps to 921.6 kbps
Configuration	
Data Bits	5, 6, 7, 8
Stop Bits	1, 1.5, 2
I/O Address/IRQ	BIOS assigned
Parity	None, Even, Odd, Space, Mark
Flow Control	RTS/CTS, XON/XOFF
Power and Environment	
Power Requirement	3414 mA (3.3V)
Operating Temperature	0 to 55°C (32 to 132°F)
Operating Humidity	5 to 95% RH
Storage Temperature	-20 to 85°C (-4 to 185°F)
ESD Protection	Embedded 15 kV ESD Protection
Surge Protection	4 kV
Standards and Certifications	EN55032, EN55024, EN61000-3-2, EN61000-3-3, IEC 61000-4-2, IEC 61000-4-3, IEC 61000-4-4, IEC 61000-4-5, IEC 61000-4-6, IEC 61000-4-8, IEC 61000-4-11 FCC Part 15 Class B
Warranty	5 years

CP-116E-A Specifications

Hardware	
Connector	Female SCSI VHDCI68
Comm. Controller	16C550C Compatible
Interface	
Bus Interface	PCI-Express x 1
Number of Ports	16
Max No. of Boards	8
Signal	
RS-232	TxD, RxD, RTS, CTS, DTR, DSR, DCD, GND
RS-422	TxD+(B), TxD-(A), RxD+(B), RxD-(A), GND
4-wire RS-485	TxD+(B), TxD-(A), RxD+(B), RxD-(A), GND
2-wire RS-422	Data+(B), Data-(A), GND
Performance	
Baudrate	50 bps to 921.6 kbps
Configuration	
Data Bits	5, 6, 7, 8
Stop Bits	1, 1.5, 2
I/O Address/IRQ	BIOS assigned
Parity	None, Even, Odd, Space, Mark
Flow Control	RTS/CTS, XON/XOFF
Power and Environment	
Power Requirement	2733 mA (3.3V)
Operating Temperature	0 to 55°C (32 to 132°F)
Operating Humidity	5 to 95% RH
Storage Temperature	-20 to 85°C (-4 to 185°F)
Surge Protection	4 kV
ESD Protection	Embedded 15 kV ESD Protection
Standards and Certifications	EN55032, EN55024, EN61000-3-2, EN61000-3-3, IEC 61000-4-2, IEC 61000-4-3, IEC 61000-4-4, IEC 61000-4-5, IEC 61000-4-6, IEC 61000-4-8, IEC 61000-4-11 FCC Part 15 Class B
Warranty	5 years