

# ioPAC 8020 Modular RTU Controller User's Manual

---

Edition 3.0, February 2017

[www.moxa.com/product](http://www.moxa.com/product)



© 2017 Moxa Inc. All rights reserved.

# ioPAC 8020 Modular RTU Controller User's Manual

The software described in this manual is furnished under a license agreement and may be used only in accordance with the terms of that agreement.

## Copyright Notice

© 2017 Moxa Inc. All rights reserved.

## Trademarks

The MOXA logo is a registered trademark of Moxa Inc.  
All other trademarks or registered marks in this manual belong to their respective manufacturers.

## Disclaimer

Information in this document is subject to change without notice and does not represent a commitment on the part of Moxa.

Moxa provides this document as is, without warranty of any kind, either expressed or implied, including, but not limited to, its particular purpose. Moxa reserves the right to make improvements and/or changes to this manual, or to the products and/or the programs described in this manual, at any time.

Information provided in this manual is intended to be accurate and reliable. However, Moxa assumes no responsibility for its use, or for any infringements on the rights of third parties that may result from its use.

This product might include unintentional technical or typographical errors. Changes are periodically made to the information herein to correct such errors, and these changes are incorporated into new editions of the publication.

## Technical Support Contact Information

[www.moxa.com/support](http://www.moxa.com/support)

### **Moxa Americas**

Toll-free: 1-888-669-2872  
Tel: +1-714-528-6777  
Fax: +1-714-528-6778

### **Moxa Europe**

Tel: +49-89-3 70 03 99-0  
Fax: +49-89-3 70 03 99-99

### **Moxa India**

Tel: +91-80-4172-9088  
Fax: +91-80-4132-1045

### **Moxa China (Shanghai office)**

Toll-free: 800-820-5036  
Tel: +86-21-5258-9955  
Fax: +86-21-5258-5505

### **Moxa Asia-Pacific**

Tel: +886-2-8919-1230  
Fax: +886-2-8919-1231

# Table of Contents

<b>1. Introduction</b>	<b>1-1</b>
ioPAC 8020 Modular RTU Controller	1-2
Product Features	1-2
Package Checklist	1-2
Available Products	1-3
Product Specifications	1-3
Physical Dimensions	1-5
Hardware Reference	1-6
<b>2. Initial Setup</b>	<b>2-1</b>
System Architecture	2-2
Installing the ioPAC on a DIN-Rail	2-2
Removing the ioPAC from the DIN-Rail	2-3
Grounding the ioPAC System	2-3
Inserting/Removing I/O Modules from the ioPAC	2-3
Connecting the Power System	2-4
Connecting to the Network	2-4
<b>3. Utilities</b>	<b>3-1</b>
Introduction to Modular ioAdmin	3-2
Features of ioAdmin	3-2
Modular ioAdmin Main Screen	3-6
Main Screen Overview	3-6
Functions on the Menu Bar	3-6
Watchdog Tab (Administrator)	3-14
Click&Go Logic Tab (Administrator)	3-15
SNMP Tab (Administrator)	3-15
Using TFTP to Import/Export Configuration	3-16
<b>4. Using the Built-in Web Console</b>	<b>4-1</b>
Overview for ioPAC 8020	4-2
Entering the Web Console	4-3
Overview	4-3
Basic Settings	4-3
Network Settings	4-4
<b>5. Click&amp;Go Introduction</b>	<b>5-1</b>
Overview	5-2
Features	5-3
Click&Go Logic Basics	5-3
Working with Rules	5-4
Developing Your Logic Rules	5-5
Define Global Variables	5-5
Internal Register Settings	5-6
Timer Settings	5-6
SNMP Trap Server	5-7
E-Mail Server	5-8
Active Message Server	5-9
IF/THEN/ELSE Statement	5-9
IF Conditions	5-10
THEN/ELSE Actions	5-11
Working with Click&Go Rulesets	5-13
Activating the Ruleset	5-13
<b>6. Hot-swappable I/O Function</b>	<b>6-1</b>
Hot-swappable I/O Function	6-2
Handling Unmatched Module Combination Events	6-3
Disable/Enable "Unmatched I/O Modules" Watchdog	6-4
<b>A. Module Specifications and Wiring</b>	<b>A-1</b>
<b>B. Using Modbus/TCP</b>	<b>B-1</b>
<b>C. Modbus/TCP Address Mappings</b>	<b>C-1</b>
I/O Image Map	C-1
Module Configuration Map (Holding register map)	C-2
System Configuration Map (Input register map)	C-2
Modbus Table	C-3
System Configuration Map	C-3
<b>D. Used Network Port Numbers</b>	<b>D-1</b>
<b>E. SNMP MIB file</b>	<b>E-1</b>

**F. Factory Default Settings..... F-1**

# Introduction

---

The ioPAC 8020 modular RTU controller is a rugged, modularized, and flexible I/O combination system. It is designed for harsh environments, such as rolling stock, mining facilities, etc. The hot swappable I/O modules can connect to various sensors and on/off switches for automation applications and the CPU module provides local intelligence that can communicate over Ethernet and IP-based networks.

The following topics are covered in this chapter:

- ❑ **ioPAC 8020 Modular RTU Controller**
- ❑ **Product Features**
- ❑ **Package Checklist**
- ❑ **Available Products**
- ❑ **Product Specifications**
- ❑ **Physical Dimensions**
- ❑ **Hardware Reference**

# ioPAC 8020 Modular RTU Controller

The ioPAC modular RTU controller is an automation system which combines one CPU module with hot swappable I/O modules. This modularity gives the ioPAC 8020 enormous flexibility. The slice type I/O modules that can connect to any combination of sensors and on/off devices, and can transfer the captured data or device status to a host computer via an Ethernet or IP-based networks. The system is designed for applications in harsh environments. It has wider operation temperature of -40 to 70°C and vibration resistance. The rugged aluminum chassis can resist UV rays to prevent wear and tear.

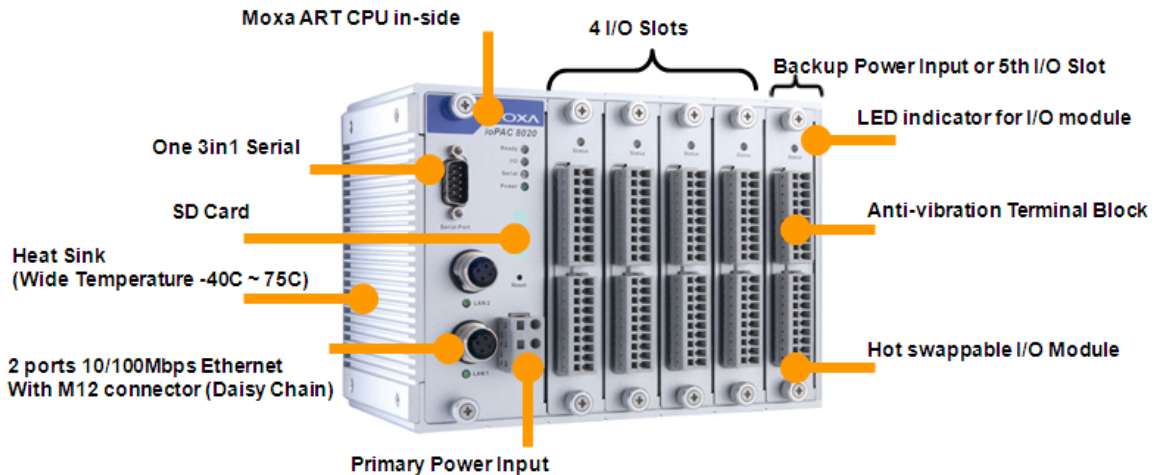

The ioPAC modular RTU controller consists of two major components: the CPU Module, which includes empty I/O slots, and the I/O modules themselves. The CPU module provides the capability for daisy-chain communications over Ethernet networks, includes simple logic control, and powers the whole system. Each CPU module is equipped with five I/O slots for different I/O modules. The last module slot can be filled by a backup power module or an additional I/O module.

## Product Features

- Robust and Compact Design for Harsh Environments
- Two Ethernet switch ports with M12 or RJ45 connectors for Daisy Chain
- Hot-swappable I/O modules
- Auto-detection of Installed Modules
- Event-based Logic with up to 80 rules and Unicode Active Messages
- Built-in Web Console

## Package Checklist

Each ioPAC 8020 and I/O module is packed securely in a small box.

### ioPAC 8020 (if ordered)

- ioPAC 8020 CPU Module with 5 or 9 empty I/O slots × 1
- Software and Documentation CD-ROM × 1
- Accessories Kit × 1 (3 slot covers, 1 DB9 cover, 1 M12 cover, and one RJ45 cabling kit)

### I/O Module (if ordered)

- RM-xxxx I/O module × 1

**NOTE:** Notify your sales representative if any of the above items are missing or damaged.

**NOTE** The 9th slot of the ioPAC 8020-9 series is reserved for future expansion. All I/O modules may only be installed in slot 1 through slot 8.

## Available Products

**ioPAC 8020-5-M12-T:** ioPAC 8020 modular RTU controller with dual M12 Ethernet LAN ports and 5 I/O slots, -40 to 75°C operating temperature

**ioPAC 8020-5-RJ45-T:** ioPAC 8020 modular RTU controller with dual RJ45 Ethernet LAN ports and 5 I/O slots, -40 to 75°C operating temperature

**ioPAC 8020-9-M12-T:** ioPAC 8020 modular RTU controller with dual M12 Ethernet LAN ports and 9 I/O slots, -40 to 75°C operating temperature

**ioPAC 8020-9-RJ45-T:** ioPAC 8020 modular RTU controller with dual RJ45 Ethernet LAN ports and 9 I/O slots, -40 to 75°C operating temperature

**RM-1602-T:** ioPAC I/O module with 16 digital inputs, 24 VDC sink/source type, -40 to 75°C operating temperature

**RM-1050-T:** ioPAC I/O module with 10 digital inputs, 110 VDC, -40 to 75°C operating temperature

**RM-2600-T:** ioPAC I/O module with 16 digital outputs, 24 VDC sink type, -40 to 75°C operating temperature

**RM-3802-T(coming soon):** ioPAC I/O module with 8 analog inputs, 4 to 20 mA, -40 to 75°C operating temperature

**RM-3810-T(coming soon):** ioPAC I/O module with 8 analog inputs, 0 to 10 V, -40 to 75°C operating temperature

## Product Specifications

### System

**CPU:** ARM9 based CPU, 32-bit/160 Mhz

#### SDRAM/Flash:

- ioPAC 8020: 8 MB / 4 MB

**I/O Scan Time:** 100 ms

**Program Cycle Time:** 100 ms

### Ethernet Interface

**LAN:** 2 auto-sensing 10/100 Mbps switch ports (M12 or RJ45)

**Ethernet Bypass Relay Function:** Hardware Normal Close

### Serial Interface (reserved)

**Serial COM1:** RS-232/422/485 (DB9 male)

**Serial Debug Port:** RS-232 (4-pin connector for ioPAC 8020-C and 8020-ISaGRAF)

### Serial Signals (reserved)

**RS-232:** TxD, RxD, DTR, DSR, RTS, CTS, DCD, GND

**RS-422:** TxD+, TxD-, RxD+, RxD-, GND

**RS-485-4w:** TxD+, TxD-, RxD+, RxD-, GND

**RS-485-2w:** Data+, Data-, GND

### Power Requirements

**Input Voltage:** 12 to 36 VDC

**Power Consumption:** CPU Module: 4.40 W @ 24 VDC

### Physical Characteristics

**Housing:** Aluminum

**Mounting:** DIN-Rail, wall, rack mounting (with optional kit)

#### Dimensions:

5-slot Version: 191 x 135 x 100 mm (7.52 x 5.31 x 3.94 in)

9-slot Version: 292 x 135 x 100 mm (11.52 x 5.31 x 3.94 in)

**I/O Module Slots:** 5 or 8 slots

### Environmental Limits

**Operating Temperature:** -40 to 75°C (-40 to 167°F)

**Storage Temperature:** -40 to 85°C (-40 to 185°F)

**Ambient Relative Humidity:** 5 to 95% (non-condensing)

**Altitude:** Up to 2000 m

**Note:** Please contact Moxa if you require products guaranteed to function properly at higher altitudes.

### Standards and Certifications

**Safety:** UL 508 (Pending)

**EMI:** FCC Part 15 Subpart B Class A, EN 55032 Class A

**EMS:**

IEC 61000-4-2 (ESD) Level 2/3,

IEC 61000-4-3 (RS) Level 2,

IEC 61000-4-4 (EFT) Level 2,

IEC 61000-4-5 (Surge) Level 3,

IEC 61000-4-6 (CS) Level 2,

IEC 61000-4-8 (PM) Level 1,

IEC 61000-4-11 (DIPS),

IEC 61000-6-2 (ESD) Level 2/3,

IEC 61000-6-4 (EFT) Level 2

**Shock:** IEC 60068-2-27

**Freefall:** IEC 60068-2-32

**Vibration:** IEC 60068-2-6

**Rail Traffic:** EN 50155, EN 50121-4

**Note:** Please check Moxa's website for the most up-to-date certification status.

### Warranty

**Warranty Period:** 5 years

**Details:** See [www.moxa.com/warranty](http://www.moxa.com/warranty)

**Note:** The SD slot and the serial interface are reserved for future function enhancement.



# Physical Dimensions

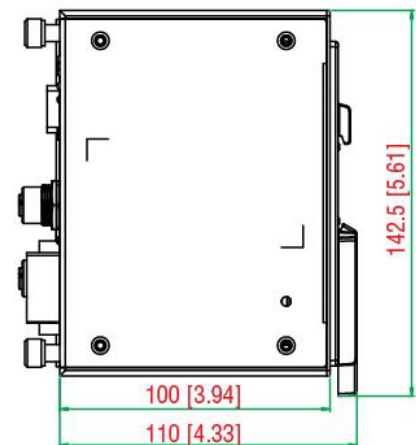
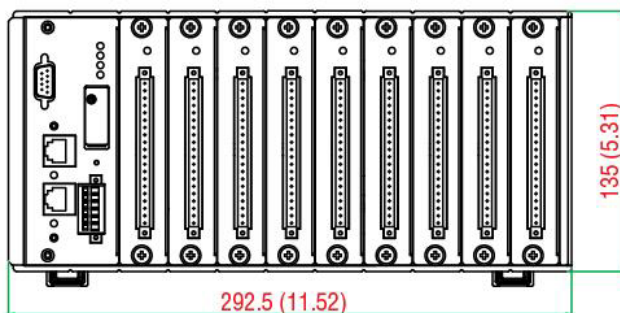
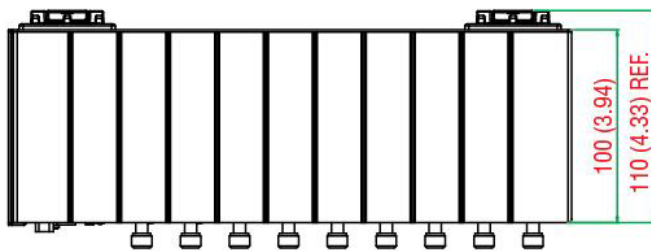
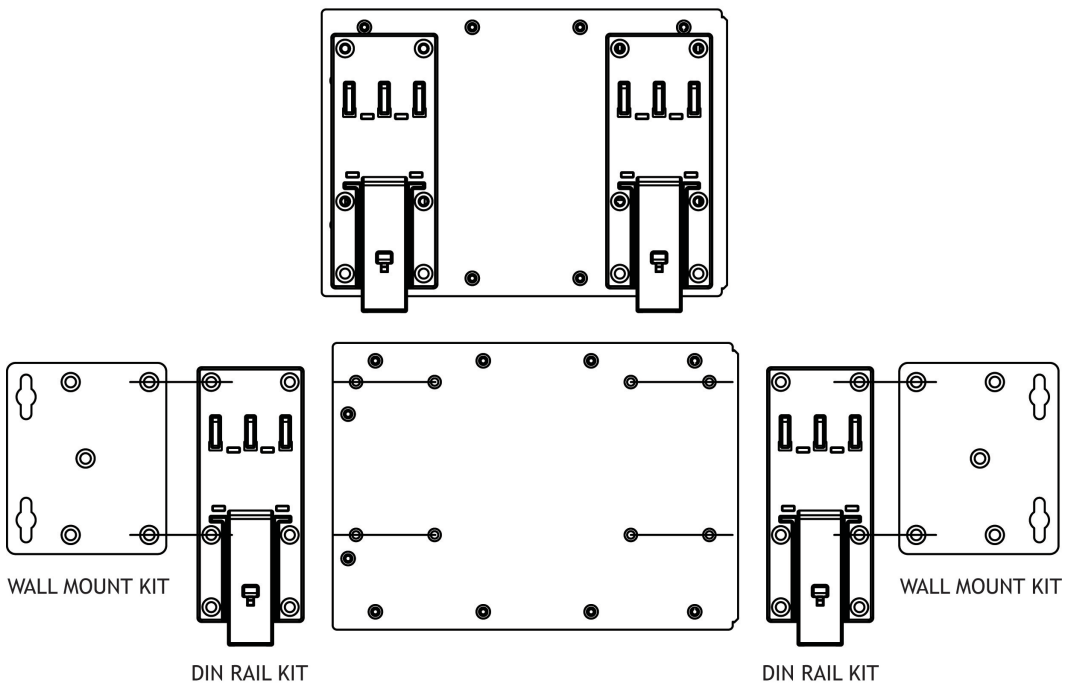
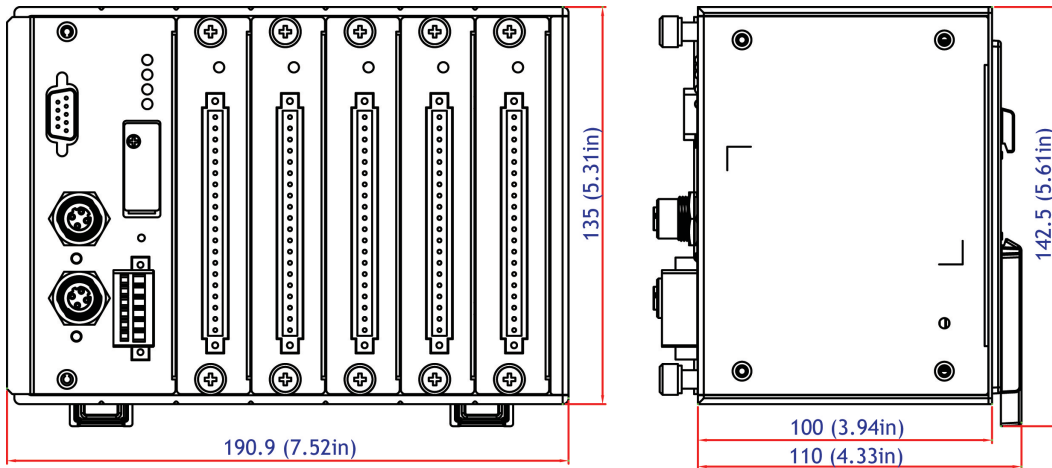

# Hardware Reference

## Panel Guide

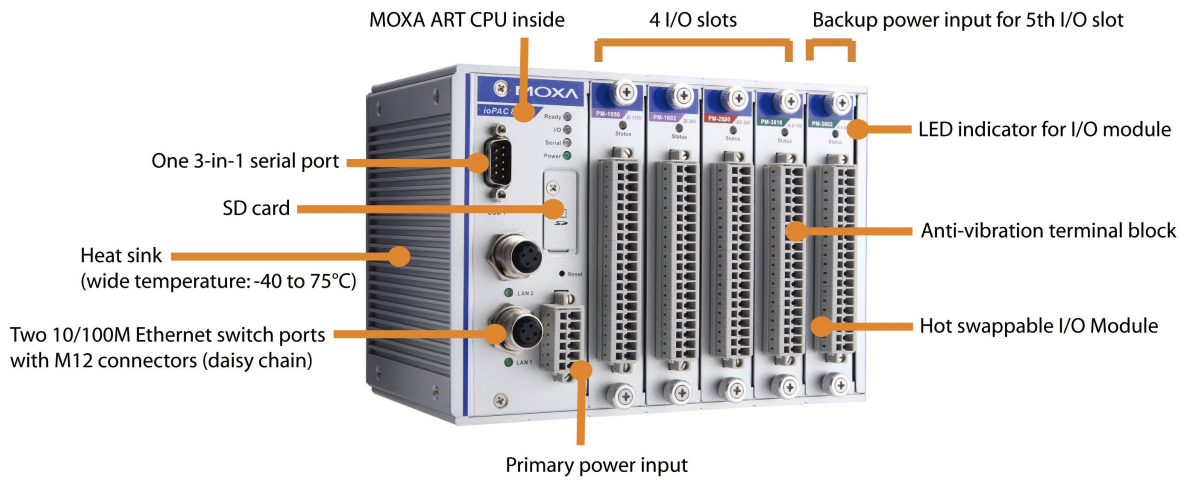

**NOTE** The reset button restarts the server and resets all settings to factory defaults. Use a pointed object such as a straightened paper clip to hold the reset button down for 5 seconds. The READY LED will turn red as you are holding the reset button down. The factory defaults will be loaded once the READY LED turns green again. You may then release the reset button.

## LED Indicators for CPU Module

Group	Pins/Description	Printed label
Ethernet	On the Plug	
Ready	Green: Power On & System working Normally Green Flashing: Click&Go Active Interlaced Green/Red Flashing: Safe Mode Red: System Error	Ready
I/O	Off: I/O Module does not exist Green: Connecting I/O Module and working normally Red: I/O Bus or Modules failure	I/O
Serial	Green: Tx Yellow: Rx Steady Red: Communication Fail	Serial
Power	Green: Normal Input 12 to 36V Red: Voltage out of range Off: No Power	Power

## LED Indicators for I/O Modules

Each DIO or AIO module is equipped with a Module Status LED indicating operation status.

LED Name	LED Color	LED Function
Status	Off	Not powered or Unknown Module
	Green	Steady On: System ready.
	Red	Steady On: I/O module isn't in configuration.

This chapter includes information about installing the ioPAC 8020 and its I/O Modules.

The following topics are covered in this chapter:

▣ **System Architecture**

▣ **Installing the ioPAC on a DIN-Rail**

- Removing the ioPAC from the DIN-Rail
- Grounding the ioPAC System
- Inserting/Removing I/O Modules from the ioPAC
- Connecting the Power System
- Connecting to the Network

# System Architecture

The ioPAC 8020 consists of a CPU module that supports Ethernet and up to 5 RM-xxxx-T I/O modules. The brains of the system is the CPU Module, which collects information from each I/O module and manages their operation. Communication between the ioPAC 8020 and RM-xxxx-T I/O modules occurs through a Modbus/RTU communication bus. Modbus Addresses for each I/O channel are fixed by the ioPAC 8020.

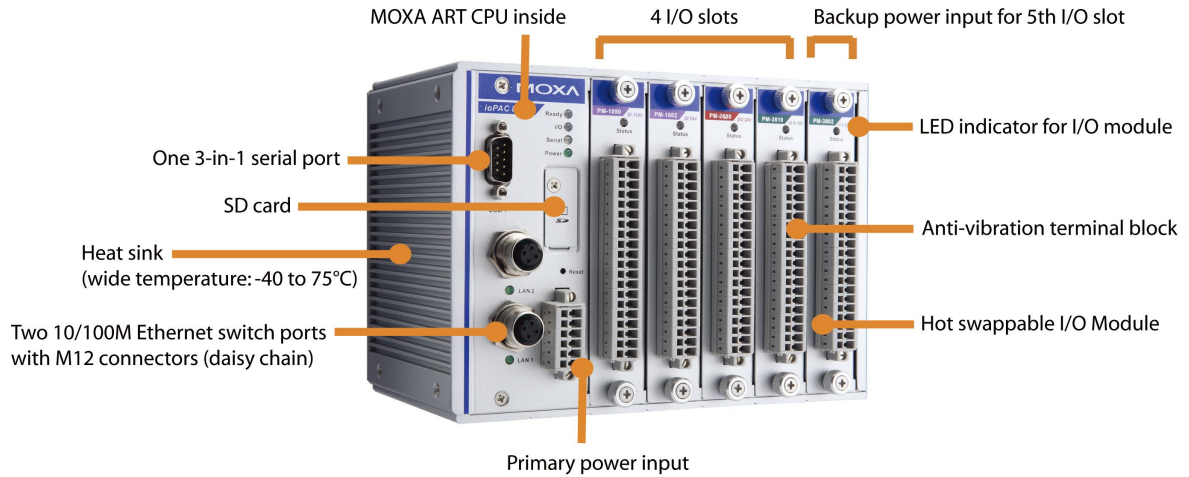

The ioPAC 8020 uses 24 VDC power inputs. One power input is required, and a second one can be used as a backup power input. The ioPAC 8020 provides 5 VDC power to all connected I/O modules. When the total current consumption of the I/O modules exceeds 1.5A, you will need to insert an extra power module.

## Installing the ioPAC on a DIN-Rail

The aluminum DIN-Rail attachment plate should already be fixed to the back panel of the ioPAC 8020 when you take it out of the box. If you need to reattach the DIN-Rail attachment plate to the ioPAC 8020, be sure the spring-loaded bracket is situated towards the bottom, as shown in the following figures.

**NOTE** You can purchase a wall-mounting or rack-mounting kit separately. The ioPAC 8020 mounting kit is identical to the one for the EDS-600.

**STEP 1:** If the spring-loaded bracket is locked in place, push the recessed button to release it. Once released, you should feel some resistance from the spring as you slide the bracket up and down a few millimeters in each direction.

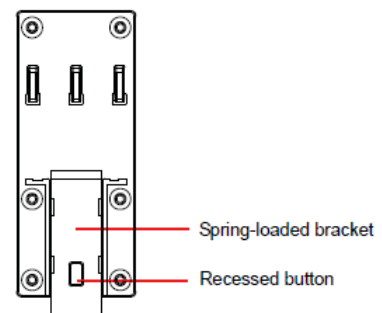

**STEP 2:** Insert the top of the DIN-Rail into the top slots on the DIN-Rail attachment plate.

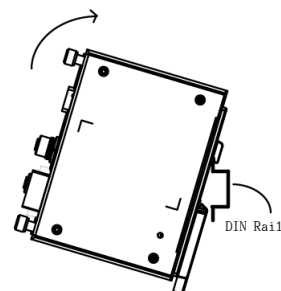

**STEP 3:** The DIN-Rail attachment unit will snap into place as shown in the illustration to the right.

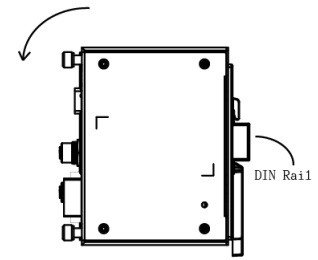

## Removing the ioPAC from the DIN-Rail

To remove the ioPAC 8020 from the DIN-Rail, use a screwdriver to push down the spring-loaded bracket until it locks in place, as shown in the diagram to the right. Next, rotate the bottom of the switch upwards and then remove the switch from the DIN-Rail.

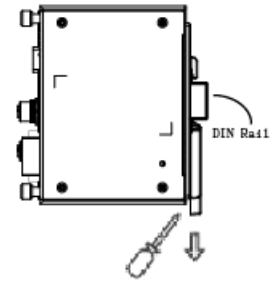

## Grounding the ioPAC System

The ioPAC 8020 is grounded to enhance EMS performance. The ioPAC 8020 comes with metal DIN-Rail brackets for grounding the system. For optimal EMS performance, connect the chassis ground nut on the ioPAC 8020 to the grounding point. The ground nut is located on the right side of the ioPAC 8020.

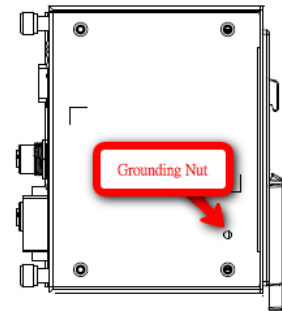

## Inserting/Removing I/O Modules from the ioPAC

The ioPAC 8020 comes with flexible, hot swappable I/O modules. It is easy to manually tighten and loosen the screws.

**When inserting a new I/O module, follow the steps below:**

- Step 1: Feed the I/O module into an empty I/O slot with the PCB clip.
- Step 2: Push down to the end until the connector is matched.
- Step 3: Tighten the I/O module screw.

**While removing the I/O module, following the steps below below**

- Step 1: Loosen the I/O module screws
- Step 2: Remove the I/O module

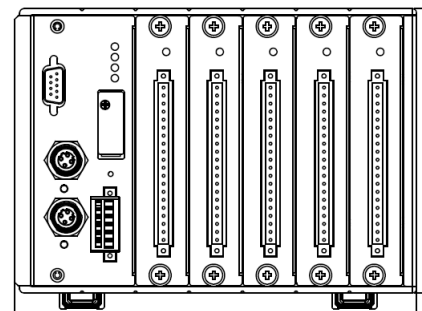

## Connecting the Power System

The ioPAC 8020 requires two 24 VDC power sources. One 24 VDC power input is for system power, and the other power input is for backup power. We recommend that the two power inputs are connected to different power supply systems.



### ATTENTION

#### Disconnect the power before installing and wiring

Disconnect the power cord before installing and/or wiring your ioPAC system.

#### Do not exceed the maximum current for the wiring

Determine the maximum possible current for each power wire and common wire. Observe all electrical codes dictating the maximum current allowable for each wire size. If the current exceeds the maximum rating, the wiring could overheat, causing serious damage to your equipment.

## Connecting to the Network

The ioPAC 8020 supports standard 10/100 Mbps Ethernet. There are two Ethernet switch ports (both of which use the same MAC address) located on the device's front panel. For ioPAC 8020-5/9-RJ45 models, these two ports are used to connect to Ethernet-enabled devices. Most users will choose to configure these ports for Auto MDI/MDI-X mode, in which case the port's pinouts are adjusted automatically depending on the type of Ethernet cable used (straight-through or cross-over), and the type of device (NIC-type or HUB/Switch-type) connected to the port. The following section presents the pinouts for both MDI (NIC-type) ports and MDI-X (HUB/Switch-type) ports. We also give cable wiring diagrams for straight-through and cross-over Ethernet cables.

### 10/100BaseT(X) RJ45 Pinouts

MDI Port Pinouts	
Pin	Signal
1	Tx+
2	Tx-
3	Rx+
6	Rx-

MDI-X Port Pinouts	
Pin	Signal
1	Rx+
2	Rx-
3	Tx+
6	Tx-

8-pin RJ45

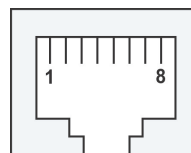

### 10/100BaseT(X) M12 Pinouts

PIN	TX
1	TD+
2	RD+
3	TD-
4	RD-

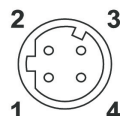

Housing: shield

**Suggestion** For first-time users, we recommend that you link from your host computer to the ioPAC 8020 over a local Ethernet network for initial IP and system configuration. Once the installation is complete, you may move the entire I/O system to the field. Please note that you can insert any LAN port to make the configuration setting work.

**Step1.** Pick one of the two LAN ports and connect the ioPAC 8020 to the host PC with an Ethernet cable. It doesn't matter which port you use. For initial setup of the ioPAC 8020, we assume that the ioPAC 8020 is configured using a direct connection to a host computer.

**Step2.** In Windows, you may need to modify the host computer's IP address to 192.168.127.xxx. (xxx: from 001 to 253) through the Control Panel.

**Step3.** Connect to the ioPAC 8020's IP address for configuration. The default IP is as below:

LAN Port	Default IP Address	Default Netmask	Default Gateway
Port 0 /1	192.168.127.254	255.255.255.0	None

There are two ways to configure the ioPAC 8020. One is to use Modular\_ioAdmin, the other is to use the web console. Once the ioPAC 8020 has been detected, modify the settings as needed for your network environment, then restart the I/O.

3.1: Using Modular\_ioAdmin: Please refer to chapter 3 for details.

3.2: Using the web console: Please refer to chapter 4 for details.

This chapter introduces software utilities you can use when configuring the ioPAC modular RTU controller system. These software utilities include:

- Modular ioAdmin: The main utility which allows you to configure, monitor, and edit Click&Go™.
- TFTP: The utility which allows you to mass deploy the configuration file.

The following topics are covered in this chapter:

### ▣ Introduction to Modular ioAdmin

- Features of ioAdmin

### ▣ Modular ioAdmin Main Screen

- Main Screen Overview
- Functions on the Menu Bar
- Watchdog Tab (Administrator)
- Click&Go Logic Tab (Administrator)
- SNMP Tab (Administrator)

### ▣ Using TFTP to Import/Export Configuration



# Introduction to Modular ioAdmin

The ioPAC system may be managed and configured over the Ethernet with Modular ioAdmin, a Windows utility provided with your ioPAC 8020. Modular ioAdmin's graphical user interface gives you easy access to all status information and settings. Although ioPAC 8020 also supports configuration by web console, full configuration and management is only available through Modular ioAdmin. Modular ioAdmin includes of following functions:

- Complete function settings
- Click&Go™ Logic

**NOTE** To support both 5-slot and 9-slot ioPAC 8020 systems, install Modular ioAdmin V1.4 or above.

## Features of ioAdmin

### Auto search and detection

While connected to the ioPAC 8020, the utility can automatically find how many devices are connected on the network. When you connect successfully, you will see the installed modules on the screen after you login.

You do not need to manually add I/O modules to the configuration one by one. What appears on screen is exactly what you've installed. In addition, it will solve any IP conflicts when you first install two or more ioPAC 8020s to the same network at the same time.

### Remote Management

Modular ioAdmin allows users to find and configure multiple ioPAC 8020 systems over the Ethernet network, and monitor and configure attached I/O devices. You can also test I/O devices and reset the system.

### Click&Go™ Logic Editor

Click&Go™ is an event-based, front-end intelligent logic control system that makes your I/O system smarter. Modular ioAdmin also includes Click&Go logic control for the configuration of your ioPAC system.

### Import/Export files:

Modular ioAdmin allows the import/export of configuration files and device management lists

Modular ioAdmin allows the entire configuration of the ioPAC 8020 system to be saved as a file. The file is viewable as text and can serve as a record or backup of the configuration, or as a template. The file includes file title, date, time, model information, and Click&Go™ rules.

Modular ioAdmin can import and export a list of ioPAC 8020 devices that are being managed. This file can make it easier to manage all devices on the network, and includes server name, module type, IP address, and unit ID.

## Installing Modular ioAdmin Utility

Insert the Software CD from the IoPAC 8020's package into the host computer. Run SETUP.EXE, which is located in the root directory. The installation program will guide you through the installation process and install the ioAdmin utility.

After the installation is complete, run Modular ioAdmin from **Start → Program Files → MOXA → IO Server → Utility → Modular ioAdmin**.



## Connecting your ioPAC 8020 system

After you open Modular ioAdmin, the auto search window will pop up and guide you to find the I/O system. Click "Start Search" to find the I/O system automatically, or you can click "Exit" and then add the ioPAC 8020 system manually.

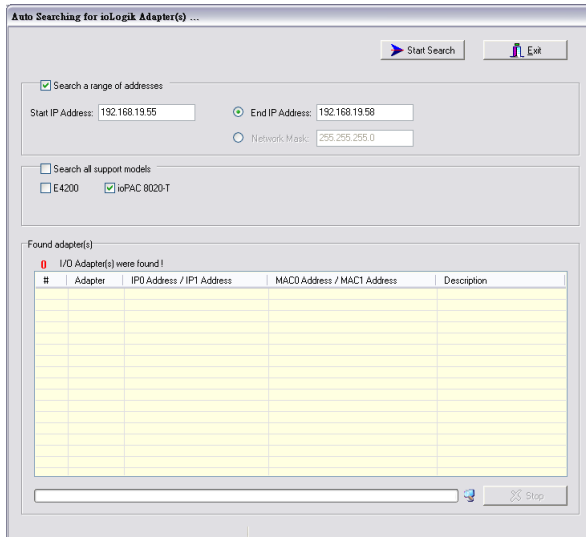

If two or more I/O systems with the same IP address are found, Modular ioAdmin will ask you to modify the IP address in a pop up window, and then reboot the I/O system. If multiple ioPAC 8020 units are installed on the same network, remember that each unit has the same default IP address. You will need to assign a different IP address to each unit to avoid IP conflicts. Modular ioAdmin automatically detects IP conflicts and gives you a chance to modify each unit's IP address in the "IP Address" columns. Click the "Set" button to reboot the corresponding unit with its new IP address. Click the "Re-Search" button to refresh the list of units found by Modular ioAdmin.

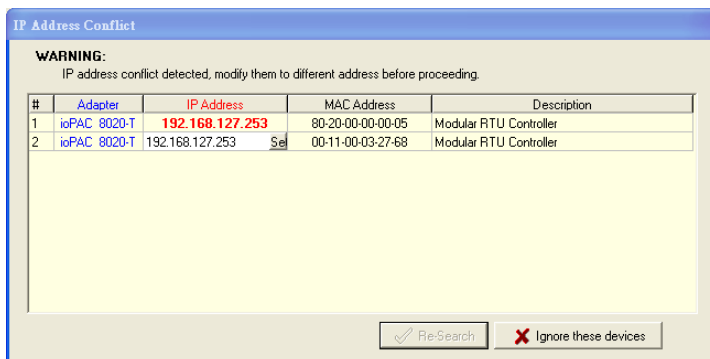

If the connection succeeds, the main screen title will be displayed as below:



### CAN'T FIND DEVICE

If Modular ioAdmin can't find the device, there are two possible causes, described below:

1. There are multiple network interfaces on the host PC. Before searching for devices, be sure to select the correct network interface at menu **bar** → **system** → **Network Interface**.

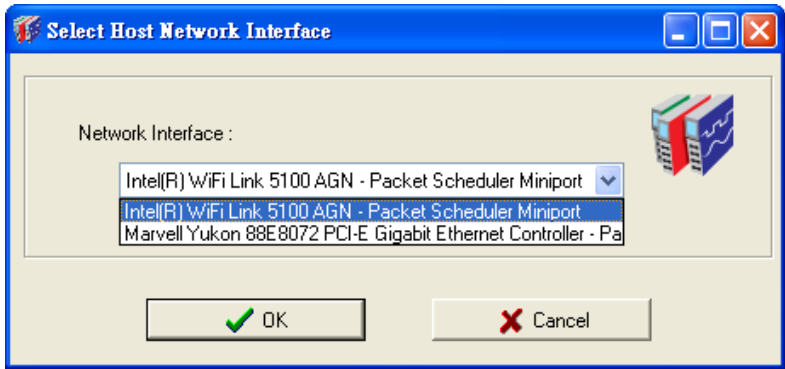

2. The device is not in the same network segment as your host PC. You can add them manually. Click the **Device** tag in the Navigation Panel, and then choose **Add new device**. In the pop out window, key in the IP address of the ioPAC you want to add.

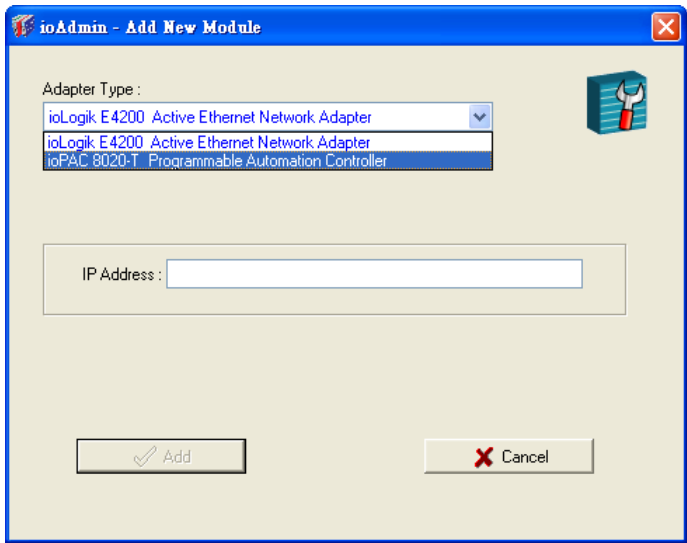

Check the Ethernet cable if the methods above do not solve the problem.

## Login as Administrator

After the ioPAC 8020 is displayed in the main window, select the "Device Settings" Tab. Type in the password and then click the "login" button in order to enter Administrator Mode. The default password is blank.

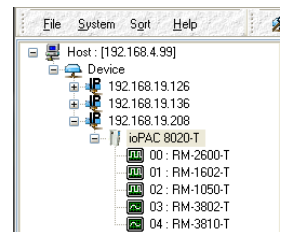

## Auto Detection of Installed Modules



### Module Order Error

Follow the instructions given below if you encounter the **Module Order Error** window.

If you are installing for the first time, you may see the **Module Order Error** window. This is because the first time the system starts successfully, the ioPAC 8020 will store the current module combination and all their settings. If the module combination changes, the ioPAC 8020 will detect this unmatched module configuration and display the warning window below:

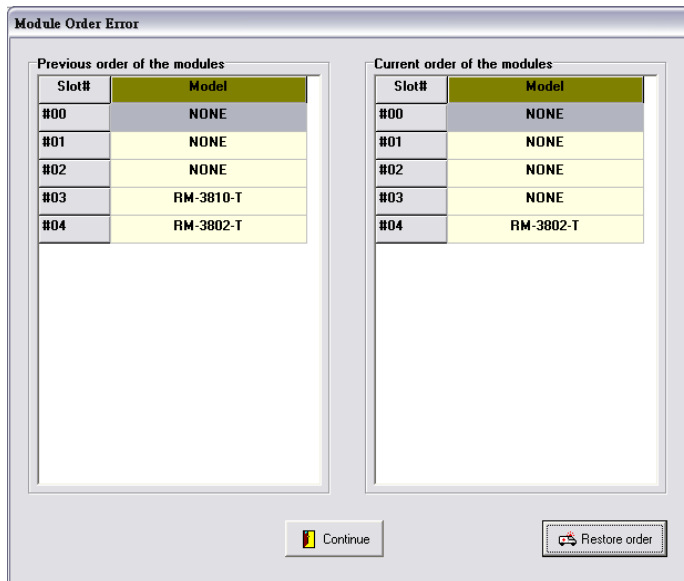

There are two solutions to handle the unmatched module combination event:

1. **Continue:**

This action will apply the currently detected I/O module combination to the system. All configurations of old module are preserved. The removed I/O modules will disappear and added modules will be applied with default settings. The system does not clear any Click&Go™ rules you have saved and you can still start it at your own risk.

2. **Restore order** (Recover to the previous module combination):

This option will maintain the previous I/O module configuration on the system. If you do **NOT** know why the I/O module combination has changed, then choose this. You must shut down the system power and address the incorrect I/O combination problem manually.

### How to Turn Off the Module Order Check

This function cannot be disabled, because incorrect I/O combination are NOT allowed as part of the configuration.

# Modular ioAdmin Main Screen

## Main Screen Overview

This is Modular ioAdmin’s main screen. After the connection between Modular ioAdmin and ioPAC is established, the main window defaults to the **I/O Configuration** tab as illustrated below. The picture displays a figure of the ioPAC 8020 with an empty module below it. The other tabs in the main window take you to Device Information and settings, and further functions are available when you log in as an administrator. Note that configuration options are not available until you log in as an administrator.

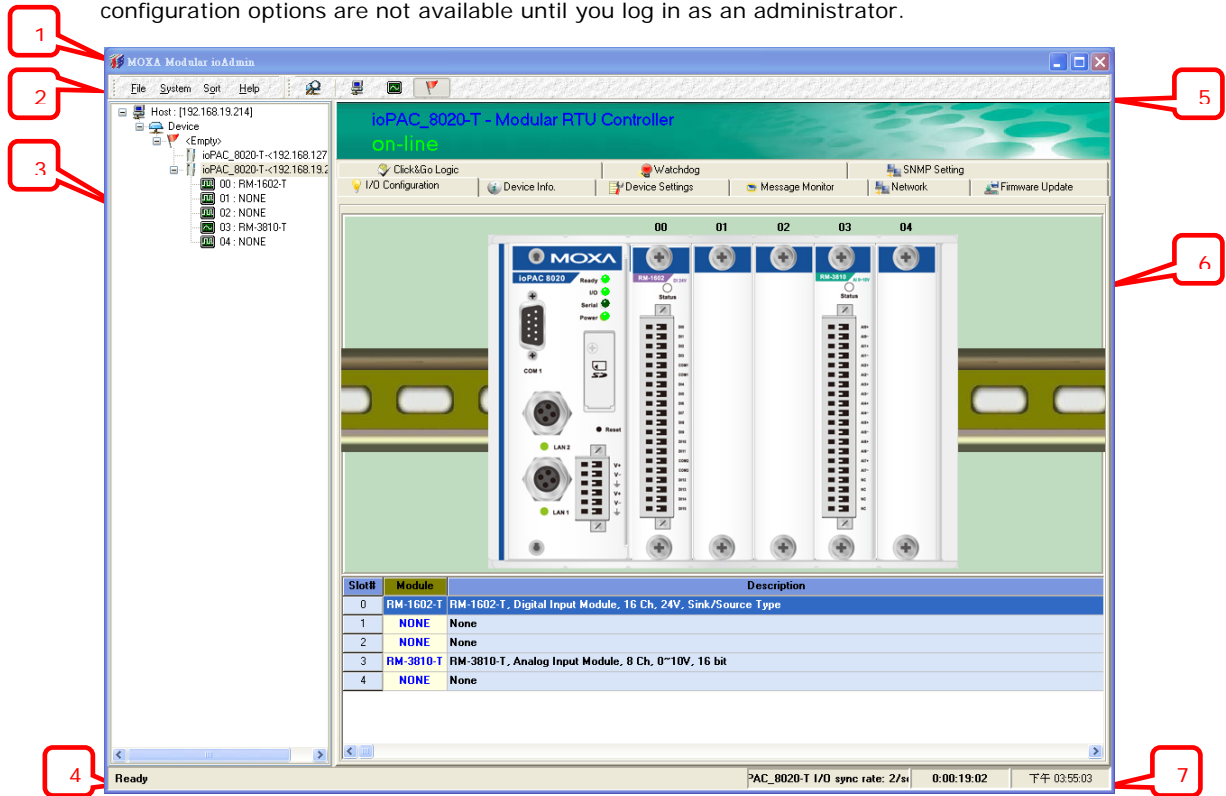

1	Modular ioAdmin Title	5	Quick Link
2	Menu Bar	6	Main Screen
3	Navigation Panel	7	Sync. Rate Information
4	Status Bar		

## Functions on the Menu Bar



### File

From the File menu, you can export the list of devices that are currently displayed in the navigation panel. You also can import a list of devices into Modular ioAdmin. When exporting/importing a device list, you will be prompted to select which devices on the list need to be exported/imported. The file will have a .SLT extension and can be opened as a text file. The device list was made from the record format: **<Module Name>=<Module Type>, <Connection String>, <Unit ID>**, including the following information for each device:

- device name
- module type
- IP address
- unit ID

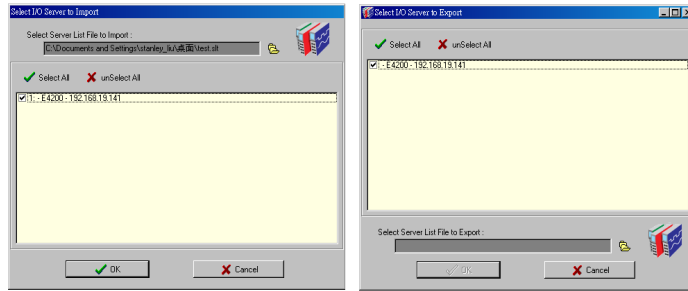

## System

Several operations are possible from the **System** menu.

**Auto Scan Devices** will search for ioPAC 8020 devices on the network. When connecting for the first time or recovering from a network disconnection, you can use this command to find I/O systems that are on the network.

**Network Interface** allows you to select a network to use, if the PC has multiple network interfaces installed.

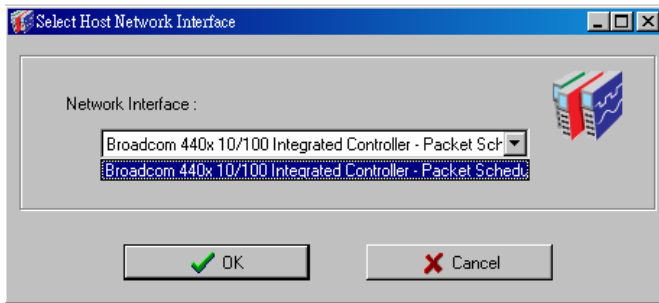

**I/O Status Refresh Interval** is used to adjust how quickly the I/O status synchronizes with Modular ioAdmin. Note that faster sync speeds will result in higher loads on the network. The default value is 500 msec. To change the configuration, fill in the "Interval" column. Note that the unit is in 10 msec increments, so if you enter 100, the refresh rate becomes 1 sec.

**TCP Socket Timeout Interval** allows you to select the preferred timeout value for TCP socket communication.

**Active Message Listen Port** specifies the port number to use for ioPAC 8020 messages. If your network uses a firewall, you can coordinate this setting with your firewall settings to ensure that active messages get through. The default Listen Port is 9001.

## Sort

The Sort menu allows the server list in the navigation panel to be sorted by connection, type, and location.

## Help

In the **Help** menu, you can view the information about Modular ioAdmin.

## Navigation Panel

On this panel, Modular ioAdmin shows information about the Host IP, and how many I/Os are in your system. They are sorted by Server Location by default. You can change the sorting method with the sorting function or on Quick Link. There are three ways to arrange the I/Os: by connection, by location, and by type.

Right click on the ioPAC 8020 tag to add the ioPAC 8020 server manually. Select **Add ioPAC 8020 server**. In the pop-up window, type in the I/O system IP address which you want to add.

Right click the ioPAC 8020 tag to display the Server Context Menu. This menu contains the Connect/Disconnect, Delete I/O server, Restart System, Reset to Default, and Import/Export file functions.

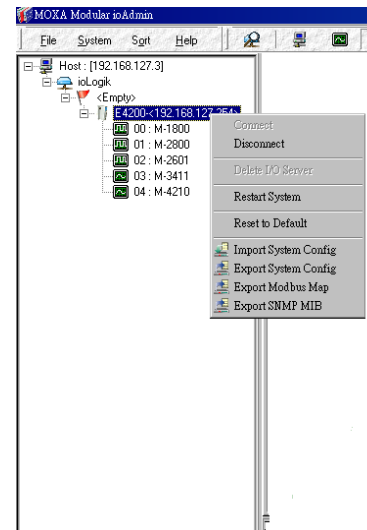

## Server Context Menu

The server context menu is accessed by right clicking on the server model name in the navigation panel.

### Connect

Use this command to have Modular ioAdmin attempt a re-connection over the network to the selected ioPAC 8020.

### Disconnect

Use this command to have Modular ioAdmin drop the network connection with the selected ioPAC 8020.

### Restart System (Administrator Mode Required)

Use this command to restart your ioPAC 8020 system from a remote site. You will need to log in as an administrator to use this function.

### Reset to Default (Administrator Mode Required)

Use this command to reset all settings, including console password, to factory default values. You will need to log in as an administrator to use this function.

### Export/Import System Config (Administrator Mode Required)

Use this command to reload a configuration that was exported to a text file. You will need to log in as an administrator to use this function. You will need to restart the ioPAC 8020 system in order for the new configuration to take effect. This command may be used to restore a configuration after loading the factory defaults, or to duplicate a configuration to multiple ioPAC 8020.





### Export Modbus Map (Administrator Mode Required)

Use this command to export the Modbus Map of the ioPAC 8020 system to a .CSV file. You will need to log in as an administrator to use this function. It is strongly recommended you use this method to record your Modbus Map after you have finished configuring the ioPAC 8020 system for your application.

## Quick Links



Quick links are provided to search for I/O servers on the network and sort the server list.

-  Auto search Device
-  Sort by connection
-  Sort by type
-  Sort by location

## Main Window (General)

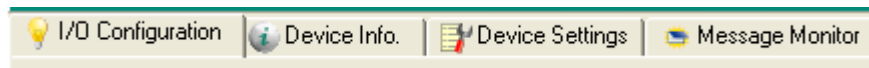

### I/O Configuration Tab (General)

The **I/O Configuration** tab shows a picture of an ioPAC 8020 when you are not logged in. This is the default tab when you first open Modular ioAdmin.

### Device Info Tab

Device information, such as firmware revision, is displayed on the device info tab.

### Device Settings Tab (General)

The Device Settings tab is where you log in as an administrator. This is required in order to gain access to the ioPAC 8020 configuration options. If no administrator password has been set up, simply click on Login and leave the Password for entry field blank. Additional detail is provided later in this chapter.

### Message Monitor Tab

The Message Monitor tab will display any TCP/UDP I/O messages received from the ioPAC 8020. When you install the ioPAC 8020 for the first time, the active I/O messaging ruleset will not have been defined yet, so there will be no messages in the Message Monitor Tab. Please refer to Chapter 5 for information on how to program the ioPAC 8020's active I/O messaging system.

Once the active I/O messaging system has been configured and activated, TCP/UDP messages sent from the ioPAC 8020 will be viewable in the Message Monitor tab.

Messages can be displayed in ASCII, UNICODE or in HEX. To display messages in HEX, make sure that "Toggle HEX" is checked. To display messages in UNICODE, make sure that "UNICODE(UCS-2)" is checked.



## Administrator Functions



For full access to all configuration options, log in as an administrator in the Device Settings tab. This is required whenever you start up ioAdmin or boot up/restart the ioPAC 8020. When you install the ioPAC 8020 for the first time, the password will be blank and you may simply click on **Login**.

Additional functions will available after logging in, including the following new tabs:

- Network
- Firmware Update
- Click & Go Logic
- Watchdog
- SNMP Setting



### ATTENTION

You must log in to access any administrator function, including Network, Communication Watchdog Timer, Firmware Update and SNMP Setting tabs. If you forget the password, you may hold down the ioPAC 8020's reset button to clear the password and load factory defaults. **This will result in the loss of all configuration settings and your Click&Go Logic active I/O messaging program!**

When making configuration changes, you will need to click on Update or on Apply to save the changes. Some changes will require a restart of the ioPAC 8020 system in order to take effect, and you will be given the option to restart the computer if necessary.

## I/O Configuration Tab (Administrator)

When logged on as an administrator, you may click on an IO Module picture in the I/O Configuration tab or click the module name displayed on Navigation Panel, and then double click on a channel to configure that channel's settings. A window will open with Modbus Address, I/O status and Config options (for output module only) for that module.

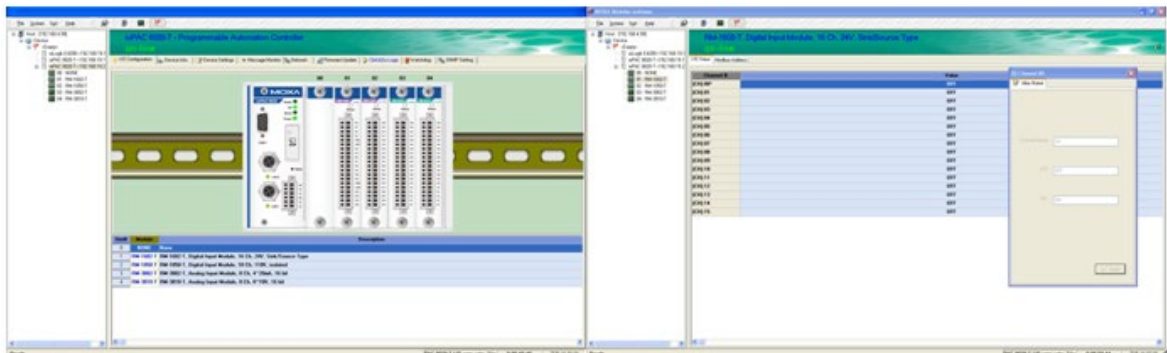

### Modbus Address

In this sub-Tab, there are two sections, Address and Module Information. The Address section displays the channel's Modbus type, such as Discrete Input, Coil, and Register. You can also check the module firmware version in the Module Information section.

I/O Status		Modbus Address	
Discrete Inputs Address			
Channel #	Address	Size (Bit)	
#0	0x0200	1	
#1	0x0201	1	
#2	0x0202	1	
#3	0x0203	1	
#4	0x0204	1	
#5	0x0205	1	
#6	0x0206	1	
#7	0x0207	1	
#8	0x0208	1	
#9	0x0209	1	
#10	0x020A	1	
#11	0x020B	1	
#12	0x020C	1	
#13	0x020D	1	
#14	0x020E	1	
#15	0x020F	1	

Module Information			
Address #	Value/Status	Access	Description
0x3202	1.000	Read	Firmware Revision

### I/O Status

This tab displays the channel values and channel names. It also allows you to assign the alias name to the channel and ON or OFF status. You can drag the border to enlarge or reduce the column width.

Channel #	Value
[CH]:00*	OFF
[CH]:01	OFF
[CH]:02	OFF
[CH]:03	OFF
[CH]:04	OFF
[CH]:05	OFF
[CH]:06	OFF
[CH]:07	OFF
[CH]:08	OFF
[CH]:09	OFF
[CH]:10	OFF
[CH]:11	OFF
[CH]:12	OFF
[CH]:13	OFF
[CH]:14	OFF
[CH]:15	OFF

### Config (For output modules only)

The list in this tab displays the module safe mode settings, such as Power On, Disconnection, and system failure.

I/O Status		Config		Modbus Address	
Channel #	Safe Mode Setting	Fault Value	Power On Setting		
[CH]:00*	Fault Value	OFF	OFF		
[CH]:01	Fault Value	OFF	OFF		
[CH]:02	Fault Value	OFF	OFF		
[CH]:03	Fault Value	OFF	OFF		
[CH]:04	Fault Value	OFF	OFF		
[CH]:05	Fault Value	OFF	OFF		
[CH]:06	Fault Value	OFF	OFF		
[CH]:07	Fault Value	OFF	OFF		
[CH]:08	Fault Value	OFF	OFF		
[CH]:09	Fault Value	OFF	OFF		
[CH]:10	Fault Value	OFF	OFF		
[CH]:11	Fault Value	OFF	OFF		
[CH]:12	Fault Value	OFF	OFF		
[CH]:13	Fault Value	OFF	OFF		
[CH]:14	Fault Value	OFF	OFF		
[CH]:15	Fault Value	OFF	OFF		

You can double click to enter the setting. After you double click, the channel setting window will pop up. It allows you to set the safe mode, power on status, test I/O, and assign an alias name.

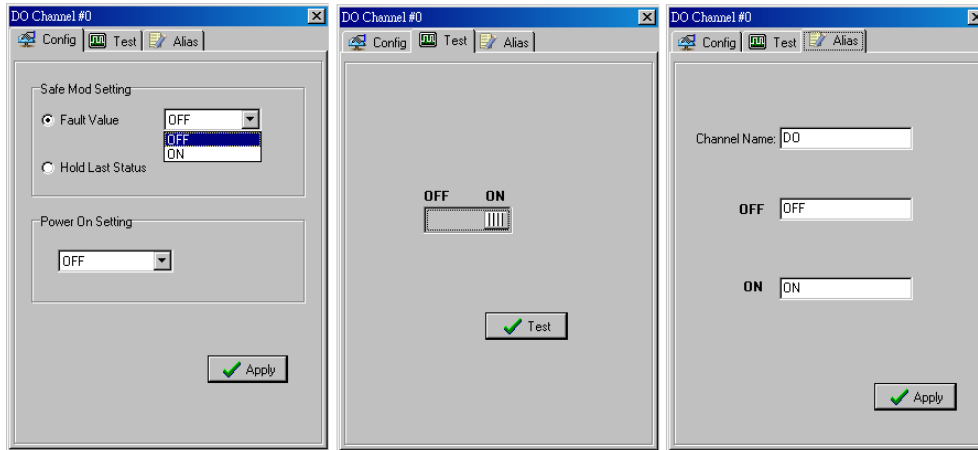

### Safe Status Settings

Use this field to specify how the I/O channel behaves when the network connection is lost. When the network connection is lost for the amount of time specified in the Host Connection Watchdog, the ioPAC 8020 enters Safe Status, and each I/O channel's Safe Status settings will go into effect.

### Power On Settings (Output Channel Only)

Use this field to set the initial behavior of the DO/AO channel when the ioPAC 8020 system is powered on. For DO channels, you may configure whether or not the DO is set to OFF or ON at power up.

### Test I/O

You may test the DO channel by using Modular ioAdmin

### I/O Alias Name

You may define your own I/O channel Name and I/O status by using Modular ioAdmin

**NOTE** There are two situations that will cause the ioPAC modular RTU controller to enter Safe Status. One is if the Host connection is lost, the other is if the internal I/O bus fails. When the ioPAC 8020 is in safe mode, the user can not start Click&Go logic and the user can not change the module configuration.

1. Host Connection lost: The "I/O" LED will be lit steady Red.

The Host Connection Watchdog is disabled by default. If the Host Connection Watchdog is disabled, the ioPAC 8020 system will never enter Safe Status and the Safe Status settings will have no effect.

2. Hot Plug I/O Module: The "I/O" LED will be lit flashing Red. Please check your I/O system installation.

## Device Settings Tab (Administrator)

There are three sections in this Tab: **Password**, **Management Settings**, and **Time settings**. You may set up a password, device name, location, date, time zone, and time server in the Device Settings tab. Modular ioAdmin supports long device names and a location description of up to 58 chars.

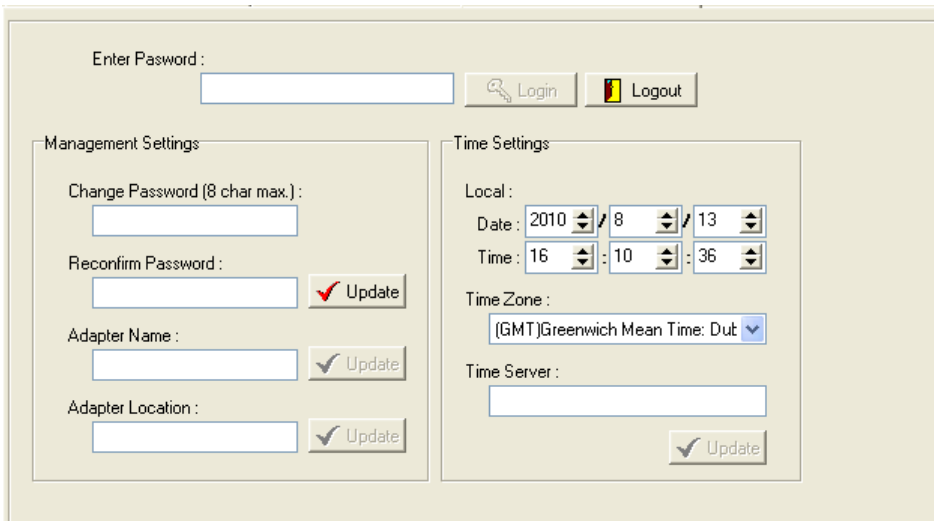

## Network Tab (Administrator)

The Network tab is where you configure **IP settings**, **Modbus/TCP Alive Check Timeout settings**, **DNS settings**, and **Web Access settings** for the ioPAC 8020.

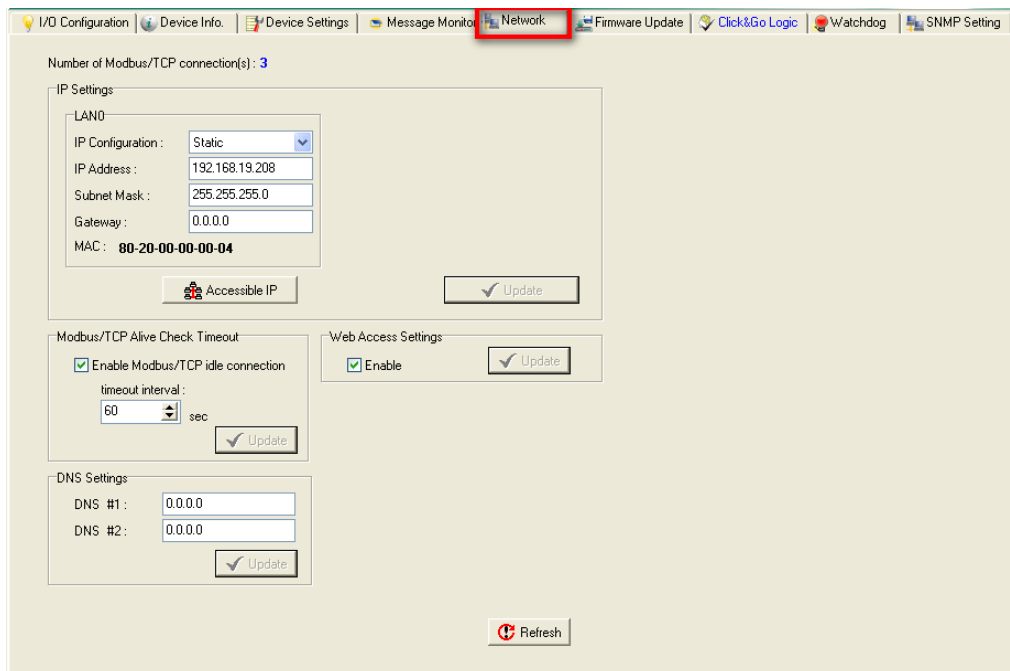

**IP Settings:** You can set up a static or dynamic IP address for both of the ioPAC 8020 LAN ports, as well as the subnet mask and gateway address.

The Accessible IP screen can be used to control network access to the ioPAC 8020 and attached sensors. Network requests that originate from sources that are not listed in the accessible IP list will be unable to use Modbus/TCP or Modular ioAdmin to access the ioPAC 8020.

**Modbus/TCP Alive Check Timeout Settings:** The Modbus/TCP Alive Check Timeout is designed to avoid TCP connection failure. When the host is down, the ioPAC 8020 will continue to wait for a response from the host. This will cause the TCP port to be indefinitely occupied by the host. When the Modbus/TCP idle connection timeout interval is enabled, the ioPAC 8020 will close the TCP connection automatically if there is no TCP activity for the specified time. Please note that Modbus/TCP connections will be blocked when setting up Accessible IP.

**DNS Settings:** Use this field to specify the IP addresses of up to two DNS servers. These two DNS servers may be used to automatically find available e-mail addresses when configuring for ioPAC 8020 e-mail messaging.

**Web Access Settings:** This field enables and disables the ioPAC 8020's web console. The web console allows the configuration of many settings using a web browser that is directed to the server's IP address. If the web console is not enabled in this field, you will not be able to access the web console.

## Firmware Update Tab (Administrator)

The ioPAC 8020 supports remote firmware updates through the **Firmware Update** tab. Enter the path to the firmware file or click on the icon to browse for the file. Click **Update** to update the firmware. The wizard will lead you through the process until the server is restarted.

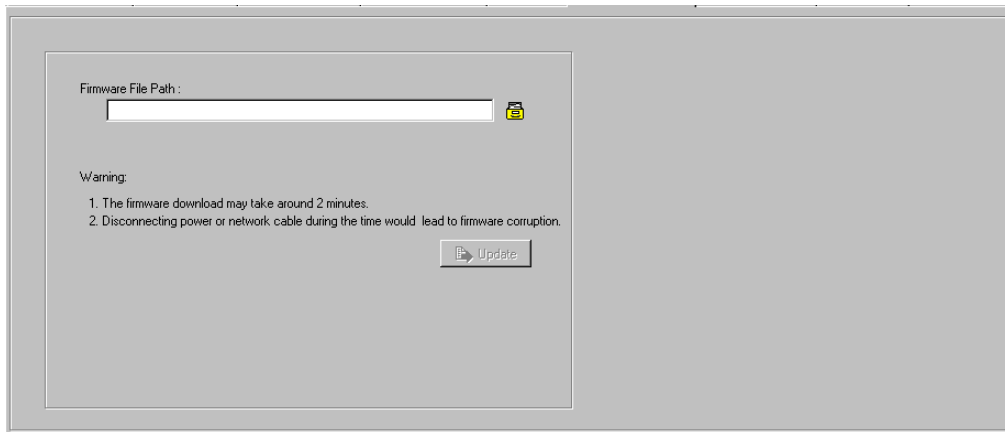

### WARNING

**Do not interrupt the firmware update process!** An interruption in the process may result in your device becoming unrecoverable. After the firmware is updated, the ioPAC 8020 will restart and you must log in again to access administrator functions.

## Watchdog Tab (Administrator)

Click the **Watchdog** tab to configure the conditions for entering Safe Mode. While the ioPAC 8020 is in Safe Mode, it will stop Click&Go and force each output channel to keep its predefined Safe Status setting. Once the system enters Safe Mode, the LED indicator will blink red and green.

- Enable Host Connection Watchdog:** Check this option to see if the Modbus/TCP connection is still alive. If it isn't, the system will enter safe mode. When the ioPAC 8020 loses its network connection for the amount of time specified in the timeout, the Host Connection Watchdog will switch the ioPAC 8020 to Safe Status and the output channels will reset to their Safe Status settings. Click&Go will stop and the Ready LED will flash red and green. By default, the Host Connection Watchdog is disabled. When you enable this option, be sure to set a Timeout value and then click the Update button.

2. **Unmatched I/O modules:** When enabled, the system will check the I/O module combination and sequence while the system is powering on or an I/O module is plugged in or not plugged in. Once the I/O module combination is changed, the watchdog will switch the ioPAC 8020 to Safe Status and the output channels will reset to their Safe Status settings. Click&Go will stop and the I/O LED indicator will flash red and green. This option is enabled by default.

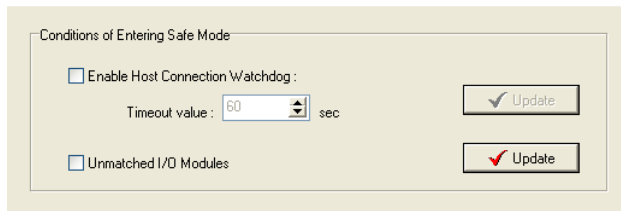

After **one of these two conditions** is enabled, the ioPAC 8020 will enter safe status. Click the Watchdog Tab to exit safe status. The system will display the message **Host Connection Lost Alarm or I/O Error**, indicating that the system is in safe status. Click Clear Alarm to exit safe status and return to normal operation manually.

**NOTE** While the ioPAC 8020 is in safe mode, you cannot start Click&Go logic nor change the module configuration. These two options are disabled by default. If they are disabled, the ioPAC 8020 system will never enter Safe Status and the Safe Status settings will have no effect.

## Click&Go Logic Tab (Administrator)

The Click&Go Logic tab is where administrators set up the ioPAC 8020's active I/O messaging program. Instead of the server reacting passively to repeated polling requests from a host for I/O data, the ioPAC 8020 is able to actively send I/O information to the host when an I/O channel satisfies conditions that you specify. Moxa developed Click&Go logic to provide a powerful and easy-to-use tool for defining the conditions under which I/O information will be sent over the network. Please refer to Chapter 6 for more detailed information.

Changes made in the Click&Go Logic tab are not effective until the ioPAC 8020 is restarted, just like changes made in other tabs.

**NOTE** Note that when Click&Go Logic is being used, the range and units of I/O channel being used in Click&Go Logic may not be modified.

## SNMP Tab (Administrator)

The ioPAC supports SNMP V1, V2c, and V3 (Simple Network Management Protocol) to monitor network and I/O devices with SNMP Network Management software. It is useful in building automation and telecom applications. Use these fields to enable SNMP and set the read and write community strings for SNMP V1 and V2c, or use authentication for SNMP V3.

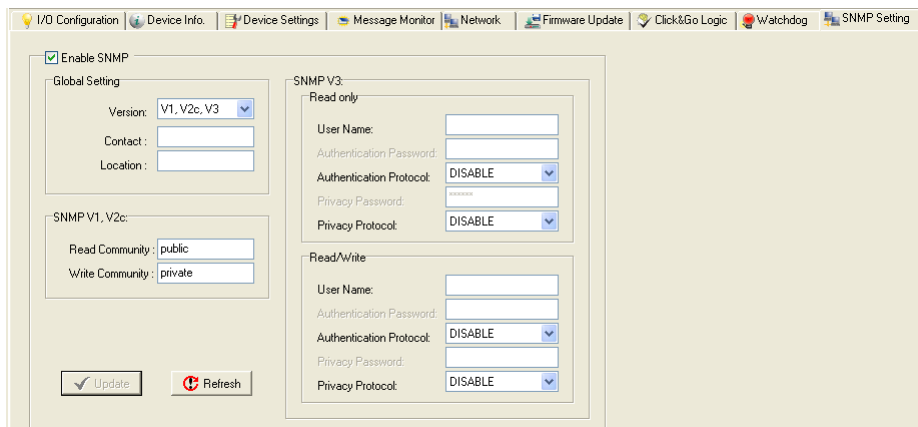

## Using TFTP to Import/Export Configuration

TFTP (Trivial File Transfer Protocol) was defined in 1980 to provide basic FTP functionality in a very simple protocol. Due to TFTP's simplicity, it can be implemented using a very small amount of memory, an important consideration when it was first developed. ioPAC 8020 supports the use of TFTP to import or export configuration files.

The following is an example using Windows TFTP and an ioPAC 8020 with an IP address of 192.168.127.254:

1. Enter "TFTP 192.168.127.254 GET ik8020.txt" to get the ioPAC's configuration file.
2. Enter "TFTP 192.168.127.254 PUT ik8020.txt" to load a configuration file onto the ioPAC.

```
Transfers files to and from a remote computer running the TFTP service.

TFTP [-i] host [GET | PUT] source [destination]

-i          Specifies binary image transfer mode (also called
           octet). In binary image mode the file is moved
           literally, byte by byte. Use this mode when
           transferring binary files.

host       Specifies the local or remote host.

GET        Transfers the file destination on the remote host to
           the file source on the local host.

PUT        Transfers the file source on the local host to
           the file destination on the remote host.

source     Specifies the file to transfer.

destination Specifies where to transfer the file.
```

You must use "ik8020.txt" as the destination filename when copying a configuration file to the ioPAC 8020 unit. Otherwise, you will receive an error message as shown below:

```
Error on server : ioServer - Fail to write file !!cess Protocol
pcmail-srv      158/tcp          #PCMail Server
snmp            161/udp          #SNMP
snmptrap        162/udp          snmp-trap      #SNMP trap
print-srv       170/tcp          #Network PostScript
bgp             179/tcp          #Border Gateway Protocol
irc            194/tcp          #Internet Relay Chat Protocol
!
ipx            213/udp          #IPX over IP
ldap           389/tcp          #Lightweight Directory Access
s Protocol
https          443/tcp          MCom
https          443/udp          MCo
https          443/tcp          MCom
https          443/udp          MCo? ▯
```

You can use TFTP in a batch file to transfer configuration files for different units. For example, you might have two configuration files that need to be copied to two different servers: **ik8020\_1.txt** for 192.168.127.253, and **ik8020\_2.txt** for 192.168.127.254. A batch file could be written as follows:

```
tftp 192.168.127.253 put ik8020_1.txt ik8020.txt
tftp 192.168.127.254 put ik8020_2.txt ik8020.txt
```

# Using the Built-in Web Console

---

This chapter introduces built-in web console when monitoring the ioPAC modular RTU controller system.

The following topics are covered in this chapter:

▣ **Entering the Web Console**

▣ **Overview**

- Basic Settings
- Network Settings



# Overview for ioPAC 8020

The ioPAC modular RTU controller web console is a browser-based configuration utility which is built into the ioPAC 8020. When the ioPAC modular RTU controller is connected to your network, you may enter the I/O's IP address in your web browser to access the web console. Note that although most configuration options are available in the web console, some settings are only available through Modular ioAdmin. Furthermore, the web console can be disabled under Web Access Settings in Modular ioAdmin. If you are unable to access the web console, check the Web Access Settings in Modular ioAdmin.

Channel	RM-1602-T	RM-2600-T	RM-1050-T	RM-3802-T	Empty
1	OFF	OFF	OFF	4.000mA	--
2	OFF	OFF	OFF	4.000mA	--
3	OFF	OFF	OFF	4.000mA	--
4	OFF	OFF	OFF	4.000mA	--
5	OFF	OFF	OFF	4.000mA	--
6	OFF	OFF	OFF	4.000mA	--
7	OFF	OFF	OFF	4.000mA	--
8	OFF	OFF	OFF	4.000mA	--
9	OFF	OFF	OFF	--	--
10	OFF	OFF	OFF	--	--
11	OFF	OFF	--	--	--
12	OFF	OFF	--	--	--
13	OFF	OFF	--	--	--
14	OFF	OFF	--	--	--
15	OFF	OFF	--	--	--
16	OFF	OFF	--	--	--

The top panel of the web console always shows the device information, such as ioPAC 8020 Model Name, Serial Number, Firmware version, IP, and MAC.

The left panel is the navigation panel and contains an expandable menu tree for navigating among the various settings and categories. When you click on a menu item in the navigation panel, the main window will display the corresponding options for that item.

The remaining panel is the main window. The window shows the contents of the currently selected page in the navigation panel. For example, if you click on **Basic Settings** in the navigation panel, the main window will show a page of basic settings that you can configure.

You must click on the **Submit** button after making configuration changes. The **Submit** button is always located at the bottom of every page that has configurable settings. If you navigate to another page without clicking the Submit button, your changes will not be retained. **Submitted changes will not take effect until they are saved and the ioPAC 8020 is restarted!**

You may save and restart the server in one step by clicking on the **Save/Restart** button after you submit a change. If you need to make several changes before restarting, you may save your changes without restarting by selecting **Save/Restart** in the navigation panel. If you restart the ioPAC 8020 without saving your configuration, the ioPAC 8020 will discard all submitted changes.

# Entering the Web Console

The main configuration interface for ioPAC modular RTU controller relies on the Modular ioAdmin utility. However, information about basic system status is available through the ioPAC 8020's web console.

Enter the IP address of the The ioPAC modular RTU controller in Internet Explorer.

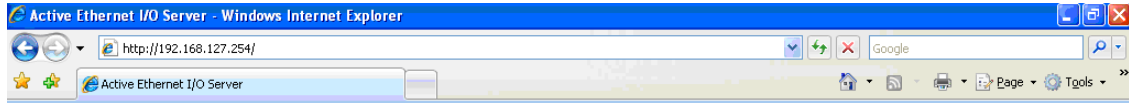

The default IP listed as below:

LAN Port	Default IP Address	Default Netmask	Default Gateway
Port 0/1	192.168.127.254	255.255.255.0	None

## Overview

When you log in to the web console, you will see the welcome page, which shows all of the I/O statuses and I/O modules for the current system on one page. Press "F5" to refresh the page and update the I/O status.

<b>Model</b> - ioPAC 8020-T	<b>IP</b> - 192.168.19.203	<b>MAC Address</b> - 00-11-00-03-27-68	<b>Serial No.</b> - 32768	<b>Firmware</b> - V1.1 Build10101313
<b>Name</b> -	<b>System Elapsed Time</b> - 000:01:55			
<b>Location</b> -				

Welcome to ioPAC 8020-T Family

Channel	RM-1602-T	RM-2600-T	RM-1050-T	RM-3802-T	Empty
1	OFF	OFF	OFF	4.000mA	--
2	OFF	OFF	OFF	4.000mA	--
3	OFF	OFF	OFF	4.000mA	--
4	OFF	OFF	OFF	4.000mA	--
5	OFF	OFF	OFF	4.000mA	--
6	OFF	OFF	OFF	4.000mA	--
7	OFF	OFF	OFF	4.000mA	--
8	OFF	OFF	OFF	4.000mA	--
9	OFF	OFF	OFF	--	--
10	OFF	OFF	OFF	--	--
11	OFF	OFF	--	--	--
12	OFF	OFF	--	--	--
13	OFF	OFF	--	--	--
14	OFF	OFF	--	--	--
15	OFF	OFF	--	--	--
16	OFF	OFF	--	--	--

## Basic Settings

On the Basic Settings page, you may set the ioPAC 8020's system time or provide the IP address of a time server for time synchronization.

Main Menu - ioPAC 8020-T

- Overview
- Basic Settings
- Network Settings
- System Management
- Change Password
- Load Factory Default
- Save/Restart

### Basic Settings

Time Settings

**Time zone (24 hour)** (GMT+12:00)Fiji, Kamchatka, Marshall Is.

**Local time** 2010 / 10 / 13 05 : 53 : 26 [ Modify ]

**Time server** time.nist.gov

**Web console**  Enable  Disable

# Network Settings

## General settings

On the General Settings page, you may assign a device name and location to assist you in differentiating between different ioPAC 8020s. You may also enable the Host Communication Watchdog and define the timeout value.

The screenshot shows the 'Adapter Settings' page in the web console. On the left is a navigation menu with the following items: Overview, Basic Settings, - Network Settings, Adapter Settings (highlighted), Ethernet Configurations, - System Management, Change Password, Load Factory Default, and Save/Restart. The main content area is titled 'Adapter Settings' and contains a sub-section 'I/O Adapter Settings'. This section includes:
 

- 'Adapter name' and 'Adapter location' fields, both currently empty.
- 'Enable communication watchdog' checkbox, which is checked.
- A timeout value of '60' in a text box, followed by the unit 'sec'.
- A 'Submit' button at the bottom.

The Host Connection Watchdog activates Safe Status when the ioPAC 8020 loses its network connection for the specified amount of time. By default, the Watchdog is disabled. When the Watchdog is enabled and a timeout occurs, the ioPAC 8020 will enter Safe Status. You may use Modular ioAdmin to configure how each output channel responds in that channel's Safe Status settings. To enable the Watchdog, check off **Enable connection watchdog**, set the timeout value, and restart the I/O system. With Watchdog enabled, the ioPAC 8020 will enter Safe Status after there is disruption in communication that exceeds the time specified.

## Ethernet Configuration

On the Ethernet Configuration page, you may set up a static or dynamic IP address for the ioPAC 8020 I/O system, as well as the subnet mask and gateway address.

The screenshot shows the 'Ethernet Configurations' page in the web console. The navigation menu on the left is identical to the previous screenshot, with 'Ethernet Configurations' highlighted. The main content area is titled 'Ethernet Configurations' and contains a sub-section 'LAN-0 Ethernet Parameters'. This section includes:
 

- 'IP configuration' dropdown menu, set to 'Static'.
- 'IP address' text box containing '192.168.19.208'.
- 'Subnet mask' text box containing '255.255.255.0'.
- 'Gateway' text box containing '0.0.0.0'.
- 'DNS server 1' text box containing '0.0.0.0'.
- 'DNS server 2' text box containing '0.0.0.0'.
- A 'Submit' button at the bottom.

# System Management

## Accessible IP

You may add a specific address or range of addresses by using a combination of IP address and Netmask, as follows:

**Accessible IP Settings**

Enable the accessible IP list ("Disable" will allow all IP's connection request.)

No.	Active	IP Address	Netmask
1	<input type="checkbox"/>	<input type="text"/>	<input type="text"/>
2	<input type="checkbox"/>	<input type="text"/>	<input type="text"/>
3	<input type="checkbox"/>	<input type="text"/>	<input type="text"/>
4	<input type="checkbox"/>	<input type="text"/>	<input type="text"/>
5	<input type="checkbox"/>	<input type="text"/>	<input type="text"/>
6	<input type="checkbox"/>	<input type="text"/>	<input type="text"/>
7	<input type="checkbox"/>	<input type="text"/>	<input type="text"/>
8	<input type="checkbox"/>	<input type="text"/>	<input type="text"/>
9	<input type="checkbox"/>	<input type="text"/>	<input type="text"/>
10	<input type="checkbox"/>	<input type="text"/>	<input type="text"/>

### To allow access to a specific IP address

Enter the IP address in the corresponding field; enter **255.255.255.255** for the netmask.

### To allow access to hosts on a specific subnet

For both the IP address and netmask, use 0 for the last digit (e.g., **192.168.1.0** and **255.255.255.0**).

### To allow unrestricted access

Deselect the **Enable the accessible IP list** option.

Refer to the following table for additional configuration examples.

Allowed Hosts	IP address/Netmask
Any host	Disable
192.168.1.120	192.168.1.120 / 255.255.255.255
192.168.1.1 to 192.168.1.254	192.168.1.0 / 255.255.255.0
192.168.0.1 to 192.168.255.254	192.168.0.0 / 255.255.0.0
192.168.1.1 to 192.168.1.126	192.168.1.0 / 255.255.255.128
192.168.1.129 to 192.168.1.254	192.168.1.128 / 255.255.255.128

## SNMP Agent

On the SNMP Agent page, you may enable SNMP and set the read and write community strings. The ioPAC 8020 provides SNMP v1/v2c/v3 (Simple Network Management Protocol) to allow monitoring of network and I/O devices with SNMP Network Management software.

**SNMP Agent**

**Configurations**

SNMP  Enable  Disable

SNMP Agent Version: V1,V2c,V3

Read Community Name: public

Write Community Name: private

Contact: \_\_\_\_\_

Location: \_\_\_\_\_

**Read only (for Snmp V3)**

User Name: \_\_\_\_\_

Authentication Password: \_\_\_\_\_

Authentication protocol: DISABLE

Privacy Password: \_\_\_\_\_

Privacy protocol: DISABLE

**Read/Write (for Snmp V3)**

User Name: \_\_\_\_\_

Authentication Password: \_\_\_\_\_

Authentication protocol: DISABLE

Privacy Password: \_\_\_\_\_

Privacy protocol: DISABLE

## Network Connection

On the Network Connection page, you may view the TCP connections from other hosts. This may assist you in the management of your devices.

**Network Connection**

Total TCP/IP Connection(s)

1

Source Host Address	Connection Type
192.168.19.217	Web/HTTP

Destination Host Address

Connection Type

## Firmware Update

On the Firmware Update page, you may load new or updated firmware onto the ioPAC 8020.

**Firmware Update**

Choose a new firmware file path :

\_\_\_\_\_

[Warning:]

1. The firmware update process may take about few minute.
2. Attention! Once you press the "Update" button, this progress cannot be reversed.
3. Disconnecting power or network cable would lead to firmware corruption during the time.

## Import System Config

On the Import System Config page, you may import a configuration onto the ioPAC 8020 system. The configuration file can be generated by ioAdmin or through the web console. This function can be used to duplicate settings between ioPAC 8020 systems. You will be prompted for the location of the configuration file (i.e., "ik8020.txt").

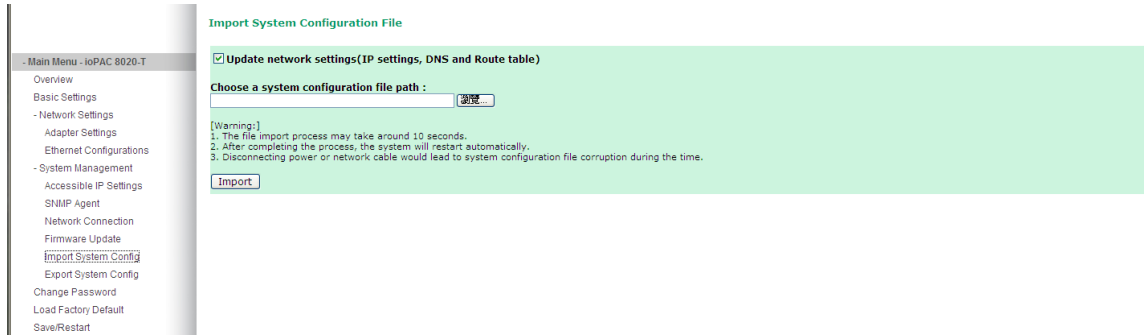

## Export System Config

On the Export System Config page, you may click the file name "ik8020.txt" to save the ioPAC's configuration into a file for backup or import into another ioPAC system. Please be noticed that the system will specify the file name with "ik8020.txt"

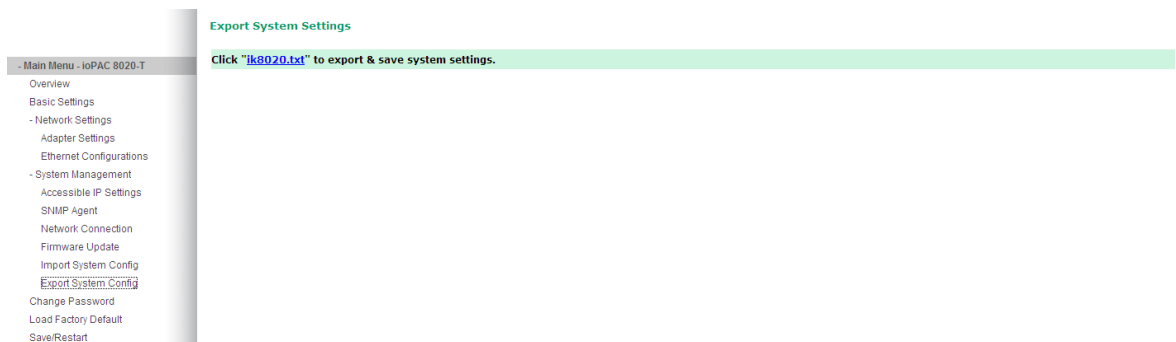

## Change password

For all changes to the ioPAC 8020's password protection settings, you will first need to enter the old password. Leave this blank if you are setting up password protection for the first time. To set up a new password or change the existing password, enter your desired password under both New password and Confirm password. To remove password protection, leave the New password and Confirm password fields blank.

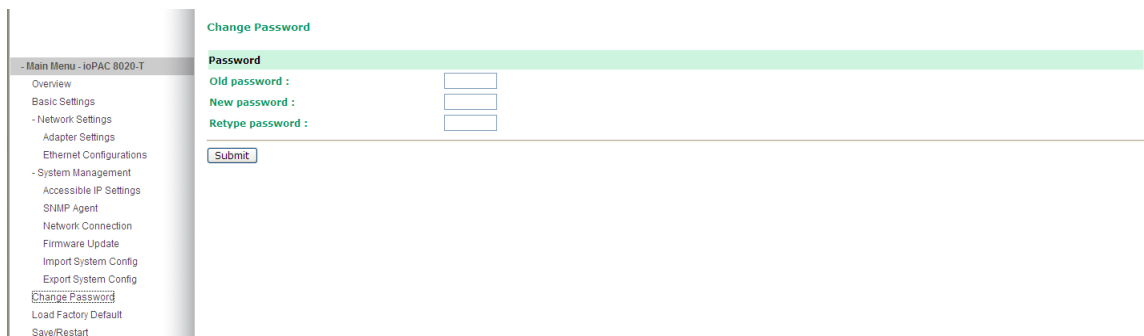

**ATTENTION**

If you forget the password, the ONLY way to configure the ioPAC 8020 is by using the reset button to load the factory defaults.

Before you set a password for the first time, it is a good idea to export the configuration to a file when you have finished setting up your ioPAC 8020. Your configuration can then be easily imported back into the ioPAC 8020 if you need to reset the ioPAC 8020 due to a forgotten password or for other reasons.

**Load Factory Default**

This function will reset all of the ioPAC 8020's settings to the factory default values. All previous settings including the console password will be lost.

**Save/Restart**

If you change the configuration, do not forget to reboot the system.

## Click&Go Introduction

---

Click&Go Logic was developed by Moxa to provide an easy way to program your ioPAC 8020 for active I/O messaging. In the chapter, we will show you how Click&Go Logic works and how to use it to develop your active I/O messaging program.

The following topics are covered in this chapter:

- ❑ **Overview**
- ❑ **Features**
- ❑ **Click&Go Logic Basics**
- ❑ **Working with Rules**
- ❑ **Developing Your Logic Rules**
- ❑ **Define Global Variables**
  - Internal Register Settings
  - Timer Settings
  - SNMP Trap Server
  - E-Mail Server
  - Active Message Server
- ❑ **IF/THEN/ELSE Statement**
  - IF Conditions
  - THEN/ELSE Actions
- ❑ **Working with Click&Go Rulesets**
  - Activating the Ruleset



## Overview

Anyone can be a programmer! Moxa's Click&Go local control logic for the ioPAC 8020 eliminates the cumbersome programming generally required for data acquisition, alarm messaging, and local control tasks. No knowledge of the C programming language or PLC ladders is required for field applications. Instead, users familiar with IF-THEN-ELSE statements will have no problem understanding the Click&Go interface and will be able to control I/O channels and alarm messaging after a few simple steps. The configuration utility also makes the control process easy to define and configure. Simply download the control logic to the ioPAC 8020 and Click&Go will be ready-to-go in no time.



Click&Go performs various functions including local I/O control, remote output control, alarm generation and messaging, and event-driven or time-based I/O status reporting. Click&Go eliminates the need for host computers to continually poll I/O devices for status. Instead, the server itself is able to monitor the status of each I/O device and take the appropriate action when the I/O status satisfies a user-defined condition. For example, users may need to configure the Moxa ioPAC 8020 s to send a TCP/UDP message only when the switch attached to DI-0 is turned on. This event-based structure results in a much improved response time and a much reduced load on the host computer's CPU and on network bandwidth. Simple IF-THEN-ELSE statements are used to specify conditions that are required for certain actions to take place. Up to three conditions, three actions, and three opposite actions (ELSE) can be combined in a rule, and you can define up to 24 rules. Supported actions include sending SNMP traps or TCP/UDP messages to up to 10 hosts at a time. Click&Go can also be used to map an input channel on one Moxa ioPAC 8020 to an output channel on another ioPAC 8020 for peer-to-peer I/O communication. Up to five different IP addresses can be entered as the output destination. Peer-to-peer I/O provides a very flexible and easy way to extend I/O signals or connect remote on/off switches. It can be used, for example, to replace or extend the wiring of PLC or DCS systems over Ethernet.

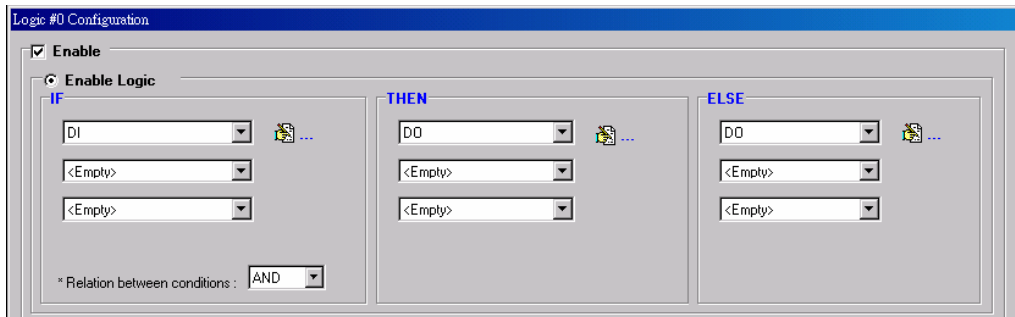

Click&Go Logic was developed to provide an easy and intuitive way to configure when and how I/O information is transmitted over the network. Using simple IF-Then-Else statements, you set the conditions that need to be satisfied and the resulting actions. Up to three conditions and three actions can be combined in any one rule, and up to 80 rules can be defined in a ruleset. Each SNMP trap, TCP/UDP message can be transmitted to up to 10 hosts simultaneously.

# Features

Click&Go Logic's key features are as follows:

## 80 Rules for Intuitive IF-THEN-ELSE Style Programming

Users do not need any programming experience to use Click&Go. The easy and straightforward IF-THEN-ELSE programming style greatly simplifies the development and installation of I/O applications. With 80 IF-THEN-ELSE rules pre-installed and up to 3 IF conditions and 3 THEN/ELSE outputs or network actions per rule, Click&Go is suitable for most remote monitoring and alarm applications.

## Local Monitoring and Local Control

Click&Go can continually monitor the local I/O status for each input channel, trigger the status, or direct it to local output channels.

## Remote Control and Control by Remote

Click&Go is capable of accepting control commands from a remote host or an ioPAC 8020. In addition, it can send out commands to remotely control another ioPAC 8020.

## Time-stamped Active Messaging

All alarms, messages, e-mail notices, and TCP, UDP, and SNMP traps are time-stamped with the exact time of the events.

## Unicode Active Messaging

All alarms, messages, e-mail notices, and TCP, UDP, SNMP traps, and SMS can be defined with multiple language of the events' context.

# Click&Go Logic Basics

To use Click&Go Logic, open Modular ioAdmin and log on as an administrator on the Device Settings tab. Once you are logged on, go to the Click&Go Logic tab. It should appear as follows:

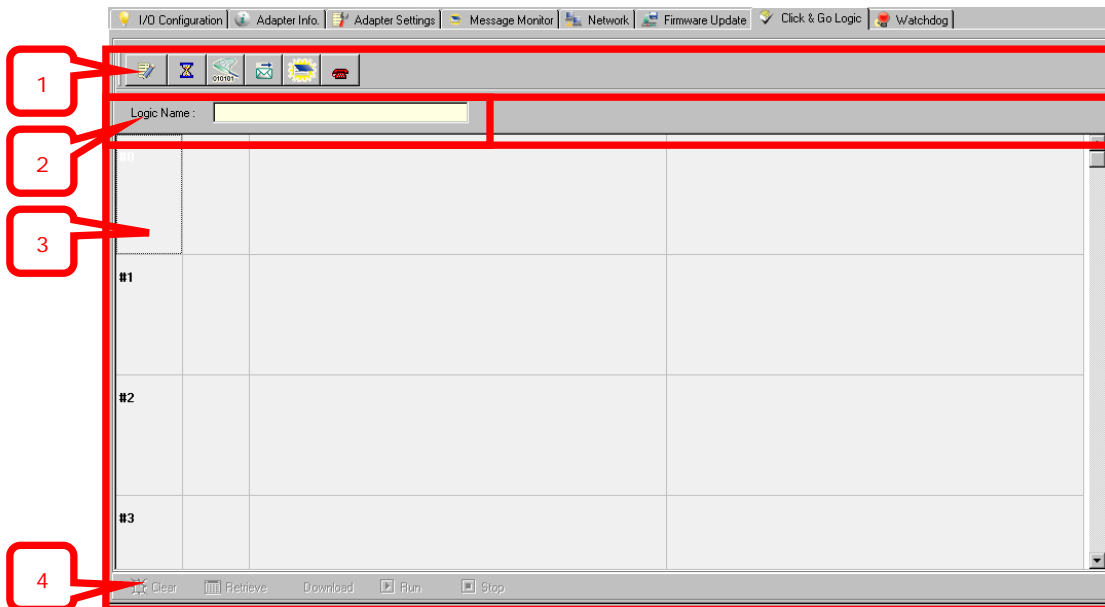

1. **Global Variables:** In this field, you can assign variables for all rules used.
2. **Logic Name:** In this field, you can assign a name for the set of rules.
3. **Rules List:** In this area, each rule's conditions, actions, and status are displayed.
4. **Ruleset Management Bar:** In this area, you manage the ruleset

## Working with Rules

Rules are the building blocks of your ioPAC 8020 system. With rules, you define the exact trigger conditions for transmission of I/O information as well as the content and destination of that information. Output channel operation can also be automated based on input channel trigger conditions.

In the main screen, you will see the list of rules in the current ruleset. Double click on a rule to open that rule's configuration window, or double click on an empty rule to start a new rule.

Under Relation between conditions, select AND to specify that all conditions must be satisfied for the actions to take place; select OR to specify that any one of the conditions can be satisfied for the actions to take place.

The configuration window is where the rule is defined. Basic If-Then-Else logic is used to set up event-based triggers.

The Equivalent Logic Statement at the bottom shows a real-time text-based summary of the rule that you are defining. It can be a useful way to make sure that the rule is designed as you intended.



### ATTENTION

The **Alias name** of I/O channel is defined on the I/O configuration tab. When an I/O channel is being used in a Click&Go Logic rule, the channel's range, units, and alias name can not be modified.

It is strongly recommended to configure these parameters for the used I/O channel before performing any further configuration or programming.

# Developing Your Logic Rules

Each rule consists of three columns. The "IF" column defines I/O conditions, the "THEN" and "Else" column defines actions. When the ioPAC 8020 detects that the IF conditions have been satisfied, the THEN or Else actions will be performed.

After searching and setting up the IP address of an ioPAC 8020, Click&Go logic can be developed by following the procedures below:

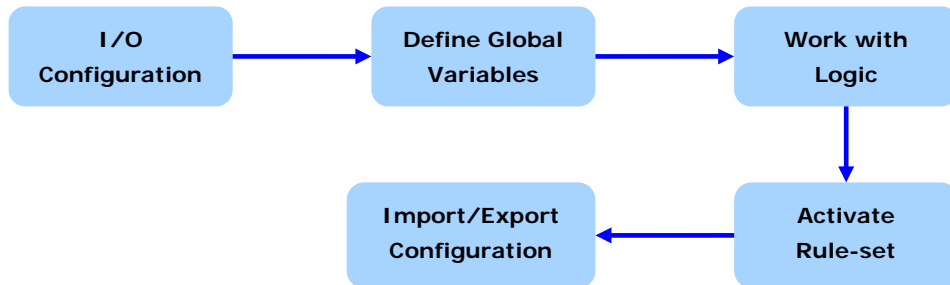

## Define Global Variables

Global Variables include the settings of **Internal Register Settings**, **Timer Settings**, **SNMP Trap Server**, **E-Mail Server**, and **Active Message Server**. If these functions are going to be used in the Click&Go rule-set, default configuration must first be set in the Global Variable Menu Bar.

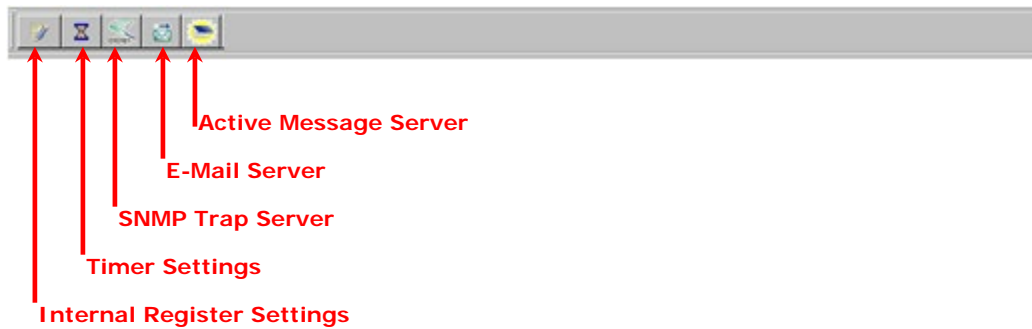

## Internal Register Settings

**Internal Register** is a flag that can be used with the Click&Go logic internally or externally. It allows you to control output channel which used in Click&Go rule from remotely site. It is useful for database control system, such as door access system. The 80 sets of the internal registers can be polled and controlled by a SCADA software using standard Modbus/TCP format, or be implemented to redirect the result of one Click&Go logic to another.

Default value of an internal register is "0".

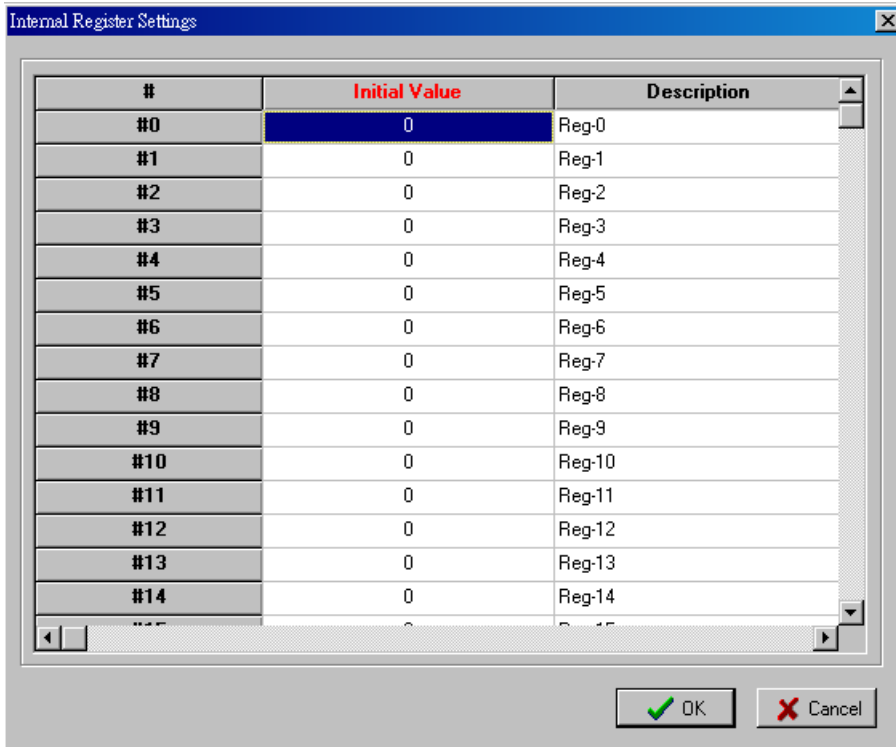

## Timer Settings

The **Timer** function allows users to delay an action, to trigger an action to run, or repeat an action. A timer is activated by a change of the logic event. After the timed interval has expired, the output will be performed. There are 80 timers that can be implemented in the Click&Go logic, and the default value of their interval is set to "5 seconds" at the "STOP" state. Configure the interval before using them. If default state is set to "START", the timer will start when the Click&Go logic is activated.

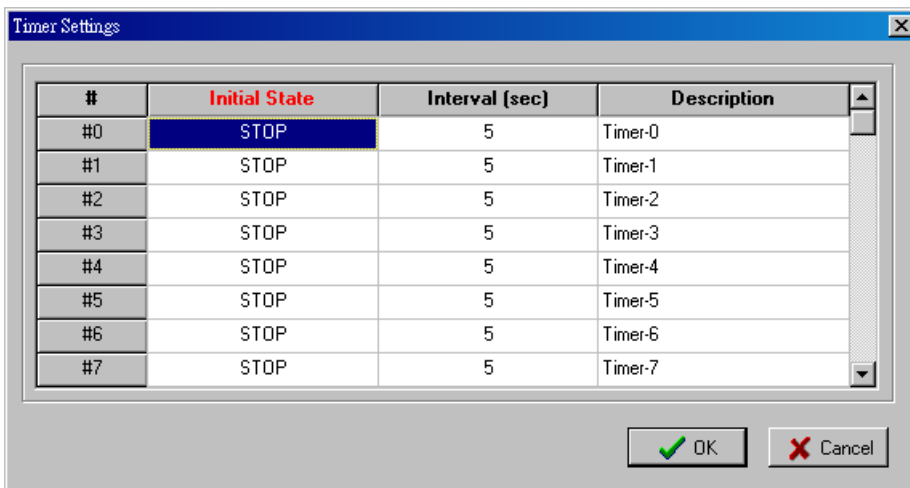

## SNMP Trap Server

The ioPAC modular RTU controller provides SNMP v2 (Simple Network Management Protocol) to allow monitoring of the network and I/O devices with SNMP Network Management software. It is useful for building automation and telecom applications. When the system information of an ioPAC 8020 needs to be monitored, or a Click&Go logic is defined to update the I/O status via SNMP traps, one or up to 10 SNMP trap servers must be defined here.

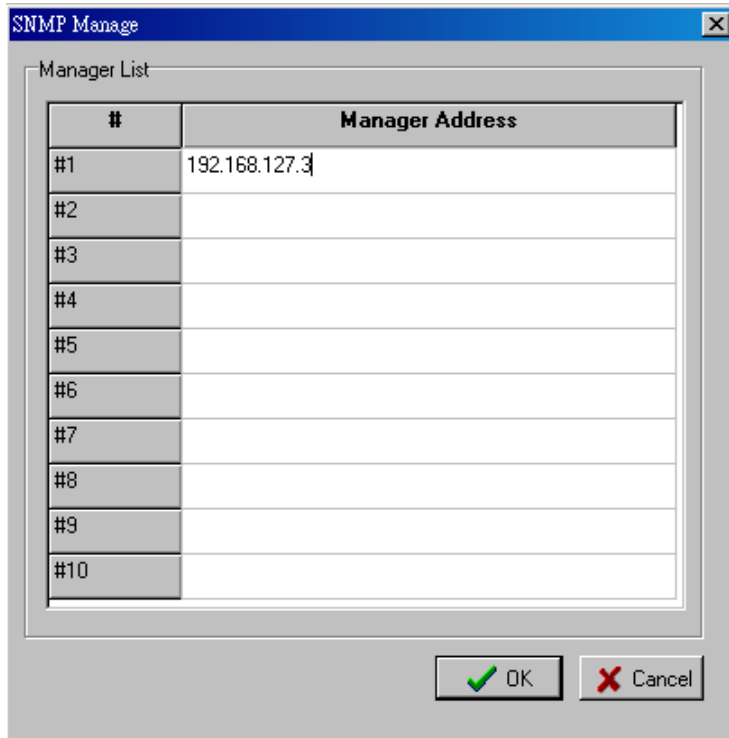

## E-Mail Server

The **E-mail Server** configures the parameters of the target e-mail servers and the recipient e-mail addresses. The **Recipient Database** should contain a list of available e-mail addresses for your network environment. The e-mail message defined in the Click&Go logic will be sent to all addresses listed in the **Receiver(s) list**. To add e-mail addresses to the **Available receiver(s) list**, enter the **Name** and **Mail Address** and click **Add** finger icons to move addresses to the **Recipient Database**; use the **Remove** finger icon to remove it. Under Mail Server Settings, you must configure the address of the SMTP server with your username and password.

**E-Mail Server**

**Mail Address Settings**

Name :  Mail Address :

**Recipient Database**

Name	e-Mail Address

**Mail Server Settings**

SMTP Server Address (IP) :  Login Name :

Login Password :

Retry  Interval  sec.

**NOTE** When using an FQDN (Fully Qualified Domain Name) address, such as ms.moxa.com, users must specify the DNS settings in the ioPAC 8020.

I/O Configuration Adapter Info Adapter Settings Message Monitor Network Firmware Update Click & Go Logic Watchdog

Number of Modbus/TCP connection(s): 2

**IP Settings**

LAN0

IP Configuration : Static

IP Address : 192.168.127.254

Subnet Mask : 255.255.255.0

Gateway : 0.0.0.0

MAC : 00-90-E8-00-42-10

LAN1

IP Configuration : Static

IP Address : 192.168.126.254

Subnet Mask : 255.255.255.0

Gateway : 0.0.0.0

MAC : 00-90-E8-00-42-11

**Modbus/TCP Alive Check Timeout**

Enable Modbus/TCP idle connection

timeout interval :  sec

**DNS Settings**

DNS #1 :

DNS #2 :

**SNMP Settings**

Enable SNMP

Read Community :

Write Community :

Contact :

Location :

**Web Access Settings**

Enable

## Active Message Server

The Active Message Server configures one or more destination IP addresses of the Message Servers that receive the event messages generated by the Click&Go logic. Message protocol (TCP or UDP) and the message socket port is also required to be configured here. The active message defined in the Click&Go logic will be sent to all addresses listed in the **Message Recipient List**.

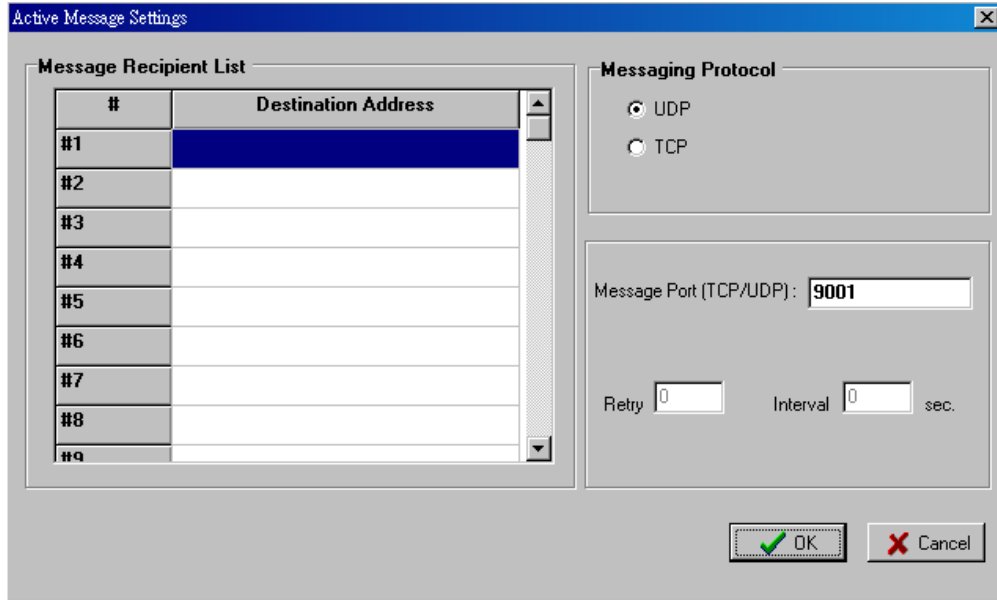

## IF/THEN/ELSE Statement

Rules are the building blocks of your ioPAC 8020 system. With rules, you define the exact trigger conditions for transmission of I/O information as well as the content and destination of that information.

Click&Go Logic can be defined with the following manner:

**IF "A" THEN "B", ELSE "C"**

For one control logic rule, there are three "A's" that can be configured. "A" refers to the IF conditions that trigger an action. These three conditions can operate by "AND" or "OR" logic. Under "AND" logic, all three conditions must be true to trigger the rule. Under "OR" logics, one or more true conditions will trigger the action.

A1	A2	A3	Result of AND Logic	A1	A2	A3	Result of OR Logic
0	0	0	0	0	0	0	0
0	0	1	0	0	0	1	1
0	1	0	0	0	1	0	1
0	1	1	0	0	1	1	1
1	0	0	1	1	0	0	1
1	0	1	1	1	0	1	1
1	1	0	1	0	0	0	1
1	1	1	1	1	1	1	1

All 80 rules are defined individually and executed one by one in a loop. The 2nd rule can only be processed after running the 1st rule and the entire rule-set will start running over again from the beginning after the last rule is processed.

Refer to Click&Go V2 Users Manual for more details.



## IF Conditions

**IF conditions** are events that trigger the **THEN/ELSE actions**. Under the **IF** column, you can set up to 3 conditions that must be satisfied for the actions under the **THEN/ELSE** column to take place. As soon as the IF conditions are satisfied, the specified THEN/ELSE action is performed. For example, an alarm can be activated when a door is opened. Use the pull downs to specify the conditions and units of measurement (e.g. DI-0=OFF).

IF conditions can be specified as follows:

### DI

DI refers to the status of a digital input channel. Edge detection can be used to refine the conditions. For example, the condition DI-0=OFF is satisfied for as long as DI-0 remains off. The condition DI-0=ON to OFF, however, is only satisfied the instant the DI-0 turns off. The transition of the status change can also be operated using the "Change" operator so it will trigger the related action whether it is ON-to-OFF or OFF-to-ON. Select the IF condition to DI and click on the property button to enter the DI Settings window.

### AI

AI refers to the readings of an analog input channel. Analog input value is specified to trigger an action. Units of the value are defined by the selected analog modes (voltage or current), or the scaling results. For example, AI-0 > 15mA represents the high level of a water tank.

### Internal Register

Internal Register represents a status flag to link the status of the first logic to the second one. Mostly it will be used with the Timer function or to combine other input statuses together. The Internal Register function also allows a PC to control the ioPAC's local output when the remote output is controlled by Click&Go log (e.g., digital output, active message, e-mail and SNMP Trap). Select the IF condition for the Internal Register and click on the property button to enter the Set Internal Register window.

**NOTE** Internal Registers can be controlled by Modbus/TCP protocol. Refer to the appendix for the address list for all the Internal Registers.

### Timer

The Timer function can be used to control the timing of a logic rule in the IF conditions. "TIMEOUT" is the only operator here. For example, users can delay the triggering of an action or to repeat an action periodically. Select the IF condition for Timer and click on the property button to enter the Internal Register Settings window.

In the above figure, the "Used in:" column indicates this Timer is also used in the Rule-0, which helps the user to identify the relationship between rules. Also the Set Timer button will help to define the default value for the Timer.

### Schedule

The Schedule function allows users to set a starting point or time period for a task. For example, a pump needs to start at 9:00 PM and stop at 11:00 PM every Monday, Wednesday, and Friday. Select the IF condition to Schedule and click on the property button to enter the setting window. For recurrent actions, select the Recurrence checkbox and select the week days. If there a time period needs to be defined, specify the stop date in the range column.

## Host Connection Fail

The Host Connection Fail function refers to when an ioPAC 8020 detects the timeout from a remote Modbus/TCP host and directs it to one of the IF condition of the Click&Go logic. Timeout can be used to trigger an action such as resetting the attached power line on a DO or relay channel to reboot the device. Select the IF condition to Host Connection Fail and click on the property button to enter the setting window.

## THEN/ELSE Actions

Under the **THEN** column, you can specify up to 3 actions that will be performed when the IF conditions are satisfied. 3 actions under the **ELSE** column will also be performed when the **IF** condition is **NOT** satisfied. Possible actions include changing the status of a DO channel, or sending a message by SNMP trap, TCP, UDP, or e-mail.

The screenshot shows a configuration window with three columns: IF, THEN, and ELSE. The IF column has three dropdown menus, the first containing 'DI'. The THEN column has a dropdown menu with 'DO' selected, and a list of actions: '<Empty>', 'DO', 'Internal Register', 'Timer', 'SNMP Trap', 'Active Message', and 'e-Mail'. The ELSE column has three empty dropdown menus. At the bottom, there is a label '\* Relation between conditions : AND' with a dropdown menu set to 'AND'.

## DO

**DO** refers to the action of controlling the local digital output channels that react to the IF conditions. Select the THEN/ELSE action to DO and click on the property button to enter the DO Settings window.

**NOTE** A Relay output channel is also referred to as a DO channel in the THEN/ELSE action fields.

## Internal Register

The **Internal Register** represents a status flag to link the status of the first logic to the second one by specifying other actions in the THEN/ELSE fields. Value from 0 to 255 can be configured here. Select the THEN/ELSE action to Timer and click on the property button to enter the Internal Register Settings window. In the above figure, the "Used in:" column indicates that this Internal Register is also used in the Rule-0, which helps the user to identify the relationship between the rules. Also the Set Internal Register button will help to define the default value of the all the registers.

**NOTE** Inter Register can be controlled by Modbus/TCP protocol; refer to the appendix for the address list for all the Internal Registers.

## Timer

The **Timer** function can be used to control the time settings of a logic rule. Actions such as "START", STOP, and "RESTART" can be configured here. Select the IF condition to Timer and click on the property button to enter the Internal Register Settings window. In the above figure, the "Used in:" column indicates this Timer is also used in the Rule-0, which helps the user to identify the relationship between the rules. Also, the Set Timer button will help to define the default value for the Timer.

**NOTE** While the "STOP" operator stops the timer and returns to "0", the "RESTART" operator clears and restarts the timer. The STOP or RESTART operator should always be used to reset or to restart the timer. Without using these operators, the Timer function can only be triggered once.

## SNMP Trap

SNMP Trap function sends an SNMP trap to one or more IP destinations. You can select a trap number between 1 and 20. (You may need to consult with your network administrator to determine how trap numbers will be used and defined in your network.) Select the THEN/ELSE action to SNMP Trap and click on the property button to enter the SNMP Settings window. You can also bind the status of up to three I/O channels within each trap. Click the Set SNMP button to specify up to 10 recipients for the SNMP trap.

## Active Message

In response to a proper IF condition, the **Active Message** function sends a customized message to one or more IP destinations by TCP or UDP packets. Select the THEN/ELSE action to Active Message and click on the property button to enter the Message Content Settings window.

Enter your desired message in the **Message Content** column. Dynamic fields such as time, date, IP address, and I/O status can be inserted in your message by clicking **Keyword Lookup**. Messages are sent in ASCII by default, but can be sent in HEX by selecting "Message Format" as "**HEX (separated by ',')**" checkbox or sent in Unicode by selecting "Message Format" as "**UNICODE (UCS-2)**" checkbox. Click the Set Active Message button to configure the default parameters such as the messaging protocol (TCP or UDP), socket port (9001 by default), and the up to 10 target message servers.

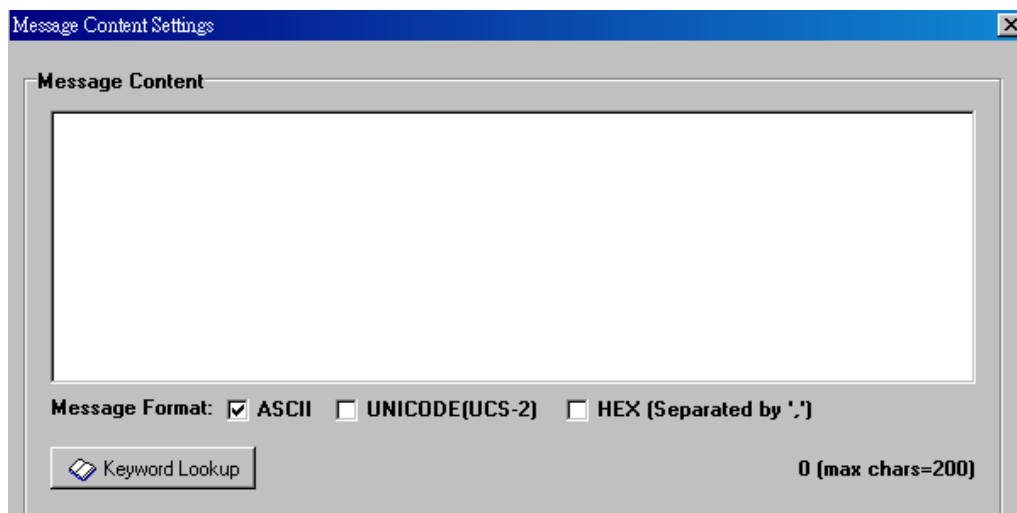

Active Messages can be received by a program using standard sockets, Moxa MXIO library, or Module\_ioAdmin's Message Monitor as in the following example:

When sending a message in HEX, each HEX value must be delimited by commas. View the incoming message in the Message Monitor tab, select **Toggle HEX** checkbox. Note that certain numbers are control characters that will not show up in the Message Monitor, as shown in the following example:

## E-mail

The E-mail function sends a customizable e-mail to one or more mail boxes or Blackberrys. Select the THEN/ELSE action to e-mail and click on the property button to enter the Mail Settings window. After entering the subject of an e-mail, enter the message in the Mail Content area. Dynamic fields such as time, date, IP address, and I/O status can be inserted in your message by clicking Keyword Lookup.

**NOTE** Content in the same logic entry can be sent by either Active Message or e-mail, in which case the content of the messages will be the same. If you would like to send an Active Message and e-mail based on the same event but with different content, you will need to use two separate logic entries, one for the Active Message and one for the e-mail.

SMTP server information including username/password, and the recipient database can be configured or by clicking the Set Mail Address button. Clicking the finger icon can move the selected address from the Recipient Database to the Recipient List. To manually add e-mail addresses to the Recipient Database, enter the Name and Mail Address and click **Add**. Once the address has been added to the **Recipient Database**, use the finger icons to move it to or from the **Recipient List**.

# Working with Click&Go Rulesets

## Activating the Ruleset

### Upload, Restart and Run

In the Click&Go tab, the rules that are displayed in the Click&Go Logic tab comprise the current rule-set, which acts as the brain of your ioPAC 8020 system. The rule-set must be activated for the ioPAC 8020 to commence local control operation as follows:

1. The rule-set must first be downloaded from Modular ioAdmin to the ioPAC. To download the rule-set, click **Upload to ioLogik** from the Rule-set Management bar.
2. After the rule-set has been downloaded, Modular ioAdmin will prompt to restart the ioPAC 8020 automatically after clicking "yes" to confirm. Do not use the reset button, as that will load all factory defaults and erase your rule-set from memory.

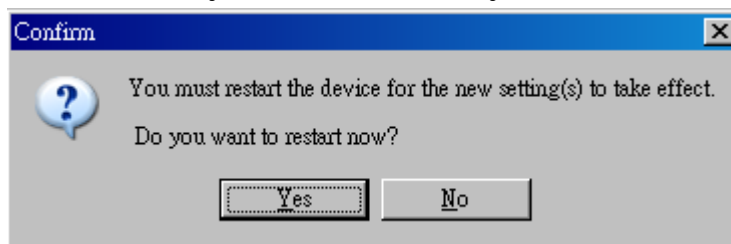

3. After the ioPAC 8020 has been restarted, the rule-set must be activated. After logging into Modular ioAdmin as an administrator, go to the Click&Go Logic tab and click Run in the Rule-set Management bar. The rules in the rule-set will now be active.

When the rule-set has been activated, it will remain active even when the ioPAC 8020 is disconnected from the host computer or from the network. If the ioPAC 8020 is turned off, ioPAC 8020 operation will resume when it is turned back on. This allows you to use the ioPAC 8020 for PC-independent automation.

### Rule-set Management Bar

In the Click&Go tab, when the rule-set has been activated, it will remain active even when the ioPAC 8020 is disconnected from the host computer or from the network. If the ioPAC 8020 is turned off, ioPAC 8020 operation will resume when it is turned back on. This allows you to use the ioPAC 8020 for PC-independent automation.



- **Clear:** This erases the rule-set in both Modular ioAdmin and the ioPAC 8020 series.
- **Retrieve:** This copies the rule-set from the ioPAC 8020 series into Modular ioAdmin.
- **Upload to ioLogik:** This copies the rule-set from Modular ioAdmin onto the ioPAC 8020 series.
- **Run:** This activates the rule-set that the ioPAC 8020 booted up with.
- **Stop:** This de-activates the Click&Go rule-set and returns the ioPAC 8020 to normal, passive operation.

### Ruleset Import/Export

Although rulesets alone cannot be imported and exported, the entire system configuration including the current ruleset can be imported and exported. As you make changes to a ruleset, you can export the system configuration in order to save that ruleset.

# Hot-swappable I/O Function

---

The ioPAC 8020 supports hot-swappable I/O. This chapter describes how it works.

The following topics are covered in this chapter:

- ❑ **Hot-swappable I/O Function**
- ❑ **Handling Unmatched Module Combination Events**
- ❑ **Disable/Enable “Unmatched I/O Modules” Watchdog**

# Hot-swappable I/O Function

The ioPAC system supports Hot Swappable I/O modules, which means the ioPAC can auto-detect and update I/O module combinations in real-time. You can check the current I/O module combination in Modular ioAdmin or with the Web console.

This function is activated by selecting the “Unmatched I/O Modules” option on the Watchdog tab. The responses triggered by selecting or not selection this option are described below.

## “Unmatched I/O Modules” is enabled.

1. Module\_ioAdmin will be offline if Modular ioAdmin is connected.
2. The I/O LED indicator on the CPU Module will flash red and green to indicate that the ioPAC is in Safe Mode.
3. If you plug in one new I/O module, the Status LED indicator on this module will be a steady red.
4. The I/O channel used by the Click&Go logic will be replaced by “Unknown.”
5. Click&Go will stop and each output channel will remain in its predefined state.
6. If you want to return to normal status, manually reset the Safe Mode Alarm.

## “Unmatched I/O Modules” is disabled.

1. Module\_ioAdmin will be offline if Modular ioAdmin is connected.
2. The I/O LED indicator on the CPU Module will be a steady red to show that the I/O module combination change was detected.
3. If you plug in one new I/O module, the Status LED indicator on this module will be a steady red.
4. An I/O channel using Click&Go logic that is removed and will be replaced by “Unknown.”
5. Click&Go will remain active, and each I/O channel will remain active.
6. After the combination returns to the original status, the I/O LED indicator will return to green.

**NOTE** It is risky to run Click&Go without the correct I/O module. It is possible to cause some damage if the “Unmatched I/O modules” option is disabled.

# Handling Unmatched Module Combination Events

Once the system starts successfully, ioPAC 8020 memorizes the current module combination and all their settings. If you change the module combination, at the next start-up, the ioPAC 8020 will detect an unmatched module combination event and display a warning window. There are two options you can choose to handle the unmatched module combination event:

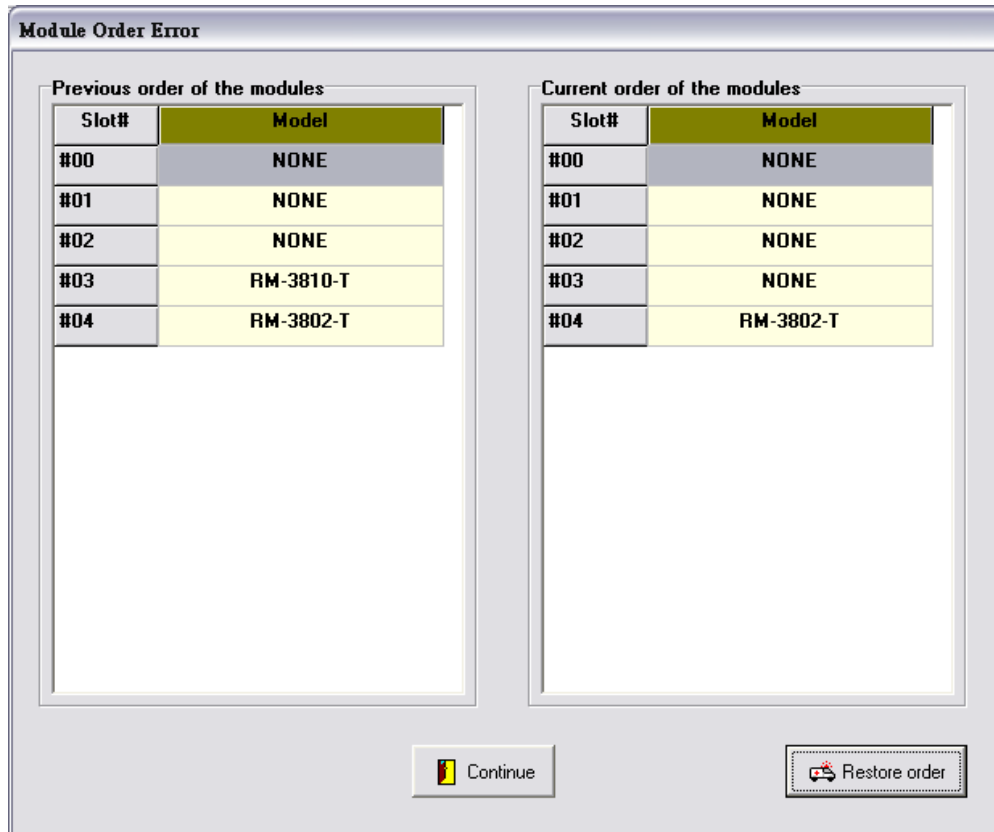

## 1. Continue and apply all new modules

This action does not clear Click&Go settings. Click&Go will continue or stop operating based on whether or not the "Unmatched I/O Modules" option on the Watchdog tab is checked. You should understand that there is some risk to running Click&Go with the watchdog disabled. Selecting this option will clear the watchdog alarm automatically if the watchdog is enabled. All configurations of the old module will be preserved, and new added modules will be applied with default settings.

## 2. Restore order (recover the original module combination)

You will need to shut down the system power and recover the original module combination yourself. After solving the issue, you must manually clear the Watchdog Alarm.

# Disable/Enable “Unmatched I/O Modules” Watchdog

If you do not want to stop Click&Go when the I/O module combination changes, uncheck the “Unmatched I/O Modules” option on the “Watchdog” tab.

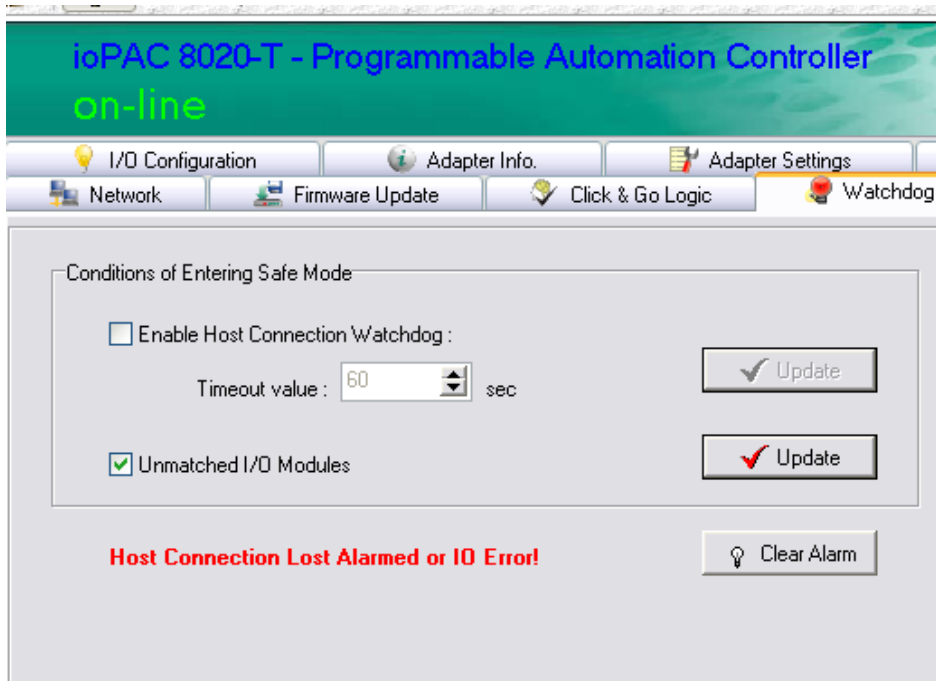



## Module Specifications and Wiring

### 16-channel 24 VDC Digital Input Module

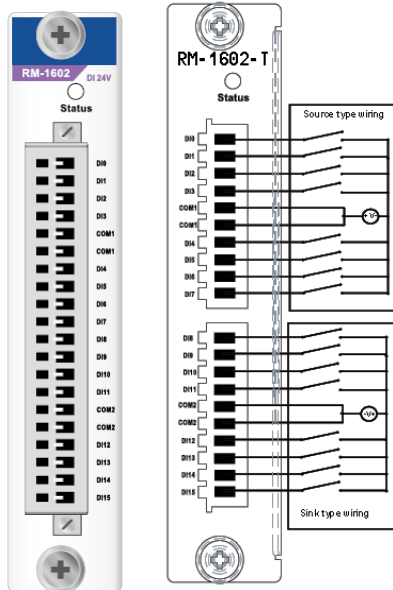

**RM-1602-T: 16 digital inputs, 24 VDC, sink/source type**

**Inputs per Module:** 16 channels, sink/source type

**On-state Voltage:** 24 VDC nominal, 10 VDC min.

**OFF-state Voltage:** 0 to 3 VDC, 3 VDC max.

**Input Impedance:** 3K ohms (typical)

**Common Type:** 16 channels / 2 DI\_COMs

**Response Time:** 100 ms

**Over Current Protection:** 200 mA per channel

**Isolation:** I/O to logic (photocoupler isolation)

**Operating Temperature:** -40 to 75°C

**Power Consumption:** 20 mA @ 24 VDC (typical)

**I/O Cable Wire:** AWG 14 (2.0 mm x mm) max.

### 10-channel 110 VDC Digital Input Module

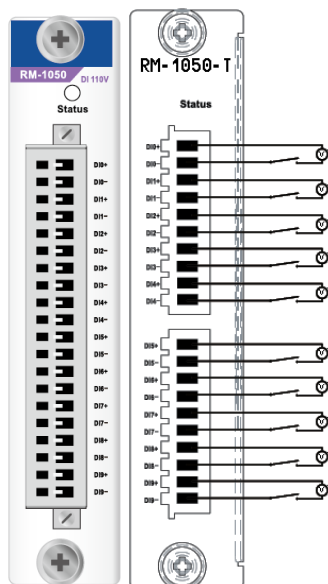

**RM-1050-T: 10 digital inputs, 110 VDC, isolated**

**Inputs per Module:** 10 channels, 110 VDC, channel-to-channel isolated

**On-state Voltage:** 72 VDC nominal, 50 VDC (min.) to 175 VDC (max.)

**Off-state Voltage:** 0 to 15 VDC, 15 VDC max.

**Input Impedance:** 120K ohms (typical)

**Common Type:** None

**Response Time:** 100 ms

**Over Current Protection:** 200 mA per channel

**Isolation:** I/O to logic (photocoupler isolation)

**Channel-to-Channel Isolation:** 2.5K VDC

**Operating Temperature:** -40 to 75°C

**Power Consumption:** 24 mA @ 24 VDC (typical)

**I/O Cable Wire:** AWG 14 (2.0 mm x mm) max.

**16-channel Digital Output Module**

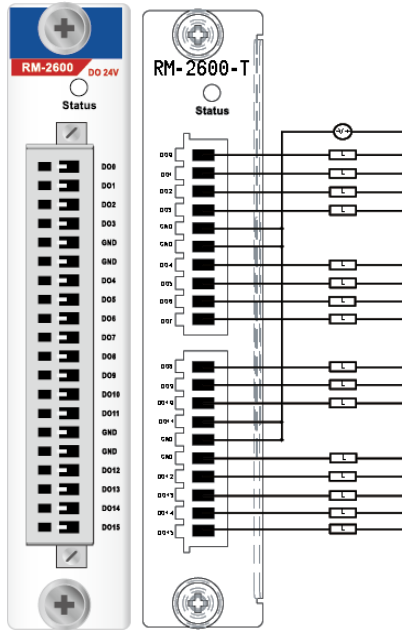

- RM-2600-T: 16 digital outputs, 24 VDC, sink type, 0.2 A**
- Outputs per Module:** 16 channels, 24 VDC, sink type
- Output Impedance:** 120m ohms (typical)
- Off-state Resistance:** 500K ohms (typical)
- Response Time:** 100 ms
- Over Current Protection:** 200 mA per channel
- Isolation:** I/O to logic (photocoupler isolation)
- Channel-to-Channel Isolation:** 2.5K VDC
- Operating Temperature:** -40 to 75°C
- Power Consumption:** 24 mA @ 24 VDC (typical)
- I/O Cable Wire:** AWG 14 (2.0 mm x mm) max.

**8-channel Analog Input Module, 16-bit Resolution (coming soon)**

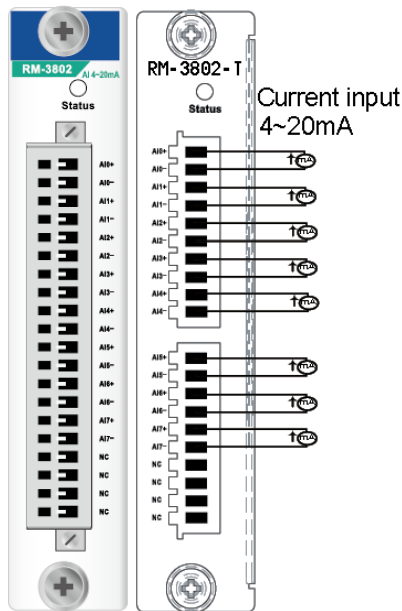

- M-3802-T: 8 analog inputs, 4 to 20 mA, 16 bits**
- Inputs per Module:** 8 channels, differential
- Input Current Range:** 4 to 20 mA
- Input Impedance:** 120 ohms
- Resolution Range:** 16 bits, 0.24  $\mu$ A/bit
- Accuracy:**
  - $\pm$ 0.1%, FSR @ 25°C
  - $\pm$ 0.3%, FSR @ -40°C, 75°C
- Response Time:** 100 ms for all channels
- Over Current Protection:** 200 mA per channel
- Isolation:** I/O to logic (photocoupler isolation)
- Channel-to-Channel Isolation:** 2.5K VDC
- Operating Temperature:** -40 to 75°C
- Power Consumption:** 30 mA @ 24 VDC (typical)
- I/O Cable Wire:** AWG 14 (2.0 mm x mm) max.

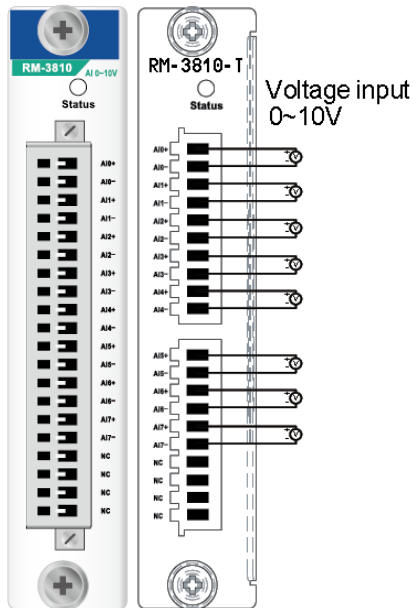
**8-channel Analog Input Module, 16-bit Resolution (coming soon)**

**M-3810-T: 8 analog inputs, 0 to 10 V, 16 bits**

**Inputs per Module:** 8 channels, differential

**Input Current Range:** 0 to 10 VDC

**Input Impedance:** > 10M ohms

**Resolution Range:** 16 bits, 0.15  $\mu$ A/bit

**Data Format:** 16-bit integer (2's complement)

**Accuracy:**

$\pm 0.1\%$ , FSR @ 25°C

$\pm 0.3\%$ , FSR @ -40°C, 75°C

**Response Time:** 100 ms for all channels

**Over Current Protection:** 200 mA per channel

**Isolation:** I/O to logic (photocoupler isolation)

**Channel-to-Channel Isolation:** 2.5K VDC

**Operating Temperature:** -40 to 75°C

**Power Consumption:** 30 mA @ 24 VDC (typical)

**I/O Cable Wire:** AWG 14 (2.0 mm x mm) max.

**NOTE** The 9th slot of the ioPAC 8020-9 series is reserved for future expansion. All I/O modules may only be installed in slot 1 through slot 8.

## Using Modbus/TCP

**Modbus Packets** consist of a Modbus Header and a Modbus Command. Each packet type is described below.

### Modbus Header

Description	Size (byte)	Example
Transaction Identifier Hi	1	0x08
Transaction Identifier Lo	1	0x01
Protocol Identifier Hi	1	0x00
Protocol Identifier Lo	1	0x01
Length	2	0x0006
Unit Identifier	1	0xFF

### Modbus Command

Use this chart of standard function codes as a programming reference....

Code (Hex)	Name	Usage
01	Read Coil Status	Read Discrete Output Bit
02	Read Input Status	Read Discrete Input Bit
03	Read Holding Registers	Read 16-bit register. Used to read integer or floating point process data
04	Read Input Registers	
05	Force Single Coil	Write data to force coil ON/OFF
06	Preset Single Register	Write data in 16-bit integer format
08	Loop-back Diagnosis	Diagnostic testing of the communication port
15	Force Multiple Coils	Write multiple data to force coil ON/OFF
16	Preset Multiple Registers	Write multiple data in 16-bit integer format

Table 5-1 Modbus Function Code

### Modbus Function Code Introductions

#### Function Code 01

Function code 01 is used to read the discrete output's ON/OFF status of ioPAC 8020 modules in a binary data format.

**Request** message format for function code 01:

Command Body					
Station Address	Function Code	Start Address High Byte	Start Address Low Byte	Requested Number of Coil High Byte	Requested Number of Coil Low Byte

Example: Read coil number 1 to 8 (address number 00017 to 00024) from ioPAC 8020 Modules

01 01 00 17 00 08

**Response** message format for function code 01:

Command Body					
Station Address	Function Code	Byte Count	Data	Data	---

Example: Coils number 2 and 7 are on, all others are off.

01 01 01 42

In the response the status of coils 1 to 8 is shown as the byte value 42 hex, equal to 0100 0010 binary.

**Function Code 02**

Function code 02 is used to read the discrete ioPAC 8020 input's ON/OFF status in a binary data format.

**Request** message format for function code 02:

Command Body					
Station Address	Function Code	Start Address High Byte	Start Address Low Byte	Requested Number of Input High Byte	Requested Number of Input High Byte

Example: Read coil number 1 to 8 (address number 00001 to 00008) from ioPAC 8020 modules

01 01 00 01 00 08

**Response** message format for function code 02:

Command Body					
Station Address	Function Code	Byte Count	Data	Data	...

Example: input number 2 and 3 are on, all others are off.

01 01 01 60

In the response the status of input 1 to 8 is shown as the byte value 60 hex, equal to 0110 0000 binary.

**Function Code 03/04**

Function code 03 or 04 is used to read the binary contents of input registers

**Request** message format for function code 03 or 04:

Command Body					
Station Address	Function Code	Start Address High Byte	Start Address Low Byte	Requested Number of Register High Byte	Requested Number of Register High Byte

Example: Read Analog inputs #1 and #2 in addresses 40001 to 40002 as floating point values from ioPAC 8020 module

01 04 00 01 00 02

**Response** message format for function code 03 or 04:

Command Body					
Station Address	Function Code	Byte Count	Data	Data	...

Example: Analog input #1 and #2 as floating point values where AI#1=100.0 and AI#2=55.32

01 04 08 42 C8 00 00 47 AE 42 5D

**Function Code 05**

Forces a single coil to either ON or OFF. The requested ON/OFF state is specified by a constant in the query data field. A value of FF 00 hex requests it to be ON. A value of 00 00 hex requests it to be OFF. A value of FF FF hex requests it to release the force.

Request message format for function code 05:

Command Body					
Station Address	Function Code	Coil Address High Byte	Coil Address Low Byte	Force Data High Byte	Force Data Low Byte

Example: Force coil 3 (address 00003) ON in IOPAC 8020 module

01 05 00 03 FF 00

**Response** message format for function code 05:

The normal response is an echo of the query, returned after the coil state has been forced.

Command Body					
Station Address	Function Code	Coil Address High Byte	Coil Address Low Byte	Force Data High Byte	Force Data Low Byte

**Function Code 06**

Presets integer value into a single register.

**Request** message format for function code 06:

Command Body					
Station Address	Function Code	Register Address High Byte	Register Address Low Byte	Preset Data High Byte	Preset Data Low Byte

Example: Preset register 40002 to 00 04 hex in IOPAC 8020 module

01 06 00 02 00 04

**Response** message format for function code 06:

The normal response is an echo of the query, returned after the coil state has been preset.

Command Body					
Station Address	Function Code	Register Address High Byte	Register Address Low Byte	Preset Data High Byte	Preset Data Low Byte

**Function Code 08**

The remote device can be initialized and restarted, and all of its communications event counters are cleared.

Most notably, data field 0x55AA makes the remote device restart with EEPROM factory default settings.

**Request** message format for function code 08:

Sub Function	Data Field (Request)	Data Field (Response)	Description
0x0001	0xff00	Echo Request Data	reset
0x0001	0x55AA	Echo Request Data	Reset with Factory defaults

**Function Code 15 (OF hex)**

Forces each coil in a sequence of coils to either ON or OFF.

**Request** message format for function code 15:

Command Body								
Station Address	Function Code	Start Address High Byte	Start Address Low Byte	Requested Number of Coil High Byte	Requested Number of Coil Low Byte	Byte Count	Force Data High Byte	Force Data Low Byte

Example: Request to force a series of 10 coils starting at address 00017 (11 hex) in ioPAC 8020 module.

01 0F 00 11 00 0A 02 CD 01

The query data contents are two bytes: CD 01 hex, equal to 1100 1101 0000 0001 binary. The binary bits are mapped to the addresses in the following way.

Bit: 1 1 0 0 1 1 0 1 0 0 0 0 0 0 0 1

Address (000XX): 24 23 22 21 20 19 18 17 - - - - - 26 25

**Response** message format for function code 08:

The normal responses return the station address, function code, start address, and requested number of coil forced.

Command Body					
Station Address	Function Code	Start Address High Byte	Start Address Low Byte	Requested Number of Coil High Byte	Requested Number of Coil Low Byte

Example: 01 0F 00 11 00 0A

**Function Code 16 (10 hex)**

Presets values into a sequence of holding registers.

**Request** message format for function code 16:

Command Body							
Station Address	Function Code	Start Address High Byte	Start Address Low Byte	Requested Number of Register High Byte	Requested Number of Register Low Byte	Byte Count	Data

Example: Preset constant #1 (address 40009) to 100.0 in ADAM-6000 module.

01 10 00 09 00 02 04 42 C8 00 00

**Response** message format for function code 08:

The normal responses return the station address, function code, start address, and requested number of registers preset.

Command Body					
Station Address	Function Code	Start Address High Byte	Start Address Low Byte	Requested Number of Coil High Byte	Requested Number of Coil Low Byte

Example: 01 10 00 09 00 02

- NOTE**
1. Command's station Address = 0x00, or =0x01, or =0xFF will direct to Ethernet I/O itself, and will not be routed to chained 485 device.
  2. For detailed Modbus register mapping, you can refer the export Modbus Map file from Modular ioAdmin.

## Modbus/TCP Address Mappings

The ioPAC 8020 Modbus Map has three categories:

1. IO image map
2. Module configuration map
3. System configuration map

The address arrangement is as below:

Map Categories	Slot-0	Slot-1	Slot-2	Slot-3	Slot-4
System Configuration Map Base Address: 0x6000					
Module configuration map Base Address: 0x3000					0x3800
				0x3600	
			0x3400		
		0x3200			
	0x3000				
I/O Image Map Base Address: 0x0000					0x0800
				0x0600	
			0x0400		
		0x0200			
	0x0000				

## I/O Image Map

Using I/O image map, users can read/write all the I/O modules' Input/Output values. You can get the Modbus Table in the Modular ioAdmin utility.

### I/O Image Map Addressing:

Module ID	Module Name	Map Category	Remark
0x8101	RM-1602-T	Input Coil	Read-Only
0x8102	RM-2600-T	Coil Map	Readable/Writable
0x8103	RM-1050-T	Input Coil	Read-Only
0x8104	RM-3802-T	Input Register Map	Readable/Writable
0x8105	RM-3810-T	Holding Register Map	Readable/Writable

### How to use:

The ioPAC 8020 Modbus addressing is fixed mode; every module occupies 512(0x200) address space. This means that each slot has its own address space of 512. The base address begins at 0x0000.

Slot No.	Beginning Address	Total Address Space
0	0x0000	512 (0x200)
1	0x0200	512 (0x200)
2	0x0400	512 (0x200)
3	0x0600	512 (0x200)
4	0x0800	512 (0x200)



Example 1: We have a RM-3802-T module (8 channel Analog Inputs) in slot-4. The input value can be read by the address below. (The analog input value data format is 1 word)

Channel No.	Modbus Address		How to calculate (Input register map, data format: 1 word)
	HEX. Value	DEC. Value	
0	0x0801	2049	$(0x200*4+0)+1= 2049$
1	0x0802	2050	$(0x200*4+1)+1= 2563$
2	0x0803	2051	$(0x200*4+2)+1= 2565$
3	0x0804	2052	$(0x200*4+3)+1= 2567$
4	0x0805	2053	$(0x200*4+4)+1= 2569$

Example 2: We have a RM-2600-T module (16 channel Digital Outputs) in slot 0. The input value can be read by the address below. (The digital output value data format is 1 bit)

Channel No.	Modbus Address		How to calculate (Coil map, data format: 1 bit)
	HEX. Value	DEC. Value	
0	0x0001	1	$(0x200*0+0)+1= 1$
1	0x0002	2	$(0x200*0+1)+1= 1$
2	0x0003	3	$(0x200*0+2)+1= 1$
3	0x0004	4	$(0x200*0+3)+1= 1$
4	0x0005	5	$(0x200*0+4)+1= 1$
...	...	....	...

## Module Configuration Map (Holding register map)

Using Module Configuration Map, users can read the I/O alias name, and power on setting value. The ioPAC 8020 Modbus addressing is fixed mode; every module occupies 512(0x200) address space. This means that each slot has its own address space of 512. The base address begins at 0x3000.

Slot No.	Beginning Address	Total Address Space
0	0x3000	512 (0x200)
1	0x3200	512 (0x200)
2	0x3400	512 (0x200)
3	0x3600	512 (0x200)
4	0x3800	512 (0x200)

## System Configuration Map (Input register map)

Using System Configuration Map, users can read the ioPAC system information. The ioPAC 8020 Modbus addressing is fixed mode; every module occupies 512(0x200) of address space. That means that each slot has its own address space of 512. The base address is begins from 0x6000.

Slot No.	Beginning Address	Total Address Space
0	0x6000	512 (0x200)
1	0x6200	512 (0x200)
2	0x6400	512 (0x200)
3	0x6600	512 (0x200)
4	0x6800	512 (0x200)

# Modbus Table

## System Configuration Map

### Input register map (Read-Only)

Address offset	Access	Data Format	Description
0x0000 ~0x0016			Reserved
0x0017 ~ 0x002A	R	20 Word	Product Name
0x002B ~0x0030	R	2 Word	Product Number
0x0031	R	1 Word	Number of TCP connection
0x0032	R	3 Word	MAC0
0x0037	R	1 Word	Click&Go Ready flag

### Holding register map(R/W)

Address offset	Access	Data Format	Description
0x0000	R/W	2 Word	LAN-0 IP
0x0002	R/W	2 Word	LAN-0 Mask
0x0004	R/W	2 Word	Gateway-0
0x0006	R/W	1 Word	LAN-0 IP Acquisition mode
0x0007	R/W	2 Word	DNS-1
0x0009	R/W	2 Word	DNS-2
0x000B	R/W	1 Word	Connection idle timeout
0x000C	R/W	1 Word	Local Timer second
0x000D	R/W	1 Word	Local Timer minute
0x000E	R/W	1 Word	Local Timer hour
0x000F	R/W	1 Word	Local Timer day
0x0010	R/W	1 Word	Local Timer month
0x0011	R/W	1 Word	Local Timer year
0x0012	R/W	1 Word	TimeZone
0x0014	R/W	5 Word	Password
0x0019	R/W	1 Word	Connection watchdog timeout
0x001A	R/W	1 Word	Safe mode status Bit 0: connection WDT Bit 1: Hot-swap
0x001B	R/W	1 Word	IP filter enable/disable
0x001C	R/W	10 Word	IP filter enable list
0x0026	R/W	20 Word	IP filter IP list
0x003A	R/W	20 Word	IP filter mask list
0x004E	R/W	20 Word	Time server
0x0062	R/W	20 Word	Log server
0x0076	R/W	1 Word	Log server port number
0x0077	R/W	30 Word	Location
0x0096	W	1 Word	Memorize the module configuration 0: clear module combination 1: commit current module combination

Address offset	Access	Data Format	Description
0x00B3	R/W	1 Word	Memorize the module configuration 0: clear module combination 1: commit current module combination
0x00B4	R/W	1 Word	Hot-swap safe mode discard 1: NOT go to safe mode if module change 0: go to safe mode if module change
0x00B5	R/W	1 Word	SNMP enable/disable 1: Enable 0: Disable
0x00B6	R/W	1 Word	SNMP version Bit0: V1, bit 1: V2, Bit2: V3
0x2000	R/W	1	Click&Go start/stop 1: Start 0: Stop

### 5xxxx Write Registers (Support function 8)

Sub-function	(Request)	(Response)	Description
0x0001	0xFF00	Echo Request Data	Reboot
0x0001	0x55AA	Echo Request Data	Reset with Factory default

### Module Configuration Map

#### For 16Channel Digital Output Module (RM-2600-T):

Address offset	Access	Data Format	Description
0x0000	Read-only	1 Word	Module ID
0x0001	Read-only	1 Word	HW version
0x0002	Read-only	1 Word	FW version
0x0003	Read-only	1 Word	Series number
0x0004	Read-only	1 Word	Number of channels
0x0005	Read-only	1 Word	Channel Occupied by Logic

#### Holding register map(R/W)

Address offset	Access	Data Format	Description
0x0000~8N-1	R/W	1 Word	Channel alias name
8N~16N-1	R/W	1 Word	Alias for ON status
16N~24N-1	R/W	1 Word	Alias for OFF status

#### Coil map(R/W)

Address offset	Access	Data Format	Description
0x0000~N-1	R/W	1 bit	Safe mode action (0: fault value, 1: hold last state)
N~2N-1	R/W	1 bit	Fault value
2N~3N-1	R/W	1 bit	Power-on status

**For 16Channel Digital Input Module (RM-1600-T):****Input register map(R)**

Address offset	Access	Data Format	Description
0x0000	Read-only	1 Word	Module ID
0x0001	Read-only	1 Word	HW version
0x0002	Read-only	1 Word	FW version
0x0003	Read-only	1 Word	Series number
0x0004	Read-only	1 Word	Number of channels
0x0005	Read-only	1 Word	Channel Occupied by Logic

**Holding register map((N: Channel Number)**

Address offset	Access	Data Format	Description
0x0000~8N-1	R/W	8 Word	Channel alias name
8N~16N-1	R/W	8 Word	Alias for ON status
16N~24N-1	R/W	8 Word	Alias for OFF status

**For 10Channel Digital Input Module (RM-1500-T):****Input register map(R)**

Address offset	Access	Data Format	Description
0x0000	Read-only	1 Word	Module ID
0x0001	Read-only	1 Word	HW version
0x0002	Read-only	1 Word	FW version
0x0003	Read-only	1 Word	Series number
0x0004	Read-only	1 Word	Number of channels
0x0005	Read-only	1 Word	Channel Occupied by Logic

**Holding register map((N: Channel Number)**

Address offset	Access	Data Format	Description
0x0000~8N-1	R/W	8 Word	Channel alias name
8N~16N-1	R/W	8 Word	Alias for ON status
16N~24N-1	R/W	8 Word	Alias for OFF status

**For 8Channel Analog Input Module (RM-3802-T / RM-3810-T):****Input register map(R)**

Address offset	Access	Data Format	Description
0x0000	Read-only	1 Word	Module ID
0x0001	Read-only	1 Word	HW version
0x0002	Read-only	1 Word	FW version
0x0003	Read-only	1 Word	Series number
0x0004	Read-only	1 Word	Number of channels
0x0005	Read-only	1 Word	Channel Occupied by Logic

**Holding register map (N: Channel Number)**

Address offset	Access	Data Format	Description
0x0000~8N-1	R/W	8 Word	Channel alias name

## Used Network Port Numbers

---

ioPAC 8020 Network Port Usage

Port	Type	Usage
80	TCP	Web Server
502	TCP	Modbus Communication
161	TCP	SNMP
68	UDP	BOOTPC
68	UDP	DHCP
4800	UDP	Auto search(handled by MOS)

## SNMP MIB file

---

The ioPAC 8020 has built-in SNMP(Simple Network Management Protocol) agent software that supports SNMP traps, RFC1317 RS232-like groups, and RFC 1213 MIB-II. The following table lists the standard MIB-II groups, as well as the variable implementation for the ioPAC 8020.

### RFC1213 MIB-II supported SNMP variables

System MIB
SysDescr
SysObjectID
SysUpTime
SysContact
SysName
SysLocation
SysServices

### Private MIB File and SNMP Variables

Moxa also provides SNMP support for the I/O MIB file to help you monitor I/O status with SNMP software. You can find the MIB file on the Document and Software CD.

Moxa Modular IO MIB		
moduleName0	moduleName1	moduleName2
ioType0	ioType1	ioType2
numberOfChannels0	numberOfChannels1	numberOfChannels2
di0Index	di1Index	di2Index
di0Status	di1Status	di2Status
do0Index	do1Index	do2Index
do0Status	do1Status	do2Status
ai0Index	ai1Index	ai2Index
ai0Type	ai1Type	ai2Type
ai0Value	ai1Value	ai2Value
ao0Index	ao1Index	ao2Index
ao0Range	ao1Range	ao2Range
ao0Value	ao1Value	ao2Value
rtd0Index	rtd1Index	rtd2Index
rtd0Enable	rtd1Enable	rtd2Enable
rtd0Type	rtd1Type	rtd1Type
rtd0UnitType	rtd1UnitType	rtd2UnitType
rtd0Value	rtd1Value	rtd2Value
tc0Index	tc1Index	tc2Index
tc0Enable	tc1Enable	tc2Enable
tc0Type	tc1Type	tc2Type
tc0UnitType	tc1UnitType	tc2UnitType
tc0Value	tc1Value	tc2Value
moduleName3	moduleName4	maxNumberOfSlots
ioType3	ioType4	serverModel

numberOfChannels3	numberOfChannels4	systemLiveTime
di3Index	di4Index	firmwareVersion
di3Status	di4Status	
do3Index	do4Index	
do3Status	do4Status	
ai3Index	ai4Index	
ai3Type	ai4Type	
ai3Value	ai4Value	
ao3Index	ao4Index	
ao3Range	ao4Range	
ao3Value	ao4Value	
rtd3Index	rtd4Index	
rtd3Enable	rtd4Enable	
rtd3Type	rtd4Type	
rtd3UnitType	rtd4UnitType	
rtd3Value	rtd4Value	
tc3Index	tc4Index	
tc3Enable	tc4Enable	
tc3Type	tc4Type	
c3UnitType	tc4UnitType	
tc3Value	tc4Value	

## Factory Default Settings

---

**ioPAC 8020 is configured with the following default private IP address:**

Default LAN IP address:	192.168.127.254
Default LAN Netmask:	255.255.255.0
Default LAN Gateway:	0.0.0.0(None)
Time Zone	23
Communication watchdog:	Disable
Modbus Idle Timeout:	60 secs
Click&Go Power-On Status:	Stop
DO Power-On Status:	OFF
DO Safe Action:	Fault value
DO Fault value:	OFF
Alias name of Channel	CH
Alias name of on	ON
Alias name of off	OFF
Password:	"empty"
Module Name:	"empty"
Module Location:	"empty"
Password:	"empty"
SNMP:	Enable
Read Community:	Public
Write Community:	Private
Contact:	"empty"
Location:	"empty"