

# **Moxa MxNVR-IA8 Industrial Network Video Recorder User's Manual**

---

**Edition 2.1, May 2016**

[www.moxa.com/product](http://www.moxa.com/product)

**MOXA®**

© 2016 Moxa Inc. All rights reserved.

# Moxa MxNVR-IA8

## Industrial Network Video Recorder

### User's Manual

The software described in this manual is furnished under a license agreement and may be used only in accordance with the terms of that agreement.

#### Copyright Notice

© 2016 Moxa Inc. All rights reserved.

#### Trademarks

The MOXA logo is a registered trademark of Moxa Inc.  
All other trademarks or registered marks in this manual belong to their respective manufacturers.

#### Disclaimer

Information in this document is subject to change without notice and does not represent a commitment on the part of Moxa.

Moxa provides this document as is, without warranty of any kind, either expressed or implied, including, but not limited to, its particular purpose. Moxa reserves the right to make improvements and/or changes to this manual, or to the products and/or the programs described in this manual, at any time.

Information provided in this manual is intended to be accurate and reliable. However, Moxa assumes no responsibility for its use, or for any infringements on the rights of third parties that may result from its use.

This product might include unintentional technical or typographical errors. Changes are periodically made to the information herein to correct such errors, and these changes are incorporated into new editions of the publication.

#### Technical Support Contact Information

[www.moxa.com/support](http://www.moxa.com/support)

##### **Moxa Americas**

Toll-free: 1-888-669-2872  
Tel: +1-714-528-6777  
Fax: +1-714-528-6778

##### **Moxa Europe**

Tel: +49-89-3 70 03 99-0  
Fax: +49-89-3 70 03 99-99

##### **Moxa India**

Tel: +91-80-4172-9088  
Fax: +91-80-4132-1045

##### **Moxa China (Shanghai office)**

Toll-free: 800-820-5036  
Tel: +86-21-5258-9955  
Fax: +86-21-5258-5505

##### **Moxa Asia-Pacific**

Tel: +886-2-8919-1230  
Fax: +886-2-8919-1231

# Before Getting Started

Before using your MxNVR-IA8, please pay close attention to the following instructions:

- After opening the MxNVR-IA8 box, compare the contents of the box with the **Package Checklist in Chapter 1**. Notify your sales representative if any of the items are missing or damaged.
- If you experience a system error, and the system can not be recovered, refer to the **Troubleshooting** section in **Chapter 7** to learn how to restore factory default settings and reinstall the system.
- The Industrial Network Video Recorder has been designed for various environments and can be used to build various applications for general security or demonstration purposes. For standard applications, refer **Chapter 2, Getting Started**, and **Chapter 3, Accessing the MxNVR-IA8 Industrial Network Video Recorder for the First Time**.

## Important Note

- Surveillance devices may be prohibited by law in your country. Since the MxNVR is both a high performance surveillance system and networked video recorder, verify that the operations of such devices are legal in your locality before installing this unit for surveillance purposes.

# Table of Contents

<b>1. Introduction</b> .....	<b>1-1</b>
Overview .....	1-2
Package Checklist .....	1-2
Product Features .....	1-2
Typical Application .....	1-3
MxNVR-IA8 Panel Layout .....	1-3
Product Description.....	1-5
<b>2. Getting Started</b> .....	<b>2-1</b>
Before Getting Started .....	2-2
First-Time Installation and Configuration .....	2-2
Installing a Hard Disk.....	2-5
Dimensions .....	2-8
Mounting the MxNVR-IA8.....	2-8
Wiring Requirements.....	2-10
Grounding the MxNVR-IA8.....	2-10
Wiring the Power Input .....	2-10
Wiring the DI/DO .....	2-11
10/100/1000BaseT(X) Ethernet Port Connection .....	2-11
<b>3. Accessing the MxNVR-IA8 Web-based Manager</b> .....	<b>3-1</b>
Overview of the MxNVR-IA8 Web Homepage.....	3-2
Recording LED Status .....	3-2
System Information.....	3-2
Video Source List .....	3-2
Camera List.....	3-2
System Configuration .....	3-3
Remote Playback.....	3-3
DO Control .....	3-6
<b>4. System Configuration</b> .....	<b>4-1</b>
System Configuration by Web Console .....	4-2
System .....	4-3
Network.....	4-9
Video Source List .....	4-17
Schedule .....	4-19
Alarm .....	4-21
<b>A. Frequently Asked Questions</b> .....	<b>A-1</b>
<b>B. ModBus Address Table</b> .....	<b>B-1</b>
<b>C. Time Zone Table</b> .....	<b>C-1</b>
<b>D. Technical Specifications</b> .....	<b>D-1</b>

## Introduction

---

The MxNVR-IA8 is a rugged networking video recorder designed for use in harsh environments. In addition to being able to handle basic video feeds, many advanced features are also included to set up surveillance or web multimedia applications. The MxNVR-IA8 is designed to provide stability, robustness, ease-of-use, and flexibility.

The following topics are covered in this chapter:

- ❑ **Overview**
- ❑ **Package Checklist**
- ❑ **Product Features**
- ❑ **Typical Application**
- ❑ **MxNVR-IA8 Panel Layout**
- ❑ **Product Description**

# Overview

The MxNVR-IA8 is a revolutionary new 8-channel industrial network video recorder designed for recording the MxNVR's MJPEG, MPEG4, and H.264 video streams in harsh environments. With rugged design features, such as no heater or fan, -40 to 75°C operating temperatures, and protection against high EMI and surges, as well as the ability to save bandwidth when transmitting video streams back to the remote control center or machine room for video recording, the MxNVR-IA8 is tailor-made for field site applications. Since videos are only transmitted when remote live view and video playback are required, you will see an improvement in network transmission efficiency and a noticeable reduction in your bandwidth investments.

## Package Checklist

The MxNVR-IA8 ships with the following items:

- The MxNVR-IA8
- 2 rackmount ears with screws
- 1 3-pin terminal block for power input
- 2 5-pin terminal blocks for the 6 DIs and 2 DOs
- 8 HDD screws
- 4 pads
- Quick installation guide
- Documentation and software CD
- Warranty card

*Note: If any of these items are missing or damaged, please contact your service representative for assistance*

## Product Features

- Supports MJPEG, MPEG4, and H.264 video recording (only for the MxNVR products)
- Capable of recording up to 8 video stream channels and 240 frames/second at 720x480 resolution
- Built-in 2 SATA interface for 2 SSDs (solid state hard disks) or 2.5 inch hard disks
- Linux OS platform stored in a DOM for high reliability
- No built-in heater and fan
- Supports remote playback and FTP download for recorded videos
- Supports recording in AVI format, which can be played by general media players
- 3 video recording modes: manual, schedule, and alarm
- Supports pre-alarm (up to 30 seconds) and post-alarm (60 seconds) video recording functions
- Web console for system configuration
- Built-in one Gigabit Ethernet for video transmission
- Provides 2 RS-232/422/485 COM ports for connecting external devices
- Provides 6 DIs (digital inputs) and 2 DOs (digital outputs) for external sensors and alarms
- Provides 1 USB port for connecting peripheral devices
- Supports 802.1X, IP filtering for access authentications
- Supports Modbus/TCP for direct SCADA communications
- Supports SNMP for network management
- Supports CGI commands for customized programming
- 8 built-in LED indicators for showing the status of each video channel
- 1 built-in LED for showing the storage status
- Maximum of 10 connections

- Free Moxa MxNVR SDK Plus (software development kit) supported with flexible interface and sample code for customized applications or system integration

**NOTE** If you are interested in Moxa’s VPORT SDK PLUS, go to Moxa’s website [www.moxa.com](http://www.moxa.com) to download the package, or contact a Moxa sales representative for more information about this SDK

## Typical Application

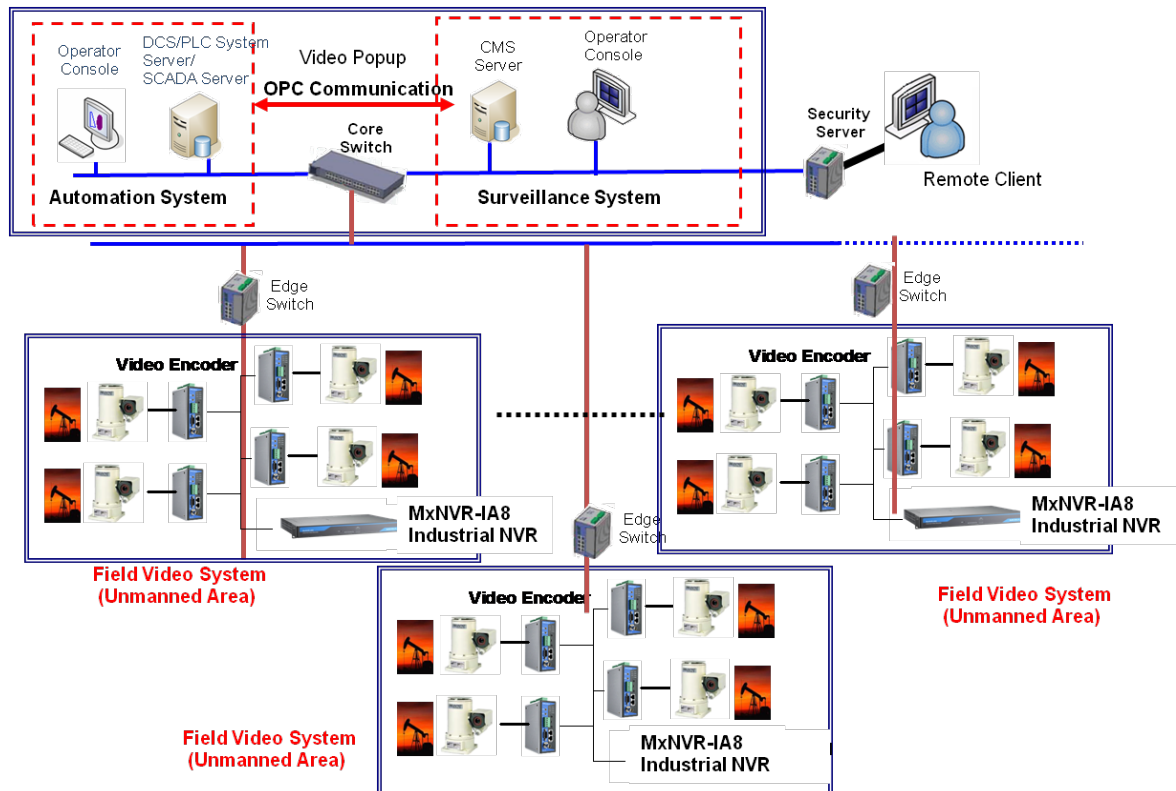

## MxNVR-IA8 Panel Layout

### Front View

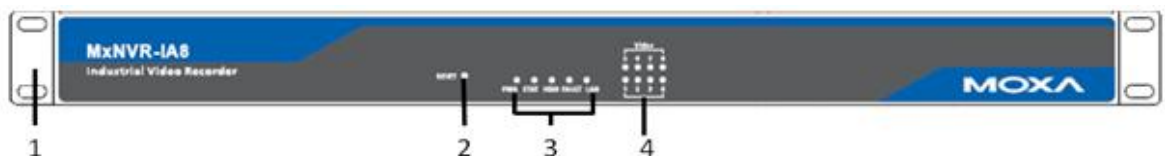

1. 19-inch rack mount ear (with accessory)
2. Reset button
3. LED indicators for PWR (power), STAT (System), HDD (Hard disk), FAULT, and LAN (10 or 100 Mbps)
4. LED indicators for video sources: V1, V2, V3, V4, V5, V6, V7, and V8

## Rear View



5. RS-232/422/485 COM ports with DB9 male connectors (reserved for future use)
6. USB 2.0 Host (Type A) (reserved for future use)
7. 10/100/1000BasedT(X) Ethernet port
8. AUDIO Output (reserved for future use)
9. 6 digital inputs (DI) and 2 digital outputs (DO)
10. 24 VDC Power input (12 to 32 VDC)
11. Ground screw

## Top View

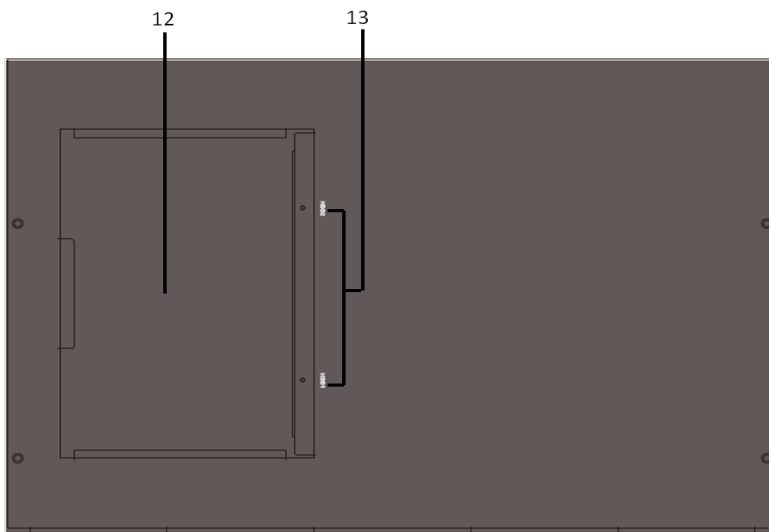

12. The cover of the hard disk socket
13. 2 2.5-inch hard disk sockets for HDD1 and HDD2



# Product Description

## LED Indicators

The front panel of the MxNVR-IA8 has several built-in LED indicators. The function of each LED is described in the following table.

LED	Color	State	Description
PWR	AMBER	On	Power is being supplied
		Off	Power is not being supplied
STAT	RED	ON	Hardware initialization
		FLASHING	Software initialization
	GREEN	ON	System boot-up
		FLASHING	Firmware upgrade proceeding
HDD	GREEN	On	Hard disks are connected
		FLASHING	Hard disks are in read/ write operation
		Off	Hard disks are not connected
FAULT	RED	On	3 conditions could cause the LED to light up: <ul style="list-style-type: none"> <li>• Video source is loss</li> <li>• Network is disconnected</li> <li>• Hard disks are failed</li> </ul>
		Off	No fault has occurred
V1/V2/V3/V4/ V5/V6/V7/V8	GREEN	On	Video source is in recording
		Off	Video source is not recording
LAN	AMBER	On	10/100 Mbps link is active
		Blinking	Data is being transmitted at 10 Mbps
		Off	10/100 Mbps link is inactive
	GREEN	On	1000 Mbps link is active
		Blinking	Data is being transmitted at 1000 Mbps
		Off	1000 Mbps link is inactive

## 10/100/1000Mbps Ethernet Port

The MxNVR-IA8 has one RJ45 10/100/1000M Ethernet port (LEDs on the front panel will show the connection to be 10/100M or 1000M).

## RS-232/RS-422/RS-485 COM ports (reserved for future use)

Two RS-232/422/485 COM ports are located on the rear panel. The two COM ports are reserved for the future use.

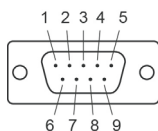

Pin	RS-232	RS-422	RS-485 (4-wire)	RS-485 (2-wire)
1	DCD	TxDA(-)	TxDA(-)	-
2	RxD	TxDB(+)	TxDB(+)	-
3	TxD	RxDB(+)	RxDB(+)	DataB(+)
4	DTR	RxDA(-)	RxDA(-)	DataB(-)
5	GND	GND	GND	GND
6	DSR	-	-	-
7	RTS	-	-	-
8	CTS	-	-	-

## 24 VDC Power Input

The MxNVR-IA8 can be powered by a DC power input from 12 to 32 VDC. Users can check the PWR LED status located on the front panel to see if the power inputs are connected appropriately.

### Power Input

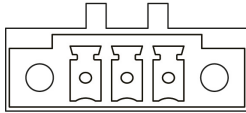

V+ V-  $\hbar$   
DC 12-32 V $\equiv$

**NOTE** The supported power input specifications for the MxNVR-IA8 series are 12 to 32 VDC for a 24 VDC power input. The maximum power consumption is around 25 watts (with two 2.5" hard disks).

## General I/O Terminal Blocks

The MxNVR-IA8 supports six DIs (digital inputs) and two DOs (digital outputs) to connect the external sensors and alarms. These DIs and DOs are connected with two 5-pin terminal blocks.

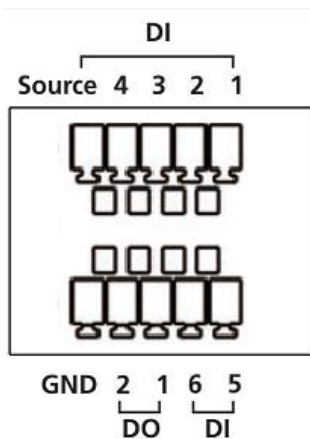

Pin No.	Signal
1	DI1
2	DI2
3	DI3
4	DI4
5	DI source
6	DI5
7	DI6
8	DO1
9	DO2
10	COM

DI	Input Voltage: 0 to 30 VDC at 15 KHz Digital Input Levels for Dry Contacts: <ul style="list-style-type: none"> <li>• Logic level 0: Close to GND</li> <li>• Logic level 1: Open</li> </ul> Digital Input Levels for Wet Contacts: <ul style="list-style-type: none"> <li>• Logic level 0: +3 V max.</li> <li>• Logic level 1: +10 V to +30 V (Source to DI)</li> </ul> Isolation: 3 KV optical isolation
DO	Output Current: Max. 20 mA per channel On-state Voltage: 24 VDC nominal Isolation: 3 KV optical isolation

## USB type A Connector (reserved for future use)

The MxNVR-IA8 supports one USB type A connector located on the rear panel. This USB port is reserved for future use.

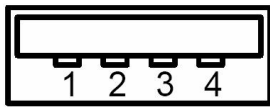

Pin No.	Function
1	V <sub>BUS</sub> (5 volts)
2	D-
3	D+
4	Ground

## Audio Output (reserved for future use)

The MxNVR-IA8 supports 1 audio output with a 3.5 mm phone jack connector, which is located on the rear panel. This audio output port is reserved for future use.

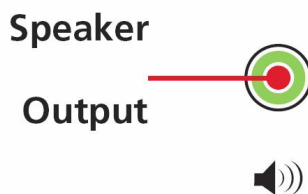

## Reset Button

A recessed RESET button is provided for rebooting and restoring the system to the factory default settings. Use a pointed object, such as a straightened paper clip or toothpick, to press the reset button.

### Reboot:

To reboot the MxNVR-IA8, power it off and then power it back on again, or push the RESET button one time. The STAT LED will light in red as the POST (Power On Self Test) process runs. When the rebooting process is finished, the STAT LED will turn green.

### Restore to Factory Settings:

A recessed RESET button is provided for restoring the system to the factory default settings. When the system fails to install properly, or operates abnormally, use the RESET button located on the front panel of the MxNVR-IA8 to restore the factory defaults.

To do this, use a pointed object such as a straightened paper clip or toothpick to hold down the reset button, and then release the reset button when the STAT LED stops flashing in red. At this point, the POST process will run, and the MxNVR-IA8 will reboot. The STAT LED will turn green when the MxNVR-IA8 has finished rebooting.

## 2.5-inch Hard Disk Sockets (HDD1 and HDD2)

The MxNVR-IA8 has two built in 2.5-inch hard disk sockets with SATA connectors to connect with 2.5-inch SATA hard disks or 2.5-inch SSDs (solid state disks). These 2 hard disk sockets are located on the front panel of MxNVR-IA8. You will need to buy 2.5-inch hard disks for the MxNVR-IA8 (0 to 60°C) and 2.5-inch SSDs (solid state disks) with -40 to 75°C operating temperature for the MxNVR-IA8-T.

**NOTE** There are a lot of hard disk suppliers on the market. We recommend using the main supplier's products with the MxNVR-IA8. The MxNVR-IA8 was tested in our lab using a 2.5" Toshiba MK5065GSX (500GB) HDD, and the MxNVR-IA8-T was tested in our lab with an Innodisk SATA 10000 (128 GB) SSD.

**NOTE** The MxNVR-IA8 comes with a 5-year warranty, but this warranty policy does not include the 2.5-inch SATA HDD and SSD, which are covered by the original manufacturers warranty.

**NOTE** To install the 2.5-inch SATA HDD or SDD, refer to the HDD installation section in Chapter 2.

## Getting Started

---

This chapter includes information about how to install an MxNVR-IA8 industrial network video recorder.

The following topics are covered in this chapter:

- ❑ **Before Getting Started**
- ❑ **First-Time Installation and Configuration**
- ❑ **Installing a Hard Disk**
- ❑ **Dimensions**
- ❑ **Mounting the MxNVR-IA8**
- ❑ **Wiring Requirements**
  - Grounding the MxNVR-IA8
  - Wiring the Power Input
  - Wiring the DI/DO
  - 10/100/1000BaseT(X) Ethernet Port Connection

# Before Getting Started

In what follows, “user” refers to those who can access the video recorder, and “Administrator” refers to the person who knows the root password that allows changes to the video recorder’s configuration, in addition to providing general access. The Administrator should read this part of the manual carefully, especially during installation.

## First-Time Installation and Configuration

Before installing the MxNVR-IA8, make sure that all items in the package checklist are in the box. In addition, you will need access to a notebook computer or PC equipped with an Ethernet port.

### Step 1: Install the hard disks

The MxNVR-IA8 has two 2.5-inch hard disk sockets with SATAII interface. You will need to purchase and install the 2.5-in hard disk (models with 0 to 60°C operating temperatures) or 2.5-in solid state disk (models with -40 to 75°C operating temperatures) into these two sockets.

**NOTE** To install a new hard disk, refer to the “Installing a New Hard Disk” section later in this chapter.

### Step 2: Connect the MxNVR-IA8 to a Network

The MxNVR-IA8 has a built in auto-sensing 10/100/1000 Mbps RJ45 Ethernet port. A LAN LED indicator located on the front panel indicates a 10/100 Mbps or a 1000 Mbps Ethernet connection.

### Step 3: Select the Power Source

The MxNVR-IA8 can be powered by a DC power input from 12 to 32 VDC. Check the PWR LED status located on the front panel to see if the power inputs are connected appropriately.

### Step 4: Configure the MxNVR-IA8’s IP address

After powering on the MxNVR-IA8, wait a few seconds for the POST (Power On Self Test) to run. The STAT LED turns green to indicate that the POST process has completed. When the LAN LED blinks, the IP address will be assigned based on the network environment.

#### Network Environment with DHCP Server

In this case, the IP address of the MxNVR-IA8 is assigned by a DHCP Server. Use the DHCP Server’s IP address table, or use the Moxa utility to determine the IP address that was assigned by the DHCP Server.

#### **Using the Moxa Ethernet Switch and Video Server Configurator Utility (edscfgui.exe)**

1. Run the **edscfgui.exe** program to search for Moxa IP video products and EDS switches. After the Utility window opens, click **Broadcast Search** under the **List Server** menu, or click the **Broadcast Search**  icon to initiate a search.

**NOTE** You may download the Moxa Ethernet Switch and Video Server Configurator software from Moxa’s website at [www.moxa.com](http://www.moxa.com).

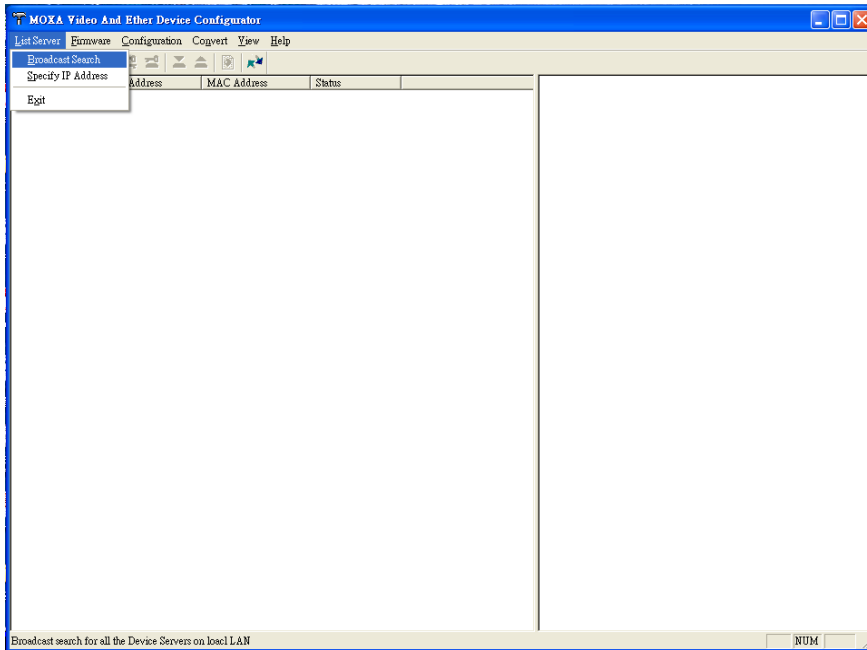

The Broadcast Search window will show a list of all the switches and MxNVRs connected to the network. The search progress will also be shown in the window.

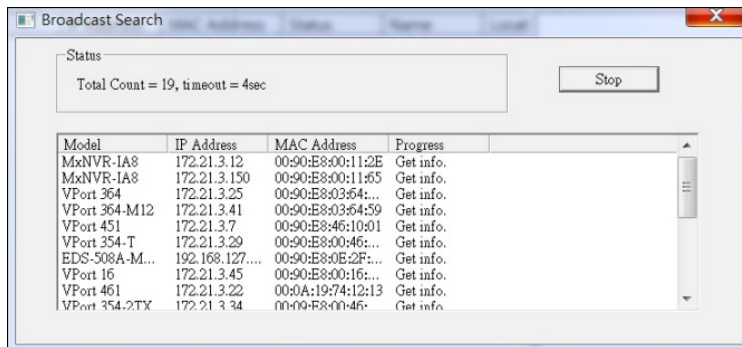

- When the search has ended, the Model Name, MAC address, and IP address of the EDS switches and MxNVRs will be listed in the Utility window.

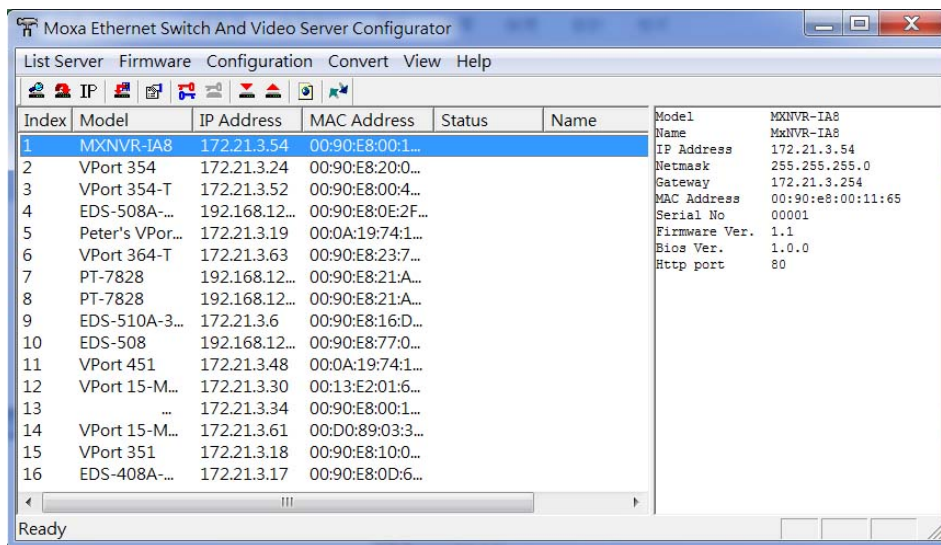

**NOTE** The Broadcast Search function can only be used for searching the devices connected to the same LAN subnet.. If your devices are located on a different LAN subnet, use the "Specify IP Address" function to search for the device by typing the IP address.

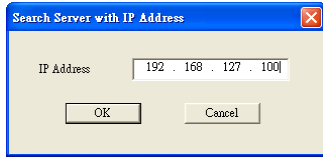

3. Type the MxNVR’s IP address in the Internet Explorer address field to access the MxNVR’s web-based manager (web console).

**Network Environment without a DHCP Server**

If your MxNVR is connected to a network that does not have a DHCP server, you will need to configure the IP address manually. The default IP address of the MxNVR is 192.168.127.100, and the default subnet mask is 255.255.255.0. Note that you may need to change your computer’s IP address and the subnet mask so as to locate the computer on the same subnet as the MxNVR.

To change the IP address of the MxNVR manually, access the MxNVR’s web server, and then navigate to the **System Configuration → Network → General** page to configure the IP address and the other network settings. Enable **Use fixed IP address** to ensure that the IP address you assign is not deleted every time the MxNVR is restarted.

**Step 5: Log in and access the MxNVR web-based manager (web console)**

Type the IP address in the web browser’s address field box and then press enter.

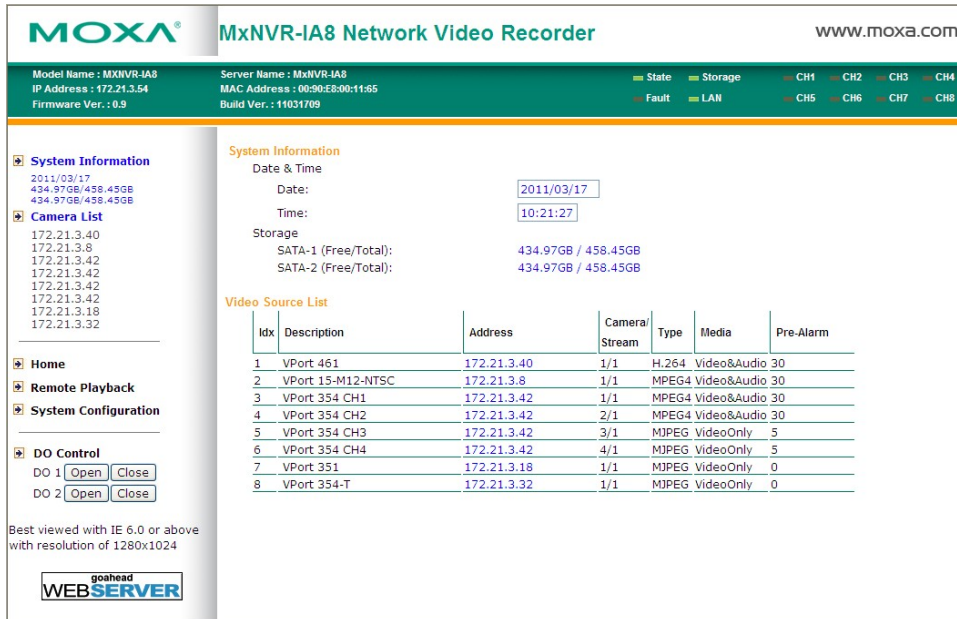



**Step 6: Access the MxNVR-IA8's System Configuration**

Click on **System Configuration** to access the overview of the system, or to change the settings. The Model Name, Server Name, IP Address, MAC Address, Firmware Version, and LED Status appear in the green bar at the top of the page. Use this information to check the system information and installation.

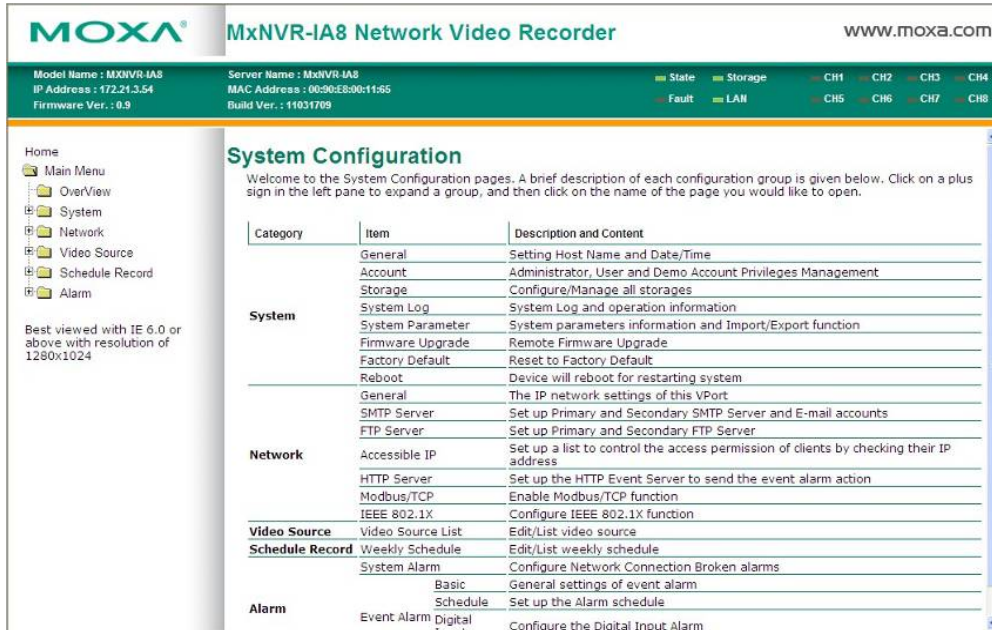

# Installing a Hard Disk

- NOTE**
1. Always make sure the power is off when you install a hard disk.
  2. Always be sure to use a 2.5-inch SATA SSD (solid state disk) with -40 to 75°C operating temperature capability for MxNVR-IA8-T for operation in extreme temperature environments.

The MxNVR-IA8 supports two hard disk sockets for connecting the hard disks for video storage. To install a hard disk, see the processes below.

**Step 1:** Disconnect the power input and remove the two screws from the HDD socket's cover

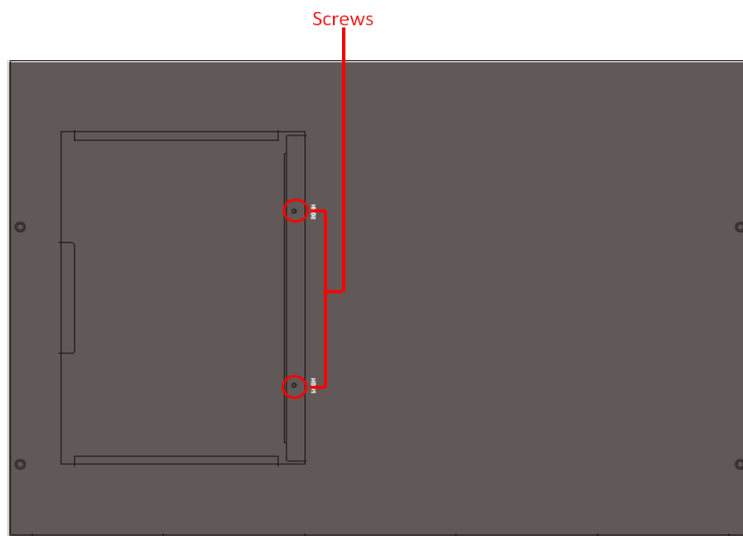

**Step 2:** Remove the cover of the HDD socket.

**Step 3:** Loosen the screws of the HDD socket, and remove the components inside.

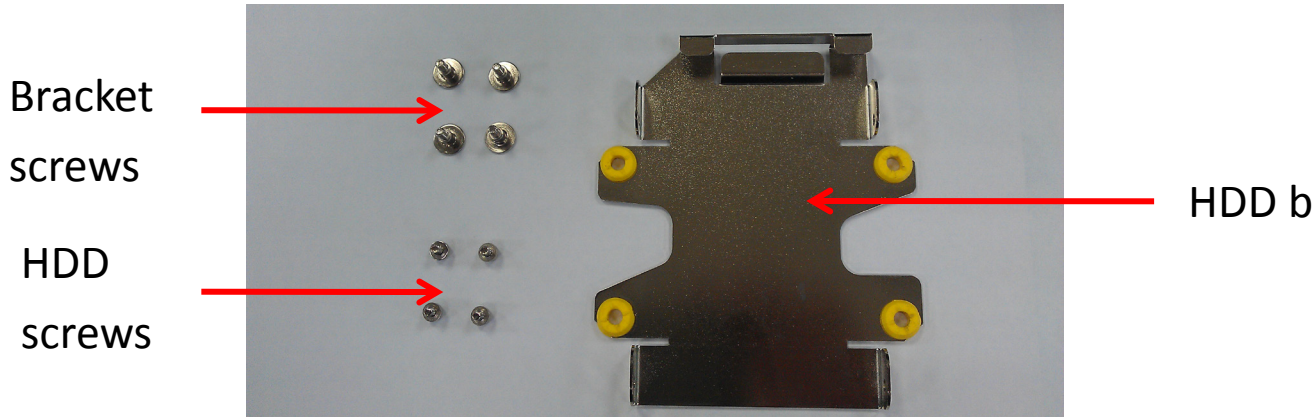

**NOTE** The HDD screws are included with the accessories for the MxNVR-IA8.

**Step 4:** Connect the SATA cable to the HDD connectors.

SATA Cable



**Step 5:** Place the hard drive disk on the bracket, and then use the 4 HDD screws to fasten it.



**Step 6:** Fasten the 4 bracket screws

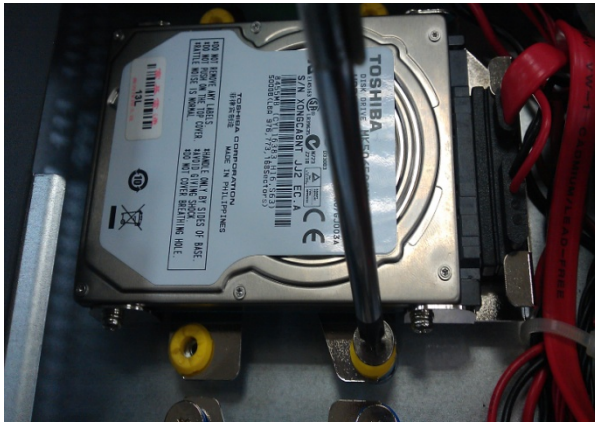

**Step 7:** Replace the cover of HDD sockets.

**Step 8:** Connect the power input. After the system is booted up successfully, log in to the MxNVR-IA8 web console, and go to **System Configuration → System → Storage Configuration** page.

---

### Storage Management

Storage list

<input type="checkbox"/>	Disk	Model	Temp.	Capacity	Health	Available	Enable
<input type="checkbox"/>	1	TOSHIBA MK5065GSX	33°C	500,107,862,016 bytes	Normal	Yes	Yes
<input type="checkbox"/>	2	TOSHIBA MK5065GSX	34°C	500,107,862,016 bytes	Normal	Yes	Yes

**Step 9:** Click on the **Format** button to format the hard disk. Then the hard disk will start running the formatting process. Once the formatting process is done, the hard disk installation is completed.

---

### Format Disk now, Please Wait....

Format Disk 1 : Partitioning...

**NOTE** The HDD format used by the MxNVR-IA8 is Ext3, so this HDD cannot be used as an external HDD with PC or any other storage server. The only way to back up the recorded videos is through the FTP download that the MxNVR-IA8 provides.

**NOTE** The two HDDs installed in the MxNVR-IA8 cannot be used as redundant storage HDDs.

# Dimensions

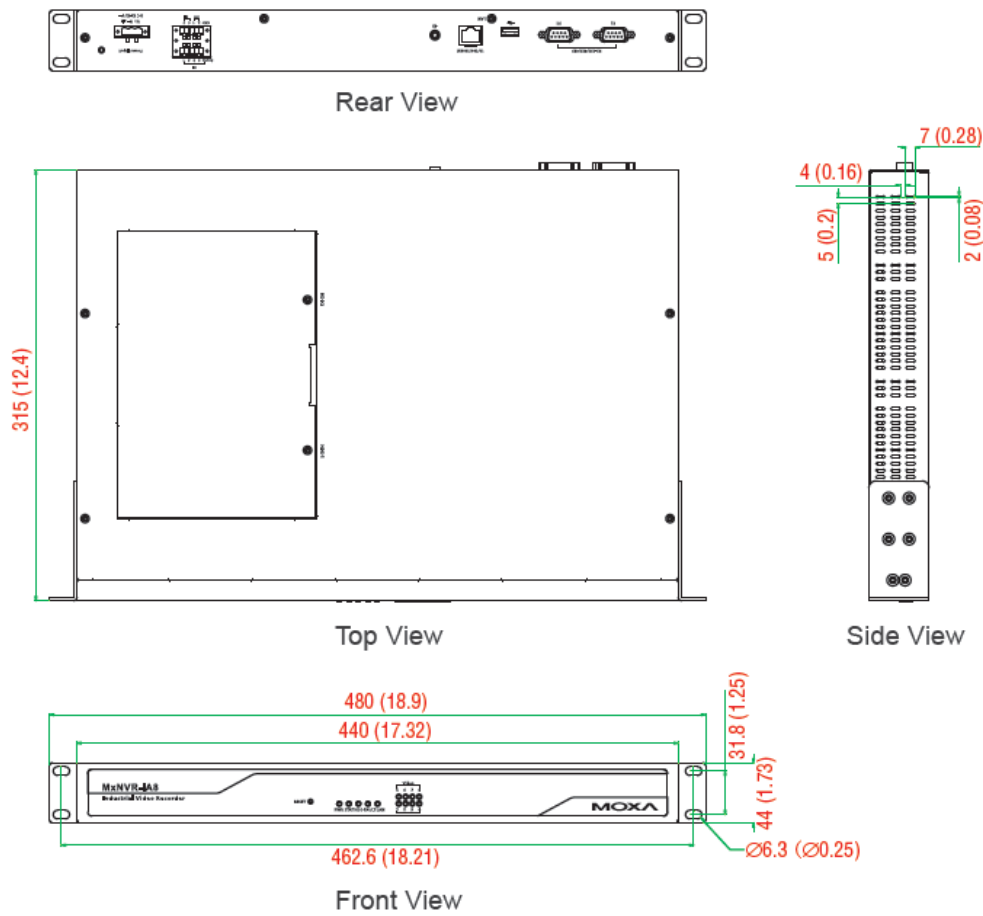

(Unit: mm)

## Mounting the MxNVR-IA8

The MxNVR-IA8 has a 19-inch rackmount kit, which can be used to install the industrial network video recorder on a standard rack.



### ATTENTION

- For maximum safety, at least two persons should work together to lift, place, and attach the industrial network video recorder to the rack.
- Before you lift or move the industrial network video recorder, make sure that the unit is turned off and the power to the rack system is also turned off.

Four rackmount screws are required to attach the MxNVR-IA8 to a standard rack.

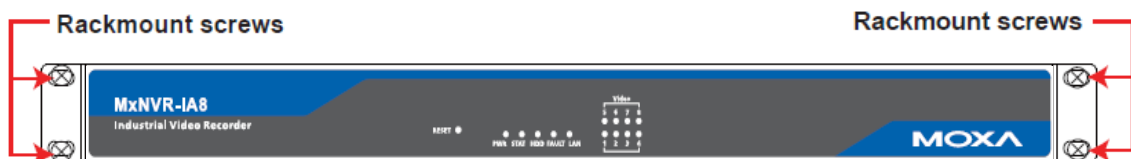

Follow these steps to install the MxNVR-IA8 on a rack.

**STEP 1: Install the rackmount kit.**

Take the rackmount kit out of the package. There are two rackmount ears and 12 screws. Each ear requires six screws to attach to the rack.

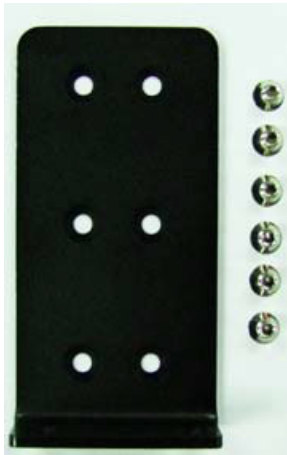

**STEP 2: Install the rackmount ears on the MxNVR-IA8.**

Use 6 screws to attach one rackmount ear to one side of the MxNVR-IA8. Repeat this step to attach the ear on the other side of the MxNVR-IA8.

**STEP 3: Install the MxNVR-IA8 to a rack.**

Gently slide the MxNVR-IA8 onto the rack, and then use the screws provided by the rack supplier to fix the rackmount support to the rail.



**ATTENTION**

**Safety First!**

The following or similar rackmount instructions are included in the installation instructions:

1. Elevated Operating Ambient - If installed in a closed or multi-unit rack assembly, the operating ambient temperature of the rack environment may be greater than the room ambient. Therefore, consideration should be given to installing the equipment in an environment compatible with the maximum ambient temperature (T<sub>ma</sub>) specified by the manufacturer.
2. Reduced Air Flow - Installation of the equipment in a rack should be such that the amount of air flow required for safe operation of the equipment is not compromised.
3. Mechanical Loading - Mounting of the equipment in the rack should be such that a hazardous condition is not achieved due to uneven mechanical loading.
4. Circuit Overloading - Consideration should be given to the connection of the equipment to the supply circuit and the effect that overloading of the circuits might have on overcurrent protection and supply wiring. Appropriate consideration of equipment nameplate ratings should be used when addressing this concern.
5. Reliable Earthing - Reliable earthing of rackmounted equipment should be maintained. Particular attention should be given to supply connections other than direct connections to the branch circuit (e.g. use of power strips).

# Wiring Requirements



## ATTENTION

### Safety First!

- Be sure to disconnect the power cord before installing and/or wiring your Moxa MxNVR-IA8.
- Calculate the maximum possible current in each power wire and common wire. Observe all electrical codes dictating the maximum current allowable for each wire size.
- If the current goes above the maximum ratings, the wiring could be overheated, causing serious damage to your equipment.

You should also pay attention to the following:

- Use separate wiring paths for power and devices. If power wiring and device wiring paths must cross, make sure the wires are perpendicular at the intersection point.  
NOTE: Do not run signal or communications wiring and power wiring in the same wire conduit. To avoid interference, wires with different signal characteristics should be routed separately.
- You can determine which wires should be routed separately by the transmitted signal types. The rule of thumb is that wires that share similar electrical characteristics can be bundled together.
- Keep input wiring and output wiring separated.
- We strongly recommend that you label all the wires in the system.



## ATTENTION

### Caution!

Risk of explosion if the battery is replaced by an incorrect type. Dispose of used batteries according to the instructions

## Grounding the MxNVR-IA8

Grounding and wire routing help limit the effects of noise caused by electromagnetic interference (EMI). Run the ground connection from the ground screw to the grounding surface prior to connecting devices.





## ATTENTION

This product should be mounted to a well-grounded mounting surface such as a metal panel.

## Wiring the Power Input

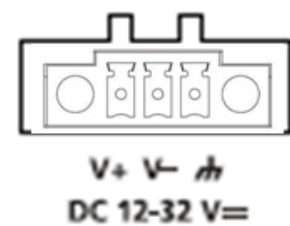
The MxNVR-IA8 has one power input, which is located on the 3-pin terminal block connector.



**STEP 1:** Insert the negative/positive DC wire into the V-/V+ terminals, and the ground cable to the 

**STEP 2:** To keep the DC wire from pulling loose, use a small flat-blade screwdriver to tighten the wire-clamp screws on the front of the terminal block connector.

**STEP 3:** Insert the plastic terminal block connector into the terminal block receptor, which is located on the MxNVR-IA8's front panel.



**ATTENTION**

The power supply used for this product is the Listed Power Unit, with LPS-marked, 12 to 32 VDC power output.



**ATTENTION**

Before connecting the VPort to the DC power inputs, make sure the DC power source voltage is stable.

## Wiring the DI/DO

The MxNVR-IA8 comes with a 6-ch digital input and a 2-ch digital output through a terminal block connector.

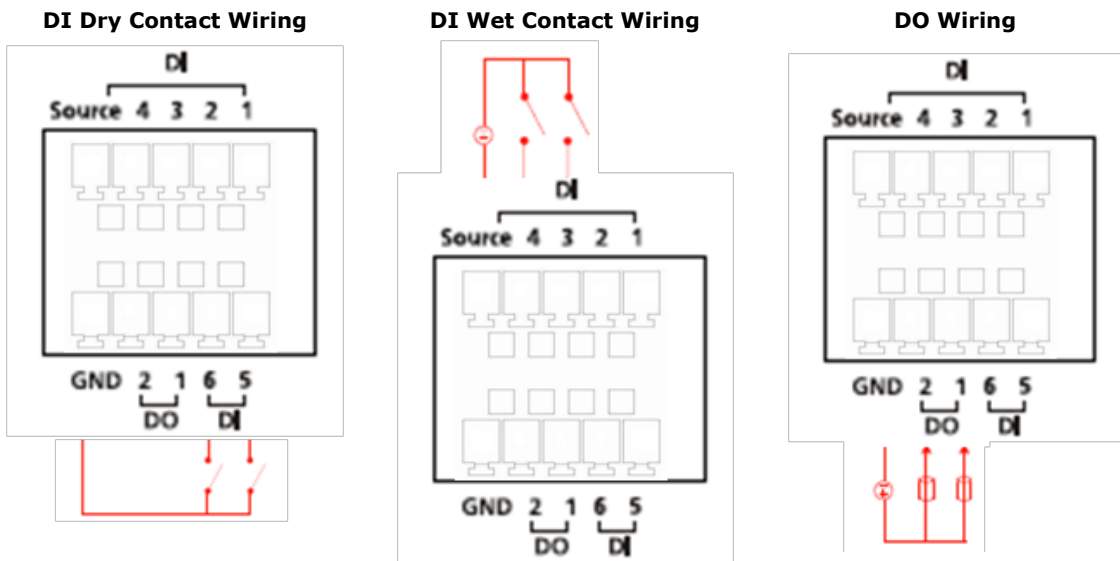

## 10/100/1000BaseT(X) Ethernet Port Connection

The 10/100/1000BaseT(X) port located on the MxNVR-IA8 rear panel is used to connect to Ethernet-enabled devices.

The following table shows the pinouts for both MDI (NIC-type) ports and MDI-X (HUB/Switch-type) ports. We also show cable wiring diagrams for straight-through and cross-over Ethernet cables.

**10/100BaseT(X) RJ45 Pinouts**

**(MDI) Port Pinouts**

Pin	Signal
1	Tx+
2	Tx-
3	Rx+
6	Rx-

**(MDI-X) Port Pinouts**

Pin	Signal
1	Rx+
2	Rx-
3	Tx+
6	Tx-

**8-pin RJ45**

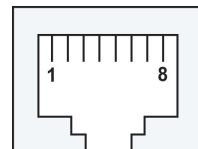

**1000BaseT RJ45 Pinouts**

Pin	MDI	MDI-X
1	BI_DA+	BI_DB+
2	BI_DA-	BI_DB-
3	BI_DB+	BI_DA+
4	BI_DC+	BI_DD+
5	BI_DC-	BI_DD-
6	BI_DB-	BI_DA-
7	BI_DD+	BI_DC+
8	BI_DD-	BI_DC-

**RJ45 (8-pin) to RJ45 (8-pin) Straight-Through Cable Wiring**

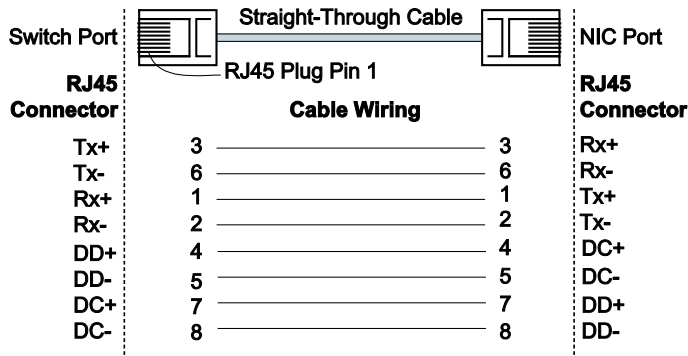

**RJ45 (8-pin) to RJ45 (8-pin) Cross-Over Cable Wiring**

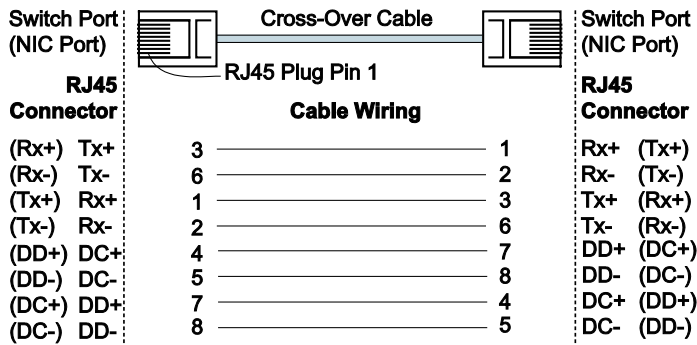



## Accessing the MxNVR-IA8 Web-based Manager

---

This chapter includes information about how to access the MxNVR-IA8 Industrial Network Video Recorder for the first time.

The following topics are covered in this chapter:

### □ Overview of the MxNVR-IA8 Web Homepage

- Recording LED Status
- System Information
- Video Source List
- Camera List
- System Configuration
- Remote Playback
- DO Control

# Overview of the MxNVR-IA8 Web Homepage

**NOTE** The MxNVR-IA8’s web homepage is best viewed at 1280 x 1024 screen resolution. We strongly recommend using IE 6.0 (Microsoft Internet Explorer) or above to avoid incompatibility with the ActiveX Plug-in.

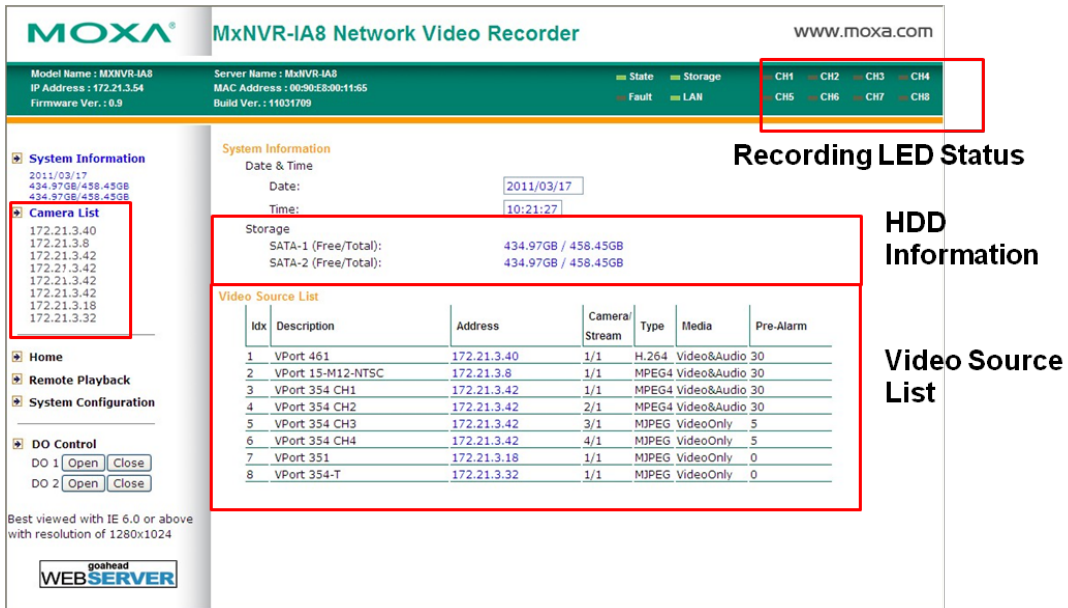

## Recording LED Status

This section shows the recording status of the video sources. The MxNVR-IA8 supports up to eight channels.

**NOTE** The LEDs shown on the MxNVR-IA8 web homepage are updated every 10 seconds.

## System Information

This section shows the date and time and the HDD information of the system.

## Video Source List

This section shows the information of the video sources that the MxNVR-IA8 is currently connected to. The information includes:

1. Idx: the video source channel index.
2. Description: the VPort’s model name and channel number of this video source.
3. Address: the IP address of this video source.
4. Camera Stream: most of the VPort products support multiple video streams. This information shows which video stream this video source records.
5. Type: the video compression standard this video source is recorded in.
6. Media: whether this video source is recorded with video only, audio only, or both video and audio.
7. Pre-alarm: the time period of the pre-alarm recorded videos.

## Camera List

This section lists the IP address of the video sources that are being connected.

## System Configuration

A button or text link on the left side of the system configuration window only appears on the Administrator’s main page. For detailed system configuration instructions, refer to Chapter 4, **System Configuration**.

## Remote Playback

To view the recorded videos, click on **Remote Playback**, and then a playback display screen will pop up to allow you to search and play back the recorded videos from a remote client PC.

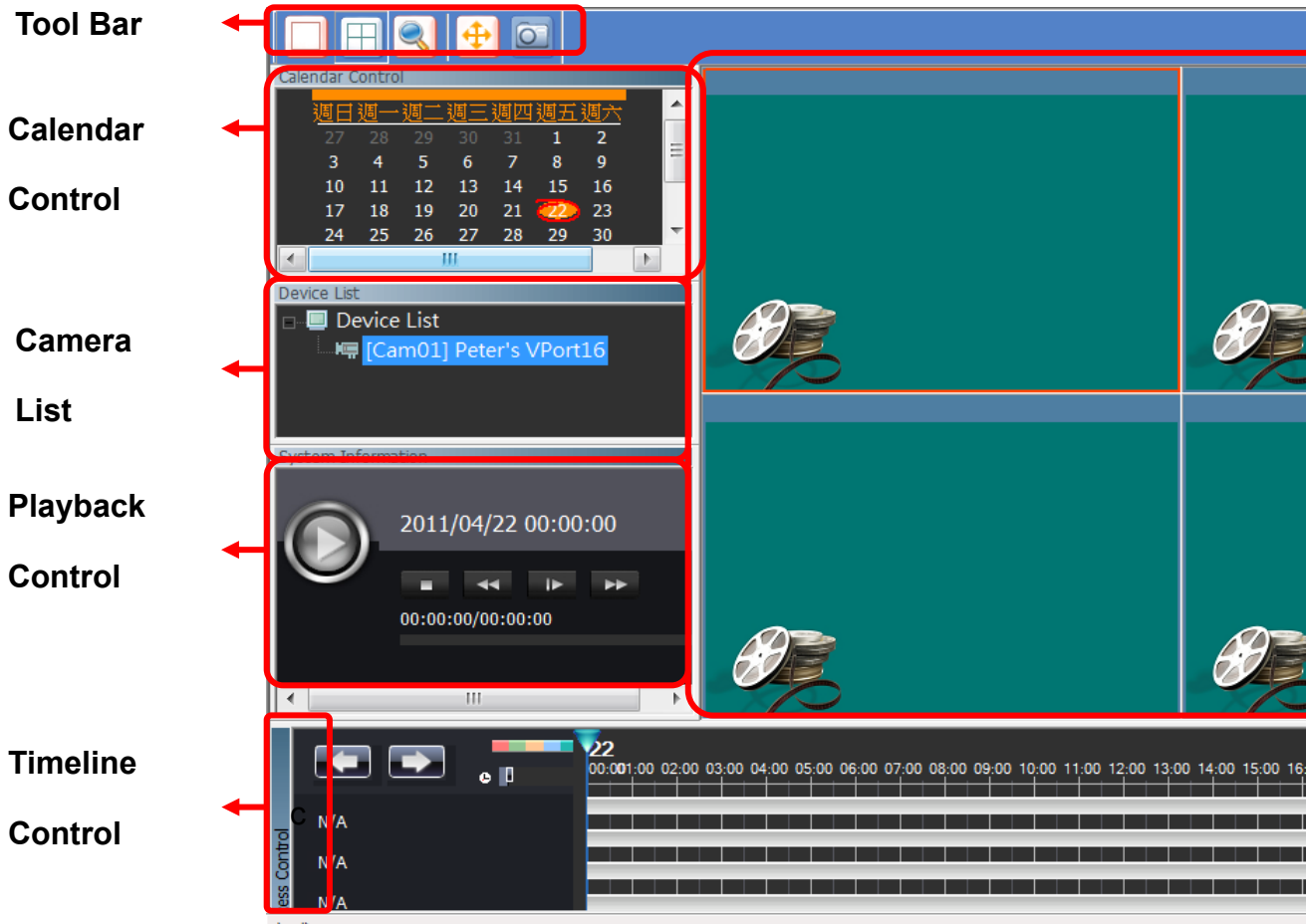

### Toolbar

Playback video display control	
Event Search	
Full Screen Display	
Take snapshot image	

## Search Recorded Videos

Click on the **Event Search** button to activate the **Event Search** pop-up window.

Device Name	Event Type	Start Time	End Time	Durati
[Cam03] VPort 451	Always Record	2011/05/26 09:0...	2011/05/26 09:0...	00:00
[Cam03] VPort 451	Always Record	2011/05/26 09:0...	2011/05/26 09:0...	00:01
[Cam03] VPort 451	Always Record	2011/05/25 17:0...	2011/05/26 08:5...	15:53
[Cam01] VPort 461	Always Record	2011/05/25 17:0...	2011/05/26 08:5...	15:53
[Cam05] VPort16	Always Record	2011/05/25 17:0...	2011/05/25 19:3...	02:28
[Cam03] VPort 451	Always Record	2011/05/25 17:0...	2011/05/25 17:0...	00:01
[Cam05] VPort16	Always Record	2011/05/25 17:0...	2011/05/25 17:0...	00:01
[Cam01] VPort 461	Always Record	2011/05/25 17:0...	2011/05/25 17:0...	00:01
[Cam03] VPort 451	Always Record	2011/05/25 16:5...	2011/05/25 16:5...	00:00
[Cam05] VPort16	Always Record	2011/05/25 16:5...	2011/05/25 16:5...	00:00
[Cam01] VPort 461	Always Record	2011/05/25 16:5...	2011/05/25 16:5...	00:00
[Cam03] VPort 451	Always Record	2011/05/25 16:3...	2011/05/25 16:5...	00:23
[Cam05] VPort16	Always Record	2011/05/25 16:3...	2011/05/25 16:5...	00:23
[Cam01] VPort 461	Always Record	2011/05/25 16:3...	2011/05/25 16:5...	00:23
[Cam03] VPort 451	Always Record	2011/05/25 16:3...	2011/05/25 16:3...	00:00
[Cam01] VPort 461	Always Record	2011/05/25 16:2...	2011/05/25 16:3...	00:05
[Cam05] VPort16	Always Record	2011/05/25 16:2...	2011/05/25 16:3...	00:05
[Cam05] VPort16	Always Record	2011/05/25 13:5...	2011/05/25 16:2...	02:29
[Cam01] VPort 461	Always Record	2011/05/25 13:5...	2011/05/25 16:2...	02:29
[Cam05] VPort16	Always Record	2011/05/25 13:2...	2011/05/25 13:3...	00:05
[Cam01] VPort 461	Always Record	2011/05/25 13:2...	2011/05/25 13:3...	00:05

Step 1: Set the **Start Date** and **Start Time**.

Step 2: Set the **End Date** and **End Time**.

Step 3: Select the **Channel** for searching the recorded videos from the specific camera.

Step 4: Select the **Event Type** for searching the recorded videos by the event type.

Step 5: Click the **Event Search** button. The search results will be listed in the right pane.

Step 6: Double-click any of the recorded videos from the search results. The selected video will be shown on the playback display screen

## Calendar Control

You can search and play back the recorded videos on specific dates in the "Timeline Control" area. The dates in bold type are the dates with recorded videos. A red frame around a date indicates the current date.

## Playback Control

This playback control is for playing back the recorded videos.



## Timeline Control

The display allows you to control video playback with a mouse.

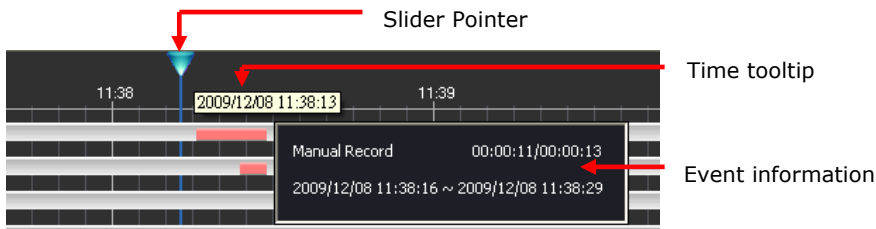
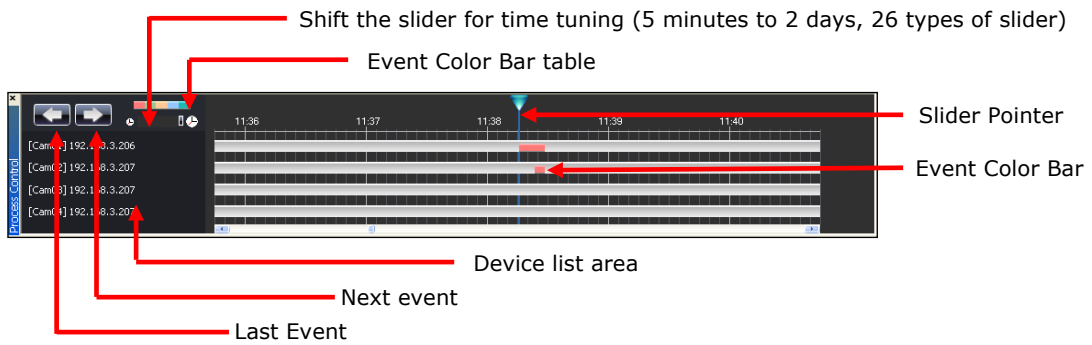

- Right-click the mouse on the event color bar to show the event information.
- Drag the "Slider Pointer" in the time line to show the time of this point.
- Scroll the mouse wheel to adjust the display ratio of the time line.

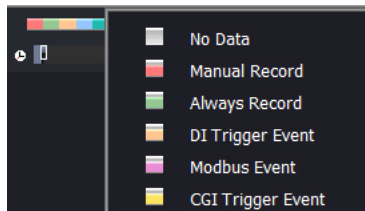

- Different event types are displayed in different colors in the time line.

## Playback Display Screen

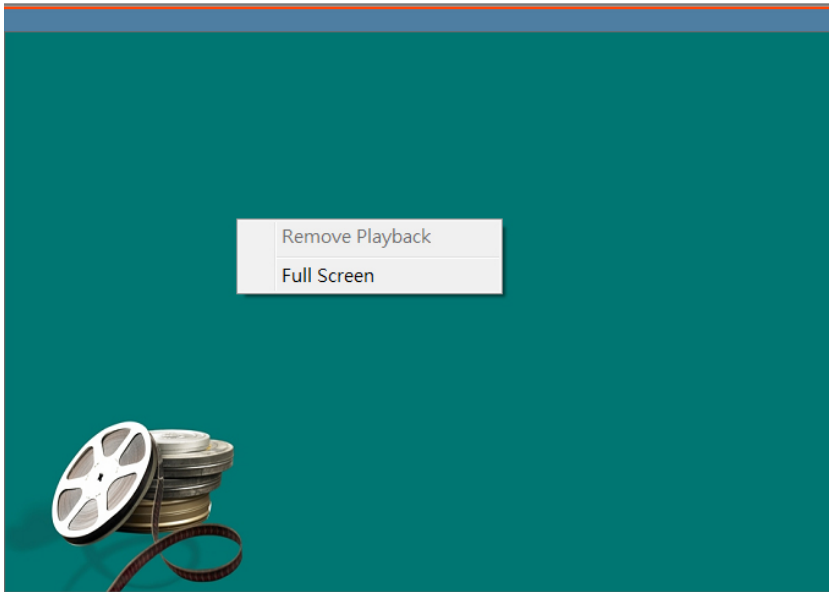

- Remove Playback: remove the camera/device from the playback display screen
- Full Screen: Change the playback display screen to full-screen mode

## DO Control

The MxNVR-IA8 has two digital outputs for external devices, such as alarms. The Administrator and privileged users can click on **Open** to short the **Normal Open** digital output pins, or click on **Close** to short the **Common** digital output pins.

# System Configuration

---

After installing the hardware, the next step is to configure the MxNVR-IA8's setting through the web console.

The following topics are covered in this chapter:

## □ System Configuration by Web Console

- System
- Network
- Video Source List
- Schedule
- Alarm

# System Configuration by Web Console

System configuration can be done remotely with Internet Explorer. To access the server, type the system configuration URL, <http://<IP address of Video Server>/setup/config.html>, to open the configuration main page.

There are six configuration categories: **System**, **Network**, **Video**, **Serial Port**, **Audio**, and **Alarm**. A description of each configuration item is shown in the following table:

Category	Item	Description and Contents	
System	General	Set Host Name, Date/Time	
	Accounts	Manage Administrator and User account privileges	
	Storage	Configure and manage all storage devices	
	Diagnosis	Self-diagnostic report with the status of the system, communication, power, and LEDs	
	System Log	System Log and operation information	
	System Parameter	System parameter information and Import and Export functions	
	Firmware Upgrade	Remote firmware upgrade	
	Factory Default	Restore the factory default settings	
	Reboot	Restart the system	
Network	General	The IP network settings of this VPort product	
	SMTP Server	Set up the Primary and Secondary SMTP servers and e-mail accounts	
	FTP Server	Set up the Primary and Secondary FTP servers	
	Accessible IP	Set up a list of IP addresses that are granted access	
	HTTP Event Server	Set up the HTTP Event Server to send the event alarm notification	
	Modbus/ TCP	Enable Modbus/TCP function	
	IEEE 802.1X	Configure IEEE 802.1X function	
Video Source	Video Source List	Edit and list video sources	
Schedule Record	Weekly Schedule	Edit and list the weekly schedule	
Alarm	System Alarm	Configure network connection broken alarms	
	Event Alarm	Basic	General event alarm settings
		Schedule	Set up the alarm schedule
		Digital Input	Configure the digital input alarm
		Video Loss	Configure the video loss alarm
		CGI Event	Set up the CGI event alarm
Sequential Snapshot	Set up the sequential snapshot operation		



This table can also be found on the **System Configuration → Overview** webpage.

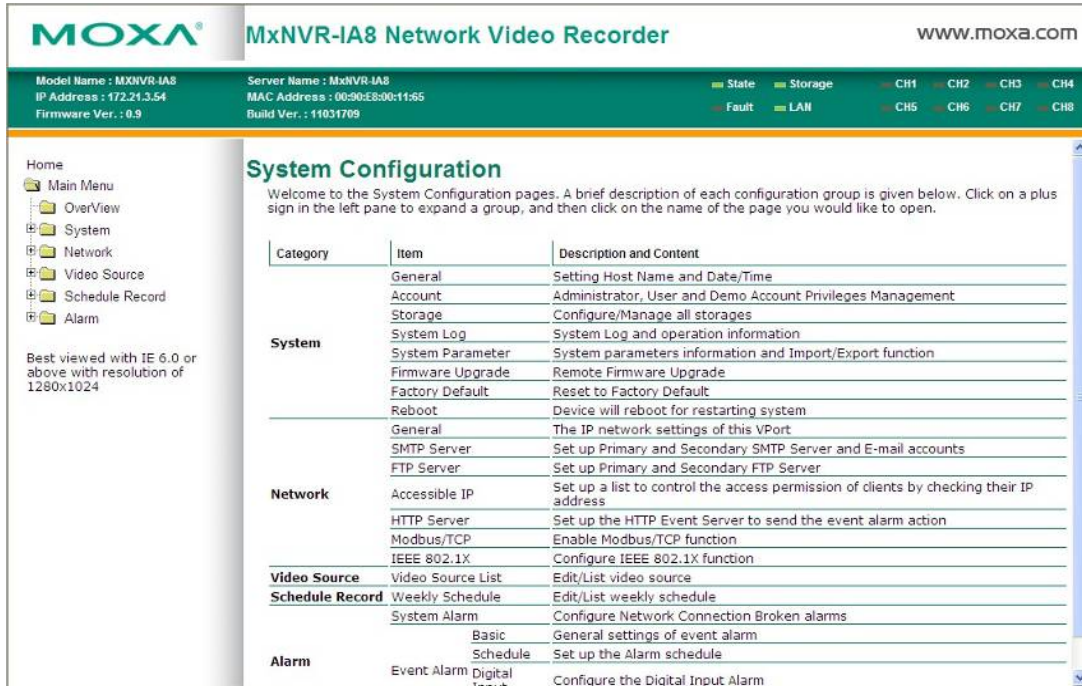

## System

### General Settings

On the **General Settings** page, the Administrator can set up the video **Server name** and the **Date and Time**, which are shown in the caption for the image.

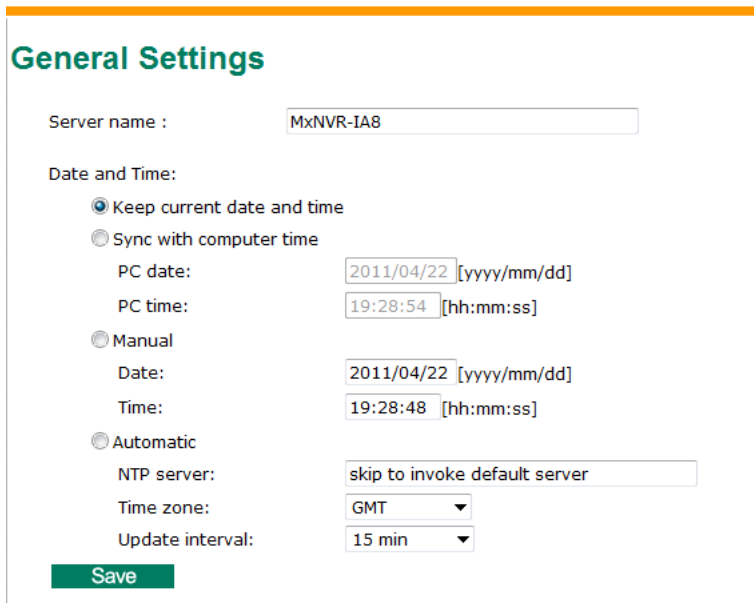

#### Server name

Setting	Description	Default
Max. 40 characters	Give a different name to each server to help identify the different servers. The name will appear on the web homepage.	MxNVR-IA8

**Date and Time**

Setting	Description	Default
Keep current date and time	Use the current date and time as the MxNVR's time setting.	Keep current date and time
Sync with computer time	Synchronize the MxNVR's date and time setting with the local computer time.	
Manual	Manually change the MxNVR's date and time setting.	
Automatic	Use the NTP server for changing the MxNVR's date and time setting in a given period.	

**NOTE** Select the **Automatic** option to force the MxNVR to synchronize automatically with timeservers over the Internet. However, synchronization may fail if the assigned NTP server cannot be reached, or when the MxNVR is connected to a local network. Leaving the NTP server blank will force the MxNVR to connect to the default timeservers. Enter either the Domain name or the IP address format of the timeserver if the DNS server is available.  
 Don't forget to set the Time zone for local settings. Refer to Appendix C: Time Zone Table.

## Account Privileges

Different account privileges are available for different purposes.

### Account Privileges

**Admin Password**

Admin Password:

Confirm Password:

Note: Admin's password must be blank or 8 to 15 characters. If leave admin password blank will disable user authentication.

**Save**

**User's Privileges**

No.	User Name	Password	Privileges
1	<input type="text"/>	<input type="password"/>	<input type="checkbox"/> Control RELAY1 <input type="checkbox"/> Control RELAY2 <input type="checkbox"/> Playback
2	<input type="text"/>	<input type="password"/>	<input type="checkbox"/> Control RELAY1 <input type="checkbox"/> Control RELAY2 <input type="checkbox"/> Playback
3	<input type="text"/>	<input type="password"/>	<input type="checkbox"/> Control RELAY1 <input type="checkbox"/> Control RELAY2 <input type="checkbox"/> Playback
4	<input type="text"/>	<input type="password"/>	<input type="checkbox"/> Control RELAY1 <input type="checkbox"/> Control RELAY2 <input type="checkbox"/> Playback
5	<input type="text"/>	<input type="password"/>	<input type="checkbox"/> Control RELAY1 <input type="checkbox"/> Control RELAY2 <input type="checkbox"/> Playback
6	<input type="text"/>	<input type="password"/>	<input type="checkbox"/> Control RELAY1 <input type="checkbox"/> Control RELAY2 <input type="checkbox"/> Playback
7	<input type="text"/>	<input type="password"/>	<input type="checkbox"/> Control RELAY1 <input type="checkbox"/> Control RELAY2 <input type="checkbox"/> Playback
8	<input type="text"/>	<input type="password"/>	<input type="checkbox"/> Control RELAY1 <input type="checkbox"/> Control RELAY2 <input type="checkbox"/> Playback
9	<input type="text"/>	<input type="password"/>	<input type="checkbox"/> Control RELAY1 <input type="checkbox"/> Control RELAY2 <input type="checkbox"/> Playback
10	<input type="text"/>	<input type="password"/>	<input type="checkbox"/> Control RELAY1 <input type="checkbox"/> Control RELAY2 <input type="checkbox"/> Playback

**Save**

**Admin password**

Setting	Description	Default
Admin Password (max. 14 characters)	The Administrator can type the new password in this box.	Default admin password is "admin"
Confirm Password (max. 14 characters)	If a new password is typed in the Admin Password box, you will need to retype the password in the Confirm Password box before updating the new password.	

**NOTE** The default account name for the Administrator is admin; which is not allowed to be changed.

### User's Privileges

The VPort products provide ten user accounts for accessing the VPort. The administrator can set up user's privileges in this section. Each user can be given independent access right to the external I/Os and camera control.

Setting	Description	Default
User Name	Type a specific user name for user authentication.	None
Password	Type a specific password for user authentication.	
Privilege	Check the function boxes to assign privileges for users in Control Relay1 (DO1), and Control Relay2 (DO2) and Playback.	

**NOTE** With the Playback privilege, you can remotely play back the recorded videos from the MxNVR-IA8.

## Storage Management

The MxNVR-IA8 supports two SATA hard disks for video storage. The hard disk's information, which includes the model name, current temperature, capacity, health, availability, and enabled/disabled status, will be shown on this page. The Administrator can also remotely enable, disable, or format the hard disks on this page.

The screenshot shows the 'Storage Management' page with a 'Storage list' table. The table has columns for Disk, Model, Temp., Capacity, Health, Available, and Enable. There are two rows of data for Toshiba MK5065GSX disks. Below the table are buttons for 'Enable', 'Disable', 'Refresh', and 'Format'.

Disk	Model	Temp.	Capacity	Health	Available	Enable
<input type="checkbox"/> 1	TOSHIBA MK5065GSX	33°C	500,107,862,016 bytes	Normal	Yes	Yes
<input type="checkbox"/> 2	TOSHIBA MK5065GSX	34°C	500,107,862,016 bytes	Normal	Yes	Yes

Buttons: Enable, Disable, Refresh, Format

**NOTE** This hard disk information is mainly from the smart commands, a function that is supported by the hard disk. . If the hard disk does not support smart commands, some of the information would be left in blank.

**NOTE** The MxNVR-IA8 supports EXT3 as the hard disk format. For this reason, we strongly recommend formatting the newly installed hard disk before using it to store the recorded videos, no matter whether it has been formatted or not.

**NOTE** There are a lot of hard disk suppliers on the market. We recommend using the main supplier's products with the MxNVR-IA8. The MxNVR-IA8 was tested in our lab using a 2.5" Toshiba MK5065GSX (500GB) HDD, and the MxNVR-IA8-T was tested in our lab with an Innodisk SATA 10000 (128 GB) SSD.

**NOTE** If the hard disk fails in certain situations, such as being unable to read/write, broken, etc, the system will send a message via the e-mail to the Administrator. For this reason, you need to configure at least one SMTP server with the recipient's e-mail address.

## System Diagnosis

The MxNVR products support a self-diagnosis function to allow the Administrator to get a quick view of the system and the connection status. The Administrator can save this diagnosis information in a file (diagnosis.log) by clicking the **Export to a File** button, or send the file via the e-mail by clicking the **Send a Report via Email** button.

### System Diagnosis

#### System Status

##### System

Serve Name: MxNVR-IA8	Firmware Version: 1.1 Build 11041512
Date/Time: Keep current data and time	User Accounts: 0
Storage Setting	
Disk 1: Available/Enable	Disk 2: Available/Enable
FTP Server Daemon	
FTP Daemon: Disable	Server Port: 21

##### Network

Access Method: Get IP address automatically	IP Address: 172.21.3.41
Gateway: 172.21.3.254	Subnet Mask: 255.255.255.0
Primary DNS: 192.168.50.33	Secondary DNS: 192.168.1.97
HTTP Port: 80	
1st SMTP Server: Disable	2nd SMTP Server: Disable
1st Recipient Email Address:	2nd Recipient Email Address:
1st Sender Email Address:	2nd Sender Email Address:
Accessible IP List: Disable	UPnP: Enable
DDNS: Disable	Modbus/TCP: Enable
IEEE 802.1X: Disable	

#### Connect Status

Ethernet Port: Connected	
Channel 1: Recording	Channel 2: Stop
Channel 3: Stop	Channel 4: Stop
Channel 5: Stop	Channel 6: Stop
Channel 7: Stop	Channel 8: Stop
DI1: High	DI2: High
DI3: High	DI4: High
DI5: High	DI6: High
DO1: Close	DO2: Close

[Export to a File](#)
[Send a Report via E-mail](#)

## System Log History

The system log contains useful information, including current system configuration and activity history with timestamps for tracking. The administrator can save this information in a file (system.log) by clicking the **Export to a File** button, or send the file by e-mail by clicking the **Send a Report via Email** button. In addition, the log can also be sent to a **Log Server** for backup. The Administrator can set up the Syslog Server 1 and Syslog Server 2 under the system log list.

### System Log History

Index	Time	Type	Description
0001	Thu Mar 17 10:40:09 2011	EVENT	Start Always Rec record on channel 1
0002	Thu Mar 17 10:40:10 2011	EVENT	Start Always Rec record on channel 2
0003	Thu Mar 17 10:40:10 2011	EVENT	Start Always Rec record on channel 3
0004	Thu Mar 17 10:40:11 2011	EVENT	Start Always Rec record on channel 4
0005	Thu Mar 17 10:40:11 2011	EVENT	Start Always Rec record on channel 5
0006	Thu Mar 17 10:40:12 2011	EVENT	Start Always Rec record on channel 6
0007	Thu Mar 17 10:40:12 2011	EVENT	Start Always Rec record on channel 7
0008	Thu Mar 17 10:40:13 2011	EVENT	Start Always Rec record on channel 8
0009	Thu Mar 17 10:45:00 2011	EVENT	Stop Always Rec record on channel 1
0010	Thu Mar 17 10:45:01 2011	EVENT	Stop Always Rec record on channel 2
0011	Thu Mar 17 10:45:01 2011	EVENT	Stop Always Rec record on channel 3
0012	Thu Mar 17 10:45:02 2011	EVENT	Stop Always Rec record on channel 4

Send to system log Server
 

Syslog Server 1:   
 Port Destination:   
 Syslog Server 2:   
 Port Destination:

### Send to system log server

Setting	Description	Default
Send to system log server	Enable sending the system log to the log sever.	Disable
Syslog Sever 1	The address of the first system log server.	Blank
Port Destination	The port number of the first system log server.	514
Syslog Sever 2	The address of the second system log server.	Blank
Port Destination	The port number of the second system log server.	514

**NOTE** A maximum of 500 entries is displayed in the log. Data that are prior to the latest 500 entries are still in the VPort's database; the Administrator can export them at any time.

## System Parameters

The **System Parameters** page allows you to view all the system parameters, which are listed by category. The Administrator can also save this information in a file (sys\_config.ini) by clicking the **Export to a File** button, or import a file by clicking the **Browse** button to search for a sys\_config.ini file and then to update the system configuration quickly by clicking the **Import a System Parameter File** button.

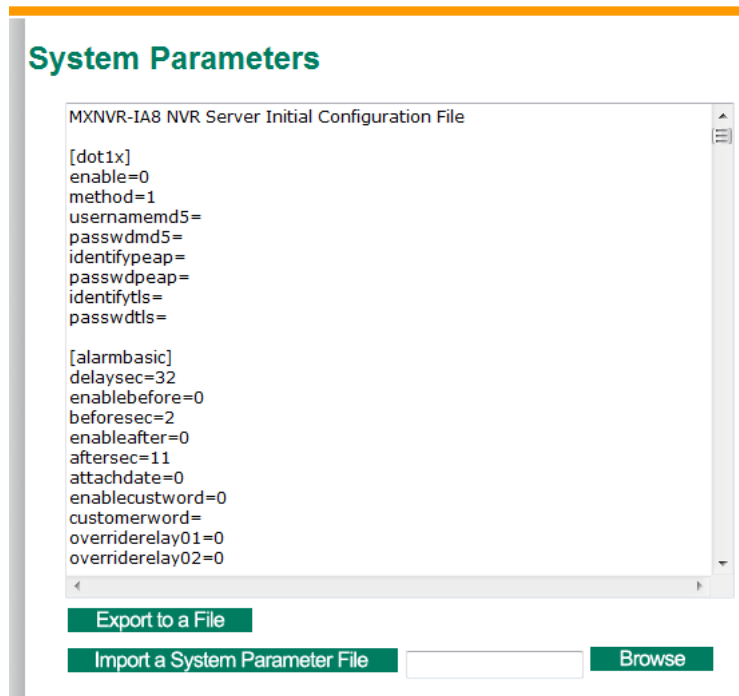

**NOTE** The system parameter import/export functions allow the Administrator to back up and restore system configurations. The administrator can export this sys\_config.ini file (in a special binary format) for backup, and import the sys\_config.ini file to restore the system configurations of the MxNVR. System configuration changes will take effect after the MxNVR is rebooted.

## Firmware Upgrade

### Firmware Upgrade

Take the following steps to upgrade the firmware:

**Step 1:** Click on the **Browse** button to select the firmware file.

**NOTE** For the MxNVR-IA8, the firmware file extension should be .rom.

**Step 2:** Click on the **Upgrade** button to upload the firmware to the MxNVR.

**Step 3:** The system will start to run the firmware upgrade process.

**Step 4:** Once **Firmware Update Success.....Reboot....** is displayed, please wait for few seconds for the VPort to reboot. The rebooting process is finished once the **STAT** LED is lit continuously in green.

**NOTE** Upgrading the firmware will not change the original settings.

## Reset to Factory Default

From the **Reset to Factory Default** page, click on **OK** (as shown in the following figure) to reset the MxNVR to its factory default settings.

### Reset to Factory Default

Reset to Factory Default will restart the system and delete all the changes that have been made to the configuration. Are you sure you want to reset to factory default?

OK

**NOTE** All parameters will be reset to factory defaults when you use the Factory Default function. For this reason, if you want to keep a digital copy of the current configuration, remember to export the sys\_config.ini file before using the Factory Default function.

## Reboot

From the **Device Reboot** page, click on **OK** (as shown in the following figure) to restart the MxNVR's system.

### Device Reboot

This device will reboot for restarting system. Are you sure you want to reboot?

OK

## Network

### General Network Settings

The **General Network Settings** page includes some basic but important network configurations that enable the MxNVR to be connected to a TCP/IP network.

The screenshot shows the 'General Network Settings' page. It features two sections: 'Access Method' and 'General Settings'. In the 'Access Method' section, there are two radio buttons: 'Get IP address automatically' (which is selected) and 'Use fixed IP address'. The 'General Settings' section contains five input fields for network parameters: IP address (172.21.3.41), Subnet mask (255.255.255.0), Gateway (172.21.3.254), Primary DNS (192.168.50.33), and Secondary DNS (192.168.1.97). A green 'Save' button is located at the bottom left of the form.

General Network Settings	
<b>Access Method</b>	
<input checked="" type="radio"/>	Get IP address automatically
<input type="radio"/>	Use fixed IP address
<b>General Settings</b>	
IP address	172.21.3.41
Subnet mask	255.255.255.0
Gateway	172.21.3.254
Primary DNS	192.168.50.33
Secondary DNS	192.168.1.97
<b>Save</b>	

**Access Method**

The MxNVR products support the DHCP protocol, which means that the MxNVR can get its IP address from a DHCP server automatically when it is connected to a TCP/IP network. The administrator should determine if it is more appropriate to use DHCP, or to use a fixed IP.

Setting	Description	Default
Get IP address automatically	Get the IP address automatically from the DHCP server.	Get IP address automatically
Use fixed IP address	Use the IP address assigned by the Administrator.	

**NOTE** We strongly recommend assigning a fixed IP address to the MxNVR, since all of the functions and applications provided by the MxNVR are active when the MxNVR is connected to the network. Use DHCP to determine if the MxNVR's IP address may change when the network environment changes, or the IP address is occupied by other clients.

**General Settings**

Setting	Description	Default
IP address	Variable IP assigned automatically by the DHCP server, or fixed IP assigned by the Administrator.	192.168.127.100
Subnet mask	Variable subnet mask assigned automatically by the DHCP server, or a fixed subnet mask assigned by the Administrator.	255.255.255.0
Gateway	Assigned automatically by the DHCP server, or assigned by the Administrator.	Blank
Primary DNS	Enter the IP address of the DNS Server used by your network. Then, you can input the VPort's url (e.g., www.VPort.company.com) in your browser's address field, instead of entering the IP address.	Obtained automatically from the DHCP server, or left blank in non-DHCP environments.
Secondary DNS	Enter the IP address of the DNS Server used by your network. The VPort will try to locate the secondary DNS Server if the primary DNS Server fails to connect.	Obtained automatically from the DHCP server, or left blank in non-DHCP environments.



## SMTP Server and Email Account Settings

The MxNVR not only plays the role of a server, but can also connect to external servers to send alarm messages. If the Administrator has set up system information notification or alarm notification, the MxNVR will send messages once the configured conditions occur.

### SMTP Server and Email Account Settings

**1st SMTP Server and Sender Email**

1st SMTP (mail) server

1st SMTP account name

1st SMTP password

1st Sender's email address

**2nd SMTP Server and Sender Email**

2nd SMTP (mail) server

2nd SMTP account name

2nd SMTP password

2nd Sender's email address

*Note: There are 2 SMTP servers and sender Email accounts for sending system information and alarms. At least one of them should be set up correctly to enable the email transmitting system.*

**Recipient's Email**

1st Recipient's Email Address:

2nd Recipient's Email Address:

*Note: There are 2 recipient email accounts for receiving system information and alarms.*

Save

### 1st SMTP Server and Sender Email

Setting	Description	Default
1st SMTP (mail) server	SMTP Server's IP address or URL address.	None
1st SMTP account name	For security reasons, most SMTP servers require the account name and password to be authenticated.	None
1st SMTP password		None
1st Sender's email address	For security reasons, SMTP servers require the exact sender's e-mail address.	None

**NOTE** If the sender's email address is not set, a warning message will pop up and the e-mail system will fail to operate.

**NOTE** The 2nd SMTP Server and the sender's e-mail are for backup use, when the 1st SMTP Server and the sender's e-mail fail to be connected.

Two recipient's e-mail accounts are available for receiving e-mails sent by the MxNVR. For redundancy, both addresses receive the sent messages and alarm snapshots simultaneously.

Setting	Description	Default
1st Recipient's E-mail Address	E-mail address of the 1st recipient.	None
2nd Recipient's E-mail Address	E-mail address of the 2nd recipient.	None

## Dynamic DNS

**DDNS (Dynamic Domain Name System)** is a combination of DHCP, DNS, and client registration. DDNS allows the Administrator to alias the MxNVR's dynamic IP address to a static host name in any of the domains provided by the DDNS service providers listed on the MxNVR's Network/DDNS configuration page. DDNS makes it easier to access the MxNVR from various locations on the Internet.

### Dynamic DNS

The Dynamic DNS function allows your VPort to get a domain name linked to a changeable IP address w IP address if you want to remote access this VPort from Internet.

Enable DDNS

Provider

Host name

Username/E-mail

Password/Key

*Note: If you don't have a DDNS account, please follow the application procedure on the website listed above.*

Setting	Description	Default
Enable DDNS	Enable or disable DDNS function.	Disable
Provider	Select the DDNS service providers, including DynDNS.org (Dynamic), DynDNS.org (Custom), TZO.com, and dhs.org.	None
Host Name	The Host Name you use to link to the MxNVR.	None
Username/ E-mail	The Username/E-mail and Password/Key you use to enable the service from the DDNS service provider (based on the rules of DDNS websites).	None
Password/ Key		None

**NOTE** Dynamic DNS is a very useful tool for accessing the MxNVR over the Internet, especially for xDSL connections with a non-fixed IP address (DHCP). You can simplify connection to the MxNVR with a non-fixed IP address by using the unique host name in the URL.

**NOTE** Different DDNS service providers have different application rules. Some applications are free of charge, but most require application fees.

## Universal PnP

**UPnP (Universal Plug & Play)** is a networking architecture that provides compatibility among the networking equipment, software, and peripherals from over 400 vendors that are part of the Universal Plug and Play Forum. These UPnP devices are also listed in the network devices table in the operating system (such as Windows XP). You can link to the MxNVR directly by clicking on the MxNVR listed in the network devices table.

### Universal PnP

UPnP (Universal Plug & Play) is a function that provides compatibility among networking equipment, software and peripherals. By enabling this function, you can find this VPort directly from the operating system's network device list.

Enable UPnP

*Note: Please make sure your OS or software supports UPnP first if you want to enable VPort's UPnP function.*

Setting	Description	Default
Enable UPnP	Enable or disable the UPnP function.	Enable

## Accessible IP List

The MxNVR uses an IP address-based filtering method to control access to the MxNVR.

### Accessible IP List

Enable accessible IP list ("Disable" will allow all IPs to connect)

Index	IP	NetMask
1	<input type="text"/>	<input type="text"/>
2	<input type="text"/>	<input type="text"/>
3	<input type="text"/>	<input type="text"/>
4	<input type="text"/>	<input type="text"/>
5	<input type="text"/>	<input type="text"/>
6	<input type="text"/>	<input type="text"/>
7	<input type="text"/>	<input type="text"/>
8	<input type="text"/>	<input type="text"/>
9	<input type="text"/>	<input type="text"/>
10	<input type="text"/>	<input type="text"/>

**Save**

Accessible IP Settings allow you to add or remove "Legal" remote host IP addresses to prevent unauthorized access. Access to the VPort is controlled by the IP address. That is, if a host's IP address is in the accessible IP table, then the host will be allowed access to the MxNVR. The Administrator can allow one of the following cases by setting this parameter:

Only one host with a specific IP address can access the MxNVR. Enter "IP address/255.255.255.255" (e.g., 192.168.1.1/255.255.255.255)

Hosts on a specific subnet can access the MxNVR. Enter "IP address/255.255.255.0" (e.g., "192.168.1.0/255.255.255.0")

Any host can access the MxNVR. Disable this function.

Refer to the following table for more configuration examples.

Allowable Hosts	Input Formats
Any host	Disable
192.168.1.120	192.168.1.120/255.255.255.255
192.168.1.1 to 192.168.1.254	192.168.1.0/255.255.255.0
192.168.0.1 to 192.168.255.254	192.168.0.0/255.255.0.0
192.168.1.1 to 192.168.1.126	192.168.1.0/255.255.255.128
192.168.1.129 to 192.168.1.254	192.168.1.128/255.255.255.128

## HTTP Event Server

The MxNVR allows you to design a customized alarm system by creating customized alarm actions and messages to be sent to the HTTP Event Servers.

### HTTP Event Servers

VPort can send the customized alarm actions and messages to the HTTP Event Server capability for the users designing the customized alarm system.

**Hostname**

**Server 1**

User name:

Password:

**Server 2**

User name:

Password:

**Server 3**

User name:

Password:

**Server 4**

User name:

Password:

**Save**

Setting	Description	Factory Default
Host Name	User-defined name for identification	Blank
Server 1, 2, 3, 4	The server's URL address with complete CGI commands Ex. http:// http event server:Port/CGI_Name	Blank
User name	The account name for accessing the HTTP server	Blank
Password	The password for accessing the HTTP server	Blank

Once the Http Alarm is triggered, the MxNVR will send the following HTTP commands to the HTTP event servers.

```
GET CGI_Name?address=<Hostname or IP Address>&[Custom CGI] HTTP/1.0\r\n
```

```
User-Agent: MxNVR-IA8 V1.1\r\n
```

```
[Authorization: Basic <Base64(username:password)>\r\n]
```

```
Host: <HTTP Server IP Address>\r\n
```

```
Connection: Keep-Alive\r\n
```

```
\r\n
```

## Modbus/TCP

Modbus is a serial communications protocol, which is often used to connect a supervisory computer with a remote terminal unit (RTU) in supervisory control and data acquisition (SCADA) systems. To transmit Modbus over a TCP/IP network, a standard Modbus/TCP protocol is provided. With the support of the Modbus/TCP protocol, the SCADA/HMI system can directly communicate with the MxNVR to acquire its operational status.

### ModBus/TCP

Modbus is a serial communications protocol for the industrial devices' communications with the SCADA/HMI system. With the Modbus/TCP protocol, the SCADA/ HMI system can directly communicate with VPort for acquiring the working status.

Enable ModBus/TCP

Save

Setting	Description	Factory Default
Enable Modbus/TCP	Enable the Modbus/TCP protocol	Enable

**NOTE** For Modbus address table, refer to the appendix B: Modbus Address Table

## FTP Server Settings (for recorded video download)

The MxNVR-IA8 can be a FTP server for remote clients to download the recorded videos.

Setting	Description	Default
Enable FTP Server Daemon	Enable the MxNVR's FTP server Daemon for remotely downloading the recorded video files	Disable
Port	FTP port number	21

The Administrator can use FTP download tool to download the recorded video files from the MxNVR-IA8. Below is the file structure of recorded video files. Two hard disks are listed in two folders: SATA0 and SATA1, and the recorded video files are stored in the subfolders categorized by the video source: Ch001 to Ch008. Under each video source's subfolder, the recorded video files are further categorized by date, which makes it more convenient for the Administrator to find a specific recorded video files.

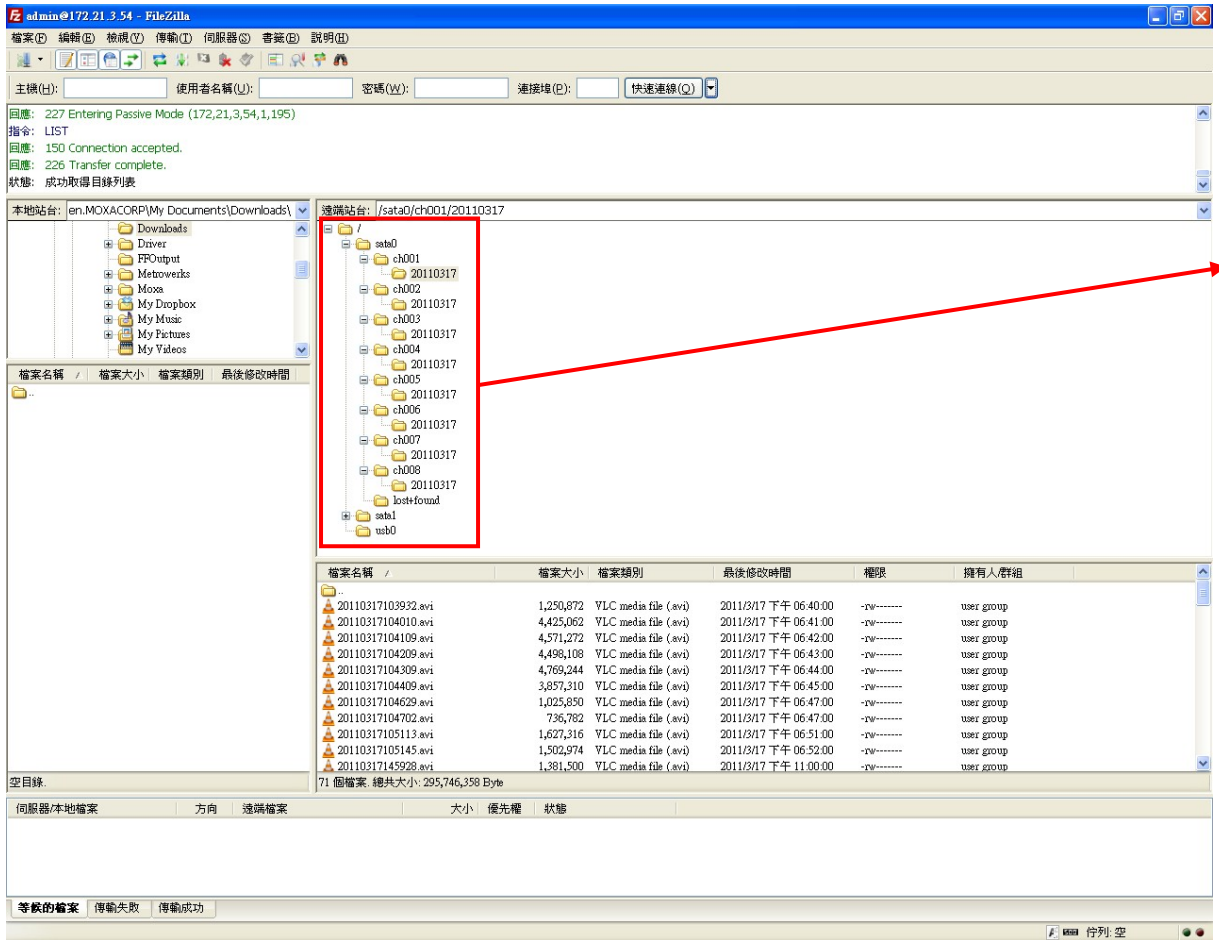

**NOTE** Only the Administrator can download the recorded video files via FTP. For this reason, the Administrator’s user name “admin” and password is the default account name and password to access the MxNVR-IA8’s FTP server.

**NOTE** The recorded video files are in AVI format, which can be played by most of the media players supporting FFDSHOW codec.

### IEEE 802.1X

The MxNVR-IA8 supports advanced IEEE 802.1X network authentication function. There are three types of 802.1X supported: EAP-MD5, EAP-PEAP/MSCHAPv2 and EAP-TLS. The Administrator should choose the appropriate type base on the network system situation.

#### EAP-MD5



### EAP-PEAP/MSCHAPv2

**IEEE 802.1X**

Enable 802.1X

EAP Method: EAP-PEAP/MSCHAPv2

Identify:

Password:

CA Certificate:  Browse Upgrade

CA Certificate Status: no file

Save

### EAP-TLS

**IEEE 802.1X**

Enable 802.1X

EAP Method: EAP-TLS

Identify:

CA Certificate:  Browse Upgrade

CA Certificate Status: no file

Client Certificate:  Browse Upgrade

Client Certificate Status: no file

Client Private Key:  Browse Upgrade

Client Private Key Status: no file

Client Private Key Password:

Save

**NOTE** Please consult an expert or your network administrators for the 802.1X configurations if you come across any trouble with it.

## Video Source List

**Video Source List**

Add to List Search Remove Select Modify

	Idx	Description	Address	Camera/Stream	Type	Media	Pre-Alarm
<input type="checkbox"/>	1	VPort 461	172.21.3.40	1/1	H.264	Video&Audio	30
<input type="checkbox"/>	2	VPort 15-M12-NTSC	172.21.3.8	1/1	MPEG4	Video&Audio	30
<input type="checkbox"/>	3	VPort 354 CH1	172.21.3.42	1/1	MPEG4	Video&Audio	30
<input type="checkbox"/>	4	VPort 354 CH2	172.21.3.42	2/1	MPEG4	Video&Audio	30
<input type="checkbox"/>	5	VPort 354 CH3	172.21.3.42	3/1	MJPEG	VideoOnly	5
<input type="checkbox"/>	6	VPort 354 CH4	172.21.3.42	4/1	MJPEG	VideoOnly	5
<input type="checkbox"/>	7	VPort 351	172.21.3.18	1/1	MJPEG	VideoOnly	0
<input type="checkbox"/>	8	VPort 354-T	172.21.3.32	1/1	MJPEG	VideoOnly	0

### Adding a Video Source

The MxNVR-IA8 supports up to eight video sources for VPort recording. There are two methods of adding the video sources.

**Using the Automatic Search to Add a Video Source**

**Step 1:** Click on the **Search** button to search the VPort in the LAN environment. A webpage will pop up to show the search status. After the status shows OK, the available VPort devices will be listed.

Search Status : Search Ok

Add to List

Select	Index	Source Address	Model
<input type="checkbox"/>	1	172.21.3.42	VPort 354
<input type="checkbox"/>	2	172.21.3.32	VPort 354-T
<input type="checkbox"/>	3	172.21.3.45	VPort 461
<input type="checkbox"/>	4	172.21.3.8	VPort 15-M12-NTSC
<input type="checkbox"/>	5	172.21.3.40	VPort 461
<input type="checkbox"/>	6	172.21.3.18	VPort 351

**Step 2:** Check the **Select** box of the VPort product you want to add, and click on the **Add to List** button to add the selected VPort to the video source list.

### Using the Manual Configuration to Add a Video Source

Click on the **Add to list** button to add the video source manually, and a window will pop up. Entering the related information, including Idx (video source index), Address (IP address), Model (VPort's model name), Description (if necessary), Camera Idx (camera channel number), Stream Idx (stream number), HTTP port, Password (the admin's password), Video Type (compression standard), media (video& audio, video only, audio only) and Pre-alarm Time (the time period of pre-alarm video record) , of this video source, and then click on **Add to list** to add this video source to the video source list

http://172.21.3.41/video\_source\_add.asp - Windows Internet Explorer

http://172.21.3.41/video\_source\_add.asp

### Add Video Source

Idx :

Address :

Model :

Description :

Camera Idx :

Stream Idx :

HTTP Port :

Password :

Video Type :  H.264     MJPEG     MPEG4

Media :  Video & Audio     Video Only     Audio Only

Pre-Alarm Time :  (0 or 5-30 sec.)

Add to List

## Removing a Video Source

To remove a video source from the video source list, the Administrator needs to select the video source by checking the Select box of this video source, and click on **Remove Select** button to remove it.

## Modifying a Video Source

To modify a video source,

**Step 1:** Select the video source by checking its Select box.

**Step 2:** Click on **Modify** button, then this video source's configuration page will pop up.



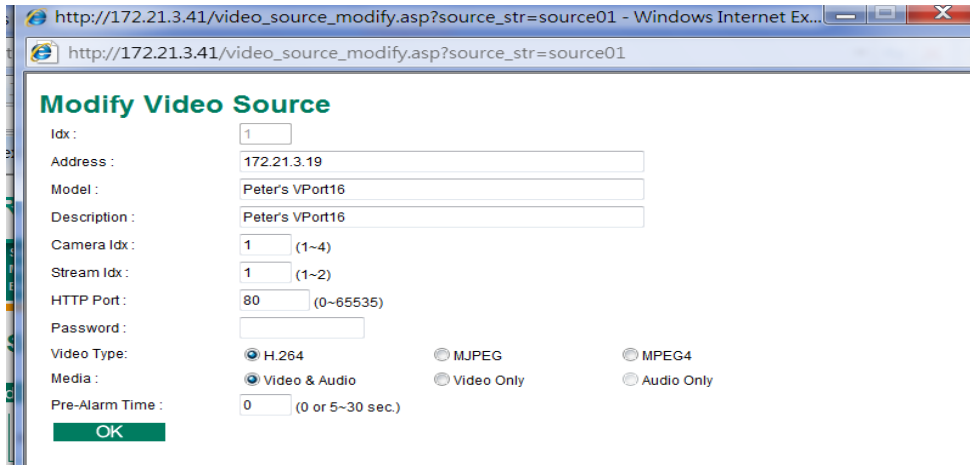

**Step 3:** After modifying the configuration, click on **OK** to update the settings to the video source list.

## Schedule

The MxNVR-IA8 supports weekly schedule settings. You can apply the schedule settings on all the video sources, or apply different schedule settings on each video source.

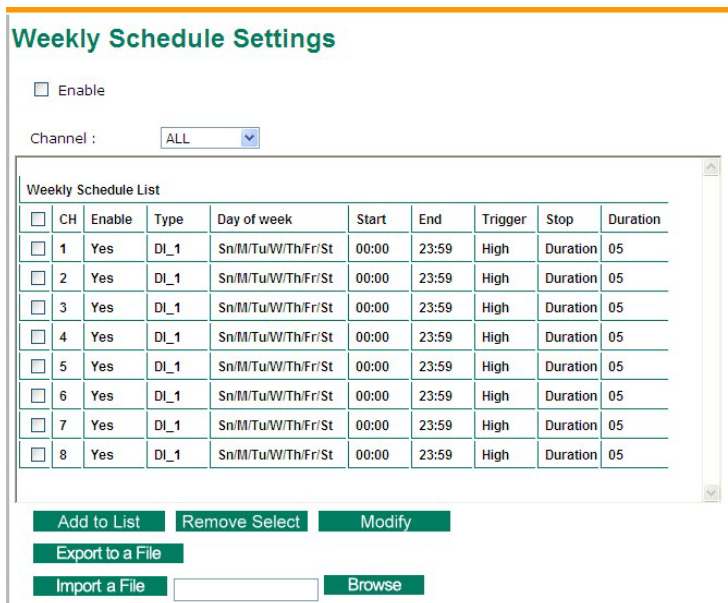

## Adding a schedule

**Step 1:** Choose the video source from the Channel menu.

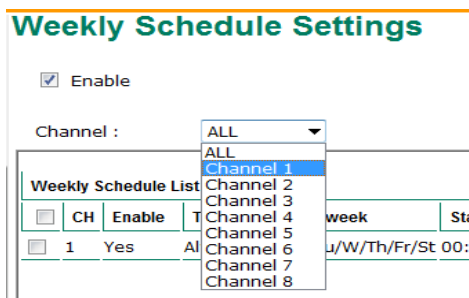

**Step 2:** Click on **Add to List** button to pop up the configuration page. Configure the related information in this page, and click on **OK** to add this schedule to the schedule list.

### Add Weekly Record Schedule Setting

**Weekly Schedule**

Enable

Channel :  1  2  3  4  5  6  7  8  All

Day :  SUN  MON  TUE  WED  THU  FRI  SAT  All

Start Time :  [hh:mm]

End Time :  [hh:mm]

Record Type :  ▼

**Event Condition**

Trigger :  ▼

Stop :  ▼

Duration :  [second]

**NOTE** The Administrator can configure the Record type on this webpage. Except for the Always Record option, the other record types are based on the events. For this reason, the configurations of the event condition being listed below the weekly schedule are required.

Record Type :  ▼

**Event Condition**

Trigger :

Stop :

Duration :

Always Record

Always Record

Record by DI 1 Event

Record by DI 2 Event

Record by DI 3 Event

Record by DI 4 Event

Record by DI 5 Event

Record by DI 6 Event

Record by CGI Event

Record by Modbus/TCP Event

**Step 3:** After modifying the schedule configurations, click on **OK** to update it to the video source list.

## Removing a schedule

To remove a schedule from the schedule list, the Administrator needs to select the schedule by checking the Select box of this schedule, and click on **Remove Select** button to remove a schedule.

## Modifying a schedule

To modify a schedule,

**Step 1:** Select the schedule by checking its Select box.

**Step 2:** Click on **Modify** button, then the schedule information page will pop up.

### Modify Weekly Record Schedule Setting

**Weekly Schedule**

Enable

Channel :

Day :  SUN  MON  TUE  WED  THU  FRI  SAT  All

Start Time :  [hh:mm]

End Time :  [hh:mm]

Record Type :

**Event Condition**

Trigger :

Stop :

Duration :  [second]

## Alarm

### System Alarm

### System Alarm

Network Disconnected Alarm

Enable network disconnected alarm

Port1 linkdown

Trigger  Alarm

*Note: System alarms work continuously after being set up.*

#### Network Disconnected Alarm

Setting	Description	Default
Enable network disconnected alarm	Enable or disable network disconnected alarm.	Disable
Trigger DO alarm	Enable or disable the triggering of DO1 or DO2	Disable

### Event Alarm

Four kinds of event alarm are provided by the VPort for building an intelligent video surveillance system.

Alarm Type	Triggered Condition	Triggered Action
Digital Inputs	DI 1 DI 2 DI3 DI4 DI5 DI6	1.DO 2.HTTP Event Server
CGI Event	The CGI trigger message	1.DO 2.HTTP Event Server

## Basic

### Event Alarm Basic Settings

Alarm Time Interval  
 Delay  second(s) before detecting the next alarm

DI, DO Status  
 DI 1 : [Low](#)    DI 2 : [Low](#)    DI 3 : [Low](#)    DI 4 : [Low](#)    DI 5 : [Low](#)    DI 6 : [Low](#)  
 DO 1 : [Close](#)    DO 2 : [Close](#)

Override DO warning setting  
 Override DO 1 warning setting  
 Override DO 2 warning setting

#### Alarm Time Interval

Setting	Description	Default
Delay second(s) before detecting the next alarm	Set the minimum time interval before another event alarm is triggered.	32 seconds (10 to 999 seconds)

**NOTE** The delay before triggering the next alarm cannot be less than the time needed to do the video recording when an event happens.

#### DI, DO Status

The Administrator can check the current DI and relay status of the MxNVR in the "DI, DO Status" section on the **Event Alarm Basic Settings** page. Two options are available to restore the relay status back to the system defaults. To enable the function, check the **Override DO 1 warning** setting and **Override DO 2 warning** setting boxes, and then click on **Save**.

**NOTE** The DOs will not be triggered if the Override DO 1 warning setting and Override DO 2 warning setting boxes are checked. Un-check these two boxes to ensure that the relays will be triggered.

## Schedule

A schedule is provided to set event alarms accordingly for daily security applications.

### Event Alarm Schedule Settings

Event Type

Weekly Schedule

Event Alarms are active all the time  
 Event Alarms are active based on weekly schedule

SUN Begin  Duration  [hh:mm]  
 MON Begin  Duration  [hh:mm]  
 TUE Begin  Duration  [hh:mm]  
 WED Begin  Duration  [hh:mm]  
 THU Begin  Duration  [hh:mm]  
 FRI Begin  Duration  [hh:mm]  
 SAT Begin  Duration  [hh:mm]

**Event Type**

Setting	Description	Default
Digital Input, CGI Event	Set up the schedule for each event type.	Digital Input

**Weekly Schedule**

Setting	Description	Default
Event Alarms are active all the time	Select the option "Event Alarms are active all the time"	Event Alarms are active based on a weekly schedule
Event Alarms are active based on a weekly schedule	Select to operate event alarms on a weekly schedule.	

**NOTE** The applications described in the following sections will only work properly if either Event Alarms are active all the time or Event Alarms are active based on selected weekly schedule.

Setting	Description	Default
<input type="checkbox"/> Sun <input type="checkbox"/> Mon <input type="checkbox"/> Tue <input type="checkbox"/> Wed <input type="checkbox"/> Thu <input type="checkbox"/> Fri <input type="checkbox"/> Sat	Select the weekday for scheduling event alarms.	None
Begin 00:00	Set the start time of the event alarm.	00:00
Duration 00:00	Set the duration for the event alarm to be active.	00:00

**NOTE** The Administrator can follow the steps to set up an event schedule:

1. Select Event Type
2. Enable "Event Alarms are active based on weekly schedule"
3. Select the weekdays
4. Set the start time
5. Set the duration this event will be active.
6. Save

**Digital Input**

6 digital inputs are provided by the MxNVR-IA8 for linking with alarm detection devices, such as sensors.

Setting	Description	Default
Enable digital input alarm	Enable or disable the digital input alarm.	Disable

**Trigger Conditions**

Setting	Description	Default
High	The DI is always in the "High" state after an alarm is detected.	Disable
Low	The DI is always in the "Low" state after an alarm is detected.	Enable
Rising	The DI works from the "Low" state to "High" state and then back to the "Low" state when an alarm is detected.	Disable
Falling	The DI works from the "High" state to "Low" state and then back to the "High" state when an alarm is detected.	Disable

**NOTE** Refer to Chapter 1 to see the DI specifications.

**Trigger Actions**

Setting	Description	Default
Trigger DO1 alarm	Once this DI is triggered, the DO1 alarm will be activated	Disable
Trigger DO2 alarm	Once this DI is triggered, the DO2 alarm will be activated	Disable
Send message via HTTP Event Servers	Once this DI is triggered, the MxNVR will send the message set in HTTP Action Setting to the HTTP event servers, which are set in the Network/ HTTP Event Server page.	Disable

**HTTP Action Setting**

Setting	Description	Default
Server 1, 2, 3, 4	Select the HTTP event server for sending the HTTP action	Disable
Blank column	The Administrator can customize the message sent to the HTTP event sever in this column	Blank

**CGI Event**

The MxNVR can accept five CGI commands, which are sent from external devices, such as ioLogik series Ethernet I/Os, to be the event alarms.

**NOTE** The MxNVR only can accept the CGI commands that conform to the MxNVR's CGI command format.

### CGI Event

Enable CGI Event alarm

CGI Event Trigger Actions

Event Index	Trigger Action	HTTP Action Setting
Event 1	<input type="checkbox"/> Trigger DO1 alarm <input type="checkbox"/> Trigger DO2 alarm <input type="checkbox"/> Send message via HTTP Event Servers	<input type="checkbox"/> Server1 <input type="checkbox"/> Server2 <input type="checkbox"/> Server3 <input type="checkbox"/> Server4 <div style="border: 1px solid #ccc; height: 40px; width: 100%;"></div>
Event 2	<input type="checkbox"/> Trigger DO1 alarm <input type="checkbox"/> Trigger DO2 alarm <input type="checkbox"/> Send message via HTTP Event Servers	<input type="checkbox"/> Server1 <input type="checkbox"/> Server2 <input type="checkbox"/> Server3 <input type="checkbox"/> Server4 <div style="border: 1px solid #ccc; height: 40px; width: 100%;"></div>
Event 3	<input type="checkbox"/> Trigger DO1 alarm <input type="checkbox"/> Trigger DO2 alarm <input type="checkbox"/> Send message via HTTP Event Servers	<input type="checkbox"/> Server1 <input type="checkbox"/> Server2 <input type="checkbox"/> Server3 <input type="checkbox"/> Server4 <div style="border: 1px solid #ccc; height: 40px; width: 100%;"></div>

**CGI Event Trigger Actions**

Setting	Description	Default
Enable CGI Event alarm	Enable or disable CGI Event alarm.	Disable
Event	Select Event 1, 2, 3, 4, 5	Disable
Trigger DO1 alarm	Once the CGI Event is triggered, the DO1 alarm will be activated	Disable
Trigger DO2 alarm	Once the CGI Event is triggered, the DO2 alarm will be activated	Disable

**HTTP Action Setting**

Setting	Description	Default
Server 1, 2, 3, 4	Select the HTTP event server for sending the HTTP action	Disable
Blank column	The administrator can customize the message sent to the HTTP event sever in this column	Blank

## Frequently Asked Questions

---

**Q: What if I forget my password?**

A: Every access to the video encoder needs authentication, unless the admin password is set to be blank. If you are one of the managed users, you will need to ask the Administrator for the password. If you are the Administrator, there is no way to recover the admin password. The only way to regain access to video encoder is to use the **RESET** button on the front panel to restore the factory settings (see Chapter 1 for details).

**Q: How much storage capability can the MxNVR-IA8 support?**

A: There are two kinds of hard disks that can be used with the MxNVR-IA8

2.5" Hard Disk: this 2.5" HDD is mainly used with the MxNVR-IA8 standard operating temperature (0 to 60°C) model. From the market information, the maximum storage capability of one 2.5" HDD is 1 TB now, which means the maximum storage capability with two 2.5" HDD is 2 TB. But for the reliability requirement, we recommend using Toshiba HDD MK5065GSX or the same series, which is tested by Moxa.

2.5" SSD (Solid State Disk): SSD is mainly used with the-IA8 wide operating temperature (-40 to 75°C) model. From the market information, the maximum storage capability is 256 GB, which means the maximum storage capability with two 2.5" SSD is 512 GB. For the operating temperature requirement, the 2.5" SSD should be able to work under temperatures of -40 to 75°C. We recommend using Innodisk SATA 10000 or the same series, which is tested by Moxa.

**Q: Does these two HDDs support redundancy?**

A: No. Currently, these two HDDs are used for storage space accumulation, not for redundancy

**Q: What is the Modbus/TCP protocol for?**

A: The MxNVR-IA8 supports the standard Modbus/TCP protocol in read/ write behavior. Using Modbus/TCP protocol allows you to monitor the status of the MxNVR-IA8, or send the Modbus commands to start video recording directly from SCADA/HMI systems, most of which use Modbus/TCP as the communication bus

**Q: What is the pre-alarm video recording for?**

A: Most NVRs support pre-alarm video recording function before the alarm is triggered. The MxNVR-IA8 supports maximum 30 seconds pre-alarm video recording. Once an alarm is triggered, the MxNVR-IA8 will provide recorded videos of up to 30 seconds before the alarm occurs.



# B

## ModBus Address Table

### Code 4 Function Support

Address	Access	Data Type	Description
<b>System Information</b>			
0x0000	R	1 word	Vendor ID = <b>0x1393</b>
0x0001	R	1 word	Unit ID (Ethernet = 1)
0x0002	R	1 word	Product Code = Magic Code(2 byte)
0x0010	R	20 words	Vendor Name = "Moxa" Word 0 Hi byte = 'M' Word 0 Lo byte = 'o' Word 1 Hi byte = 'x' Word 1 Lo byte = 'a' Word 2 Hi byte = '\0' Word 2 Lo byte = '\0'
0x0030	R	20 words	Product Name = "MxNVR-IA8" Word 0 Hi byte = 'M' Word 0 Lo byte = 'x' Word 1 Hi byte = 'N' Word 1 Lo byte = 'V' Word 2 Hi byte = 'R' Word 2 Lo byte = '-' Word 3 Hi byte = 'I' Word 3 Lo byte = 'A' Word 4 Hi byte = '8' Word 4 Lo byte = '\0'
0x0050	R	1 word	Product Serial Number
0x0051	R	2 words	Firmware Version Word 0 Hi byte = major (A) Word 0 Lo byte = minor (B) Word 1 Hi byte = release (C) Word 1 Lo byte = build (D)
0x0053	R	2 words	Firmware Release Date Firmware was released on 2007-05-06 at 09 o'clock Word 0 = 0x0609 Word 1 = 0x0705
0x0055	R	3 words	Ethernet MAC Address Ex: MAC = 00-01-02-03-04-05 Word 0 Hi byte = 0x00 Word 0 Lo byte = 0x01 Word 1 Hi byte = 0x02 Word 1 Lo byte = 0x03 Word 2 Hi byte = 0x04 Word 2 Lo byte = 0x05

Address	Access	Data Type	Description
0x005A	R	1 word	Fault LED Status 0x0000:No 0x0001:Yes
0x0080	R	1 word	DI1 0x0000:Off 0x0001:On
0x0081	R	1 word	DI2 0x0000:Off 0x0001:On
0x0082	R	1 word	DI3 0x0000:Off 0x0001:On
0x0083	R	1 word	DI4 0x0000:Off 0x0001:On
0x0084	R	1 word	DI5 0x0000:Off 0x0001:On
0x0085	R	1 word	DI6 0x0000:Off 0x0001:On
0x0086	RW	1 word	DO1 0x0000:Off 0x0001:On
0x0087	RW	1 word	DO2 0x0000:Off 0x0001:On
<b>Recorder</b>			
0x0200	R/W	1 word	Channel 1 Record Status 0x0000: Off 0x0001: Recording
0x0201	R/W	1 word	Channel 2 Record Status 0x0000: Off 0x0001: Recording
0x0202	R/W	1 word	Channel 3 Record Status 0x0000: Off 0x0001: Recording
0x0203	R/W	1 word	Channel 4 Record Status 0x0000: Off 0x0001: Recording
0x0204	R/W	1 word	Channel 5 Record Status 0x0000: Off 0x0001: Recording
0x0205	R/W	1 word	Channel 6 Record Status 0x0000: Off 0x0001: Recording
0x0206	R/W	1 word	Channel 7 Record Status 0x0000: Off 0x0001: Recording
0x0207	R/W	1 word	Channel 8 Record Status 0x0000: Off 0x0001: Recording

# C

## Time Zone Table

---

The hour offsets for different time zones are shown below. You will need this information when setting the time zone in automatic date/time synchronization. GMT stands for Greenwich Mean Time, which is the global time that all time zones are measured from.

(GMT-12:00)	International Date Line West
(GMT-11:00)	Midway Island, Samoa
(GMT-10:00)	Hawaii
(GMT-09:00)	Alaska
(GMT-08:00)	Pacific Time (US & Canada), Tijuana
(GMT-07:00)	Arizona
(GMT-07:00)	Chihuahua, La Paz, Mazatlan
(GMT-07:00)	Mountain Time (US & Canada)
(GMT-06:00)	Central America
(GMT-06:00)	Central Time (US & Canada)
(GMT-06:00)	Guadalajara, Mexico City, Monterrey
(GMT-06:00)	Saskatchewan
(GMT-05:00)	Bogota, Lima, Quito
(GMT-05:00)	Eastern Time (US & Canada)
(GMT-05:00)	Indiana (East)
(GMT-04:00)	Atlantic Time (Canada)
(GMT-04:00)	Caracas, La Paz
(GMT-04:00)	Santiago
(GMT-03:30)	Newfoundland
(GMT-03:00)	Brasilia
(GMT-03:00)	Buenos Aires, Georgetown
(GMT-03:00)	Greenland
(GMT-02:00)	Mid-Atlantic
(GMT-01:00)	Azores
(GMT-01:00)	Cape Verde Is.
(GMT)	Casablanca, Monrovia
(GMT)	Greenwich Mean Time: Dublin, Edinburgh, Lisbon, London
(GMT+01:00)	Amsterdam, Berlin, Bern, Stockholm, Vienna

(GMT+01:00) Belgrade, Bratislava, Budapest, Ljubljana, Prague (GMT+01 :00) Brussels, Copenhagen, Madrid, Paris

(GMT+01:00) Sarajevo, Skopje, Warsaw, Zagreb

(GMT+01:00) West Central Africa

(GMT+02:00) Athens, Istanbul, Minsk

(GMT+02:00) Bucharest

(GMT+02:00) Cairo

(GMT+02:00) Harare, Pretoria

(GMT+02:00) Helsinki, Kyiv, Riga, Sofia, Tallinn, Vilnius

(GMT+02:00) Jerusalem

(GMT+03:00) Baghdad

(GMT+03:00) Kuwait, Riyadh

(GMT+03:00) Moscow, St. Petersburg, Volgograd

(GMT+03:00) Nairobi

(GMT+03:30) Tehran

(GMT+04:00) Abu Dhabi, Muscat (GMT+04:00) Baku, Tbilisi, Yerevan (GMT+04:30) Kabul

(GMT+05:00) Ekaterinburg

(GMT+05:00) Islamabad, Karachi, Tashkent (GMT+05:30) Chennai, Kolkata, Mumbai, New Delhi

(GMT+05:45) Kathmandu

(GMT+06:00) Almaty, Novosibirsk (GMT+06:00) Astana, Dhaka

(GMT+06:00) Sri Jayawardenepura (GMT+06:30) Rangoon

(GMT+07:00) Bangkok, Hanoi, Jakarta (GMT+07:00) Krasnoyarsk

(GMT+08:00) Beijing, Chongqing, Hongkong, Urumqi

(GMT+08:00) Taipei

(GMT+08:00) Irkutsk, Ulaan Bataar (GMT+08:00) Kuala Lumpur, Singapore (GMT+08:00) Perth

(GMT+09:00) Osaka, Sapporo, Tokyo (GMT+09:00) Seoul

(GMT+09:00) Yakutsk

(GMT+09:30) Adelaide

(GMT+09:30) Darwin

(GMT+10:00) Brisbane

(GMT+10:00) Canberra, Melbourne, Sydney

(GMT+10:00) Guam, Port Moresby (GMT+10:00) Hobart

(GMT+10:00) Vladivostok

(GMT+11:00) Magadan, Solomon Is., New Caledonia

(GMT+12:00) Auckland, Wellington (GMT+ 12:00) Fiji, Kamchatka, Marshall Is.

(GMT+13:00) Nuku'alofa.

# Technical Specifications

Recording	
<b>No. of stream</b>	8 VPort video/audio streams
<b>Stream types</b>	H.264, MPEG4, and MJPEG
<b>Video inputs</b>	Via Ethernet
<b>Video file format</b>	AVI
<b>Record mode</b>	Manual, schedule, alarm
<b>Pre-alarm recording</b>	Up to 30 sec.
<b>Post-alarm recording</b>	Up to 60 sec.
Searching	
<b>Search mode</b>	Camera, date/time, event
Playback	
<b>Method</b>	Remote access, FTP file download
<b>Remote access</b>	Playback via web browser or client software
<b>FTP file downloads</b>	Playback via popular media players (requires FFDSHOW)
Storage	
<b>Disk interface</b>	2 2.5" SATAII sockets
<b>Note: Storage disks are not included. Users will need to purchase 2.5" hard disks or SSDs (Solid State Disk) from hard disk vendors.</b>	
Network	
<b>Protocols</b>	TCP, UDP, HTTP, SMTP, FTP, Telnet, NTP, DNS, DHCP, UPnP, RTP, RTSP, ICMP, IGMPv3, QoS (ToS), SNMP (V1/V2c/V3), DDNS, Modbus/TCP, 802.1X
<b>Ethernet</b>	1 auto-sensing 10/100/1000BaseT(X) RJ45 connector
<b>Connection</b>	Max. 10
Audio ports	
<b>Audio output</b>	1, 3.5mm, phone jack connector
Data Ports	
<b>COM ports</b>	2 RS-232 or RS-422/485 port, with DB9 male connectors (for external devices)
<b>USB ports</b>	1 USB 2.0 port, Type A
<b>Console port</b>	1 RS-232 RJ45 port
GPIO	
<b>Digital Inputs</b>	6, source type, 0 to 5 VDC at 15 Hz Level 0: Close to GND Level 1: Open
<b>Digital Outputs</b>	2, source type, 0 to 15 VDC, max. 20 mA Level 0: 0 to 0.55V Level 1: 4.2 to 5.0V
LED Indicators	
<b>STAT</b>	Indicates if system is booted up properly or not
<b>PWR</b>	Power on/off
<b>HDD</b>	Indicates if the hard disk is working or not
<b>FAULT</b>	Can be configured for system alarm-- video loss, or network down.
<b>Video 1/2/3/4/5/6/7/8</b>	The status of video channel 1 to 8

<b>LAN</b>	10/100/1000 Mbps Ethernet link status
<b>Power</b>	
<b>Input Voltage</b>	1 24 VDC power input with the 3-pin terminal block connector
<b>Power Consumption</b>	Max. of 20 watts (with 2 2.5" 500GB hard disk)
<b>Physical Characteristics</b>	
<b>Housing</b>	Metal
<b>Dimensions (W x H x D)</b>	440 x 44 x 325 mm (17.32 x 1.73 x 12.8 in)
<b>Weight</b>	Approx. 3.6 Kg
<b>Installation</b>	19" rackmount
<b>Security</b>	
<b>Password</b>	User level password protection
<b>Filtering</b>	By IP address
<b>Authentication</b>	802.1X
<b>Environmental Limits</b>	
<b>Operating Temperature</b>	Standard models: 0 to 60°C (32 to 140°F) Wide Temp. models: -40 to 75°C (-40 to 167°F)
<b>Storage Temperature</b>	-40 to 85°C (-40 to 185°F)
<b>Ambient Relative Humidity</b>	5 to 95% (non-condensing)
<b>Regulatory Approvals</b>	
<b>Safety</b>	UL 60950-1
<b>EMI</b>	FCC Part 15 Subpart B Class A, EN55022 class A
<b>EMS</b>	EN61000-4-2 (ESD), Level 3 EN61000-4-3 (RS), Level 3 EN61000-4-4 (EFT), Level 2 EN61000-4-5 (Surge), Level 3 EN61000-4-6 (CS), Level 3 EN61000-4-8 EN61000-4-11
<b>Shock</b>	IEC60068-2-27
<b>Freefall</b>	IEC60068-2-32
<b>Vibration</b>	IEC60068-2-6
<b>Warranty</b>	
<b>Warranty period</b>	5 years
<b>Details</b>	See <a href="http://www.moxa.com/warranty">www.moxa.com/warranty</a>
<b>System Requirements</b>	
<b>CPU</b>	Pentium 4 2.4 GHz or above
<b>Memory</b>	512 MB memory or above
<b>OS</b>	Windows XP/2000 with SP2 or above
<b>Browser</b>	Internet Explorer 6.x or above
<b>Multimedia</b>	DirectX9.0C or above
<b>Software development kit</b>	
<b>VPort SDK PLUS</b>	Includes VPort CGI commands, ActiveX Control, and API library for customized applications or system integration for third-party developers (the latest version of SDK is available for download from Moxa's website )