

ioLogik MXIO.NET Library User Manual

Third Edition, July 2009

www.moxa.com/product

MOXA®

© 2009 Moxa Inc. All rights reserved.
Reproduction without permission is prohibited.

ioLogik MXIO.NET Library User Manual

The software described in this manual is furnished under a license agreement, and may be used only in accordance with the terms of that agreement.

Copyright Notice

Copyright © 2009 Moxa Inc.
All rights reserved.
Reproduction without permission is prohibited.

Trademarks

Moxa is a registered trademark of Moxa Inc.
All other trademarks or registered marks in this manual belong to their respective manufacturers.

Disclaimer

Information in this document is subject to change without notice, and does not represent a commitment on the part of Moxa.

Moxa provides this document “as is,” without warranty of any kind, either expressed or implied, including, but not limited to, its particular purpose. Moxa reserves the right to make improvements, and/or changes to this manual, or to the products, and/or the programs described in this manual, at any time.

Information provided in this manual is intended to be accurate, and reliable. However, Moxa assumes no responsibility for its use, or for any infringements on the rights of third parties that may result from its use.

This manual might include unintentional technical or typographical errors. Changes are made periodically to the information herein to correct such errors, and these changes are incorporated into new editions of the manual.

Technical Support Contact Information

www.moxa.com/support

Moxa Americas:

Toll-free: 1-888-669-2872
Tel: +1-714-528-6777
Fax: +1-714-528-6778

Moxa Europe:

Tel: +49-89-3 70 03 99-0
Fax: +49-89-3 70 03 99-99

Moxa China (Shanghai office):

Toll-free: 800-820-5036
Tel: +86-21-5258-9955
Fax: +86-10-6872-3958

Moxa Asia-Pacific:

Tel: +886-2-8919-1230
Fax: +886-2-8919-1231

Table of Contents

Chapter 1.	Overview	1-1
	What is the MXIO.NET Library?	1-2
	Supported Platforms	1-2
	Supported I/O Modules	1-2
	Supported I/O Firmware	1-2
	How to Install MXIO.NET Library	1-3
	How to link MXIO.NET Library Using VB.NET and C#	1-5
	Check the version of the .NET Framework	1-5
Chapter 2.	Programming Flow	2-1
	Connecting to a Single Ethernet I/O	2-2
	Connecting to Multiple Ethernet I/O	2-3
	Connecting to a Single Serial I/O	2-4
	Connecting to Multiple RS-485 I/O	2-5
	Connecting to the ioLogik E2000 and Attached RS-485 I/O	2-6
	Modbus Command Sets vs. Direct I/O Command Sets	2-7
	Modbus Command Sets	2-7
	Direct I/O Command Sets	2-7
Chapter 3.	MXIO.NET API Overview	3-1
	System Command Sets	3-2
	RS-485/RS-232 I/O Connect Commands	3-2
	Ethernet I/O Connect Commands	3-2
	General Commands	3-2
	Commands for ioLogik E2000, R2000	3-2
	Commands for ioLogik 4000	3-3
	Commands for ioLogik E4200	3-3
	Commands for ioLogik 5000	3-3
	Commands for ioLogik E1200	3-4
	Modbus Command Sets	3-4
	Direct I/O Command Sets	3-4
	Digital Input Commands	3-4
	Digital Input Commands for ioLogik E2000, R2000	3-4
	Digital Input Commands for ioLogik 4200	3-4
	Digital Input Commands for ioLogik 5000	3-5
	Digital Input Commands for ioLogik E1200	3-5
	Digital Input / Output Mode Commands for ioLogik E2000	3-5
	Digital Input & Output mode change Commands for ioLogik 5000	3-5
	Digital Input & Output mode change Commands for ioLogik 1200	3-5
	Counter Commands for ioLogik E2000, R2000	3-6
	Counter Commands for ioLogik 5000	3-7
	Counter Commands for ioLogik E1200	3-7
	Digital Output Commands	3-8
	Digital Output Commands for ioLogik E2000, R2000	3-8
	Digital Output Commands for ioLogik 4000	3-8
	Digital Output Commands for ioLogik E4200	3-9
	Digital Output Commands for ioLogik 5000	3-9
	Digital Output Commands for E1200	3-9
	Pulse Output Commands for ioLogik E2000, R2000	3-10

	Pulse Output Commands for ioLogik 5000	3-10
	Pulse Output Commands for E1200	3-11
	Analog Input Commands	3-11
	Analog Input Commands for ioLogik E2000, R2000	3-11
	Analog Input Commands for ioLogik 5000	3-12
	Analog Input Commands for ioLogik E1200	3-12
	Analog Output Commands	3-13
	Analog Output Commands for ioLogik E2000, R2000	3-13
	Analog Output Commands for ioLogik 4000	3-13
	Analog Output Commands for ioLogik E4200	3-14
	Relay Commands for ioLogik E2000	3-14
	Relay Commands for ioLogik 5000	3-14
	Relay Commands for ioLogik E1200	3-14
	RTD Commands	3-15
	RTD Commands for ioLogik E4200	3-16
	Thermocouple Commands	3-16
	TC Commands for ioLogik E4200	3-16
	Click&Go Logic Commands	3-16
	Click&Go Logic Commands for E2000	3-16
	Click&Go Logic Commands for E4200	3-16
	Commands for ioLogik 5000	3-17
	Active I/O Message Commands	3-17
	Active I/O Message Commands for ioLogik E2000	3-17
	Active I/O Message Commands for ioLogik E4200	3-17
	Commands for ioLogik 5000	3-17
Chapter 4.	System Command Sets	4-1
	RS-232/RS-485 I/O Connect Commands	4-2
	Ethernet I/O Connect Commands	4-5
	General Commands	4-7
	Commands for ioLogik E2000, R2000	4-10
	Commands for ioLogik 4000	4-13
	Commands for ioLogik E4200	4-16
	Commands for ioLogik W5000	4-24
	Commands for ioLogik E1200	4-29
Chapter 5.	Modbus Command Sets	5-1
Chapter 6.	Direct I/O Command Sets	6-1
	Digital Input Commands	6-2
	Digital Input Commands for ioLogik E2000, R2000	6-4
	Digital Input Commands for ioLogik E4200	6-9
	Digital Input Commands for ioLogik W5000	6-10
	Digital Input Commands for ioLogik E1200	6-15
	Counter Commands for ioLogik E2000, R2000	6-20
	Counter Commands for ioLogik 5000	6-43
	Counter Commands for ioLogik E1200	6-59
	Digital Output Commands	6-74
	Digital Output Commands for ioLogik E2000, R2000	6-84
	Digital Input/Output Commands for ioLogik E2000	6-90
	Digital Input/Output Commands for ioLogik W5000	6-93
	Digital Input/Output Commands for ioLogik E1200	6-95

	Digital Output Commands for ioLogik 4000.....	6-96
	Digital Output Commands for ioLogik W5000.....	6-108
	Digital Output Commands for ioLogik 1200.....	6-115
	Pulse Output Commands for ioLogik E2000, R2000.....	6-125
	Pulse Output Commands for ioLogik W5000.....	6-145
	Pulse Output Commands for ioLogik E1200.....	6-155
	Analog Input Commands.....	6-165
	Analog Input Commands for ioLogik E2000, R2000.....	6-169
	Analog Input Commands for E4200.....	6-181
	Analog Input Commands for ioLogik W5000.....	6-183
	Analog Input Commands for ioLogik E1200.....	6-194
	Analog Output Commands.....	6-205
	Analog Output Commands for ioLogik E2000, R2000.....	6-221
	Analog Output Commands for ioLogik 4000.....	6-228
	Analog Output Commands for ioLogik E4200.....	6-232
	Relay Commands for ioLogik 2000.....	6-242
	Relay Commands for ioLogik W5000.....	6-246
	Relay Commands for ioLogik E1200.....	6-250
	RTD Commands.....	6-251
	RTD Commands for ioLogik E2000.....	6-255
	RTD Commands for ioLogik E4200.....	6-277
	Thermocouple Commands.....	6-283
	TC Commands for ioLogik E4200.....	6-287
Chapter 7.	Click&Go Logic Commands.....	7-1
Chapter 8.	Active I/O Message Commands.....	8-1
Chapter 9.	Return Codes.....	9-1
Chapter 10.	Product Model and ID Reference Table.....	10-1
	ioLogik 4000.....	10-1
	ioLogik E2000 and R2000.....	10-3
	ioLogik W5000.....	10-3
	ioLogik E1200.....	10-3

1

Overview

This reference introduces the MXIO.NET Library for Moxa's ioLogik 4000, E4200, E2000, W5000 and R2000 remote I/O.

The following topics are covered in this chapter:

- What is the MXIO.NET Library?**
- Supported Platforms**
- Supported I/O Modules**
- Supported I/O Firmware**
- How to Install MXIO.NET Library**
- How to link MXIO.NET Library Using VB.NET and C#**
- Check the version of the .NET Framework**

What is the MXIO.NET Library?

The MXIO.NET library is developed for the ioLogik 2000, ioLogik 4000, ioLogik 5000 and ioLogik 4200 series; it provides one unmanaged DLL file to be used by higher-level computer languages. It has no valid CLR (Common Language Runtime) header.

The DLL file is written by Visual C++ 2005 and provides numerous functions for a variety of digital input/output, Counter/Timer Analog input/output, and RS-485/Ethernet communication operations with ioLogik 2000, ioLogik 4000, and ioLogik 4200 series hardware.

The DLL can be used with Windows operation system, eliminating the need to process the lower-level hardware controls.

The DLL files can be used by higher-level computer language easily. For example, it provides lots of demo programs that are written in Visual C# and Visual Basic.NET. After installed MXIO.NET Library, all functions and example codes can be found in the start up menu.

Supported Platforms

- Windows 2000/XP/2003/Vista
- WinCE 5.0 ARMV4I(UC-712x, UC-7420)
- WinCE 6.0 x86(V481)

Supported I/O Modules

For a list of I/O modules that are supported by this library, please refer to *Chapter 10, Product Model and ID Reference Table*.



ATTENTION

Click&Go logic and active I/O messaging are supported by the ioLogik E2000 and ioLogik E4200.

Supported I/O Firmware

The latest MXIO library contains functions that support the latest firmware. Please refer to the following table to upgrade to the proper version. Please also refer to the ioLogik user's manual for the firmware upgrade procedures.

ioLogik Model	E2210	E2212	E2214	E2240	E2242	E2260	E2262	R2110	R2140
Firmware Version	V3.1↑	V3.1↑	V3.1↑	V2.2↑	V1.3↑	V1.2↑	V1.0↑	V1.4↑	V1.2↑

ioLogik Model	E4200	W5340	NA4XXX	E12XX					
Firmware Version	V1.0↑	V1.0	V1.0↑	V1.0↑					

How to Install MXIO.NET Library

- Download MXIO.NET library from Moxa download center. <http://www.moxa.com/support/>.
- Extract the Zip file and find “setup.exe”.



- Start to install MXIO.NET Library.

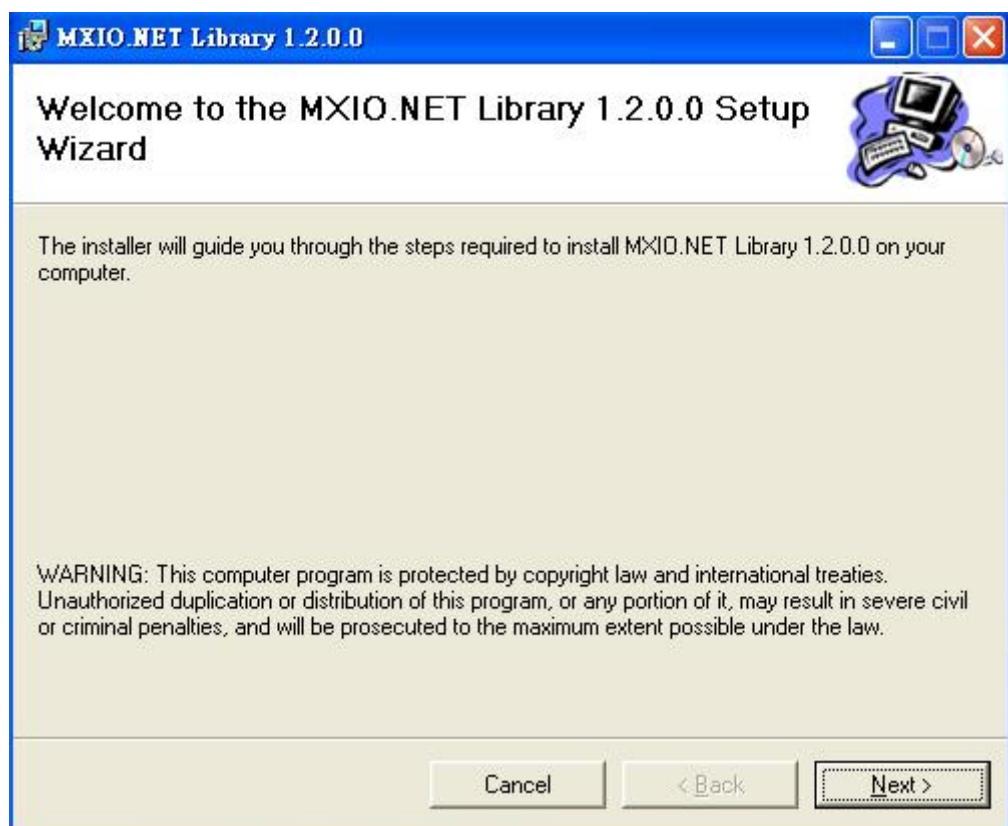

- Define the installed path for MXIO.NET library. The system default path is “C:\Program Files\MOXA\MXIO.NET\”.

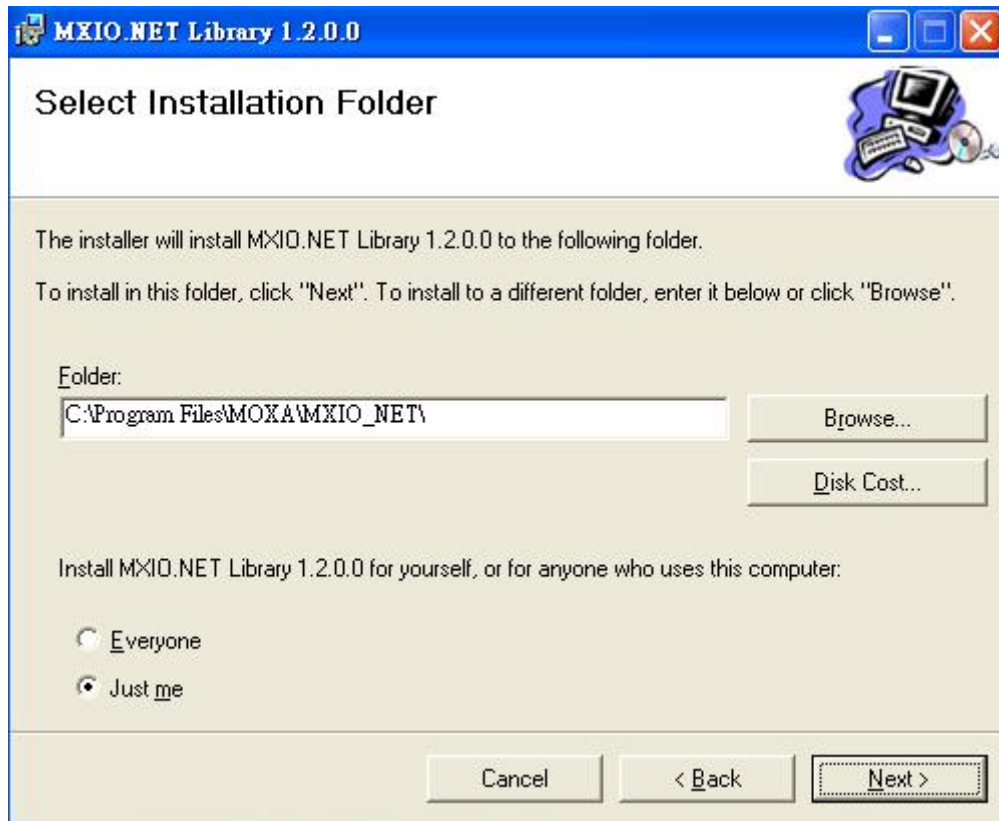

- After installed the MXIO, user can find example code, help file, and introduction from start menu.

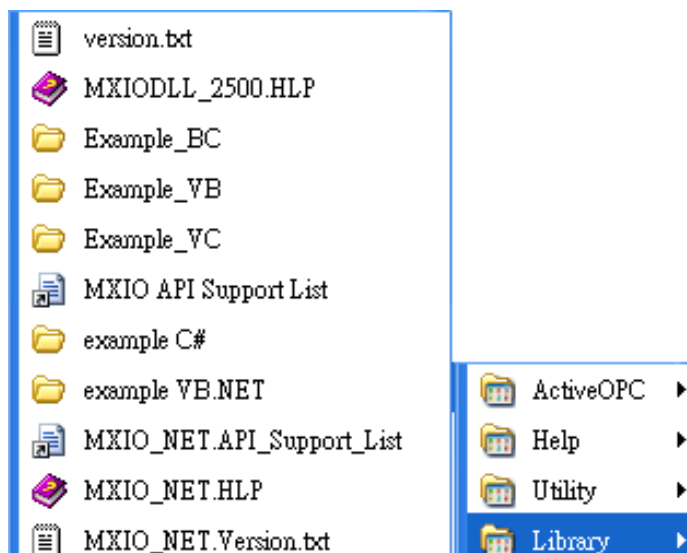

How to link MXIO.NET Library Using VB.NET and C#

- **How to link mxio.NET lib using VB.NET**

Add Existing Item into your project

C:\Program Files\MOXA\MXIO_NET\include\vb.net\MXIO.vb

Use MXIO.NET LIB API into your project

Add class name “MXIO_VB” before function name to notify to link with MXIO.NET LIB API

Ex. Function call: MXIO_VB.MXEIO_Connect (.....)

Return code: MXIO_VB.MXIO_OK

- **How to link mxio.NET lib using C#**

Add Existing Item into to your project and change namespace as your project

C:\Program Files\MOXA\MXIO_NET\include\c#\MXIO.cs.

Default namespace is “MOXA_CSharp_MXIO”

Use MXIO.NET LIB API in your project

Add class name “MXIO_CS” before function name to notify to link with MXIO.NET LIB API

Ex. Function call: MXIO_CS.MXEIO_Connect (.....)

Return code: MXIO_CS.MXIO_OK

Check the version of the .NET Framework

Moxa.NET library need to be worked with .NET Framework V2.0.50727 or above.

How to determine which versions of the .NET Framwrok are installed and whether service packs have been applied. Please refer to Microsoft official website.

<http://support.microsoft.com/kb/318785/en-us>

2

Programming Flow

The process used to obtain access to a remote I/O device on an ioLogik is similar for both Ethernet and serial interfaces. Five different scenarios are described below.

The following topics are covered:

- ❑ **Connecting to a Single Ethernet I/O**
- ❑ **Connecting to Multiple Ethernet I/O**
- ❑ **Connecting to a Single Serial I/O**
- ❑ **Connecting to Multiple RS-485 I/O**
- ❑ **Connecting to the ioLogik E2000 and Attached RS-485 I/O**
- ❑ **Modbus Command Sets vs. Direct I/O Command Sets**
 - Modbus Command Sets
 - Direct I/O Command Sets

Connecting to a Single Ethernet I/O

The MXIO.NET Library establishes a data tunnel using Modbus commands to communicate with the Ethernet I/O. Access is usually established using TCP port number 502.

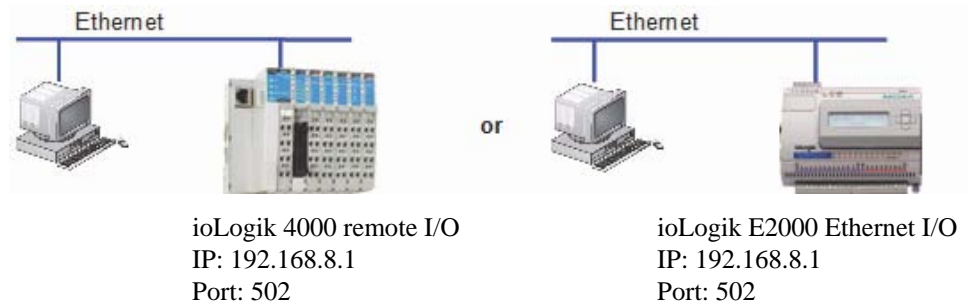

Three steps are required to access remote I/O data using the MXIO.NET Library.

1. Use `MXEIO_Connect` to connect to the Ethernet I/O using IP:Port (e.g., 192.168.8.1:502). `MXEIO_Connect` should return a handle.
2. Use the handle to access the desired I/O point with Modbus commands or direct I/O commands.
3. To finish the operation, use `MXEIO_Disconnect` to release Windows system resources.

Program Flow I.

Connecting to a Single Ethernet I/O

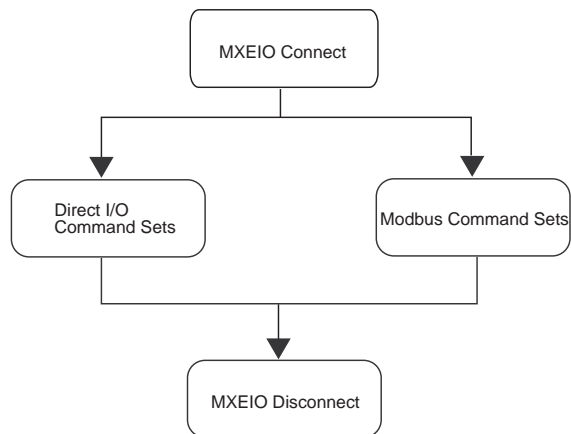

Connecting to Multiple Ethernet I/O

Before multiple Ethernet I/Os can be accessed over the network, make sure that each I/O has a unique IP address.

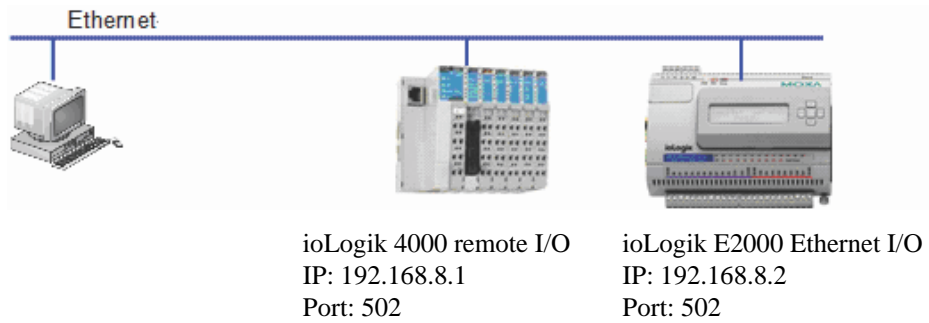

Each Ethernet I/O needs a unique handle in order to be accessed. Use `MXEIO_Connect` to obtain the handle for each Ethernet I/O.

Program Flow II.

Connecting to Multiple Ethernet I/Os.

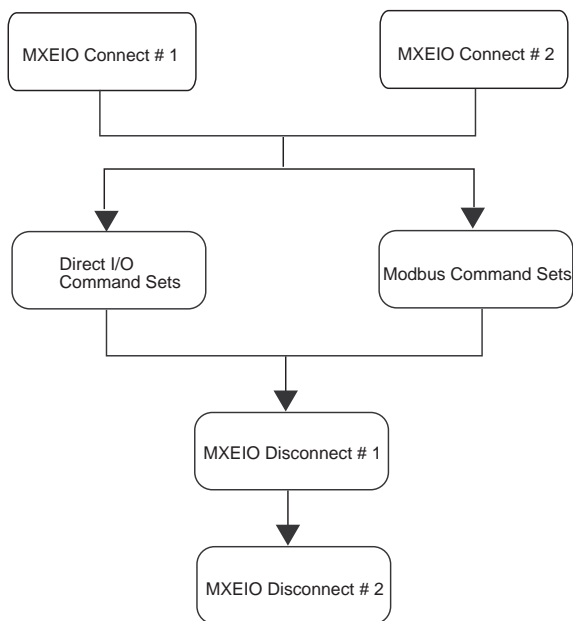

Connecting to a Single Serial I/O

The ioLogik 4000 and R2000 I/O can be used in RS-485, RS-232 control networks. For access to I/O over RS-485 or RS-232, please pay attention to the following:

- Your computer must be equipped with an RS-232 or RS-485 communication port.
- Make sure that the baudrate and communication parameters for the computer and the I/O are identical.
- Make sure that the I/O is running under Modbus/RTU

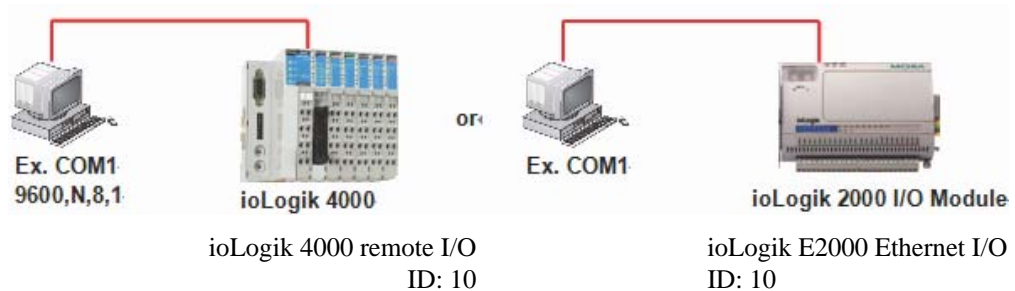

Four steps are required to access remote I/O data using theMXIO.NET Library:

1. Use `MXSIO_OpenCommport` to open the COM port and connect to the serial I/O.
2. Use `MXSIO_Connect` to connect to the serial I/O using the Unit ID (e.g., 10). `MXSIO_Connect` should return a handle.
3. Use the handle to access the desired I/O point with Modbus command sets or direct I/O command sets.
4. To finish the operation, use `MXSIO_Disconnect` and `MXSIO_CloseCommport` to release Windows system resources.

Program Flow III.

Connecting Single RS-485 I/O.

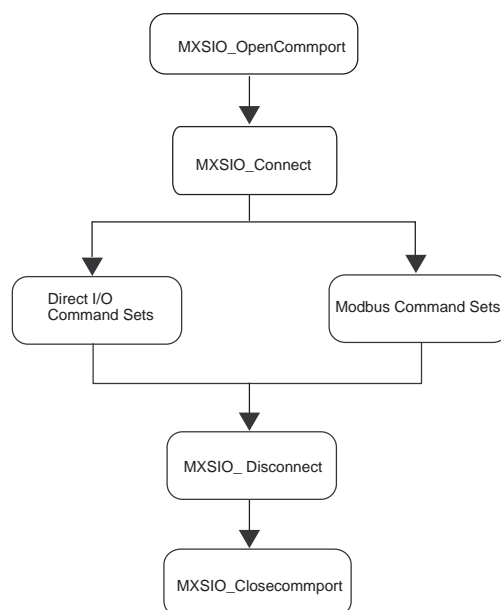

Connecting to Multiple RS-485 I/O

In most real world applications, multiple RS-485 I/Os are often connected to the same network. One RS-485 network can support up to 32 nodes.

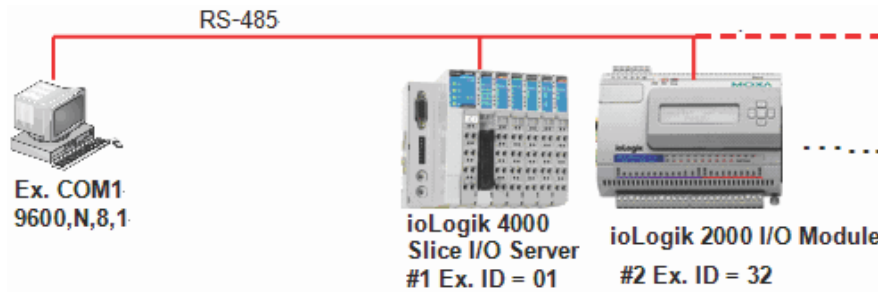

ioLogik 4000 remote I/O ID: 01 ioLogik E2000 Ethernet I/O ID: 32

Each serial I/O requires a unique handle. Make sure each serial I/O server already has its own handle before accessing the I/O points.

Program Flow IV.

Connecting Multiple Serial I/O.

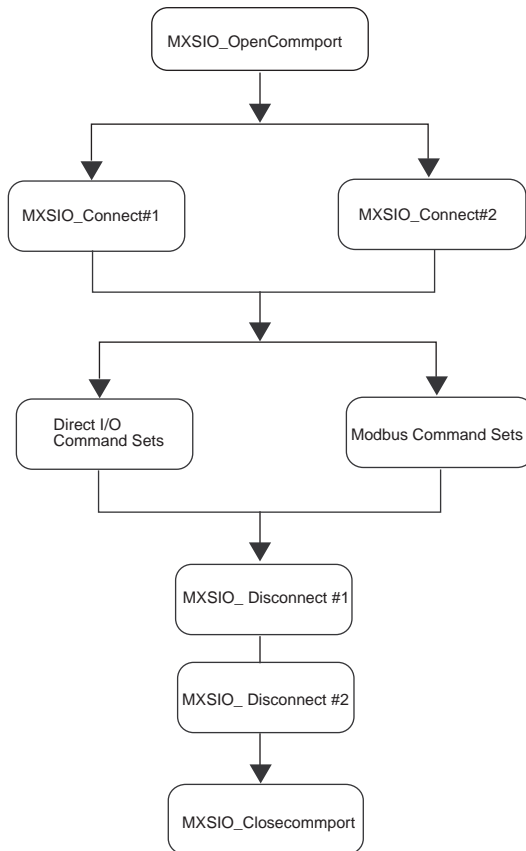

Connecting to the ioLogik E2000 and Attached RS-485 I/O

It is possible to combine Ethernet and RS-485 connections, as shown in the following figure.

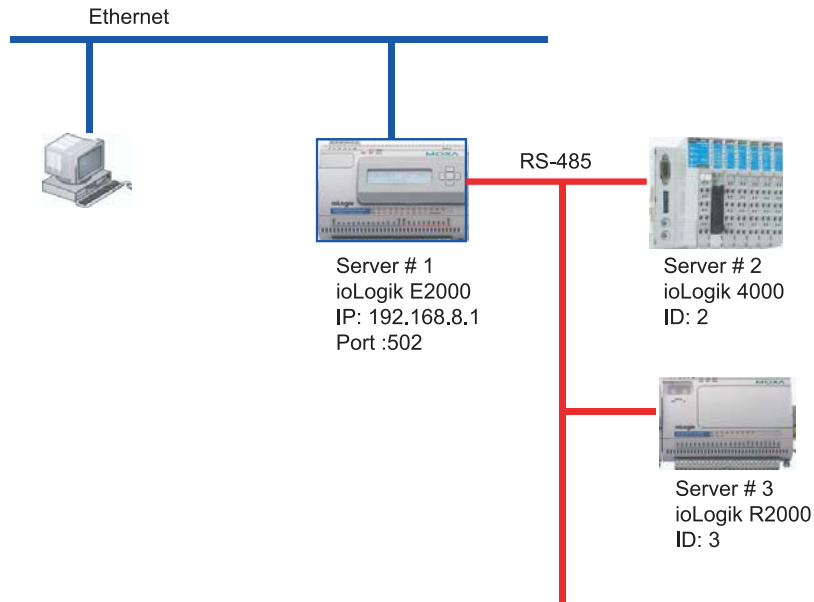

Program Flow V.

Connecting to the ioLogik E2000 Ethernet I/O and Attached RS-485 I/O.

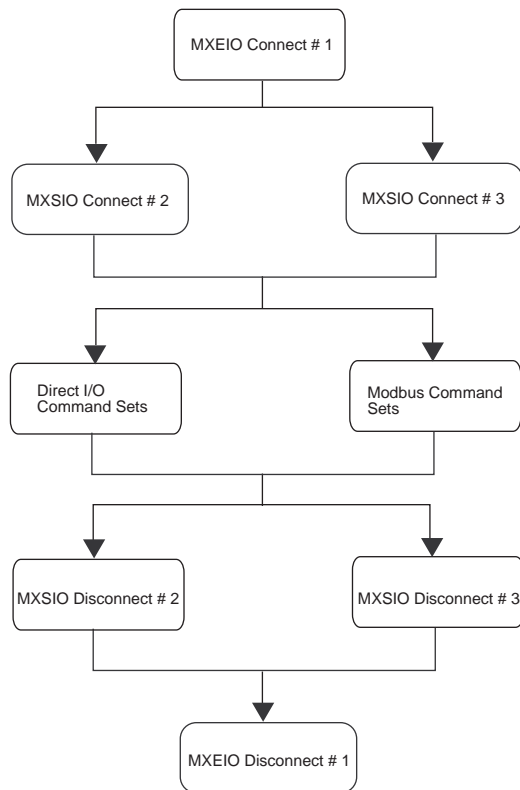

Modbus Command Sets vs. Direct I/O Command Sets

The MXIO.Net Library offers two options for accessing I/O data from ioLogik 4000, E2000, E4200 and R2000 I/O.

Modbus Command Sets

The ioLogik 4000, E4200, E2000, and R2000 I/O use Modbus/TCP and Modbus/RTU to communicate with host computers. MXIO.NET Library includes Modbus command sets that use the Modbus protocol data format to access I/O data. This is a good choice if you are already familiar with the Modbus protocol and prefer using the Modbus data structure.

Direct I/O Command Sets

As an alternative to the complex data structure of Modbus, MXIO.NET library also provides direct I/O command sets for a more intuitive method of obtaining I/O data. With direct I/O command sets, each I/O point or channel can be accessed using the physical slot number and channel number. This allows users to obtain I/O data quickly and easily.

MXIO.NET API Overview

MXIO.NET API is organized into five types of commands:

- ❑ **System Command Sets**
 - RS-485/RS-232 I/O Connect Commands
 - Ethernet I/O Connect Commands
 - General Commands
 - Commands for ioLogik E2000, R2000
 - Commands for ioLogik 4000
 - Commands for ioLogik E4200
 - Commands for ioLogik 5000
- ❑ **Modbus Command Sets**
- ❑ **Direct I/O Command Sets**
 - Digital Input Commands
 - Digital Input Commands for ioLogik E2000, R2000
 - Digital Input Commands for ioLogik 4200
 - Digital Input Commands for ioLogik 5000
 - Digital Input / Output Mode Commands for ioLogik E2000
 - Digital Input & Output mode change Commands for ioLogik 5000
 - Counter Commands for ioLogik E2000, R2000
 - Counter Commands for ioLogik 5000
 - Digital Output Commands
 - Digital Output Commands for ioLogik E2000, R2000
 - Digital Output Commands for ioLogik 4000
 - Digital Output Commands for ioLogik E4200
 - Digital Output Commands for ioLogik 5000
 - Pulse Output Commands for ioLogik E2000, R2000
 - Pulse Output Commands for ioLogik 5000
 - Analog Input Commands Analog Input Commands for ioLogik E2000, R2000
 - Analog Input Commands for ioLogik 5000
 - Analog Output Commands
 - Analog Output Commands for ioLogik E2000, R2000
 - Analog Output Commands for ioLogik 4000
 - Analog Output Commands for ioLogik E4200
 - Relay Commands for ioLogik E2000
 - Realy Commands for ioLogik 5000
 - RTD Commands RTD Commands for ioLogik E4200
 - Thermocouple Commands
 - TC Commands for ioLogik E4200
- ❑ **Click&Go Logic Commands**
- ❑ **Active I/O Message Commands**

System Command Sets

RS-485/RS-232 I/O Connect Commands

Function Name
MXSIO_OpenCommport
MXSIO_CloseCommport
MXSIO_Connect
MXSIO_Disconnect

Ethernet I/O Connect Commands

Function Name
MXEIO_Init
MXEIO_Exit
MXEIO_Connect
MXEIO_Disconnect
MXEIO_CheckConnection

General Commands

Function Name
MXIO_GetDllVersion
MXIO_GetDllBuildDate
MXIO_GetModuleType
MXIO_ReadFirmwareRevision
MXIO_ReadFirmwareDate
MXIO_Restart
MXIO_Reset

Commands for ioLogik E2000, R2000

Function Name
Module2K_GetSafeStatus
Module2K_ClearSafeStatus
Module2K_GetInternalReg
Module2K_SetInternalReg
Module2K_GetInternalRegs
Module2K_SetInternalRegs

Commands for ioLogik 4000

Function Name
Adp4K_ReadFirmwareRevision
Adp4K_ReadStatus
Adp4K_ClearStatus
Adp4K_ReadFirmwareDate
Adp4K_ReadSlotAmount
Adp4K_ReadAlarmedSlot
Adp4K_ReadAlarmedSlot

Commands for ioLogik E4200

Function Name
E42_ReadFirmwareRevision
E42_ReadFirmwareDate
E42_ReadSlotAmount
E42_ReadStatus
E42_ClearStatus
E42_GetInternalRegs
E42_SetInternalRegs
E42_GetWorkInternalRegs
E42_SetWorkInternalRegs
E42_GetIOMapMode
E42_SetIOMapMode
E42_Modbus_List
E42_ClearSafeStatus

Commands for ioLogik 5000

Function Name
W5K_GetInternalRegs
W5K_SetInternalRegs
W5K_GetGprsSignal
W5K_ListOpcDevices
W5K_GetOpcDevicesInfo
W5K_GetOpcAliasName
W5K_GetSafeStatus
W5K_ClearSafeStatus

Commands for ioLogik E1200

Function Name
E1K_GetSafeStatus
E1K_ClearSafeStatus

Modbus Command Sets

Function Name
MXIO_ReadCoils
MXIO_WriteCoils
MXIO_ReadRegs
MXIO_WriteRegs

Direct I/O Command Sets

Digital Input Commands

Function Name
DI_Reads
DI_Read
E42_DI_Reads (For E4200 only)

Digital Input Commands for ioLogik E2000, R2000

Function Name
DI2K_GetModes
DI2K_SetModes
DI2K_GetMode
DI2K_SetMode
DI2K_GetFilters
DI2K_SetFilters
DI2K_GetFilter
DI2K_SetFilter

Digital Input Commands for ioLogik 4200

Function Name
E42_DI_Reads

Digital Input Commands for ioLogik 5000

Function Name
W5K_DI_Reads
W5K_DI_GetModes
W5K_DI_SetModes
W5K_DI_GetFilters
W5K_DI_SetFilters

Digital Input Commands for ioLogik E1200

Function Name
E1K_DI_Reads
E1K_DI_GetModes
E1K_DI_SetModes
E1K_DI_GetFilters
E1K_DI_SetFilters

Digital Input / Output Mode Commands for ioLogik E2000

Function Name
DIO2K_GetIOMode
DIO2K_SetIOMode
DIO2K_GetIOModes
DIO2K_SetIOModes

Digital Input & Output mode change Commands for ioLogik 5000

Function Name
W5K_DIO_GetIOModes
W5K_DIO_SetIOModes

Digital Input & Output mode change Commands for ioLogik 1200

Function Name
E1K_DIO_GetIOModes E1K_Pulse_GetSignalWidths

Counter Commands for ioLogik E2000, R2000

Function Name
Cnt2K_Reads
Cnt2K_Clears
Cnt2K_Read
Cnt2K_Clear
Cnt2K_GetOverflows
Cnt2K_ClearOverflows
Cnt2K_GetOverflow
Cnt2K_ClearOverflow
Cnt2K_GetFilters
Cnt2K_SetFilters
Cnt2K_GetFilter
Cnt2K_SetFilter
Cnt2K_GetStartStatuses
Cnt2K_SetStartStatuses
Cnt2K_GetStartStatus
Cnt2K_SetStartStatus
Cnt2K_GetTriggerTypes
Cnt2K_SetTriggerTypes
Cnt2K_GetTriggerType
Cnt2K_SetTriggerType
Cnt2K_GetPowerOnValues
Cnt2K_SetPowerOnValues
Cnt2K_GetPowerOnValue
Cnt2K_SetPowerOnValue
Cnt2K_GetSafeValues
Cnt2K_SetSafeValues
Cnt2K_GetSafeValue
Cnt2K_SetSafeValue
Cnt2K_GetTriggerTypeWords
Cnt2K_SetTriggerTypeWords
Cnt2K_GetTriggerTypeWord
Cnt2K_SetTriggerTypeWord
Cnt2K_GetSaveStatusesOnPowerFail
Cnt2K_SetSaveStatusesOnPowerFail

Counter Commands for ioLogik 5000

Function Name
W5K_Cnt_Reads
W5K_Cnt_Clears
W5K_Cnt_GetOverflows
W5K_Cnt_ClearOverflows
W5K_Cnt_GetFilters
W5K_Cnt_SetFilters
W5K_Cnt_GetStartStatuses
W5K_Cnt_SetStartStatuses
W5K_Cnt_GetTriggerTypes
W5K_Cnt_SetTriggerTypes
W5K_Cnt_GetPowerOnValues
W5K_Cnt_SetPowerOnValues
W5K_Cnt_GetSafeValues
W5K_Cnt_SetSafeValues
W5K_Cnt_GetTriggerTypeWords
W5K_Cnt_SetTriggerTypeWords
W5K_Cnt_GetSaveStatusesOnPowerFail
W5K_Cnt_SetSaveStatusesOnPowerFail
W5K_Cnt_Reads

Counter Commands for ioLogik E1200

Function Name
E1K_Cnt_Reads
E1K_Cnt_Clears
E1K_Cnt_GetOverflows
E1K_Cnt_ClearOverflows
E1K_Cnt_GetFilters
E1K_Cnt_SetFilters
E1K_Cnt_GetStartStatuses
E1K_Cnt_SetStartStatuses
E1K_Cnt_GetPowerOnValues
E1K_Cnt_SetPowerOnValues
E1K_Cnt_GetSafeValues
E1K_Cnt_SetSafeValues
E1K_Cnt_GetTriggerTypeWords
E1K_Cnt_SetTriggerTypeWords
E1K_Cnt_GetSaveStatusesOnPowerFail

Function Name
E1K_Cnt_SetSaveStatusesOnPowerFail

Digital Output Commands

Function Name
DO_Reads
DO_Read
DO_Writes
DO_Write
DO_GetSafeValues
DO_SetSafeValues
DO_GetSafeValue
DO_SetSafeValue
DO_GetSafeValues_W
DO_SetSafeValues_W

Digital Output Commands for ioLogik E2000, R2000

Function Name
DO2K_GetModes
DO2K_SetModes
DO2K_GetMode
DO2K_SetMode
DO2K_GetPowerOnValues
DO2K_SetPowerOnValues
DO2K_GetPowerOnValue
DO2K_SetPowerOnValue
DO2K_GetPowerOnSeqDelaytimes
DO2K_SetPowerOnSeqDelaytimes

Digital Output Commands for ioLogik 4000

Function Name
DO4K_GetSafeActions
DO4K_SetSafeActions
DO4K_GetSafeAction
DO4K_SetSafeAction

Digital Output Commands for ioLogik E4200

Function Name
E42_DO_GetSafeActions
E42_DO_SetSafeActions
E42_DO_GetPowerOnValues
E42_DO_SetPowerOnValues
E42_DO_Reads
E42_DO_Writes
E42_DO_GetFaultValues
E42_DO_SetFaultValues

Digital Output Commands for ioLogik 5000

Function Name
W5K_DO_Reads
W5K_DO_Writes
W5K_DO_GetSafeValues
W5K_DO_SetSafeValues
W5K_DO_GetModes
W5K_DO_SetModes
W5K_DO_GetPowerOnValues
W5K_DO_SetPowerOnValues

Digital Output Commands for E1200

Function Name
E1K_DO_Reads
E1K_DO_Writes
E1K_DO_GetSafeValues_W
E1K_DO_SetSafeValues_W
E1K_DO_GetModes
E1K_DO_SetModes
E1K_DO_GetPowerOnValues
E1K_DO_SetPowerOnValues
E1K_DO_GetPowerOnSeqDelayTimes
E1K_DO_SetPowerOnSeqDelayTimes

Pulse Output Commands for ioLogik E2000, R2000

Function Name
Pulse2K_GetSignalWidths
Pulse2K_SetSignalWidths
Pulse2K_GetSignalWidth
Pulse2K_SetSignalWidth
Pulse2K_GetSignalWidths32: Only for ioLogik E2260
Pulse2K_SetSignalWidths32: Only for ioLogik E2260
Pulse2K_GetSignalWidth32: Only for ioLogik E2260
Pulse2K_SetSignalWidth32: Only for ioLogik E2260
Pulse2K_GetOutputCounts
Pulse2K_SetOutputCounts
Pulse2K_GetOutputCount
Pulse2K_SetOutputCount
Pulse2K_GetStartStatuses
Pulse2K_SetStartStatuses
Pulse2K_GetStartStatus
Pulse2K_SetStartStatus
Pulse2K_GetPowerOnValues
Pulse2K_SetPowerOnValues
Pulse2K_GetPowerOnValue
Pulse2K_SetPowerOnValue
Pulse2K_GetSafeValues
Pulse2K_SetSafeValues
Pulse2K_GetSafeValue
Pulse2K_SetSafeValue

Pulse Output Commands for ioLogik 5000

Function Name
W5K_Pulse_GetSignalWidths32
W5K_Pulse_SetSignalWidths32
W5K_Pulse_GetOutputCounts
W5K_Pulse_SetOutputCounts
W5K_Pulse_GetStartStatuses
W5K_Pulse_SetStartStatuses
W5K_Pulse_GetPowerOnValues
W5K_Pulse_SetPowerOnValues
W5K_Pulse_GetSafeValues
W5K_Pulse_SetSafeValues
W5K_Pulse_GetSignalWidths32

Pulse Output Commands for E1200

Function Name
E1K_Pulse_GetSignalWidths
E1K_Pulse_SetSignalWidths
E1K_Pulse_GetOutputCounts
E1K_Pulse_SetOutputCounts
E1K_Pulse_GetStartStatuses
E1K_Pulse_SetStartStatuses
E1K_Pulse_GetPowerOnValues
E1K_Pulse_SetPowerOnValues
E1K_Pulse_GetSafeValues
E1K_Pulse_SetSafeValues

Analog Input Commands

Function Name
AI_Reads
AI_Read
AI_ReadRaws
AI_ReadRaw
E42_AI_Reads (for E4200 only)

Analog Input Commands for ioLogik E2000, R2000

Function Name
AI2K_ReadMins
AI2K_ReadMinRaws
AI2K_ResetMins
AI2K_ReadMin
AI2K_ReadMinRaw
AI2K_ResetMin
AI2K_ReadMaxs
AI2K_ReadMaxRaws
AI2K_ResetMaxs
AI2K_ReadMax
AI2K_ReadMaxRaw
AI2K_ResetMax
AI2K_GetRanges
AI2K_SetRanges
AI2K_GetRange
AI2K_SetRange
AI2K_GetChannelStatus
AI2K_SetChannelStatus
AI2K_GetChannelStatuses

Function Name
AI2K_SetChannelStatuses

Analog Input Commands for ioLogik 5000

Function Name
W5K_AI_Reads
W5K_AI_ReadRaws
W5K_AI_ReadMins
W5K_AI_ReadMinRaws
W5K_AI_ResetMins
W5K_AI_ReadMaxs
W5K_AI_ReadMaxRaws
W5K_AI_ResetMaxs
W5K_AI_GetRanges
W5K_AI_SetRanges
W5K_AI_GetChannelStatuses
W5K_AI_SetChannelStatuses

Analog Input Commands for ioLogik E1200

Function Name
E1K_AI_Reads
E1K_AI_ReadRaws
E1K_AI_ReadMins
E1K_AI_ReadMinRaws
E1K_AI_ResetMins
E1K_AI_ReadMaxs
E1K_AI_ReadMaxRaws
E1K_AI_ResetMaxs
E1K_AI_GetRanges
E1K_AI_GetChannelStatuses
E1K_AI_SetChannelStatuses

Analog Output Commands

Function Name
AO_Reads
AO_Writes
AO_Read
AO_Write
AO_ReadRaws
AO_WriteRaws
AO_ReadRaw
AO_WriteRaw
AO_GetSafeValues
AO_SetSafeValues
AO_GetSafeValue
AO_SetSafeValue
AO_GetSafeRaws
AO_SetSafeRaws
AO_GetSafeRaw
AO_SetSafeRaw

Analog Output Commands for ioLogik E2000, R2000

Function Name
AO2K_GetRanges
AO2K_SetRanges
AO2K_GetRange
AO2K_SetRange
AO2K_GetPowerOnValues
AO2K_SetPowerOnValues
AO2K_GetPowerOnValue
AO2K_SetPowerOnValue
AO2K_GetPowerOnRaws
AO2K_SetPowerOnRaws
AO2K_GetPowerOnRaw
AO2K_SetPowerOnRaw

Analog Output Commands for ioLogik 4000

Function Name
AO4K_GetSafeActions
AO4K_SetSafeActions
AO4K_GetSafeAction
AO4K_SetSafeAction

Analog Output Commands for ioLogik E4200

Function Name
E42_AO_GetSafeActions
E42_AO_SetSafeActions
E42_AO_GetPowerOnValues
E42_AO_SetPowerOnValues
E42_AO_Reads
E42_AO_Writes
E42_AO_ReadRaws
E42_AO_WriteRaws
E42_AO_GetFaultValues
E42_AO_SetFaultValues

Relay Commands for ioLogik E2000

Function Name
RLY2K_GetResetTime
RLY2K_TotalCntRead
RLY2K_TotalCntReads
RLY2K_CurrentCntRead
RLY2K_CurrentCntReads
RLY2K_ResetCnt
RLY2K_ResetCnts

Relay Commands for ioLogik 5000

Function Name
W5K_RLY_GetResetTime
W5K_RLY_TotalCntReads
W5K_RLY_CurrentCntReads
W5K_RLY_ResetCnts

Relay Commands for ioLogik E1200

Function Name
E1K_RLY_TotalCntReads

RTD Commands

Function Name
RTD_Reads
RTD_Read
RTD_ReadRaws
RTD_ReadRaw
RTD2K_ResetMin
RTD2K_ResetMins
RTD2K_ResetMax
RTD2K_ResetMaxs
RTD2K_ReadMinRaw
RTD2K_ReadMinRaws
RTD2K_ReadMaxRaw
RTD2K_ReadMaxRaws
RTD2K_ReadMin
RTD2K_ReadMins
RTD2K_ReadMax
RTD2K_ReadMaxs
RTD2K_GetChannelStatus
RTD2K_SetChannelStatus
RTD2K_GetChannelStatuses
RTD2K_SetChannelStatuses
RTD2K_GetSensorType
RTD2K_SetSensorType
RTD2K_GetSensorTypes
RTD2K_SetSensorTypes
RTD2K_GetEngUnit
RTD2K_SetEngUnit
RTD2K_GetEngUnits
RTD2K_GetMathPar
RTD2K_SetMathPar
RTD2K_GetMathPars
RTD2K_SetMathPars

RTD Commands for ioLogik E4200

Function Name
E42_RTD_Reads
E42_RTD_ReadRaws
E42_RTD_GetEngUnit
E42_RTD_SetEngUnit
E42_RTD_GetSensorType
E42_RTD_SetSensorType

Thermocouple Commands

Function Name
TC_Reads
TC_Read
TC_ReadRaws
TC_ReadRaw

TC Commands for ioLogik E4200

Function Name
E42_TC_Reads
E42_TC_ReadRaws
E42_TC_GetEngUnit
E42_TC_SetEngUnit
E42_TC_GetSensorType
E42_TC_SetSensorType

Click&Go Logic Commands

Click&Go Logic Commands for E2000

Function Name
Logic2K_GetStartStatus
Logic2K_SetStartStatus

Click&Go Logic Commands for E4200

Function Name
E42_Logic_GetStartStatus
E42_Logic_SetStartStatus

Commands for ioLogik 5000

Function Name
W5K_Logic_GetStartStatus
W5K_Logic_SetStartStatus

Active I/O Message Commands

Active I/O Message Commands for ioLogik E2000

Function Name
Message2K_Start
Message2K_Stop

Active I/O Message Commands for ioLogik E4200

Function Name
E42_Message_Start
E42_Message_Stop

Commands for ioLogik 5000

Function Name
W5K_Message_Start
W5K_Message_Stop

4

System Command Sets

System commands include functions that initialize the connection between a host computer and the I/O. In addition, system commands include functions for obtaining hardware and status information for the I/O itself.

The following topics are covered:

- RS-232/RS-485 I/O Connect Commands**
- Ethernet I/O Connect Commands**
- General Commands**
- Commands for ioLogik E2000, R2000**
- Commands for ioLogik 4000**
- Commands for ioLogik E4200**
- Commands for ioLogik W5000**
- Commands for ioLogik E1200**

RS-232/RS-485 I/O Connect Commands

MXSIO_OpenCommport	This function opens the local COM port of the host computer with communication parameters.	
C#	int	MXSIO_OpenCommport (byte[] szCommport, UInt32 dwBaudrate, byte bytDataFormat, UInt32 dwTimeout, Int[] hCommport);
VB.NET	MXSIO_OpenCommport (ByVal sCommport() As Byte, ByVal nBaudrate As UInt32, ByVal bytDataFormat AS Byte, ByVal nTimeOut As UInt32, ByRef hCommport As Integer) As Integer;	
Arguments	szCommport: Name of the common port, e.g., "COM3". dwBaudrate: Baud rate value. e.g. 1200, 9600, 19200 bytDataFormat: Transmission data format. bit_cnt (bit 0, 1) = 0x00 = bit_5 0x01 = bit_6 0x02 = bit_7 0x03 = bit_8 stop_cnt (bit 2) = 0x00 = stop_1 0x04 = stop_2 parity (bit 3, 4, 5) = 0x00 = none 0x08 = odd 0x18 = even 0x28 = mark 0x38 = space dwTimeout: Time out value for serial adapter communication. The unit is in milliseconds. hCommport: Handle of the opened COM port.	
Return Value	Succeed MXIO_OK. Fail Refer to Return Codes.	

MXSIO_CloseCommport	This closes the COM port; the COM port handle will be invalid.
C#	int MXSIO_CloseCommport (Int32 hCommport);
VB.NET	MXSIO_CloseCommport(ByVal hCommport As Integer) As Integer
Arguments	hCommport: Handle of the opened COM port.
Return Value	Succeed MXIO_OK. Fail Refer to Return Codes.

MXSIO_Connect	Based on the COM port handle users must use the function to establish an I/O device handle for each RS-485 or RS-232 I/O device. A COM port handle can connect one RS-232 I/O device or up to 64 RS-485 I/O devices.	
C#	int MXSIO_Connect (Int32 byte byte Int32[]	hCommport, bytUnitID, bytTransmissionMode, hConnection);
VB.NET	MXSIO_Connect (ByVal ByVal ByVal ByRef	hCommport As Integer, bytUnitID As Byte, bytTransmissionMode AS Byte hConnection As Integer), As Integer;
Arguments	<p>hCommport: Connecting I/O Server via Serial interface will get a serial handle. Connecting I/O Server via Ethernet interface will get a Ethernet handle. For more detail description please see the program flow IV and program flow V.</p> <p>bytUnitID: Modbus Unit ID of the RS-232 or RS-485 I/O Server. Ranging from 01 – 99.</p> <p>bytTransmissionMod: Modbus transmission format.</p> <p><i>ex:</i> 0: RTU mode Transmission Mode 1: ASCII Transmission Mode.</p> <p>Note that the protocol settings must agree with the hardware settings on ioLogik 4000 RS-485/232 I/O Server, and ioLogik 2000 only supports RTU.</p> <p>hConnection: Handle of the I/O device connection.</p>	
Return Value	<p>Succeed</p> <p>Fail</p>	<p>MXIO_OK.</p> <p>Refer to Return Codes.</p>

MXSIO_Disconnect	Disconnect the RS-485/232 I/O device. The I/O device handle will be invalid.
C#	int MXSIO_Disconnect(Int32 hConnection);
VB.NET Arguments	MXSIO_Disconnect(ByVal hConnection As Integer) As Integer
Return Value	hConnection: Handle for the I/O device connection. Succeed MXIO_OK. Fail Refer to Return Codes.

Ethernet I/O Connect Commands

MXEIO_Init	Initiate the socket.
C#	int MXEIO_Init ();
VB.NET Arguments	MXEIO_Init() As Integer
Return Value	None Succeed MXIO_OK. Fail Refer to Return Codes.

MXEIO_Exit	To terminates use of the socket.
C#	int MXEIO_Exit ();
VB.NET Arguments	MXEIO_Exit()
Return Value	None.

MXEIO_Connect	This function establishes a connection to the port of the Ethernet I/O device. Once a connection is established, a handle will be returned for additional functions.	
C#	int MXEIO_Connect (byte[] szIP, UInt16 wPort, UInt32 dwTimeOut, Int32[] hConnection);	
BV.NET	MXEIO_Connect (ByVal szIP() As Byte, ByVal iPort As UInt16, ByVal nTimeOut As UInt32, ByRef hConnection As Integer) As Integer	
Arguments	szIP:	IP address of the Ethernet I/O device to be connected.
	wPort:	TCP port number of Ethernet I/O device. Please use 502 for ioLogik 4000 and ioLogik 2000.
	dwTimeOut:	Timeout value for establishing a network connection with the ioLogik Ethernet Adapter. The unit is in milliseconds.
	hConnection:	Handle for the I/O device connection.
Return Value	Succeed	MXIO_OK.
	Fail	Refer to Return Codes.

MXEIO_Disconnect	Close the connection with the Ethernet I/O device; the handle will be invalid.	
C#	int MXEIO_Disconnect(Int32 hConnection);	
VB.NET	MXEIO_Disconnect(ByVal hConnection As Integer) As Integer	
Arguments	hConnection:	Handle for the connection.
Return Value	Succeed	MXIO_OK.
	Fail	Refer to Return Codes.

MXEIO_CheckConnection	This function checks connection status. Once the connection is connected, a handle will be returned for additional functions.	
C#	int MXEIO_CheckConnection(Int32	hConnection,
	UInt32	dwTimeOut,
	byte[]	bytStatus);
VB.NET	MXEIO_CheckConnection(Byval	hconnection As Integer,
	ByVal	nTimeOut As UInt32,
	ByRef	bytStatus As Byte) As
	Integer	
Arguments	hConnection:	I/O device handle for a connection.
	dwTimeOut:	Timeout value for network connection. The unit is in milliseconds.
	bytStatus	Connection status. 0: Check connection ok. 1: Check connection fail. 2: Check connection time out.
Return Value	Succeed	MXIO_OK.
	Fail	Refer to Return Codes.

General Commands

MXIO_GetDllVersion	This will get the DLL version.	
C#	int MXIO_GetDllVersion ();	
VB.NET	MXIO_GetDllVersion() As Integer	
Arguments	None	
Return Value	Succeed	Return the DLL version. If the value is 0x2000, then the version is 2.0.0.0.

MXIO_GetDllBuildDate	This will get the DLL release date.	
C#	int MXIO_GetDllBuildDate ();	
VB.NET	MXIO_GetDllBuildDate() As Integer	
Arguments	None	
Return Value	Succeed	Return the DLL release date. If the value is 0x20071001, then the date is 2007/10/01.

MXIO_GetModuleType	This function reports the model name of the Network Adapter and the I/O modules.	
C#	int MXIO_GetModuleType (Int32 hConnection, byte bytSlot, UInt16[] wType);	
VB.NET	MXIO_GetModuleType (ByVal hConnection As Integer, ByVal bytSlot As Byte, ByRef iTType As UInt16) As Integer	
Arguments	hConnection:	I/O device handle for a connection.
	bytSlot:	Slot number of the I/O device to be checked. The ioLogik 4000 Network Adapter's Slot number is always 0. The Slot number ranges from 0 to 32. But this parameter is inactive in ioLogik 2000.
	wType:	A pointer that stores the model name. If the value is 0 x 4010, the model name is NA-4010. Refer to the Model name reference table for more information.
Return Value	Succeed	MXIO_OK.
	Fail	Refer to Return Codes.

MXIO_ReadFirmwareRevision	This function reports the firmware revision of the ioLogik Network Adapter or the ioLogik 2000 module.
C#	int MXIO_ReadFirmwareRevision (Int32 hConnection, byte[] bytRevision);
VB.NET	MXIO_ReadFirmwareRevision(ByVal hConnection As Integer, ByVal bytRevision() As Byte) As Integer
Arguments	<p>hConnection: I/O device handle for a connection.</p> <p>bytRevision: Stored ioLogik 4000 firmware revision</p> <p>bytRevision[0] = major (A)</p> <p>bytRevision[1] = minor (B)</p> <p>bytRevision[2] = release (C)</p> <p>bytRevision[3] = build (D)</p> <p>format is A.B.C.D</p>
Return Value	<p>Succeed MXIO_OK.</p> <p>Fail Refer to Return Codes.</p>

MXIO_ReadFirmwareDate	This function reports firmware release date of the ioLogik 4000 Network Adapter or the ioLogik 2000 module.
C#	int MXIO_ReadFirmwareDate (Int32 hConnection, UInt16[] wDate);
VB.NET	MXIO_ReadFirmwareDate(ByVal hConnection As Integer, ByVal iDate() As UInt16) As Integer
Arguments	<p>hConnection: I/O device handle for a connection.</p> <p>wDate: Firmware release date.</p> <p>Ex If Word 0 = 0x0705 , Word 1 = 0x2005 then firmware release date is July 5, 2005</p>
Return Value	<p>Succeed MXIO_OK.</p> <p>Fail Refer to Return Codes.</p>

MXIO_Restart	This function is used to restart the I/O device.
C#	int MXIO_Restart (Int32 hConnection);
VB.NET	MXIO_Restart(ByVal hConnection As Integer) As Integer
Arguments	hConnection: I/O device handle for a connection.
Return Value	Succeed MXIO_OK. Fail Refer to Return Codes.

MXIO_Reset	This function is used to reset to default.
C#	int MXIO_Reset (Int32 hConnection);
VB.NET	MXIO_Reset(ByVal hConnection As Integer) As Integer
Arguments	hConnection: I/O Server handle for a connection.
Return Value	Succeed MXIO_OK. Fail Refer to Return Codes.

Commands for ioLogik E2000, R2000

Module2K_GetSafeStatus	This function code is used to get the safe status of an ioLogik E2000 or R2000 I/O.
C#	int Module2K_GetSafeStatus (Int32 hConnection, UInt16[] wStatus);
VB.NET	Module2K_GetSafeStatus(ByVal hConnection As Integer, ByRef istatus As UInt16) As Integer
Arguments	hConnection: The handle for a connection. wStatus: A pointer to the specific module's safe status. The values are: 0: Normal. 1: Safe mode.
Return Value	Succeed MXIO_OK. Fail Refer to Return Codes.

Module2K_ClearSafeStatus	This function code is used to clear the safe status of ioLogik 2000 Module.
C#	int Module2K_ClearSafeStatus (Int32 hConnection);
VB.NET	Module2K_ClearSafeStatus(ByVal hConnection As Integer) As Integer
Arguments	hConnection: The handle for a connection.
Return Value	Succeed MXIO_OK. Fail Refer to Return Codes.

Module2K_GetInternalReg	This function code is used to get the internal register of the ioLogik 2000 Module.
C#	int Module2K_GetInternalReg(Int32 hConnection, byte bytChannel, UInt16[] wValue);
VB.NET	Module2K_GetInternalReg(ByVal hConnection As Integer, ByVal bytChannel As Byte, ByRef wValue As UInt16) As Integer
Arguments	hConnection: The handle for a connection bytChannel: The specific channel to be read. wValue Represents the value of the specific channel. The values are 0 ~ 255
Return Value	Succeed MXIO_OK. Fail Refer to Return Codes.

Module2K_SetInternalReg	This function code is used to set the internal register of ioLogik 2000 Module.	
C#	<pre>int Module2K_SetInternalReg(Int32 hConnection, byte bytChannel, UInt16 wValue);</pre>	
VB.NET	<pre>Module2K_SetInternalReg(ByVal hConnection As Integer, ByVal bytChannel As Byte, ByVal wValue As UInt16) As Integer</pre>	
Arguments	<p>hConnection: The handle for a connection</p> <p>bytChannel: The specific channel to be set.</p> <p>wValue: Represents the value of the specific channel. The values are 0 ~ 255</p>	
Return Value	<p>Succeed: MXIO_OK.</p> <p>Fail: Refer to Return Codes.</p>	

Module2K_GetInternalRegs	This function code is used to get the internal registers of ioLogik 2000 Module.	
C#	<pre>int Module2K_GetInternalRegs(Int32 hConnection, byte bytStartChannel, byte bytCount, UInt16[] wValue);</pre>	
VB.NET	<pre>Module2K_GetInternalRegs(ByVal hConnection As Integer, ByVal bytStartChannel As Byte, ByVal bytCount As Byte, ByVal wValue() As UInt16) As Integer</pre>	
Arguments	<p>hConnection: The handle for a connection</p> <p>bytStartChannel: Specifies the starting channel</p> <p>bytCount: The number of channels to be read (Up to 24).</p> <p>wValue: Represents the value of the starting channel. The values are 0 ~ 255</p>	
Return Value	<p>Succeed: MXIO_OK.</p> <p>Fail: Refer to Return Codes.</p>	

Module2K_SetInternalRegs	This function code is used to set the internal registers of ioLogik 2000 Module.
C#	int Module2K_SetInternalRegs(int hConnection, byte bytStartChannel, byte bytCount, UInt16[] wValue);
VB.NET	Module2K_SetInternalRegs(ByVal hConnection As Integer, ByVal bytStartChannel As Byte, ByVal bytCount As Byte, ByVal wValue() As UInt16) As Integer
Arguments	<p>hConnection: The handle for a connection</p> <p>bytStartChannel: Specifies the starting channel</p> <p>bytCount: The number of channels to be read (Up to 24).</p> <p>wValue: An array that stores contiguous internal register. The values are 0 ~ 255</p>
Return Value	<p>Succeed: MXIO_OK.</p> <p>Fail: Refer to Return Codes.</p>

Commands for ioLogik 4000

Adp4K_ReadFirmwareRevision	This function code is used to read the firmware revision.
C#	int Adp4K_ReadFirmwareRevision(Int32 hConnection, UInt16[] wRevision);
VB.NET	Adp4K_ReadFirmwareRevision(ByVal hConnection As Integer, ByRef iRevision As UInt16) As Integer
Arguments	<p>hConnection: The handle for an I/O device connection.</p> <p>wRevision: Stores the firmware revision. For revision 1.01, the value will be 0X0101.</p>
Return Value	<p>Succeed: MXIO_OK.</p> <p>Fail: Refer to Return Codes.</p>

Adp4K_ReadStatus	This function code is used to read the status of the ioLogik4000 adapter.
C#	<pre>int Adp4K_ReadStatus(Int32 hConnection, UInt16[] wBusStatus, UInt16[] wFPStatus, UInt16[] wEWStatus, UInt16[] wESStatus, UInt16[] wECStatus);</pre>
VB.NET	<pre>Adp4K_ReadStatus(ByVal hConnection As Integer, ByRef iBusStatus As UInt16, ByRef iFPStatus As UInt16, ByRef iEWStatus As UInt16, ByRef iESStatus As UInt16, ByRef iECStatus As UInt16) As Integer</pre>
Arguments	<p>hConnection: The handle for an I/O device connection.</p> <p>wBusStatus: Stores the bus status in numerical format. The values are: 0: Normal Operation. 1: Bus Standby. 2: Bus Communication Fault. 3: Slot Configuration Failed. 4: No Expansion Slot.</p> <p>wFPStatus: Stores the field power status in numerical format. The values are: 0: 24 VDC Field Power On. 1: 24 VDC Field Power Off.</p> <p>wEWStatus: Stores the Watchdog status in numerical format. The values are: 0: No Error. 1: Watchdog activated.</p> <p>wESStatus: Stores the Modbus Setup Error status in numeric data format, only support NA-4020 & NA-4021. 0: No Error. 1: Modbus Setup Error.</p> <p>wECStatus: Stores the Modbus Checksum Error status, supported by NA-4020 & NA-4021 only. 0: No Error. 1: Three continuous CRC/LRC checksum errors have occurred since last restart, last clear counters operation, or last power-up.</p>
Return Value	<p>Succeed MXIO_OK.</p> <p>Fail Refer to Return Codes.</p>

Adp4K_ClearStatus	This function code is used to clear the status of the ioLogik 4000 adapters.
C#	int Adp4K_ClearStatus (Int32 hConnection);
VB.NET	Adp4K_ClearStatus(ByVal hConnection As Integer) As Integer
Arguments	hConnection: The handle for an I/O device connection.
Return Value	Succeed MXIO_OK. Fail Refer to Return Codes.

Adp4K_ReadFirmwareDate	This function code is used to read the firmware release date.
C#	int Adp4K_ReadFirmwareDate(Int32 hConnection, UInt16[] wDate);
VB.NET	Adp4K_ReadFirmwareDate(ByVal hConnection As Integer, ByVal iDate() As UInt16) As Integer
Arguments	hConnection: The handle for a connection. wDate: An array that stores the firmware release date. For a firmware release date of July 5, 2005, wDate[0] will be 0X0705 and wDate[1] will be 0X2005.
Return Value	Succeed MXIO_OK. Fail Refer to Return Codes.

Adp4K_ReadSlotAmount	This function code is used to read the number of expansion slots.
C#	int Adp4K_ReadSlotAmount(Int32 hConnection, UInt16[] wAmount);
VB.NET	Adp4K_ReadSlotAmount(ByVal hConnection As Integer, ByRef iAmount As UInt16) As Integer
Arguments	hConnection: The handle for a connection. wAmount: A pointer to the number of expansion slots.
Return Value	Succeed MXIO_OK. Fail Refer to Return Codes.

Adp4K_ReadAlarmedSlot	This function code is used to read the number of expansion slots.
C#	int Adp4K_ReadAlarmedSlot(Int32 hConnection, UInt32[] dwAlarm);
VB.NET	Adp4K_ReadAlarmedSlot(ByVal hConnection As Integer, ByRef nAlarm As UInt32) As Integer
Arguments	<p>hConnection: The handle for a connection.</p> <p>dwAlarm: A pointer to the Alarm slot list. The corresponding bit represents slot position. The wAlarm bit 0 is represented by the first slot and bit 31 is represented by the last slot. The values are: 0: Normal slot. 1: Alarm slot.</p>
Return Value	<p>Succeed MXIO_OK.</p> <p>Fail Refer to Return Codes.</p>

Commands for ioLogik E4200

E42_ReadFirmwareRevision	This function reports the firmware revision for the ioLogik E4200 Network Adapter.
C#	int E42_ReadFirmwareRevision (Int32 hConnection, byte[] bytRevision);
VB.NET	E42_ReadFirmwareRevision(ByVal hConnection As Integer, ByVal bytRevision() As Byte) As Integer
Arguments	<p>hConnection: I/O device handle for a connection.</p> <p>bytRevision: stored ioLogik E4200 firmware revision bytRevision[0] = major (A) bytRevision[1] = minor (B) bytRevision[2] = release (C) bytRevision[3] = build (D) format is A.B.C.D</p>
Return Value	<p>Succeed MXIO_OK.</p> <p>Fail Refer to Return Codes.</p>

E42_ReadFirmwareDate	This function reports firmware release date for the ioLogik E4200 Network Adapter.
C#	int E42_ReadFirmwareDate(Int32 hConnection, UInt16[] wDate);
VB.NET	E42_ReadFirmwareDate(ByVal hConnection As Integer, ByVal iDate() As UInt16) As Integer
Arguments	hConnection: I/O device handle for a connection. wDate: Firmware release date. Ex If Word 0 = 0x0705 , Word 1 = 0x2005 then firmware release date is July 5, 2005
Return Value	Succeed MXIO_OK. Fail Refer to Return Codes.

E42_ReadStatus	This function code is used to read the status of the ioLogik E4200 network adapter.
C#	int E42_ReadStatus(Int32 hConnection, UInt16[] wState, UInt16[] wLastErrorCode);
VB.NET	E42_ReadStatus(ByVal hConnection As Integer, ByRef wState As UInt16, ByRef wLastErrorCode As UInt16) As Integer
Arguments	hConnection: The handle for an I/O device connection. wState: Stores the Bus status in numerical format. The values are: 0: Initial now 1: IO ready 2: Initial fault 3: IO failed wLastErrorCode: Stores the Field Power status in numerical format. The values are: 0: No error -3: No module attached (retry). -4: Set module parameter (need reboot) -5: module worm-up error (need reboot) -30: module configuration error (need reboot)
Return Value	Succeed MXIO_OK. Fail Refer to Return Codes.

E42_ClearStatus	This function code is used to clear the status of the ioLogik E4200 Active Ethernet network adaptors. When changing or removing slots from the E4200, you need to reboot the E4200 after clearing the status.
C#	int E42_ClearStatus (Int32 hConnection);
VB.NET	E42_ClearStatus(ByVal hConnection As Integer) As Integer
Arguments	hConnection: The handle for an I/O device connection.
Return Value	Succeed MXIO_OK. Fail Refer to Return Codes.

E42_ReadSlotAmount	This function code is used to read the number of expansion slots.
C#	int E42_ReadSlotAmount(Int32 hConnection, UInt16[] wAmount);
VB.NET	E42_ReadSlotAmount(ByVal hConnection As Integer, ByRef iAmount As UInt16) As Integer
Arguments	hConnection: The handle for a connection. WAmount: A pointer that stores the number of expansion slots.
Return Value	Succeed MXIO_OK. Fail Refer to Return Codes.

E42_GetInternalRegs	This function code is used to get the internal registers of ioLogik E4200 Active Ethernet network adaptors.
C#	int E42_GetInternalRegs(Int32 hConnection, byte bytStartChannel, byte bytCount, UInt16[] wValue);
VB.NET	E42_GetInternalRegs(ByVal hConnection As Integer, ByVal bytStartChannel As Byte, ByVal bytCount As Byte, ByVal iValue() As UInt16) As Integer
Arguments	<p>hConnection: The handle for a connection.</p> <p>bytStartchannel: Specifies the starting channel.</p> <p>bytCount: The number of channels to be read.</p> <p>wValue: Represents the value of the starting channel. The values are 0 to 255.</p>
Return Value	<p>Succeed MXIO_OK.</p> <p>Fail Refer to Return Codes.</p>

E42_SetInternalRegs	This function code is used to set the internal registers of the ioLogik E4200 network adaptors.
C#	int E42_SetInternalRegs(Int32 hConnection, byte bytStartChannel, byte bytCount, UInt16[] wValue);
VB.NET	E42_SetInternalRegs(ByVal hConnection As Integer, ByVal bytStartChannel As Byte, ByVal bytCount As Byte, ByVal iValue() As UInt16) As Integer
Arguments	<p>hConnection: The handle for an I/O device connection.</p> <p>bytStartchannel: Specifies the starting channel.</p> <p>bytCount: The number of channels to be set (up to 80).</p> <p>wValue: An array that stores contiguous internal register. The values are 0 to 255.</p>
Return Value	<p>Succeed MXIO_OK.</p> <p>Fail Refer to Return Codes.</p>

E42_GetWorkInternalRegs	This function code is used to get the working internal registers of the ioLogik E4200 Active Ethernet network adaptors.
C#	<pre>int E42_GetWorkInternalRegs(Int32 hConnection, byte bytStartChannel, byte bytCount, UInt16[] wValue);</pre>
VB.NET	<pre>E42_GetWorkInternalRegs(ByVal hConnection As Integer, ByVal bytStartChannel As Byte, ByVal bytCount As Byte, ByVal iValue() As UInt16) As Integer</pre>
Arguments	<p>hConnection: The handle for an I/O device connection.</p> <p>bytStartchannel: Specifies the starting channel.</p> <p>bytCount: The number of channels to retrieve (up to 80).</p> <p>wValue: Represents the value of the starting channel. The values are 0 to 255.</p>
Return Value	<p>Succeed MXIO_OK.</p> <p>Fail Refer to Return Codes.</p>

E42_SetWorkInternalRegs	This function code is used to set the working internal registers of the ioLogik E4200 Active Ethernet network adaptors (not saved to flash memory).
C/C++	<pre>int E42_SetWorkInternalRegs(Int32 hConnection, byte bytStartChannel, byte bytCount, UInt16[] wValue);</pre>
VB.NET	<pre>E42_SetWorkInternalRegs(ByVal hConnection As Integer, ByVal bytStartChannel As Byte, ByVal bytCount As Byte, ByVal iValue() As UInt16) As Integer</pre>
Arguments	<p>hConnection: The handle for an I/O device connection.</p> <p>bytStartchannel: Specifies the starting channel.</p> <p>bytCount: The number of channels to be set (up to 80).</p> <p>wValue: An array that stores contiguous internal register. The values are 0 to 255.</p>
Return Value	<p>Succeed MXIO_OK.</p> <p>Fail Refer to Return Codes.</p>

E42_GetIOMapMode	This function code is used to get the IO Modbus addressing map mode of ioLogik E4200 Active Ethernet network adapters.
C#	int E42_GetIOMapMode(Int32 hConnection, UInt16[] wValue);
VB.NET	E42_GetIOMapMode(ByVal hConnection As Integer, ByRef iStatus As UInt16) As Integer
Arguments	<p>hConnection: The handle for a connection.</p> <p>wValue: Stores the specific module's IO image map status. The values are: 0: fix mode 1: dynamic mode</p>
Return Value	<p>Succeed MXIO_OK.</p> <p>Fail Refer to Return Codes.</p>

E42_SetIOMapMode	This function code is used to set the IO Modbus addressing mode of the ioLogik E4200 Active Ethernet network adapters.
C#	int E42_SetIOMapMode(Int32 hConnection, UInt16 wValue);
VB.NET	E42_SetIOMapMode(ByVal hConnection As Integer, ByVal iStatus As UInt16) As Integer
Arguments	<p>hConnection: The handle for a connection.</p> <p>wValue: Stores the specific module's IO image map status. The values are: 0: fix mode 1: dynamic mode</p>
Return Value	<p>Succeed MXIO_OK.</p> <p>Fail Refer to Return Codes.</p>

E42_Modbus_List	This function code is used to get the IO Modbus addressing mode of the ioLogik E4200 Active Ethernet network adaptors.
C#	int E42_Modbus_List(Int32 hConnection, byte[] FilePath);
VB.NET	E42_Modbus_List(ByVal hConnection As Integer, ByVal FilePath() As Byte) As Integer
Arguments	<p>hConnection: The handle for a connection.</p> <p>FilePath: Specific log file path and file name to save module's IO image map list file. Ex. char * FilePath = "c:\\modbus.txt";</p>
Return Value	<p>Succeed MXIO_OK.</p> <p>Fail Refer to Return Codes.</p>

E42_ClearSafeStatus	This function code is used to clear E4200 watchdog status. (Device need reboot after clear watchdog status.)
C#	int E42_ClearWatchdogStatus (Int32 hConnection);
VB.NET	E42_ClearWatchdogStatus (ByVal hConnection As Integer) As Integer
Arguments	<p>hConnection: The handle for a connection.</p>
Return Value	<p>Succeed MXIO_OK.</p> <p>Fail Refer to Return Codes.</p>

Commands for ioLogik W5000

W5K_GetInternalRegs	This function code is used to get the internal registers of ioLogik 5000 Module.
C#	<pre>int W5K_GetInternalRegs (Int32 hConnection, byte bytStartChannel, byte bytCount, UInt16[] wValue);</pre>
VB.NET	<pre>W5K_GetInternalRegs (ByVal hConnection As Integer, ByVal bytStartChannel As Byte, ByVal bytCount As Byte, ByVal wValue() As UInt16) As Integer</pre>
Arguments	<p>hConnection: The handle for a connection.</p> <p>bytStartChannel: Specifies the starting channel.</p> <p>bytCount: The number of channels to be read. (Up to 24)</p> <p>wValue: Represents the value of the starting channel. The values are 0 ~ 255</p>
Return Value	<p>Succeed MXIO_OK.</p> <p>Fail Refer to Return Codes.</p>

W5K_SetInternalRegs	This function code is used to set the internal registers of ioLogik 5000 Module.
C#	int W5K_SetInternalRegs(Int32 hConnection, byte bytStartChannel, byte bytCount, UInt16[] wValue);
VB.NET	W5K_SetInternalRegs (ByVal hConnection As Integer, ByVal bytStartChannel As Byte, ByVal bytCount As Byte, ByVal wValue() As UInt16) As Integer
Arguments	<p>hConnection: The handle for a connection.</p> <p>bytStartChannel: Specifies the starting channel.</p> <p>bytCount: The number of channels to be gets. (Up to 24)</p> <p>wValue: An array that stores contiguous internal register The values are 0 ~ 255</p>
Return Value	<p>Succeed MXIO_OK.</p> <p>Fail Refer to Return Codes.</p>

W5K_GetGprsSignal	This function code is used to get the Click & Go Logic start status of ioLogik 5000 Ethernet Module.
C#	int W5K_GetGprsSignal(Int32 hConnection, UInt16[] wSignal);
VB.NET	W5K_GetGprsSignal (ByVal hConnection As Integer, ByRef wSignal As UInt16) As Integer
Arguments	<p>hConnection: The handle for a connection.</p> <p>iStatus: A pointer that stores the specific module's Click & Go Logic start status. The values are: 0: stop 1: start</p>
Return Value	<p>Succeed MXIO_OK.</p> <p>Fail Refer to Return Codes.</p>

W5K_GetOpcDevicesInfo	This function get ioLogik W5000 Device information that link in A-OPC server.
C#	<pre>int W5K_GetOpcDevicesInfo (byte[] szIP, UInt32 dwTimeOut, UInt16 wDeviceCount, byte[] szDeviceInfo);</pre>
VB.NET	<pre>W5K_GetOpcDevicesInfo (ByVal szIP() As Byte, ByVal nTimeOut As UInt32, ByVal wDeviceCount As UInt16, ByVal szDeviceInfo() As Byte) As Integer</pre>
Arguments	<p>szIP: IP address of the A-OPC Server to be connected.</p> <p>dwTimeOut: Timeout value for establishing a network connection with the ioLogik Ethernet Adapter. The unit is in milliseconds.</p> <p>wDeviceCount: Total amount for the I/O device connected to A-OPC Server. (get from W5K_ListOpcDevices API)</p> <p>szDeviceInfo: Each ioLogik W5000 device status request 12 Bytes</p> <p>IP Address: 4 bytes, start from array [0] MAC Address: 6 Bytes, start from array [4] Online Status: 1 Bytes, start from array [10] UnitID: 1 Bytes, start from array [11]</p>
Return Value	<p>Succeed MXIO_OK.</p> <p>Fail Refer to Return Codes.</p>

W5K_GetOpcAliasName	This function get A-OPC server alias name of the specific ip address device that running A-OPC server.
C#	int W5K_GetOpcAliasName (byte[] szIP, UInt32 dwTimeOut, byte[] szAliasName);
VB.NET	W5K_GetOpcAliasName (ByVal szIP() As Byte, ByVal nTimeOut As UInt32, ByVal szAliasName() As Byte) As Integer
Arguments	szIP: IP address of the A-OPC Server to be connected. dwTimeOut: Timeout value for establishing a network connection with the ioLogik Ethernet Adapter. The unit is in milliseconds. szAliasName: A-OPC Server alias name (MAX: 32 Bytes)
Return Value	Succeed MXIO_OK. Fail Refer to Return Codes.

W5K_ListOpcDevices	This function get amount of ioLogik W5000 that link in A-OPC server.
C#	int W5K_ListOpcDevices (byte[] szIP, UInt32 dwTimeOut, UInt16[] wDeviceCount);
VB.NET	W5K_ListOpcDevices (ByVal szIP() As Byte, ByVal nTimeOut As UInt32, ByRef wDeviceCount As UInt16) As Integer
Arguments	szIP: IP address of the A-OPC Server to be connected. dwTimeOut: Timeout value for establishing a network connection with the ioLogik Ethernet Adapter. The unit is in milliseconds. wDeviceCount: Total amount for the I/O device connected to A-OPC Server.
Return Value	Succeed MXIO_OK. Fail Refer to Return Codes.

W5K_GetSafeStatus	This function code is used to get the safe status of ioLogik 5000 Module.
C#	int W5K_GetSafeStatus(Int32 hConnection, UInt16[] wStatus);
VB.NET	W5K_GetSafeStatus(ByVal hConnection As Integer, ByRef istatus As UInt16) As Integer
Arguments	<p>hConnection: The handle for a connection..</p> <p>wStatus: A pointer that stores the specific module's safe status. The values are: 0: Normal 1: Safe mode</p>
Return Value	<p>Succeed MXIO_OK.</p> <p>Fail Refer to Return Codes.</p>

W5K_ClearSafeStatus	This function code is used to clear the safe status of ioLogik 5000 Module.
C#	int W5K_ClearSafeStatus(Int32 hConnection);
VB.NET	W5K_ClearSafeStatus(ByVal hConnection As Integer) As Integer
Arguments	<p>hConnection: The handle for a connection..</p>
Return Value	<p>Succeed MXIO_OK.</p> <p>Fail Refer to Return Codes.</p>

Commands for ioLogik E1200

E1K_GetSafeStatus	This function code is used to get the safe status of the ioLogik 1200 Module.
C#	int E1K_GetSafeStatus(Int32 hConnection, UInt16[] wStatus);
VB.NET	E1K_GetSafeStatus(ByVal hConnection As Integer, ByRef istatus As UInt16) As Integer
Arguments	<p>hConnection: The handle for a connection..</p> <p>wStatus: A pointer that stores the specific module's safe status. The values are: 0: Normal 1: Safe mode</p>
Return Value	<p>Succeed MXIO_OK.</p> <p>Fail Refer to Return Codes.</p>

E1K_ClearSafeStatus	This function code is used to clear the safe status of the ioLogik 1200 Module.
C#	int E1K_ClearSafeStatus(Int32 hConnection);
VB.NET	E1K_ClearSafeStatus(ByVal hConnection As Integer) As Integer
Arguments	<p>hConnection: The handle for a connection..</p>
Return Value	<p>Succeed MXIO_OK.</p> <p>Fail Refer to Return Codes.</p>

Modbus Command Sets

Four basic Modbus commands are provided in the Modbus command set. However, you must refer to the Modbus reference table in ioAdmin to extract data from the Modbus packet.

MXIO_ReadCoils	This function reads the on/off status for a contiguous group of coils on the same I/O.	
C#	int	MXIO_ReadCoils(Int32 hConnection, byte bytCoilType, UInt16 wStartCoil, UInt16 wCount, byte[] bytCoils);
VB.NET	MXIO_ReadCoils(ByVal ByVal ByVal ByVal ByVal)	hConnection As Integer, bytCoilType As Byte, iStartCoil As UInt16, iCount As UInt16, bytcoils() As Byte) As Integer
Arguments	hConnection: Handle for the I/O connection. bytCoilType: Coil type to be read. 1: read coils (output bit). 2: read discrete (input bit). wStartCoil: Specifies the starting coil address to be read. The address is beginning at 0. wCount: The number of coils to be read. bytCoils: An array that stores the status of register; each byte holds eight coil values. Bit 0 of 1st byte represents 1st coil status.	
Return Value	Succeed MXIO_OK. Fail Refer to Return Codes.	

MXIO_WriteCoils	This function code is used to write the contiguous status of an I/O coils.
C#	int MXIO_WriteCoils(Int32 hConnection, UInt16 wStartCoil, UInt16 wCount, byte[] bytCoils);
VB.NET	MXIO_WriteCoils(ByVal hConnection As Integer, ByVal iwStartCoil As UInt16, ByVal iCount As UInt16, ByVal bytcoils() As Byte) As Integer
Arguments	hConnection: Handle for the I/O connection. wStartCoil: Specifies the starting coil to be written. The address is beginning at 0. wCount: The number of coils to be written. bytCoils: An array that stores the register value; each byte holds eight coil values.
Return Value	Succeed MXIO_OK. Fail Refer to Return Codes.

MXIO_ReadRegs	This function code is used to read the contents of a contiguous block of the I/O holding registers.
C#	int MXIO_ReadRegs(Int32 hConnection, byte bytRegisterType, UInt16 wStartRegister, UInt16 wCount, UInt16[] wRegister);
VB.NET	MXIO_ReadRegs(ByVal hConnection As Integer, ByVal bytRegisterType As Byte, ByVal iStartRegister As UInt16, ByVal iCount As UInt16, ByVal iRegister() As UInt16) As Integer
Arguments	<p>hConnection: The handle for an I/O connection.</p> <p>bytRegisterType: Coil type to be read. The meaning for a value in an entity is as follows: 3: read holding registers (output word). 4: read input register (input word).</p> <p>wStartRegister: Specifies the starting register address. The address is beginning at 0.</p> <p>wCount: The number of coils to be read.</p> <p>wRegister: An array that stores the register values.</p>
Return Value	<p>Succeed MXIO_OK.</p> <p>Fail Refer to Return Codes.</p>

MXIO_WriteRegs	This function code is used to write the contents of a contiguous block of the I/O holding registers.
C#	int MXIO_WriteRegs(Int32 hConnection, UInt16 wStartRegister, UInt16 wCount, UInt16[] wRegister);
VB.NET	MXIO_WriteRegs(ByVal hConnection As Integer, ByVal iStartRegister As UInt16, ByVal iCount As UInt16, ByVal iRegister() As UInt16) As Integer
Arguments	hConnection: The handle for an I/O connection. wStartRegister: Specifies the starting register address. The address begins at 0. wCount: The number of coils to be written. wRegister: An array that stores the register values.
Return Value	Succeed MXIO_OK. Fail Refer to Return Codes.

6

Direct I/O Command Sets

Direct I/O command sets provide an intuitive way to access the data for each channel.

In this chapter, we explain how to control I/O by the .Net library. The ioLogik 4000, E4200, E2000, R2000, W5000, and E1200 are supported in this version. The Direct I/O command sets allow users to access the I/O without any Modbus knowledge.

Digital Input Commands

DI_Reads	This function code is used to read the status of a group of contiguous D/I channels.	
C#	<pre>int DI_Reads(Int32 hConnection, byte bytSlot, byte bytStartChannel, byte bytCount, UInt32[] dwValue);</pre>	
VB.NET	<pre>DI_Reads(ByVal hConnection As Integer, ByVal bytSlot As Byte, ByVal bytStartChannel As Byte, ByVal bytCount As Byte, ByRef nValue As UInt32) As Integer</pre>	
Arguments	<p>hConnection: The handle for an I/O device's connection.</p> <p>bytSlot: Slot number of the I/O module, from 1 to 32. This parameter is inactive for the ioLogik E2000 and R2000.</p> <p>bytStartChannel: Specifies the starting channel.</p> <p>bytCount: The number of channels to read.</p> <p>dwValue: A pointer to the contiguous D/I channel's values; each bit holds the value of one channel. A bit value of 0 represents the digital input status of the start channel. A bit value of 1 represents the second digital input channel's status. The values of the unused bits are random.</p>	
Return Value	<p>Succeed MXIO_OK.</p> <p>Fail Refer to Return Codes.</p>	

DI_Read	This function code is used to read the status of a specific D/I channel.
C#	int DI_Read(Int32 hConnection, byte bytSlot, byte bytChannel, byte[] bytValue);
VB.NET	DI_Read(ByVal hConnection As Integer, ByVal bytSlot As Byte, ByVal bytChannel As Byte, ByRef bytValue As Byte) As Integer
Arguments	<p>hConnection: The handle for an I/O device's connection.</p> <p>bytSlot: Slot number of the I/O module, from 1 to 32. This parameter is inactive for the ioLogik E2000 and R2000.</p> <p>bytChannel: The desired channel.</p> <p>bytValue: A pointer to a specific D/I channel's status.</p>
Return Value	<p>Succeed MXIO_OK.</p> <p>Fail Refer to Return Codes.</p>

Digital Input Commands for ioLogik E2000, R2000

DI2K_GetModes	This function code is used to get the mode of contiguous D/I channels.
C#	<pre>int DI2K_GetModes(Int32 hConnection, byte bytStartChannel, byte bytCount, UInt16[] wMode);</pre>
VB.NET	<pre>DI2K_GetModes(ByVal hConnection As Integer, ByVal bytStartChannel As Byte, ByVal bytCount As Byte, ByVal iMode() As UInt16) As Integer</pre>
Arguments	<p>hConnection: The handle for an I/O device's connection.</p> <p>bytStartChannel: Specifies the starting channel.</p> <p>bytCount: The number of channels to read.</p> <p>wMode: An array that stores the modes of the contiguous D/I channels. wMode[0] represents the value of the starting channel. The values are: 0: D/I Mode. 1: Count Mode.</p>
Return Value	<p>Succeed MXIO_OK.</p> <p>Fail Refer to Return Codes.</p>

DI2K_SetModes	This function code is used to set the mode of contiguous D/I channels.
C#	<pre>int DI2K_SetModes(Int32 hConnection, byte bytStartChannel, byte bytCount, UInt16[] wMode);</pre>
VB.NET	<pre>DI2K_SetModes(ByVal hConnection As Integer, ByVal bytStartChannel As Byte, ByVal bytCount As Byte, ByVal iMode() As UInt16) As Integer</pre>
Arguments	<p>hConnection: The handle for an I/O device's connection.</p> <p>bytStartChannel: Specifies the starting channel.</p> <p>bytCount: The number of channels to set.</p> <p>wMode: An array that stores the modes of the contiguous D/I channels. wMode [0] represents the value of the starting channel. The values are: 0: D/I Mode. 1: Count Mode.</p>
Return Value	<p>Succeed MXIO_OK.</p> <p>Fail Refer to Return Codes.</p>

DI2K_GetMode	This function code is used to get the mode of a specific D/I channel.
C#	int DI2K_GetMode(Int32 hConnection, byte bytChannel, UInt16[] wMode);
VB.NET	DI2K_GetMode(ByVal hConnection As Integer, ByVal bytChannel As Byte, ByVal iMode As UInt16) As Integer
Arguments	<p>hConnection: The handle for an I/O device's connection.</p> <p>bytChannel: The desired channel.</p> <p>wMode: A pointer to the mode of the desired D/I channel. The values are: 0: D/I Mode. 1: Count Mode.</p>
Return Value	<p>Succeed MXIO_OK.</p> <p>Fail Refer to Return Codes.</p>

DI2K_SetMode	This function code is used to set the mode of a specific D/I channel.
C#	int DI2K_SetMode(Int32 hConnection, byte bytChannel, UInt16 wMode);
VB.NET	DI2K_SetMode(ByVal hConnection As Integer, ByVal bytChannel As Byte, ByVal wMode As UInt16) As Integer
Arguments	<p>hConnection: The handle for an I/O device's connection.</p> <p>bytChannel: The desired channel.</p> <p>wMode: A pointer to the mode of the desired D/I channel. The values are: 0: D/I Mode. 1: Count Mode.</p>
Return Value	<p>Succeed MXIO_OK.</p> <p>Fail Refer to Return Codes.</p>

DI2K_GetFilters	This function code is used to get the filter of contiguous D/I channels.
C#	int DI2K_GetFilters(Int32 byte byte UInt16[] hConnection, bytStartChannel, bytCount, wFilter);
VB.NET	DI2K_GetFilters(ByVal ByVal ByVal ByVal hConnection As Integer, bytStartChannel As Byte, bytCount As Byte, iFilter() As UInt16) As Integer
Arguments	<p>hConnection: The handle for an I/O device's connection.</p> <p>bytStartChannel: Specifies the starting channel.</p> <p>bytCount: The number of channels to read.</p> <p>wFilter: An array that stores the filter values of the contiguous D/I channels. wFilter [0] represents the value of the starting channel.</p>
Return Value	<p>Succeed MXIO_OK.</p> <p>Fail Refer to Return Codes.</p>

DI2K_SetFilters	This function code is used to set the filter of contiguous D/I channels.
C#	int DI2K_SetFilters(Int32 byte byte UInt16[] hConnection, bytStartChannel, bytCount, wFilter);
VB.NET	DI2K_SetFilters(ByVal ByVal ByVal ByVal hConnection As Integer, bytStartChannel As Byte, bytCount As Byte, iFilter() As UInt16) As Integer
Arguments	<p>hConnection: The handle for an I/O device's connection.</p> <p>bytStartChannel: Specifies the starting channel.</p> <p>bytCount: The number of channels to set.</p> <p>wFilter: An array that stores the filter values of the contiguous D/I channels. wFilter [0] represents the value of the starting channel.</p>
Return Value	<p>Succeed MXIO_OK.</p> <p>Fail Refer to Return Codes.</p>

DI2K_GetFilter	This function code is used to get the filter of a specific D/I channel.
C#	int DI2K_GetFilter(Int32 hConnection, byte bytChannel, UInt16[] wFilter);
VB.NET	DI2K_GetFilter(ByVal hConnection As Integer, ByVal bytChannel As Byte, ByRef iFilter As UInt16) As Integer
Arguments	hConnection: The handle for an I/O connection. bytChannel: The desired channel. wFilter: A pointer to the filter value of the desired D/I channel.
Return Value	Succeed MXIO_OK. Fail Refer to Return Codes.

DI2K_SetFilter	This function code is used to set the filter of a specific D/I channel.
C#	int DI2K_SetFilter(Int32 hConnection, byte bytChannel, UInt16 wFilter);
VB.NET	DI2K_SetFilter(ByVal hConnection As Integer, ByVal bytChannel As Byte, ByVal iFilter As UInt16) As Integer
Arguments	hConnection: The handle for an I/O connection. bytChannel: The desired channel. wFilter: A pointer to the filter value of the desired D/I channel.
Return Value	Succeed MXIO_OK. Fail Refer to Return Codes.

Digital Input Commands for ioLogik E4200

E42_DI_Reads	This function code is used to read the status of a group of contiguous D/I channels.
C#	<pre>int E42_DI_Reads(Int32 hConnection, byte bytSlot, byte bytStartChannel, byte bytCount, UInt32[] dwValue);</pre>
VB.NET	<pre>E42_DI_Reads(ByVal hConnection As Integer, ByVal bytSlot As Byte, ByVal bytStartChannel As Byte, ByVal bytCount As Byte, ByRef nValue As UInt32) As Integer</pre>
Arguments	<p>hConnection: The handle for an I/O device's connection.</p> <p>bytSlot: Slot number of the I/O module. The Slot number ranges from 1 to 16. But this parameter is inactive on the ioLogik 2000.</p> <p>bytStartchannel: Specifies the starting channel.</p> <p>wCount: The number of channels to be read.</p> <p>dwValue: A pointer that stores the contiguous D/I channel's values; each bit holds one channel value. A bit value of 0 represents the digital input status of the start channel. A bit value of 1 represents the second digital input channel's status. The values of the unused bits are random.</p>
Return Value	<p>Succeed MXIO_OK.</p> <p>Fail Refer to Return Codes.</p>

Digital Input Commands for ioLogik W5000

W5K_DI_GetModes	This function code is used to get the mode of contiguous D/I channels.
C#	<pre>int W5K_DI_GetModes(Int32 hConnection, byte bytStartChannel, byte bytCount, UInt16[] wMode);</pre>
VB.NET	<pre>W5K_DI_GetModes(ByVal hConnection As Integer, ByVal bytStartChannel As Byte, ByVal bytCount As Byte, ByVal iMode() As UInt16) As Integer</pre>
Arguments	<p>hConnection: The handle for an I/O device's connection.</p> <p>bytStartChannel: Specifies the starting channel.</p> <p>bytCount: The number of channels to be gets.</p> <p>wMode: An array that stores contiguous D/I channel's mode. wMode[0] represents the value of the starting channel. The values are:</p> <p>0: D/I Mode</p> <p>1: Count Mode</p>
Return Value	<p>Succeed MXIO_OK.</p> <p>Fail Refer to Return Codes.</p>

W5K_DI_SetModes	This function code is used to set the mode of contiguous D/I channels.
C#	<pre>int W5K_DI_SetModes(Int32 hConnection, byte bytStartChannel, byte bytCount, UInt16[] wMode);</pre>
VB.NET	<pre>W5K_DI_SetModes(ByVal hConnection As Integer, ByVal bytStartChannel As Byte, ByVal bytCount As Byte, ByVal iMode() As UInt16) As Integer</pre>
Arguments	<p>hConnection: The handle for an I/O device's connection.</p> <p>bytStartChannel: Specifies the starting channel.</p> <p>bytCount: The number of channels to be sets.</p> <p>wMode: An array that stores contiguous D/I channel's mode. wMode[0] represents the value of the starting channel. The values are:</p> <p>0: D/I Mode</p> <p>1: Count Mode</p>
Return Value	<p>Succeed MXIO_OK.</p> <p>Fail Refer to Return Codes.</p>

W5K_DI_GetFilters	This function code is used to get the filter of contiguous D/I channels.
C#	<pre>int W5K_DI_GetFilters(Int32 hConnection, byte bytStartChannel, byte bytCount, UInt16[] wFilter);</pre>
VB.NET	<pre>W5K_DI_GetFilters(ByVal hConnection As Integer, ByVal bytStartChannel As Byte, ByVal bytCount As Byte, ByVal iFilter() As UInt16) As Integer</pre>
Arguments	<p>hConnection: The handle for an I/O device's connection.</p> <p>bytStartChannel: Specifies the starting channel.</p> <p>bytCount: The number of channels to be read.</p> <p>wFilter: An array that stores contiguous D/I channel's filter value. wFilter[0] represents the value of the starting channel.</p>
Return Value	<p>Succeed MXIO_OK.</p> <p>Fail Refer to Return Codes.</p>

W5K_DI_SetFilters	This function code is used to set the filter of contiguous D/I channels.
C#	<pre>int W5K_DI_SetFilters(Int32 hConnection, byte bytStartChannel, byte bytCount, UInt16[] wFilter);</pre>
VB.NET	<pre>W5K_DI_SetFilters(ByVal hConnection As Integer, ByVal bytStartChannel As Byte, ByVal bytCount As Byte, ByVal iFilter() As UInt16) As Integer</pre>
Arguments	<p>hConnection: The handle for an I/O device's connection.</p> <p>bytStartChannel: Specifies the starting channel.</p> <p>bytCount: The number of channels to be set.</p> <p>wFilter: An array that stores contiguous D/I channel's filter value. wFilter[0] represents the value of the starting channel.</p>
Return Value	<p>Succeed MXIO_OK.</p> <p>Fail Refer to Return Codes.</p>

W5K_DI_Reads	This function code is used to read the status of a group of contiguous D/I channels.
C#	int W5K_DI_Reads(Int32 hConnection, byte bytStartChannel, byte bytCount, UInt32[] dwValue);
VB.NET	W5K_DI_Reads(ByVal hConnection As Integer, ByVal bytStartChannel As Byte, ByVal bytCount As Byte, ByRef nValue As UInt32) As Integer
Arguments	<p>hConnection: The handle for an I/O device's connection.</p> <p>bytStartChannel: Specifies the starting channel.</p> <p>wCount The number of channels to be read.</p> <p>dwValue: A pointer that stores the contiguous D/I channel's values; each bit holds one channel value. A bit value of 0 represents the digital input status of the start channel. A bit value of 1 represents the second digital input channel's status. The values of the unused bits are random.</p>
Return Value	<p>Succeed MXIO_OK.</p> <p>Fail Refer to Return Codes.</p>

Digital Input Commands for ioLogik E1200

E1K_DI_Reads	This function code is used to read the status of a group of contiguous D/I channels.
C#	int E1K_DI_Reads(Int32 hConnection, byte bytStartChannel, byte bytCount, UInt32[] dwValue);
VB.NET	E1K_DI_Reads(ByVal hConnection As Integer, ByVal bytStartChannel As Byte, ByVal bytCount As Byte, ByRef nValue As UInt32) As Integer
Arguments	<p>hConnection: The handle for an I/O device's connection.</p> <p>bytStartChannel: Specifies the starting channel.</p> <p>wCount The number of channels to be read.</p> <p>dwValue: A pointer that stores the contiguous D/I channel's values; each bit holds one channel value. A bit value of 0 represents the digital input status of the start channel. A bit value of 1 represents the second digital input channel's status. The values of the unused bits are random.</p>
Return Value	<p>Succeed MXIO_OK.</p> <p>Fail Refer to Return Codes.</p>

E1K_DI_GetModes	This function code is used to get the mode of contiguous D/I channels.
C#	<pre>int E1K_DI_GetModes(Int32 hConnection, byte bytStartChannel, byte bytCount, UInt16[] wMode);</pre>
VB.NET	<pre>E1K_DI_GetModes(ByVal hConnection As Integer, ByVal bytStartChannel As Byte, ByVal bytCount As Byte, ByVal iMode() As UInt16) As Integer</pre>
Arguments	<p>hConnection: The handle for an I/O device's connection.</p> <p>bytStartChannel: Specifies the starting channel.</p> <p>bytCount: The number of channels to be read.</p> <p>wMode: An array that stores contiguous D/I channel's mode. wMode[0] represents the value of the starting channel. The values are:</p> <p>0: D/I Mode</p> <p>1: Count Mode</p>
Return Value	<p>Succeed: MXIO_OK.</p> <p>Fail: Refer to Return Codes.</p>

E1K_DI_SetModes	This function code is used to set the mode of contiguous D/I channels.
C#	<pre>int E1K_DI_SetModes(Int32 hConnection, byte bytStartChannel, byte bytCount, UInt16[] wMode);</pre>
VB.NET	<pre>E1K_DI_SetModes(ByVal hConnection As Integer, ByVal bytStartChannel As Byte, ByVal bytCount As Byte, ByVal iMode() As UInt16) As Integer</pre>
Arguments	<p>hConnection: The handle for an I/O device's connection.</p> <p>bytStartChannel: Specifies the starting channel.</p> <p>bytCount: The number of channels to be set.</p> <p>wMode: An array that stores contiguous D/I channel's mode. wMode[0] represents the value of the starting channel. The values are:</p> <p>0: D/I Mode</p> <p>1: Count Mode</p>
Return Value	<p>Succeed: MXIO_OK.</p> <p>Fail: Refer to Return Codes.</p>

E1K_DI_GetFilters	This function code is used to get the filter of contiguous D/I channels.
C#	<pre>int E1K_DI_GetFilters(Int32 hConnection, byte bytStartChannel, byte bytCount, UInt16[] wFilter);</pre>
VB.NET	<pre>E1K_DI_GetFilters(ByVal hConnection As Integer, ByVal bytStartChannel As Byte, ByVal bytCount As Byte, ByVal iFilter() As UInt16) As Integer</pre>
Arguments	<p>hConnection: The handle for an I/O device's connection.</p> <p>bytStartChannel: Specifies the starting channel.</p> <p>bytCount: The number of channels to be read.</p> <p>wFilter: An array that stores contiguous D/I channel's filter value. wFilter[0] represents the value of the starting channel.</p>
Return Value	<p>Succeed: MXIO_OK.</p> <p>Fail: Refer to Return Codes.</p>

E1K_DI_SetFilters	This function code is used to set the filter of contiguous D/I channels.
C#	<pre>int E1K_DI_SetFilters(Int32 hConnection, byte bytStartChannel, byte bytCount, UInt16[] wFilter);</pre>
VB.NET	<pre>E1K_DI_SetFilters(ByVal hConnection As Integer, ByVal bytStartChannel As Byte, ByVal bytCount As Byte, ByVal iFilter() As UInt16) As Integer</pre>
Arguments	<p>hConnection: The handle for an I/O device's connection.</p> <p>bytStartChannel: Specifies the starting channel.</p> <p>bytCount: The number of channels to be set.</p> <p>wFilter: An array that stores contiguous D/I channel's filter value. wFilter[0] represents the value of the starting channel.</p>
Return Value	<p>Succeed: MXIO_OK.</p> <p>Fail: Refer to Return Codes.</p>

Counter Commands for ioLogik E2000, R2000

Cnt2K_Reads	This function code is used to read the counter values of contiguous D/I channels in Count mode.
C#	int Cnt2K_Reads(Int32 hConnection, byte bytStartChannel, byte bytCount, UInt32[] dwValue);
VB.NET	Cnt2K_Reads(ByVal hConnection As Integer, ByVal bytStartChannel As Byte, ByVal bytCount As Byte, ByVal nValue() As UInt32) As Integer
Arguments	<p>hConnection: The handle for an I/O device's connection.</p> <p>bytStartChannel: Specifies the starting channel.</p> <p>bytCount: The number of channels to read.</p> <p>dwValue: An array that stores the counter values of the contiguous channels, dwValue[0] represents the value of the starting channel.</p>
Return Value	<p>Succeed MXIO_OK.</p> <p>Fail Refer to Return Codes.</p>

Cnt2K_Clears	This function code is used to clear the counter values of contiguous D/I channels in Count mode.
C#	int Cnt2K_Clears(Int32 hConnection, byte bytStartChannel, byte bytCount);
VB.NET	Cnt2K_Clears(ByVal hConnection As Integer, ByVal bytStartChannel As Byte, ByVal bytCount As Byte) As Integer
Arguments	<p>hConnection: The handle for an I/O device's connection.</p> <p>bytStartChannel: Specifies the starting channel.</p> <p>bytCount: The number of channels to clear.</p>
Return Value	<p>Succeed MXIO_OK.</p> <p>Fail Refer to Return Codes.</p>

Cnt2K_Read	This function code is used to read the counter value of a specific D/I channel in Count mode.	
C#	int Cnt2K_Read(Int32	hConnection,
	byte	bytChannel,
	UInt32[]	dwValue);
VB.NET	Cnt2K_Read(ByVal	hConnection As Integer,
	ByVal	bytChannel As Byte,
	ByRef	nValue As UInt32) As Integer
Arguments	hConnection:	The handle for an I/O device's connection.
	bytChannel:	The specific channel to be read.
	dwValue:	A pointer that stores the count value for specific channel.
Return Value	Succeed	MXIO_OK.
	Fail	Refer to Return Codes.

Cnt2K_Clear	This function code is used to clear the counter value of a specific D/I channel in Count mode.	
C#	int Cnt2K_Clear(Int32	hConnection,
	byte	bytChannel);
VB.NET	Cnt2K_Clear(ByVal	hConnection As Integer,
	ByVal	bytChannel As Byte) As Integer
Arguments	hConnection:	The handle for an I/O device connection.
	bytChannel:	The specific channel to be clear.
Return Value	Succeed	MXIO_OK.
	Fail	Refer to Return Codes.

Cnt2K_GetOverflows	This function code is used to get the overflow statuses of contiguous D/I channels in Count mode.
C#	int Cnt2K_GetOverflows(Int32 hConnection, byte bytStartChannel, byte bytCount, UInt32[] dwStatus);
VB.NET	Cnt2K_GetOverflows(ByVal hConnection As Integer, ByVal bytStartChannel As Byte, ByVal bytCount As Byte, ByRef nStatus As UInt32) As Integer
Arguments	<p>hConnection: The handle for an I/O device connection.</p> <p>bytStartChannel: Specifies the starting channel.</p> <p>bytCount: The number of channels to be get.</p> <p>dwStatus: A pointer that stores the contiguous channel's overflow status; each bit holds one channel status. A bit value of 0 represents the status of the start channel. A bit value of 1 represents the second channel's status. The values are :</p> <p>0: Normal 1: Overflow</p>
Return Value	<p>Succeed MXIO_OK.</p> <p>Fail Refer to Return Codes.</p>

Cnt2K_ClearOverflows	This function code is used to clear the overflow statuses of contiguous D/I channels in Count mode.
C#	int Cnt2K_ClearOverflows(Int32 hConnection, byte bytStartChannel, byte bytCount);
VB.NET	Cnt2K_ClearOverflows(ByVal hConnection As Integer, ByVal bytStartChannel As Byte, ByVal bytCount As Byte) As Integer
Arguments	<p>hConnection: The handle for an I/O device connection.</p> <p>bytStartChannel: Specifies the starting channel.</p> <p>bytCount: The number of channels to be clear.</p>
Return Value	<p>Succeed MXIO_OK.</p> <p>Fail Refer to Return Codes.</p>

Cnt2K_GetOverflow	This function code is used to get the overflow status of a specific D/I channel in Count mode.
C#	int Cnt2K_GetOverflow(Int32 hConnection, byte bytChannel, byte[] bytStatus);
VB.NET	Cnt2K_GetOverflow(ByVal hConnection As Integer, ByVal bytChannel As Byte, ByRef bytStatus As Byte) As Integer
Arguments	<p>hConnection: The handle for an I/O device connection.</p> <p>bytChannel: The specific channel to be get.</p> <p>bytStatus: A pointer that stores the overflow status for specific channel. The values are :</p> <p>0: Normal</p> <p>1: Overflow</p>
Return Value	<p>Succeed MXIO_OK.</p> <p>Fail Refer to Return Codes.</p>

Cnt2K_ClearOverflow	This function code is used to clear the overflow status of a specific D/I channel in Count mode.
C#	int Cnt2K_ClearOverflow(Int32 hConnection, byte bytChannel);
VB.NET	Cnt2K_ClearOverflow(ByVal hConnection As Integer, ByVal bytChannel As Byte) As Integer
Arguments	<p>hConnection: The handle for an I/O device connection.</p> <p>bytChannel: The specific channel to be clear.</p>
Return Value	<p>Succeed MXIO_OK.</p> <p>Fail Refer to Return Codes.</p>

Cnt2K_GetFilters	This function code is used to get the filter value of contiguous D/I channels in Count mode.
C#	int Cnt2K_GetFilters(Int32 byte byte UInt16[] hConnection, byStartChannel, bytCount, wFilter);
VB.NET	Cnt2K_GetFilters(ByVal ByVal ByVal ByVal hConnection As Integer, byStartChannel As Byte, bytCount As Byte, iFilter() As UInt16) As Integer
Arguments	hConnection: The handle for an I/O device connection. byStartChannel: Specifies the starting channel. bytCount: The number of channels to be gets. wFilter: An array that stores the filter values for the contiguous D/I channels.
Return Value	Succeed MXIO_OK. Fail Refer to Return Codes.

Cnt2K_SetFilters	This function code is used to set the filter values of contiguous D/I channels in Count mode.
C#	int Cnt2K_SetFilters(Int32 byte byte UInt16[] hConnection, byStartChannel, bytCount, wFilter);
VB.NET	Cnt2K_SetFilters(ByVal ByVal ByVal ByVal hConnection As Integer, byStartChannel As Byte, bytCount As Byte, iFilter() As UInt16) As Integer
Arguments	hConnection: The handle for an I/O device connection. byStartChannel: Specifies the starting channel. bytCount: The number of channels to be set. wFilter: An array that stores the filter values for the contiguous D/I channels.
Return Value	Succeed MXIO_OK. Fail Refer to Return Codes.

Cnt2K_GetFilter	This function code is used to get the filter value of a specific D/I channel in Counter mode.
C#	int Cnt2K_GetFilter(Int32 hConnection, byte bytChannel, UInt16[] wFilter);
VB.NET	Cnt2K_GetFilter(ByVal hConnection As Integer, ByVal bytChannel As Byte, ByRef iFilter As UInt16) As Integer
Arguments	hConnection: The handle for an I/O device connection. bytChannel: The specific channel to be get. wFilter: A pointer that stored the filter value
Return Value	Succeed MXIO_OK. Fail Refer to Return Codes.

Cnt2K_SetFilter	This function code is used to set the filter value of a specific D/I channel in Count mode.
C#	int Cnt2K_SetFilter(Int32 hConnection, byte bytChannel, UInt16 wFilter);
VB.NET	Cnt2K_SetFilter(ByVal hConnection As Integer, ByVal bytChannel As Byte, ByVal iFilter As UInt16) As Integer
Arguments	hConnection: The handle for an I/O device connection. bytChannel: The specific channel to be set. wFilter: Stored the filter value.
Return Value	Succeed MXIO_OK. Fail Refer to Return Codes.

Cnt2K_GetStartStatuses	This function code is used to get the start statuses of contiguous D/I channels in Count mode.
C#	int Cnt2K_GetStartStatuses(Int32 byte byte UInt32[] hConnection, bytStartChannel, bytCount, dwStatus);
VB.NET	Cnt2K_GetStartStatuses(ByVal ByVal ByVal ByRef hConnection As Integer, bytStartChannel As Byte, bytCount As Byte, nStatus As UInt32) As Integer
Arguments	<p>hConnection: The handle for an I/O device connection.</p> <p>bytStartChannel: Specifies the starting channel.</p> <p>bytCount: The number of channels to be set.</p> <p>dwStatus: A pointer to the start statuses of the contiguous D/I channel's; each bit holds the start status of one channel. A bit value of 0 represents the status of the start channel. A bit value of 1 represents the second channel's status. The values are :</p> <p>0: stop 1: start</p>
Return Value	<p>Succeed MXIO_OK.</p> <p>Fail Refer to Return Codes.</p>

Cnt2K_SetStartStatuses	This function code is used to set the start statuses of contiguous D/I channels in Count mode.
C#	int Cnt2K_SetStartStatuses(Int32 hConnection, byte bytStartChannel, byte bytCount, UInt32 dwStatus);
VB.NET	Cnt2K_SetStartStatuses(ByVal hConnection As Integer, ByVal bytStartChannel As Byte, ByVal bytCount As Byte, ByVal nStatus As UInt32) As Integer
Arguments	<p>hConnection: The handle for an I/O device connection.</p> <p>bytStartChannel: Specifies the starting channel.</p> <p>bytCount: The number of channels to be set.</p> <p>dwStatus: A pointer to the start statuses of the contiguous D/I channel's; each bit holds the start status of one channel. A bit value of 0 represents the status of the start channel. A bit value of 1 represents the second channel's status. The values are :</p> <p>0: stop 1: start</p>
Return Value	<p>Succeed MXIO_OK.</p> <p>Fail Refer to Return Codes.</p>

Cnt2K_GetStartStatus	This function code is used to get the start status of a specific D/I channel in Count mode.	
C#	int Cnt2K_GetStartStatus(Int32	hConnection,
	byte	bytChannel,
	byte[]	bytStatus);
VB.NET	Cnt2K_GetStartStatus(ByVal	hConnection As Integer,
	ByVal	bytChannel As Byte,
	ByRef	bytStatus As Byte)
		As Integer
Arguments	hConnection:	The handle for an I/O device connection.
	bytChannel:	The specific channel to be get.
	bytStatus:	A pointer that stores the specific count channel's start status. The values are :
		0 : stop
		1 : start
Return Value	Succeed	MXIO_OK.
	Fail	Refer to Return Codes.

Cnt2K_SetStartStatus	This function code is used to set the start status of a specific D/I channel in Count mode.	
C#	int Cnt2K_SetStartStatus(Int32	hConnection,
	byte	bytChannel,
	byte	bytStatus);
VB.NET	Cnt2K_SetStartStatus(ByVal	hConnection As Integer,
	ByVal	bytChannel As Byte,
	ByVal	bytStatus As Byte)
		As Integer
Arguments	hConnection:	The handle for an I/O device connection.
	bytChannel:	The specific channel to be set.
	bytStatus:	A pointer that stores the specific count channel's start status. The values are :
		0: stop
		1: start
Return Value	Succeed	MXIO_OK.
	Fail	Refer to Return Codes.

Cnt2K_GefTriggerTypes	This function code is used to get the trigger types of contiguous D/I channels in Count mode.
C#	<pre>int Cnt2K_GetTriggerTypes(Int32 hConnection, byte bytStartChannel, byte bytCount, UInt32[] dwType);</pre>
VB.NET	<pre>Cnt2K_GetTriggerTypes(ByVal hConnection As Integer, ByVal bytStartChannel As Byte, ByVal bytCount As Byte, ByRef nType As UInt32) As Integer</pre>
Arguments	<p>hConnection: The handle for an I/O device connection.</p> <p>bytStartChannel: Specifies the starting channel.</p> <p>bytCount: The number of channels to be get.</p> <p>dwType: A pointer that stores the contiguous channel's triggers types; each bit holds one channel trigger type. A bit value of 0 represents the trigger type of the start channel. A bit value of 1 represents the second channel's trigger type. The values are :</p> <p>0: LoToHi 1: HiToLo</p>
Return Value	<p>Succeed MXIO_OK.</p> <p>Fail Refer to Return Codes.</p>

Cnt2K_SetTriggerTypes	This function code is used to set the trigger types of contiguous D/I channels in Count mode.
C#	<pre>int Cnt2K_SetTriggerTypes(Int32 hConnection, byte bytStartChannel, byte bytCount, UInt32 dwType);</pre>
VB.NET	<pre>Cnt2K_SetTriggerTypes(ByVal hConnection As Integer, ByVal bytStartChannel As Byte, ByVal bytCount As Byte, ByVal nType As UInt32) As Integer</pre>
Arguments	<p>hConnection: The handle for an I/O device connection.</p> <p>bytStartChannel: Specifies the starting channel.</p> <p>bytCount: The number of channels to be clear.</p> <p>dwType: Stores the trigger types of the contiguous channels; each bit holds the trigger type of one channel. A bit value of 0 represents the trigger type of the start channel. A bit value of 1 represents the second channel's trigger type. The values are : 0: LoToHi 1: HiToLo</p>
Return Value	<p>Succeed MXIO_OK.</p> <p>Fail Refer to Return Codes.</p>

Cnt2K_GetTriggerType	This function code is used to get the trigger type of a specific D/I channel in Count mode.
C#	int Cnt2K_GetTriggerType(Int32 hConnection, byte bytChannel, byte[] bytType);
VB.NET	Cnt2K_GetTriggerType(ByVal hConnection As Integer, ByVal bytChannel As Byte, ByVal bytType As Byte) As Integer
Arguments	<p>hConnection: The handle for an I/O device connection.</p> <p>bytChannel: The specific channel to be get.</p> <p>bytType: A pointer to the trigger type for a specific channel. The values are: 0 : LoToHi 1 : HiToLo</p>
Return Value	<p>Succeed MXIO_OK.</p> <p>Fail Refer to Return Codes.</p>

Cnt2K_SetTriggerType	This function code is used to set the trigger type of a specific D/I channel in Count mode.
C#	int Cnt2K_SetTriggerType(Int32 hConnection, byte bytChannel, byte bytType);
VB.NET	Cnt2K_SetTriggerType(ByVal hConnection As Integer, ByVal bytChannel As Byte, ByVal bytType As Byte) As Integer
Arguments	<p>hConnection: The handle for an I/O device connection.</p> <p>bytChannel: The Specific channel to be set.</p> <p>bytType: Stores the trigger type for specific channel. The values are: 0 : LoToHi 1 : HiToLo</p>
Return Value	<p>Succeed MXIO_OK.</p> <p>Fail Refer to Return Codes.</p>

Cnt2K_GetPowerOnValues	This function code is used to get the power on values of contiguous D/I channels in Count mode.
C#	int Cnt2K_GetPowerOnValues(Int32 hConnection, byte bytStartChannel, byte bytCount, UInt32[] dwValue);
VB.NET	Cnt2K_GetPowerOnValues(ByVal hConnection As Integer, ByVal bytStartChannel As Byte, ByVal bytCount As Byte, ByRef nValue As UInt32) As Integer
Arguments	<p>hConnection: The handle for an I/O device connection.</p> <p>bytStartChannel: Specifies the starting channel.</p> <p>bytCount: The number of channels to be get.</p> <p>dwValue: A pointer that stores the contiguous channel's power on values; each bit holds one channel power on value. A bit value of 0 represents the power on value of the start channel. A bit value of 1 represents the second channel's power on value. The values are :</p> <p>0: OFF 1: ON</p>
Return Value	<p>SucceedS MXIO_OK.</p> <p>Fail Refer to Return Codes.</p>

Cnt2K_SetPowerOnValues	This function code is used to set the power on values of contiguous D/I channels in Count mode.
C#	<pre>int Cnt2K_SetPowerOnValues(Int32 hConnection, byte bytStartChannel, byte bytCount, UInt32 dwValue);</pre>
VB.NET	<pre>Cnt2K_SetPowerOnValues(ByVal hConnection As Integer, ByVal bytStartChannel As Byte, ByVal bytCount As Byte, ByVal nValue As UInt32) As Integer</pre>
Arguments	<p>hConnection: The handle for an I/O device connection.</p> <p>bytStartChannel: Specifies the starting channel.</p> <p>bytCount: The number of channels to be set.</p> <p>dwValue: Stored the power on values for the contiguous channel's; each bit holds the power on value of one channel. A bit value of 0 represents the power on value of the start channel. A bit value of 1 represents the second channel's power on value. The values are: 0: OFF 1: ON</p>
Return Value	<p>Succeed MXIO_OK.</p> <p>Fail Refer to Return Codes.</p>

Cnt2K_GetPowerOnValue	This function code is used to get power on values when specific D/I channel in Count mode.
C#	int Cnt2K_GetPowerOnValue(Int32 hConnection, byte bytChannel, byte[] bytValue);
VB.NET	Cnt2K_GetPowerOnValue(ByVal hConnection As Integer, ByVal bytChannel As Byte, ByRef bytValue As Byte) As Integer
Arguments	<p>hConnection: The handle for an I/O device connection.</p> <p>bytChannel: The specific channel to be get.</p> <p>bytValue: A pointer to the power on value for specific channel. The values are: 0: OFF 1: ON</p>
Return Value	<p>Succeed MXIO_OK.</p> <p>Fail Refer to Return Codes.</p>

Cnt2K_SetPowerOnValue	This function code is used to set the power on value of a specific D/I channel in Count mode.
C#	int Cnt2K_SetPowerOnValue(Int32 hConnection, byte bytChannel, byte bytValue);
VB.NET	Cnt2K_SetPowerOnValue(ByVal hConnection As Integer, ByVal bytChannel As Byte, ByVal bytValue As Byte) As Integer
Arguments	<p>hConnection: The handle for an I/O device connection.</p> <p>bytChannel: The specific channel to be set.</p> <p>bytValue: Stores the power on value for the specific channel. The values are: 0: OFF 1: ON</p>
Return Value	<p>Succeed MXIO_OK.</p> <p>Fail Refer to Return Codes.</p>

Cnt2K_GetSafeValues	This function code is used to get the safe values of contiguous D/I channels in Count mode.
C#	<pre> Cnt2K_GetSafeValues(Int32 hConnection, Byte bytStartChannel, Byte bytCount, UInt32[] dwValue);</pre>
VB.NET	<pre> Cnt2K_GetSafeValues(ByVal Connection As Integer, ByVal ytStartChannel As Byte, ByVal ytCount As Byte, ByRef Value As UInt32) As Integer</pre>
Arguments	<p>Connection: The handle for an I/O device connection</p> <p>bytStartChannel: Specifies the starting channel.</p> <p>bytCount: The number of channels to be get.</p> <p>dwValue: A pointer to the safe values; each bit holds the safe value of one channel. A bit value of 0 represents the safe value of the start channel. A bit value of 1 represents the second channel's safe value. The values are: 0: OFF 1: ON</p>
Return Value	<p>Succeed MXIO_OK.</p> <p>Fail Refer to Return Codes.</p>

Cnt2K_SetSafeValues	This function code is used to set the safe values of contiguous D/I channels in Count mode.
C#	<pre>Cnt2K_SetSafeValues(Int32 hConnection, Byte bytStartChannel, Byte bytCount, UInt32 dwValue);</pre>
VB.NET	<pre>Cnt2K_SetSafeValues(ByVal hConnection As Integer, ByVal bytStartChannel As Byte, ByVal bytCount As Byte, ByVal nValue As UInt32) As Integer</pre>
Arguments	<p>hConnection: The handle for an I/O device connection.</p> <p>bytStartChannel: Specifies the starting channel.</p> <p>bytCount: The number of channels to be set.</p> <p>dwValue: Stored the safe values of the contiguous channels; each bit holds the safe value of one channel. A bit value of 0 represents the safe value of the start channel. A bit value of 1 represents the second channel's safe value.</p> <p>The values are: 0: OFF 1: ON</p>
Return Value	<p>Succeed MXIO_OK.</p> <p>Fail Refer to Return Codes.</p>

Cnt2K_GetSafeValue	This function code is used to get the safe value of a specific D/I channel in Count mode.	
C#	Cnt2K_GetSafeValue(Int32	hConnection,
	Byte	bytChannel,
	byte[]	bytValue);
VB.NET	Cnt2K_GetSafeValue(ByVal	hConnection As Integer,
	ByVal	bytChannel As Byte,
	ByRef	bytValue As Byte)
		As Integer
Arguments	hConnection:	The handle for an I/O device connection.
	bytChannel:	The specific channel to be get.
	bytValue:	A pointer to the safe value of the specific channel. The values are: 0: OFF 1: ON
Return Value	Succeed	MXIO_OK.
	Fail	Refer to Return Codes.

Cnt2K_SetSafeValue	This function code is used to set the safe value of a specific D/I channel in Count mode.	
C#	Cnt2K_SetSafeValue(Int32	hConnection,
	Byte	bytChannel,
	Byte	bytValue);
VB.NET	Cnt2K_SetSafeValue(ByVal	hConnection As Integer,
	ByVal	bytChannel As Byte,
	ByVal	bytValue As Byte) As Integer
Arguments	hConnection:	The handle for an I/O device connection.
	bytChannel:	The specific channel to be set.
	bytType:	Stores the safe value for the specific channel. The values are: 0: OFF 1: ON
Return Value	Succeed	MXIO_OK.
	Fail	Refer to Return Codes.

Cnt2K_GefTriggerTypeWords	This function code is used to get trigger types for contiguous channels when the D/I channel is in Count mode.
C#	Cnt2K_GetTriggerTypeWords(Int32 hConnection, Byte bytStartChannel, Byte bytCount, UInt16[] wType);
VB.NET	Cnt2K_GetTriggerTypeWords(ByVal hConnection As Integer, ByVal bytStartChannel As Byte, ByVal bytCount As Byte, ByVal iType() As UInt16) As Integer
Arguments	<p>hConnection: The handle for an I/O device connection.</p> <p>bytStartChannel: Specifies the starting channel.</p> <p>bytCount: The number of channels to be get.</p> <p>wType: A pointer that stores the trigger types for contiguous channels; each bit holds one channel trigger type. A bit value of 0 represents the trigger type of the start channel. A bit value of 1 represents the second channel's trigger type. The values are:</p> <p>0: LoToHi 1: HiToLo 2: Both</p>
Return Value	<p>Succeed MXIO_OK.</p> <p>Fail Refer to Return Codes.</p>

Cnt2K_SetTriggerTypeWords	This function code is used to set trigger types for contiguous channels when the D/I channel is in Count mode.
C#	<pre> Cnt2K_SetTriggerTypeWords(Int32 hConnection, Byte bytStartChannel, Byte bytCount, UInt16[] wType); </pre>
VB.NET	<pre> Cnt2K_SetTriggerTypeWords(ByVal hConnection As Integer, ByVal bytStartChannel As Byte, ByVal bytCount As Byte, ByVal iType() As UInt16) As Integer </pre>
Arguments	<p>hConnection: The handle for an I/O device connection.</p> <p>bytStartChannel: Specifies the starting channel.</p> <p>bytCount: The number of channels to be set.</p> <p>wType: A pointer that stores the trigger types for contiguous channels; each bit holds one channel trigger type. A bit value of 0 represents the trigger type of the start channel. A bit value of 1 represents the second channel's trigger type. The values are:</p> <ul style="list-style-type: none"> 0: LoToHi 1: HiToLo 2: Both
Return Value	<p>Succeed MXIO_OK.</p> <p>Fail Refer to Return Codes.</p>

Cnt2K_GetTriggerTypeWord	This function code is used to get contiguous channel's trigger types when D/I channel is in Count mode.	
C#	Cnt2K_GetTriggerTypeWord(Int32	hConnection,
	Byte	bytChannel,
	UInt16[]	wType);
VB.NET	Cnt2K_GetTriggerTypeWord(ByVal	hConnection As
	Integer,	Integer,
	ByVal	bytChannel As
	Byte,	Byte,
	ByRef	iType As UInt16)
		As Integer
Arguments	hConnection:	The handle for an I/O device connection.
	bytChannel:	The specific channel to be get.
	wType:	A pointer that stores the trigger type for a specific channel. The values are :
		0: LoToHi
		1: HiToLo
		2: Both
Return Value	Succeed	MXIO_OK.
	Fail	Refer to Return Codes.

Cnt2K_SetTriggerTypeWord	This function code is used to get contiguous channel's trigger types when D/I channel is in Count mode.	
C#	Cnt2K_SetTriggerTypeWord(Int32	hConnection,
	Byte	bytChannel,
	UInt16	wType);
VB.NET	Cnt2K_SetTriggerTypeWord(ByVal	hConnection As Integer,
	ByVal	Integer,
	ByVal	bytChannel As Byte,
	ByVal	wType As UInt16)
		As Integer
Arguments	hConnection:	The handle for an I/O device connection.
	bytChannel:	The specific channel to be set.
	wType:	Stores the trigger type for a specific channel. The values are :
		0: LoToHi
		1: HiToLo
		2: Both
Return Value	Success	MXIO_OK.
	Fail	Refer to Return Codes.

Cnt2K_SetSaveStatusesOnPowerFail	This function code is used to set contiguous channel's DI/DO mode power off storage enable mode.
C#	<pre>int Cnt2K_SetSaveStatusesOnPowerFail (Int32 hConnection, byte bytStartChannel, byte bytCount, UInt32 dwMode);</pre>
VB.NET	<pre>Cnt2K_SetSaveStatusesOnPowerFail (ByVal hConnection As Integer, ByVal bytStartChannel As Byte, ByVal bytCount As Byte, ByVal nMode As UInt32) As Integer</pre>
Arguments	<p>hConnection: The handle for an I/O device connection.</p> <p>bytStartChannel: Specifies the starting channel.</p> <p>bytCount: The number of channels to be set.</p> <p>dwStatus: A pointer that stores the contiguous channel's DI/DO mode; each bit holds one channel status. A bit value of 0 represents the status of the start channel. A bit value of 1 represents the second channel's status. The values are :</p> <p>0: ON, 1: OFF</p>
Return Value	<p>Succeed MXIO_OK.</p> <p>Fail Refer to Return Codes.</p>

Cnt2K_SetSaveStatusesOnPowerFail	This function code is used to set contiguous channel's DI/DO mode power off storage enable mode.
C#	<pre>int Cnt2K_SetSaveStatusesOnPowerFail (Int32 hConnection, byte bytStartChannel, byte bytCount, UInt32 dwMode);</pre>
VB.NET	<pre>Cnt2K_SetSaveStatusesOnPowerFail (ByVal hConnection As Integer, ByVal bytStartChannel As Byte, ByVal bytCount As Byte, ByVal nMode As UInt32) As Integer</pre>
Arguments	<p>hConnection: The handle for an I/O device connection.</p> <p>bytStartChannel: Specifies the starting channel.</p> <p>bytCount: The number of channels to be set.</p> <p>dwStatus: A pointer that stores the contiguous channel's DI/DO mode; each bit holds one channel status. A bit value of 0 represents the status of the start channel. A bit value of 1 represents the second channel's status. The values are :</p> <p style="padding-left: 40px;">0: ON, 1: OFF</p>
Return Value	<p>Succeed MXIO_OK.</p> <p>Fail Refer to Return Codes.</p>

Counter Commands for ioLogik 5000

W5K_Cnt_Reads	This function code is used to read contiguous channel's count value when D/I channels in "Count" mode.	
C#	int W5K_Cnt_Reads(Int32	hConnection,
	byte	bytStartChannel,
	byte	bytCount,
	UInt32[]	dwValue);
VB.NET	W5K_Cnt_Reads(ByVal	hConnection As Integer,
	ByVal	bytStartChannel As Byte,
	ByVal	bytCount As Byte,
	ByVal	nValue() As UInt32) As Integer
Arguments	<p>hConnection: The handle for an I/O device's connection.</p> <p>bytStartChannel: Specifies the starting channel.</p> <p>bytCount: The number of channels to be read.</p> <p>dwValue: An array that stores the contiguous channel's count value, dwValue[0] represents the value of the starting channel.</p>	
Return Value	<p>Succeed MXIO_OK.</p> <p>Fail Refer to Return Codes.</p>	

W5K_Cnt_Clears	This function code is used to clear contiguous channel's count value when D/I channel in "Count" mode.	
C#	int W5K_Cnt_Clears(Int32	hConnection,
	byte	bytStartChannel,
	byte	bytCount);
VB.NET	W5K_Cnt_Clears(ByVal	hConnection As Integer,
	ByVal	bytStartChannel As Byte,
	ByVal	bytCount As Byte) As Integer
Arguments	<p>hConnection: The handle for an I/O device's connection.</p> <p>bytStartChannel: Specifies the starting channel.</p> <p>bytCount: The number of channels to be clear.</p>	
Return Value	<p>Succeed MXIO_OK.</p> <p>Fail Refer to Return Codes.</p>	

W5K_Cnt_GetOverflows	This function code is used to get contiguous channel's overflow status when D/I channel in "Count" mode.
C#	int W5K_Cnt_GetOverflows(Int32 byte byte UInt32[] hConnection, bytStartChannel, bytCount, dwStatus);
VB.NET	W5K_Cnt_GetOverflows(ByVal ByVal ByVal ByRef hConnection As Integer, bytStartChannel As Byte, bytCount As Byte, nStatus As UInt32) As Integer
Arguments	<p>hConnection: The handle for an I/O device connection.</p> <p>bytStartChannel: Specifies the starting channel.</p> <p>bytCount: The number of channels to be get.</p> <p>dwStatus: A pointer that stores the contiguous channel's overflow status; each bit holds one channel status. A bit value of 0 represents the status of the start channel. A bit value of 1 represents the second channel's status. The values are :</p> <p>0: Normal</p> <p>1: Overflow</p>
Return Value	<p>Succeed MXIO_OK.</p> <p>Fail Refer to Return Codes.</p>

W5K_Cnt_ClearOverflows	This function code is used to clear contiguous channel's overflow status when D/I channel in "Count" mode.	
C#	int W5K_Cnt_ClearOverflows(Int32	hConnection,
	byte	bytStartChannel,
	byte	bytCount);
VB.NET	W5K_Cnt_ClearOverflows(ByVal	hConnection As Integer,
	ByVal	bytStartChannel As Byte,
	ByVal	bytCount As Byte) As
		Integer
Arguments	hConnection:	The handle for an I/O device connection.
	bytStartChannel:	Specifies the starting channel.
	bytCount:	The number of channels to be clear.
Return Value	Succeed	MXIO_OK.
	Fail	Refer to Return Codes.

W5K_Cnt_GetFilters	This function code is used to get contiguous channel's filter value when D/I channel in "Count" mode.	
C#	int W5K_Cnt_GetFilters(Int32	hConnection,
	byte	bytStartChannel, \
	byte	bytCount,
	UInt16[]	wFilter);
VB.NET	W5K_Cnt_GetFilters(ByVal	hConnection As Integer,
	ByVal	bytStartChannel As Byte,
	ByVal	bytCount As Byte,
	ByVal	iFilter() As UInt16) As
		Integer
Arguments	hConnection:	The handle for an I/O device connection.
	bytStartChannel:	Specifies the starting channel.
	bytCount:	The number of channels to be gets.
	wFilter:	An array that stored the filter value for contiguous D/I channel.
Return Value	Succeed	MXIO_OK.
	Fail	Refer to Return Codes.

W5K_Cnt_SetFilters	This function code is used to set contiguous channel's filter value when D/I channel in "Count" mode.	
C#	int W5K_Cnt_SetFilters(Int32 byte byte UInt16[]	hConnection, bytStartChannel, bytCount, wFilter);
VB.NET	W5K_Cnt_SetFilters(ByVal ByVal ByVal ByVal	hConnection As Integer, bytStartChannel As Byte, bytCount As Byte, iFilter() As UInt16) As Integer
Arguments	<p>hConnection: The handle for an I/O device connection.</p> <p>bytStartChannel: Specifies the starting channel.</p> <p>bytCount: The number of channels to be set.</p> <p>wFilter: An array that stored the filter value for contiguous D/I channel.</p>	
Return Value	<p>Succeed MXIO_OK.</p> <p>Fail Refer to Return Codes.</p>	

W5K_Cnt_GetStartStatuses	This function code is used to get contiguous channel's start status when D/I channel in "Count" mode.
C#	<pre>int W5K_Cnt_GetStartStatuses(Int32 hConnection, byte bytStartChannel, byte bytCount, UInt32[] dwStatus);</pre>
VB.NET	<pre>W5K_Cnt_GetStartStatuses(ByVal hConnection As Integer, ByVal bytStartChannel As Byte, ByVal bytCount As Byte, ByRef nStatus As UInt32) As Integer</pre>
Arguments	<p>hConnection: The handle for an I/O device connection.</p> <p>bytStartChannel: Specifies the starting channel.</p> <p>bytCount: The number of channels to be set.</p> <p>dwStatus: A pointer that stores the contiguous count channel's start status; each bit holds one channel status. A bit value of 0 represents the status of the start channel. A bit value of 1 represents the second channel's status. The values are :</p> <p>0: stop</p> <p>1: start</p>
Return Value	<p>Succeed MXIO_OK.</p> <p>Fail Refer to Return Codes.</p>

W5K_Cnt_SetStartStatuses	This function code is used to set contiguous channel's start status when D/I channel in "Count" mode.
C#	<pre>int W5K_Cnt_SetStartStatuses(Int32 hConnection, byte bytStartChannel, byte bytCount, UInt32 dwStatus);</pre>
VB.NET	<pre>W5K_Cnt_SetStartStatuses(ByVal hConnection As Integer, ByVal bytStartChannel As Byte, ByVal bytCount As Byte, ByVal nStatus As UInt32) As Integer</pre>
Arguments	<p>hConnection: The handle for an I/O device connection.</p> <p>bytStartChannel: Specifies the starting channel.</p> <p>bytCount: The number of channels to be set.</p> <p>dwStatus: A pointer that stores the contiguous count channel's start status; each bit holds one channel status. A bit value of 0 represents the status of the start channel. A bit value of 1 represents the second channel's status. The values are :</p> <p> 0: stop</p> <p> 1: start</p>
Return Value	<p>Succeed MXIO_OK.</p> <p>Fail Refer to Return Codes.</p>

W5K_Cnt_GetTriggerTypes	This function code is used to get contiguous channel's trigger types when D/I channel in "Count" mode.
C#	<pre>int W5K_Cnt_GetTriggerTypes (Int32 hConnection, byte bytStartChannel, byte bytCount, UInt32[] dwType);</pre>
VB.NET	<pre>W5K_Cnt_GetTriggerTypes(ByVal hConnection As Integer, ByVal bytStartChannel As Byte, ByVal bytCount As Byte, ByRef nType As UInt32) As Integer</pre>
Arguments	<p>hConnection: The handle for an I/O device connection.</p> <p>bytStartChannel: Specifies the starting channel.</p> <p>bytCount: The number of channels to be get.</p> <p>dwType: A pointer that stores the contiguous channel's triggers types; each bit holds one channel trigger type. A bit value of 0 represents the trigger type of the start channel. A bit value of 1 represents the second channel's trigger type. The values are :</p> <p>0: LoToHi 1: HiToLo</p>
Return Value	<p>Succeed MXIO_OK.</p> <p>Fail Refer to Return Codes.</p>

W5K_Cnt_SetTriggerTypes	This function code is used to set contiguous channel's trigger types when D/I channel in "Count" mode.
C#	<pre>int W5K_Cnt_SetTriggerTypes(Int32 hConnection, byte bytStartChannel, byte bytCount, UInt32 dwType);</pre>
VB.NET	<pre>W5K_Cnt_SetTriggerTypes(ByVal hConnection As Integer, ByVal bytStartChannel As Byte, ByVal bytCount As Byte, ByVal nType As UInt32) As Integer</pre>
Arguments	<p>hConnection: The handle for an I/O device connection.</p> <p>bytStartChannel: Specifies the starting channel.</p> <p>bytCount: The number of channels to be clear.</p> <p>dwType: Stored the contiguous channel's triggers types; each bit holds one channel trigger type. A bit value of 0 represents the trigger type of the start channel. A bit value of 1 represents the second channel's trigger type. The values are :</p> <p>0: LoToHi 1: HiToLo</p>
Return Value	<p>Succeed MXIO_OK.</p> <p>Fail Refer to Return Codes.</p>

W5K_Cnt_GetPowerOnValues	This function code is used to get contiguous channel's power on values when D/I channel in "Count" mode.
C#	<pre>int W5K_Cnt_GetPowerOnValues (Int32 hConnection, byte bytStartChannel, byte bytCount, UInt32[] dwValue);</pre>
VB.NET	<pre>W5K_Cnt_GetPowerOnValues (ByVal hConnection As Integer, ByVal bytStartChannel As Byte, ByVal bytCount As Byte, ByRef nValue As UInt32) As Integer</pre>
Arguments	<p>hConnection: The handle for an I/O device connection.</p> <p>bytStartChannel: Specifies the starting channel.</p> <p>bytCount: The number of channels to be get.</p> <p>dwValue: A pointer that stores the contiguous channel's power on values; each bit holds one channel power on value. A bit value of 0 represents the power on value of the start channel. A bit value of 1 represents the second channel's power on value. The values are :</p> <p>0: OFF</p> <p>1: ON</p>
Return Value	<p>Succeed MXIO_OK.</p> <p>Fail Refer to Return Codes.</p>

W5K_Cnt_SetPowerOnValues	This function code is used to set contiguous channel's power on values when D/I channel in "Count" mode.
C#	<pre>int W5K_Cnt_SetPowerOnValues (Int32 hConnection, byte bytStartChannel, byte bytCount, UInt32 dwValue);</pre>
VB.NET	<pre>W5K_Cnt_SetPowerOnValues (ByVal hConnection As Integer, ByVal bytStartChannel As Byte, ByVal bytCount As Byte, ByVal nValue As UInt32) As Integer</pre>
Arguments	<p>hConnection: The handle for an I/O device connection.</p> <p>bytStartChannel: Specifies the starting channel.</p> <p>bytCount: The number of channels to be clear.</p> <p>dwValue: Stored the contiguous channel's power on values; each bit holds one channel power on value. A bit value of 0 represents the power on value of the start channel. A bit value of 1 represents the second channel's power on value. The values are :</p> <p>0: OFF</p> <p>1: ON</p>
Return Value	<p>Succeed MXIO_OK.</p> <p>Fail Refer to Return Codes.</p>

W5K_Cnt_GetSafeValues	This function code is used to get contiguous channel's safe values when D/I channel in "Count" mode.
C#	<pre>int W5K_Cnt_GetSafeValues (Int32 hConnection, byte bytStartChannel, byte bytCount, UInt32[] dwValue);</pre>
VB.NET	<pre>W5K_Cnt_GetSafeValues (ByVal hConnection As Integer, ByVal bytStartChannel As Byte, ByVal bytCount As Byte, ByRef nValue As UInt32) As Integer</pre>
Arguments	<p>hConnection: The handle for an I/O device connection.</p> <p>bytStartChannel: Specifies the starting channel.</p> <p>bytCount: The number of channels to be get.</p> <p>dwValue: A pointer that stores the contiguous channel's safe values; each bit holds one channel safe value. A bit value of 0 represents the safe value of the start channel. A bit value of 1 represents the second channel's safe value. The values are :</p> <p> 0: OFF</p> <p> 1: ON</p>
Return Value	<p>Succeed MXIO_OK.</p> <p>Fail Refer to Return Codes.</p>

W5K_Cnt_SetSafeValues	This function code is used to set contiguous channel's safe values when D/I channel in "Count" mode.
C#	<pre>int W5K_Cnt_SetSafeValues (Int32 hConnection, byte bytStartChannel, byte bytCount, UInt32 dwValue);</pre>
VB.NET	<pre>W5K_Cnt_SetSafeValues (ByVal hConnection As Integer, ByVal bytStartChannel As Byte, ByVal bytCount As Byte, ByVal nValue As UInt32) As Integer</pre>
Arguments	<p>hConnection: The handle for an I/O device connection.</p> <p>bytStartChannel: Specifies the starting channel.</p> <p>bytCount: The number of channels to be clear.</p> <p>dwValue: Stored the contiguous channel's safe values; each bit holds one channel safe value. A bit value of 0 represents the safe value of the start channel. A bit value of 1 represents the second channel's safe value. The values are :</p> <p>0: OFF</p> <p>1: ON</p>
Return Value	<p>Succeed MXIO_OK.</p> <p>Fail Refer to Return Codes.</p>

W5K_Cnt_GetTriggerType Words	This function code is used to get contiguous channel's trigger types when D/I channel in "Count" mode.
C#	<pre>int W5K_Cnt_GetTriggerTypeWords (Int32 hConnection, byte bytStartChannel, byte bytCount, UInt16[] wType);</pre>
VB.NET	<pre>W5K_Cnt_GetTriggerTypeWords (ByVal hConnection As Integer, ByVal bytStartChannel As Byte, ByVal bytCount As Byte, ByVal iType() As UInt16) As Integer</pre>
Arguments	<p>hConnection: The handle for an I/O device connection.</p> <p>bytStartChannel: Specifies the starting channel.</p> <p>bytCount: The number of channels to be get.</p> <p>wType: A pointer that stores the contiguous channel's triggers types; each bit holds one channel trigger type. A bit value of 0 represents the trigger type of the start channel. A bit value of 1 represents the second channel's trigger type. The values are :</p> <p>0: LoToHi 1: HiToLo 2: Both</p>
Return Value	<p>Succeed MXIO_OK.</p> <p>Fail Refer to Return Codes.</p>

W5K_Cnt_SetTriggerType Words	This function code is used to set contiguous channel's trigger types when D/I channel in "Count" mode.
C#	<pre>int W5K_Cnt_SetTriggerTypeWords (Int32 hConnection, byte bytStartChannel, byte bytCount, UInt16[] wType);</pre>
VB.NET	<pre>W5K_Cnt_SetTriggerTypeWords (ByVal hConnection As Integer, ByVal bytStartChannel As Byte, ByVal bytCount As Byte, ByVal iType() As UInt16) As Integer</pre>
Arguments	<p>hConnection: The handle for an I/O device connection.</p> <p>bytStartChannel: Specifies the starting channel.</p> <p>bytCount: The number of channels to be clear.</p> <p>wType: A pointer that stores the contiguous channel's triggers types; each bit holds one channel trigger type. A bit value of 0 represents the trigger type of the start channel. A bit value of 1 represents the second channel's trigger type. The values are :</p> <p>0: LoToHi 1: HiToLo 2: Both</p>
Return Value	<p>Succeed MXIO_OK.</p> <p>Fail Refer to Return Codes.</p>

W5K_Cnt_GetSaveStatusesOnPowerFail	This function code is used to get contiguous channel's DI/DO power off storage enable mode.
C#	<pre>int W5K_Cnt_GetSaveStatusesOnPowerFail (Int32 hConnection, byte bytStartChannel, byte bytCount, UInt32[] dwMode);</pre>
VB.NET	<pre>W5K_Cnt_GetSaveStatusesOnPowerFail (ByVal hConnection As Integer, ByVal bytStartChannel As Byte, ByVal bytCount As Byte, ByRef nMode As UInt32) As Integer</pre>
Arguments	<p>hConnection: The handle for an I/O device connection.</p> <p>bytStartChannel: Specifies the starting channel.</p> <p>bytCount: The number of channels to be get.</p> <p>dwStatus: A pointer that stores the contiguous channel's DI/DO mode; each bit holds one channel status. A bit value of 0 represents the status of the start channel. A bit value of 1 represents the second channel's status. The values are :</p> <p> 0: ON, 1: OFF</p>
Return Value	<p>Succeed MXIO_OK.</p> <p>Fail Refer to Return Codes.</p>

W5K_Cnt_SetSaveStatusesOnPowerFail	This function code is used to set contiguous channel's DI/DO mode power off storage enable mode.
C#	<pre>int W5K_Cnt_SetSaveStatusesOnPowerFail (Int32 hConnection, byte bytStartChannel, byte bytCount, UInt32 dwMode);</pre>
VB.NET	<pre>W5K_Cnt_SetSaveStatusesOnPowerFail (ByVal hConnection As Integer, ByVal bytStartChannel As Byte, ByVal bytCount As Byte, ByVal nMode As UInt32) As Integer</pre>
Arguments	<p>hConnection: The handle for an I/O device connection.</p> <p>bytStartChannel: Specifies the starting channel.</p> <p>bytCount: The number of channels to be set.</p> <p>dwStatus: A pointer that stores the contiguous channel's DI/DO mode; each bit holds one channel status. A bit value of 0 represents the status of the start channel. A bit value of 1 represents the second channel's status. The values are :</p> <p>0: ON, 1: OFF</p>
Return Value	<p>Succeed MXIO_OK.</p> <p>Fail Refer to Return Codes.</p>

Counter Commands for ioLogik E1200

E1K_Cnt_Reads	This function code is used to read contiguous channel's count value when D/I channels are in "Count" mode.
C#	<pre>int E1K_Cnt_Reads(Int32 hConnection, byte bytStartChannel, byte bytCount, UInt32[] dwValue);</pre>
VB.NET	<pre>E1K_Cnt_Reads(ByVal hConnection As Integer, ByVal bytStartChannel As Byte, ByVal bytCount As Byte, ByVal nValue() As UInt32) As Integer</pre>
Arguments	<p>hConnection: The handle for an I/O device connection.</p> <p>bytStartChannel: Specifies the starting channel.</p> <p>bytCount: The number of channels to be read.</p> <p>dwValue: An array that stores the contiguous channel's count value , dwValue[0] represents the value of the starting channel.</p>
Return Value	<p>Succeed MXIO_OK.</p> <p>Fail Refer to Return Codes.</p>

E1K_Cnt_Clears	This function code is used to clear contiguous channel's count value when D/I channel in "Count" mode.
C#	int E1K_Cnt_Clears(Int32 hConnection, byte bytStartChannel, byte bytCount);
VB.NET	E1K_Cnt_Clears(ByVal hConnection As Integer, ByVal bytStartChannel As Byte, ByVal bytCount As Byte) As Integer
Arguments	hConnection: The handle for an I/O device connection. bytStartChannel: Specifies the starting channel. bytCount: The number of channels to be cleared.
Return Value	Succeed MXIO_OK. Fail Refer to Return Codes.

E1K_Cnt_GetOverflows	This function code is used to get contiguous channel's overflow status when D/I channel in "Count" mode.
C#	<pre>int E1K_Cnt_GetOverflows(Int32 hConnection, byte bytStartChannel, byte bytCount, UInt32[] dwStatus);</pre>
VB.NET	<pre>E1K_Cnt_GetOverflows(ByVal hConnection As Integer, ByVal bytStartChannel As Byte, ByVal bytCount As Byte, ByRef nStatus As UInt32) As Integer</pre>
Arguments	<p>hConnection: The handle for an I/O device connection.</p> <p>bytStartChannel: Specifies the starting channel.</p> <p>bytCount: The number of channels to be read.</p> <p>dwStatus: A pointer that stores the contiguous channel's overflow status; each bit holds one channel status. A bit value of 0 represents the status of the start channel. A bit value of 1 represents the second channel's status. The values are :</p> <p>0: Normal</p> <p>1: Overflow.</p>
Return Value	<p>Succeed MXIO_OK.</p> <p>Fail Refer to Return Codes.</p>

E1K_Cnt_ClearOverflows	This function code is used to clear contiguous channel's overflow status when D/I channel in "Count" mode.
C#	int E1K_Cnt_ClearOverflows(Int32 hConnection, byte bytStartChannel, byte bytCount);
VB.NET	E1K_Cnt_ClearOverflows(ByVal hConnection As Integer, ByVal bytStartChannel As Byte, ByVal bytCount As Byte) As Integer
Arguments	hConnection: The handle for an I/O device connection. bytStartChannel: Specifies the starting channel. bytCount: The number of channels to be cleared.
Return Value	Succeed MXIO_OK. Fail Refer to Return Codes.

E1K_Cnt_GetFilters	This function code is used to get contiguous channel's filter value when D/I channel in "Count" mode.
C#	int E1K_Cnt_GetFilters(Int32 hConnection, byte bytStartChannel, byte bytCount, UInt16[] wFilter);
VB.NET	E1K_Cnt_GetFilters(ByVal hConnection As Integer, ByVal bytStartChannel As Byte, ByVal bytCount As Byte, ByVal iFilter() As UInt16) As Integer
Arguments	hConnection: The handle for an I/O device connection. bytStartChannel: Specifies the starting channel. bytCount: The number of channels to be read. wFilter: An array that stored the filter value for contiguous D/I channel.
Return Value	Succeed MXIO_OK. Fail Refer to Return Codes.

E1K_Cnt_SetFilters	This function code is used to set contiguous channel's filter value when D/I channel in "Count" mode.
C#	int E1K_Cnt_SetFilters(Int32 hConnection, byte bytStartChannel, byte bytCount, UInt16[] wFilter);
VB.NET	E1K_Cnt_SetFilters(ByVal hConnection As Integer, ByVal bytStartChannel As Byte, ByVal bytCount As Byte, ByVal iFilter() As UInt16) As Integer
Arguments	hConnection: The handle for an I/O device connection. bytStartChannel: Specifies the starting channel. bytCount: The number of channels to be set. wFilter: An array that stores the filter value for contiguous D/I channel.
Return Value	Succeed MXIO_OK. Fail Refer to Return Codes.

E1K_Cnt_GetStartStatuses	This function code is used to get contiguous channel's start status when D/I channel in "Count" mode.
C#	<pre>int E1K_Cnt_GetStartStatuses(Int32 hConnection, byte bytStartChannel, byte bytCount, UInt32[] dwStatus);</pre>
VB.NET	<pre>E1K_Cnt_GetStartStatuses(ByVal hConnection As Integer, ByVal bytStartChannel As Byte, ByVal bytCount As Byte, ByRef nStatus As UInt32) As Integer</pre>
Arguments	<p>hConnection: The handle for an I/O device connection.</p> <p>bytStartChannel: Specifies the starting channel.</p> <p>bytCount: The number of channels to be set.</p> <p>dwStatus: A pointer that stores the contiguous count channel's start status; each bit holds one channel status. A bit value of 0 represents the status of the start channel. A bit value of 1 represents the second channel's status. The values are :</p> <p>0: stop</p> <p>1: start</p>
Return Value	<p>Succeed MXIO_OK.</p> <p>Fail Refer to Return Codes.</p>

E1K_Cnt_SetStartStatuses	This function code is used to set contiguous channel's start status when D/I channel in "Count" mode.
C#	<pre>int E1K_Cnt_SetStartStatuses(Int32 hConnection, byte bytStartChannel, byte bytCount, UInt32 dwStatus);</pre>
VB.NET	<pre>E1K_Cnt_SetStartStatuses(ByVal hConnection As Integer, ByVal byStartChannel As Byte, ByVal bytCount As Byte, ByVal nStatus As UInt32) As Integer</pre>
Arguments	<p>hConnection: The handle for an I/O device connection.</p> <p>bytStartChannel: Specifies the starting channel.</p> <p>bytCount: The number of channels to be set.</p> <p>dwStatus: A pointer that stores the contiguous count channel's start status; each bit holds one channel status. A bit value of 0 represents the status of the start channel. A bit value of 1 represents the second channel's status. The values are :</p> <p>0: stop</p> <p>1: start</p>
Return Value	<p>Succeed MXIO_OK.</p> <p>Fail Refer to Return Codes.</p>

E1K_Cnt_GetPowerOnValues	This function code is used to get contiguous channel's power on values when D/I channel in "Count" mode.
C#	<pre>int E1K_Cnt_GetPowerOnValues(Int32 hConnection, byte bytStartChannel, byte bytCount, UInt32[] dwValue);</pre>
VB.NET	<pre>E1K_Cnt_GetPowerOnValues(ByVal hConnection As Integer, ByVal bytStartChannel As Byte, ByVal bytCount As Byte, ByRef nValue As UInt32) As Integer</pre>
Arguments	<p>hConnection: The handle for an I/O device connection.</p> <p>bytStartChannel: Specifies the starting channel.</p> <p>bytCount: The number of channels to be read.</p> <p>dwValue: A pointer that stores the contiguous channel's power on values; each bit holds one channel power on value. A bit value of 0 represents the power on value of the start channel. A bit value of 1 represents the second channel's power on value. The values are :</p> <p>0: OFF</p> <p>1: ON</p>
Return Value	<p>Succeed MXIO_OK.</p> <p>Fail Refer to Return Codes.</p>

E1K_Cnt_SetPowerOnValues	This function code is used to set contiguous channel's power on values when D/I channel in "Count" mode.
C#	<pre>int E1K_Cnt_SetPowerOnValues(Int32 hConnection, byte bytStartChannel, byte bytCount, UInt32 dwValue);</pre>
VB.NET	<pre>E1K_Cnt_SetPowerOnValues(ByVal hConnection As Integer, ByVal bytStartChannel As Byte, ByVal bytCount As Byte, ByVal nValue As UInt32) As Integer</pre>
Arguments	<p>hConnection: The handle for an I/O device connection.</p> <p>bytStartChannel: Specifies the starting channel.</p> <p>bytCount: The number of channels to be cleared.</p> <p>dwValue: Stores the contiguous channel's power on values; each bit holds one channel power on value. A bit value of 0 represents the power on value of the start channel. A bit value of 1 represents the second channel's power on value. The values are :</p> <p>0: OFF</p> <p>1: ON</p>
Return Value	<p>Succeed MXIO_OK.</p> <p>Fail Refer to Return Codes.</p>

E1K_Cnt_GetSafeValues	This function code is used to get contiguous channel's safe values when D/I channel in "Count" mode.	
C#	<pre>int E1K_Cnt_GetSafeValues(Int32 byte byte UInt32[] hConnection, bytStartChannel, bytCount, dwValue);</pre>	
VB.NET	<pre>E1K_Cnt_GetSafeValues(ByVal hConnection As Integer, ByVal bytStartChannel As Byte, ByVal bytCount As Byte, ByRef nValue As UInt32) As Integer</pre>	
Arguments	<p>hConnection: The handle for an I/O device connection.</p> <p>bytStartChannel: Specifies the starting channel.</p> <p>bytCount: The number of channels to be read.</p> <p>dwValue: A pointer that stores the contiguous channel's safe values; each bit holds one channel safe value. A bit value of 0 represents the safe value of the start channel. A bit value of 1 represents the second channel's safe value. The values are :</p> <p>0: OFF</p> <p>1: ON</p>	
Return Value	<p>Succeed MXIO_OK.</p> <p>Fail Refer to Return Codes.</p>	

E1K_Cnt_SetSafeValues	This function code is used to set contiguous channel's safe values when D/I channel in "Count" mode.
C#	<pre>int E1K_Cnt_SetSafeValues(Int32 hConnection, byte bytStartChannel, byte bytCount, UInt32 dwValue);</pre>
VB.NET	<pre>E1K_Cnt_SetSafeValues(ByVal hConnection As Integer, ByVal bytStartChannel As Byte, ByVal bytCount As Byte, ByVal nValue As UInt32) As Integer</pre>
Arguments	<p>hConnection: The handle for an I/O device connection.</p> <p>bytStartChannel: Specifies the starting channel.</p> <p>bytCount: The number of channels to be cleared.</p> <p>dwValue: Stores the contiguous channel's safe values; each bit holds one channel safe value. A bit value of 0 represents the safe value of the start channel. A bit value of 1 represents the second channel's safe value. The values are :</p> <p>0: OFF</p> <p>1: ON</p>
Return Value	<p>Succeed MXIO_OK.</p> <p>Fail Refer to Return Codes.</p>

E1K_Cnt_GetTriggerTypeWords	This function code is used to get contiguous channel's trigger types when D/I channel in "Count" mode.
C#	<pre>int E1K_Cnt_GetTriggerTypeWords (Int32 hConnection, byte bytStartChannel, byte bytCount, UInt16[] wType);</pre>
VB.NET	<pre>E1K_Cnt_GetTriggerTypeWords(ByVal hConnection As Integer, ByVal bytStartChannel As Byte, ByVal bytCount As Byte, ByVal iType() As UInt16) As Integer</pre>
Arguments	<p>hConnection: The handle for an I/O device connection.</p> <p>bytStartChannel: Specifies the starting channel.</p> <p>bytCount: The number of channels to be read.</p> <p>wType: A pointer that stores the contiguous channel's triggers types; each bit holds one channel trigger type. A bit value of 0 represents the trigger type of the start channel. A bit value of 1 represents the second channel's trigger type. The values are :</p> <p>0: LoToHi 1: HiToLo 2: Both</p>
Return Value	<p>Succeed MXIO_OK.</p> <p>Fail Refer to Return Codes.</p>

E1K_Cnt_SetTriggerTypeWords	This function code is used to set contiguous channel's trigger types when D/I channel in "Count" mode.
C#	<pre>int E1K_Cnt_SetTriggerTypeWords (Int32 hConnection, byte bytStartChannel, byte bytCount, UInt16[] wType);</pre>
VB.NET	<pre>E1K_Cnt_SetTriggerTypeWords(ByVal hConnection As Integer, ByVal bytStartChannel As Byte, ByVal bytCount As Byte, ByVal iType() As UInt16) As Integer</pre>
Arguments	<p>hConnection: The handle for an I/O device connection.</p> <p>bytStartChannel: Specifies the starting channel.</p> <p>bytCount: The number of channels to be cleared.</p> <p>wType: Stores the contiguous channel's triggers types; each bit holds one channel trigger type. A bit value of 0 represents the trigger type of the start channel. A bit value of 1 represents the second channel's trigger type. The values are :</p> <p>0: LoToHi 1: HiToLo 2: Both</p>
Return Value	<p>Succeed MXIO_OK.</p> <p>Fail Refer to Return Codes.</p>

E1K_Cnt_GetSaveStatusesOnPowerFail	This function code is used to get contiguous channel's DI/DO power off storage enable mode.
C#	<pre>int E1K_Cnt_GetSaveStatusesOnPowerFail (Int32 hConnection, byte bytStartChannel, byte bytCount, UInt32[] dwMode);</pre>
VB.NET	<pre>E1K_Cnt_GetSaveStatusesOnPowerFail(ByVal hConnection As Integer, ByVal bytStartChannel As Byte, ByVal bytCount As Byte, ByRef nMode As UInt32) As Integer</pre>
Arguments	<p>hConnection: The handle for an I/O device connection.</p> <p>bytStartChannel: Specifies the starting channel.</p> <p>bytCount: The number of channels to be read.</p> <p>dwStatus: A pointer that stores the contiguous channel's DI/DO mode; each bit holds one channel status. A bit value of 0 represents the status of the start channel. A bit value of 1 represents the second channel's status. The values are :</p> <p>0: ON, 1: OFF</p>
Return Value	<p>Succeed MXIO_OK.</p> <p>Fail Refer to Return Codes.</p>

E1K_Cnt_SetSaveStatusesOnPowerFail	This function code is used to set contiguous channel's DI/DO mode power off storage enable mode.
C#	<pre>int E1K_Cnt_SetSaveStatusesOnPowerFail (Int32 hConnection, byte bytStartChannel, byte bytCount, UInt32 dwMode);</pre>
VB.NET	<pre>E1K_Cnt_SetSaveStatusesOnPowerFail(ByVal hConnection As Integer, ByVal bytStartChannel As Byte, ByVal bytCount As Byte, ByVal nMode As UInt32) As Integer</pre>
Arguments	<p>hConnection: The handle for an I/O device connection.</p> <p>bytStartChannel: Specifies the starting channel.</p> <p>bytCount: The number of channels to be set.</p> <p>dwStatus: A pointer that stores the contiguous channel's DI/DO mode; each bit holds one channel status. A bit value of 0 represents the status of the start channel. A bit value of 1 represents the second channel's status. The values are :</p> <p>0: ON, 1: OFF</p>
Return Value	<p>Succeed MXIO_OK.</p> <p>Fail Refer to Return Codes.</p>

Digital Output Commands

DO_Reads	This function code is used to read the output statuses of contiguous D/O channels.
C#	<pre>int DO_Reads(Int32 hConnection, byte bytSlot, byte bytStartChannel, byte bytCount, UInt32[] dwValue);</pre>
VB.NET	<pre>DO_Reads(ByVal hConnection As Integer, ByVal bytSlot As Byte, ByVal bytStartChannel As Byte, ByVal bytCount As Byte, ByRef nValue As UInt32) As Integer</pre>
Arguments	<p>hConnection: The handle for an I/O device connection.</p> <p>bytSlot: Slot number of the I/O module, from 1 to 32. This parameter is inactive for the ioLogik E2000 and R2000.</p> <p>bytStartChannel: Specifies the starting channel.</p> <p>bytCount: The number of channels to be read.</p> <p>dwValue: A pointer to the statuses of the contiguous D/O channels; each bit holds the value of one channel. A bit value of 0 represents the digital output status of the start channel. A bit value of 1 represents the status of the second digital output channel. The values of the unused bits are random.</p>
Return Value	<p>Succeed MXIO_OK.</p> <p>Fail Refer to Return Codes.</p>

DO_Read	This function code is used to read the output status of a specific D/O channel.
C#	int DO_Read(Int32 hConnection, byte bytSlot, byte bytChannel, byte[] bytValue);
VB.NET	DO_Read(ByVal hConnection As Integer, ByVal bytSlot As Byte, ByVal bytChannel As Byte, ByRef bytValue As Byte) As Integer
Arguments	<p>hConnection: The handle for an I/O device connection.</p> <p>bytSlot: Slot number of the I/O module, from 1 to 32. This parameter is inactive for the ioLogik E2000 and R2000.</p> <p>bytChannel: The specific channel to be read.</p> <p>bytValue: A pointer that stores the specific channel output value to be read.</p>
Return Value	<p>Succeed MXIO_OK.</p> <p>Fail Refer to Return Codes.</p>

DO_Writes	This function code is used to write the output statuses of contiguous D/O channels.	
C#	int DO_Writes(Int32	hConnection,
	Byte	bytSlot,
	Byte	bytStartChannel,
	Byte	bytCount,
	UInt32	dwValue);
VB.NET	DO_Writes(ByVal	hConnection As Integer,
	ByVal	bytSlot As Byte,
	ByVal	bytStartChannel As Byte,
	ByVal	bytCount As Byte,
	ByVal	nValue As UInt32) As Integer
Arguments	hConnection:	The handle for an I/O device connection.
	bytSlot:	Slot number of the I/O module, from 1 to 32. This parameter is inactive for the ioLogik E2000 and R2000.
	bytStartChannel:	Specifies the starting channel.
	bytCount:	The number of channels to be written.
	dwValue:	Stores the channel statuses of the contiguous D/O channels; each bit holds the status of one channel. A bit value of 0 represents the digital output status of the start channel. A bit value of 1 represents the second digital output channel's status. The values of the unused bits are random.
Return Value	Succeed	MXIO_OK.
	Fail	Refer to Return Codes.

DO_Write	This function code is used to write the output status for a specific D/O channel.	
C#	int DO_Write(Int32	hConnection,
	byte	bytSlot,
	byte	bytChannel,
	byte	bytValue);
VB.NET	DO_Write(ByVal	hConnection As Integer,
	ByVal	bytSlot As Byte,
	ByVal	bytChannel As Byte,
	ByVal	bytValue As Byte) As Integer
Arguments	hConnection:	The handle for an I/O device connection.
	bytSlot:	Slot number of the I/O module, from 1 to 32. This parameter is inactive for the ioLogik E2000 and R2000.
	bytChannel:	The specific channel to be write.
	bytValue:	Stores the output status of the desired channel. 1: represents ON, 0: represents OFF.
Return Value	Succeed	MXIO_OK.
	Fail	Refer to Return Codes.

DO_GetSafeValues	This function code is used to get the output safe values of contiguous D/O channels.
C#	<code>int DO_GetSafeValues(Int32 hConnection, byte bytSlot, byte bytStartChannel, byte bytCount, UInt32[] dwValue);</code>
VB.NET	<code>DO_GetSafeValues(ByVal hConnection As Integer, ByVal bytSlot As Byte, ByVal bytStartChannel As Byte, ByVal bytCount As Byte, ByRef nValue As UInt32) As Integer</code>
Arguments	<p>hConnection: The handle for an I/O device connection.</p> <p>bytSlot: Slot number of the I/O module, from 1 to 32. This parameter is inactive for the ioLogik E2000 and R2000.</p> <p>bytStartChannel: Specifies the starting channel.</p> <p>bytCount: The number of channels to be gets.</p> <p>dwValue: A pointer to the safe values of the contiguous D/O channels; each bit holds the value of one channel. A bit value of 0 represents the digital output status of the start channel. A bit value of 1 represents the status of the second digital output channel. The values of the unused bits are random.</p>
Return Value	<p>Succeed MXIO_OK.</p> <p>Fail Refer to Return Codes.</p>

DO_SetSafeValues	This function code is used to set the safe values of contiguous D/O channels.	
C#	int DO_SetSafeValues(Int32	hConnection,
	byte	bytSlot,
	byte	bytStartChannel,
	byte	bytCount,
	UInt32	dwValue);
VB.NET	DO_SetSafeValues(ByVal	hConnection As Integer,
	ByVal	bytSlot As Byte,
	ByVal	bytStartChannel As Byte,
	ByVal	bytCount As Byte,
	ByVal	nValue As UInt32) As Integer
Arguments	hConnection:	The handle for an I/O device connection.
	bytSlot:	Slot number of the I/O module, from 1 to 32. This parameter is inactive for the ioLogik E2000 and R2000.
	bytStartChannel:	Specifies the starting channel.
	bytCount:	The number of channels to be set.
	dwValue:	A pointer to the safe values of the contiguous D/O channels; each bit holds the value of one channel. A bit value of 0 represents the digital output status of the start channel. A bit value of 1 represents the status of the second digital output channel.
Return Value	Succeed	MXIO_OK.
	Fail	Refer to Return Codes.

DO_GetSafeValue	This function code is used to get the safe value for a specific D/O channel.
C#	<pre>int DO_GetSafeValue(Int32 hConnection, byte bytSlot, byte bytChannel, byte[] bytValue);</pre>
VB.NET	<pre>DO_GetSafeValue(ByVal hConnection As Integer, ByVal bytSlot As Byte, ByVal bytChannel As Byte, ByRef bytValue As Byte) As Integer</pre>
Arguments	<p>hConnection: The handle for an I/O device connection.</p> <p>bytSlot: Slot number of the I/O module, from 1 to 32. This parameter is inactive for the ioLogik E2000 and R2000.</p> <p>bytChannel: The specific channel to be get.</p> <p>bytValue: Stores the safe value of the desired D/O channel. 0 represents OFF. 1 represents ON,</p>
Return Value	<p>Succeed MXIO_OK.</p> <p>Fail Refer to Return Codes.</p>

DO_SetSafeValue	This function code is used to set the safe value for a specific D/O channel.
C#	<pre>int DO_SetSafeValue(Int32 hConnection, byte bytSlot, byte bytChannel, byte bytValue);</pre>
VB.NET	<pre>DO_SetSafeValue(ByVal hConnection As Integer, ByVal bytSlot As Byte, ByVal bytChannel As Byte, ByVal bytValue As Byte) As Integer</pre>
Arguments	<p>hConnection: The handle for an I/O device connection.</p> <p>bytSlot: Slot number of the I/O module, from 1 to 32. This parameter is inactive for the ioLogik E2000 and R2000.</p> <p>bytChannel: The specific channel whose output will be set.</p> <p>bytValue: Stores the safe value of the desired channel. 0 represents OFF , 1 represents ON.</p>
Return Value	<p>Succeed MXIO_OK.</p> <p>Fail Refer to Return Codes.</p>

DO_GetSafeValues_W	This function code is used to get output safe values of contiguous D/O channels.
C#	<pre>int DO_GetSafeValues_W(Int32 hConnection, byte bytSlot, byte bytStartChannel, byte bytCount, UInt16[] wValues);</pre>
VB.NET	<pre>DO_GetSafeValues_W(ByVal hConnection As Integer, ByVal bytSlot As Byte, ByVal bytStartChannel As Byte, ByVal bytCount As Byte, ByVal iValue() As UInt16) As Integer</pre>
Arguments	<p>hConnection: The handle for an I/O device connection.</p> <p>bytSlot: Slot number of the I/O module. Slot numbers range from 1 to 32. But this parameter is inactive in ioLigik 2000.</p> <p>bytStartChannel: Specifies the starting channel.</p> <p>bytCount: The number of channels to be gets.</p> <p>wValue: A pointer that stores the safe value of contiguous D/O channels; each word holds one channel value. A word value of 0 represents the digital output status of the start channel. A word value of 1 represents the status of the second digital output channel. The values of the unused bits are random. 0: OFF 1: ON 2: Hold Last</p>
Return Value	<p>Succeed MXIO_OK.</p> <p>Fail Refer to Return Codes.</p>

DO_SetSafeValues_W	This function code is used to set safe values of contiguous D/O channels.
C#	<pre>int DO_SetSafeValues_W(Int32 hConnection, byte bytSlot, byte bytStartChannel, byte bytCount, UInt16[] wValues);</pre>
VB.NET	<pre>DO_SetSafeValues_W(ByVal hConnection As Integer, ByVal bytSlot As Byte, ByVal bytStartChannel As Byte, ByVal bytCount As Byte, ByVal iValue() As UInt16) As Integer</pre>
Arguments	<p>hConnection: The handle for an I/O device connection.</p> <p>bytSlot: Slot number of the I/O module. Slot numbers range from 1 to 32. But this parameter is inactive in ioLigik 2000.</p> <p>bytStartChannel: Specifies the starting channel.</p> <p>bytCount: The number of channels to be set.</p> <p>wValue: A pointer that stores the safe value of contiguous D/O channels; each word holds one channel value. A word value of 0 represents the digital output status of the start channel. A word value of 1 represents the status of the second digital output channel.</p> <p>0: OFF 1: ON 2: Hold Last</p>
Return Value	<p>Succeed MXIO_OK.</p> <p>Fail Refer to Return Codes.</p>

Digital Output Commands for ioLogik E2000, R2000

DO2K_GetModes	This function code is used to get the mode of contiguous D/O channels.
C#	<pre>int DO2K_GetModes(Int32 byte hConnection, byte bytStartChannel, UInt16[] wMode);</pre>
VB.NET	<pre>DO2K_GetModes(ByVal hConnection As Integer, ByVal bytStartChannel As Byte, ByVal bytCount As Byte, ByVal iMode() As UInt16) As Integer</pre>
Arguments	<p>hConnection: The handle for an I/O device connection.</p> <p>bytStartChannel: Specifies the starting channel.</p> <p>bytCount: The number of channels to be gets.</p> <p>wMode: An array that stores the modes of contiguous D/O channels. The values are: 0: D/O mode 1: Pulse mode</p>
Return Value	<p>Succeed MXIO_OK.</p> <p>Fail Refer to Return Codes.</p>

DO2K_SetModes	This function code is used to set the modes of contiguous D/O channels.
C#	<pre>int DO2K_SetModes(Int32 hConnection, byte bytStartChannel, byte bytCount, UInt16[] wMode);</pre>
VB.NET	<pre>DO2K_SetModes(ByVal hConnection As Integer, ByVal bytStartChannel As Byte, ByVal bytCount As Byte, ByVal iMode() As UInt16) As Integer</pre>
Arguments	<p>hConnection: The handle for an I/O device connection.</p> <p>bytStartChannel: Specifies the starting channel.</p> <p>bytCount: The number of channels to be set.</p> <p>wMode: An array that stores the modes of contiguous D/O channels. The values are: 0: D/O mode 1: Pulse mode</p>
Return Value	<p>Succeed MXIO_OK.</p> <p>Fail Refer to Return Codes.</p>

DO2K_GetMode	This function code is used to get the mode of a specific D/O channel.
C#	<pre>int DO2K_GetMode(Int32 hConnection, byte bytChannel, UInt16[] wMode);</pre>
VB.NET	<pre>DO2K_GetMode(ByVal hConnection As Integer, ByVal bytChannel As Byte, ByRef iMode As UInt16) As Integer</pre>
Arguments	<p>hConnection: The handle for an I/O device connection.</p> <p>bytChannel: The specific channel to be get.</p> <p>wMode: A pointer to the mode of tthe desired D/O channel. The values are: 0: D/O mode 1: Pulse mode</p>
Return Value	<p>Succeed MXIO_OK.</p> <p>Fail Refer to Return Codes.</p>

DO2K_SetMode	This function code is used to set the mode for a specific D/O channel.
C#	int DO2K_SetMode(Int32 hConnection, byte bytChannel, UInt16 wMode);
VB.NET	DO2K_SetMode(ByVal hConnection As Integer, ByVal bytChannel As Byte, ByVal wMode As UInt16) As Integer
Arguments	hConnection: The handle for an I/O device connection. bytChannel: The specific channel to be set. wMode: A pointer to the mode of the desired D/O channel. The values are: 0: D/O mode 1: Pulse mode
Return Value	Succeed MXIO_OK. Fail Refer to Return Codes.

DO2K_GetPowerOnValues	This function code is used to get the power on values of contiguous D/O channels.
C#	int DO2K_GetPowerOnValues(Int32 hConnection, byte bytStartChannel, byte bytCount, UInt32[] dwValue);
VB.NET	DO2K_GetPowerOnValues(ByVal hConnection As Integer, ByVal bytStartChannel As Byte, ByVal bytCount As Byte, ByRef nValue As UInt32) As Integer
Arguments	hConnection: The handle for an I/O device connection. bytStartChannel: Specifies the starting channel. bytCount: The number of channels to be gets. dwValue: A pointer to the power on values of the contiguous D/O channels; each bit holds the value of one channel. A bit value of 0 represents the power on status of the start channel. A bit value of 1 represents the status of the second digital output channel. The values of the unused bits are random.
Return Value	Succeed MXIO_OK. Fail Refer to Return Codes.

DO2K_SetPowerOnValues	This function code is used to set the power on values of contiguous D/O channels.
C#	int DO2K_SetPowerOnValues(Int32 hConnection, byte bytStartChannel, byte bytCount, UInt32 dwValue);
VB.NET	DO2K_SetPowerOnValues(ByVal hConnection As Integer, ByVal bytStartChannel As Byte, ByVal bytCount As Byte, ByVal nValue As UInt32) As Integer
Arguments	<p>hConnection: The handle for an I/O device connection.</p> <p>bytStartChannel: Specifies the starting channel.</p> <p>bytCount: The number of channels to be set.</p> <p>dwValue: Stores the power on values of contiguous D/O channels; each bit holds the value of one channel. A bit value of 0 represents the power on status of the start channel. A bit value of 1 represents the status of the second digital output channel. The values of the unused bits are random.</p>
Return Value	<p>Succeed MXIO_OK.</p> <p>Fail Refer to Return Codes.</p>

DO2K_GetPowerOnValue	This function code is used to get the power on value for a specific D/O channel.
C#	int DO2K_GetPowerOnValue(Int32 hConnection, byte bytChannel, byte[] bytValue);
VB.NET	DO2K_GetPowerOnValue(ByVal hConnection As Integer, ByVal bytChannel As Byte, ByRef bytValue As Byte) As Integer
Arguments	<p>hConnection: The handle for an I/O device connection.</p> <p>bytChannel: The specific channel to be get.</p> <p>bytValue: A pointer to the power on value of the desired D/O channel.</p>
Return Value	<p>Succeed MXIO_OK.</p> <p>Fail Refer to Return Codes.</p>

DO2K_SetPowerOnValue	This function code is used to set the power on value for a specific D/O channel.
C#	int DO2K_SetPowerOnValue(Int32 hConnection, byte bytChannel, byte bytValue);
VB.NET	DO2K_SetPowerOnValue(ByVal hConnection As Integer, ByVal bytChannel As Byte, ByVal bytValue As Byte) As Integer
Arguments	<p>hConnection: The handle for an I/O device connection.</p> <p>bytChannel: The specific channel to be set.</p> <p>bytValue: Stores the power on value of a specific D/O channel.</p>
Return Value	<p>Succeed MXIO_OK.</p> <p>Fail Refer to Return Codes.</p>

DO2K_GetPowerOnSeqDelaytimes	This function code is used to get contiguous channel's DI/DO power off storage enable mode.
C#	int DO2K_GetPowerOnSeqDelaytimes(Int32 hConnection, byte bytStartChannel, byte bytCount, UInt16[] wValue);
VB.NET	DO2K_GetPowerOnSeqDelaytimes (ByVal hConnection As Integer, ByVal bytStartChannel As Byte, ByVal bytCount As Byte, ByVal iValue() As UInt16) As Integer
Arguments	<p>hConnection: The handle for an I/O device connection.</p> <p>bytStartChannel: Specifies the starting channel.</p> <p>bytCount: The number of channels to be set.</p> <p>wValue: A pointer that stores the contiguous channel's power on sequence delay time (Second) The values are: Range: 0~300.</p>
Return Value	<p>Succeed MXIO_OK.</p> <p>Fail Refer to Return Codes.</p>

DO2K_SetPowerOnSeqDelaytimes	This function code is used to set contiguous channel's DI/DO mode power off storage enable mode.
C#	<pre>int DO2K_SetPowerOnSeqDelaytimes(Int32 hConnection, byte bytStartChannel, byte bytCount, UInt16[] wValue);</pre>
VB.NET	<pre>DO2K_SetPowerOnSeqDelaytimes(ByVal hConnection As Integer, ByVal bytStartChannel As Byte, ByVal bytCount As Byte, ByVal iValue() As UInt16) As Integer</pre>
Arguments	<p>hConnection: The handle for an I/O device connection.</p> <p>bytStartChannel: Specifies the starting channel.</p> <p>bytCount: The number of channels to be set.</p> <p>wValue: A pointer that stores the contiguous channel's power on sequence delay time (Second) The values are: Range: 0~300.</p>
Return Value	<p>Succeed MXIO_OK.</p> <p>Fail Refer to Return Codes.</p>

Digital Input/Output Commands for ioLogik E2000

DIO2K_GetIOMode	This function code is used to get specific channel's DI/DO mode.
C#	<code>int DIO2K_GetIOMode(Int32 hConnection, byte bytChannel, byte[] bytMode);</code>
VB.NET	<code>DIO2K_GetIOMode(ByVal hConnection As Integer, ByVal bytChannel As Byte, ByRef bytMode As Byte) As Integer</code>
Arguments	<p>hConnection: The handle for an I/O device connection.</p> <p>bytChannel: The specific channel to be get.</p> <p>bytMode: A pointer that stores the specific channel's DI/DO mode. The values are :</p> <p>0 : INPUT DI mode</p> <p>1 : OUTPUT DO mode</p>
Return Value	<p>Succeed MXIO_OK</p> <p>Fail Refer to Return Codes.</p>

DIO2K_SetIOMode	This function code is used to set specific channel's DI/DO mode. This function will take effect after restart the device.
C#	<code>int DIO2K_SetIOMode (Int32 hConnection, BYTE bytChannel, BYTE bytMode);</code>
VB.NET	<code>DIO2K_SetIOMode(ByVal hConnection As Integer, ByVal bytChannel As Byte, ByVal bytMode As Byte) As Integer</code>
Arguments	<p>hConnection: The handle for an I/O device connection.</p> <p>bytChannel: The specific channel to be set.</p> <p>bytMode: A pointer that stores the specific channel's DI/DO mode. The values are:</p> <p>0 : INPUT DI mode</p> <p>1 : OUTPUT DO mode</p>
Return Value	<p>Succeed MXIO_OK</p> <p>Fail Refer to Return Codes.</p>

DIO2K_GetIOModes	This function code is used to get contiguous channel's DI/DO mode.	
C#	<pre>int DIO2K_GetIOModes(Int32 byte byte UInt32[]</pre>	<pre>hConnection, bytStartChannel, bytCount, dwMode);</pre>
VB.NET	<pre>DIO2K_GetIOModes(ByVal ByVal ByVal ByRef</pre>	<pre>hConnection As Integer, bytStartChannel As Byte, bytCount As Byte, nMode As UInt32) As Integer</pre>
Arguments	<p>hConnection: The handle for an I/O device connection.</p> <p>bytStartChannel: Specifies the starting channel.</p> <p>bytCount: The number of channels to be set.</p> <p>dwStatus: A pointer that stores the contiguous channel's DI/DO mode; each bit holds one channel status. A bit value of 0 represents the status of the start channel. A bit value of 1 represents the second channel's status. The values are :</p> <pre>0 : INPUT DI mode 1 : OUTPUT DO mode</pre>	
Return Value	<p>Succeed MXIO_OK</p> <p>Fail Refer to Return Codes.</p>	

DIO2K_SetIOModes	This function code is used to set contiguous channel's DI/DO mode. This function will take effect after restart the device.
C#	<pre>int DIO2K_SetIOModes(Int32 hConnection, byte bytStartChannel, byte bytCount, UInt32 dwMode);</pre>
VB.NET	<pre>DIO2K_SetIOModes(ByVal hConnection As Integer, ByVal bytStartChannel As Byte, ByVal bytCount As Byte, ByVal nMode As UInt32) As Integer</pre>
Arguments	<p>hConnection: The handle for an I/O device connection.</p> <p>bytStartChannel: Specifies the starting channel.</p> <p>bytCount: The number of channels to be set.</p> <p>dwMode: A pointer that stores the contiguous channel's DI/DO mode; each bit holds one channel status. A bit value of 0 represents the status of the start channel. A bit value of 1 represents the second channel's status. The values are :</p> <pre>0 : INPUT DI mode 1 : OUTPUT DO mode</pre>
Return Value	<p>Succeed MXIO_OK</p> <p>Fail Refer to Return Codes.</p>

Digital Input/Output Commands for ioLogik W5000

W5K_DIO_GetIOModes	This function code is used to get contiguous channel's DI/DO mode.
C#	<pre>int W5K_DIO_GetIOModes (Int32 hConnection, byte bytStartChannel, byte bytCount, UInt32[] dwMode);</pre>
VB.NET	<pre>W5K_DIO_GetIOModes(ByVal hConnection As Integer, ByVal bytStartChannel As Byte, ByVal bytCount As Byte, ByRef nMode As UInt32) As Integer</pre>
Arguments	<p>hConnection: The handle for an I/O device connection.</p> <p>bytStartChannel: Specifies the starting channel.</p> <p>bytCount: The number of channels to be set.</p> <p>dwStatus: A pointer that stores the contiguous channel's DI/DO mode; each bit holds one channel status. A bit value of 0 represents the status of the start channel. A bit value of 1 represents the second channel's status. The values are :</p> <p>0: INPUT DI mode 1: OUTPUT DO mode</p>
Return Value	<p>Succeed MXIO_OK</p> <p>Fail Refer to Return Codes.</p>

W5K_DIO_SetIOModes	This function code is used to get contiguous channel's DI/DO mode.
C#	<pre>int W5K_DIO_SetIOModes(Int32 byte byte UInt32 hConnection, bytStartChannel, bytCount, dwMode);</pre>
VB.NET	<pre>W5K_DIO_SetIOModes(ByVal ByVal ByVal ByVal hConnection As Integer, bytStartChannel As Byte, bytCount As Byte, nMode As UInt32) As Integer</pre>
Arguments	<p>hConnection: The handle for an I/O device connection.</p> <p>bytStartChannel: Specifies the starting channel.</p> <p>bytCount: The number of channels to be set.</p> <p>dwMode: A pointer that stores the contiguous channel's DI/DO mode; each bit holds one channel status. A bit value of 0 represents the status of the start channel. A bit value of 1 represents the second channel's status. The values are :</p> <p>0: INPUT DI mode 1: OUTPUT DO mode</p>
Return Value	<p>Succeed MXIO_OK</p> <p>Fail Refer to Return Codes.</p>

Digital Input/Output Commands for ioLogik E1200

E1K_DIO_GetIOModes	This function code is used to get contiguous channel's DI/DO mode.
C#	<pre>int E1K_DIO_GetIOModes(Int32 hConnection, byte bytStartChannel, byte bytCount, UInt32[] dwMode);</pre>
VB.NET	<pre>E1K_DIO_GetIOModes(ByVal hConnection As Integer, ByVal bytStartChannel As Byte, ByVal bytCount As Byte, ByRef nMode As UInt32) As Integer</pre>
Arguments	<p>hConnection: The handle for an I/O device connection.</p> <p>bytStartChannel: Specifies the starting channel.</p> <p>bytCount: The number of channels to be set.</p> <p>dwStatus: A pointer that stores the contiguous channel's DI/DO mode; each bit holds one channel status. A bit value of 0 represents the status of the start channel. A bit value of 1 represents the second channel's status. The values are :</p> <p>0: INPUT DI mode 1: OUTPUT DO mode</p>
Return Value	<p>Succeed MXIO_OK</p> <p>Fail Refer to Return Codes.</p>

Digital Output Commands for ioLogik 4000

DO4K_GetSafeActions	This function code is used to get the safe actions of contiguous D/O channels.	
C#	int DO4K_GetSafeActions(Int32	hConnection,
	byte	bytSlot,
	byte	bytStartChannel,
	byte	bytCount,
	UInt16[]	wAction);
VB.NET	DO4K_GetSafeActions(ByVal	hConnection As Integer,
	ByVal	bytSlot As Byte,
	ByVal	bytStartChannel As Byte,
	ByVal	bytCount As Byte,
	ByRef	iAction As UInt16) As
		Integer
Arguments	hConnection:	The handle for an I/O device connection.
	bytSlot:	Slot number of the I/O module, from 1 to 32.
	bytStartChannel:	Specifies the starting channel.
	bytCount:	The number of channels to be gets.
	wAction:	An array that stores the safe actions of contiguous D/O channels. The values are: 0: Safe Value 1: Hold last state
Return Value	Succeed	MXIO_OK.
	Fail	Refer to Return Codes.

DO4K_SetSafeActions	This function code is used to set the safe actions of contiguous D/O channels.
C#	<pre>int DO4K_SetSafeActions(Int32 hConnection, byte bytSlot, byte bytStartChannel, byte bytCount, UInt16[] wAction);</pre>
VB.NET	<pre>DO4K_SetSafeActions(ByVal hConnection As Integer, ByVal bytSlot As Byte, ByVal bytStartChannel As Byte, ByVal bytCount As Byte, ByRef iAction As UInt16) As Integer</pre>
Arguments	<p>hConnection: The handle for an I/O device connection.</p> <p>bytSlot: Slot number of the I/O module, from 1 to 32.</p> <p>bytStartChannel: Specifies the starting channel.</p> <p>bytCount: The number of channels to be set.</p> <p>wAction: An array that stores the safe actions of contiguous D/O channels. The values are: 0: Safe Value 1: Hold last state</p>
Return Value	<p>Succeed MXIO_OK.</p> <p>Fail Refer to Return Codes.</p>

DO4K_GetSafeAction	This function code is used to get the safe action for a specific D/O channel.
C#	<pre>int DO4K_GetSafeAction(Int32 hConnection, byte bytSlot, byte bytChannel, UInt16[] wAction);</pre>
VB.NET	<pre>DO4K_GetSafeAction(ByVal hConnection As Integer, ByVal bytSlot As Byte, ByVal bytChannel As Byte, ByRef iAction As UInt16) As Integer</pre>
Arguments	<p>hConnection: The handle for an I/O device connection.</p> <p>bytSlot: Slot number of the I/O module, from 1 to 32.</p> <p>bytChannel: The desired channel.</p> <p>wAction: A pointer to the safe action for the desired D/O channel. The values are: 0: Safe Value 1: Hold last state</p>
Return Value	<p>Succeed MXIO_OK.</p> <p>Fail Refer to Return Codes.</p>

DO4K_SetSafeAction	This function code is used to set the safe action for a specific channel.
C#	<pre>int DO4K_SetSafeAction(Int32 hConnection, byte bytSlot, byte bytChannel, UInt16 wAction);</pre>
VB.NET	<pre>DO4K_SetSafeAction(ByVal hConnection As Integer, ByVal bytSlot As Byte, ByVal bytChannel As Byte, ByVal iAction As UInt16) As Integer</pre>
Arguments	<p>hConnection: The handle for an I/O device connection.</p> <p>bytSlot: Slot number of the I/O module, from 1 to 32.</p> <p>bytChannel: The specific channel to be set.</p> <p>wAction: Stores the safe action for the desired D/O channel. The values are: 0: Safe Value 1: Hold last state</p>
Return Value	<p>Succeed MXIO_OK.</p> <p>Fail Refer to Return Codes.</p>

E42_DO_GetSafeActions	This function code is used to get the safe action of contiguous D/O channels.
C#	<pre>int E42_DO_GetSafeActions(Int32 hConnection, byte bytSlot, byte bytStartChannel, byte bytCount, UInt32[] wAction);</pre>
VB.NET	<pre>E42_DO_GetSafeActions(ByVal hConnection As Integer, ByVal bytSlot As Byte, ByVal bytStartChannel As Byte, ByVal bytCount As Byte, ByRef nAction As UInt32) As Integer</pre>
Arguments	<p>hConnection: The handle for an I/O device connection.</p> <p>bytSlot: Slot number of the I/O module, from 1 to 16.</p> <p>bytStartChannel: Specifies the starting channel.</p> <p>bytCount: The number of channels to be gets.</p> <p>dwAction: A pointer that stores the contiguous D/O channel's safe action values; each bit holds one channel value. A bit value of 0 represents the digital input status of the start channel. A bit value of 1 represents the second digital input channel's status. The values of the unused bits are random. 0: Fault Value 1: Hold last value</p>
Return Value	<p>Succeed MXIO_OK.</p> <p>Fail Refer to Return Codes.</p>

E42_DO_SetSafeActions	This function code is used to set the safe action of contiguous D/O channels.
C#	<pre>int E42_DO_SetSafeActions(Int32 hConnection, byte bytSlot, byte bytStartChannel, byte bytCount, UInt32 wAction);</pre>
VB.NET	<pre>E42_DO_SetSafeActions(ByVal hConnection As Integer, ByVal bytSlot As Byte, ByVal bytStartChannel As Byte, ByVal bytCount As Byte, ByVal nAction As UInt32) As Integer</pre>
Arguments	<p>hConnection: The handle for an I/O device connection.</p> <p>bytSlot: Slot number of the I/O module, from 1 to 16.</p> <p>bytStartChannel: Specifies the starting channel.</p> <p>bytCount: The number of channels to be set.</p> <p>dwAction: A pointer that stores the contiguous D/O channel's safe action values; each bit holds one channel value. A bit value of 0 represents the digital input status of the start channel. A bit value of 1 represents the second digital input channel's status. The values of the unused bits are random.</p> <p>0: Fault Value 1: Hold last value</p>
Return Value	<p>Succeed MXIO_OK.</p> <p>Fail Refer to Return Codes.</p>

E42_DO_GetPowerOnValues	This function code is used to get the power on value of contiguous D/O channels.
C#	<pre>int E42_DO_GetPowerOnValues(Int32 hConnection, byte bytSlot, byte bytStartChannel, byte bytCount, UInt32[] dwValue);</pre>
VB.NET	<pre>E42_DO_GetPowerOnValues(ByVal hConnection As Integer, ByVal bytSlot As Byte, ByVal bytStartChannel As Byte, ByVal bytCount As Byte, ByRef nValue As UInt32) As Integer</pre>
Arguments	<p>hConnection: The handle for an I/O device connection.</p> <p>bytSlot: Slot number of the I/O module, from 1 to 16.</p> <p>bytStartChannel: Specifies the starting channel.</p> <p>bytCount: The number of channels to be gets.</p> <p>dwValue: A pointer that stores the power on value of contiguous D/O channels; each bit holds one channel value. A bit value of 0 represents the power on status of the start channel. A bit value of 1 represents the status of the second digital output channel. The values of the unused bits are random.</p>
Return Value	<p>Succeed MXIO_OK.</p> <p>Fail Refer to Return Codes.</p>

E42_DO_SetPowerOnValues	This function code is used to set the power on value of contiguous D/O channels.	
C#	int E42_DO_SetPowerOnValues(Int32	hConnection,
	byte	bytSlot,
	byte	bytStartChannel,
	byte	bytCount,
	UInt32	dwValue);
VB.NET	E42_DO_SetPowerOnValues(ByVal	hConnection As Integer,
	ByVal	bytSlot As Byte,
	ByVal	bytStartChannel As
		Byte,
	ByVal	bytCount As Byte,
	ByVal	nValue As UInt32)
		As Integer
Arguments	hConnection:	The handle for an I/O device connection.
	bytSlot:	Slot number of the I/O module, from 1 to 16.
	bytStartChannel:	Specifies the starting channel.
	bytCount:	The number of channels to be set.
	dwValue:	Stores the power on value of contiguous D/O channels; each bit holds one channel value. A bit value of 0 represents the power on status of the start channel. A bit value of 1 represents the status of the second digital output channel. The values of the unused bits are random.
Return Value	Succeed	MXIO_OK.
	Fail	Refer to Return Codes.

E42_DO_Reads	This function code is used to read the output statuses of contiguous D/O channels.
C#	int E42_DO_Reads(Int32 hConnection, byte bytSlot, byte bytStartChannel, byte bytCount, UInt32[] dwValue);
VB.NET	E42_DO_Reads(ByVal hConnection As Integer, ByVal bytSlot As Byte, ByVal bytStartChannel As Byte, ByVal bytCount As Byte, ByRef nValue As UInt32) As Integer
Arguments	<p>hConnection: The handle for an I/O device connection.</p> <p>bytSlot: Slot number of the I/O module. Slot numbers range from 1 to 16. But this parameter is inactive on the ioLogik 2000.</p> <p>bytStartChannel: Specifies the starting channel.</p> <p>bytCount: The number of channels to be read.</p> <p>dwValue: A pointer that stores the contiguous D/O channel's status; each bit holds one channel value. A bit value of 0 represents the digital output status of the start channel. A bit value of 1 represents the status of the second digital output channel. The values of the unused bits are random.</p>
Return Value	<p>Succeed MXIO_OK.</p> <p>Fail Refer to Return Codes.</p>

E42_DO_Writes	This function code is used to write the output statuses of contiguous D/O channels.
C#	int E42_DO_Writes(Int32 hConnection, byte bytSlot, byte bytStartChannel, byte bytCount, UInt32 dwValue);
VB.NET	E42_DO_Writes(ByVal hConnection As Integer, ByVal bytSlot As Byte, ByVal bytStartChannel As Byte, ByVal bytCount As Byte, ByVal nValue As UInt32) As Integer
Arguments	<p>hConnection: The handle for an I/O device connection.</p> <p>bytSlot: Slot number of the I/O module. Slot numbers range from 1 to 16. But this parameter is inactive in ioLogik 2000.</p> <p>bytStartChannel: Specifies the starting channel.</p> <p>bytCount: The number of channels to be written.</p> <p>dwValue: Stores the channel statuses of contiguous D/O channels; each bit holds one channel status. A bit value of 0 represents the digital output status of the start channel. A bit value of 1 represents the second digital output channel's status. The values of the unused bits are random.</p>
Return Value	<p>Succeed MXIO_OK.</p> <p>Fail Refer to Return Codes.</p>

E42_DO_GetFaultValues	This function code is used to get output safe values of contiguous D/O channels.	
C#	int E42_DO_GetFaultValues(Int32	hConnection,
	byte	bytSlot,
	byte	bytStartChannel,
	byte	bytCount,
	UInt32[]	dwValue);
VB.NET	E42_DO_GetFaultValues(ByVal	hConnection As Integer,
	ByVal	bytSlot As Byte,
	ByVal	bytStartChannel As Byte,
	ByVal	bytCount As Byte,
	ByRef	nValue As UInt32)
		As Integer
Arguments	hConnection:	The handle for an I/O device connection.
	bytSlot:	Slot number of the I/O module. Slot numbers range from 1 to 16. But this parameter is inactive on the ioLogik 2000.
	bytStartChannel:	Specifies the starting channel.
	bytCount:	The number of channels to be received.
	dwValue:	A pointer that stores the safe value of contiguous D/O channels; each WORD holds one channel value. A bit value of 0 represents the digital output status of the start channel. A bit value of 1 represents the status of the second digital output channel. The values of the unused bits are random.
Return Value	Succeed	MXIO_OK.
	Fail	Refer to Return Codes.

E42_DO_SetFaultValues	This function code is used to set safe values of contiguous D/O channels.
C#	int E42_DO_SetFaultValues(Int32 hConnection, byte bytSlot, byte bytStartChannel, byte bytCount, UInt32 dwValue);
VB.NET	E42_DO_SetFaultValues(ByVal hConnection As Integer, ByVal bytSlot As Byte, ByVal bytStartChannel As Byte, ByVal bytCount As Byte, ByVal nValue As UInt32) As Integer
Arguments	<p>hConnection: The handle for an I/O device connection.</p> <p>bytSlot: Slot number of the I/O module. Slot numbers range from 1 to 16. But this parameter is inactive on the ioLogik 2000.</p> <p>bytStartChannel: Specifies the starting channel.</p> <p>bytCount: The number of channels to be set.</p> <p>dwValue: A pointer that stores the safe value of contiguous D/O channels; each WORD holds one channel value. A bit value of 0 represents the digital output status of the start channel. A bit value of 1 represents the status of the second digital output channel.</p>
Return Value	<p>Succeed MXIO_OK.</p> <p>Fail Refer to Return Codes.</p>

Digital Output Commands for ioLogik W5000

W5K_DO_Writes	This function code is used to write the output statuses of contiguous D/O channels.	
C#	int W5K_DO_Writes(Int32	hConnection,
	byte	bytStartChannel,
	byte	bytCount,
	UInt32	dwValue);
VB.NET	W5K_DO_Writes	hConnection As Integer,
	(ByVal	bytStartChannel As Byte,
	ByVal	bytCount As Byte,
	ByVal	nValue As UInt32) As Integer
Arguments	hConnection:	The handle for an I/O device connection.
	bytStartChannel:	Specifies the starting channel.
	bytCount:	The number of channels to be written.
	dwValue:	Stores the channel statuses of contiguous D/O channels; each bit holds one channel status. A bit value of 0 represents the digital output status of the start channel. A bit value of 1 represents the second digital output channel's status. The values of the unused bits are random.
Return Value	Succeed	MXIO_OK.
	Fail	Refer to Return Codes.

W5K_DO_GetSafeValues	This function code is used to get output safe values of contiguous D/O channels.
C#	<pre>int W5K_DO_GetSafeValues (Int32 hConnection, byte bytStartChannel, byte bytCount, UInt32[] dwValue);</pre>
VB.NET	<pre>W5K_DO_GetSafeValues (ByVal hConnection As Integer, ByVal bytStartChannel As Byte, ByVal bytCount As Byte, ByRef nValue As UInt32) As Integer</pre>
Arguments	<p>hConnection: The handle for an I/O device connection.</p> <p>bytStartChannel: Specifies the starting channel.</p> <p>bytCount: The number of channels to be gets.</p> <p>dwValue: A pointer that stores the safe value of contiguous D/O channels; each WORD holds one channel value. A bit value of 0 represents the digital output status of the start channel. A bit value of 1 represents the status of the second digital output channel. The values of the unused bits are random.</p>
Return Value	<p>Succeed MXIO_OK.</p> <p>Fail Refer to Return Codes.</p>

W5K_DO_SetSafeValues	This function code is used to set safe values of contiguous D/O channels.
C#	<pre> int W5K_DO_SetSafeValues (Int32 hConnection, byte bytStartChannel, byte bytCount, UInt32 dwValue); </pre>
VB.NET	<pre> W5K_DO_SetSafeValues (ByVal hConnection As Integer, ByVal bytStartChannel As Byte, ByVal bytCount As Byte, ByVal nValue As UInt32) As Integer</pre>
Arguments	<p>hConnection: The handle for an I/O device connection.</p> <p>bytStartChannel: Specifies the starting channel.</p> <p>bytCount: The number of channels to be set.</p> <p>dwValue: A pointer that stores the safe value of contiguous D/O channels; each WORD holds one channel value. A bit value of 0 represents the digital output status of the start channel. A bit value of 1 represents the status of the second digital output channel.</p>
Return Value	<p>Succeed MXIO_OK.</p> <p>Fail Refer to Return Codes.</p>

W5K_DO_GetModes	This function code is used to get the mode of contiguous D/O channels.
C#	<pre>int W5K_DO_GetModes (Int32 hConnection, byte bytStartChannel, byte bytCount, UInt16[] wMode);</pre>
VB.NET	<pre>W5K_DO_GetModes (ByVal hConnection As Integer, ByVal bytStartChannel As Byte, ByVal bytCount As Byte, ByVal iMode() As UInt16) As Integer</pre>
Arguments	<p>hConnection: The handle for an I/O device connection.</p> <p>bytStartChannel: Specifies the starting channel.</p> <p>bytCount: The number of channels to be gets.</p> <p>wMode: An array that stores the mode of contiguous D/O channels. The values are: 0: D/O mode 1: Pulse mode</p>
Return Value	<p>Succeed MXIO_OK.</p> <p>Fail Refer to Return Codes.</p>

W5K_DO_SetModes	This function code is used to set the mode of contiguous D/O channels.
C#	<pre>int W5K_DO_SetModes (Int32 hConnection, byte bytStartChannel, byte bytCount, UInt16[] wMode);</pre>
VB.NET	<pre>W5K_DO_SetModes (ByVal hConnection As Integer, ByVal bytStartChannel As Byte, ByVal bytCount As Byte, ByVal iMode() As UInt16) As Integer</pre>
Arguments	<p>hConnection: The handle for an I/O device connection.</p> <p>bytStartChannel: Specifies the starting channel.</p> <p>bytCount: The number of channels to be set.</p> <p>wMode: An array that stores the mode of contiguous D/O channels. The values are: 0: D/O mode 1: Pulse mode</p>
Return Value	<p>Succeed MXIO_OK.</p> <p>Fail Refer to Return Codes.</p>

W5K_DO_GetPowerOn Values	This function code is used to get the power on value of contiguous D/O channels.
C#	<pre>int W5K_DO_GetPowerOnValues (Int32 hConnection, byte bytStartChannel, byte bytCount, UInt32[] dwValue);</pre>
VB.NET	<pre>W5K_DO_GetPowerOnValues (ByVal hConnection As Integer, ByVal bytStartChannel As Byte, ByVal bytCount As Byte, ByRef nValue As UInt32) As Integer</pre>
Arguments	<p>hConnection: The handle for an I/O device connection.</p> <p>bytStartChannel: Specifies the starting channel.</p> <p>bytCount: The number of channels to be gets.</p> <p>dwValue: A pointer that stores the power on value of contiguous D/O channels; each bit holds one channel value. A bit value of 0 represents the power on status of the start channel. A bit value of 1 represents the status of the second digital output channel. The values of the unused bits are random.</p>
Return Value	<p>Succeed MXIO_OK.</p> <p>Fail Refer to Return Codes.</p>

W5K_DO_SetPowerOnValues	This function code is used to set the power on value of contiguous D/O channels.
C#	<pre>int W5K_DO_SetPowerOnValues (Int32 hConnection, byte bytStartChannel, byte bytCount, UInt32 dwValue);</pre>
VB.NET	<pre>W5K_DO_SetPowerOnValues (ByVal hConnection As Integer, ByVal bytStartChannel As Byte, ByVal bytCount As Byte, ByVal nValue As UInt32) As Integer</pre>
Arguments	<p>hConnection: The handle for an I/O device connection.</p> <p>bytStartChannel: Specifies the starting channel.</p> <p>bytCount: The number of channels to be gets.</p> <p>dwValue: Stores the power on value of contiguous D/O channels; each bit holds one channel value. A bit value of 0 represents the power on status of the start channel. A bit value of 1 represents the status of the second digital output channel. The values of the unused bits are random.</p>
Return Value	<p>Succeed MXIO_OK.</p> <p>Fail Refer to Return Codes.</p>

Digital Output Commands for ioLogik 1200

E1K_DO_Reads	This function code is used to read the output statuses of contiguous D/O channels.
C#	<pre>int E1K_DO_Reads(Int32 hConnection, byte bytStartChannel, byte bytCount, UInt32[] dwValue);</pre>
VB.NET	<pre>E1K_DO_Reads(ByVal hConnection As Integer, ByVal bytStartChannel As Byte, ByVal bytCount As Byte, ByRef nValue As UInt32) As Integer</pre>
Arguments	<p>hConnection: The handle for an I/O device connection.</p> <p>bytStartChannel: Specifies the starting channel.</p> <p>bytCount: The number of channels to be read.</p> <p>dwValue: A pointer that stores the contiguous D/O channel's status; each bit holds one channel value. A bit value of 0 represents the digital output status of the start channel. A bit value of 1 represents the status of the second digital output channel. The values of the unused bits are random.</p>
Return Value	<p>Succeed MXIO_OK.</p> <p>Fail Refer to Return Codes.</p>

E1K_DO_Writes	This function code is used to write the output statuses of contiguous D/O channels.
C#	<pre>int E1K_DO_Writes(Int32 hConnection, byte bytStartChannel, byte bytCount, UInt32 dwValue);</pre>
VB.NET	<pre>E1K_DO_Writes(ByVal hConnection As Integer, ByVal bytStartChannel As Byte, ByVal bytCount As Byte, ByVal nValue As UInt32) As Integer</pre>
Arguments	<p>hConnection: The handle for an I/O device connection.</p> <p>bytStartChannel: Specifies the starting channel.</p> <p>bytCount: The number of channels to be written.</p> <p>dwValue: Stores the channel statuses of contiguous D/O channels; each bit holds one channel status. A bit value of 0 represents the digital output status of the start channel. A bit value of 1 represents the second digital output channel's status. The values of the unused bits are random.</p>
Return Value	<p>Succeed MXIO_OK.</p> <p>Fail Refer to Return Codes.</p>

E1K_DO_GetSafeValues_W	This function code is used to get output safe values of contiguous D/O channels.
C#	int E1K_DO_GetSafeValues(Int32 hConnection, byte bytStartChannel, byte bytCount, UInt16[] wValue);
VB.NET	E1K_DO_GetSafeValues(ByVal hConnection As Integer, ByVal bytStartChannel As Byte, ByVal bytCount As Byte, ByVal wValue() As UInt16) As Integer
Arguments	<p>hConnection: The handle for an I/O device connection.</p> <p>bytStartChannel: Specifies the starting channel.</p> <p>bytCount: The number of channels to be read.</p> <p>wValue: A pointer that stores the safe value of contiguous D/O channels; each word holds one channel value. A word value of 0 represents the digital output of the start channel. A word value of 1 represents the status of the second digital output channel. The values of the unused bits are random.</p> <p>0: OFF 1: ON 2: Hold Last</p>
Return Value	<p>Succeed MXIO_OK.</p> <p>Fail Refer to Return Codes.</p>

E1K_DO_SetSafeValues_W	This function code is used to set safe values of contiguous D/O channels.
C#	int E1K_DO_SetSafeValues(Int32 hConnection, byte bytStartChannel, byte bytCount, UInt16[] wValue);
VB.NET	E1K_DO_SetSafeValues(ByVal hConnection As Integer, ByVal bytStartChannel As Byte, ByVal bytCount As Byte, ByVal wValue() As UInt16) As Integer
Arguments	<p>hConnection: The handle for an I/O device connection.</p> <p>bytStartChannel: Specifies the starting channel.</p> <p>bytCount: The number of channels to be set.</p> <p>wValue: A pointer that stores the safe value of contiguous D/O channels; each word holds one channel value. A word value of 0 represents the digital output status of the start channel. A word value of 1 represents the status of the second digital output channel. The values of the unused bits are random. 0: OFF 1: ON 2: Hold Last</p>
Return Value	<p>Succeed MXIO_OK.</p> <p>Fail Refer to Return Codes.</p>

E1K_DO_GetModes	This function code is used to get the mode of contiguous D/O channels.
C#	<pre>int E1K_DO_GetModes(Int32 hConnection, byte bytStartChannel, byte bytCount, UInt16[] wMode);</pre>
VB.NET	<pre>E1K_DO_GetModes(ByVal hConnection As Integer, ByVal bytStartChannel As Byte, ByVal bytCount As Byte, ByVal iMode() As UInt16) As Integer</pre>
Arguments	<p>hConnection: The handle for an I/O device connection.</p> <p>bytStartChannel: Specifies the starting channel.</p> <p>bytCount: The number of channels to be read.</p> <p>wMode: An array that stores the mode of contiguous D/O channels. The values are: 0: D/O mode 1: Pulse mode</p>
Return Value	<p>Succeed MXIO_OK.</p> <p>Fail Refer to Return Codes.</p>

E1K_DO_SetModes	This function code is used to set the mode of contiguous D/O channels.
C#	<pre>int E1K_DO_SetModes(Int32 hConnection, byte bytStartChannel, byte bytCount, UInt16[] wMode);</pre>
VB.NET	<pre>E1K_DO_SetModes(ByVal hConnection As Integer, ByVal bytStartChannel As Byte, ByVal bytCount As Byte, ByVal iMode() As UInt16) As Integer</pre>
Arguments	<p>hConnection: The handle for an I/O device connection.</p> <p>bytStartChannel: Specifies the starting channel.</p> <p>bytCount: The number of channels to be set.</p> <p>wMode: An array that stores the mode of contiguous D/O channels. The values are: 0: D/O mode 1: Pulse mode</p>
Return Value	<p>Succeed MXIO_OK.</p> <p>Fail Refer to Return Codes.</p>

E1K_DO_GetPowerOnValues	This function code is used to get the power on value of contiguous D/O channels.
C#	<pre>int E1K_DO_GetPowerOnValues (Int32 hConnection, byte bytStartChannel, byte bytCount, UInt32[] dwValue);</pre>
VB.NET	<pre>E1K_DO_GetPowerOnValues(ByVal hConnection As Integer, ByVal bytStartChannel As Byte, ByVal bytCount As Byte, ByRef nValue As UInt32) As Integer</pre>
Arguments	<p>hConnection: The handle for an I/O device connection.</p> <p>bytStartChannel: Specifies the starting channel.</p> <p>bytCount: The number of channels to be read.</p> <p>dwValue: A pointer that stores the power on value of contiguous D/O channels; each bit holds one channel value. A bit value of 0 represents the power on status of the start channel. A bit value of 1 represents the status of the second digital output channel. The values of the unused bits are random.</p>
Return Value	<p>Succeed MXIO_OK.</p> <p>Fail Refer to Return Codes.</p>

E1K_DO_SetPowerOnValues	This function code is used to set the power on value of contiguous D/O channels.
C#	<pre>int E1K_DO_SetPowerOnValues (Int32 hConnection, byte bytStartChannel, byte bytCount, UInt32 dwValue);</pre>
VB.NET	<pre>E1K_DO_SetPowerOnValues(ByVal hConnection As Integer, ByVal bytStartChannel As Byte, ByVal bytCount As Byte, ByVal nValue As UInt32) As Integer</pre>
Arguments	<p>hConnection: The handle for an I/O device connection.</p> <p>bytStartChannel: Specifies the starting channel.</p> <p>bytCount: The number of channels to be set.</p> <p>dwValue: A pointer that stores the power on value of contiguous D/O channels; each bit holds one channel value. A bit value of 0 represents the power on status of the start channel. A bit value of 1 represents the status of the second digital output channel. The values of the unused bits are random.</p>
Return Value	<p>Succeed MXIO_OK.</p> <p>Fail Refer to Return Codes.</p>

E1K_DO_GetPowerOnSeqDelaytimes	This function code is used to get contiguous channel's DI/DO power off storage enable mode.
C#	<pre>int E1K_DO_GetPowerOnSeqDelaytimes (Int32 hConnection, byte bytStartChannel, byte bytCount, UInt16[] wValue);</pre>
VB.NET	<pre>E1K_DO_GetPowerOnSeqDelaytimes(ByVal hConnection As Integer, ByVal bytStartChannel As Byte, ByVal bytCount As Byte, ByVal iValue() As UInt16) As Integer</pre>
Arguments	<p>hConnection: The handle for an I/O device connection.</p> <p>bytStartChannel: Specifies the starting channel.</p> <p>bytCount: The number of channels to be set.</p> <p>wValue: A pointer that stores the contiguous channel's power on sequence delay time (Second) The values are : Range: 0 to 300</p>
Return Value	<p>Succeed MXIO_OK.</p> <p>Fail Refer to Return Codes.</p>

E1K_DO_SetPowerOnSeqDelaytimes	This function code is used to set contiguous channel's DI/DO mode power off storage enable mode.
C#	<pre>int E1K_DO_SetPowerOnSeqDelaytimes (Int32 hConnection, byte bytStartChannel, byte bytCount, UInt16[] wValue);</pre>
VB.NET	<pre>E1K_DO_SetPowerOnSeqDelaytimes(ByVal hConnection As Integer, ByVal bytStartChannel As Byte, ByVal bytCount As Byte, ByVal iValue() As UInt16) As Integer</pre>
Arguments	<p>hConnection: The handle for an I/O device connection.</p> <p>bytStartChannel: Specifies the starting channel.</p> <p>bytCount: The number of channels to be set.</p> <p>wValue: A pointer that stores the contiguous channel's power on sequence delay time (Second) The values are : Range: 0 to 300</p>
Return Value	<p>Succeed MXIO_OK.</p> <p>Fail Refer to Return Codes.</p>

Pulse Output Commands for ioLogik E2000, R2000

Pulse2K_GetSignalWidths	This function code is used to get the Hi/Lo signal widths of contiguous pulse output channels.	
C#	<pre>int Pulse2K_GetSignalWidths(Int32 hConnection, byte bytStartChannel, byte bytCount, UInt16[] wHiWidth, UInt16[] wLoWidth);</pre>	
VB.NET	<pre>Pulse2K_GetSignalWidths(ByVal hConnection As Integer, ByVal bytStartChannel As Byte, ByVal bytCount As Byte, ByVal iHiWidth() As UInt16, ByVal iLoWidth() As UInt16) As Integer</pre>	
Arguments	hConnection:	The handle for an I/O device connection.
	bytStartChannel:	Specifies the starting channel.
	bytCount:	The number of channels to be gets.
	wHiWidth:	An array that stores the Hi signal widths of the contiguous pulse output channels; wHiWidth[0] represents the Hi signal width of the starting channel.
	wLoWidth:	An array that stores the Lo signal widths of the contiguous pulse output channels; wLoWidth[0] represents the Lo signal width of the starting channel.
Return Value	Succeed	MXIO_OK.
	Fail	Refer to Return Codes.

Pulse2K_SetSignalWidths	This function code is used to set the Hi/Lo signal widths of contiguous pulse output channels.	
C#	int	Pulse2K_SetSignalWidths(Int32 hConnection, byte bytStartChannel, byte bytCount, UInt16[] wHiWidth, UInt16[] wLoWidth);
VB.NET	Pulse2K_SetSignalWidths	(ByVal hConnection As Integer, ByVal bytStartChannel As Byte, ByVal bytCount As Byte, ByVal iHiWidth() As UInt16, ByVal iLoWidth() As UInt16) As Integer
Arguments	hConnection:	The handle for an I/O device connection.
	bytStartChannel:	Specifies the starting channel.
	bytCount:	The number of channels to be set.
	wHiWidth:	An array that stores the Hi signal widths of the contiguous pulse output channels; wHiWidth[0] represents the Hi signal width of the starting channel.
	wLoWidth:	An array that stores the Lo signal widths of the contiguous pulse output channels; wLoWidth[0] represents the Lo signal width of the starting channel.
Return Value	Succeed	MXIO_OK.
	Fail	Refer to Return Codes.

Pulse2K_GetSignalWidth	This function code is used to get the Hi/Lo signal width for a specific pulse channel.	
C#	int	Pulse2K_GetSignalWidth(Int32 hConnection, byte bytChannel, UInt16[] wHiWidth, UInt16[] wLoWidth);
VB.NET	Pulse2K_GetSignalWidth(ByVal hConnection As Integer, ByVal bytChannel As Byte, ByVal iHiWidth As UInt16, ByVal iLoWidth As UInt16) As Integer	
Arguments	hConnection:	The handle for an I/O device connection.
	bytChannel:	The specific channel to be get.
	wHiWidth:	A pointer that stores the specific pulse channel's Hi signal width to be get.
	wLoWidth:	A pointer that stores the specific pulse channel's Lo signal width to be get.
Return Value	Succeed	MXIO_OK.
	Fail	Refer to Return Codes.

Pulse2K_SetSignalWidth	This function code is used to set the Hi/Lo signal width for a specific pulse channel.	
C#	int	Pulse2K_SetSignalWidth(Int32 hConnection, byte bytChannel, UInt16 wHiWidth, UInt16 wLoWidth);
VB.NET	Pulse2K_SetSignalWidth(ByVal hConnection As Integer, ByVal bytChannel As Byte, ByVal iHiWidth As UInt16, ByVal iLoWidth As UInt16) As Integer	
Arguments	hConnection:	The handle for an I/O device connection.
	bytChannel:	The specific channel to be set.
	wHiWidth:	A pointer that stores the specific pulse channel's Hi signal width to be set.
	wLoWidth:	A pointer that stores the specific pulse channel's Lo signal width to be set.
Return Value	Succeed	MXIO_OK.
	Fail	Refer to Return Codes.

Pulse2K_GetSignalWidths32	<p>This function code is used to get the contiguous pulse channel's Hi/Lo signal width (32 bits). The function code is designed for the ioLogik E2260 only.</p>
C#	<pre>int Pulse2K_GetSignalWidths32(Int32 hConnection, byte bytStartChannel, byte bytCount, UInt32[] dwHiWidth, UInt32[] dwLoWidth);</pre>
VB.NET	<pre>Pulse2K_GetSignalWidths32 (ByVal hConnection As Integer, ByVal bytStartChannel As Byte, ByVal bytCount As Byte, ByVal iHiWidth() As UInt32, ByVal iLoWidth() As UInt32) As Integer</pre>
Arguments	<p>hConnection: The handle for an I/O device connection.</p> <p>bytStartChannel: Specifies the starting channel.</p> <p>bytCount: The number of channels to be get.</p> <p>dwHiWidth: An array that stores the contiguous pulse channel's Hi signal width, dwHiWidth[0] represents the Hi signal width of the starting channel.</p> <p>dwLoWidth: An array that stores the contiguous pluse channel's Lo signal width ,dwLoWidth[0] represents the Lo signal width of the starting channel.</p>
Return Value	<p>Succeed MXIO_OK.</p> <p>Fail Refer to Return Codes.</p>

Pulse2K_SetSignalWidths32	This function code is used to set the contiguous pulse channel's Hi/Lo signal width (32 bits). The function code is designed for the ioLogik E2260 only.
C#	<pre>int Pulse2K_SetSignalWidths32(Int32 hConnection, byte bytStartChannel, byte bytCount, UInt32[] dwHiWidth, UInt32[] dwLoWidth);</pre>
VB.NET	<pre>Pulse2K_SetSignalWidths32 (ByVal hConnection As Integer, ByVal bytStartChannel As Byte, ByVal bytCount As Byte, ByVal iHiWidth() As UInt32, ByVal iLoWidth() As UInt32) As Integer</pre>
Arguments	<p>hConnection: The handle for an I/O connection.</p> <p>bytStartChannel: Specifies the starting channel.</p> <p>bytCount: The number of channels to set.</p> <p>dwHiWidth: An array that stores the contiguous pulse channel's Hi signal width, dwHiWidth[0] represents the Hi signal width of the starting channel.</p> <p>dwLoWidth: An array that stores the contiguous pulse channel's Lo signal width , dwLoWidth[0] represents the Lo signal width of the starting channel.</p>
Return Value	<p>Succeed: MXIO_OK.</p> <p>Fail: Refer to Return Codes.</p>

Pulse2K_GetSignalWidth32	This function code is used to get the Hi/Lo signal width (32 bits) for a specific pulse channel. The function code is designed for the ioLogik E2260 only.	
C#	<pre>int Pulse2K_GetSignalWidth32(Int32 hConnection, byte bytChannel, UInt32[] dwHiWidth, UInt32[] dwLoWidth);</pre>	
VB.NET	<pre>Pulse2K_GetSignalWidth32 (ByVal hConnection As Integer, ByVal bytChannel As Byte, ByRef iHiWidth As UInt32, ByRef iLoWidth As UInt32) As Integer</pre>	
Arguments	hConnection:	The handle for an I/O device connection.
	bytChannel:	The specific channel to be get.
	dwHiWidth:	A pointer that stores the specific pulse channel's Hi signal width.
	dwLoWidth:	A pointer that stores the specific pulse channel's Lo signal width.
Return Value	Succeed	MXIO_OK.
	Fail	Refer to Return Codes.

Pulse2K_SetSignalWidth32	<p>This function code is used to set the Hi/Lo signal width (32 bits) for a specific pulse channel. The function code is designed for the ioLogik E2260 only.</p>
<p>C#</p> <p>VB.NET</p>	<pre>int Pulse2K_SetSignalWidth32(Int32 hConnection, byte bytChannel, UInt32 dwHiWidth, UInt32 dwLoWidth);</pre> <pre>Pulse2K_SetSignalWidth32 (ByVal hConnection As Integer, ByVal bytChannel As Byte, ByVal iHiWidth As UInt32, ByVal iLoWidth As UInt32) As Integer</pre>
Arguments	<p>hConnection: The handle for an I/O device connection.</p> <p>bytChannel: The specific channel to be set.</p> <p>dwHiWidth: Store the specific pulse channel's Hi signal width.</p> <p>dwLoWidth: Store the specific pulse channel's Lo signal width.</p>
Return Value	<p>Succeed MXIO_OK.</p> <p>Fail Refer to Return Codes.</p>

Pulse2K_GetOutputCounts	This function code is used to get the contiguous pulse channel's output count.
C#	int Pulse2K_GetOutputCounts(Int32 hConnection, byte bytStartChannel, byte bytCount, UInt32[] dwOutputCounts);
VB.NET	Pulse2K_GetOutputCounts (ByVal hConnection As Integer, ByVal bytStartChannel As Byte, ByVal bytCount As Byte, ByVal nOutputCounts() As UInt32) As Integer
Arguments	<p>hConnection: The handle for an I/O device connection.</p> <p>bytStartChannel: Specifies the starting channel.</p> <p>bytCount: The number of channels to be gets.</p> <p>dwOutputCounts: An array that stores the output count, dwOutputCounts[0] represents the pulse output count of the starting channel.</p>
Return Value	<p>Succeed MXIO_OK.</p> <p>Fail Refer to Return Codes.</p>

Pulse2K_SetOutputCounts	This function code is used to set the output counts for contiguous pulse output channels.
C#	int Pulse2K_SetOutputCounts(Int32 hConnection, byte bytStartChannel, byte bytCount, UInt32[] dwOutputCounts);
VB.NET	Pulse2K_SetOutputCounts (ByVal hConnection As Integer, ByVal bytStartChannel As Byte, ByVal bytCount As Byte, ByVal nOutputCounts() As UInt32) As Integer
Arguments	<p>hConnection: The handle for an I/O device connection.</p> <p>bytStartChannel: Specifies the starting channel.</p> <p>bytCount: The number of channels to be set.</p> <p>dwOutputCounts: An array that stores the output counts of the contiguous pulse output channels; dwOutputCounts[0] represents the pulse output count of the starting channel.</p>
Return Value	<p>Succeed MXIO_OK.</p> <p>Fail Refer to Return Codes.</p>

Pulse2K_GetOutputCount	This function code is used to get the output count for a specific pulse channel.
C#	int Pulse2K_GetOutputCount(Int32 hConnection, byte bytChannel, UInt32[] dwOutputCount);
VB.NET	Pulse2K_GetOutputCount (ByVal hConnection As Integer, ByVal bytChannel As Byte, ByRef nOutputCount As UInt32) As Integer
Arguments	<p>hConnection: The handle for an I/O device connection.</p> <p>bytChannel: The specific channel to be get .</p> <p>dwOutputCounts: A pointer that stores the specific pulse channel's output count.</p>
Return Value	<p>Succeed MXIO_OK.</p> <p>Fail Refer to Return Codes.</p>

Pulse2K_SetOutputCount	This function code is used to set the output count for a specific pulse channel.
C#	int Pulse2K_SetOutputCount(Int32 hConnection, byte bytChannel, UInt32 dwOutputCount);
VB.NET	Pulse2K_SetOutputCount (ByVal hConnection As Integer, ByVal bytChannel As Byte, ByVal dwOutputCount As UInt32) As Integer
Arguments	<p>hConnection: The handle for an I/O device connection.</p> <p>bytChannel: The specific channel to be set.</p> <p>dwOutputCounts: A pointer that stores the specific pulse channel's output count.</p>
Return Value	<p>Succeed MXIO_OK.</p> <p>Fail Refer to Return Codes.</p>

Pulse2K_GetStartStatuses	This function code is used to get the start statuses of contiguous pulse channels.
C#	<pre>int Pulse2K_GetStartStatuses(Int32 hConnection, byte bytStartChannel, byte bytCount, UInt32[] dwStatus);</pre>
VB.NET	<pre>Pulse2K_GetStartStatuses (ByVal hConnection As Integer, ByVal bytStartChannel As Byte, ByVal bytCount As Byte, ByRef iValue As UInt16) As Integer</pre>
Arguments	<p>hConnection: The handle for an I/O device connection.</p> <p>bytStartChannel: Specifies the starting channel.</p> <p>bytCount: The number of channels to be get.</p> <p>dwStatus: An point that stores the start statuses for the contiguous pulse channels; each bit holds the value of one channel. A bit value of 0 represents the start status of the start channel. A bit value of 1 represents the status of the second pulse channel. The values are: 0: stop 1: start</p>
Return Value	<p>Succeed MXIO_OK.</p> <p>Fail Refer to Return Codes.</p>

Pulse2K_SetStartStatuses	This function code is used to set the start statuses of contiguous pulse channels.
C#	int Pulse2K_SetStartStatuses(Int32 hConnection, byte bytStartChannel, byte bytCount, UInt32 dwStatus);
VB.NET	Pulse2K_SetStartStatuses (ByVal hConnection As Integer, ByVal bytStartChannel As Byte, ByVal bytCount As Byte, ByVal iValue As UInt16) As Integer
Arguments	<p>hConnection: The handle for an I/O device connection.</p> <p>bytStartChannel: Specifies the starting channel.</p> <p>bytCount: The number of channels to be set.</p> <p>dwStatus: Stores the start statuses of the contiguous pulse channels; each bit holds the value of one channel. A bit value of 0 represents the start status of the start channel. A bit value of 1 represents the status of the second pulsevchannel. The values are :</p> <p>0: stop 1: start</p>
Return Value	<p>Succeed MXIO_OK.</p> <p>Fail Refer to Return Codes.</p>

Pulse2K_GetStartStatus	This function code is used to get the start status for a specific pulse channel.
C#	int Pulse2K_GetStartStatus(Int32 hConnection, byte bytChannel, byte[] bytStatus);
VB.NET	Pulse2K_GetStartStatus (ByVal hConnection As Integer, ByVal bytChannel As Byte, ByRef iValue As UInt16) As Integer
Arguments	<p>hConnection: The handle for an I/O device connection.</p> <p>bytChannel: The specific channel to be get.</p> <p>bytStatus: A pointer that stores the specific pulse channel's start status. The values are: 0: stop 1: start</p>
Return Value	<p>Succeed MXIO_OK.</p> <p>Fail Refer to Return Codes.</p>

Pulse2K_SetStartStatus	This function code is used to set the start status for a specific pulse channel.
C#	int Pulse2K_SetStartStatus(Int32 hConnection, byte bytChannel, byte bytStatus);
VB.NET	Pulse2K_SetStartStatus (ByVal hConnection As Integer, ByVal bytChannel As Byte, ByVal iValue As UInt16) As Integer
Arguments	<p>hConnection: The handle for an I/O device connection.</p> <p>bytChannel: The specific channel to be set.</p> <p>bytStatus: A pointer that stores the specific pulse channel's start status. The values are: 0: stop 1: start</p>
Return Value	<p>Succeed MXIO_OK.</p> <p>Fail Refer to Return Codes.</p>

Pulse2K_GetPowerOnValues	This function code is used to get the power on values for contiguous pulse channels.
C#	int Pulse2K_GetPowerOnValues(Int32 hConnection, byte bytStartChannel, byte bytCount, UInt32[] dwValue);
VB.NET	Pulse2K_GetPowerOnValues (ByVal hConnection As Integer, ByVal bytStartChannel As Byte, ByVal bytCount As Byte, ByRef nValue As UInt32) As Integer
Arguments	<p>hConnection: The handle for an I/O device connection.</p> <p>bytStartChannel: Specifies the starting channel.</p> <p>bytCount: The number of channels to be gets.</p> <p>bytStatus: A pointer to the power on values of the contiguous pulse channels; each bit holds the value of one channel. A bit value of 0 represents the power on value of the start channel. A bit value of 1 represents the value of the second pulse channel. The values are:</p> <p>0: stop 1: start</p>
Return Value	<p>Succeed MXIO_OK.</p> <p>Fail Refer to Return Codes.</p>

Pulse2K_SetPowerOnValues	This function code is used to set the power on values of contiguous pulse channels.
C#	int Pulse2K_SetPowerOnValues(Int32 hConnection, byte bytStartChannel, byte bytCount, UInt32 dwValue);
VB.NET	Pulse2K_SetPowerOnValues (ByVal hConnection As Integer, ByVal bytStartChannel As Byte, ByVal bytCount As Byte, ByVal nValue As UInt32) As Integer
Arguments	<p>hConnection: The handle for an I/O device connection.</p> <p>bytStartChannel: Specifies the starting channel.</p> <p>bytCount: The number of channels to be set.</p> <p>dwValue: Stores the power on values for the contiguous channels; each bit holds the value of one channel. A bit value of 0 represents the power on value of the start channel. A bit value of 1 represents the value of the second pulse channel. The values are: 0: stop 1: start</p>
Return Value	<p>Succeed MXIO_OK.</p> <p>Fail Refer to Return Codes.</p>

Pulse2K_GetPowerOnValue	This function code is used to get the power on value for a specific pulse channel.
C#	int Pulse2K_GetPowerOnValue(Int32 hConnection, byte bytChannel, byte[] bytValue);
VB.NET	Pulse2K_GetPowerOnValue (ByVal hConnection As Integer, ByVal bytChannel As Byte, ByRef bytValue As Byte) As Integer
Arguments	<p>hConnection: The handle for an I/O device connection.</p> <p>bytChannel: The specific channel to be get.</p> <p>bytValue: A pointer that stores the specific pulse channel's power on value. The values are: 0: stop 1: start</p>
Return Value	<p>Succeed MXIO_OK.</p> <p>Fail Refer to Return Codes.</p>

Pulse2K_SetPowerOnValue	This function code is used to set the power on value for a specific pulse channel.
C#	int Pulse2K_SetPowerOnValue(Int32 hConnection, byte bytChannel, byte bytValue);
VB.NET	Pulse2K_SetPowerOnValue (ByVal hConnection As Integer, ByVal bytChannel As Byte, ByVal bytValue As Byte) As Integer
Arguments	<p>hConnection: The handle for an I/O device connection.</p> <p>bytChannel: The specific channel to be set.</p> <p>bytValue: A pointer that stores the specific pulse channel's power on value. The values are: 0: stop 1: start</p>
Return Value	<p>Succeed MXIO_OK.</p> <p>Fail Refer to Return Codes.</p>

Pulse2K_GetSafeValues	This function code is used to get the safe values of contiguous pulse channels.
C#	int Pulse2K_GetSafeValues(Int32 hConnection, byte bytStartChannel, byte bytCount, UInt32[] dwValue);
VB.NET	Pulse2K_GetSafeValues (ByVal hConnection As Integer, ByVal bytStartChannel As Byte, ByVal bytCount As Byte, ByRef nValue As UInt32) As Integer
Arguments	<p>hConnection: The handle for an I/O device connection.</p> <p>bytStartChannel: Specifies the starting channel.</p> <p>bytCount: The number of channels to be gets.</p> <p>dwValue: A pointer to the safe values for the contiguous channels; each bit holds the value of one channel. A bit value of 0 represents the safe value of the start channel. A bit value of 1 represents the value of the second pulse channel. The values are: 0: stop 1: start</p>
Return Value	<p>Succeed MXIO_OK.</p> <p>Fail Refer to Return Codes.</p>

Pulse2K_SetSafeValues	This function code is used to set the safe values of contiguous pulse channels.
C#	int Pulse2K_SetSafeValues(Int32 hConnection, byte bytStartChannel, byte bytCount, UInt32 dwValue);
VB.NET	Pulse2K_SetSafeValues (ByVal hConnection As Integer, ByVal bytStartChannel As Byte, ByVal bytCount As Byte, ByVal nValue As UInt32) As Integer
Arguments	<p>hConnection: The handle for an I/O device connection.</p> <p>bytStartChannel: Specifies the starting channel.</p> <p>bytCount: The number of channels to be set.</p> <p>dwValue: Stores the safe value, each bit holds the value of one channel. A bit value of 0 represents the safe value of the start channel. A bit value of 1 represents the value of the second pulse channel. The values are: 0: stop 1: start</p>
Return Value	<p>Succeed MXIO_OK.</p> <p>Fail Refer to Return Codes.</p>

Pulse2K_GetSafeValue	This function code is used to get the safe value for a specific pulse channel.
C#	int Pulse2K_GetSafeValue(Int32 hConnection, byte bytChannel, byte[] bytValue);
VB.NET	Pulse2K_GetSafeValue (ByVal hConnection As Integer, ByVal bytChannel As Byte, ByVal bytValue As Byte) As Integer
Arguments	<p>hConnection: The handle for an I/O device connection.</p> <p>bytChannel: The specific channel to be get.</p> <p>bytValue: A pointer to the specific pulse channel's power on value. The values are: 0: stop 1: start</p>
Return Value	<p>Succeed MXIO_OK.</p> <p>Fail Refer to Return Codes.</p>

Pulse2K_SetSafeValue	This function code is used to set the safe value for a specific pulse channel.
C#	int Pulse2K_SetSafeValue(Int32 hConnection, byte bytChannel, byte bytValue);
VB.NET	Pulse2K_SetSafeValue (ByVal hConnection As Integer, ByVal bytChannel As Byte, ByVal bytValue As Byte) As Integer
Arguments	<p>hConnection: The handle for an I/O device connection.</p> <p>bytChannel: The specific channel to be set.</p> <p>bytValue: Stores the specific pulse channel's power on value. The values are: 0: stop 1: start</p>
Return Value	<p>Succeed MXIO_OK.</p> <p>Fail Refer to Return Codes.</p>

Pulse Output Commands for ioLogik W5000

W5K_Pulse_GetSignalWidths32	This function code is used to get the contiguous pulse channel's Hi/Lo signal width(32 bits)
C#	<pre>int W5K_Pulse_GetSignalWidths32 (Int32 hConnection, byte bytStartChannel, byte bytCount, UInt32[] dwHiWidth, UInt32[] dwLoWidth);</pre>
VB.NET	<pre>W5K_Pulse_GetSignalWidths32 (ByVal hConnection As Integer, ByVal bytStartChannel As Byte, ByVal bytCount As Byte, ByVal iHiWidth() As UInt32, ByVal iLoWidth() As UInt32) As Integer</pre>
Arguments	<p>hConnection: The handle for an I/O device connection.</p> <p>bytStartChannel: Specifies the starting channel.</p> <p>bytCount: The number of channels to be gets.</p> <p>dwHiWidth: An array that stores the contiguous pulse channel's Hi signal width, dwHiWidth[0] represents the Hi signal width of the starting channel.</p> <p>dwLoWidth: An array that stores the contiguous pulse channel's Lo signal width, dwLoWidth[0] represents the Lo signal width of the starting channel.</p>
Return Value	<p>Succeed MXIO_OK.</p> <p>Fail Refer to Return Codes.</p>

W5K_Pulse_SetSignalWidths32	This function code is used to set the contiguous pulse channel's Hi/Lo signal width(32 bits)
C#	<pre>int W5K_Pulse_SetSignalWidths32 (Int32 hConnection, byte bytStartChannel, byte bytCount, UInt32[] dwHiWidth, UInt32[] dwLoWidth);</pre>
VB.NET	<pre>W5K_Pulse_SetSignalWidths32 (ByVal hConnection As Integer, ByVal bytStartChannel As Byte, ByVal bytCount As Byte, ByVal iHiWidth() As UInt32, ByVal iLoWidth() As UInt32) As Integer</pre>
Arguments	<p>hConnection: The handle for an I/O device connection.</p> <p>bytStartChannel: Specifies the starting channel.</p> <p>bytCount: The number of channels to be set.</p> <p>dwHiWidth: An array that stores the contiguous pulse channel's Hi signal width, dwHiWidth[0] represents the Hi signal width of the starting channel.</p> <p>dwLoWidth: An array that stores the contiguous pulse channel's Lo signal width, dwLoWidth[0] represents the Lo signal width of the starting channel.</p>
Return Value	<p>Succeed MXIO_OK.</p> <p>Fail Refer to Return Codes.</p>

W5K_Pulse_GetOutput Counts	This function code is used to get the contiguous pulse channel's output count.
C#	<pre>int W5K_Pulse_GetOutputCounts (Int32 hConnection, byte bytStartChannel, byte bytCount, UInt32[] dwOutputCounts);</pre>
VB.NET	<pre>W5K_Pulse_GetOutputCounts (ByVal hConnection As Integer, ByVal bytStartChannel As Byte, ByVal bytCount As Byte, ByVal nOutputCounts() As UInt32) As Integer</pre>
Arguments	<p>hConnection: The handle for an I/O device connection.</p> <p>bytStartChannel: Specifies the starting channel.</p> <p>bytCount: The number of channels to be gets.</p> <p>dwOutputCounts: An array that stores the contiguous pulse channel's output count, dwOutputCounts[0] represents the pulse output count of the starting channel.</p>
Return Value	<p>Succeed MXIO_OK.</p> <p>Fail Refer to Return Codes.</p>

W5K_Pulse_SetOutput Counts	This function code is used to set the contiguous pulse channel's output count.
C#	<pre>int W5K_Pulse_SetOutputCounts (Int32 hConnection, byte bytStartChannel, byte bytCount, UInt32[] dwOutputCounts);</pre>
VB.NET	<pre>W5K_Pulse_SetOutputCounts (ByVal hConnection As Integer, ByVal bytStartChannel As Byte, ByVal bytCount As Byte, ByVal nOutputCounts() As UInt32) As Integer</pre>
Arguments	<p>hConnection: The handle for an I/O device connection.</p> <p>bytStartChannel: Specifies the starting channel.</p> <p>bytCount: The number of channels to be set.</p> <p>dwOutputCounts: An array that stores the contiguous pulse channel's output count, dwOutputCounts[0] represents the pulse output count of the starting channel.</p>
Return Value	<p>Succeed MXIO_OK.</p> <p>Fail Refer to Return Codes.</p>

W5K_Pulse_GetStartStatuses	This function code is used to get the contiguous pulse channel's start status.
C#	<pre>int W5K_Pulse_GetStartStatuses (Int32 hConnection, byte bytStartChannel, byte bytCount, UInt32[] dwStatus);</pre>
VB.NET	<pre>W5K_Pulse_GetStartStatuses (ByVal hConnection As Integer, ByVal bytStartChannel As Byte, ByVal bytCount As Byte, ByRef iValue As UInt16) As Integer</pre>
Arguments	<p>hConnection: The handle for an I/O device connection.</p> <p>bytStartChannel: Specifies the starting channel.</p> <p>bytCount: The number of channels to be gets.</p> <p>dwStatus: An point that stores the contiguous pulse channel's start status, each bit holds one channel value. A bit value of 0 represents the start status of the start channel. A bit value of 1 represents the status of the second pulse channel. The values are:</p> <p>0: stop</p> <p>1: start</p>
Return Value	<p>Succeed MXIO_OK.</p> <p>Fail Refer to Return Codes.</p>

W5K_Pulse_SetStartStatuses	This function code is used to set the contiguous pulse channel's start status.
C#	<pre>int W5K_Pulse_SetStartStatuses (Int32 hConnection, byte bytStartChannel, byte bytCount, UInt32 dwStatus);</pre>
VB.NET	<pre>W5K_Pulse_SetStartStatuses (ByVal hConnection As Integer, ByVal bytStartChannel As Byte, ByVal bytCount As Byte, ByVal iValue As UInt16) As Integer</pre>
Arguments	<p>hConnection: The handle for an I/O device connection.</p> <p>bytStartChannel: Specifies the starting channel.</p> <p>bytCount: The number of channels to be set.</p> <p>dwStatus: An point that stores the contiguous pulse channel's start status, each bit holds one channel value. A bit value of 0 represents the start status of the start channel. A bit value of 1 represents the status of the second pulse channel. The values are:</p> <p>0: stop 1: start</p>
Return Value	<p>Succeed MXIO_OK.</p> <p>Fail Refer to Return Codes.</p>

W5K_Pulse_GetPowerOn Values	This function code is used to get the contiguous pulse channel's power on value.
C#	<pre>int W5K_Pulse_GetPowerOnValues (Int32 hConnection, byte bytStartChannel, byte bytCount, UInt32[] dwValue);</pre>
VB.NET	<pre>W5K_Pulse_GetPowerOnValues (ByVal hConnection As Integer, ByVal bytStartChannel As Byte, ByVal bytCount As Byte, ByRef nValue As UInt32) As Integer</pre>
Arguments	<p>hConnection: The handle for an I/O device connection.</p> <p>bytStartChannel: Specifies the starting channel.</p> <p>bytCount: The number of channels to be gets.</p> <p>bytStatus: An point that stores the contiguous pulse channe's power on value, each bit holds one channel value. A bit value of 0 represents the power on value of the start channel. A bit value of 1 represents the value of the second pulse channel. The values are: 0: stop 1: start</p>
Return Value	<p>Succeed MXIO_OK.</p> <p>Fail Refer to Return Codes.</p>

W5K_Pulse_SetPowerOn Values	This function code is used to set the contiguous pulse channel's power on value.
C#	<pre>int W5K_Pulse_SetPowerOnValues (Int32 hConnection, byte bytStartChannel, byte bytCount, UInt32 dwValue);</pre>
VB.NET	<pre>W5K_Pulse_SetPowerOnValues (ByVal hConnection As Integer, ByVal bytStartChannel As Byte, ByVal bytCount As Byte, ByVal nValue As UInt32) As Integer</pre>
Arguments	<p>hConnection: The handle for an I/O device connection.</p> <p>bytStartChannel: Specifies the starting channel.</p> <p>bytCount: The number of channels to be set.</p> <p>dwValue: Stores the contiguous pulse channel's power on value, each bit holds one channel value. A bit value of 0 represents the power on value of the start channel. A bit value of 1 represents the value of the second pulse channel. The values are:</p> <p>0: stop 1: start</p>
Return Value	<p>Succeed MXIO_OK.</p> <p>Fail Refer to Return Codes.</p>

W5K_Pulse_GetSafeValues	This function code is used to get the contiguous pulse channel's safe value.
C#	<pre>int W5K_Pulse_GetSafeValues (Int32 hConnection, byte bytStartChannel, byte bytCount, UInt32[] dwValue);</pre>
VB.NET	<pre>W5K_Pulse_GetSafeValues (ByVal hConnection As Integer, ByVal bytStartChannel As Byte, ByVal bytCount As Byte, ByRef nValue As UInt32) As Integer</pre>
Arguments	<p>hConnection: The handle for an I/O device connection.</p> <p>bytStartChannel: Specifies the starting channel.</p> <p>bytCount: The number of channels to be gets.</p> <p>dwValue: An point that stores the contiguous pulse channel's safe value, each bit holds one channel value. A bit value of 0 represents the safe value of the start channel. A bit value of 1 represents the value of the second pulse channel. The values are:</p> <p>0: stop 1: start</p>
Return Value	<p>Succeed MXIO_OK.</p> <p>Fail Refer to Return Codes.</p>

W5K_Pulse_SetSafeValues	This function code is used to set the contiguous pulse channel's safe value.
C#	<pre>int W5K_Pulse_SetSafeValues (Int32 hConnection, byte bytStartChannel, byte bytCount, UInt32 dwValue);</pre>
VB.NET	<pre>W5K_Pulse_SetSafeValues (ByVal hConnection As Integer, ByVal bytStartChannel As Byte, ByVal bytCount As Byte, ByVal nValue As UInt32) As Integer</pre>
Arguments	<p>hConnection: The handle for an I/O device connection.</p> <p>bytStartChannel: Specifies the starting channel.</p> <p>bytCount: The number of channels to be set.</p> <p>dwValue: An point that stores the contiguous pulse channel's safe value, each bit holds one channel value. A bit value of 0 represents the safe value of the start channel. A bit value of 1 represents the value of the second pulse channel. The values are:</p> <p>0: stop 1: start</p>
Return Value	<p>Succeed MXIO_OK.</p> <p>Fail Refer to Return Codes.</p>

Pulse Output Commands for ioLogik E1200

E1K_Pulse_GetSignalWidths	This function code is used to get the contiguous pulse channel's Hi/Lo signal width (32 bits).
C#	<pre>int E1K_Pulse_GetSignalWidths (Int32 hConnection, byte bytStartChannel, byte bytCount, UInt32[] dwHiWidth, UInt32[] dwLoWidth);</pre>
VB.NET	<pre>E1K_Pulse_GetSignalWidths(ByVal hConnection As Integer, ByVal bytStartChannel As Byte, ByVal bytCount As Byte, ByVal iHiWidth() As UInt32, ByVal iLoWidth() As UInt32) As Integer</pre>
Arguments	<p>hConnection: The handle for an I/O device connection.</p> <p>bytStartChannel: Specifies the starting channel.</p> <p>bytCount: The number of channels to be read.</p> <p>dwHiWidth: An array that stores the contiguous pulse channel's Hi signal width, dwHiWidth[0] represents the Hi signal width of the starting channel.</p> <p>dwLowwidth: An array that stores the contiguous pulse channel's Lo signal width, dwLoWidth[0] represents the Lo signal width of the starting channel.</p>
Return Value	<p>Succeed MXIO_OK.</p> <p>Fail Refer to Return Codes.</p>

E1K_Pulse_SetSignalWidths	This function code is used to set the contiguous pulse channel's Hi/Lo signal width (32 bits).
C#	<pre>int E1K_Pulse_SetSignalWidths (Int32 hConnection, byte bytStartChannel, byte bytCount, UInt32[] dwHiWidth, UInt32[] dwLoWidth);</pre>
VB.NET	<pre>E1K_Pulse_SetSignalWidths(ByVal hConnection As Integer, ByVal bytStartChannel As Byte, ByVal bytCount As Byte, ByVal iHiWidth() As UInt32, ByVal iLoWidth() As UInt32) As Integer</pre>
Arguments	<p>hConnection: The handle for an I/O device connection.</p> <p>bytStartChannel: Specifies the starting channel.</p> <p>bytCount: The number of channels to be set.</p> <p>dwHiWidth: An array that stores the contiguous pulse channel's Hi signal width, dwHiWidth[0] represents the Hi signal width of the starting channel.</p> <p>dwLowwidth: An array that stores the contiguous pulse channel's Lo signal width, dwLoWidth[0] represents the Lo signal width of the starting channel.</p>
Return Value	<p>Succeed MXIO_OK.</p> <p>Fail Refer to Return Codes.</p>

E1K_Pulse_GetOutputCounts	This function code is used to get the contiguous pulse channel's output count.
C#	<pre>int E1K_Pulse_GetOutputCounts (Int32 hConnection, byte bytStartChannel, byte bytCount, UInt32[] dwOutputCounts);</pre>
VB.NET	<pre>E1K_Pulse_GetOutputCounts(ByVal hConnection As Integer, ByVal bytStartChannel As Byte, ByVal bytCount As Byte, ByVal nOutputCounts() As UInt32) As Integer</pre>
Arguments	<p>hConnection: The handle for an I/O device connection.</p> <p>bytStartChannel: Specifies the starting channel.</p> <p>bytCount: The number of channels to be read.</p> <p>dwOutputCounts: An array that stores the contiguous pulse channel's output count, dwOutputCounts[0] represents the pulse output count of the starting channel.</p>
Return Value	<p>Succeed MXIO_OK.</p> <p>Fail Refer to Return Codes.</p>

E1K_Pulse_SetOutputCounts	This function code is used to set the contiguous pulse channel's output count.
C#	<pre>int E1K_Pulse_SetOutputCounts (Int32 hConnection, byte bytStartChannel, byte bytCount, UInt32[] dwOutputCounts);</pre>
VB.NET	<pre>E1K_Pulse_SetOutputCounts(ByVal hConnection As Integer, ByVal bytStartChannel As Byte, ByVal bytCount As Byte, ByVal nOutputCounts() As UInt32) As Integer</pre>
Arguments	<p>hConnection: The handle for an I/O device connection.</p> <p>bytStartChannel: Specifies the starting channel.</p> <p>bytCount: The number of channels to be set.</p> <p>dwOutputCounts: An array that stores the contiguous pulse channel's output count, dwOutputCounts[0] represents the pulse output count of the starting channel.</p>
Return Value	<p>Succeed MXIO_OK.</p> <p>Fail Refer to Return Codes.</p>

E1K_Pulse_GetStartStatuses	This function code is used to get the contiguous pulse channel's start status.
C#	<pre>int E1K_Pulse_GetStartStatuses (Int32 hConnection, byte bytStartChannel, byte bytCount, UInt32[] dwStatus);</pre>
VB.NET	<pre>E1K_Pulse_GetStartStatuses(ByVal hConnection As Integer, ByVal bytStartChannel As Byte, ByVal bytCount As Byte, ByRef iValue As UInt16) As Integer</pre>
Arguments	<p>hConnection: The handle for an I/O device connection.</p> <p>bytStartChannel: Specifies the starting channel.</p> <p>bytCount: The number of channels to be read.</p> <p>dwStatus: A pointer that stores the contiguous pulse channel's start status, each bit holds one channel value. A bit value of 0 represents the start status of the start channel. A bit value of 1 represents the status of the second pulse channel. The values are:</p> <p style="padding-left: 40px;">0: stop</p> <p style="padding-left: 40px;">1: start</p>
Return Value	<p>Succeed MXIO_OK.</p> <p>Fail Refer to Return Codes.</p>

E1K_Pulse_SetStartStatuses	This function code is used to set the contiguous pulse channel's start status.
C#	<pre>int E1K_Pulse_SetStartStatuses (Int32 hConnection, byte bytStartChannel, byte bytCount, UInt32 dwStatus);</pre>
VB.NET	<pre>E1K_Pulse_SetStartStatuses(ByVal hConnection As Integer, ByVal bytStartChannel As Byte, ByVal bytCount As Byte, ByVal iValue As UInt16) As Integer</pre>
Arguments	<p>hConnection: The handle for an I/O device connection.</p> <p>bytStartChannel: Specifies the starting channel.</p> <p>bytCount: The number of channels to be set.</p> <p>dwStatus: A pointer that stores the contiguous pulse channel's start status, each bit holds one channel value. A bit value of 0 represents the start status of the start channel. A bit value of 1 represents the status of the second pulse channel. The values are:</p> <p>0: stop</p> <p>1: start</p>
Return Value	<p>Succeed MXIO_OK.</p> <p>Fail Refer to Return Codes.</p>

E1K_Pulse_GetPowerOnValues	This function code is used to get the contiguous pulse channel's power on value.
C#	<pre>int E1K_Pulse_GetPowerOnValues (Int32 hConnection, byte bytStartChannel, byte bytCount, UInt32[] dwValue);</pre>
VB.NET	<pre>E1K_Pulse_GetPowerOnValues(ByVal hConnection As Integer, ByVal bytStartChannel As Byte, ByVal bytCount As Byte, ByRef nValue As UInt32) As Integer</pre>
Arguments	<p>hConnection: The handle for an I/O device connection.</p> <p>bytStartChannel: Specifies the starting channel.</p> <p>bytCount: The number of channels to be read.</p> <p>bytStatus: A pointer that stores the contiguous pulse channel's power on value, each bit holds one channel value. A bit value of 0 represents the power on value of the start channel. A bit value of 1 represents the value of the second pulse channel. The values are:</p> <p>0: stop</p> <p>1: start</p>
Return Value	<p>Succeed MXIO_OK.</p> <p>Fail Refer to Return Codes.</p>

E1K_Pulse_SetPowerOnValues	This function code is used to set the contiguous pulse channel's power on value.
C#	<pre>int E1K_Pulse_SetPowerOnValues (Int32 hConnection, byte bytStartChannel, byte bytCount, UInt32 dwValue);</pre>
VB.NET	<pre>E1K_Pulse_SetPowerOnValues(ByVal hConnection As Integer, ByVal bytStartChannel As Byte, ByVal bytCount As Byte, ByVal nValue As UInt32) As Integer</pre>
Arguments	<p>hConnection: The handle for an I/O device connection.</p> <p>bytStartChannel: Specifies the starting channel.</p> <p>bytCount: The number of channels to be set.</p> <p>dwValue: Stores the contiguous pulse channel's power on value, each bit holds one channel value. A bit value of 0 represents the power on value of the start channel. A bit value of 1 represents the value of the second pulse channel. The values are:</p> <p> 0: stop</p> <p> 1: start</p>
Return Value	<p>Succeed MXIO_OK.</p> <p>Fail Refer to Return Codes.</p>

E1K_Pulse_GetSafeValues	This function code is used to get the contiguous pulse channel's safe value.
C#	<pre>int E1K_Pulse_GetSafeValues (Int32 hConnection, byte bytStartChannel, byte bytCount, UInt32[] dwValue);</pre>
VB.NET	<pre>E1K_Pulse_GetSafeValues(ByVal hConnection As Integer, ByVal bytStartChannel As Byte, ByVal bytCount As Byte, ByRef nValue As UInt32) As Integer</pre>
Arguments	<p>hConnection: The handle for an I/O device connection.</p> <p>bytStartChannel: Specifies the starting channel.</p> <p>bytCount: The number of channels to be read.</p> <p>dwValue: A pointer that stores the contiguous pulse channel's safe value, each bit holds one channel value. A bit value of 0 represents the safe value of the start channel. A bit value of 1 represents the value of the second pulse channel. The values are:</p> <p>0: stop</p> <p>1: start</p>
Return Value	<p>Succeed MXIO_OK.</p> <p>Fail Refer to Return Codes.</p>

E1K_Pulse_SetSafeValues	This function code is used to set the contiguous pulse channel's safe value.
C#	<pre>int E1K_Pulse_SetSafeValues (Int32 hConnection, byte bytStartChannel, byte bytCount, UInt32 dwValue);</pre>
VB.NET	<pre>E1K_Pulse_SetSafeValues(ByVal hConnection As Integer, ByVal bytStartChannel As Byte, ByVal bytCount As Byte, ByVal nValue As UInt32) As Integer</pre>
Arguments	<p>hConnection: The handle for an I/O device connection.</p> <p>bytStartChannel: Specifies the starting channel.</p> <p>bytCount: The number of channels to be set.</p> <p>dwValue: A pointer that stores the contiguous pulse channel's safe value, each bit holds one channel value. A bit value of 0 represents the safe value of the start channel. A bit value of 1 represents the value of the second pulse channel. The values are:</p> <p style="padding-left: 40px;">0: stop</p> <p style="padding-left: 40px;">1: start</p>
Return Value	<p>Succeed MXIO_OK.</p> <p>Fail Refer to Return Codes.</p>

Analog Input Commands

AI_Reads	This function code is used to read the values of contiguous analog input channels.	
C#	int	AI_Reads(Int32
	byte	hConnection,
	byte	bytSlot,
	byte	bytStartChannel,
	byte	bytCount,
	double[]	dValue);
VB.NET	AI_Reads(ByVal	hConnection As Integer,
	ByVal	bytSlot As Byte,
	ByVal	bytStartChannel As Byte,
	ByVal	bytCount As Byte,
	ByVal	dValue() As Double) As Integer
Arguments	hConnection:	The handle for an I/O device connection.
	bytSlot:	Slot number of the I/O module, from 1 to 32. This parameter is inactive for the ioLogik E2000 and R2000.
	bytStartChannel:	Specifies the starting channel.
	bytCount:	The number of channels to be read.
	dValue:	An array that stores the values of the contiguous A/I channels; dValue[0] represents the value of the starting channel. The unit is Vdc for the voltage module, and mA for the current module.
Return Value	Succeed	MXIO_OK.
	Fail	Refer to Return Codes.

AI_Read	This function code is used to read the value of a specific analog input channel.
C#	int AI_Read(Int32 hConnection, byte bytSlot, byte bytChannel, double[] dValue);
VB.NET	AI_Read(ByVal hConnection As Integer, ByVal bytSlot As Byte, ByVal bytChannel As Byte, ByRef dValue As Double) As Integer
Arguments	<p>hConnection: The handle for an I/O device connection.</p> <p>bytSlot: Slot number of the I/O module, from 1 to 32. This parameter is inactive for the ioLogik E2000 and R2000.</p> <p>bytChannel: The specific channel to be read.</p> <p>dValue: A pointer to the value of the desired analog input channel. The unit is VDC for the voltage module, and mA for the current module.</p>
Return Value	<p>Succeed MXIO_OK.</p> <p>Fail Refer to Return Codes.</p>

AI_ReadRaws	This function code is used to read contiguous channel's analog input raw data.	
C#	int AI_ReadRaws(Int32 byte byte byte UInt16[]	hConnection, bytSlot, bytStartChannel, bytCount, wValue);
VB.NET	AI_ReadRaws(ByVal ByVal ByVal ByVal ByVal	hConnection As Integer, bytSlot As Byte, bytStartChannel As Byte, bytCount As Byte, iValue() As UInt16) As Integer
Arguments	<p>hConnection: The handle for an I/O device connection.</p> <p>bytSlot: Slot number of the I/O module, from 1 to 32. This parameter is inactive for the ioLogik E2000 and R2000.</p> <p>bytStartChannel: Specifies the starting channel.</p> <p>bytCount: The number of channels to be read.</p> <p>wValue: An array that stores the raw data values of the contiguous A/I channels; wValue[0] represents the value of the starting channel.</p>	
Return Value	<p>Succeed MXIO_OK.</p> <p>Fail Refer to Return Codes.</p>	

AI_ReadRaw	This function code is used to read the raw data value of a specific analog input channel.
C#	int AI_ReadRaw(Int32 hConnection, byte bytSlot, byte bytChannel, UInt16[] wValue);
VB.NET	AI_ReadRaw(ByVal hConnection As Integer, ByVal bytSlot As Byte, ByVal bytChannel As Byte, ByRef iValue As UInt16) As Integer
Arguments	<p>hConnection: The handle for an I/O device connection.</p> <p>bytSlot: Slot number of the I/O module, from 1 to 32. This parameter is inactive for the ioLogik E2000 and R2000.</p> <p>bytChannel: The specific channel to be read.</p> <p>wValue: A pointer that stores the specific channel's analog input raw data to be read.</p>
Return Value	<p>Succeed MXIO_OK.</p> <p>Fail Refer to Return Codes.</p>

Analog Input Commands for ioLogik E2000, R2000

AI2K_ReadMins	This function code is used to read the minimize values of contiguous A/I channels.	
C#	int AI2K_ReadMins(Int32	hConnection,
	byte	bytStartChannel,
	byte	bytCount,
	double[]	dValue);
VB.NET	AI2K_ReadMins(ByVal	hConnection As Integer,
	ByVal	bytStartChannel As Byte,
	ByVal	bytCount As Byte,
	ByVal	dValue() As Double) As Integer
Arguments	hConnection:	The handle for an I/O device connection.
	bytStartChannel:	Specifies the starting channel.
	bytCount:	The number of channels to be read.
	dValue:	An array that stores the minimize values of contiguous A/I channels; dValue[0] represents the value of the starting channel. The unit is VDC for the voltage module, and mA for the current module.
Return Value	Succeed	MXIO_OK.
	Fail	Refer to Return Codes.

AI2K_ReadMinRaws	This function code is used to read the minimize raw data values of contiguous A/I channels.	
C#	int AI2K_ReadMinRaws(Int32	hConnection,
	byte	bytStartChannel,
	byte	bytCount,
	UInt16[]	wValue);
VB.NET	AI2K_ReadMinRaws(ByVal	hConnection As Integer,
	ByVal	bytStartChannel As Byte,
	ByVal	bytCount As Byte,
	ByVal	iValue() As UInt16) As Integer
Arguments	hConnection:	The handle for an I/O device connection.
	bytStartChannel:	Specifies the starting channel.
	bytCount:	The number of channels to be read.
	wValue:	An array that stores the minimize raw data values of the contiguous A/I channels; wValue[0] represents the value of the starting channel.
Return Value	Succeed	MXIO_OK.
	Fail	Refer to Return Codes.

AI2K_ResetMins	This function code is used to reset the minimize values of contiguous A/I channels.	
C#	int AI2K_ResetMins(Int32	hConnection,
	byte	bytStartChannel,
	byte	bytCount);
VB.NET	AI2K_ResetMins(ByVal	hConnection As Integer,
	ByVal	bytStartChannel As Byte,
	ByVal	bytCount As Byte) As Integer
Arguments	hConnection:	The handle for an I/O device connection.
	bytStartChannel:	Specifies the starting channel.
	bytCount:	The number of channels to be reset.
Return Value	Succeed	MXIO_OK.
	Fail	Refer to Return Codes.

AI2K_ReadMin	This function code is used to read the minimize value for a specific A/I channel.	
C#	int AI2K_ReadMin(Int32	hConnection,
	byte	bytChannel,
	double[]	dValue);
VB.NET	AI2K_ReadMin(ByVal	hConnection As Integer,
	ByVal	bytChannel As Byte,
	ByRef	dValue As Double) As Integer
Arguments	hConnection:	The handle for an I/O device connection.
	bytChannel:	The specific channel to be read.
	dValue:	A pointer that stores the specific channel's analog input minimize value to be read. The unit is Vdc for the voltage module, and mA for the current module.
Return Value	Succeed	MXIO_OK.
	Fail	Refer to Return Codes.

AI2K_ReadMinRaw	This function code is used to read the minimize raw data value for a specific A/I channel.
C#	int AI2K_ReadMinRaw(Int32 hConnection, byte bytChannel, UInt16[] wValue);
VB.NET	AI2K_ReadMinRaw(ByVal hConnection As Integer, ByVal bytChannel As Byte, ByRef iValue As UInt16) As Integer
Arguments	hConnection: The handle for an I/O device connection. bytChannel: The specific channel to be read. wValue: A pointer that stores the specific A/I channel's minimize raw data.
Return Value	Succeed MXIO_OK. Fail Refer to Return Codes.

AI2K_ResetMin	This function code is used to reset the minimize value for a specific A/I channel.
C#	int AI2K_ResetMin(Int32 hConnection, byte bytChannel);
VB.NET	AI2K_ResetMin(ByVal hConnection As Integer, ByVal bytChannel As Byte) As Integer
Arguments	hConnection: The handle for an I/O device connection. bytChannel: The specific channel to be reset.
Return Value	Succeed MXIO_OK. Fail Refer to Return Codes.

AI2K_ReadMaxs	This function code is used to read the maximize values for contiguous A/I channels.	
C#	int AI2K_ReadMaxs(Int32	hConnection,
	byte	bytStartChannel,
	byte	bytCount,
	double[]	dValue);
VB.NET	AI2K_ReadMaxs(ByVal	hConnection As Integer,
	ByVal	bytStartChannel As Byte,
	ByVal	bytCount As Byte,
	ByRef	dValue As Double) As Integer
Arguments	hConnection:	The handle for an I/O device connection.
	bytStartChannel:	Specifies the starting channel.
	bytCount:	The number of channels to be read.
	dValue:	An array that stores the maximize values for contiguous A/I channels; dValue[0] represents the value of the starting channel. The unit is VDC for the voltage module, and mA for the current module.
Return Value	Succeed	MXIO_OK.
	Fail	Refer to Return Codes.

AI2K_ReadMaxRaws	This function code is used to read the maximize raw data values for contiguous A/I channels.	
C#	int AI2K_ReadMaxRaws(Int32	hConnection,
	byte	bytStartChannel,
	byte	bytCount,
	UInt16[]	wValue);
VB.NET	AI2K_ReadMaxRaws(ByVal	hConnection As Integer,
	ByVal	bytStartChannel As Byte,
	ByVal	bytCount As Byte,
	ByRef	iValue As UInt16) As Integer
Arguments	hConnection:	The handle for an I/O device connection.
	bytStartChannel:	Specifies the starting channel.
	bytCount:	The number of channels to be read.
	wValue:	An array that stores the maximize raw data values for the contiguous A/I channels; wValue[0] represents the value of the starting channel.
Return Value	Succeed	MXIO_OK.
	Fail	Refer to Return Codes.

AI2K_ResetMaxs	This function code is used to reset the maximize values of contiguous A/I channels.
C#	int AI2K_ResetMaxs(Int32 hConnection, byte bytStartChannel, byte bytCount);
VB.NET	AI2K_ResetMaxs(ByVal hConnection As Integer, ByVal bytStartChannel As Byte, ByVal bytCount As Byte) As Integer
Arguments	hConnection: The handle for an I/O device connection. bytStartChannel: Specifies the starting channel. bytCount: The number of channels to be reset.
Return Value	Succeed MXIO_OK. Fail Refer to Return Codes.

AI2K_ReadMax	This function code is used to read the maximize value for a specific A/I channel.
C#	int AI2K_ReadMax(Int32 hConnection, byte bytChannel, double[] dValue);
VB.NET	AI2K_ReadMax(ByVal hConnection As Integer, ByVal bytChannel As Byte, ByRef dValue As Double) As Integer
Arguments	hConnection: The handle for an I/O device connection. bytChannel: The specific channels to be read. dValue: A pointer to the maximize value of the desired A/I channel. The unit is VDC for the voltage module, and mA for the current module.
Return Value	Succeed MXIO_OK. Fail Refer to Return Codes.

AI2K_ReadMaxRaw	This function code is used to read the maximize raw data value for a specific A/I channel.
C#	int AI2K_ReadMaxRaw(Int32 hConnection, byte bytChannel, UInt16[] wValue);
VB.NET	AI2K_ReadMaxRaw(ByVal hConnection As Integer, ByVal bytChannel As Byte, ByRef iValue As UInt16) As Integer
Arguments	hConnection: The handle for an I/O device connection. bytChannel: The specific channel to be read. wValue: A pointer that stores the specific A/I channel's maximize raw data.
Return Value	Succeed MXIO_OK. Fail Refer to Return Codes.

AI2K_ResetMax	This function code is used to reset the maximize value for a specific A/I channel.
C#	int AI2K_ResetMax(Int32 hConnection, byte bytChannel);
VB.NET	AI2K_ResetMax(ByVal hConnection As Integer, ByVal bytChannel As Byte) As Integer
Arguments	hConnection: The handle for an I/O device connection. bytChannel: The specific channel to be reset.
Return Value	Succeed MXIO_OK. Fail Refer to Return Codes.

AI2K_GetRanges	This function code is used to get the ranges of contiguous A/I channels.
C#	<pre>int AI2K_GetRanges(Int32 hConnection, byte bytStartChannel, byte bytCount, UInt16[] wRange);</pre>
VB.NET	<pre>AI2K_GetRanges(ByVal hConnection As Integer, ByVal bytStartChannel As Byte, ByVal bytCount As Byte, ByRef iRange As UInt16) As Integer</pre>
Arguments	<p>hConnection: The handle for an I/O device connection.</p> <p>bytStartChannel: Specifies the starting channel.</p> <p>bytCount: The number of channels to be read.</p> <p>wRange: An array that stores the ranges of the contiguous A/I channels; wRange[0] represents the value of the starting channel. The values are: 00: ±150mV 01: ±500mV 02: ±5V 03: ±10V 04: 0-20mA 05: 4-20mA Others: return Illegal Data Value</p>
Return Value	<p>Succeed MXIO_OK.</p> <p>Fail Refer to Return Codes.</p>

AI2K_SetRanges	This function code is used to set the ranges of contiguous A/I channels.
C#	<pre>int AI2K_SetRanges(Int32 hConnection, byte bytStartChannel, byte bytCount, UInt16[] wRange);</pre>
VB.NET	<pre>AI2K_SetRanges(ByVal hConnection As Integer, ByVal bytStartChannel As Byte, ByVal bytCount As Byte, ByRef iRange As UInt16) As Integer</pre>
Arguments	<p>hConnection: The handle for an I/O device connection.</p> <p>bytStartChannel: Specifies the starting channel.</p> <p>bytCount: The number of channels to be set.</p> <p>wRange: An array that stores the ranges of the contiguous A/I channels; wRange[0] represents the value of the starting channel. The values are: 00: ±150mV 01: ±500mV 02: ±5V 03: ±10V 04: 0-20mA 05: 4-20mA Others: return Illegal Data Value</p>
Return Value	<p>Succeed MXIO_OK.</p> <p>Fail Refer to Return Codes.</p>

AI2K_GetRange	This function code is used to get the range for a specific A/I channel.
C#	int AI2K_GetRange(Int32 hConnection, byte bytChannel, UInt16[] wRange);
VB.NET	AI2K_GetRange(ByVal hConnection As Integer, ByVal bytChannel As Byte, ByRef iRange As UInt16) As Integer
Arguments	<p>hConnection: The handle for an I/O device connection.</p> <p>bytChannel: The specific channel to be get.</p> <p>wRange: An array that stores the contiguous A/I channel's range, wRange[0] represents the value of the starting channel. The values are: 00: ±150mV 01: ±500mV 02: ±5V 03: ±10V 04: 0-20mA 05: 4-20mA Others: return Illegal Data Value</p>
Return Value	<p>Succeed MXIO_OK.</p> <p>Fail Refer to Return Codes.</p>

AI2K_SetRange	This function code is used to set the range for a specific A/I channel.	
C#	int AI2K_SetRange(Int32 byte UInt16	hConnection, bytChannel, wRange);
VB.NET	AI2K_SetRange(ByVal ByVal ByVal	hConnection As Integer, bytChannel As Byte, iRange As UInt16) As Integer
Arguments	<p>hConnection: The handle for an I/O device connection.</p> <p>bytChannel: The specific channel to be set.</p> <p>wRange: An array that stores the contiguous A/I channel's range, wRange[0] represents the value of the starting channel. The values are:</p> <p>00: ±150mV 01: ±500mV 02: ±5V 03: ±10V 04: 0-20mA 05: 4-20mA Others: return Illegal Data Value</p>	
Return Value	<p>Succeed MXIO_OK.</p> <p>Fail Refer to Return Codes.</p>	

AI2K_GetChannelStatus	This function code is used to get the A/I channel status for the ioLogik 2000 module.
C#	int AI2K_GetChannelStatus(Int32 hConnection, byte bytChannel, UInt16[] wValue);
VB.NET	AI2K_GetChannelStatus(ByVal hConnection As Integer, ByVal bytChannel As Byte, ByRef iValue As UInt16) As Integer
Arguments	hConnection: The handle for an I/O device connection. bytChannel: The specific channel to be get. wValue: Represents the value of the starting channel. 0: disabled, 1: enabled
Return Value	Succeed MXIO_OK. Fail Refer to Return Codes.

AI2K_SetChannelStatus	This function code is used to set the A/I channel status for ioLogik 2000 module.
C#	int AI2K_SetChannelStatus(Int32 hConnection, byte bytChannel, UInt16 wValue);
VB.NET	AI2K_SetChannelStatus(ByVal hConnection As Integer, ByVal bytChannel As Byte, ByVal iValue As UInt16) As Integer
Arguments	hConnection: The handle for an I/O device connection. bytChannel: The specific channel to be set. wValue: Represents the value of the starting channel. 0: disabled, 1: enabled
Return Value	Succeed MXIO_OK. Fail Refer to Return Codes.

AI2K_GetChannelStatuses	This function code is used to get the A/I channel status for the ioLogik 2000 module.
C#	int AI2K_GetChannelStatuses(Int32 hConnection, byte bytStartChannel, byte bytCount, UInt16[] wValue);
VB.NET	AI2K_GetChannelStatuses(ByVal hConnection As Integer, ByVal bytStartChannel As Byte, ByVal bytCount As Byte, ByRef iValue As UInt16) As Integer
Arguments	<p>hConnection: The handle for an I/O device connection.</p> <p>bytStartChannel: Specifies the starting channel.</p> <p>bytCount: The number of channels to be read.</p> <p>wValue: Represents the value of the starting channel. 0: disabled, 1: enabled</p>
Return Value	<p>Succeed MXIO_OK.</p> <p>Fail Refer to Return Codes.</p>

AI2K_SetChannelStatuses	This function code is used to set the A/I channel status for the ioLogik 2000 module.
C#	int AI2K_SetChannelStatuses(Int32 hConnection, byte bytStartChannel, byte bytCount, UInt16[] wValue);
VB.NET	AI2K_SetChannelStatuses(ByVal hConnection As Integer, ByVal bytStartChannel As Byte, ByVal bytCount As Byte, ByRef iValue As UInt16) As Integer
Arguments	<p>hConnection: The handle for an I/O device connection.</p> <p>bytStartChannel: Specifies the starting channel.</p> <p>bytCount: The number of channels to be set.</p> <p>wValue: Represents the value of the starting channel. 0: disabled, 1: enabled</p>
Return Value	<p>Succeed MXIO_OK.</p> <p>Fail Refer to Return Codes.</p>

Analog Input Commands for E4200

E42_AI_Reads	This function code is used to read contiguous channel's analog input value. (Design for ioLogik E4200)
C#	<pre>int E42_AI_Reads(Int32 hConnection, byte bytSlot, byte bytStartChannel, byte bytCount, double[] dValue);</pre>
VB.NET	<pre>E42_AI_Reads(ByVal hConnection As Integer, ByVal bytSlot As Byte, ByVal bytStartChannel As Byte, ByVal bytCount As Byte, ByVal dValue() As Double) As Integer</pre>
Arguments	<p>hConnection: The handle for an I/O device connection.</p> <p>bytSlot: Slot number of the I/O module. The Slot number ranges from 1 to 16. But this parameter is inactive on the ioLogik 2000.</p> <p>bytStartChannel: Specifies the starting channel.</p> <p>bytCount: The number of channels to be read.</p> <p>dValue: An array that stores the contiguous A/I channel's value, dValue[0] represents the value of the starting channel. The unit is Vdc for the voltage module, and mA for the current module.</p>
Return Value	<p>Succeed MXIO_OK.</p> <p>Fail Refer to Return Codes.</p>

E42_AI_ReadRaws	This function code is used to read contiguous channel's analog input raw data. (Design for ioLogik E4200)
C#	<pre>int E42_AI_ReadRaws(Int32 hConnection, byte bytSlot, byte bytStartChannel, byte bytCount, UInt16[] wValue);</pre>
VB.NET	<pre>Declare Function E42_AI_ReadRaws Lib "MXIO.dll" (ByVal hConnection As Long, ByVal bytSlot As Byte, ByVal bytStartChannel As Byte, ByVal bytCount As Byte, iValue As UInt32) As Long</pre>
Arguments	<p>hConnection: The handle for an I/O device connection.</p> <p>bytSlot: Slot number of the I/O module. The Slot number ranges from 1 to 16. But this parameter is inactive on the ioLogik 2000.</p> <p>bytStartChannel: Specifies the starting channel.</p> <p>bytCount: The number of channels to be read.</p> <p>wValue: An array that stores the contiguous A/I channel's raw data , wValue[0] represents the value of the starting channel.</p>
Return Value	<p>Succeed MXIO_OK.</p> <p>Fail Refer to Return Codes.</p>

Analog Input Commands for ioLogik W5000

W5K_AI_Reads	This function code is used to read contiguous channel's analog input value.
C#	<pre>int W5K_AI_Reads(Int32 hConnection, byte bytStartChannel, byte bytCount, double[] dValue);</pre>
VB.NET	<pre>W5K_AI_Reads(ByVal hConnection As Integer, ByVal bytStartChannel As Byte, ByVal bytCount As Byte, ByVal dValue() As Double) As Integer</pre>
Arguments	<p>hConnection: The handle for an I/O device connection.</p> <p>bytStartChannel: Specifies the starting channel.</p> <p>bytCount: The number of channels to be read.</p> <p>dValue: An array that stores the contiguous A/I channel's value, dValue[0] represents the value of the starting channel. The unit is Vdc for the voltage module, and mA for the current module.</p>
Return Value	<p>Succeed MXIO_OK.</p> <p>Fail Refer to Return Codes.</p>

W5K_AI_ReadRaws	This function code is used to read contiguous channel's analog input raw data.
C#	<pre> int W5K_AI_ReadRaws (Int32 hConnection, byte bytStartChannel, byte bytCount, UInt16[] wValue); </pre>
VB.NET	<pre> W5K_AI_ReadRaws (ByVal hConnection As Integer, ByVal bytStartChannel As Byte, ByVal bytCount As Byte, ByVal iValue() As UInt16) As Integer</pre>
Arguments	<p>hConnection: The handle for an I/O device connection.</p> <p>bytStartChannel: Specifies the starting channel.</p> <p>bytCount: The number of channels to be read.</p> <p>wValue: An array that stores the contiguous A/I channel's raw data , wValue[0] represents the value of the starting channel.</p>
Return Value	<p>Succeed MXIO_OK.</p> <p>Fail Refer to Return Codes.</p>

W5K_AI_ReadMins	This function code is used to read contiguous A/I channel's minimize value.
C#	<pre>int W5K_AI_ReadMins (Int32 hConnection, byte bytStartChannel, byte bytCount, double[] dValue);</pre>
VB.NET	<pre>W5K_AI_ReadMins (ByVal hConnection As Integer, ByVal bytStartChannel As Byte, ByVal bytCount As Byte, ByVal dValue() As Double) As Integer</pre>
Arguments	<p>hConnection: The handle for an I/O device connection.</p> <p>bytStartChannel: Specifies the starting channel.</p> <p>bytCount: The number of channels to be read.</p> <p>dValue: An array that stores the contiguous A/I channel's value, dValue[0] represents the value of the starting channel. The unit is Vdc for the voltage module, and mA for the current module.</p>
Return Value	<p>Succeed MXIO_OK.</p> <p>Fail Refer to Return Codes.</p>

W5K_AI_ReadMinRaws	This function code is used to read contiguous A/I channel's minimize raw data.
C#	<pre>int W5K_AI_ReadMinRaws(Int32 hConnection, byte bytStartChannel, byte bytCount, UInt16[] wValue);</pre>
VB.NET	<pre>W5K_AI_ReadMinRaws (ByVal hConnection As Integer, ByVal bytStartChannel As Byte, ByVal bytCount As Byte, ByVal iValue() As UInt16) As Integer</pre>
Arguments	<p>hConnection: The handle for an I/O device connection.</p> <p>bytStartChannel: Specifies the starting channel.</p> <p>bytCount: The number of channels to be read.</p> <p>wValue: An array that stores the contiguous A/I channel's minimize raw data , wValue[0] represents the value of the starting channel.</p>
Return Value	<p>Succeed MXIO_OK.</p> <p>Fail Refer to Return Codes.</p>

W5K_AI_ResetMins	This function code is used to reset contiguous A/I channel's minimize value.
C#	int W5K_AI_ResetMins (Int32 hConnection , byte bytStartChannel , byte bytCount);
VB.NET	W5K_AI_ResetMins(ByVal hConnection As Integer, ByVal bytStartChannel As Byte, ByVal bytCount As Byte) As Integer
Arguments	hConnection: The handle for an I/O device connection. bytStartChannel: Specifies the starting channel. bytCount: The number of channels to be reset.
Return Value	Succeed MXIO_OK. Fail Refer to Return Codes.

W5K_AI_ReadMaxRaws	This function code is used to read contiguous A/I channel's maximize raw data.
C#	<pre> int W5K_AI_ReadMaxRaws (Int32 hConnection, byte bytStartChannel, byte bytCount, UInt16[] wValue); </pre>
VB.NET	<pre> W5K_AI_ReadMaxRaws (ByVal hConnection As Integer, ByVal bytStartChannel As Byte, ByVal bytCount As Byte, ByVal iValue() As UInt16) As Integer</pre>
Arguments	<p>hConnection: The handle for an I/O device connection.</p> <p>bytStartChannel: Specifies the starting channel.</p> <p>bytCount: The number of channels to be read.</p> <p>wValue: An array that stores the contiguous A/I channel's maximize raw data , wValue[0] represents the value of the starting channel.</p>
Return Value	<p>Succeed MXIO_OK.</p> <p>Fail Refer to Return Codes.</p>

W5K_AI_ResetMaxs	This function code is used to reset contiguous A/I channel's maximize value.
C#	int W5K_AI_ResetMaxs(Int32 hConnection, byte bytStartChannel, byte bytCount);
VB.NET	W5K_AI_ResetMaxs (ByVal hConnection As Integer, ByVal bytStartChannel As Byte, ByVal bytCount As Byte) As Integer
Arguments	<p>hConnection: The handle for an I/O device connection.</p> <p>bytStartChannel: Specifies the starting channel.</p> <p>bytCount: The number of channels to be reset.</p>
Return Value	<p>Succeed MXIO_OK.</p> <p>Fail Refer to Return Codes.</p>

W5K_AI_GetRanges	This function code is used to get contiguous A/I channel's range.
C#	<pre>int W5K_AI_GetRanges (Int32 hConnection, byte bytStartChannel, byte bytCount, UInt16[] wRange);</pre>
VB.NET	<pre>W5K_AI_GetRanges (ByVal hConnection As Integer, ByVal bytStartChannel As Byte, ByVal bytCount As Byte, ByVal iRange() As UInt16) As Integer</pre>
Arguments	<p>hConnection: The handle for an I/O device connection.</p> <p>bytStartChannel: Specifies the starting channel.</p> <p>bytCount: The number of channels to be read.</p> <p>wRange: An array that stores the contiguous A/I channel's range, wRange[0] represents the value of the starting channel. The values are:</p> <ul style="list-style-type: none"> 00: +/-150mV 01: +/-500mV 02: +/-5V 03: +/-10V 04: 0-20mA 05: 4-20mA 06: 0-150mV 07: 0-500mV 08: 0-5V 09: 0-10V <p>Others_return Illegal Data Value</p>
Return Value	<p>Succeed MXIO_OK.</p> <p>Fail Refer to Return Codes.</p>

W5K_AI_SetRanges	This function code is used to set contiguous A/I channel's range.
C#	<pre>int W5K_AI_SetRanges (Int32 hConnection, byte bytStartChannel, byte bytCount, UInt16[] wRange);</pre>
VB.NET	<pre>W5K_AI_SetRanges (ByVal hConnection As Integer, ByVal bytStartChannel As Byte, ByVal bytCount As Byte, ByVal iRange() As UInt16) As Integer</pre>
Arguments	<p>hConnection: The handle for an I/O device connection.</p> <p>bytStartChannel: Specifies the starting channel.</p> <p>bytCount: The number of channels to be set.</p> <p>wRange: An array that stores the contiguous A/I channel's range, wRange[0] represents the value of the starting channel. The values are:</p> <p>00: +/-150mV 01: +/-500mV 02: +/-5V 03: +/-10V 04: 0-20mA 05: 4-20mA 06: 0-150mV 07: 0-500mV 08: 0-5V 09: 0-10V Others_return Illegal Data Value</p>
Return Value	<p>Succeed MXIO_OK.</p> <p>Fail Refer to Return Codes.</p>

W5K_AI_GetChannelStatuses	This function code is used to get the AI channel status of ioLogik 5000 Module.
C#	<pre> int W5K_AI_GetChannelStatuses (Int32 hConnection, byte bytStartChannel, byte bytCount, UInt16[] wValue); </pre>
VB.NET	<pre> W5K_AI_GetChannelStatuses (ByVal hConnection As Integer, ByVal bytStartChannel As Byte, ByVal bytCount As Byte, ByVal iValue() As UInt16) As Integer </pre>
Arguments	<p>hConnection: The handle for an I/O device connection.</p> <p>bytStartChannel: Specifies the starting channel.</p> <p>bytCount: The number of channels to be read.</p> <p>wValue: Represents the value of the starting channel. 0: disabled, 1: enabled</p>
Return Value	<p>Succeed MXIO_OK.</p> <p>Fail Refer to Return Codes.</p>

W5K_AI_SetChannelStatuses	This function code is used to set the AI channel status of ioLogik 5000 Module.
C#	<pre>int W5K_AI_SetChannelStatuses (Int32 hConnection, byte bytStartChannel, byte bytCount, UInt16[] wValue);</pre>
VB.NET	<pre>W5K_AI_SetChannelStatuses (ByVal hConnection As Integer, ByVal bytStartChannel As Byte, ByVal bytCount As Byte, ByVal iValue() As UInt16) As Integer</pre>
Arguments	<p>hConnection: The handle for an I/O device connection.</p> <p>bytStartChannel: Specifies the starting channel.</p> <p>bytCount: The number of channels to be set.</p> <p>wValue: Represents the value of the starting channel. 0: disabled, 1: enabled</p>
Return Value	<p>Succeed MXIO_OK.</p> <p>Fail Refer to Return Codes.</p>

Analog Input Commands for ioLogik E1200

E1K_AI_Reads	This function code is used to read contiguous channel's analog input value.
C#	<pre>int E1K_AI_Reads(Int32 hConnection, byte bytStartChannel, byte bytCount, double[] dValue);</pre>
VB.NET	<pre>E1K_AI_Reads(ByVal hConnection As Integer, ByVal bytStartChannel As Byte, ByVal bytCount As Byte, ByVal dValue() As Double) As Integer</pre>
Arguments	<p>hConnection: The handle for an I/O device connection.</p> <p>bytStartChannel: Specifies the starting channel.</p> <p>bytCount: The number of channels to be read.</p> <p>dValue: An array that stores the contiguous A/I channel's value, dValue[0] represents the value of the starting channel. The unit is Vdc for the voltage module, and mA for the current module.</p>
Return Value	<p>Succeed MXIO_OK.</p> <p>Fail Refer to Return Codes.</p>

E1K_AI_ReadRaws	This function code is used to read contiguous channel's analog input raw data.
C#	<pre>int E1K_AI_ReadRaws(Int32 hConnection, byte bytStartChannel, byte bytCount, UInt16[] wValue);</pre>
VB.NET	<pre>E1K_AI_ReadRaws(ByVal hConnection As Integer, ByVal bytStartChannel As Byte, ByVal bytCount As Byte, ByVal iValue() As UInt16) As Integer</pre>
Arguments	<p>hConnection: The handle for an I/O device connection.</p> <p>bytStartChannel: Specifies the starting channel.</p> <p>bytCount: The number of channels to be read.</p> <p>wValue: An array that stores the contiguous A/I channel's raw data , wValue[0] represents the value of the starting channel.</p>
Return Value	<p>Succeed MXIO_OK.</p> <p>Fail Refer to Return Codes.</p>

E1K_AI_ReadMins	This function code is used to read contiguous A/I channel's minimize value.
C#	<pre>int E1K_AI_ReadMins(Int32 hConnection, byte bytStartChannel, byte bytCount, double[] dValue);</pre>
VB.NET	<pre>E1K_AI_ReadMins(ByVal hConnection As Integer, ByVal bytStartChannel As Byte, ByVal bytCount As Byte, ByVal dValue() As Double) As Integer</pre>
Arguments	<p>hConnection: The handle for an I/O device connection.</p> <p>bytStartChannel: Specifies the starting channel.</p> <p>bytCount: The number of channels to be read.</p> <p>dValue: An array that stores the contiguous A/I channel's value, dValue[0] represents the value of the starting channel. The unit is Vdc for the voltage module, and mA for the current module.</p>
Return Value	<p>Succeed MXIO_OK.</p> <p>Fail Refer to Return Codes.</p>

E1K_AI_ReadMinRaws	This function code is used to read contiguous A/I channel's minimize raw data.
C#	<pre>int E1K_AI_ReadMinRaws(Int32 hConnection, byte bytStartChannel, byte bytCount, UInt16[] wValue);</pre>
VB.NET	<pre>E1K_AI_ReadMinRaws(ByVal hConnection As Integer, ByVal bytStartChannel As Byte, ByVal bytCount As Byte, ByVal iValue() As UInt16) As Integer</pre>
Arguments	<p>hConnection: The handle for an I/O device connection.</p> <p>bytStartChannel: Specifies the starting channel.</p> <p>bytCount: The number of channels to be read.</p> <p>wValue: An array that stores the contiguous A/I channel's minimize raw data , wValue[0] represents the value of the starting channel.</p>
Return Value	<p>Succeed MXIO_OK.</p> <p>Fail Refer to Return Codes.</p>

E1K_AI_ResetMins	This function code is used to reset contiguous A/I channel's minimize value.
C#	int E1K_AI_ResetMins(Int32 hConnection, byte bytStartChannel, byte bytCount);
VB.NET	E1K_AI_ResetMins(ByVal hConnection As Integer, ByVal bytStartChannel As Byte, ByVal bytCount As Byte) As Integer
Arguments	hConnection: The handle for an I/O device connection. bytStartChannel: Specifies the starting channel. bytCount: The number of channels to be reset.
Return Value	Succeed MXIO_OK. Fail Refer to Return Codes.

E1K_AI_ReadMaxs	This function code is used to read contiguous A/I channel's maximize value.
C#	<pre>int E1K_AI_ReadMaxs(Int32 hConnection, byte bytStartChannel, byte bytCount, double[] dValue);</pre>
VB.NET	<pre>E1K_AI_ReadMaxs(ByVal hConnection As Integer, ByVal bytStartChannel As Byte, ByVal bytCount As Byte, ByVal dValue() As Double) As Integer</pre>
Arguments	<p>hConnection: The handle for an I/O device connection.</p> <p>bytStartChannel: Specifies the starting channel.</p> <p>bytCount: The number of channels to be read.</p> <p>dValue: An array that stores the contiguous A/I channel's maximize value , dValue[0] represents the value of the starting channel. The unit is Vdc for the voltage module, and mA for the current module.</p>
Return Value	<p>Succeed MXIO_OK.</p> <p>Fail Refer to Return Codes.</p>

E1K_AI_ReadMaxRaws	This function code is used to read contiguous A/I channel's maximize raw data.
C#	<pre>int E1K_AI_ReadMaxRaws (Int32 hConnection, byte bytStartChannel, byte bytCount, UInt16[] wValue);</pre>
VB.NET	<pre>E1K_AI_ReadMaxRaws(ByVal hConnection As Integer, ByVal bytStartChannel As Byte, ByVal bytCount As Byte, ByVal iValue() As UInt16) As Integer</pre>
Arguments	<p>hConnection: The handle for an I/O device connection.</p> <p>bytStartChannel: Specifies the starting channel.</p> <p>bytCount: The number of channels to be read.</p> <p>wValue: An array that stores the contiguous A/I channel's maximize raw data, wValue[0] represents the value of the starting channel.</p>
Return Value	<p>Succeed MXIO_OK.</p> <p>Fail Refer to Return Codes.</p>

E1K_AI_ResetMaxs	This function code is used to reset contiguous A/I channel's maximize value.
C#	int E1K_AI_ResetMaxs(Int32 hConnection, byte bytStartChannel, byte bytCount);
VB.NET	E1K_AI_ResetMaxs(ByVal hConnection As Integer, ByVal bytStartChannel As Byte, ByVal bytCount As Byte) As Integer
Arguments	hConnection: The handle for an I/O device connection. bytStartChannel: Specifies the starting channel. bytCount: The number of channels to be reset.
Return Value	Succeed MXIO_OK. Fail Refer to Return Codes.

E1K_AI_GetRanges	This function code is used to get contiguous A/I channel's range.
C#	<pre>int E1K_AI_GetRanges(Int32 hConnection, byte bytStartChannel, byte bytCount, UInt16[] wRange);</pre>
VB.NET	<pre>E1K_AI_GetRanges(ByVal hConnection As Integer, ByVal bytStartChannel As Byte, ByVal bytCount As Byte, ByVal iRange() As UInt16) As Integer</pre>
Arguments	<p>hConnection: The handle for an I/O device connection.</p> <p>bytStartChannel: Specifies the starting channel.</p> <p>bytCount: The number of channels to be read.</p> <p>wRange: An array that stores the contiguous A/I channel's range, wRange[0] represents the value of the starting channel. The values are:</p> <p>0: 0-10V</p> <p>1: 4-20mA</p> <p>Others_return Illegal Data Value</p>
Return Value	<p>Succeed MXIO_OK.</p> <p>Fail Refer to Return Codes.</p>

E1K_AI_GetChannelStatuses	This function code is used to get the AI channel status of ioLogik 1200 Module.
C#	<pre>int E1K_AI_GetChannelStatuses (Int32 hConnection, byte bytStartChannel, byte bytCount, UInt16[] wValue);</pre>
VB.NET	<pre>E1K_AI_GetChannelStatuses(ByVal hConnection As Integer, ByVal bytStartChannel As Byte, ByVal bytCount As Byte, ByVal iValue() As UInt16) As Integer</pre>
Arguments	<p>hConnection: The handle for an I/O device connection.</p> <p>bytStartChannel: Specifies the starting channel.</p> <p>bytCount: The number of channels to be read.</p> <p>wValue: Represents the value of the starting channel. 0: disabled, 1: enabled</p>
Return Value	<p>Succeed MXIO_OK.</p> <p>Fail Refer to Return Codes.</p>

E1K_AI_SetChannelStatuses	This function code is used to set the AI channel status of ioLogik 1200 Module.
C#	<pre>int E1K_AI_SetChannelStatuses (Int32 hConnection, byte bytStartChannel, byte bytCount, UInt16[] wValue);</pre>
VB.NET	<pre>E1K_AI_SetChannelStatuses(ByVal hConnection As Integer, ByVal bytStartChannel As Byte, ByVal bytCount As Byte, ByVal iValue() As UInt16) As Integer</pre>
Arguments	<p>hConnection: The handle for an I/O device connection.</p> <p>bytStartChannel: Specifies the starting channel.</p> <p>bytCount: The number of channels to be set.</p> <p>wValue: Represents the value of the starting channel. 0: disabled, 1: enabled</p>
Return Value	<p>Succeed MXIO_OK.</p> <p>Fail Refer to Return Codes.</p>

Analog Output Commands

AO_Reads	This function code is used to read the values of contiguous analog output channels.
C#	<pre>int AO_Reads(Int32 hConnection, byte bytSlot, byte bytStartChannel, byte bytCount, double[] dValue);</pre>
VB.NET	<pre>AO_Reads(ByVal hConnection As Integer, ByVal bytSlot As Byte, ByVal bytStartChannel As Byte, ByVal bytCount As Byte, ByVal dValue() As Double) As Integer</pre>
Arguments	<p>hConnection: The handle for an I/O device connection.</p> <p>bytSlot: Slot number of the I/O module, from 1 to 32. This parameter is inactive for the ioLogik E2000 and R2000.</p> <p>bytStartChannel: Specifies the starting channel.</p> <p>bytCount: The number of channels to be read.</p> <p>dValue: An array that stores the values of contiguous analog output channels. dValue[0] represents the value of the starting channel. The unit is Vdc for the voltage channel and mA for the current channel.</p>
Return Value	<p>Succeed MXIO_OK.</p> <p>Fail Refer to Return Codes.</p>

AO_Writes	This function code is used to write the values of contiguous analog output channels.
C#	<pre>int AO_Writes(Int32 byte byte byte double[] hConnection, bytSlot, bytStartChannel, bytCount, dValue);</pre>
VB.NET	<pre>AO_Writes(ByVal ByVal ByVal ByVal hConnection As Integer, bytSlot As Byte, bytStartChannel As Byte, bytCount As Byte, dValue() As Double) As Integer</pre>
Arguments	<p>hConnection: The handle for an I/O device connection.</p> <p>bytSlot: Slot number of the I/O module, from 1 to 32. This parameter is inactive for the ioLogik E2000 and R2000.</p> <p>bytStartChannel: Specifies the starting channel.</p> <p>bytCount: The number of channels to write.</p> <p>dValue: An array that stores the values of contiguous channel outputs. dValue [0] represents the value of the starting channel. The unit is VDC for the voltage channel and mA for the current channel.</p>
Return Value	<p>Succeed MXIO_OK.</p> <p>Fail Refer to Return Codes.</p>

AO_Read	This function code is used to read the value for a specific analog output channel.
C#	<pre>int AO_Read(Int32 hConnection, byte bytSlot, byte bytChannel, double[] dValue);</pre>
VB.NET	<pre>AO_Read(ByVal hConnection As Integer, ByVal bytSlot As Byte, ByVal bytChannel As Byte, ByRef dValue As Double) As Integer</pre>
Arguments	<p>hConnection: The handle for an I/O device connection.</p> <p>bytSlot: Slot number of the I/O module, from 1 to 32. This parameter is inactive for the ioLogik E2000 and R2000.</p> <p>bytChannel: The specific channel to be read.</p> <p>dValue: A pointer to the value of the desired analog output channel. The unit is VDC for the voltage channel and mA for the current channel.</p>
Return Value	<p>Succeed MXIO_OK.</p> <p>Fail Refer to Return Codes.</p>

AO_Write	This function code is used to write the status for a specific analog output channel.
C#	<pre>int AO_Write(Int32 hConnection, byte bytSlot, byte bytChannel, double dValue);</pre>
VB.NET	<pre>AO_Write(ByVal hConnection As Integer, ByVal bytSlot As Byte, ByVal bytChannel As Byte, ByVal dValue As Double) As Integer</pre>
Arguments	<p>hConnection: The handle for an I/O device connection.</p> <p>bytSlot: Slot number of the I/O module, from 1 to 32. This parameter is inactive for the ioLogik E2000 and R2000.</p> <p>bytChannel: The specific channel to be written.</p> <p>dValue: Stores the specific channel output value that is to be written. The unit is Vdc for the voltage channel and mA for the current channel.</p>
Return Value	<p>Succeed MXIO_OK.</p> <p>Fail Refer to Return Codes.</p>

AO_ReadRaws	This function code is used to read the raw data values of contiguous analog output channels.	
C#	int	AO_ReadRaws(Int32 hConnection, byte bytSlot, byte bytStartChannel, byte bytCount, UInt16[] wValue);
VB.NET	AO_ReadRaws(ByVal hConnection As Integer, ByVal bytSlot As Byte, ByVal bytStartChannel As Byte, ByVal bytCount As Byte, ByVal iValue() As UInt16) As Integer	
Arguments	<p>hConnection: The handle for an I/O device connection.</p> <p>bytSlot: Slot number of the I/O module, from 1 to 32. This parameter is inactive for the ioLogik E2000 and R2000.</p> <p>bytStartChannel: Specifies the starting channel.</p> <p>bytCount: The number of channels to be read.</p> <p>wValue: An array that stores the raw data values for the contiguous analog output channels. wValue [0] represents the value of the starting channel.</p>	
Return Value	<p>Succeed MXIO_OK.</p> <p>Fail Refer to Return Codes.</p>	

AO_WriteRaws	This function code is used to write the raw data values for contiguous analog output channels.
C#	int AO_WriteRaws(Int32 hConnection, byte bytSlot, byte bytStartChannel, byte bytCount, UInt16[] wValue);
VB.NET	AO_WriteRaws(ByVal hConnection As Integer, ByVal bytSlot As Byte, ByVal bytStartChannel As Byte, ByVal bytCount As Byte, ByVal iValue() As UInt16) As Integer
Arguments	<p>hConnection: The handle for an I/O device connection.</p> <p>bytSlot: Slot number of the I/O module, from 1 to 32. This parameter is inactive for the ioLogik E2000 and R2000.</p> <p>bytStartChannel: Specifies the starting channel.</p> <p>bytCount: The number of channels to write.</p> <p>wValue: An array that stores raw data values for the contiguous analog output channels. wValue[0] represents the value of the starting analog output channel.</p>
Return Value	<p>Succeed MXIO_OK.</p> <p>Fail Refer to Return Codes.</p>

AO_ReadRaw	This function code is used to read the raw data value of a specific analog output channel.
C#	int AO_ReadRaw(Int32 hConnection, byte bytSlot, byte bytChannel, UInt16[] wValue);
VB.NET	AO_ReadRaw(ByVal hConnection As Integer, ByVal bytSlot As Byte, ByVal bytChannel As Byte, ByVal iValue As UInt16) As Integer
Arguments	<p>hConnection: The handle for an I/O device connection.</p> <p>bytSlot: Slot number of the I/O module, from 1 to 32. This parameter is inactive for the ioLogik E2000 and R2000.</p> <p>bytChannel: The specific channel to be read.</p> <p>wValue: A pointer that stores the specific channel output raw data to be read.</p>
Return Value	<p>Succeed MXIO_OK.</p> <p>Fail Refer to Return Codes.</p>

AO_WriteRaw	This function code is used to write the raw data value of a specific analog output channel.	
C#	int AO_WriteRaw(Int32	hConnection,
	byte	bytSlot,
	byte	bytChannel,
	UInt16	wValue);
VB.NET	AO_WriteRaw(ByVal	hConnection As Integer,
	ByVal	bytSlot As Byte,
	ByVal	bytChannel As Byte,
	ByVal	iValue As UInt16) As Integer
Arguments	hConnection:	The handle for an I/O device connection.
	bytSlot:	Slot number of the I/O module, from 1 to 32. This parameter is inactive for the ioLogik E2000 and R2000.
	bytChannel:	The specific channel to be written.
	wValue:	Stores the specific channel output raw data that is to be written.
Return Value	Succeed	MXIO_OK.
	Fail	Refer to Return Codes.

AO_GetSafeValues	This function code is used to get the safe values of contiguous analog output channels.
C#	int AO_GetSafeValues(Int32 hConnection, byte bytSlot, byte bytStartChannel, byte bytCount, double[] dValue);
VB.NET	AO_GetSafeValues(ByVal hConnection As Integer, ByVal bytSlot As Byte, ByVal bytStartChannel As Byte, ByVal bytCount As Byte, ByVal dValue() As Double) As Integer
Arguments	<p>hConnection: The handle for an I/O device connection.</p> <p>bytSlot: Slot number of the I/O module, from 1 to 32. This parameter is inactive for the ioLogik E2000 and R2000.</p> <p>bytStartChannel: Specifies the starting channel.</p> <p>bytCount: The number of channels to be read.</p> <p>dValue: An array that stores the safe values for the contiguous A/O channels. dValue[0] represents the value of the starting channel. The unit is Vdc for the voltage channel and mA for the current channel.</p>
Return Value	<p>Succeed MXIO_OK.</p> <p>Fail Refer to Return Codes.</p>

AO_SetSafeValues	This function code is used to set the safe values for contiguous A/O channels.	
C#	int AO_SetSafeValues(Int32 byte byte byte double[]	hConnection, bytSlot, bytStartChannel, bytCount, dValue);
VB.NET	AO_SetSafeValues(ByVal ByVal ByVal ByVal ByVal	hConnection As Integer, bytSlot As Byte, bytStartChannel As Byte, bytCount As Byte, dValue() As Double) As Integer
Arguments	<p>hConnection: The handle for an I/O device connection.</p> <p>bytSlot: Slot number of the I/O module, from 1 to 32. This parameter is inactive for the ioLogik E2000 and R2000.</p> <p>bytStartChannel: Specifies the starting channel.</p> <p>bytCount: The number of channels to be set.</p> <p>dValue: An array that stores the safe values for the contiguous A/O channels. dValue[0] represents the value of the starting analog output channel. The unit is VDC for the voltage channel and mA for the current channel.</p>	
Return Value	<p>Succeed MXIO_OK.</p> <p>Fail Refer to Return Codes.</p>	

AO_GetSafeValue	This function code is used to get the safe value for a specific A/O channel.
C#	<pre>int AO_GetSafeValue(Int32 hConnection, byte bytSlot, byte bytChannel, double[] dValue);</pre>
VB.NET	<pre>AO_GetSafeValue(ByVal hConnection As Integer, ByVal bytSlot As Byte, ByVal bytChannel As Byte, ByRef dValue As Double) As Integer</pre>
Arguments	<p>hConnection: The handle for an I/O device connection.</p> <p>bytSlot: Slot number of the I/O module, from 1 to 32. This parameter is inactive for the ioLogik E2000 and R2000.</p> <p>bytChannel: The specific channel to be read.</p> <p>dValue: A pointer to the safe value of the desired A/O channel. The unit is VDC for the voltage channel and mA for the current channel.</p>
Return Value	<p>Succeed MXIO_OK.</p> <p>Fail Refer to Return Codes.</p>

AO_SetSafeValue	This function code is used to set the safe value for a specific A/O channel.
C#	<pre>int AO_SetSafeValue(Int32 byte byte double hConnection, bytSlot, bytChannel, dValue);</pre>
VB.NET	<pre>AO_SetSafeValue(ByVal ByVal ByVal ByVal hConnection As Integer, bytSlot As Byte, bytChannel As Byte, dValue As Double) As Integer</pre>
Arguments	<p>hConnection: The handle for an I/O device connection.</p> <p>bytSlot: Slot number of the I/O module, from 1 to 32. This parameter is inactive for the ioLogik E2000 and R2000.</p> <p>bytChannel: The specific channel to be set.</p> <p>dValue: Stores the safe value of the desired A/O channel. The unit is Vdc for the voltage channel and mA for the current channel.</p>
Return Value	<p>Succeed MXIO_OK.</p> <p>Fail Refer to Return Codes.</p>

AO_GetSafeRaws	This function code is used to get the raw safe values of contiguous analog output channels.	
C#	int AO_GetSafeRaws(Int32	hConnection,
	byte	bytSlot,
	byte	bytStartChannel,
	byte	bytCount,
	UInt16[]	wValue);
VB.NET	AO_GetSafeRaws(ByVal	hConnection As Integer,
	ByVal	bytSlot As Byte,
	ByVal	bytStartChannel As Byte,
	ByVal	bytCount As Byte,
	ByVal	iValue() As UInt16) As Integer
Arguments	hConnection:	The handle for an I/O device connection.
	bytSlot:	Slot number of the I/O module, from 1 to 32. This parameter is inactive for the ioLogik E2000 and R2000.
	bytStartChannel:	Specifies the starting channel.
	bytCount:	The number of channels to be read.
	wValue:	An array that stores the raw safe values of the contiguous A/O channels. wValue[0] represents the value of the starting channel.
Return Value	Succeed	MXIO_OK.
	Fail	Refer to Return Codes.

AO_SetSafeRaws	This function code is used to set safe values for contiguous A/O Channel's in raw data format.
C#	<pre>int AO_SetSafeRaws(Int32 hConnection, byte bytSlot, byte bytStartChannel, byte bytCount, UInt16[] wValue);</pre>
VB.NET	<pre>AO_SetSafeRaws(ByVal hConnection As Integer, ByVal bytSlot As Byte, ByVal bytStartChannel As Byte, ByVal bytCount As Byte, ByVal iValue() As UInt16) As Integer</pre>
Arguments	<p>hConnection: The handle for an I/O device connection.</p> <p>bytSlot: Slot number of the I/O module, from 1 to 32. This parameter is inactive for the ioLogik E2000 and R2000.</p> <p>bytStartChannel: Specifies the starting channel.</p> <p>bytCount: The number of channels to write.</p> <p>wValue: An array that stores safe values in raw data format for the contiguous A/O channels. wValue[0] represents the value of the starting analog output channel.</p>
Return Value	<p>Succeed MXIO_OK.</p> <p>Fail Refer to Return Codes.</p>

AO_GetSafeRaw	This function code is used to get the safe value for a specific A/O channel in raw data format.
C#	<pre>int AO_SetSafeRaws(Int32 hConnection, byte bytSlot, byte bytStartChannel, byte bytCount, UInt16[] wValue);</pre>
VB.NET	<pre>AO_SetSafeRaws(ByVal hConnection As Integer, ByVal bytSlot As Byte, ByVal bytStartChannel As Byte, ByVal bytCount As Byte, ByVal iValue() As UInt16) As Integer</pre>
Arguments	<p>hConnection: The handle for an I/O device connection.</p> <p>bytSlot: Slot number of the I/O module, from 1 to 32. This parameter is inactive for the ioLogik E2000 and R2000.</p> <p>bytCount: The number of channels to be get.</p> <p>bytStartChannel: The first channel number will be collected.</p> <p>wValue: An array that stores the contiguous channel safe raw data to set. The wValue[0] represents the value of the starting Analog output channel.</p>
Return Value	<p>Succeed MXIO_OK.</p> <p>Fail Refer to Return Codes.</p>

AO_SetSafeRaw	This function code is used to set the safe value for a specific A/O channel in raw data format.	
C#	int AO_SetSafeRaw(Int32	hConnection,
	byte	bytSlot,
	byte	bytChannel,
	UInt16	wValue);
VB.NET	AO_SetSafeRaw(ByVal	hConnection As Integer,
	ByVal	bytSlot As Byte,
	ByVal	bytChannel As Byte,
	ByVal	iValue As UInt16) As Integer
Arguments	hConnection:	The handle for an I/O device connection.
	bytSlot:	Slot number of the I/O module, from 1 to 32. This parameter is inactive for the ioLogik E2000 and R2000.
	bytChannel:	The specific channel to be set.
	wValue:	Stores the safe value for the desired channel in raw data format.
Return Value	Succeed	MXIO_OK.
	Fail	Refer to Return Codes.

Analog Output Commands for ioLogik E2000, R2000

AO2K_GetRanges	This function code is used to get the ranges of contiguous A/O channels.
C#	<pre>int AO2K_GetRanges(Int32 hConnection, byte bytStartChannel, byte bytCount, UInt16[] wRange);</pre>
VB.NET	<pre>AO2K_GetRanges(ByVal hConnection As Integer, ByVal bytStartChannel As Byte, ByVal bytCount As Byte, ByVal iRange() As UInt16) As Integer</pre>
Arguments	<p>hConnection: The handle for an I/O device connection.</p> <p>bytStartChannel: Specifies the starting channel.</p> <p>bytCount: The number of channels to be read.</p> <p>wRange: An array that stores the ranges of the contiguous A/O channels. wRange[0] represents the value of the starting channel. The values are: 0: 0-10 VDC 1: 4-20 mA 0xff: disable Others : return Illegal Data Value</p>
Return Value	<p>Succeed MXIO_OK.</p> <p>Fail Refer to Return Codes.</p>

AO2K_SetRanges	This function code is used to set the ranges of contiguous A/O channels.
C#	int AO2K_SetRanges(Int32 hConnection, byte bytStartChannel, byte bytCount, UInt16[] wRange);
VB.NET	AO2K_SetRanges(ByVal hConnection As Integer, ByVal bytStartChannel As Byte, ByVal bytCount As Byte, ByVal iRange() As UInt16) As Integer
Arguments	<p>hConnection: The handle for an I/O device connection.</p> <p>bytStartChannel: Specifies the starting channel.</p> <p>bytCount: The number of channels to set.</p> <p>wRange: An array that stores the ranges of the contiguous A/O channels. wRange[0] represents the value of the starting channel. The values are: 0: 0-10 VDC 1: 4-20 mA Others : return Illegal Data Value</p>
Return Value	<p>Succeed MXIO_OK.</p> <p>Fail Refer to Return Codes.</p>

AO2K_GetRange	This function code is used to get the range of a specific A/O channel.
C#	int AO2K_GetRange(Int32 hConnection, byte bytChannel, UInt16[] wRange);
VB.NET	AO2K_GetRange(ByVal hConnection As Integer, ByVal bytChannel As Byte, ByRef iRange As UInt16) As Integer
Arguments	<p>hConnection: The handle for an I/O device connection.</p> <p>bytChannel: The specific channel to be get.</p> <p>wRange: A pointer to the range of the desired A/O channel. The values are: 0: 0-10 VDC 1: 4-20 mA 0xff: disable Others : return Illegal Data Value</p>
Return Value	<p>Succeed MXIO_OK.</p> <p>Fail Refer to Return Codes.</p>

AO2K_SetRange	This function code is used to set the range for a specific A/O channel.
C#	int AO2K_SetRange(Int32 hConnection, byte bytChannel, UInt16 wRange);
VB.NET	AO2K_SetRange(ByVal hConnection As Integer, ByVal bytChannel As Byte, ByVal iRange As UInt16) As Integer
Arguments	<p>hConnection: The handle for an I/O device connection.</p> <p>bytChannel: The specific channel to be set.</p> <p>wRange: Stores the specific A/O channel's range. The values are: 0: 0-10 VDC 1: 4-20 mA Others: return Illegal Data Value</p>
Return Value	<p>Succeed MXIO_OK.</p> <p>Fail Refer to Return Codes.</p>

AO2K_GetPowerOnValues	This function code is used to get the power on values of contiguous A/O channels.
C#	int AO2K_GetPowerOnValues(Int32 hConnection, byte bytStartChannel, byte bytCount, double[] dValue);
VB.NET	AO2K_GetPowerOnValues (ByVal hConnection As Integer, ByVal bytStartChannel As Byte, ByVal bytCount As Byte, ByVal dValue() As Double) As Integer
Arguments	<p>hConnection: The handle for an I/O device connection.</p> <p>bytStartChannel: Specifies the starting channel.</p> <p>bytCount: The number of channels to be get.</p> <p>dValue: An array that stores the power on values for the contiguous A/O channels. dValue[0] represents the value of the starting channel. The unit is Vdc for the voltage channel and mA for the current channel.</p>
Return Value	<p>Succeed MXIO_OK.</p> <p>Fail Refer to Return Codes.</p>

AO2K_SetPowerOnValues	This function code is used to set the power on values of contiguous A/O channels.
C#	int AO2K_SetPowerOnValues(Int32 hConnection, byte bytStartChannel, byte bytCount, double[] dValue);
VB.NET	AO2K_SetPowerOnValues (ByVal hConnection As Integer, ByVal bytStartChannel As Byte, ByVal bytCount As Byte, ByVal dValue() As Double) As Integer
Arguments	<p>hConnection: The handle for an I/O device connection.</p> <p>bytStartChannel: Specifies the starting channel.</p> <p>bytCount: The number of channels to set.</p> <p>dValue: An array that stores the power on values for the contiguous A/O channels. dValue[0] represents the value of the starting channel. The unit is Vdc for the voltage channel and mA for the current channel.</p>
Return Value	<p>Succeed MXIO_OK.</p> <p>Fail Refer to Return Codes.</p>

AO2K_GetPowerOnValue	This function code is used to get the power on value for a specific channel.
C#	int AO2K_GetPowerOnValue(Int32 hConnection, byte bytChannel, double[] dValue);
VB.NET	AO2K_GetPowerOnValue (ByVal hConnection As Integer, ByVal bytChannel As Byte, ByRef dValue As Double) As Integer
Arguments	<p>hConnection: The handle for an I/O device connection.</p> <p>bytChannel: The specific channel to be get.</p> <p>dValue: A pointer to the power on value for the desired A/O channel. The unit is Vdc for the voltage channel and mA for the current channel.</p>
Return Value	<p>Succeed MXIO_OK.</p> <p>Fail Refer to Return Codes.</p>

AO2K_SetPowerOnValue	This function code is used to set the power on value for a specific channel.
C#	int AO2K_SetPowerOnValue(Int32 hConnection, byte bytChannel, double dValue);
VB.NET	AO2K_SetPowerOnValue(ByVal hConnection As Integer, ByVal bytChannel As Byte, ByVal dValue As Double) As Integer
Arguments	<p>hConnection: The handle for an I/O device connection.</p> <p>bytChannel: The specific channel to be set.</p> <p>dValue: Stores the power on value for the desired A/O channel. The unit is Vdc for the voltage channel and mA for the current channel.</p>
Return Value	<p>Succeed MXIO_OK.</p> <p>Fail Refer to Return Codes.</p>

AO2K_GetPowerOnRaws	This function code is used to get the power on values of contiguous A/O channels in raw data format.
C#	int AO2K_GetPowerOnRaws(Int32 hConnection, byte bytStartChannel, byte bytCount, UInt16[] wValue);
VB.NET	AO2K_GetPowerOnRaws (ByVal hConnection As Integer, ByVal bytStartChannel As Byte, ByVal bytCount As Byte, ByVal iValue() As UInt16) As Integer
Arguments	<p>hConnection: The handle for an I/O device connection.</p> <p>bytStartChannel: Specifies the starting channel.</p> <p>bytCount: The number of channels to be read.</p> <p>wValue: An array that stores the power on values of the contiguous A/O channels in raw data format. wValue[0] represents the value of the starting channel.</p>
Return Value	<p>Succeed MXIO_OK.</p> <p>Fail Refer to Return Codes.</p>

AO2K_SetPowerOnRaws	This function code is used to set the power on values of contiguous A/O channels in raw data format.
C#	int AO2K_SetPowerOnRaws(Int32 hConnection, byte bytStartChannel, byte bytCount, UInt16[] wValue);
VB.NET	AO2K_SetPowerOnRaws (ByVal hConnection As Integer, ByVal bytStartChannel As Byte, ByVal bytCount As Byte, ByVal iValue() As UInt16) As Integer
Arguments	<p>hConnection: The handle for an I/O device connection.</p> <p>bytStartChannel: Specifies the starting channel.</p> <p>bytCount: The number of channels to set.</p> <p>wValue: An array that stores the power on values of contiguous A/O channels in raw data format. wValue [0] represents the value of the starting channel.</p>
Return Value	<p>Succeed MXIO_OK.</p> <p>Fail Refer to Return Codes.</p>

AO2K_GetPowerOnRaw	This function code is used to get the power on value of a specific analog output channel in raw data format.
C#	int AO2K_GetPowerOnRaw(Int32 hConnection, byte bytChannel, UInt16[] wValue);
VB.NET	AO2K_GetPowerOnRaw (ByVal hConnection As Integer, ByVal bytChannel As Byte, ByRef iValue As UInt16) As Integer
Arguments	<p>hConnection: The handle for an I/O device connection.</p> <p>bytChannel: The specific channel to be read.</p> <p>wValue: A pointer to the power on value for the specific channel in raw data format.</p>
Return Value	<p>Succeed MXIO_OK.</p> <p>Fail Refer to Return Codes.</p>

AO2K_SetPowerOnRaw	This function code is used to set the power on value of a specific analog output channel in raw data format.
C#	AO2K_SetPowerOnRaw (ByVal hConnection As Integer, ByVal bytChannel As Byte, ByVal iValue As UInt16) As Integer
VB.NET	int AO2K_SetPowerOnRaw (Int32 hConnection, byte bytChannel, UInt16 wValue);
Arguments	hConnection: The handle for an I/O device connection. bytChannel: The specific channel to be set. wValue: Stores the power on value for the specific channel in raw data format.
Return Value	Succeed MXIO_OK. Fail Refer to Return Codes.

Analog Output Commands for ioLogik 4000

AO4K_GetSafeActions	This function code is used to get the safe actions of contiguous A/O channels.
C#	<pre>int AO4K_GetSafeActions(Int32 hConnection, byte bytSlot, byte bytStartChannel, byte bytCount, UInt16[] wAction);</pre>
VB.NET	<pre>AO4K_GetSafeActions(ByVal hConnection As Integer, ByVal bytSlot As Byte, ByVal bytStartChannel As Byte, ByVal bytCount As Byte, ByVal iAction() As UInt16) As Integer</pre>
Arguments	<p>hConnection: The handle for an I/O device connection.</p> <p>bytSlot: Slot number of the I/O module, from 1 to 32.</p> <p>bytStartChannel: Specifies the starting channel.</p> <p>bytCount: The number of channels to be read.</p> <p>wAction: An array that stores the safe actions of the contiguous A/O channels. wAction[0] represents the value of the starting channel. The values are:</p> <ul style="list-style-type: none"> 0: Safe value 1: Hold last state 2: Low Limit 3: High Limit
Return Value	<p>Succeed MXIO_OK.</p> <p>Fail Refer to Return Codes.</p>

AO4K_SetSafeActions	This function code is used to set the safe actions of contiguous A/O channels.
C#	int AO4K_SetSafeActions(Int32 hConnection, byte bytSlot, byte bytStartChannel, byte bytCount, UInt16[] wAction);
VB.NET	AO4K_SetSafeActions(ByVal hConnection As Integer, ByVal bytSlot As Byte, ByVal bytStartChannel As Byte, ByVal bytCount As Byte, ByVal iAction() As UInt16) As Integer
Arguments	<p>hConnection: The handle for an I/O device connection.</p> <p>bytSlot: Slot number of the I/O module, from 1 to 32.</p> <p>bytStartChannel: Specifies the starting channel.</p> <p>bytCount: The number of channels to be set.</p> <p>wAction: An array that stores the safe actions for the contiguous A/O channels. wAction[0] represents the value of the starting channel. The values are: 0: Safe value 1: Hold last state 2: Low Limit 3: High Limit</p>
Return Value	<p>Succeed MXIO_OK.</p> <p>Fail Refer to Return Codes.</p>

AO4K_GetSafeAction	This function code is used to get the safe action for a specific analog output channel.
C#	int AO4K_GetSafeAction(Int32 hConnection, byte bytSlot, byte bytChannel, UInt16[] wAction);
VB.NET	AO4K_GetSafeAction(ByVal hConnection As Integer, ByVal bytSlot As Byte, ByVal bytChannel As Byte, ByRef iAction As UInt16) As Integer
Arguments	<p>hConnection: The handle for an I/O device connection.</p> <p>bytSlot: Slot number of the I/O module, from 1 to 32.</p> <p>bytChannel: The specific channel to be get.</p> <p>wAction: A pointer to the safe action of the desired A/O channel. The values are: 0: Safe value 1: Hold last state 2: Low Limit 3: High Limit</p>
Return Value	<p>Succeed MXIO_OK.</p> <p>Fail Refer to Return Codes.</p>

AO4K_SetSafeAction	This function code is used to set the safe action for a specific channel.
<p>C#</p> <p>VB.NET</p> <p>Arguments</p> <p>Return Value</p>	<pre> int AO4K_SetSafeAction(Int32 byte byte UInt16 hConnection, bytSlot, bytChannel, wAction); AO4K_SetSafeAction(ByVal ByVal ByVal ByVal hConnection As Integer, bytSlot As Byte, bytChannel As Byte, iAction As UInt16) As Integer </pre> <p>hConnection: The handle for an I/O device connection.</p> <p>bytSlot: Slot number of the I/O module, from 1 to 32.</p> <p>bytChannel: The specific channel to be set.</p> <p>wAction: Stores the safe action of the desired A/O channel. The values are: 0: Safe value 1: Hold last state 2: Low Limit 3: High Limit</p> <p>Succeed MXIO_OK.</p> <p>Fail Refer to Return Codes.</p>

Analog Output Commands for ioLogik E4200

E42_AO_GetSafeActions	This function code is used to get the safe action of contiguous A/O channels.	
C#	int	E42_AO_GetSafeActions(Int32 hConnection, byte bytSlot, byte bytStartChannel, byte bytCount, UInt16[] wAction);
VB.NET	E42_AO_GetSafeActions(ByVal hConnection As Integer, ByVal bytSlot As Byte, ByVal bytStartChannel As Byte, ByVal bytCount As Byte, ByVal iAction() As UInt16) As Integer	
Arguments	hConnection: The handle for an I/O device connection. bytSlot: Slot number of the I/O module. The Slot number ranges from 1 to 16. bytStartChannel: Specifies the starting channel. bytCount: The number of channels to be read. wAction: An array that stores the contiguous A/O channel's safe action to be get. The wAction[0] represents the value of the starting channel. The values are: 0: Safe value 1: Hold last state 2: Low Limit 3: High Limit	
Return Value	Succeed MXIO_OK. Fail Refer to Return Codes.	

E42_AO_SetSafeActions	This function code is used to set the safe action of contiguous A/O channels.
C#	<pre>int E42_AO_SetSafeActions(Int32 hConnection, byte bytSlot, byte bytStartChannel, byte bytCount, UInt16[] wAction);</pre>
VB.NET	<pre>E42_AO_SetSafeActions(ByVal hConnection As Integer, ByVal bytSlot As Byte, ByVal bytStartChannel As Byte, ByVal bytCount As Byte, ByVal iAction() As UInt16) As Integer</pre>
Arguments	<p>hConnection: The handle for an I/O device connection.</p> <p>bytSlot: Slot number of the I/O module. The Slot number ranges from 1 to 16.</p> <p>bytStartChannel: Specifies the starting channel.</p> <p>bytCount: The number of channels to be set.</p> <p>wAction: An array that stores the contiguous A/O channel's safe action to be set. The wAction[0] represents the value of the starting channel. The values are: 0: Safe value 1: Hold last state 2: Low limit 3: High limit</p>
Return Value	<p>Succeed MXIO_OK.</p> <p>Fail Refer to Return Codes.</p>

E42_AO_GetPowerOnValues	This function code is used to get the power on raw data of contiguous A/O channels.
C#	<pre>int E42_AO_GetPowerOnValues(Int32 hConnection, byte bytSlot, byte bytStartChannel, byte bytCount, UInt16[] wValue);</pre>
VB.NET	<pre>E42_AO_GetPowerOnValues (ByVal hConnection As Integer, ByVal bytSlot As Byte, ByVal bytStartChannel As Byte, ByVal bytCount As Byte, ByVal iValue() As UInt16) As Integer</pre>
Arguments	<p>hConnection: The handle for an I/O device connection.</p> <p>bytSlot: Slot number of the I/O module. The Slot number ranges from 1 to 16. But this parameter is inactive on the ioLogik 2000.</p> <p>bytStartChannel: Specifies the starting channel.</p> <p>bytCount: The number of channels to be read.</p> <p>wValue: An array that stores the contiguous A/O channel's power on raw data to be get. The wValue[0] represents the value of the starting channel.</p>
Return Value	<p>Succeed MXIO_OK.</p> <p>Fail Refer to Return Codes.</p>

E42_AO_SetPowerOnValues	This function code is used to set the power on raw data for contiguous A/O channels.
C#	<pre>int E42_AO_SetPowerOnValues(Int32 hConnection, byte bytSlot, byte bytStartChannel, byte bytCount, UInt16[] wValue);</pre>
VB.NET	<pre>E42_AO_SetPowerOnValues (ByVal hConnection As Integer, ByVal bytSlot As Byte, ByVal bytStartChannel As Byte, ByVal bytCount As Byte, ByVal iValue() As UInt16) As Integer</pre>
Arguments	<p>hConnection: The handle for an I/O device connection.</p> <p>bytSlot: Slot number of the I/O module. The Slot number ranges from 1 to 16. But this parameter is inactive on the ioLogik 2000.</p> <p>bytStartChannel: Specifies the starting channel.</p> <p>bytCount: The number of channels to be set.</p> <p>wValue: An array that stores the contiguous A/O channel's power on raw data to be set. The wValue[0] represents the value of the starting channel.</p>
Return Value	<p>Succeed MXIO_OK.</p> <p>Fail Refer to Return Codes.</p>

E42_AO_Reads	This function code is used to read the output value of contiguous analog output channels.
C#	int E42_AO_Reads(Int32 hConnection, byte bytSlot, byte bytStartChannel, byte bytCount, double[] dValue);
VB.NET	E42_AO_Reads(ByVal hConnection As Integer, ByVal bytSlot As Byte, ByVal bytStartChannel As Byte, ByVal bytCount As Byte, ByVal dValue() As Double) As Integer
Arguments	<p>hConnection: The handle for an I/O device connection.</p> <p>bytSlot: Slot number of the I/O module. The Slot number ranges from 1 to 16. But this parameter is inactive on the ioLogik 2000.</p> <p>bytStartChannel: Specifies the starting channel.</p> <p>bytCount: The number of channels to be read.</p> <p>dValue: An array that stores the contiguous channel output value to be read. The dValue[0] represents the value of the starting channel. The unit is Vdc for the voltage channel and mA for the current channel.</p>
Return Value	<p>Succeed MXIO_OK.</p> <p>Fail Refer to Return Codes.</p>

E42_AO_Writes	This function code is used to write the output value for contiguous channels.
C#	int E42_AO_Writes(Int32 hConnection, byte bytSlot, byte bytStartChannel, byte bytCount, double[] dValue);
VB.NET	E42_AO_Writes(ByVal hConnection As Integer, ByVal bytSlot As Byte, ByVal bytStartChannel As Byte, ByVal bytCount As Byte, ByVal dValue() As Double) As Integer
Arguments	<p>hConnection: The handle for an I/O device connection.</p> <p>bytslot: Slot number of the I/O module. The Slot number ranges from 1 to 16. But this parameter is inactive on the ioLogik 2000.</p> <p>bytStartChannel: Specifies the starting channel.</p> <p>bytCount: The number of channels to be write.</p> <p>dValue: An array that stores the contiguous channel output value to write. The dValue[0] represents the value of the starting analog output channel. The unit is Vdc for the voltage channel and mA for the current channel.</p>
Return Value	<p>Succeed MXIO_OK.</p> <p>Fail Refer to Return Codes.</p>

E42_AO_ReadRaws	This function code is used to read the output raw data of contiguous analog output channels.
C#	int E42_AO_ReadRaws(Int32 hConnection, byte bytSlot, byte bytStartChannel, byte bytCount, UInt16[] wValue);
VB.NET	E42_AO_ReadRaws(ByVal hConnection As Integer, ByVal bytSlot As Byte, ByVal bytStartChannel As Byte, ByVal bytCount As Byte, ByVal iValue() As UInt16) As Integer
Arguments	<p>hConnection: The handle for an I/O device connection.</p> <p>bytSlot: Slot number of the I/O module. The Slot number ranges from 1 to 16. But this parameter is inactive on the ioLogik 2000.</p> <p>bytStartChannel: Specifies the starting channel.</p> <p>bytCount: The number of channels to be read.</p> <p>wValue: An array that stores the contiguous channel output raw data to be read. The wValue[0] represents the value of the starting channel.</p>
Return Value	<p>Succeed MXIO_OK.</p> <p>Fail Refer to Return Codes.</p>

E42_AO_WriteRaws	This function code is used to write the output raw data for contiguous channels.
C#	int E42_AO_WriteRaws(Int32 hConnection, byte bytSlot, byte bytStartChannel, byte bytCount, UInt16[] wValue);
VB.NET	E42_AO_WriteRaws(ByVal hConnection As Integer, ByVal bytSlot As Byte, ByVal bytStartChannel As Byte, ByVal bytCount As Byte, ByVal iValue() As UInt16) As Integer
Arguments	<p>hConnection: The handle for an I/O device connection.</p> <p>bytSlot: Slot number of the I/O module. The Slot number ranges from 1 to 16. But this parameter is inactive on the ioLogik 2000.</p> <p>bytStartChannel: Specifies the starting channel.</p> <p>bytCount: The number of channels to be write.</p> <p>wValue: An array that stores the contiguous channel output raw data to write. The wValue[0] represents the value of the starting analog output channel.</p>
Return Value	<p>Succeed MXIO_OK.</p> <p>Fail Refer to Return Codes.</p>

E42_AO_GetFaultValues	This function code is used to get the fault value of contiguous analog output channels.
C#	int E42_AO_GetFaultValues(Int32 hConnection, byte bytSlot, byte bytStartChannel, byte bytCount, UInt16[] wValue);
VB.NET	E42_AO_GetFaultValues (ByVal hConnection As Integer, ByVal bytSlot As Byte, ByVal bytStartChannel As Byte, ByVal bytCount As Byte, ByVal iValue() As UInt16) As Integer
Arguments	<p>hConnection: The handle for an I/O device connection.</p> <p>bytSlot: Slot number of the I/O module. The Slot number ranges from 1 to 16. But this parameter is inactive on the ioLogik 2000.</p> <p>bytStartChannel: Specifies the starting channel.</p> <p>bytCount: The number of channels to be read.</p> <p>wValue: An array that stores the contiguous A/O channel's safe raw data to be get. The wValue[0] represents the value of the starting channel.</p>
Return Value	<p>Succeed MXIO_OK.</p> <p>Fail Refer to Return Codes.</p>

E42_AO_SetFaultValues	This function code is used to set the safe raw data for contiguous A/O channels.
C#	<pre>int E42_AO_SetFaultValues(Int32 hConnection, byte bytSlot, byte bytStartChannel, byte bytCount, UInt16[] wValue);</pre>
VB.NET	<pre>E42_AO_SetFaultValues (ByVal hConnection As Integer, ByVal bytSlot As Byte, ByVal bytStartChannel As Byte, ByVal bytCount As Byte, ByVal iValue() As UInt16) As Integer</pre>
Arguments	<p>hConnection: The handle for an I/O device connection.</p> <p>bytSlot: Slot number of the I/O module. The Slot number ranges from 1 to 16. But this parameter is inactive on the ioLogik 2000.</p> <p>bytStartChannel: Specifies the starting channel.</p> <p>bytCount: The number of channels to write.</p> <p>wValue: An array that stores the contiguous channel safe raw data to set. The wValue[0] represents the value of the starting analog output channel.</p>
Return Value	<p>Succeed MXIO_OK.</p> <p>Fail Refer to Return Codes.</p>

Relay Commands for ioLogik 2000

RLY2K_GetResetTime	This function code is used to get the reset time for D/O channel.
C#	<code>int RLY2K_GetResetTime(Int32 hConnection, byte bytChannel, UInt16[] wValue);</code>
VB.NET	<code>RLY2K_GetResetTime(ByVal hConnection As Integer, ByVal bytChannel As Byte, ByVal iValue() As UInt16) As Integer</code>
Arguments	<p>hConnection: The handle for an I/O device connection.</p> <p>bytChannel: The specific channel to be get.</p> <p>wValue: An array that stores the contiguous D/O channels relay time. wValue[0]~wValue[5]=> sec/min/hour/day/month/year represents the value of the specific channel.</p>
Return Value	<p>Succeed MXIO_OK.</p> <p>Fail Refer to Return Codes.</p>

RLY2K_TotalCntRead	This function code is used to get the count value for contiguous D/O channel.
C#	<code>int RLY2K_TotalCntRead(Int32 hConnection, byte bytChannel, UInt32[] dwValue);</code>
VB.NET	<code>RLY2K_TotalCntRead(ByVal hConnection As Integer, ByVal bytChannel As Byte, ByRef nValue As UInt32) As Integer</code>
Arguments	<p>hConnection: The handle for an I/O device connection.</p> <p>bytChannel: The specific channel to be get.</p> <p>dwValue: A pointer that stores the count value of contiguous D/O channel.</p>
Return Value	<p>Succeed MXIO_OK.</p> <p>Fail Refer to Return Codes.</p>

RLY2K_TotalCntReads	This function code is used to get the count value for contiguous D/O channel.
C#	int RLY2K_TotalCntReads(Int32 hConnection, byte bytStartChannel, byte bytCount, UInt32[] dwValue);
VB.NET	RLY2K_TotalCntReads (ByVal hConnection As Integer, ByVal bytStartChannel As Byte, ByVal bytCount As Byte, ByVal nValue() As UInt32) As Integer
Arguments	<p>hConnection: The handle for an I/O device connection.</p> <p>bytStartChannel: Specifies the starting channel.</p> <p>bytCount: The number of channels to be set.</p> <p>wValue: An array that stores the contiguous D/O channels relay count. wValue[0] represents the value of the starting channel.</p>
Return Value	<p>Succeed MXIO_OK.</p> <p>Fail Refer to Return Codes.</p>

RLY2K_CurrentCntRead	This function code is used to get the count value for contiguous D/O channel.
C#	int RLY2K_CurrentCntRead(Int32 hConnection, byte bytChannel, UInt32[] dwValue);
VB.NET	RLY2K_CurrentCntRead (ByVal hConnection As Integer, ByVal bytChannel As Byte, ByRef nValue As UInt32) As Integer
Arguments	<p>hConnection: The handle for an I/O device connection.</p> <p>bytChannel: The specific channel to be get.</p> <p>dwValue: A pointer that stores the count value of contiguous D/O channel.</p>
Return Value	<p>Succeed MXIO_OK.</p> <p>Fail Refer to Return Codes.</p>

RLY2K_CurrentCntReads	This function code is used to get the count value for contiguous D/O channel.
C#	int RLY2K_CurrentCntReads(Int32 hConnection, byte bytStartChannel, byte bytCount, UInt32[] dwValue);
VB.NET	RLY2K_CurrentCntReads(ByVal hConnection As Integer, ByVal bytStartChannel As Byte, ByVal bytCount As Byte, ByVal nValue() As UInt32) As Integer
Arguments	<p>hConnection: The handle for an I/O device connection.</p> <p>bytStartChannel: Specifies the starting channel.</p> <p>bytCount: The number of channels to be set.</p> <p>wValue: An array that stores the contiguous D/O channels relay count. wValue[0] represents the value of the starting channel.</p>
Return Value	<p>Succeed MXIO_OK.</p> <p>Fail Refer to Return Codes.</p>

RLY2K_ResetCnt	This function code is used to reset count value for contiguous D/O channel.
C#	int RLY2K_ResetCnt(Int32 hConnection, byte bytChannel);
VB.NET	RLY2K_ResetCnt(ByVal hConnection As Integer, ByVal bytChannel As Byte) As Integer
Arguments	<p>hConnection: The handle for an I/O device connection.</p> <p>bytChannel: The specific channel to be reset.</p>
Return Value	<p>Succeed MXIO_OK.</p> <p>Fail Refer to Return Codes.</p>

RLY2K_ResetCnts	This function code is used to reset count value for contiguous D/O channel.	
C#	int RLY2K_ResetCnts(Int32	hConnection,
	byte	bytStartChannel,
	byte	bytCount);
VB.NET	RLY2K_ResetCnts(ByVal	hConnection As Integer,
	ByVal	bytStartChannel As Byte,
	ByVal	bytCount As Byte) As Integer
Arguments	hConnection:	The handle for an I/O device connection.
	bytStartChannel:	Specifies the starting channel.
	bytCount:	The number of channels to be reset.
Return Value	Succeed	MXIO_OK.
	Fail	Refer to Return Codes.

Relay Commands for ioLogik W5000

W5K_RLY_GetResetTime	This function code is used to get reset time of D/O channels.
C#	<pre>int W5K_RLY_GetResetTime (Int32 hConnection, byte bytChannel, UInt16[] wValue);</pre>
VB.NET	<pre>W5K_RLY_GetResetTime(ByVal hConnection As Integer, ByVal bytChannel As Byte, ByVal iValue() As UInt16) As Integer</pre>
Arguments	<p>hConnection: The handle for an I/O device connection.</p> <p>bytChannel: Specifies channel to be get.</p> <p>wValue: An array that stores the contiguous D/O channels relay reset time. wValue[0]~ wValue[5] => “sec/min/hour/day/month/year” represents the value of the specific channel.</p>
Return Value	<p>Succeed MXIO_OK.</p> <p>Fail Refer to Return Codes.</p>

W5K_RLY_TotalCntReads	This function code is used to get count value of contiguous D/O channels.
C#	<pre>int W5K_RLY_TotalCntReads (Int32 hConnection, byte bytStartChannel, byte bytCount, UInt32[] dwValue);</pre>
VB.NET	<pre>W5K_RLY_TotalCntReads (ByVal hConnection As Integer, ByVal bytStartChannel As Byte, ByVal bytCount As Byte, ByVal nValue() As UInt32) As Integer</pre>
Arguments	<p>hConnection: The handle for an I/O device connection.</p> <p>bytStartChannel: Specifies the starting channel.</p> <p>bytCount: The number of channels to be set.</p> <p>wValue: An array that stores the contiguous D/O channels relay count. wValue[0] represents the value of the starting channel.</p>
Return Value	<p>Succeed MXIO_OK.</p> <p>Fail Refer to Return Codes.</p>

W5K_RLY_CurrentCntReads	This function code is used to get count value of contiguous D/O channels.
C#	<pre>int W5K_RLY_CurrentCntReads (Int32 hConnection, byte bytStartChannel, byte bytCount, UInt32[] dwValue);</pre>
VB.NET	<pre>W5K_RLY_CurrentCntReads (ByVal hConnection As Integer, ByVal bytStartChannel As Byte, ByVal bytCount As Byte, ByVal nValue() As UInt32) As Integer</pre>
Arguments	<p>hConnection: The handle for an I/O device connection.</p> <p>bytStartChannel: Specifies the starting channel.</p> <p>bytCount: The number of channels to be set.</p> <p>wValue: An array that stores the contiguous D/O relay count. wValue[0] represents the value of the starting channel.</p>
Return Value	<p>Succeed MXIO_OK.</p> <p>Fail Refer to Return Codes.</p>

W5K_RLY_ResetCnts	This function code is used to reset count value of contiguous D/O channels.	
C#	int W5K_RLY_ResetCnts(Int32	hConnection,
	byte	bytStartChannel,
	byte	bytCount);
VB.NET	W5K_RLY_ResetCnts	
	(ByVal hConnection As Integer,	
	ByVal bytStartChannel As Byte,	
	ByVal bytCount As Byte) As Integer	
Arguments	hConnection:	The handle for an I/O device connection.
	bytStartChannel:	Specifies the starting channel.
	bytCount:	The number of channels to be reset.
Return Value	Succeed	MXIO_OK.
	Fail	Refer to Return Codes.

Relay Commands for ioLogik E1200

E1K_RLY_TotalCntReads	This function code is used to get count value of contiguous D/O channels.
C#	<pre>int E1K_RLY_TotalCntReads(Int32 hConnection, byte bytStartChannel, byte bytCount, UInt32[] dwValue);</pre>
VB.NET	<pre>E1K_RLY_TotalCntReads(ByVal hConnection As Integer, ByVal byStartChannel As Byte, ByVal bytCount As Byte, ByVal nValue() As UInt32) As Integer</pre>
Arguments	<p>hConnection: The handle for an I/O device connection.</p> <p>bytStartChannel: Specifies the starting channel.</p> <p>bytCount: The number of channels to be set.</p> <p>wValue: An array that stores the contiguous D/O channels relay count. wValue[0] represents the value of the starting channel.</p>
Return Value	<p>Succeed MXIO_OK.</p> <p>Fail Refer to Return Codes.</p>

RTD Commands

RTD_Reads	This function code is used to read the temperature values for contiguous channels.
C#	<pre>int RTD_Reads(Int32 hConnection, byte bytSlot, byte bytStartChannel, byte bytCount, double[] dValue);</pre>
VB.NET	<pre>RTD_Reads(ByVal hConnection As Integer, ByVal bytSlot As Byte, ByVal bytStartChannel As Byte, ByVal bytCount As Byte, ByVal dValue() As Double) As Integer</pre>
Arguments	<p>hConnection: The handle for an I/O device connection.</p> <p>bytSlot: Slot number of the I/O module, from 1 to 32. This parameter is inactive for the ioLogik E2000 and R2000.</p> <p>bytStartChannel: Specifies the starting channel.</p> <p>bytCount: The number of channels to be read.</p> <p>dValue: An array that stores the temperature values of the contiguous channels. dValue[0] represents the start channel.</p> <p>When dValue is 0x8000, it means the sensor is not wired correctly, or the measured value is out of range. When using the RTD module for Resistance Input, the unit is Ohm. When the operating mode is temperature sensor, the unit is C or F, depending on the setting. Use the ioAdmin utility to check the current settings for the desired channels.</p>
Return Value	<p>Succeed MXIO_OK.</p> <p>Fail Refer to Return Codes.</p>

RTD_Read	This function code is used to read the temperature value for a specific channel.
C#	<pre>int RTD_Read(Int32 hConnection, byte bytSlot, byte bytChannel, double[] dValue);</pre>
VB.NET	<pre>RTD_Read(ByVal hConnection As Integer, ByVal bytSlot As Byte, ByVal bytChannel As Byte, ByRef dValue As Double) As Integer</pre>
Arguments	<p>hConnection: The handle for an I/O device connection.</p> <p>bytSlot: Slot number of the I/O module, from 1 to 32. This parameter is inactive for the ioLogik E2000 and R2000.</p> <p>bytChannel: The specific channel to be read.</p> <p>dValue: A pointer to the temperature value of the desired channel. When dValue is 0x8000, it means the sensor is not correctly wired or the measured value is out of range. When using the RTD module for Resistance Input, the unit is Ohm. When the operating mode is temperature sensor, the unit is C or F, depending on the setting. Use the ioAdmin utility to check the current settings for the desired channels.</p>
Return Value	<p>Succeed MXIO_OK.</p> <p>Fail Refer to Return Codes.</p>

RTD_ReadRaws	This function code is used to read the temperatures for contiguous channels in raw data format.
C#	int RTD_ReadRaws(Int32 hConnection, byte bytSlot, byte bytStartChannel, byte bytCount, UInt16[] wValue);
VB.NET	RTD_ReadRaws(ByVal hConnection As Integer, ByVal bytSlot As Byte, ByVal bytStartChannel As Byte, ByVal bytCount As Byte, ByVal iValue() As UInt16) As Integer
Arguments	<p>hConnection: The handle for an I/O device connection.</p> <p>bytSlot: Slot number of the I/O module, from 1 to 32. This parameter is inactive for the ioLogik E2000 and R2000.</p> <p>bytStartChannel: Specifies the starting channel.</p> <p>bytCount: The number of channels to be read.</p> <p>wValue: An array that stores the temperature values of the contiguous channels in raw data format. wValue [0] represents the start channel.</p> <p>When wValue is 0x8000, it means the sensor is not wired correctly, or the measured value is out of range.</p> <p>When using the RTD module for Resistance Input 1~2000Ω, 100 mΩ/1count.</p> <p>When using the RTD module for Resistance Input 1~327Ω, 10 mΩ/1count.</p> <p>When using the RTD module for Resistance Input 1~620Ω, 20 mΩ/1count.</p> <p>When the operating mode is temperature sensor, 0.1°C (°F)/1count, depending on the setting. Use the ioAdmin utility to check the current settings for the desired channels.</p>
Return Value	<p>Succeed MXIO_OK.</p> <p>Fail Refer to Return Codes.</p>

RTD_ReadRaw	This function code is used to read the temperature value of a specific channel in raw data format.
C#	int RTD_ReadRaw(Int32 hConnection, byte bytSlot, byte bytChannel, UInt16[] wValue);
VB.NET	RTD_ReadRaw(ByVal hConnection As Integer, ByVal bytSlot As Byte, ByVal bytChannel As Byte, ByVal iValue As UInt16) As Integer
Arguments	<p>hConnection: The handle for an I/O device connection.</p> <p>bytSlot: Slot number of the I/O module, from 1 to 32. This parameter is inactive for the ioLogik E2000 and R2000.</p> <p>bytChannel: The specific channel to be read.</p> <p>wValue: A pointer to the temperature value of the desired channel. When wValue is 0x8000, it means the sensor is not wired correctly, or the measured value is out of range.</p> <p>When using the RTD module for Resistance Input 1~2000Ω, 100 mΩ/1count.</p> <p>When using the RTD module for Resistance Input 1~327Ω, 10 mΩ/1count.</p> <p>When using the RTD module for Resistance Input 1~620Ω, 20 mΩ/1count.</p> <p>When the operating mode is temperature sensor, 0.1°C (°F)/1count, depending on the setting. Use the ioAdmin utility to check the current settings for the desired channels.</p>
Return Value	<p>Succeed MXIO_OK.</p> <p>Fail Refer to Return Codes.</p>

RTD Commands for ioLogik E2000

RTD2K_ResetMin	This function code is used to reset the RTD input minimize value for a specific channel.
C#	int RTD2K_ResetMin(Int32 hConnection, byte bytChannel);
VB.NET	RTD2K_ResetMin(ByVal hConnection As Integer, ByVal bytChannel As Byte) As Integer
Arguments	hConnection: The handle for an I/O device connection. bytChannel: The specific channel to be reset.
Return Value	Succeed MXIO_OK. Fail Refer to Return Codes.

RTD2K_ResetMins	This function code is used to reset contiguous RTD channel's minimize value.
C#	int RTD2K_ResetMins(Int32 hConnection, byte bytStartChannel, byte bytCount);
VB.NET	RTD2K_ResetMins(ByVal hConnection As Integer, ByVal bytStartChannel As Byte, ByVal bytCount As Byte) As Integer
Arguments	hConnection: The handle for an I/O device connection. bytStartChannel: Specifies the starting channel. bytCount: The number of channels to be reset.
Return Value	Succeed MXIO_OK. Fail Refer to Return Codes.

RTD2K_ResetMax	This function code is used to reset the RTD input maximize value for a specific channel.
C#	int RTD2K_ResetMax(Int32 hConnection, byte bytChannel);
VB.NET	RTD2K_ResetMax(ByVal hConnection As Integer, ByVal bytChannel As Byte) As Integer
Arguments	hConnection: The handle for an I/O device connection. bytChannel: The specific channel to be reset.
Return Value	Succeed MXIO_OK. Fail Refer to Return Codes.

RTD2K_ResetMaxs	This function code is used to reset contiguous RTD channel's maximize value.
C#	int RTD2K_ResetMaxs(Int32 hConnection, byte bytStartChannel, byte bytCount);
VB.NET	RTD2K_ResetMaxs(ByVal hConnection As Integer, ByVal bytStartChannel As Byte, ByVal bytCount As Byte) As Integer
Arguments	hConnection: The handle for an I/O device connection. bytStartChannel: Specifies the starting channel. bytCount: The number of channels to be reset.
Return Value	Succeed MXIO_OK. Fail Refer to Return Codes.

RTD2K_ReadMinRaw	This function code is used to read the RTD input minimize raw data for a specific channel.
C#	int RTD2K_ReadMinRaw(Int32 hConnection, byte bytChannel, UInt16[] wValue);
VB.NET	RTD2K_ReadMinRaw(ByVal hConnection As Integer, ByVal bytChannel As Byte, ByRef nValue As UInt32) As Integer
Arguments	hConnection: The handle for an I/O device connection. bytChannel : The specific channel to be read. iValue: A pointer that stores the specific RTD channel's minimize raw data.
Return Value	Succeed MXIO_OK. Fail Refer to Return Codes.

RTD2K_ReadMinRaws	This function code is used to read contiguous RTD channel's minimize raw data.
C#	int RTD2K_ReadMinRaws(Int32 hConnection, byte bytStartChannel, byte bytCount, UInt16[] wValue);
VB.NET	RTD2K_ReadMinRaws(ByVal hConnection As Integer, ByVal bytStartChannel As Byte, ByVal bytCount As Byte, ByVal iValue() As UInt16) As Integer
Arguments	hConnection: The handle for an I/O device connection. bytStartChannel: Specifies the starting channel. bytCount: The number of channels to be read. wValue: An array that stores the contiguous RTD channel's minimize raw data , wValue[0] represents the value of the starting channel.
Return Value	Succeed MXIO_OK. Fail Refer to Return Codes.

RTD2K_ReadMaxRaw	This function code is used to read the RTD input maximize raw data for a specific channel.
C#	int RTD2K_ReadMaxRaw(Int32 hConnection, byte bytChannel, UInt16[] wValue);
VB.NET	RTD2K_ReadMaxRaw(ByVal hConnection As Integer, ByVal bytChannel As Byte, ByRef iValue As UInt16) As Integer
Arguments	hConnection: The handle for an I/O device connection. bytChannel : The specific channel to be read. wValue: A pointer that stores the specific RTD channel's maximize raw data.
Return Value	Succeed MXIO_OK. Fail Refer to Return Codes.

RTD2K_ReadMaxRaws	This function code is used to read contiguous RTD channel's maximize raw data.
C#	int RTD2K_ReadMaxRaws(Int32 hConnection, byte bytStartChannel, byte bytCount, UInt16[] wValue);
VB.NET	RTD2K_ReadMaxRaws(ByVal hConnection As Integer, ByVal bytStartChannel As Byte, ByVal bytCount As Byte, ByVal iValue() As UInt16) As Integer
Arguments	hConnection: The handle for an I/O device connection. bytStartChannel: Specifies the starting channel. bytCount: The number of channels to be read. wValue: An array that stores the contiguous RTD channel's maximize raw data , wValue[0] represents the value of the starting channel.
Return Value	Succeed MXIO_OK. Fail Refer to Return Codes.

RTD2K_ReadMin	This function code is used to read the RTD input minimize value for a specific channel.	
C#	<pre>int RTD2K_ReadMin(Int32 hConnection, byte bytChannel, double[] dValue);</pre>	
VB.NET	<pre>RTD2K_ReadMin(ByVal hConnection As Integer, ByVal bytChannel As Byte, ByRef dValue As Double) As Integer</pre>	
Arguments	<p>hConnection: The handle for an I/O device connection.</p> <p>bytChannel: The specific channel to be read.</p> <p>dValue: A pointer that stores the specific channel RTD input minimize value to be read. The unit is Ω for the Ohm, °C for Celsius and °F for Fahrenheit.</p>	
Return Value	<p>Succeed MXIO_OK.</p> <p>Fail Refer to Return Codes.</p>	

RTD2K_ReadMins	This function code is used to read contiguous RTD channel's minimize value.
C#	int RTD2K_ReadMins(Int32 hConnection, byte bytStartChannel, byte bytCount, double[] dValue);
VB.NET	RTD2K_ReadMins(ByVal hConnection As Integer, ByVal bytStartChannel As Byte, ByVal bytCount As Byte, ByVal dValue() As Double) As Integer
Arguments	<p>hConnection: The handle for an I/O device connection.</p> <p>bytStartChannel: Specifies the starting channel.</p> <p>bytCount: The number of channels to be read.</p> <p>dValue: An array that stores the contiguous RTD channel's minimize value , dValue[0] represents the value of the starting channel. The unit is Ω for the Ohm, °C for Celsius and °F for Fahrenheit.</p>
Return Value	<p>Succeed MXIO_OK.</p> <p>Fail Refer to Return Codes.</p>

RTD2K_ReadMax	This function code is used to read the RTD input maximize value for a specific channel.
C#	int RTD2K_ReadMax(Int32 hConnection, byte bytChannel, double[] dValue);
VB.NET	RTD2K_ReadMax(ByVal hConnection As Integer, ByVal bytChannel As Byte, ByRef dValue As Double) As Integer
Arguments	<p>hConnection : The handle for an I/O device connection.</p> <p>bytChannel : The specific channel to be read.</p> <p>dValue: A pointer that stores the specific channel RTD input maximize value to be read. The unit is Ω for the Ohm, °C for Celsius and °F for Fahrenheit.</p>
Return Value	<p>Succeed MXIO_OK.</p> <p>Fail Refer to Return Codes.</p>

RTD2K_ReadMaxs	This function code is used to read contiguous RTD channel's maximize value.
C#	int RTD2K_ReadMaxs(Int32 hConnection, byte bytStartChannel, byte bytCount, double[] dValue);
VB.NET	RTD2K_ReadMaxs(ByVal hConnection As Integer, ByVal bytStartChannel As Byte, ByVal bytCount As Byte, ByVal dValue() As Double) As Integer
Arguments	<p>hConnection: The handle for an I/O device connection.</p> <p>bytStartChannel: Specifies the starting channel.</p> <p>bytCount: The number of channels to be read.</p> <p>dValue: An array that stores the contiguous RTD channel's maximize value, dValue[0] represents the value of the starting channel. The unit is Ω for the Ohm, °C for Celsius and °F for Fahrenheit.</p>
Return Value	<p>Succeed MXIO_OK.</p> <p>Fail Refer to Return Codes.</p>

RTD2K_GetChannelStatus	This function code is used to get specific channel's status.
C#	int RTD2K_GetChannelStatus(Int32 hConnection, byte bytChannel, byte[] bytStatus);
VB.NET	RTD2K_GetChannelStatus(ByVal hConnection As Integer, ByVal bytChannel As Byte, ByRef bytStatus As Byte) As Integer
Arguments	<p>hConnection: The handle for an I/O device connection.</p> <p>bytChannel: The specific channel to be get.</p> <p>bytStatus: A pointer that stores the specific RTD channel's start status. The values are :</p> <p>0 : stop</p> <p>1 : start</p>
Return Value	<p>Succeed MXIO_OK.</p> <p>Fail Refer to Return Codes.</p>

RTD2K_SetChannelStatus	This function code is used to set specific channel's status.
<p>C#</p> <p>VB.NET</p> <p>Arguments</p> <p>Return Value</p>	<pre>int RTD2K_SetChannelStatus(Int32 hConnection, byte bytChannel, byte bytStatus);</pre> <p>RTD2K_SetChannelStatus (ByVal hConnection As Integer, ByVal bytChannel As Byte, ByVal bytStatus As Byte) As Integer</p> <p>hConnection: The handle for an I/O device connection. bytChannel: The specific channel to be set. bytStatus: A pointer that stores the specific RTD channel's start status. The values are : 0 : stop 1 : start</p> <p>Succeed MXIO_OK. Fail Refer to Return Codes.</p>

RTD2K_GetChannelStatuses	This function code is used to get contiguous channel's status.	
C#	int RTD2K_GetChannelStatuses(Int32	hConnection, byte bytStartChannel, byte bytCount, UInt32[] dwStatus);
VB.NET	RTD2K_GetChannelStatuses (ByVal ByVal ByVal ByRef	hConnection As Integer, bytStartChannel As Byte, bytCount As Byte, nStatus As UInt32) As Integer
Arguments	hConnection: bytStartChannel: bytCount: dwStatus:	The handle for an I/O device connection. Specifies the starting channel. The number of channels to be set. A pointer that stores the contiguous RTD channel's start status; each bit holds one channel status. A bit value of 0 represents the status of the start channel. A bit value of 1 represents the second channel's status. The values are : 0 : stop 1 : start
Return Value	Succeed Fail	MXIO_OK. Refer to Return Codes.

RTD2K_SetChannelStatuses	This function code is used to set contiguous channel's status.	
C#	<pre>int RTD2K_SetChannelStatuses(Int32 hConnection, byte bytStartChannel, byte bytCount, UInt32 dwStatus);</pre>	
VB.NET	<pre>RTD2K_SetChannelStatuses (ByVal hConnection As Integer, ByVal bytStartChannel As Byte, ByVal bytCount As Byte, ByRef nStatus As UInt32) As Integer</pre>	
Arguments	<p>hConnection:</p> <p>bytStartChannel:</p> <p>bytCount:</p> <p>dwStatus:</p>	<p>The handle for an I/O device connection.</p> <p>Specifies the starting channel.</p> <p>The number of channels to be set.</p> <p>A pointer that stores the contiguous count channel's start status; each bit holds one channel status. A bit value of 0 represents the status of the start channel. A bit value of 1 represents the second channel's status. The values are :</p> <p>0 : stop</p> <p>1 : start</p>
Return Value	<p>Succeed</p> <p>Fail</p>	<p>MXIO_OK.</p> <p>Refer to Return Codes.</p>

RTD2K_GetSensorType	This function code is used to get the sensor type for a specific RTD channel.
C#	<pre>int RTD2K_GetSensorType(Int32 hConnection, byte bytChannel, UInt16[] wSensorType);</pre>
VB.NET	<pre>RTD2K_GetSensorType (ByVal hConnection As Integer, ByVal bytChannel As Byte, ByRef iSensorType As UInt16) As Integer</pre>
Arguments	<p>hConnection: The handle for an I/O device connection.</p> <p>bytChannel : The specific channel to be get.</p> <p>wSensorType: A pointer that stores the specific RTD channel's sensor type. The values for normal channels are:</p> <ul style="list-style-type: none"> 0=PT50 1=PT100 2=PT200 3=PT500 4=PT1000 5=JPT100 6=JPT200 7=JPT500 8=JPT1000 9=NI100 10=NI200 11=NI500 12=NI1000 13=NI120 14=310 Ohm 15=620 Ohm 16=1250 Ohm 17=2500 Ohm <p>Others : return Illegal Data Value</p> <p>The values for virtual channels are:</p> <ul style="list-style-type: none"> 20=AVG 21=DIV <p>Others : return Illegal Data Value</p>
Return Value	<p>Succeed MXIO_OK.</p> <p>Fail Refer to Return Codes.</p>

RTD2K_SetSensorType	This function code is used to set the sensor type for a specific RTD channel.
C#	<pre>int RTD2K_SetSensorType(Int32 hConnection, byte bytChannel, UInt16 wSensorType);</pre>
VB.NET	<pre>RTD2K_SetSensorType (ByVal hConnection As Integer, ByVal bytChannel As Byte, ByValSensorType As UInt16) As Integer</pre>
Arguments	<p>hConnection: The handle for an I/O device connection.</p> <p>bytChannel : The specific channel to be set.</p> <p>wSensorType: A pointer that stores the specific RTD channel's sensor type. The values for normal channels are:</p> <ul style="list-style-type: none"> 0=PT50 1=PT100 2=PT200 3=PT500 4=PT1000 5=JPT100 6=JPT200 7=JPT500 8=JPT1000 9=NI100 10=NI200 11=NI500 12=NI1000 13=NI120 14=310 Ohm 15=620 Ohm 16=1250 Ohm 17=2500 Ohm <p>Others : return Illegal Data Value</p> <p>The values for virtual channels are:</p> <ul style="list-style-type: none"> 20=AVG 21=DIV <p>Others : return Illegal Data Value</p>
Return Value	<p>Succeed MXIO_OK.</p> <p>Fail Refer to Return Codes.</p>

RTD2K_GetSensorTypes	This function code is used to get contiguous RTD channel's sensor type.
C#	<pre>int RTD2K_GetSensorTypes(Int32 hConnection, byte bytStartChannel, byte bytCount, UInt16[] wSensorType);</pre>
VB.NET	<pre>RTD2K_GetSensorTypes (ByVal hConnection As Integer, ByVal bytStartChannel As Byte, ByVal bytCount As Byte, ByVal iSensorType() As UInt16) As Integer</pre>
Arguments	<p>hConnection: The handle for an I/O device connection.</p> <p>bytStartChannel: Specifies the starting channel.</p> <p>bytCount: The number of channels to be read.</p> <p>wSensorType: An array that stores the contiguous RTD channel's sensor type, wSensorType[0] represents the value of the starting channel. The values for normal channel are:</p> <ul style="list-style-type: none"> 0=PT50 1=PT100 2=PT200 3=PT500 4=PT1000 5=JPT100 6=JPT200 7=JPT500 8=JPT1000 9=NI100 10=NI200 11=NI500 12=NI1000 13=NI120 14=310 Ohm 15=620 Ohm 16=1250 Ohm 17=2500 Ohm <p>Others : return Illegal Data Value</p> <p>The values for virtual channels are:</p> <ul style="list-style-type: none"> 20=AVG 21=DIV <p>Others : return Illegal Data Value</p>
Return Value	<p>Succeed MXIO_OK.</p> <p>Fail Refer to Return Codes.</p>

RTD2K_SetSensorTypes	This function code is used to set contiguous RTD channel's sensor type.
C#	<pre>int RTD2K_SetSensorTypes(Int32 hConnection, byte bytStartChannel, byte bytCount, UInt16[] wSensorType);</pre>
VB.NET	<pre>RTD2K_SetSensorTypes(ByVal hConnection As Integer, ByVal bytStartChannel As Byte, ByVal bytCount As Byte, ByVal iSensorType() As UInt16) As Integer</pre>
Arguments	<p>hConnection: The handle for an I/O device connection.</p> <p>bytStartChannel: Specifies the starting channel.</p> <p>bytCount: The number of channels to be set.</p> <p>wSensorType: An array that stores the contiguous RTD channel's sensor type, wSensorType[0] represents the value of the starting channel. The values for normal channel are:</p> <ul style="list-style-type: none"> 0=PT50 1=PT100 2=PT200 3=PT500 4=PT1000 5=JPT100 6=JPT200 7=JPT500 8=JPT1000 9=NI100 10=NI200 11=NI500 12=NI1000 13=NI120 14=310 Ohm 15=620 Ohm 16=1250 Ohm 17=2500 Ohm <p>Others : return Illegal Data Value</p> <p>The values for virtual channels are:</p> <ul style="list-style-type: none"> 20=AVG 21=DIV <p>Others : return Illegal Data Value</p>
Return Value	<p>Succeed MXIO_OK.</p> <p>Fail Refer to Return Codes.</p>

RTD2K_GetEngUnit	This function code is used to get the engineering unit for a specific RTD channel.
C#	<pre>int RTD2K_GetEngUnit(Int32 hConnection, byte bytChannel, UInt16[] wEngUnit);</pre>
VB.NET	<pre>RTD2K_GetEngUnit(ByVal hConnection As Integer, ByVal bytChannel As Byte, ByRef iEngUnit As UInt16) As Integer</pre>
Arguments	<p>hConnection: The handle for an I/O device connection.</p> <p>bytChannel : The specific channel to be get.</p> <p>wEngUnit: A pointer that stores the specific RTD channel's engineering unit. The values for normal channels are: 0=Celsius 1=Fahrenheit 2=Ohm Others_: return Illegal Data Value</p> <p>The values for virtual channels are: 0=Celsius 1=Fahrenheit Others_: return Illegal Data Value</p>
Return Value	<p>Succeed MXIO_OK.</p> <p>Fail Refer to Return Codes.</p>

RTD2K_SetEngUnit	This function code is used to set the engineering unit for a specific RTD channel.	
C#	int RTD2K_SetEngUnit(Int32 byte UInt16	hConnection, bytChannel, wEngUnit);
VB.NET	RTD2K_SetEngUnit(ByVal ByVal ByVal	hConnection As Integer, bytChannel As Byte, iEngUnit As UInt16) As Integer
Arguments	<p>hConnection:</p> <p>bytChannel :</p> <p>wEngUnit:</p>	<p>The handle for an I/O device connection.</p> <p>The specific channel to be set.</p> <p>A pointer that stores the specific RTD channel's engineering unit. The values for normal channels are:</p> <p>0=Celsius 1=Fahrenheit 2=Ohm Others_: return Illegal Data Value</p> <p>The values for virtual channels are:</p> <p>0=Celsius 1=Fahrenheit Others_: return Illegal Data Value</p>
Return Value	Succeed Fail	MXIO_OK. Refer to Return Codes.

RTD2K_GetEngUnits	This function code is used to get contiguous RTD channel's engineering unit.
C#	<pre>int RTD2K_GetEngUnits(Int32 hConnection, byte bytStartChannel, byte bytCount, UInt16[] wEngUnit);</pre>
VB.NET	<pre>RTD2K_GetEngUnits (ByVal hConnection As Integer, ByVal bytStartChannel As Byte, ByVal bytCount As Byte, ByVal iEngUnit() As UInt16) As Integer</pre>
Arguments	<p>Connection: The handle for an I/O device connection.</p> <p>bytStartChannel: Specifies the starting channel.</p> <p>bytCount: The number of channels to be read.</p> <p>wEngUnit: An array that stores the contiguous RTD channel's engineering unit, wEngUnit[0] represents the value of the starting channel. The values for normal channel are: 0=Celsius 1=Fahrenheit 2=Ohm Others_: return Illegal Data Value</p> <p>The values for virtual channels are: 0=Celsius 1=Fahrenheit Others_: return Illegal Data Value</p>
Return Value	<p>Succeed MXIO_OK.</p> <p>Fail Refer to Return Codes.</p>

RTD2K_SetEngUnits	This function code is used to get contiguous RTD channel's engineering unit.	
C#	<pre>int RTD2K_SetEngUnits(Int32 hConnection, byte bytStartChannel, byte bytCount, UInt16[] wEngUnit);</pre>	
VB.NET	<pre>RTD2K_SetEngUnits(ByVal hConnection As Integer, ByVal bytStartChannel As Byte, ByVal bytCount As Byte, ByVal iEngUnit() As UInt16) As Integer</pre>	
Arguments	<p>hConnection: bytStartChannel: bytCount: wEngUnit:</p>	<p>The handle for an I/O device connection. Specifies the starting channel. The number of channels to be set. An array that stores the contiguous RTD channel's engineering unit, wEngUnit[0] represents the value of the starting channel. The values for normal channel are: 0=Celsius 1=Fahrenheit 2=Ohm Others_: return Illegal Data Value</p> <p>The values for virtual channels are: 0=Celsius 1=Fahrenheit Others_: return Illegal Data Value</p>
Return Value	<p>Succeed Fail</p>	<p>MXIO_OK. Refer to Return Codes.</p>

RTD2K_GetMathPar	This function code is used to get the math parameter for a specific RTD channel.
C#	int RTD2K_GetMathPar(Int32 hConnection, byte bytChannel, UInt16[] wMathPar);
VB.NET	RTD2K_GetMathPar(ByVal hConnection As Integer, ByVal bytChannel As Byte, ByRef iMathPar As UInt16) As Integer
Arguments	<p>hConnection: The handle for an I/O device connection.</p> <p>bytChannel : The specific channel to be get.</p> <p>wMathPar: A pointer that stores the specific RTD channel's math parameter. For AVG, Bit 0 of high byte represents the first channel and Bit 1 of high byte represents the second channel. For DEV, the High-Byte as subtrahend and Low-Byte as minuend.</p> <p>Exp : AVG(b'0000-0000 b'0010-0011) = ch5+ch1+ch0 Exp : DEV(b'0000-0100 b'0010-0000) = ch2-ch6</p>
Return Value	<p>Succeed MXIO_OK.</p> <p>Fail Refer to Return Codes.</p>

RTD2K_SetMathPar	This function code is used to set the math parameter for a specific RTD channel.
C#	int RTD2K_SetMathPar(Int32 hConnection, byte bytChannel, UInt16 wMathPar);
VB.NET	RTD2K_SetMathPar(ByVal hConnection As Integer, ByVal bytChannel As Byte, ByVal iMathPar As UInt16) As Integer
Arguments	<p>hConnection: The handle for an I/O device connection.</p> <p>bytChannel : The specific channel to be set.</p> <p>wMathPar: A pointer that stores the specific RTD channel's math parameter. For AVG, Bit 0 of high byte represents the first channel and Bit 1 of high byte represents the second channel. For DEV, the High-Byte as subtrahend and Low-Byte as minuend.</p> <p>Exp : AVG(b'0000-0000 b'0010-0011) = ch5+ch1+ch0 Exp : DEV(b'0000-0100 b'0010-0000) = ch2-ch6</p>
Return Value	<p>Succeed MXIO_OK.</p> <p>Fail Refer to Return Codes.</p>

RTD2K_GetMathPars	This function code is used to get contiguous RTD virtual channel's math parameter.
C#	<pre>int RTD2K_GetMathPars(Int32 hConnection, byte bytStartChannel, byte bytCount, UInt16[] wMathPar);</pre>
VB.NET	<pre>RTD2K_GetMathPars (ByVal hConnection As Integer, ByVal bytStartChannel As Byte, ByVal bytCount As Byte, ByVal iMathPar() As UInt16) As Integer</pre>
Arguments	<p>hConnection: The handle for an I/O device connection.</p> <p>bytStartChannel: Specifies the starting channel.</p> <p>bytCount: The number of channels to be read.</p> <p>wMathPart: An array that stores the contiguous RTD channel's math parameter, wMathPar[0] represents the value of the starting channel. The values are :</p> <p>For AVG, Bit 0 of high byte represents the first channel and Bit 1 of high byte represents the second channel.</p> <p>For DEV, High-Byte as subtrahend and Low-Byte as minuend.</p> <p>Exp : AVG(b'0000-0000 b'0010-0011) = ch5+ch1+ch0</p> <p>Exp : DEV(b'0000-0100 b'0010-0000) = ch2-ch6</p>
Return Value	<p>Succeed MXIO_OK.</p> <p>Fail Refer to Return Codes.</p>

RTD2K_SetMathPars	This function code is used to set contiguous RTD virtual channel's math parameter.
C#	<pre>int RTD2K_SetMathPars(Int32 hConnection, byte bytStartChannel, byte bytCount, UInt16[] wMathPar);</pre>
VB.NET	<pre>RTD2K_SetMathPars (ByVal hConnection As Integer, ByVal bytStartChannel As Byte, ByVal bytCount As Byte, ByVal iMathPar() As UInt16) As Integer</pre>
Arguments	<p>hConnection: The handle for an I/O device connection.</p> <p>bytStartChannel: Specifies the starting channel.</p> <p>bytCount: The number of channels to be sets.</p> <p>wMathPart: An array that stores the contiguous RTD channel's math parameter, wMathPar[0] represents the value of the starting channel. The values are :</p> <p>For AVG, Bit 0 of high byte represents the first channel and Bit 1 of high byte represents the second channel.</p> <p>For DEV, High-Byte as subtrahend and Low-Byte as minuend.</p> <p>Exp : AVG(b'0000-0000 b'0010-0011) = ch5+ch1+ch0</p> <p>Exp : DEV(b'0000-0100 b'0010-0000) = ch2-ch6</p>
Return Value	<p>Succeed MXIO_OK.</p> <p>Fail Refer to Return Codes.</p>

RTD Commands for ioLogik E4200

E42_RTD_Reads	This function code is used to read the temperature value for contiguous channels.
C#	<pre>int E42_RTD_Reads(Int32 hConnection, byte bytSlot, byte bytStartChannel, byte bytCount, double[] dValue);</pre>
VB.NET	<pre>E42_RTD_Reads(ByVal hConnection As Integer, ByVal bytSlot As Byte, ByVal bytStartChannel As Byte, ByVal bytCount As Byte, ByVal dValue() As Double) As Integer</pre>
Arguments	<p>hConnection: The handle for an I/O device connection.</p> <p>bytSlot: Slot number of the I/O module. The Slot number ranges from 1 to 16. But this parameter is inactive on the ioLogik 2000.</p> <p>bytStartChannel: Specifies the starting channel.</p> <p>bytCount: The number of channels to be read.</p> <p>dValue: An array that stores the temperature value to be read. The dValue[0] represents the start channel. When the dValue is 0x8000, it means the sensor is not wired correctly, or the measured value is out of range. When using the E42_RTD module for Resistance Input, the unit is Ohm. When the operating mode is temperature sensor, the unit is °C or °F, depending on the setting. Check the ioAdmin utility for current settings.</p>
Return Value	<p>Succeed MXIO_OK.</p> <p>Fail Refer to Return Codes.</p>

E42_RTD_ReadRaws	This function code is used to read the temperature raw data for contiguous channels.
C#	<pre>int E42_RTD_ReadRaws(Int32 hConnection, byte bytSlot, byte bytStartChannel, byte bytCount, UInt16[] wValue);</pre>
VB.NET	<pre>E42_RTD_ReadRaws(ByVal hConnection As Integer, ByVal bytSlot As Byte, ByVal bytStartChannel As Byte, ByVal bytCount As Byte, ByVal iValue() As UInt16) As Integer</pre>
Arguments	<p>hConnection: The handle for an I/O device connection.</p> <p>bytSlot: Slot number of the I/O module. The Slot number ranges from 1 to 16. But this parameter is inactive on the ioLogik 2000.</p> <p>bytStartChannel: Specifies the starting channel.</p> <p>bytCount: The number of channels to be read.</p> <p>wValue: An array that stores the temperature value to be read. The wValue[0] represents the start channel. When the wValue is 0x8000, it means the sensor is not wired correctly, or the measured value is out of range. When using the E42_RTD module for Resistance Input 1 to 2000Ω, 100mΩ/1count. When using the E42_RTD module for Resistance Input 1 to 327Ω, 10mΩ/1count. When using the E42_RTD module for Resistance Input 1 to 620Ω, 20mΩ/1count. When the operating mode is temperature sensor, 0.1°C (°F)/1count, depending on the setting. Check the ioAdmin utility for current settings.</p>
Return Value	<p>Succeed MXIO_OK.</p> <p>Fail Refer to Return Codes.</p>

E42_RTD_GetEngUnit	This function code is used to get the temperatureType for contiguous channels.
C#	<pre>int E42_RTD_GetEngUnit(Int32 hConnection, byte bytSlot, UInt16[] wEngUnit);</pre>
VB.NET	<pre>E42_RTD_GetEngUnit(ByVal hConnection As Integer, ByVal bytSlot As Byte, ByRef iEngUnit As UInt16) As Integer</pre>
Arguments	<p>hConnection: The handle for an I/O device connection.</p> <p>bytSlot: Slot number of the I/O module. The Slot number ranges from 1 to 16.</p> <p>wEngUnit: An array that stores the contiguous A/O channel's safe action to be retrieved. The wEngUnit[0] represents the value of all channels. The values are: 0: Celsius 1: Fahrenheit</p>
Return Value	<p>Succeed MXIO_OK.</p> <p>Fail Refer to Return Codes.</p>

E42_RTD_SetEngUnit	This function code is used to set the temperature Type for contiguous channels.	
C#	<pre>int E42_RTD_SetEngUnit(Int32 hConnection, byte bytSlot, UInt16 wEngUnit);</pre>	
VB.NET	<pre>E42_RTD_SetEngUnit(ByVal hConnection As Integer, ByVal bytSlot As Byte, ByVal iEngUnit As UInt16) As Integer</pre>	
Arguments	<p>hConnection:</p> <p>bytSlot:</p> <p>wEngUnit:</p>	<p>The handle for an I/O device connection.</p> <p>Slot number of the I/O module. The Slot number ranges from 1 to 16.</p> <p>An array that stores the contiguous A/O channel's safe action to be set. The wEngUnit[0] represents the value of all channels. The values are:</p> <p>0: Celsius</p> <p>1: Fahrenheit</p>
Return Value	<p>Succeed</p> <p>Fail</p>	<p>MXIO_OK.</p> <p>Refer to Return Codes.</p>

E42_RTD_GetSensorType	This function code is used to get the Sensor Type for contiguous channels.
C#	<pre>int E42_RTD_GetSensorType(Int32 hConnection, byte bytSlot, UInt16[] wSensorType);</pre>
VB.NET	<pre>E42_RTD_GetSensorType(ByVal hConnection As Integer, ByVal bytSlot As Byte, ByRef iSensorType As UInt16) As Integer</pre>
Arguments	<p>hConnection: The handle for an I/O device connection.</p> <p>bytSlot: Slot number of the I/O module. The Slot number ranges from 1 to 16.</p> <p>wSensorType: An array that stores the contiguous RTD channel's sensor type, wSensorType[0] represents the value of all channels. The values for normal channels are:</p> <ul style="list-style-type: none"> 0=PT100 1=PT200 2=PT500 3=PT1000 4=PT50 16=JPT100 17=JPT200 18=JPT500 19=JPT1000 32=NI100 33=NI200 34=NI500 35=NI1000 48=NI120 64=CU10 128=1 to 2000 Ohm, 100 mohm/1 count 129=1 to 327 Ohm, 10 mohm/1 count 130=1 to 620 Ohm, 20 mohm/1 count <p>Others return Illegal Data Value</p>
Return Value	<p>Succeed MXIO_OK.</p> <p>Fail Refer to Return Codes.</p>

E42_RTD_SetSensorType	This function code is used to set the Sensor Type for contiguous channels.
C#	int E42_RTD_SetSensorType(Int32 hConnection, byte bytSlot, UInt16 wSensorType);
VB.NET	E42_RTD_SetSensorType(ByVal hConnection As Integer, ByVal bytSlot As Byte, ByVal iSensorType As UInt16) As Integer
Arguments	<p>hConnection: The handle for an I/O device connection.</p> <p>bytslot: Slot number of the I/O module. The Slot number ranges from 1 to 16.</p> <p>bytStartchannel: Specifies the starting channel.</p> <p>bytcount: The number of channels to be set.</p> <p>wSensorTypet: An array that stores the contiguous RTD channel's sensor type, wSensorType[0] represents the value of the starting channel. The values for normal channels are:</p> <p>0=PT100 1=PT200 2=PT500 3=PT1000 4=PT50 16=JPT100 17=JPT200 18=JPT500 19=JPT1000 32=NI100 33=NI200 34=NI500 35=NI1000 48=NI120 64=CU10 128=1 to 2000 Ohm, 100 mohm/1 count 129=1 to 327 Ohm, 10 mohm/1 count 130=1 to 620 Ohm, 20 mohm/1 count Others return Illegal Data Value</p>
Return Value	<p>Succeed MXIO_OK.</p> <p>Fail Refer to Return Codes.</p>

Thermocouple Commands

TC_Reads	This function code is used to read the temperature values for contiguous channels.	
C#	int TC_Reads(Int32 byte byte byte	hConnection, bytSlot, bytStartChannel, bytCount, double[] dValue);
VB.NET	TC_Reads(ByVal ByVal ByVal ByVal ByVal	hConnection As Integer, bytSlot As Byte, bytStartChannel As Byte, bytCount As Byte, dValue() As Double) As Integer
Arguments	<p>hConnection: The handle for an I/O device connection.</p> <p>bytSlot: Slot number of the I/O module, from 1 to 32. This parameter is inactive for the ioLogik E2000 and R2000.</p> <p>bytStartChannel: Specifies the starting channel.</p> <p>bytCount: The number of channels to be read.</p> <p>dValue: An array that stores the temperature values of the contiguous channels. dValue[0] represents start channel 0. When dValue is 0x8000, it means the sensor is not correctly wired. When the operating mode of the TC module is voltage input, the unit is μv. Use ioAdmin to check the I/O module settings.</p>	
Return Value	<p>Succeed MXIO_OK.</p> <p>Fail Refer to Return Codes.</p>	

TC_Read	This function code is used to read the temperature value of a specific channel.
C#	<pre>int TC_Read(Int32 hConnection, byte bytSlot, byte bytChannel, double[] dValue);</pre>
VB.NET	<pre>TC_Read(ByVal hConnection As Integer, ByVal bytSlot As Byte, ByVal bytChannel As Byte, ByRef dValue As Double) As Integer</pre>
Arguments	<p>hConnection: The handle for an I/O device connection.</p> <p>bytSlot: Slot number of the I/O module, from 1 to 32. This parameter is inactive for the ioLogik E2000 and R2000.</p> <p>bytChannel: The specific channel to be read.</p> <p>dValue: Stores the temperature value of the desired channel. When dValue is 0x8000, it means the sensor is not wired correctly. When the operating mode of the TC module is voltage input, the unit is μv. Use ioAdmin to check the I/O module settings.</p>
Return Value	<p>Succeed MXIO_OK.</p> <p>Fail Refer to Return Codes.</p>

TC_ReadRaws	This function code is used to read the temperature value of contiguous channels in raw data format.	
C#	int TC_ReadRaws(Int32 byte byte byte UInt16[]	hConnection, bytSlot, bytStartChannel, bytCount, wValue);
VB.NET	TC_ReadRaws(ByVal ByVal ByVal ByVal ByVal	hConnection As Integer, bytSlot As Byte, bytStartChannel As Byte, bytCount As Byte, iValue() As UInt16) As Integer
Arguments	<p>hConnection: The handle for an I/O device connection.</p> <p>bytSlot: Slot number of the I/O module, from 1 to 32. This parameter is inactive for the ioLogik E2000 and R2000.</p> <p>bytStartChannel: Specifies the starting channel.</p> <p>bytCount: The number of channels to be read.</p> <p>wValue: An array that stores the temperature values of the contiguous channels in raw data format. wValue[0] represents start channel 0. When wValue is 0x8000, it means the sensor is not correctly wired. When the operating mode is temperature sensor, 0.1°C (°F). When the operating mode of the TC module is -78.0 ~ 78.0 mV, 10 uV/count. When the operating mode of the TC module is -32.7 ~ 32.7 mV, 1uV/count. When the operating mode of the TC module is -65.5 ~ 65.5 mV, 2uV/count. Use ioAdmin to check the I/O module settings.</p>	
Return Value	<p>Succeed MXIO_OK.</p> <p>Fail Refer to Return Codes.</p>	

TC_ReadRaw	This function code is used to read the temperature value of a specific channel in raw data format.
C#	int TC_ReadRaw(Int32 hConnection, byte bytSlot, byte bytChannel, UInt16[] wValue);
VB.NET	TC_ReadRaw(ByVal hConnection As Integer, ByVal bytSlot As Byte, ByVal bytChannel As Byte, ByRef iValue As UInt16) As Integer
Arguments	<p>hConnection: The handle for an I/O device connection.</p> <p>bytSlot: Slot number of the I/O module, from 1 to 32. This parameter is inactive for the ioLogik E2000 and R2000.</p> <p>bytChannel: The specific channel to be read.</p> <p>wValue: A pointer to the temperature value to read. When wValue is 0x8000, it means the sensor is not correctly wired. When the operating mode is temperature sensor, 0.1°C (°F). When the operating mode of the TC module is -78.0 ~ 78.0 mV, 10uV/count. When the operating mode of the TC module is -32.7 ~ 32.7 mV, 1uV/count. When the operating mode of the TC module is -65.5 ~ 65.5 mV, 2uV/count. Use ioAdmin to check the I/O module settings.</p>
Return Value	<p>Succeed MXIO_OK.</p> <p>Fail Refer to Return Codes.</p>

TC Commands for ioLogik E4200

E42_TC_Reads	This function code is used to read the temperature value of contiguous channels.	
C#	int E42_TC_Reads(Int32	hConnection,
	byte	bytSlot,
	byte	bytStartChannel,
	byte	bytCount,
	double[]	dValue);
VB.NET	E42_TC_Reads(ByVal	hConnection As Integer,
	ByVal	bytSlot As Byte,
	ByVal	bytStartChannel As Byte,
	ByVal	bytCount As Byte,
	ByVal	dValue() As Double)
		As Integer
Arguments	hConnection:	The handle for an I/O device connection.
	bytSlot:	Slot number of the I/O module. The Slot number ranges from 1 to 16. But this parameter is inactive on the ioLogik 2000.
	bytStartchannel:	Specifies the starting channel.
	bytCount:	The number of channels to be read.
	dValue:	An array that stores the temperature value to read. The dValue[0] represents start channel 0. When the dValue is 0x8000, it means the sensor is not correctly wired. When the operating mode of the TC module is voltage input, the unit is μV . Use ioAdmin to check the I/O module settings.
Return Value	Succeed	MXIO_OK.
	Fail	Refer to Return Codes.

E42_TC_ReadRaws	This function code is used to read the temperature raw data of contiguous channels.
C#	<pre>int E42_TC_ReadRaws(Int32 hConnection, byte bytSlot, byte bytStartChannel, byte bytCount, UInt16[] wValue);</pre>
VB.NET	<pre>E42_TC_ReadRaws(ByVal hConnection As Integer, ByVal bytSlot As Byte, ByVal bytStartChannel As Byte, ByVal bytCount As Byte, ByVal iValue() As UInt16) As Integer</pre>
Arguments	<p>hConnection: The handle for an I/O device connection.</p> <p>bytSlot: Slot number of the I/O module. The Slot number ranges from 1 to 16. But this parameter is inactive on the ioLogik 2000.</p> <p>bytStartchannel: Specifies the starting channel.</p> <p>bytCount: The number of channels to be read.</p> <p>wValue: An array that stores the temperature value to read. The wValue[0] represents start channel 0. When the wValue is 0x8000, it means the sensor is not correctly wired. When the operating mode is temperature sensor, 0.1°C (°F). When the operating mode of the TC module is -78.0 to 78.0 mV, 10uV/count. When the operating mode of the TC module is -32.7 to 32.7 mV, 1uV/count. When the operating mode of the TC module is -65.5 to 65.5 mV, 2uV/count. Use ioAdmin to check the I/O module settings.</p>
Return Value	<p>Succeed MXIO_OK.</p> <p>Fail Refer to Return Codes.</p>

E42_TC_GetEngUnit	This function code is used to get the temperature Type for contiguous channels.
C#	int E42_TC_GetEngUnit(Int32 hConnection,
	byte bytSlot,
	UInt16[] wEngUnit);
VB.NET	E42_TC_GetEngUnit(ByVal hConnection As Integer,
	ByVal bytSlot As Byte,
	ByRef iEngUnit As UInt16)
Arguments	hConnection: The handle for an I/O device connection.
	bytSlot: Slot number of the I/O module. The Slot number ranges from 1 to 16.
	wEngUnit: An array that stores the contiguous A/O channel's safe action to be retrieved. The wEngUnit[0] represents the value of all channels. The values are:
	0: Celsius
	1: Fahrenheit
Return Value	Succeed MXIO_OK.
	Fail Refer to Return Codes.

E42_TC_SetEngUnit	This function code is used to set the temperature Type for contiguous channels.
C#	<pre>int E42_TC_SetEngUnit(Int32 hConnection, byte bytSlot, UInt16 wEngUnit);</pre>
VB.NET	<pre>E42_TC_SetEngUnit(ByVal hConnection As Integer, ByVal bytSlot As Byte, ByVal iEngUnit As UInt16) As Integer</pre>
Arguments	<p>hConnection: The handle for an I/O device connection.</p> <p>bytSlot: Slot number of the I/O module. The Slot number ranges from 1 to 16.</p> <p>wEngUnit: An array that stores the contiguous A/O channel's safe action to be set. The wEngUnit[0] represents the value of allchannel. The values are:</p> <p>0: Celsius</p> <p>1: Fahrenheit</p>
Return Value	<p>Succeed MXIO_OK.</p> <p>Fail Refer to Return Codes.</p>

E42_TC_GetSensorType	This function code is used to get the Sensor Type for contiguous channels.
C#	<pre>int E42_TC_GetSensorType(Int32 hConnection, byte bytSlot, UInt16[] wSensorType);</pre>
VB.NET	<pre>E42_TC_GetSensorType(ByVal hConnection As Integer, ByVal bytSlot As Byte, ByRef iSensorType As UInt16) As Integer</pre>
Arguments	<p>hConnection: The handle for an I/O device connection.</p> <p>bytSlot: Slot number of the I/O module. The Slot number ranges from 1 to 16.</p> <p>wSensorType: An array that stores the contiguous TC channel's sensor type, wSensorType[0] represents the value of all the channels. The values for all channels are:</p> <ul style="list-style-type: none"> 0=TYPE K 1=TYPE J 2=TYPE T 3=TYPE B 4=TYPE R 5=TYPE S 6=TYPE E 7=TYPE N 8=TYPE L 9=TYPE U 10=TYPE C 11=TYPE D 128=10uV Input, -78mV–78mV,10uV/count 129=1uV Input, -32.7mV–32.7mV,1uV/count 130=2uV Input, -65.5mV–65.5mV,2uV/count <p>Others return Illegal Data Value</p>
Return Value	<p>Succeed MXIO_OK.</p> <p>Fail Refer to Return Codes.</p>

E42_TC_SetSensorType	This function code is used to set the Sensor Type for contiguous channels.
C#	int E42_TC_SetSensorType(Int32 hConnection,
	byte bytSlot,
	UInt16 wSensorType);
VB.NET	E42_TC_SetSensorType(ByVal hConnection As Integer,
	ByVal bytSlot As Byte,
	ByVal iSensorType As
	UInt16) As Integer
Arguments	<p>hConnection: The handle for an I/O device connection.</p> <p>bytSlot: Slot number of the I/O module. The Slot number ranges from 1 to 16.</p> <p>wSensorType: An array that stores the contiguous TC channel's sensor type, wSensorType[0] represents the value of all the channels. The values for all channels are:</p> <p>0=TYPE K 1=TYPE J 2=TYPE T 3=TYPE B 4=TYPE R 5=TYPE S 6=TYPE E 7=TYPE N 8=TYPE L 9=TYPE U 10=TYPE C 11=TYPE D 128=10uV Input, -78mV~78mV,10uV/count 129=1uV Input, -32.7mV~32.7mV,1uV/count 130=2uV Input, -65.5mV~65.5mV,2uV/count Others return Illegal Data Value</p> <p>Return Value</p> <p>Succeed MXIO_OK. Fail Refer to Return Codes.</p>

Click&Go Logic Commands

Click&Go logic commands are for ioLogik E2000 and E4200 Ethernet I/O. These commands involve the activation of Click&Go logic on an ioLogik E2000 and E4200 I/O.

Logic2K_GetStartStatus	This function code is used to verify activation of Click&Go logic on an ioLogik E2000 Ethernet I/O.
C#	int Logic2K_GetStartStatus(Int32 hConnection, UInt16[] wStatus);
VB.NET	Logic2K_GetStartStatus(ByVal hConnection As Integer, ByRef istatus As UInt16) As Integer
Arguments	<p>hConnection: The handle for a connection.</p> <p>wStatus: A pointer that stores the specific module's Click&Go Logic start status. The values are :</p> <p>0: Stop</p> <p>1: Start</p>
Return Value	<p>Succeed MXIO_OK.</p> <p>Fail Refer to Return Codes.</p>

Logic2K_SetStartStatus	This function code is used to activate or deactivate Click&Go logic on an ioLogik E2000 Ethernet I/O.
C#	int Logic2K_SetStartStatus(Int32 hConnection, UInt16 wStatus);
VB.NET	Logic2K_SetStartStatus(ByVal hConnection As Integer, ByVal istatus As UInt16) As Integer
Arguments	hConnection: The handle for a connection. wStatus: Stores the specific module's Click&Go Logic start status. The values are: 0: Stop 1: Start
Return Value	Succeed MXIO_OK. Fail Refer to Return Codes.

E42_Logic_GetStartStatus	This function code is used to get the Click&Go Logic start status of the ioLogik 4200 network adaptors.
C#	int E42_Logic_GetStartStatus(Int32 hConnection, UInt16[] wStatus);
VB.NET	E42_Logic_GetStartStatus(ByVal hConnection As Integer, ByRef iStatus As UInt16) As Integer
Arguments	hConnection: The handle for a connection. wStatus: A pointer that stores the specific module's Click&Go Logic start status. The values are: 0: stop 1: start
Return Value	Succeed MXIO_OK. Fail Refer to Return Codes.

E42_Logic_SetStartStatus	This function code is used to set the Click & Go Logic start status of ioLogik 4200 network adaptors.
C#	int E42_Logic_SetStartStatus(Int32 hConnection, UInt16 wStatus);
VB.NET	E42_Logic_SetStartStatus(ByVal hConnection As Integer, ByVal iStatus As UInt16) As Integer
Arguments	hConnection: The handle for a connection. wStatus: A point that stores the specific module's Click & Go Logic start status. The values are: 0: stop 1: start
Return Value	Succeed MXIO_OK. Fail Refer to Return Codes.

W5K_Logic_GetStartStatus	This function code is used to get the Click & Go Logic start status of ioLogik 5000 Ethernet Module.
C#	int W5K_Logic_GetStartStatus (Int32 hConnection, UInt16[] wStatus);
VB.NET	W5K_Logic_GetStartStatus (ByVal hConnection As Integer, ByRef istatus As UInt16) As Integer
Arguments	hConnection: The handle for a connection. iStatus: A pointer that stores the specific module's Click & Go Logic start status. The values are: 0: stop 1: start
Return Value	Succeed MXIO_OK. Fail Refer to Return Codes.

W5K_Logic_SetStartStatus	This function code is used to set the Click & Go Logic start status of ioLogik 5000 Ethernet Module.
C#	int W5K_Logic_SetStartStatus (Int32 hConnection , UInt16 wStatus);
VB.NET	W5K_Logic_SetStartStatus (ByVal hConnection As Integer , ByVal istatus As UInt16) As Integer
Arguments	hConnection: The handle for a connection. iStatus: A pointer that stores the specific module's Click & Go Logic start status. The values are: 0: stop 1: start
Return Value	Succeed MXIO_OK. Fail Refer to Return Codes.

Active I/O Message Commands

Active I/O message commands are for ioLogik Active I/O (E2000, E4200) only. These commands manage active I/O messages that are received from Active Ethernet I/O.

Message2K_Start	This function code is used to start receive active message of ioLogik 2000 Ethernet Module.
C#	<pre>int Message2K_Start(int iProtocol, UInt16 wPort pfnCALLBACK iProcAddress); public delegate void pfnCALLBACK(StringBuilder bytData, UInt16 wSize);</pre>
VB.NET	<pre>Message2K_Start(ByVal nProtocol As UInt32, ByVal iPort As UInt16, ByVal nProcAddress As pfnCALLBACK) As Integer</pre>
Callback Function	<pre>Public Delegate Sub pfnCALLBACK(ByVal bytData As StringBulder, ByVal wSize As UInt16)</pre> <p>NOTE: Message Command is not recommend to use by VB. Please refer the Exmample file for more detail. If you want to use it by VB language, please select P-Code while compiling to execute file.</p>
Arguments	<p>iProtocol: Transmission protocol. 1: TCP 2: UDP</p> <p>wPort: TCP or UDP port number.</p> <p>iProcAddress: Callback function, which is called after receiving an active I/O message from an ioLogik E2000 Ethernet I/O.</p> <p>bytData: An array that stores the message.</p> <p>wSize: Array size.</p>
Return Value	<p>Succeed MXIO_OK.</p> <p>Fail Refer to Return Codes.</p>

Message2K_Stop	This function code is used to stop receiving active I/O messages from an ioLogik E2000 Ethernet I/O.
C#	int Message2K_Stop(int iProtocol);
VB.NET	Message2K_Stop(ByVal nProtocol As UInt32) As Integer
Arguments	iProtocol: Transmission protocol. 1: TCP 2: UDP
Return Value	Succeeds MXIO_OK. Fail Refer to Return Codes.

E42_Message_Start	This function code is used to start receiving active messages for the ioLogik 4200 network adaptors.
C#	<pre>int E42_Message_Start(int iProtocol, UInt16 wPort, pfnCALLBACK iProcAddress);</pre>
Callback Function	<pre>public delegate void pfnCALLBACK(StringBuilder bytData, UInt16 wSize);</pre>
VB.NET	<pre>E42_Message_Start(ByVal nProtocol As UInt32, ByVal iPort As UInt16, ByVal nProcAddress As pfnCALLBACK) As Integer</pre>
Callback Function	<pre>Public Delegate Sub pfnCALLBACK(ByVal bytData As StringBulder, ByVal wSize As UInt16)</pre>
Arguments	<p>NOTE: It is not recommended to use Message Command by VB. Please refer the example file for more details. If you want to use it by VB language, please select P-Code while compiling to execute file.</p> <p>iProtocol: Transmission protocol. 1: TCP 2: UDP</p> <p>wPort: TCP or UDP port number.</p> <p>iProcAddress: Callback function, which is called after receiving an active I/O message from an ioLogik 4200 Ethernet module.</p> <p>bytData: An array that stores the message.</p> <p>wSize: Array size.</p>
Return Value	<p>Succeed MXIO_OK.</p> <p>Fail Refer to Return Codes.</p>

E42_Message_Stop	This function code is used to stop receiving active messages for the ioLogik 4200 network adaptors.
C#	int E42_Message_Stop (int iProtocol);
VB.NET	E42_Message_Stop(ByVal nProtocol As UInt32) As Integer
Arguments	iProtocol: Transmission protocol. 1: TCP 2: UDP
Return Value	Succeed MXIO_OK. Fail Refer to Return Codes.

W5K_Message_Start	This function code is used to start receive active message of ioLogik 5000 Ethernet Module.
C#	<pre> int W5K_Message_Start (int iProtocol, UInt16 wPort, pfncallback iProcAddress); </pre>
Callback Function	<pre> public delegate void pfncallback (StringBuilder bytData, UInt16 wSize); </pre>
VB.NET	<pre> W5K_Message_Start (ByVal nProtocol As UInt32, ByVal iPort As UInt16, ByVal nProcAddress As pfncallback) As Integer </pre>
Callback Function	<pre> Public Delegate Sub pfncallback (ByVal bytData As StringBuilder, ByVal wSize As UInt16) </pre>
Arguments	<p>NOTE: Message Command is not recommend to use by VB. Please refer the Exmaple file for more detail. If you want to use it by VB language, please select P-Code while compiling to execute file.</p> <p>iProtocol: Transmission protocol. 1: TCP 2: UDP</p> <p>wPort: TCP or UDP port number.</p> <p>iProcAddress: Callback function, which is called after receive an active message form ioLogik 5000 Ethernet module.</p> <p>bytData: An array that stores the message.</p> <p>wSize: Array size.</p>
Return Value	<p>Succeed MXIO_OK.</p> <p>Fail Refer to Return Codes.</p>

W5K_Message_Stop	This function code is used to stop receive active message of ioLogik 5000 Ethernet Module.
C#	int W5K_Message_Stop(int iProtocol);
VB.NET	W5K_Message_Stop(ByVal nProtocol As UInt32) As Integer
Arguments	iProtocol: Transmission protocol. 1: TCP 2: UDP
Return Value	Succeed MXIO_OK. Fail Refer to Return Codes.

Return Codes

Return Value	Value	Description
MXIO_OK	0	Function call was successful.
ILLEGAL_FUNCTION	1001	The function code received in the query is not an allowable action for the server (or slave).
ILLEGAL_DATA_ADDRESS	1002	The data address received in the query is not an allowable address for the server (or slave).
ILLEGAL_DATA_VALUE	1003	A value contained in the query data field is not an allowable value for the server (or slave).
SLAVE_DEVICE_FAILURE	1004	An unrecoverable error occurred while the server (or slave) was attempting to perform the requested action.
SLAVE_DEVICE_BUSY	1006	Specialized use in conjunction with programming commands. The server (or slave) is engaged in processing a long-duration program command. The client (or master) should retransmit the message later when the server (or slave) is free.
EIO_TIME_OUT	2001	The following situation may cause an EIO_TIME_OUT : 1. Open socket timeout. 2. Send command to the I/O server timeout. 3. I/O response timeout.
EIO_INIT_SOCKETS_FAIL	2002	An error occurred when the Windows system couldn't complete SOCKET INIT.
EIO_CREATING_SOCKET_ERROR	2003	An error occurred when the Windows system couldn't initiate Socket.
EIO_RESPONSE_BAD	2004	The data received from Ethernet I/O server is incorrect.
EIO_SOCKET_DISCONNECT	2005	The network connection from host computer is down.
PROTOCOL_TYPE_ERROR	2006	Protocol type error.
SIO_OPEN_FAIL	3001	Open COM port failure.

SIO_TIME_OUT	3002	Unable to communicate to the COM port in the designated time.
SIO_CLOSE_FAIL	3003	Unable to close the COM port.
SIO_PURGE_COMM_FAIL	3004	Purge COM port error
SIO_FLUSH_FILE_BUFFERS_FAIL	3005	Flush file buffers error
SIO_GET_COMM_STATE_FAIL	3006	Get COM port status error
SIO_SET_COMM_STATE_FAIL	3007	Set COM port status error
SIO_SETUP_COMM_FAIL	3008	Setup COM port error
SIO_SET_COMM_TIME_OUT_FAIL	3009	Set COM port read timeout and write timeout fail
SIO_CLEAR_COMM_FAIL	3010	Clear COM port
SIO_RESPONSE_BAD	3011	The data received from the serial I/O server is incorrect.
SIO_TRANSMISSION_MODE_ERROR	3012	Modbus transmission parameter error while calling MXSIO_Connect ().
SIO_BAUDRATE_NOT_SUPPORT	3013	Baudrate is not supported.
PRODUCT_NOT_SUPPORT	4001	The I/O module is not supported by this version of MXIO DLL.
HANDLE_ERROR	4002	Handle error.
SLOT_OUT_OF_RANGE	4003	Slot out of range.
CHANNEL_OUT_OF_RANGE	4004	Channel out of range.
COIL_TYPE_ERROR	4005	Coil type error.
REGISTER_TYPE_ERROR	4006	Register type error.
FUNCTION_NOT_SUPPORT	4007	Function is not supported for designated I/O module.
OUTPUT_VALUE_OUT_OF_RANGE	4008	The output value is out of the output range.
INPUT_VALUE_OUT_OF_RANGE	4009	The input value is out of the input range.

Product Model and ID Reference Table

The MXIO.NET Library is designed for use by the ioLogik line of remote I/O, including the ioLogik 4000, E4200, E2000, R2000, W5000, and E1200 series. A list of supported products is provided below. To support new I/O modules, you must upgrade to this version of the MXIO.NET library.

ioLogik 4000

Module ID	Model Name	Network Adapter
0x4010	NA-4010	Ethernet network adapter Modbus/TCP
0x4020	NA-4020	RS-485 network adapter Modbus/RTU
0x4021	NA-4021	RS-232 network adapter Modbus/RTU
0x4200	E4200	Active Ethernet Network Adaptor
		Digital Input
0x1400	M-1400	4 DI, sink, 24 VDC, RTB
0x1401	M-1401	4 DI, source, 24 VDC, RTB
0x1410	M-1410	4 DI, sink, 48 VDC, RTB
0x1411	M-1411	4 DI, source, 48 VDC, RTB
0x1800	M-1800	8 DI, sink, 24 VDC, RTB
0x1801	M-1801	8 DI, source, 24 VDC, RTB
0x1600	M-1600	16 DI, sink, 24 VDC, RTB
0x1601	M-1601	16 DI, source, 24 VDC, RTB
0x1450	M-1450	4 DI, 110 VAC, RTB
0x1451	M-1451	4 DI, 220 VAC, RTB

		Digital Output
0x2400	M-2400	4 DO, sink, MOSFET, 24 VDC, 0.5A, RTB
0x2401	M-2401	4 DO, source, MOSFET, 24 VDC, 0.5A, RTB
0x2800	M-2800	8 DO, sink, MOSFET, 24 VDC, 0.5A, RTB
0x2801	M-2801	8 DO, source, MOSFET, 24 VDC, 0.5A, RTB
0x2600	M-2600	16 DO, sink, MOSFET, 24 VDC, 0.3A, 20 pin
0x2601	M-2601	16 DO, source, MOSFET, 24 VDC, 0.3A, 20 pin
0x2402	M-2402	4 DO, sink, MOSFET, diag., 24 VDC, 0.5A, RTB
0x2403	M-2403	4 DO, source, MOSFET, diag., 24 VDC, 0.5A, RTB
0x2404	M-2404	4 DO, sink, MOSFET, diag., 24 VDC, 2.0A, RTB
0x2405	M-2405	4 DO, source, MOSFET, diag., 24 VDC, 2.0A, RTB
0x2450	M-2450	4 DO, relay 230VAC, 24 VDC, 2.0A, RTB
0x2250	M-2250	2 DO, relay, 230 VAC, 24 VDC, 2.0A, RTB
0x2254	M-2254	2 DO, Triac, 12 to 125 AC, 0.5A, RTB

		Analog Input
0x3400	M-3400	4 AI, current, 0 to 20 mA, 12 bit, RTB
0x3401	M-3401	4 AI, current, 0 to 20 mA, 14 bit, RTB
0x3402	M-3402	4 AI, current, 4 to 20 mA, 12 bit, RTB
0x3403	M-3403	4 AI, current, 4 to 20 mA, 14 bit, RTB
0x3410	M-3410	4 AI, voltage, 0 to 10V, 12 bit, RTB
0x3411	M-3411	4 AI, voltage, 0 to 10V, 14 bit, RTB
0x3412	M-3412	4 AI, voltage, -10 to 10V, 12 bit, RTB
0x3413	M-3413	4 AI, voltage, -10 to 10V, 14 bit, RTB
0x3414	M-3414	4 AI, voltage, 0 to 5V, single-ended, 12 bit, RTB
0x3415	M-3415	4 AI, voltage, 0 to 5V, single-ended, 14 bit, RTB
0x3802	M-3802	8AI, Current, 4-20mA, 12bit, RTB
0x3810	M-3810	8AI, Voltage, 0-10V, 12bit, RTB
0x6200	M-6200	2 AI, RTD: PT100, JPT100 300 Ohm, RTB
0x6201	M-6201	2 AI, thermocouple: 30 mV(1 uV/bit), RTB
		Analog Output
0x4201	M-4201	2 AO, 0 to 20 mA, 12 bit, RTB
0x4202	M-4202	2 AO, 4 to 20 mA, 12 bit, RTB
0x4210	M-4210	2 AO, voltage, 0 to 10V, 12 bit, RTB
0x4211	M-4211	2 AO, voltage, -10 to 10V, 12 bit, RTB
0x4212	M-4212	2 AO, voltage, 0 to 5V, 12 bit, RTB
0x4402	M-4402	4 AO, 4 to 20mA, 12bit, RTB
0x4410	M-4410	4 AO, 0 to 10V, 12bit, RTB

ioLogik E2000 and R2000

Module ID	Model Name	Remote I/O
0x2110	R2210	Remote I/O with 12DI, 8DO
0x2140	R2140	Remote I/O with 8AI, 2AO
0x2210	E2210	Active Ethernet I/O with 12DI, 8DO
0x2212	E2212	Active Ethernet I/O with 8DI, 8DO, 4DIO
0x2214	E2214	Active Ethernet I/O with 6DI, 6Relay
0x2240	E2240	Active Ethernet I/O with 8AI, 2AO
0x2242	E2242	Active Ethernet I/O with 4AI, 12DIO
0x2260	E2260	Active Ethernet I/O with 6RTD, 4DO
0x2262	E2262	Active Ethernet I/O with 8TC, 4DO

ioLogik W5000

Module ID	Model Name	Remote I/O
0x5340	W5340	8DIO, 2RLY, 4AI Active Remote I/O Server

ioLogik E1200

Module ID	Model Name	Remote I/O
0x1210	E1210	16DI Active Remote I/O Server
0x1211	E1211	16DO Active Remote I/O Server
0x1212	E1212	8DI, 8DI/DO Active Remote I/O Server
0x1214	E1214	6DI, 6Relay Outputs Active Remote I/O Server
0x1240	E1240	8AI Active Remote I/O Server