

ioLogik W5300 Series User's Manual

Edition 10.0, February 2017

www.moxa.com/product

MOXA®

© 2017 Moxa Inc. All rights reserved.

ioLogik W5300 Series User's Manual

The software described in this manual is furnished under a license agreement and may be used only in accordance with the terms of that agreement.

Copyright Notice

© 2017 Moxa Inc., All rights reserved.

Trademarks

The MOXA logo is a registered trademark of Moxa Inc.
All other trademarks or registered marks in this manual belong to their respective manufacturers.

Disclaimer

Information in this document is subject to change without notice and does not represent a commitment on the part of Moxa.

Moxa provides this document as is, without warranty of any kind, either expressed or implied, including, but not limited to, its particular purpose. Moxa reserves the right to make improvements and/or changes to this manual, or to the products and/or the programs described in this manual, at any time.

Information provided in this manual is intended to be accurate and reliable. However, Moxa assumes no responsibility for its use, or for any infringements on the rights of third parties that may result from its use.

This product might include unintentional technical or typographical errors. Changes are periodically made to the information herein to correct such errors, and these changes are incorporated into new editions of the publication.

Technical Support Contact Information

www.moxa.com/support

Moxa Americas

Toll-free: 1-888-669-2872
Tel: +1-714-528-6777
Fax: +1-714-528-6778

Moxa Europe

Tel: +49-89-3 70 03 99-0
Fax: +49-89-3 70 03 99-99

Moxa India

Tel: +91-80-4172-9088
Fax: +91-80-4132-1045

Moxa China (Shanghai office)

Toll-free: 800-820-5036
Tel: +86-21-5258-9955
Fax: +86-21-5258-5505

Moxa Asia-Pacific

Tel: +886-2-8919-1230
Fax: +886-2-8919-1231

Table of Contents

1. Introduction	1-1
Architecture	1-2
Using Active OPC Server to Resolve Dynamic IP Addresses	1-2
Resolving Dynamic/Private IP Issues with DDNS	1-3
Overview	1-4
Product Features	1-4
Appearance	1-4
Package Checklist	1-6
Product Selection Guide	1-6
Product Specifications	1-6
Common Specifications	1-6
ioLogik W5312/W5312-T Specifications	1-8
ioLogik W5340/W5340-T/W5340-HSPA/W5340-HSPA-T	1-8
2. Getting Started	2-1
Before Testing	2-2
Installing the ioAdmin Utility	2-2
Laboratory Testing	2-3
Grounding the Unit	2-3
Connecting to a Power Source	2-3
Connecting to ioAdmin via Ethernet	2-3
Configuring the Computer's IP Address	2-3
Activating ioAdmin and connecting to the ioLogik	2-4
Configuring Digital I/O Channels	2-7
Connecting I/O Devices	2-7
Testing I/O Devices	2-9
DIN Rail / Wall Mounting	2-10
Installing/Removing SIM and SD Cards	2-10
Connecting the ioLogik W5300 to a Cellular Network	2-11
Installing AOPC on a Host with a Static IP Address	2-12
Import/Export a Configuration File	2-14
Using ioAdmin to Import/Export a Device Configuration	2-14
3. The ioAdmin Utility	3-1
System Requirements	3-2
Key Features	3-2
Using the ioAdmin Utility	3-3
The ioAdmin Utility Window	3-3
ioAdmin Menu Bar	3-3
The Wiring Guide	3-7
ioAdmin Quick-Link Buttons	3-8
ioAdmin Navigation Panel	3-9
Main Window	3-10
Synchronization Rate Status Bar	3-12
ioAdmin Status Bar	3-12
ioAdmin Configuration Panels	3-13
The Server Settings Panel	3-13
The LAN Settings Panel	3-14
The I/O Configuration Panel	3-15
Configuring AI Channels	3-15
Configuring Digital I/O Channels	3-19
Configuring Digital Input Channels	3-19
Configuring Digital Output / Relay Output Channels	3-21
Testing DI and DO Channels	3-23
The I/O Expansion Panel	3-24
I/O Expansion: Step-by-Step	3-26
The Active Tags Panel	3-28
Active OPC: Redundancy Mode	3-29
The Cellular Settings Panel	3-32
Dial-up Setting	3-32
Caller IDs	3-33
Operation Mode	3-33
DDNS Settings	3-34
VPN Settings Panel (ioLogik W5340-HSPA(-T) only)	3-36
VPN System Log Events and Error Codes	3-39
Cellular Reconnection	3-40
Meter/Sensor	3-41
Network Statistics	3-42
Watchdog Panel	3-43
Click&Go Logic Panel	3-44

4. Click&Go Logic	4-1
To Get a Quick Start	4-2
Overview	4-2
Features	4-3
Click&Go Logic Basics	4-3
Working with the Rules	4-4
Click&Go Development Process	4-4
I/O Configuration	4-5
Configurable DIO Channel Mode Selection	4-5
Digital Input Mode Selection	4-5
Digital Output Mode Selection	4-6
Analog Input Mode Selection	4-7
Alias Configuration	4-7
Testing the I/O Channels	4-8
Defining Global Variables	4-9
Internal Register (Integer) Settings	4-9
Timer Settings	4-9
SNMP Trap Server	4-10
E-Mail Server	4-10
Active Message Server	4-12
SMS Phone Book	4-12
Working/Off Working Days	4-13
FTP Settings	4-13
Data Logging Profile List	4-14
Internal Register (Float) Settings	4-16
Working with Logic	4-16
Click&Go Logic Basics	4-16
IF...THEN/ELSE Conditionals	4-18
THEN/ELSE Actions	4-26
Activating the Rule-set	4-36
Upload, Restart, and Run	4-36
Rule-set Management Bar	4-37
Import/Export Configuration	4-37
5. Planning and Assistance	5-1
Known Issues of Cellular Monitoring Systems	5-2
Active OPC Server with a Static IP Address	5-3
Cellular Remote I/O Architecture	5-4
Using ioAdmin to Perform Simple Data Monitoring from a Remote Site	5-4
Expanding Input/Output Channels	5-6
Using Modbus/TCP Protocol with Your Program	5-9
Using the Counter to Get Meter Readings and Statistics	5-12
Record your I/O Data in the Data Log File	5-13
Connecting a Modbus/RTU Serial Device Attached to the ioLogik over a Cellular Network	5-19
Connecting to a SCADA System	5-19
Updating Serial Tags to SCADA System with Active OPC Server over a Cellular Network	5-21
Handling Front-End Events and Alarms	5-23
SMS Escalation and Acknowledgement	5-24
SMS Commands for Monitoring and Control	5-26
Enabling the Power Saving Function and Secure Wake on Call	5-27
Enabling Ethernet and Cellular Redundancy	5-28
A. Pin-outs and Cable Wiring	A-1
Pinouts	A-2
CN1: SMA, Cellular Antenna Connector	A-2
CN2: DB9, Male, RS-232 Connector	A-2
CN3: RJ-45, Ethernet Connector	A-2
TB1: Power Input Terminal Block	A-3
TB2: I/O Terminal Block (W5340)	A-3
TB3: 5-pin, 4-wire/2-wire RS-422/485 Terminal Block	A-3
TB2: I/O Terminal Block (W5312)	A-4
Cable Wiring	A-4
Digital Input Dry Contact	A-4
Digital Input Wet Contact	A-4
Digital Output Sink Mode	A-5
Relay Output	A-5
Analog Input	A-5
B. SMS Commands	B-1
SMS Command Syntax	B-2
SMS Command Table	B-2
C. Modbus/TCP Address Mapping	C-1
ioLogik W5340 and ioLogik W5340-HSPA Modbus Mapping	C-2

0xxxx Read/Write Coils (support functions 1, 5, 15)	C-2
1xxxx Read only Coils (supports function 2)	C-6
3xxxx Read-only Registers (supports function 4)	C-7
4xxxx Read/Write Registers (supports functions 3, 6, 16)	C-8
5xxxx Write Registers (supports function 8)	C-18
ioLogik W5312 Modbus Mapping	C-19
0xxxx Read/Write Coils (supports functions 1, 5, 15)	C-19
1xxxx Read only Coils (supports function 2)	C-24
3xxxx Read only Registers (supports function 4)	C-24
4xxxx Read/Write Registers (supports functions 3, 6, 16)	C-26
5xxxx Write Registers (supports function 8)	C-39
D. SNMP Agents with MIB II, RS-232-like Groups	D-1
E. Factory Default Settings	E-1
F. Troubleshooting the Cellular I/O Connection	F-1
G. FAQ	G-1

Introduction

Moxa's ioLogik W5300 series of programmable remote I/O solutions are stand-alone devices with full cellular communications designed for remote monitoring applications. Using Moxa's patented Active OPC Server with push communications technology, ioLogik W5300 economically solve the problem with identification and addressing that remote, private networks carried over cellular communications typically have with dynamic IP addresses.

NOTE Throughout this user's manual, we use ioLogik W5300 to refer to one of any of the product models in the ioLogik W5300 series.

The following topics are covered in this chapter:

- ❑ **Architecture**
 - Using Active OPC Server to Resolve Dynamic IP Addresses
 - Resolving Dynamic/Private IP Issues with DDNS
- ❑ **Overview**
- ❑ **Product Features**
- ❑ **Appearance**
- ❑ **Package Checklist**
- ❑ **Product Selection Guide**
- ❑ **Product Specifications**
 - Common Specifications
 - ioLogik W5312/W5312-T Specifications
 - ioLogik W5340/W5340-T/W5340-HSPA/W5340-HSPA-T

Architecture

Cellular networks usually run in a dynamic IP environment with private IP addresses assigned by the cellular service provider. To allow private networks to get around the connectivity issues raised by edge devices configured with dynamically assigned private IP addresses, typically operators purchase high-cost static IP addresses for each device, with IPs provided by a DDNS or VPN service purchased from an MVNO (Mobile Virtual Network Operator). Even with DDNS technology, SCADA systems need to assign resources to manage the DDNS servers. As an alternative, Moxa's Cellular remote I/O devices use Moxa's proprietary "push" technology, called Active OPC Server. With Moxa's powerful Active OPC Server support, communications efficiency between ioLogik W5300 devices and the central SCADA are substantially improved. Moxa's Active OPC Server's non-polling communications architecture supports the standard OPC protocol, but instead of requiring the SCADA to poll edge devices it allows edge devices to actively push communications to the central HMI/SCADA system, empowering the network with real time I/O updates while substantially cutting network overhead.

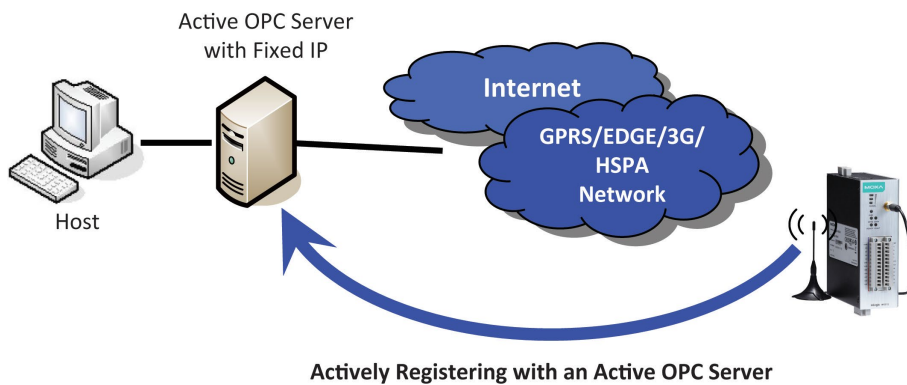

Unlike the requirements of a traditional OPC server (where remote I/O devices must use a static IP so they may be successfully polled), Active OPC Server and ioLogik products allow engineers the flexibility of configuring edge devices with dynamic IP addresses. Even when using DHCP addressing, ioLogik devices can push messages back to the OPC server, allowing wide area I/O networks using dynamic IP cellular accounts. Using traditional polling OPC applications, I/O devices cannot make use of this approach.

Using Active OPC Server to Resolve Dynamic IP Addresses

With its push communications capabilities, Active OPC Server can be configured to become a cellular gateway that enables direct communications from the edge back to the core. By configuring the Active OPC Server with a static address, remote I/O devices may push their IP addresses back to the OPC server and thus register with the SCADA over a cellular network. In this way, edge devices can communicate their new IP address directly, easily sidestepping dynamic IP addressing issues. The topology is illustrated below:

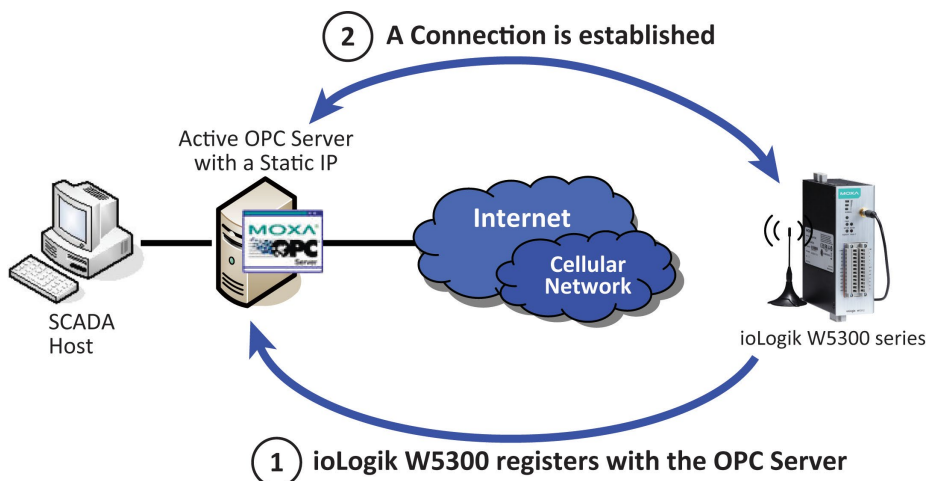

Each time it reassociates with a cellular network, an edge device will most likely receive a new IP address from the carrier. Each time it reassociates, regardless of whether the ioLogik device uses a public IP or private IP, it will automatically register with the Active OPC Server (which has a static IP address). After registering, the entire network can be managed by one centralized AOPC server. Thereafter, all I/O data can be read or written via one powerful cellular device gateway.

The ioLogik W5300 allows you to use a variety of methods to connect with your application software, including Modbus, OPC client/server, and SNMP. You can also configure AOPC server to send alarms by TCP/UDP, SMS, and email. For example, if you are using a SCADA application to monitor your system, you can use the OPC client/server architecture.

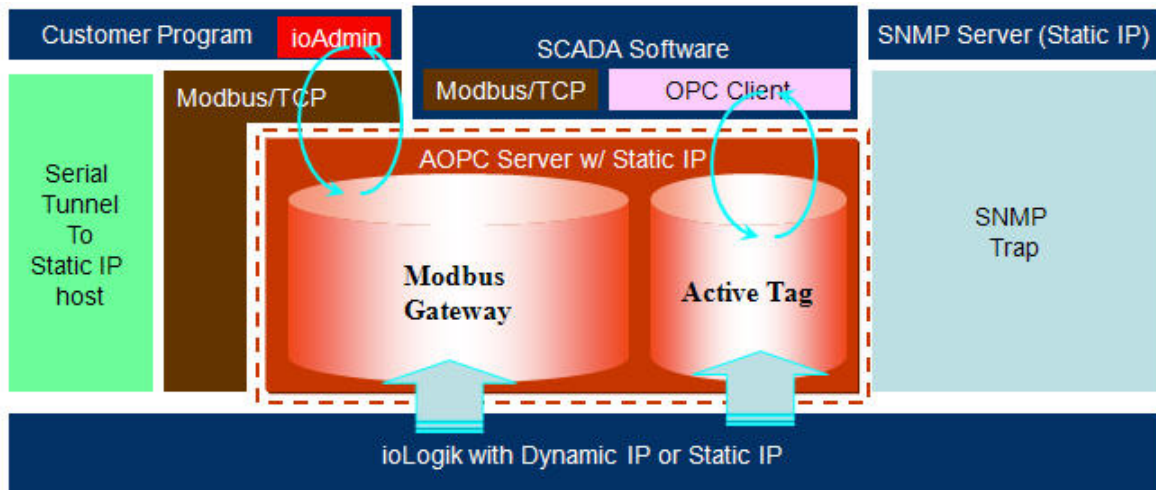

Active OPC Server and ioLogik W5300 series products also automatically generate tags, to eliminate the headache of specifying individual IP addresses, I/O channels, and data formats one by one, or of editing and importing configuration text files. Instead, Active OPC Server automatically creates the tags for a target ioLogik. All you need to do is select the channels to be updated from the Active OPC Server. Generally speaking, tag generation is 50 times faster on Active OPC Server compared to a traditional OPC server, making extra training for installation and configuration of the OPC no longer a requirement.

The traditional polling architecture occupies more network bandwidth, which results in longer response times. In comparison, cellular-enabled ioLogik units use **push communications**, and can report active messages when predefined events occur. This event-driven logic successfully speeds up I/O response times, allows for more precise I/O access, and relieves network bandwidth and CPU loading burdens.

Resolving Dynamic/Private IP Issues with DDNS

In addition to using Active OPC Server to register an ioLogik W5300 with SCADA over a dynamic IP cellular connection, you may also use DDNS to configure the device with a unique URL. The ioLogik W5300 can be configured to register a DNS hostname (i.e. – URL) with DDNS, and thereby convert a dynamic IP to a publicized address. In this way, centralized control software will be able to connect to the remote ioLogik W5300 without requiring a fixed IP or VPN service from a network provider.

NOTE Device features are dependent on the firmware version. Be sure to use firmware version V1.3 or above for the ioLogik W5312 series, and V1.5 or above for the ioLogik W5340 series.

Overview

The ioLogik W5300 combines a **cellular modem, a data logger, and a remote I/O device** into one compact box, dramatically reducing the amount of effort required to integrate devices from multiple vendors. The cellular interface supports tri-band HSPA/UMTS and quad-band GSM/GPRS/EDGE frequencies, offering a full spectrum of 3G mobile communication services. The cellular remote I/O unit provides I/O and serial data logging onto an SD card that can support up to 32 GB of storage space. Multiple options are available to remotely retrieve data logs, such as FTP, e-mail, and Moxa's DA-Center™. In addition, this cellular remote I/O unit is a programmable device that supports Click&Go™ control logic for constructing customized control systems. The ioLogik W5300 is a rugged device with tolerance for a wide range of temperatures, well suited for hard-to-wire remote monitoring and alarm applications such as at unmanned sites like riversides and pipelines.

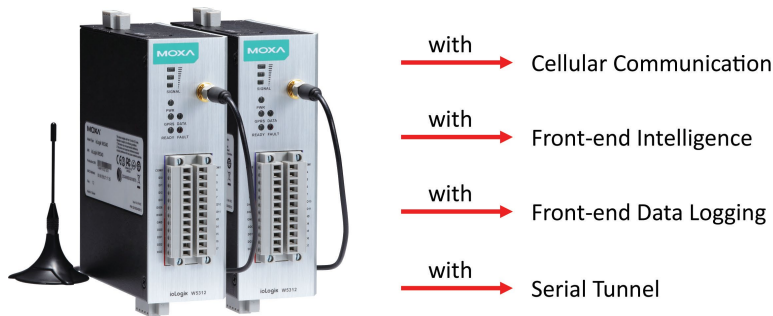

Product Features

- Trouble-free connections to cellular networks
- Automatic data update from SD cards following network failure
- Front-end intelligence for event handling
- Intelligent SMS alarms and SMS commands
- Friendly serial device connectivity
- Network redundancy
- WAN-to-LAN extension with port forwarding
- Secure wake on call
- I/O expansion capability

Appearance

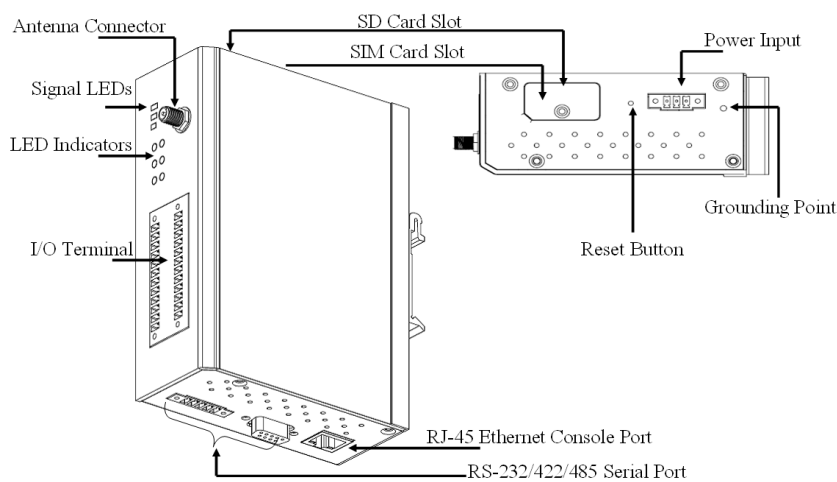

NOTE The reset button restarts the server and resets all settings to factory defaults. Use a pointed object such as a straightened paper clip to hold the reset button down for 5 sec. The RDY LED will turn red as you are holding the reset button down. The factory defaults will be loaded once the RDY LED turns green again. You can then release the reset button.

LED Indicators

Function	Description	Mark
Power Input	OFF: No Power	PWR
	Green: Power On	
Connection Status	OFF: Disconnected or in "On Demand" Mode	GPRS or LINK
	Amber: Connected and "Always ON"	
	Blinking: Connected with Active OPC Server	
System Status	Green: System Ready	READY
	Ready LED is blinking and Fault LED is not lit: Click&Go is running	
	Ready LED is blinking and Fault LED is blinking: Safe Mode	
Communication Activity (ioLogik W5312, ioLogik W5340 only)	OFF: No communication	DATA
	Green: Cellular modular sending/receiving serial TX/RX command signal	
System Fault Status	RED: I/O out of work	FAULT
	OFF: Function Normal	
	Blinking: Safe Mode	
Signal Status	OFF: No signal, or No SIM Card	SIGNAL
	1 Green LED: Weak or insufficient (SMS only)	
	2 Green LEDs: Average (good for cellular connections)	
	3 Green LEDs: Excellent Signal	

Physical Dimensions (unit = mm)

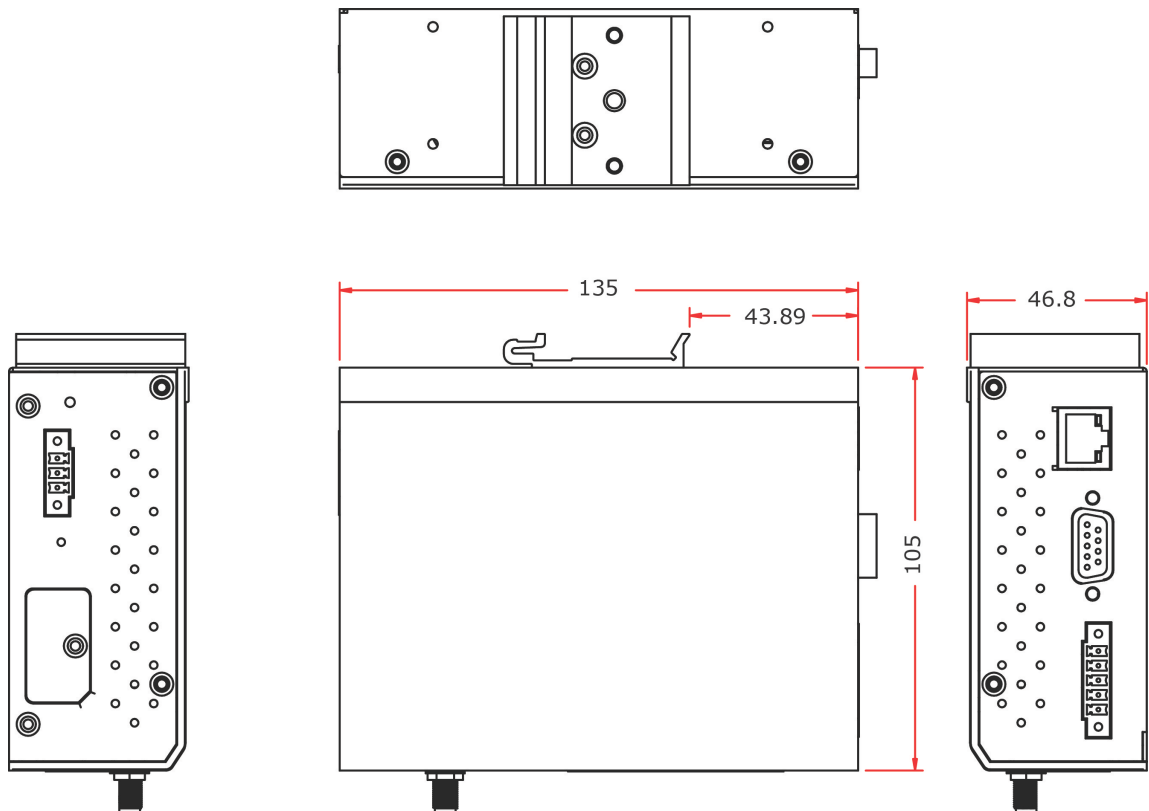

Package Checklist

The ioLogik W5300 is shipped with the following items:

Standard Accessories

- ioLogik W5300
- 3-pin screw terminal block x 1 (for power input)
- 12-pin screw terminal blocks x 2 (for I/O)
- 5-pin screw terminal block x 1 (for RS-485)
- Antenna

NOTE: Notify your sales representative if any of the above items are missing or damaged.

Product Selection Guide

The cellular-enabled ioLogik W5300 series of remote I/O units includes the ioLogik W5312, ioLogik W5340, and ioLogik W5340-HSPA. Their respective features are broken down in the following table:

Model	Operating Temp.	I/O Combination					Serial Ports	Ethernet Ports	Data Logger	OPC Server
		AI	DI	DO	DIO	Relay				
W5300 Series	Common Specification									
W5312	-10 to 55°C	0	8	8	4	0	1, RS-232/ 422/485	1, RJ45	Yes, with an additional SD card	Yes
W5340	-10 to 55°C	4	0	0	8	2				
W5340-HSPA	-10 to 55°C	4	0	0	8	2				
W5312-T	-30 to 70°C	0	8	8	4	0				
W5340-T	-30 to 70°C	4	0	0	8	2				
W5340-HSPA-T	-20 to 70°C	4	0	0	8	2				

Note: Click on a model name to see specifications relevant to that particular model.

Product Specifications

Common Specifications

Computer

CPU: ARM9 based CPU, 32-bit/160 MHz

SDRAM/Flash:

- ioLogik W5312: 4 MB
- ioLogik W5340: 2 MB

Storage

Expansion Slot: Up to 32 GB SD™ memory card (SD 2.0 compatible)

Note: For units operating in extreme temperatures, industrial grade, wide-temperature SD cards are required.

Cellular

Network:

ioLogik W5312/W5340: Quad-band GSM/GPRS/EDGE 850/900/1800/1900 MHz

ioLogik W5340-HSPA: Five band UMTS/HSPA+ 800/850/AWS/1900/2100 MHz

Internet:

HSPA+:

- Up to 5.76 Mbps upload speed.
- Up to 14.4 Mbps download speed.

UMTS:

- Up to 384k bps upload/download speed.

GPRS/EDGE:

- Multi-slot class: Class 12
- Coding schemes: CS1 to CS4
- Terminal device class: Class B

SMS: Point-to-Point Text/PDU mode**SIM Control Voltage:** 3 V / 1.8 V**LAN****Ethernet:** 1 x 10/100 Mbps, RJ45**Protection:** 1.5 kV magnetic isolation**Protocols:** Modbus/TCP, TCP/IP, UDP, DHCP, Bootp, SNMP, SNTP**Serial Communication****Interface:** 1 x RS-232/422/485, software selectable

(9-pin D-Sub male, or 5-contact terminal block)

Baudrate: 300, 1200, 2400, 4800, 9600, 19200, 38400, 57600, 115200 bps**Power Requirements****Power Input:** 24 VDC nominal, 12 to 36 VDC**Physical Characteristics****Dimensions:** 46.8 x 135 x 105 mm (1.84 x 5.31 x 4.13 in)**Weight:** 495 g**Mounting:** DIN-rail (standard), wall (optional)**Environmental Limits****Operating Temperature:**

Standard Models: -10 to 55°C (14 to 131°F)

Wide Temp. Models: -30 to 70°C (-22 to 158°F)

Storage Temperature: -40 to 85°C (-40 to 185°F)**Ambient Relative Humidity:** 5 to 95% (non-condensing)**Altitude:** Up to 2000 m

Note: Please contact Moxa if you require products guaranteed to function properly at higher altitudes.

Standards and Certifications**Safety:** UL 508, EN 60950-1, NCC**EMI:** EN 55032; EN 61000-3-2; EN 61000-3-3;

FCC Part 15, Subpart B, Class A

EMS: EN 55024, EN 61000-4-2, EN 61000-4-3,

EN 61000-4-4, EN 61000-4-5, EN 61000-4-6,

EN 61000-4-8, EN 61000-4-11, EN 61000-6-2

Shock: IEC 60068-2-27**Freefall:** IEC 60068-2-32**Vibration:** IEC 60068-2-6**Green Product:** RoHS, CRoHS, WEEE

Note: Please check Moxa's website for the most up-to-date certification status.

Warranty**Warranty Period:**

- ioLogik W5312: 5 years
- ioLogik W5340/W5340-HSPA: 2 years*

*Because of the limited lifetime of power relays, products that use that component are covered by a 2-year warranty.

Details: See www.moxa.com/warranty

ioLogik W5312/W5312-T Specifications

Inputs and Outputs

Digital Inputs: 8 channels

Digital Outputs: 8 channels

Configurable DIOs: 4 channels

Isolation: 3K VDC or 2K Vrms

Digital Input

Sensor Type: Wet Contact (NPN or PNP) and Dry Contact

I/O Mode: DI or Event Counter

Dry Contact:

- On: short to GND
- Off: open

Wet Contact (DI to GND):

- On: 0 to 3 VDC
- Off: 10 to 30 VDC

Common Type: 6 points per COM

Counter Frequency: 900 Hz, power off storage

Digital Filtering Time Interval: Software selectable

Digital Output

Type: Sink

I/O Mode: DO or Pulse Output

Pulse Output Frequency: 1 kHz

Over-voltage Protection: 45 VDC

Over-current Protection: 2.6 A (4 channels @ 650 mA)

Over-temperature Shutdown: 160°C (min.)

Current Rating: 200 mA per channel

DIO Output Leakage Current: 3.6 mA @ 24 VDC

Power Requirements

Power Consumption:

- Always on: 156 mA @ 24 VDC
- On demand: 138 mA @ 24 VDC

MTBF (mean time between failure)

Time: 407,406 hrs

Database: Telcordia (Bellcore)

ioLogik W5340/W5340-T/W5340-HSPA/W5340-HSPA-T

Inputs and Outputs

Analog Inputs: 4 channels

Configurable DIOs: 8 channels

Relay Outputs: 2 channels

Isolation: 3K VDC or 2K Vrms

Analog Input

Type: Differential input

Resolution: 16 bits

I/O Mode: Voltage / Current

Input Range: 0 to 10 V, ± 10 V, ± 5 V, 0 to 20 mA, 4 to 20 mA

Accuracy:

- $\pm 0.1\%$ FSR @ 25°C
- $\pm 0.3\%$ FSR @ -30 and 70°C

Sampling Rate: • All channels: 25 samples/sec

- Per channel: 6.25 samples/sec
- Only one channel enabled: 100 samples/sec

Input Impedance: 200K ohms (min.)

Built-in Resistor for Current Input: 102 ohms

Digital Input

Sensor Type: Wet Contact (NPN or PNP) and Dry Contact

I/O Mode: DI or Event Counter

Dry Contact:

- On: short to GND
- Off: open

Wet Contact (DI to GND):

- On: 0 to 3 VDC
- Off: 10 to 30 VDC

Common Type: 4 points per COM

Counter Frequency: 900 Hz, power off storage

Digital Filtering Time Interval: Software selectable/Programmable

Digital Output

Type: Sink

I/O Mode: DO or Pulse Output

Pulse Output Frequency: 1 kHz

Over-voltage Protection: 45 VDC

Over-current Protection: 2.6 A (4 channels @ 650 mA)

Over-temperature Shutdown: 160°C (min.)

Current Rating: 200 mA per channel

DIO Output Leakage Current: 3.6 mA @ 24 VDC

Relay Output

Type: Form A (N.O.) power relay

Contact Current Rating:

- Resistive Load: 1 A @ 30 VDC, 250 VAC, 110 VAC

Initial Insulation Resistance: 1000 m ohms (min.) @ 500 VDC

Mechanical endurance: 5,000,000 operations

Electrical endurance: 600,000 operations @ 1 A resistive load

Contact Resistance: 100 m ohms (max.)

Pulse Output: 0.3 Hz at rated load

Power Requirements

Power Consumption:

ioLogik W5340:

- Always on: 195 mA @ 24 VDC
- On demand: 178 mA @ 24 VDC

ioLogik W5340-HSPA:

- Always on: 196 mA @ 24 VDC
- On demand: 189 mA @ 24 VDC

MTBF (mean time between failure)

Time:

ioLogik W5340: 196,561 hrs

ioLogik W5340-HSPA: 280,739 hrs

Database: Telcordia (Bellcore)

This chapter describes how to install the ioLogik W5300.

The following topics are covered in this chapter:

- ❑ **Before Testing**
- ❑ **Installing the ioAdmin Utility**
- ❑ **Laboratory Testing**
 - Grounding the Unit
 - Connecting to a Power Source
- ❑ **Connecting to ioAdmin via Ethernet**
 - Configuring the Computer's IP Address
 - Activating ioAdmin and connecting to the ioLogik
- ❑ **Configuring Digital I/O Channels**
 - Connecting I/O Devices
 - Testing I/O Devices
 - DIN Rail / Wall Mounting
 - Installing/Removing SIM and SD Cards
 - Connecting the ioLogik W5300 to a Cellular Network
 - Installing AOPC on a Host with a Static IP Address
- ❑ **Import/Export a Configuration File**
 - Using ioAdmin to Import/Export a Device Configuration

Before Testing

Prepare the following items before testing the ioLogik W5300.

1. Set up the Active OPC server environment, including network settings.
2. Install ioAdmin on the same PC serving Active OPC.

Installing the ioAdmin Utility

ioAdmin is a Windows utility provided for the configuration and management of the ioLogik W5300. ioAdmin can be used from anywhere on the network to monitor and configure the ioLogik W5300.

ioAdmin can be downloaded from Moxa's website.

1. Installing ioAdmin from website:

- a. First click on the following link to access the website's search utility:
<http://www.moxa.com/support/search.aspx?type=soft>
- b. When the web page opens, enter the model name of your product in the search box.
- c. Click the model name and navigate to the product page, and then click on Utilities, located in the box titled Software.
- d. Download and then unzip the file. Run **SETUP.EXE** from that location.
The installation program will guide you through the installation process and install the software.

2. **Open ioAdmin:** After installation is finished, run ioAdmin from the Windows Start menu: **Start → Program Files → MOXA → IO Server → Utility → ioAdmin.**

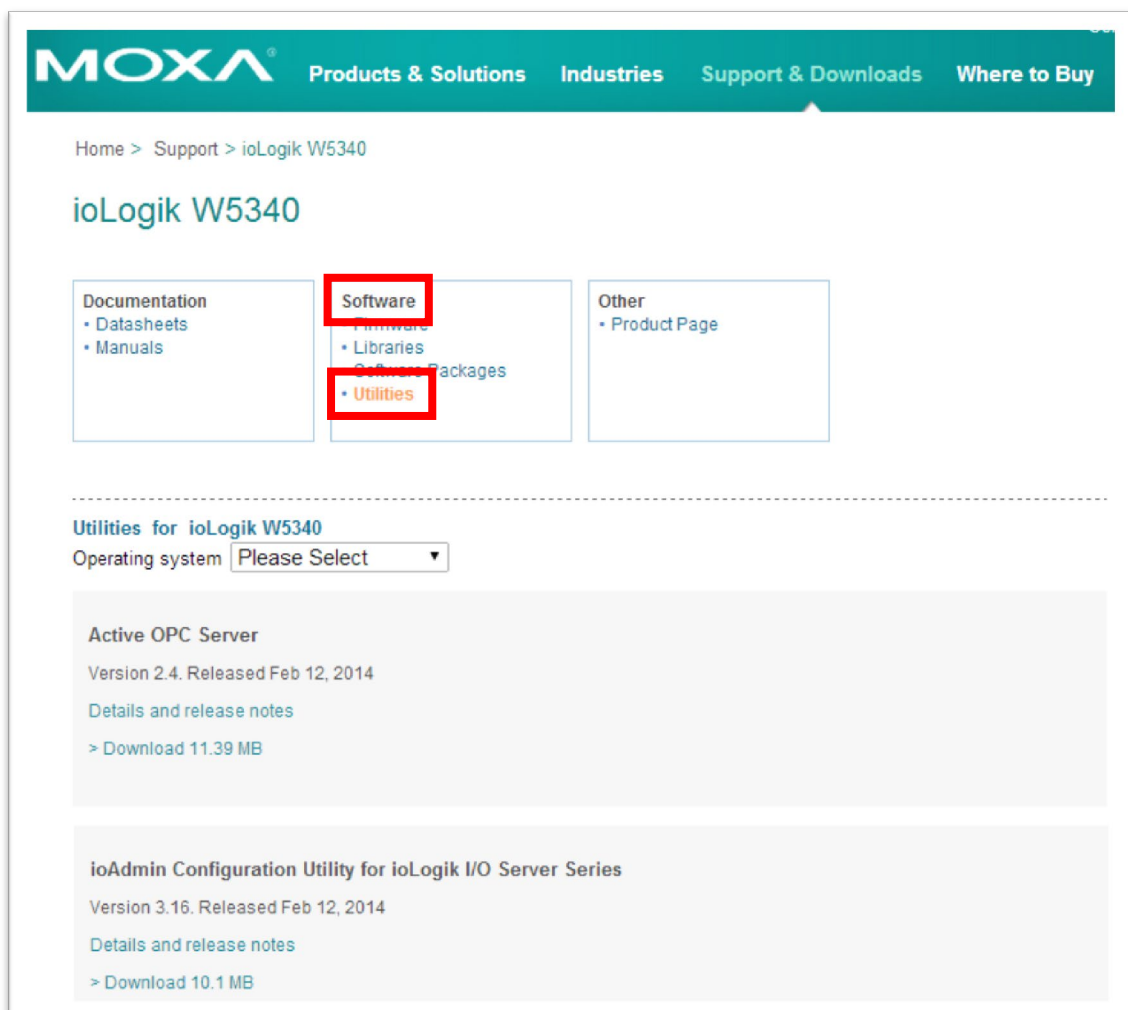

Laboratory Testing

Grounding the Unit

The ioLogik is equipped with one grounding point located on the top of the device next to the Power Input Terminal Block. To provide better stability for both power and signal transmission, we recommend wiring the grounding point to a suitable grounded contact, such as the power supply or a cabinet enclosure.

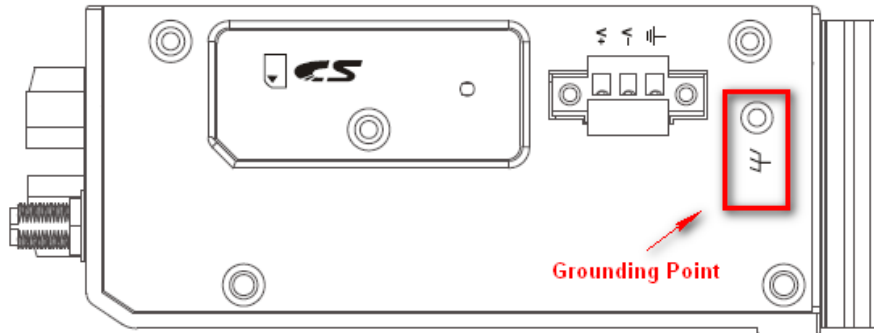



WARNING



This equipment is intended to be used in Restricted Access Locations. External metal parts are hot! Before touching it, special attention or protection is necessary.

Connecting to a Power Source

Connect the 12 to 36 VDC power line to the ioLogik’s Power Input Terminal Block. If power is properly supplied, the PWR LED will glow a steady GREEN color; the READY LED will glow a steady GREEN when the system is ready.



ATTENTION

Determine the maximum possible current for each power wire and common wire. Observe all electrical codes dictating the maximum current allowable for each wire size. If the current exceeds the maximum rating, the wiring could overheat, causing serious damage to your equipment. For safety reasons, we recommend an average cable size of 22 AWG. However, depending on the current load, you may want to adjust your cable size (the maximum wire size for power connectors is 2 mm).

Connecting to ioAdmin via Ethernet

Configuring the Computer’s IP Address

1. **For initial configuration, we recommend using a direct connection through the RJ45 Ethernet console port to a host computer**, rather than remotely over the cellular network. Connect the ioLogik to the host PC with an Ethernet cable.
2. **Set the host PC’s IP address to 192.168.127.XXX.** (where XXX can range from 001 to 253). In Windows, you can adjust this setting through the **Control Panel**→**Network and Internet**. The default ioLogik device settings are:

Default IP Address	Default Netmask	Default Gateway
192.168.127.254	255.255.255.0	None

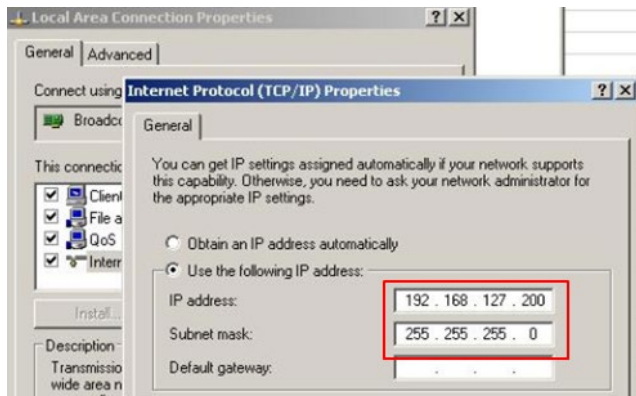

Example IP: 192.168.127.200

Activating ioAdmin and connecting to the ioLogik

1. To open ioAdmin, click the **Start** menu, then **Program Files**→ **MOXA**→ **IO Server**→ **Utility**→ **ioAdmin**.
2. When ioAdmin is started, it will automatically run the a search program to find all ioLogik devices on the network to which you are connected. You may also click **System** on the menu bar, then select **Auto Scan ioLogik device**. A dialog will appear. Click **Start Search**. Once the ioLogik has been detected, modify the settings as needed for your network environment, and then restart the device.

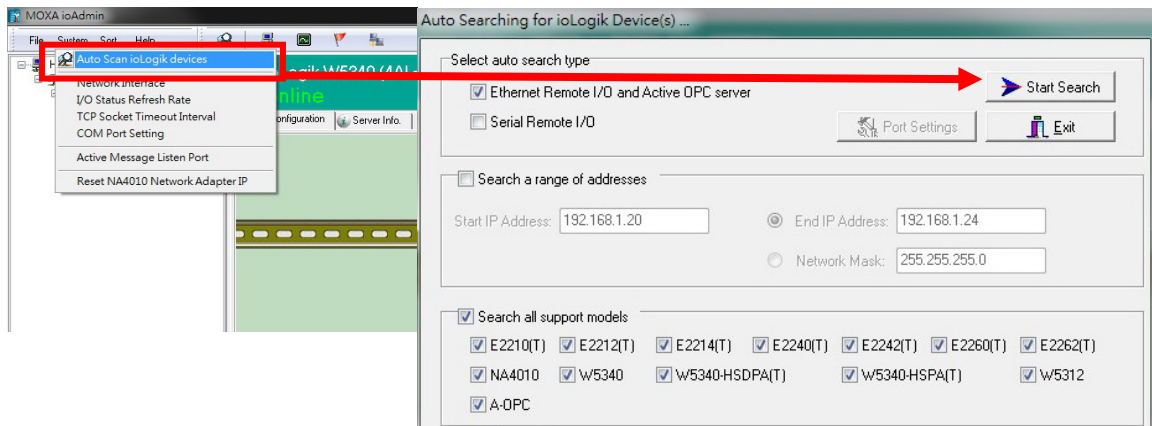

NOTE The best approach to setting up a previously configured ioLogik is to first reset it to the factory default using the reset button (see Chapter 1 for details). You can then use ioAdmin to configure the ioLogik.

3. If the host computer has multiple interfaces, be sure to select the correct one before searching.

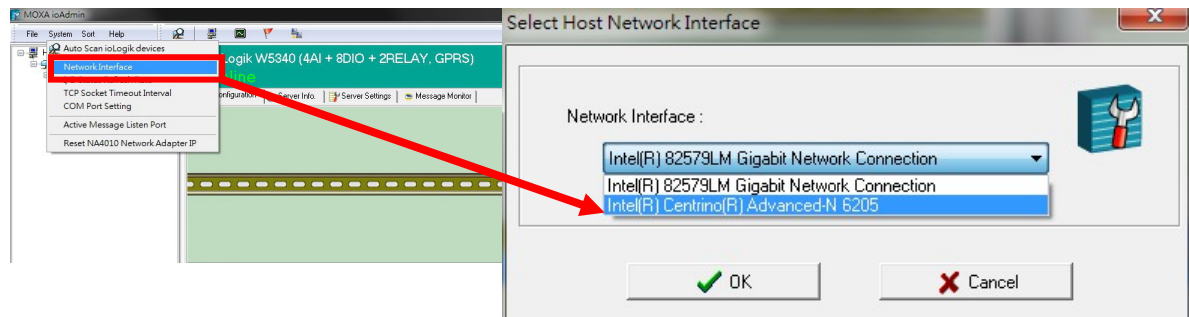

NOTE If multiple ioLogik W5300 units with the same default IP address are installed on the same network, to avoid IP conflicts you will need to first assign a different IP address to each unit. ioAdmin automatically detects IP conflicts and gives you a chance to modify each unit's IP address in the **IP Address** column. Click the **Set** button to reboot the corresponding unit with its new IP address. Click the **Re-Search** button to check if the setting has been successful by refreshing the list of units found by ioAdmin.

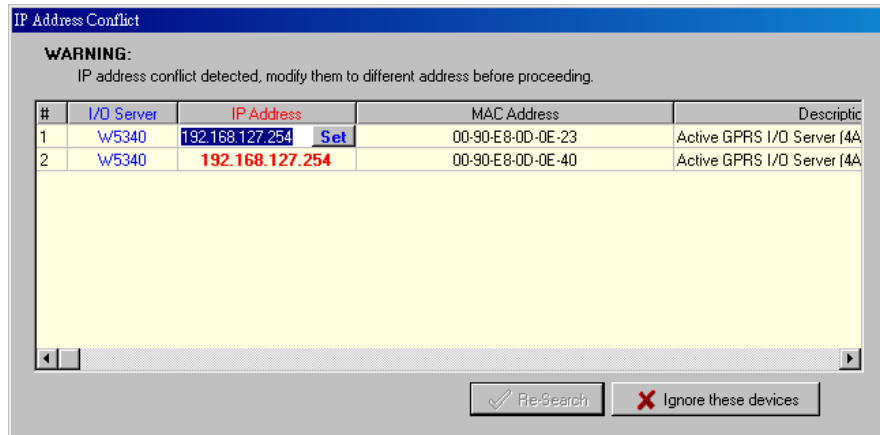

- 4. **Login as administrator:** For full access to all configuration options, log in as administrator from the Server Settings panel. This is required whenever you start ioAdmin, or boot up or restart the ioLogik. When you install the ioLogik for the first time, the password will be blank and you can simply click Login. If a password has already been set, hold down the reset button to clear the password and load factory defaults.

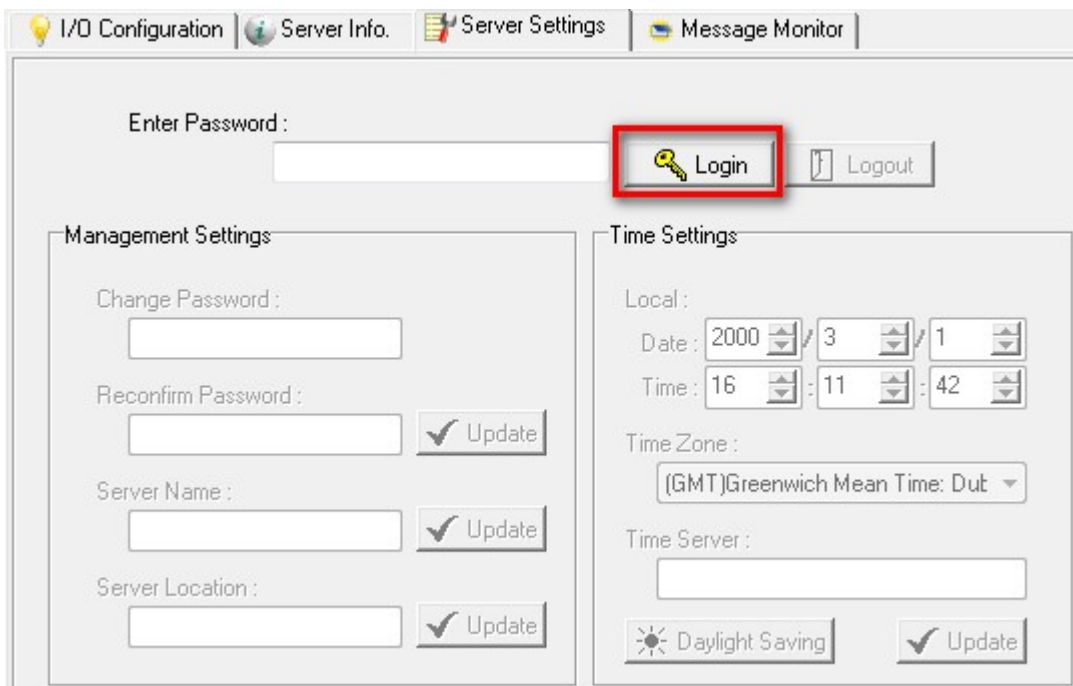

5. **Monitoring and Testing I/O status:** Once your unit has been found by ioAdmin, you can view the status of all attached I/O on ioAdmin's main screen.

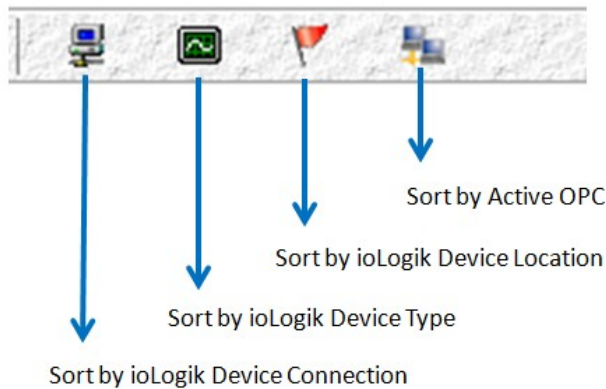

NOTE ioAdmin supports four viewing options for the navigation panel. If you select **Sort by Active OPC server**, the ioLogik W5300 will appear in the **Active OPC** server group. Alternately, the same device will be shown under the **LAN** group if you connect to the W5300 with Ethernet cables, instead of over the cellular network.

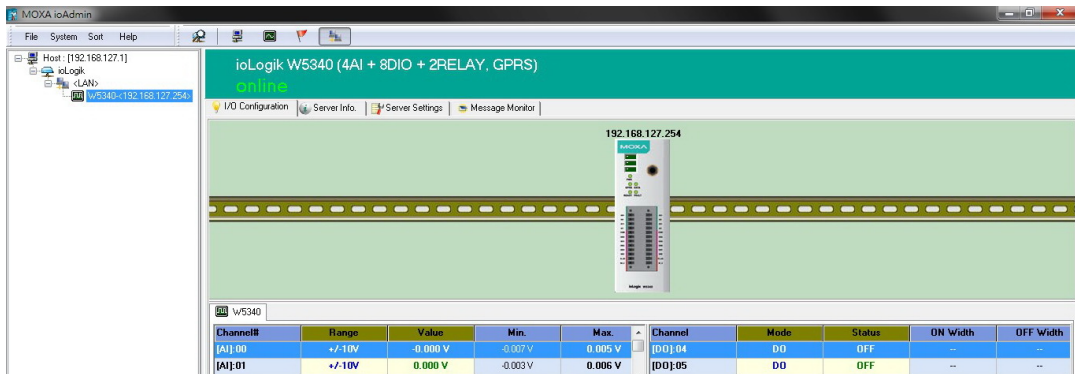

You can test each DO channel by opening the channel's configuration window and selecting the **Digital Output Test** tab.

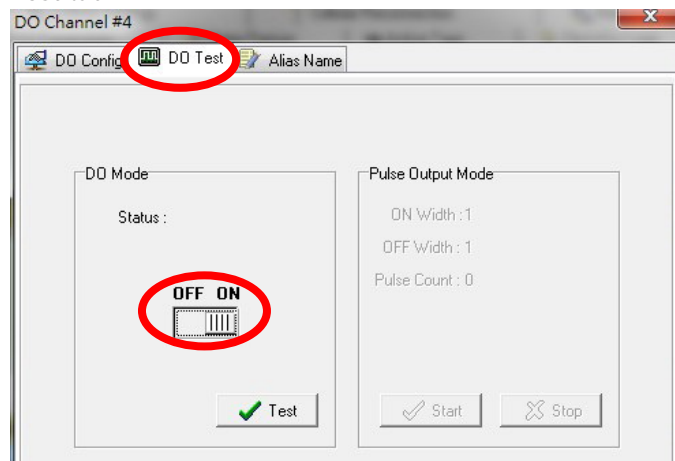

After clicking the **Test** button, you can see how a channel's status affects or is affected by the attached device. For DO channels, you can set the on/off status to start and stop pulse output. For DI channels, you can monitor the attached device's on/off status, or monitor the counter.

You can now use ioAdmin to set up or configure your unit. Refer to Chapter 3 for additional information on using ioAdmin.

Configuring Digital I/O Channels

The ioLogik W5300 product family is equipped with different I/O types, including analog inputs, digital inputs, digital outputs, relay outputs, and software configurable DIOs, offering great flexibility for connecting I/O devices such as software configurable DIO channels. Before you connect I/O devices and sensors, you should configure the DIO channels as DI or DO. The W5340 for example comes with 4 DI channels and 4 DO channels. However, the user has the option of redefining the function of these channels. Each DIO channel is configured to act as either a DI or DO channel, according to the **Power On Settings**. To switch between DI and DO channel operation, select the desired mode in the **I/O Direction** field under **Power on Settings**. After clicking **Apply**, you will need to restart the ioLogik W5300 for the new setting to take effect.

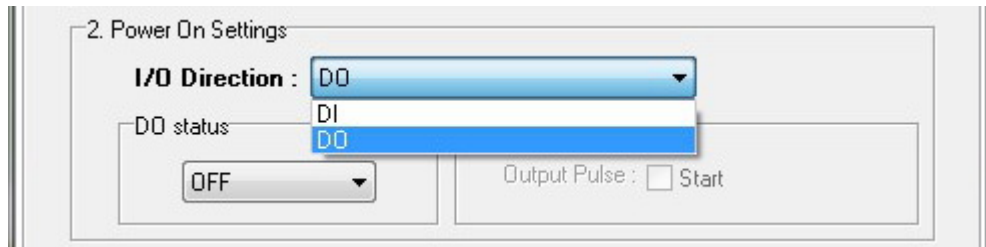

Connecting I/O Devices

Unlike traditional Ethernet I/O products, the ioLogik W5300 can connect to analog sensors, dry contact, PNP, and NPN sensors at the same time. The sensor type determines your wiring approach, as shown in the following examples (this example shows the pin numbers for an ioLogik W5340 unit):

Analog Input

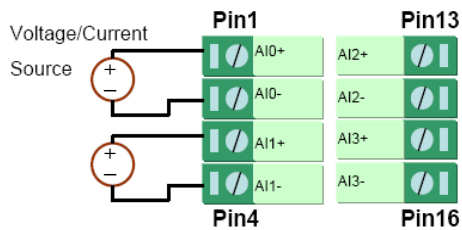

Digital Input Dry Contact:

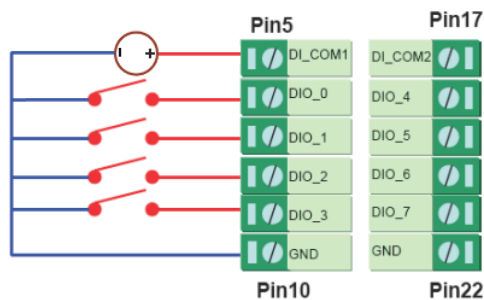

Digital Input Wet Contact (Connect to NPN-type Sensor)

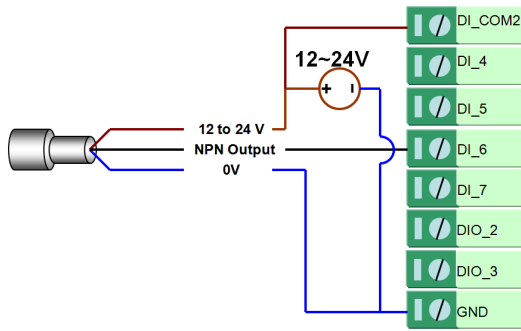

Digital Input Wet Contact (Connect to PNP-type Sensor)

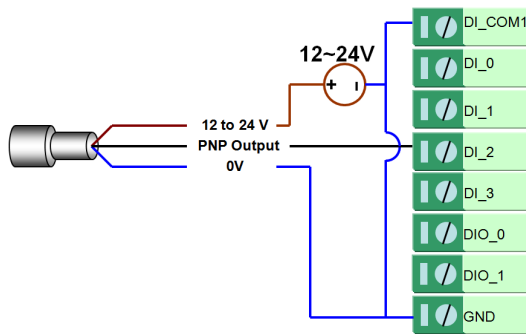

Digital Output (Sink Type)

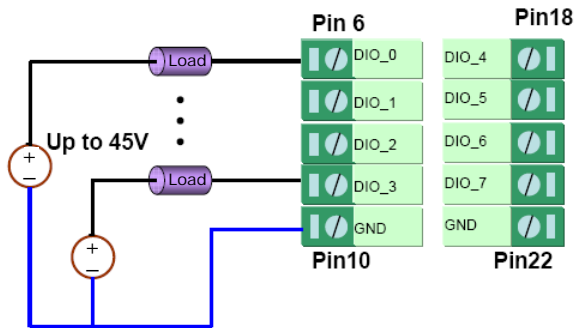

Relay Output

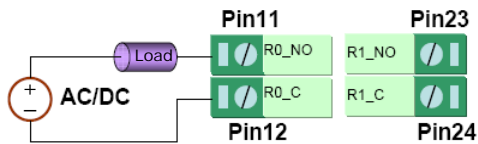



ATTENTION

When connecting the I/O device to the ioLogik’s dry contacts, we strongly recommend connecting DI.Com to the power of the external sensor to avoid affecting other channels. DI.Com input power should be limited at 12 to 36 VDC.

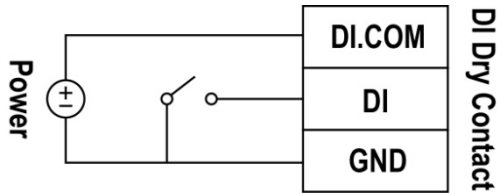

ATTENTION

Sensor types are arranged in groups, with DIO-0 to DIO-3 forming one group and DIO-4 to DIO-7 forming another group. If an NPN sensor is connected to DI-0, then only NPN sensors can be connected to the other DI channels in that group (i.e., DIO-1, DIO-2, and DIO-3). Likewise, if a PNP sensor is connected to DIO-4, then only PNP sensors can be connected to the other DI channels in that group (i.e., DIO-5, DIO-6, and DIO-7).

NOTE

A “load” in a circuit schematic is a component or portion of the circuit that consumes electric power. For the diagrams shown in this document, “load” refers to the devices or systems connected to the remote I/O unit.

Testing I/O Devices

Power on the ioLogik W5300, try changing the I/O status, and then use ioAdmin to determine if the status has changed under the **I/O Configuration** bar. (Refer to the figure below)

Channel#	Range	Value	Min.	Max.
[AI]:00	+/-10V	0.001 V	-0.008 V	0.005 V
[AI]:01	+/-10V	0.001 V	-0.006 V	0.009 V

Channel#	Operation	Value	Unit
[VC]:00	--	--	--
[VC]:01	--	--	--

Channel	Mode	Status	Filter	Trigger
[DI]:00	DI	OFF	50.0 ms	--
[DI]:01	DI	OFF	50.0 ms	--

Channel	Mode	Status	ON Width	OFF Width
[DO]:04	DO	OFF	--	--
[DO]:05	DO	OFF	--	--
[DO]:06	DO	OFF	--	--
[DO]:07	DO	OFF	--	--

Channel	Mode	Status	ON Width	OFF Width
[RLY]:00	DO	OFF	--	--
[RLY]:01	DO	OFF	--	--

DIN Rail / Wall Mounting

The ioLogik W5300's built-in mounting appendages are suitable for mounting on a flat wall or installing on a DIN rail. Follow the instructions in the figures below to install the W5300 on a DIN rail.

STEP 1: Insert the top of the DIN rail into the slot.

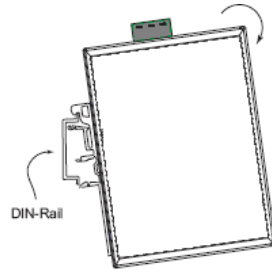

STEP 2: The DIN rail attachment unit will snap into place as shown at right.

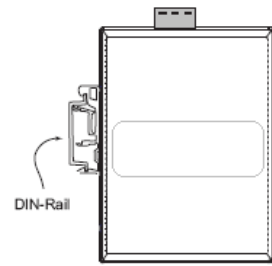

Installing/Removing SIM and SD Cards

The ioLogik is equipped with two slots; one is for SIM cards and the other is for SD cards. The card reader slots are protected inside the ioLogik device. You will need to unscrew and remove the card cover to install your SIM and SD cards. When inserting an SD or SIM card, remember to keep the chipped side of the card facing down.

Follow these steps to remove or install a SIM or SD card:

1. Remove the screw holding the card cover in place.

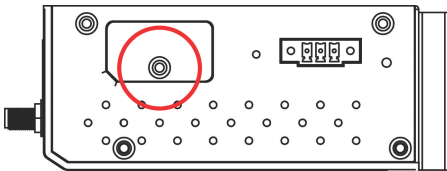

2. There are two different card slot types used on the ioLogik series of devices:
 - (a) On ioLogik W5312 and W5340 models, directly insert or remove the SIM/SD card into the respective slot
 - (b) On the ioLogik W5340-HSPA you must first depress the card-locking mechanism to eject the card. Use a pointed instrument like a ball-point pen to depress the small yellow button at the side of the card slot. This ejects the card tray, from which you may then insert or remove a SIM card.

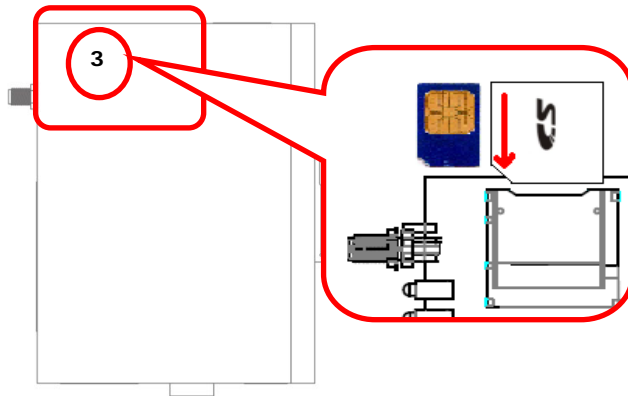

ATTENTION

We strongly recommend using the following SD cards, which have been tested in our laboratory:

- Kingston SDHC 4/16/32 GB
- Transcend SDHC 4/8/32 GB
- Innodisk SD6 2/4/8 GB (These Innodisk SD cards are classified as wide-temperature products.)

The function is dependent on the firmware version. Be sure to use firmware version V1.3 or above for the ioLogik W5312 series, and V1.5 or above for the ioLogik W5340 series.

The SIGNAL LEDs on the front panel provide a convenient way of checking if the SIM card is installed properly. If the antenna is installed and the network is operating normally, then at least one of the three SIGNAL LEDs should be illuminated at all times. If none of the LEDs are illuminated, then the SIM card may not be installed properly. This is because the PIN code is stored on the SIM card; if the PIN code cannot be accessed, then the modem will not be accessible over the network. If the LED is not illuminated, check the Error message shown on the ioAdmin “cellular settings” panel.

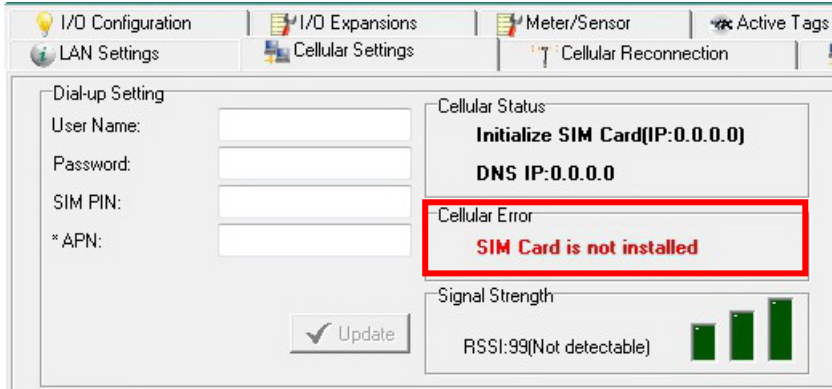

Connecting the ioLogik W5300 to a Cellular Network

When the environment is ready, follow these steps to test the ioLogik W5300 (refer to the figure below).

Step 1: Connect directly from the PC to the W5300 and use ioAdmin to configure the W5300’s cellular settings.

Step 2: For the ioLogik W5300, enter the user name, password, SIM Pin, APN, and define the **Active OPC server** IP on the cellular settings page. Make sure the Operation Mode is correctly selected.

Step 3: Remove the cable connecting the PC and ioLogik W5300, re-open ioAdmin, and then add the **Active OPC Server** manually. The checkmarked PC will receive Internet access first.

Active OPC Server (Taipei, Taiwan)
 Public & Static IP Address: 59.124.42.169
 Domain Name: gprsio.moxa.com

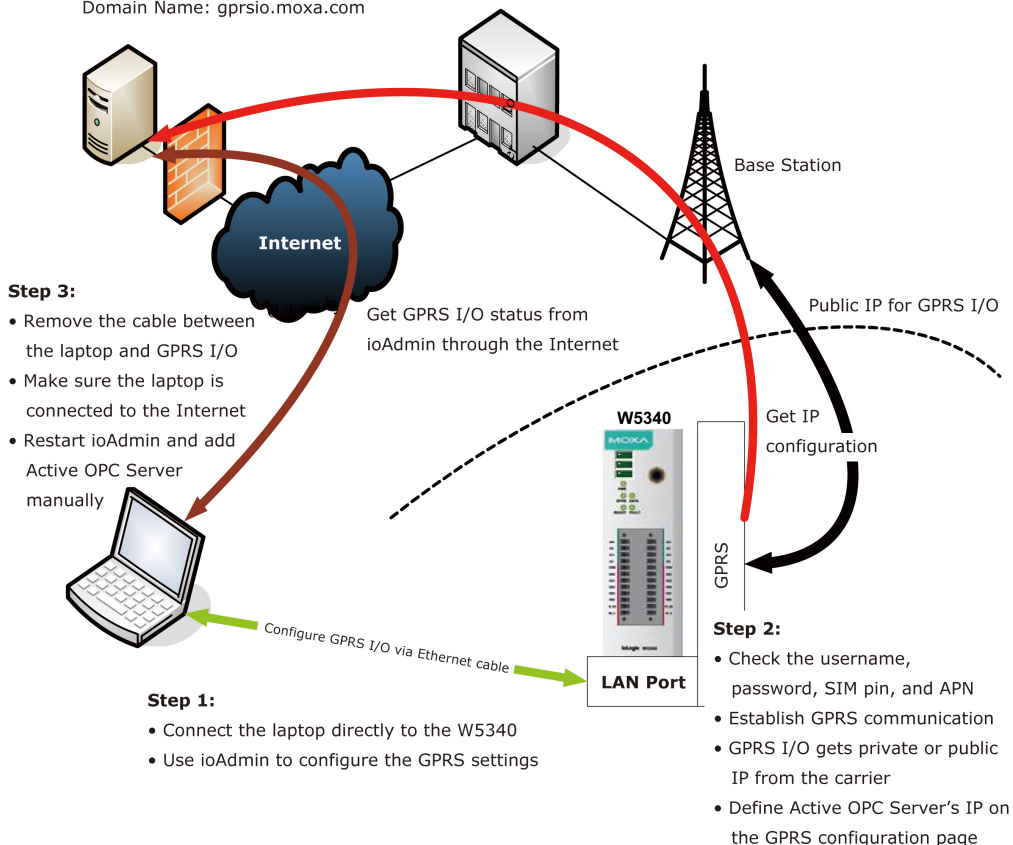

Detailed instructions:

1. Power off the ioLogik W5300.
2. Insert a SIM card that can connect to the cellular network.
3. Connect to ioAdmin via the Ethernet port of the ioLogik.
4. Power on the ioLogik and start ioAdmin.
5. After connecting ioAdmin and the ioLogik W5300, log in with the administrator password.
6. To set up your cellular connection, click the **Cellular Settings** tab and enter your User name, Password, SIM pin code, and APN of your Cellular Provider (contact your local Cellular Service Provider for assistance) than click **Update**. When you click **Update**, the system will prompt you to restart to activate the new settings.

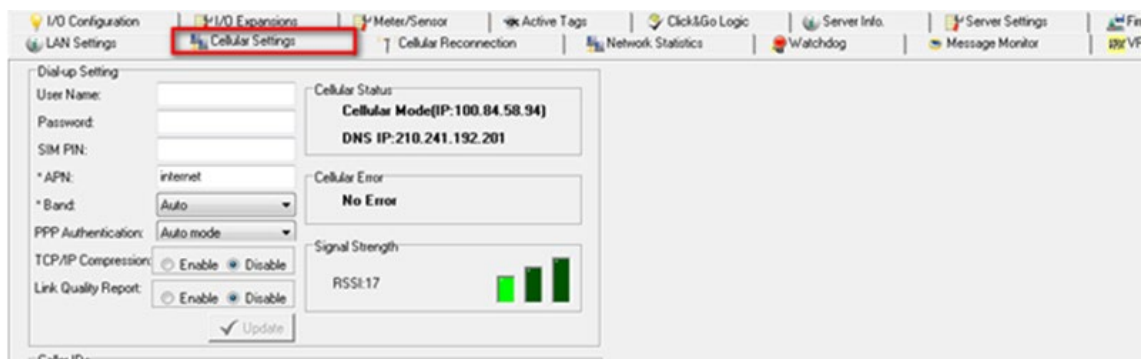

7. **The Operation Mode** must also be correctly selected for your application. (Default Operation Mode: Cellular Always On)
8. After rebooting, the W5300 will try to connect to the Cellular network, with the connection status shown in the **Cellular Status** column. If the connection is established, the IP address will appear in this column. If the connection is not successful, you will receive an Error message. Additional details can be found in Appendix F.
9. For testing, Once you have obtained the public IP address for the ioLogik W5300, try to **PING** from the DOS shell (e.g., type **C\>ping 61.56.74.10**). If the W5300 is using a private IP, you can skip this step.

NOTE Be sure to configure the LAN settings first to make sure the LAN IP Address is on the same subnet as the PC running ioAdmin. Follow the instructions to restart the ioLogik and then proceed with the settings on the Cellular Settings page.

NOTE Be sure to select the Cellular Setting → Operation Mode → **Cellular Always ON** when performing the connection test.

Installing AOPC on a Host with a Static IP Address

Moxa's Active OPC Server™ is an OPC software driver for an HMI or SCADA system. It seamlessly connects Moxa's ioLogik products to a wide variety of SCADA systems, including the most popular: Wonderware, Citect, and iFix. Active OPC Server™ conforms to the OPC Foundation's DA 3.0 data access standard. Active OPC server must use public, static IP address.

1. To install Active OPC Server, it can be downloaded from Moxa's Website, and may be found from the support page, www.moxa.com/support/. After downloading the AOPC software, unzip it and run **setup.exe**. The installation program will guide you through the installation process and install the Active OPC Server Utility.

*For more details on AOPC installation and use, refer to the **Active OPC User's Manual**.*

2. Start the ioAdmin utility and set up the Active OPC Server IP address on the **Active Tags** panel. ioAdmin will prompt you to reboot the ioLogik W5300 after clicking the **Update** button. Click **yes** to restart the ioLogik.

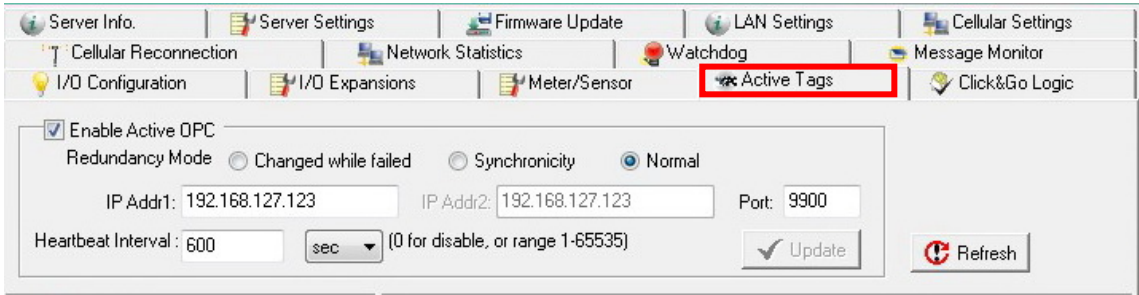

3. Start Active OPC Server; a new ioLogik W5300 will be created.
4. In ioAdmin's search menu, manually add the IP address for Active OPC Server. The ioLogik W5300 will appear under Active OPC Server. The ioAdmin search menu is set by default to sort **by Active OPC**.

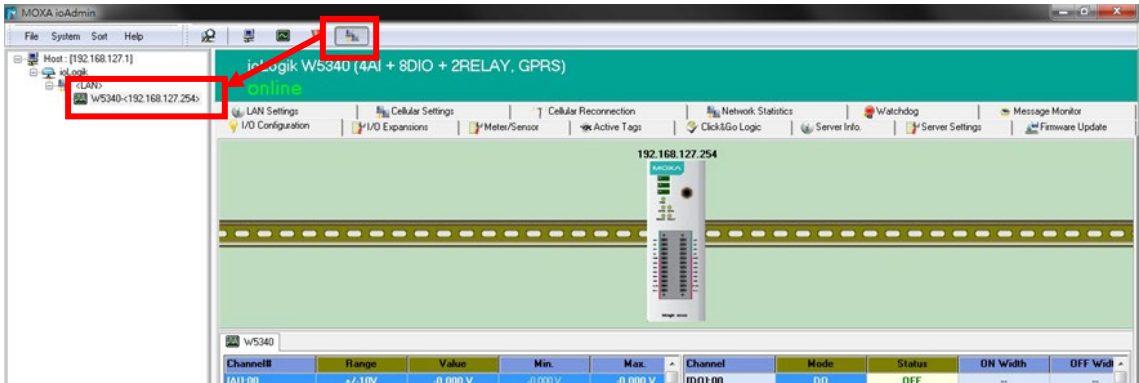

5. You can now test and monitor I/O status in ioAdmin.

NOTE In this scenario, Active OPC Server is acting as middleware between the central configuration/control software and the ioLogik W5300 remote I/O unit served over a cellular interface. To minimize bandwidth usage, click the **Refresh** button manually to retrieve the settings.

Import/Export a Configuration File

Using ioAdmin to Import/Export a Device Configuration

To import or export a system configuration right click on the I/O model name and then selection **Import System Config** or **Export System Config**. You must be logged in as an administrator to use this command.

Export System Config

Select this command to export the selected ioLogik's configuration to a text file. We recommend using this method to back up your configuration after you have finished configuring the ioLogik for your application.

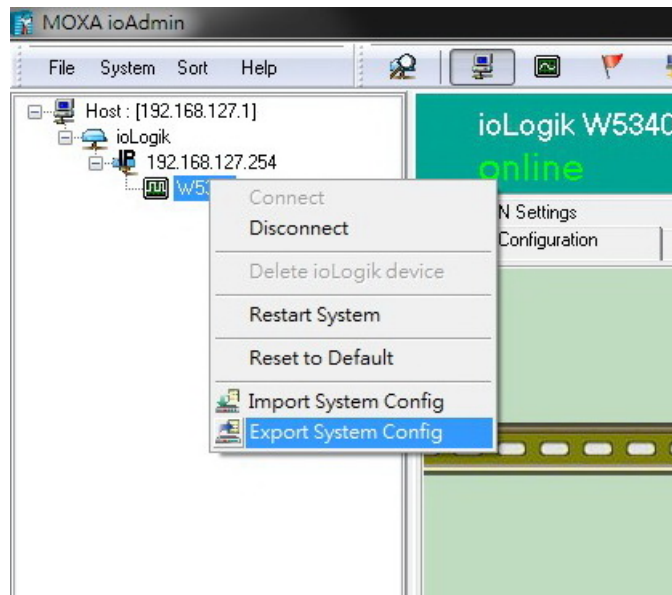

ATTENTION

Since there are major functional differences between firmware versions, exporting the configuration file requires a longer processing time. **Adjust the TCP Socket Timeout Interval to 30 seconds** when using ioAdmin 3.10 or above, especially if earlier versions of ioAdmin have been installed and then removed.

Import System Config

Select this command to load a configuration for the selected ioLogik from a configuration text file. The new configuration will not take effect until the ioLogik has been restarted. This command can be used to restore a configuration after loading the factory defaults, or to duplicate a configuration to multiple ioLogik units.



ATTENTION

Since there are major function differences between firmware versions, the configuration file is not compatible if using firmware V1.3 or above for the ioLogik W5312 series, and V1.5 or above for the ioLogik W5340 series.

The configuration file cannot be imported into firmware versions earlier than the above versions. Be sure to check your firmware version carefully before importing/exporting and upgrading firmware.

The ioAdmin Utility

In this chapter, we explain how to use ioAdmin to configure your ioLogik product.

The following topics are covered in this chapter:

❑ System Requirements

- Key Features

❑ Using the ioAdmin Utility

- The ioAdmin Utility Window
- ioAdmin Menu Bar
- The Wiring Guide
- ioAdmin Quick-Link Buttons

❑ ioAdmin Navigation Panel

- Main Window
- Synchronization Rate Status Bar
- ioAdmin Status Bar

❑ ioAdmin Configuration Panels

❑ The Server Settings Panel

❑ The LAN Settings Panel

❑ The I/O Configuration Panel

- Configuring AI Channels
- Configuring Digital I/O Channels
- Configuring Digital Input Channels
- Configuring Digital Output / Relay Output Channels
- Testing DI and DO Channels

❑ The I/O Expansion Panel

- I/O Expansion: Step-by-Step

❑ The Active Tags Panel

- Active OPC: Redundancy Mode

❑ The Cellular Settings Panel

- Dial-up Setting
- Caller IDs
- Operation Mode
- DDNS Settings
- VPN Settings Panel (ioLogik W5340-HSPA(-T) only)
- VPN System Log Events and Error Codes
- Cellular Reconnection
- Meter/Sensor
- Network Statistics
- Watchdog Panel

➤ Click&Go Logic Panel

System Requirements

ioLogik W5300 remote I/O units can be managed and configured over either an Ethernet or cellular network using ioAdmin, a Windows utility provided with your ioLogik. ioAdmin's graphical user interface gives you easy access to all status information and settings. ioAdmin can also be used to configure Click&Go rules to provide front-end event handling capabilities.

Hardware Requirements	
CPU	Intel Pentium (Pentium 4 and above)
RAM	512 MB (1024 MB recommended)
Network Interface	10/100Mb Ethernet
Software Requirements	
Operating System	Microsoft Windows 2000, XP or later
Editor(Not necessary)	Microsoft Office 2003 (Access 2003) or later

NOTE In this chapter, all of the descriptions are based on ioAdmin 3.10. The function, however, is dependent on the firmware version. Use firmware version V1.3 or above for the ioLogik W5312 series, and V1.5 or above for the ioLogik W5340 series.

Key Features

Remote Management

Over the Ethernet or Cellular network, ioAdmin allows users to:

- Search and configure multiple ioLogiks.
- Perform I/O status monitoring and control
- Use active message monitoring
- Use Click&Go local logic control configuration
- Use the firmware upgrade interface
- Restart the ioLogik
- Reset to factory defaults

On-line Wiring Guide

A wiring guide can be opened from within ioAdmin.

Configuration File

ioAdmin allows the entire configuration of the ioLogik W5300 series to be saved as a file. The file is viewable in text format and serves three purposes:

- As a record or backup of your configuration.
- As a template for configuring other ioLogik W5300 units.
- As a quick reference guide for you to configure Modbus drivers in a SCADA system.

The file includes the following information:

- File title, Date, and Time
- Model Information
- System Configuration
- Modbus Address

Device Management List

ioAdmin can import and export a list of ioLogik devices that are being managed. This file can make it easier to manage all devices on the network, and includes the following information:

- Device name
- Module
- IP address
- Unit ID

Using the ioAdmin Utility

The ioAdmin Utility Window

Below you see a screenshot of ioAdmin’s main window, with its main features highlighted. The window defaults to the **I/O Configuration Panel**, which displays a figure of your unit and the status of its I/O channels. The other tabs in the main window take you to device and network settings which become available once you log into the ioLogik. Note that configuration options are not available until you log in as administrator.

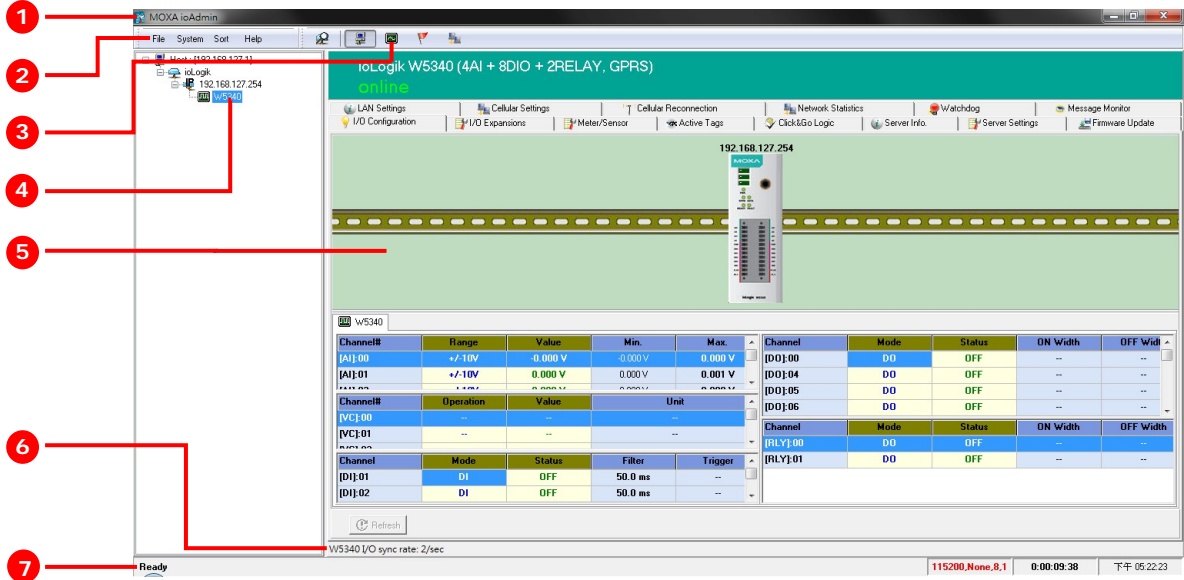

- 1. Window title
- 2. Menu bar
- 3. Quick-link buttons
- 4. Navigation panel
- 5. Main window
- 6. Sync. rate status
- 7. Status bar

ioAdmin Menu Bar

Menu Bar: File

Here you can save, import, or export a configuration file or lists of servers and devices. When importing or exporting device lists you will be prompted for source and destination devices with a popup window. You may click on the **Folder** icon to select the device you will be retrieving the list from, or key-in the file name to save/import a specific file.

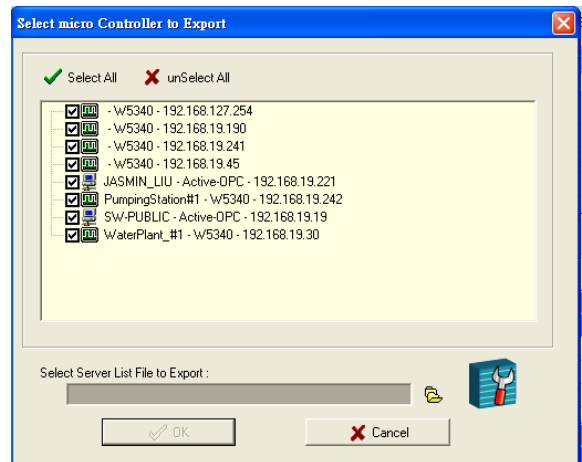
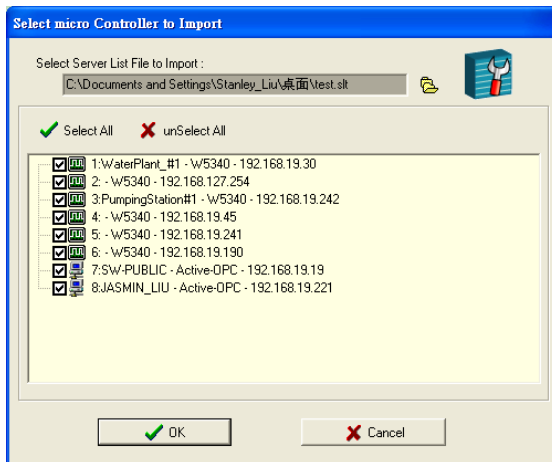

The file will have an .SLT extension and can be opened as a text file. The server list will provide the basic information for each server, such as **Device Name**, **Model**, **IP address**, and **Unit ID**.

Menu Bar: System

Several operations can be accessed from the System menu.

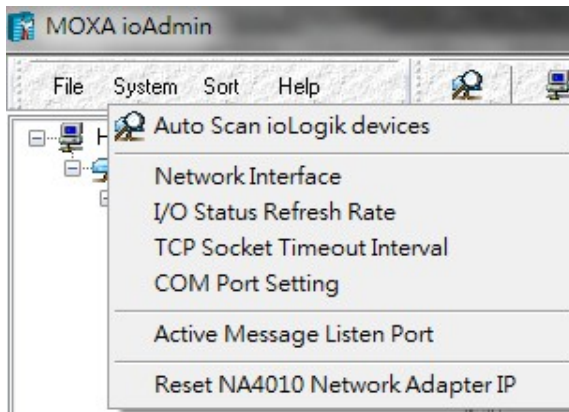

Auto Scan ioLogik Devices searches the network for connected ioLogik devices. This is useful when connecting a new device for the first time, or when recovering from a network failure.

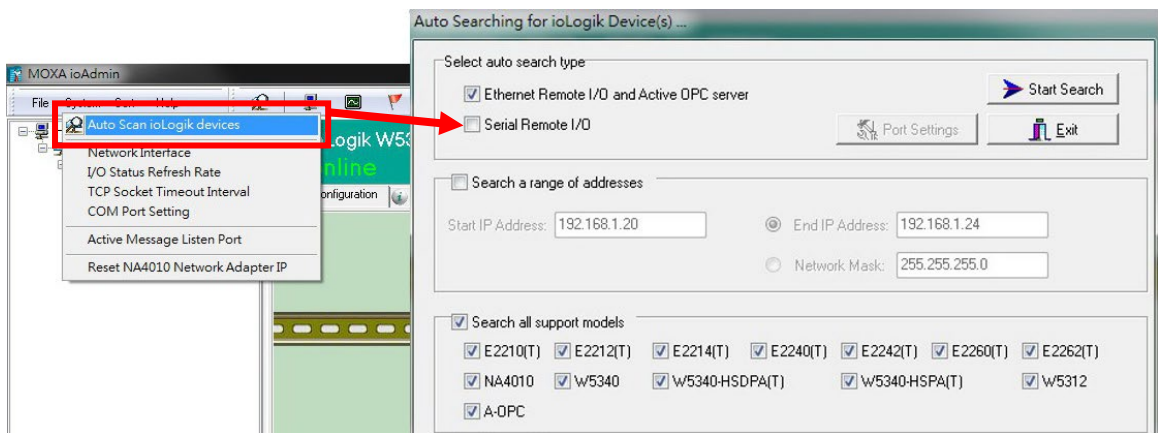

Auto-scan allows you to search according to **Type**, **IP Range**, or **Model**.

Type: Search for ioLogik remote I/O terminals by the type of connection, either **Ethernet** or **Serial**.

IP range: There are two ways to define a range of IPs to search: by entering a starting IP address and an ending IP address in the appropriate boxes, or by using a netmask with a starting IP address.

Model: Search for selected models; click all that you are interested in finding.

Click **Start Search** to begin. Whenever a device is found, it will display in the lower portion of the window.

Network Interface: If the PC has multiple network adapters installed, this allows you to select which NIC the device will connect over. The default network interface will be the same as the one set in Windows. If the ioLogik device is not connected to the selected interface, the PC will not be able to detect it.

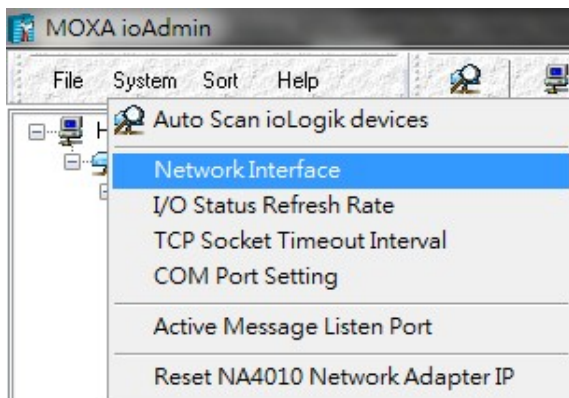

I/O Status Refresh Rate is used to adjust how often the ioLogik is polled for device status by the ioAdmin utility. The current rate is displayed on the status bar at the bottom of the window.

Note: Higher sync rates result in higher loads on the network.

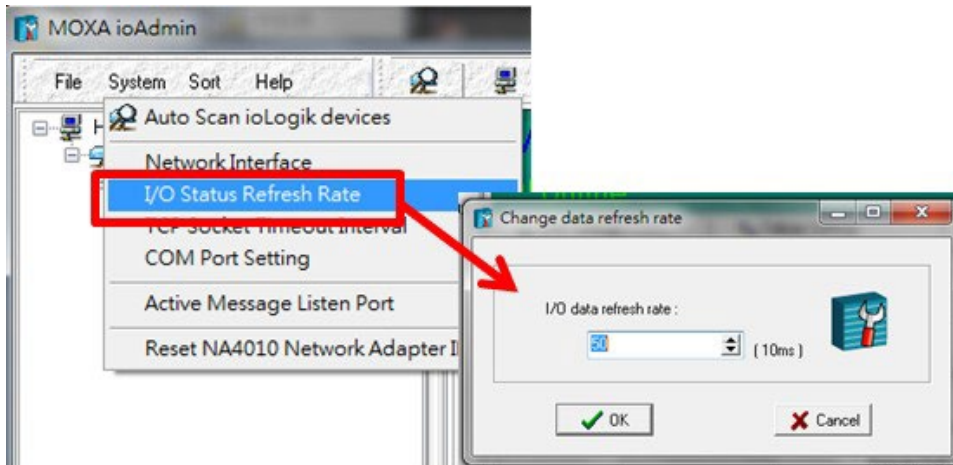

TCP Socket Timeout Interval allows you to set a timeout period when attempting to establish a connection over a TCP socket. If the ioLogik cannot connect to a server within the specified time period, it will automatically release the modbus/TCP connection to free up the port for the next attempt. (Default: 30 seconds)

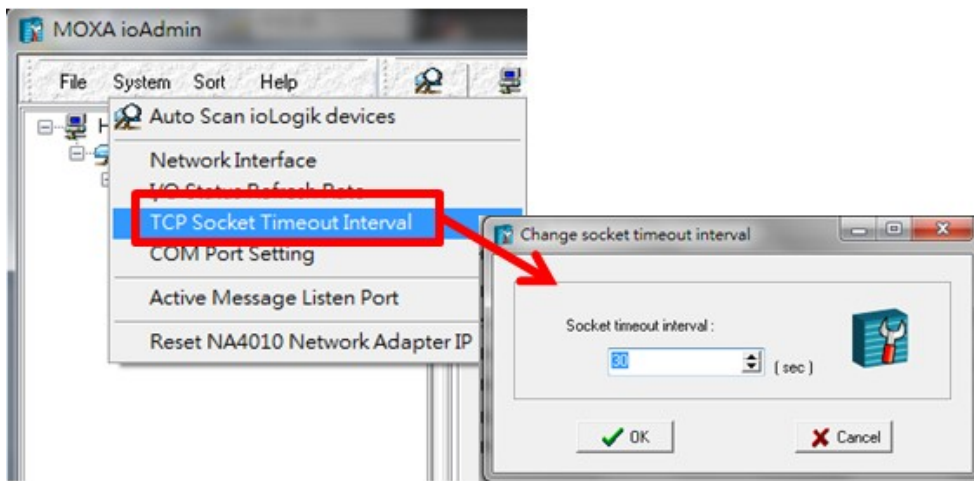

COM Port Setting is used to set the default serial communications parameters so the ioAdmin utility may establish a Modbus connection. The fields are **baud rate**, **data bits**, **stop bits**, **parity**, and **timeout interval**. For most applications, this will involve connecting to ioLogik R-series devices.

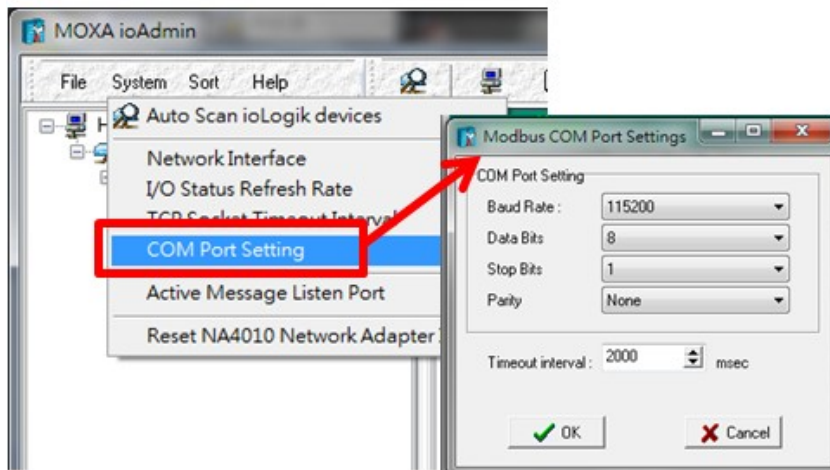

Active Message Listen Port specifies the port number over which the ioLogik will listen for Active Messages. If the active messages are traveling across a network firewall you must be sure to open the port on your firewall settings to ensure that messages can get through.

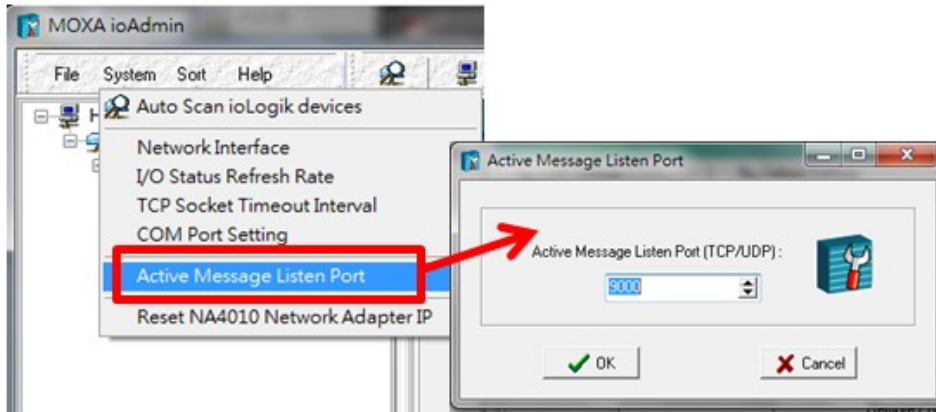

Reset NA4010 Network Adaptor IP is used to re-assign an IP address to the NA-4010 network as reported by the ioLogik W5300 series adapter.

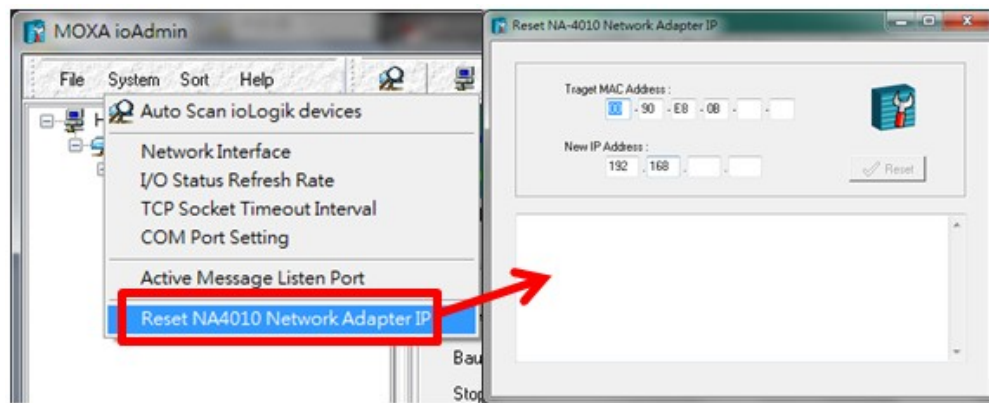

Menu Bar: Sort

The **Sort** menu re-orders the list of devices shown in the navigation panel according to their **connection/IP address, model, location** (as defined in the **location field**, a 58 character descriptor that may be set in the **The Server Settings Panel**), or whether or not the device supports an **Active OPC** client.

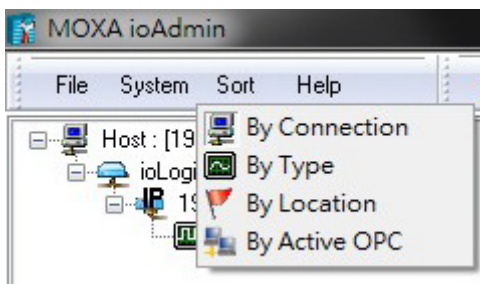

The Wiring Guide

ioAdmin provides a wiring guide for the ioLogik W5300 series. You can access the wiring guide by right-clicking the ioLogik figure in the **I/O Configuration panel**, or by clicking on the **Wiring Guide** icon in the submenu at the top of the window. The wiring guide is a help file showing wiring information and electrical characteristics for various types of connection.

You can also access the wiring guide online, by clicking on the links provided in the **Help** menu on the menu bar.

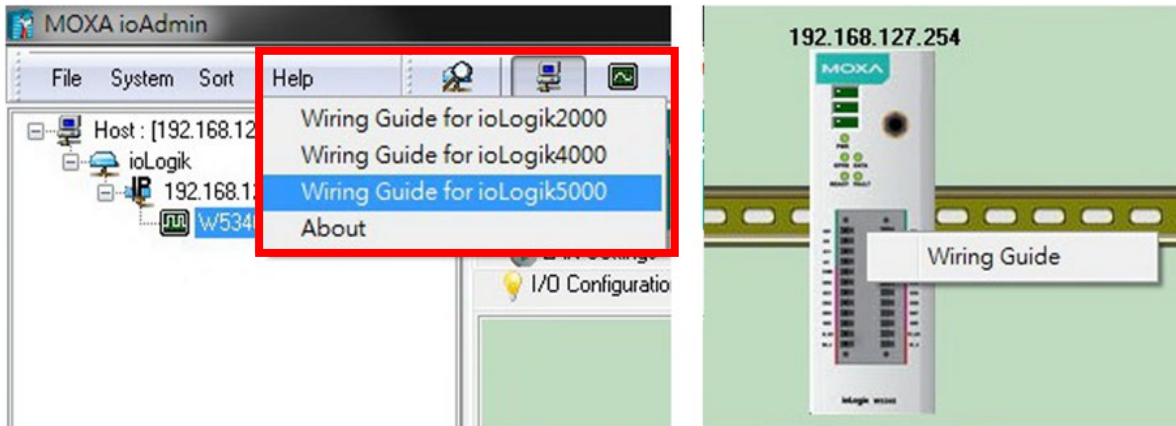

ioLogik W5340 Active GPRS I/O

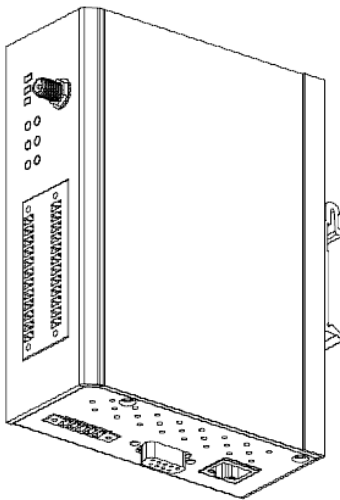

Specifications

System power: 24 VDC nominal, 12 to 36 VDC
 Power dissipation:
 GPRS Always On (Communication): 4.2 W

Analog Input

Channels: 4, differential inputs, 16 bits
 I/O Mode: Voltage: 0 to 10 V, +/- 10V, +/- 5V
 Current: 0 to 20 mA, 4 to 20 mA
 Input Impedance: 200K ohms (min.)
 Built-in Resistor for Current Input: 102 ohms

Software Configurable Digital Input/Output

Channels: 8
 I/O Mode: DI, event counter, DO, Pulse Output
 Sensor Types: DI: NPN, PNP, 24V
 DO: Sink, 45 VDC, 200 mA
 Common Type: 4 points per COM
 Power off Storage for Counter Mode: Yes

Relay Output

Channels: 2 Form A (N.O.) relay outputs, 5 A
 Contact Rating: 5A @30VDC, 5A @110/240VAC
 2A (Inductance Load)/5A (Resistance Load)
 Relay On/Off Time: 10 ms, 5 ms (max.)

I/O Cable Gauge : AWG14 ~ AWG28

System Wiring

Analog Input:

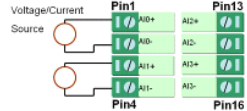

Digital Output (Sink Type)

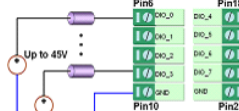

Relay Output

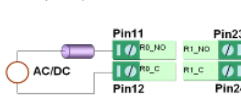

ioAdmin Quick-Link Buttons

Quick links are a collection of commonly used features. Starting with the rightmost icon, they include search, and a series of sorting buttons: by connection, by device type, by the device's 58 character location descriptor (defined in the **The Server Settings** Panel), or show all devices which have an AOPC client installed on them.

Auto-Scan ioLogik Devices









Auto Scan ioLogik devices allows users to search and locate an ioLogik on the same physical network, or specify a remote IP address to connect to a remote ioLogik.

Sorting Views

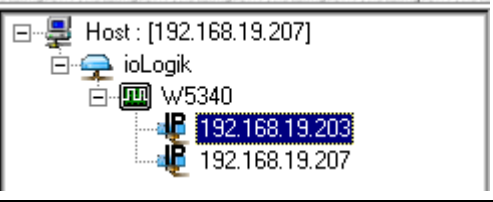
These buttons give four different ways of re-ordering devices in the ioAdmin navigation panel. The icons are shown at right, and explained in the table below.

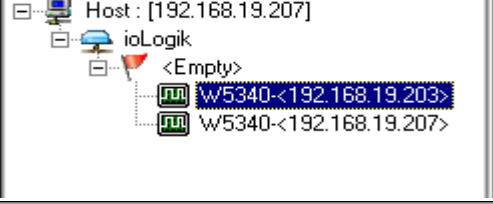

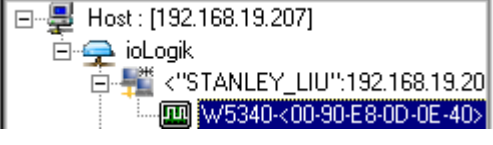
ICON		Navigation Panel View
	Sort according to the connection : using subnets and IP addresses	
	Sort according to device type using the ioLogik model number	
	Sort by the ioLogik's location field; this is a descriptor that is defined in the ioAdmin's The Server Settings Panel	
	Show all devices that support an Active OPC client	

NOTE The default location is **Empty**. If you have not set the **location** field when setting up the ioLogik W5300, the navigation panel will register its location as **Empty**, and group all devices configured so together.

ioAdmin Navigation Panel

The navigation panel shows an overview of every configured ioLogik device currently connected to the network, with devices ordered according to the selected **Sorting Views** (see above). The default view is **By Connection**. You can choose a different sorting method by clicking the quick-link buttons at the top of the navigation panel.

The navigation panel offers many functions (such as **connect** and **disconnect**). Advanced functions require administrator rights. The action menu is accessed by **right clicking** on the **server's model name** in the navigation panel.

Basic Functions: Add, Connect, and Disconnect

Add ioLogik ioLogik device: Right click an ioLogik tag, then select this command to manually add an ioLogik device or Active OPC server.

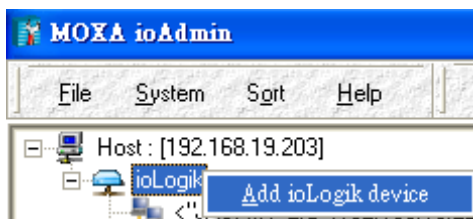

Connect: Attempt to connecting to the selected device over the network.

Disconnect: Drop the network connection to the selected ioLogik.

Advanced Functions: Delete, Restart, Reset, Import/Export Config

You must be logged in as administrator to use these commands.

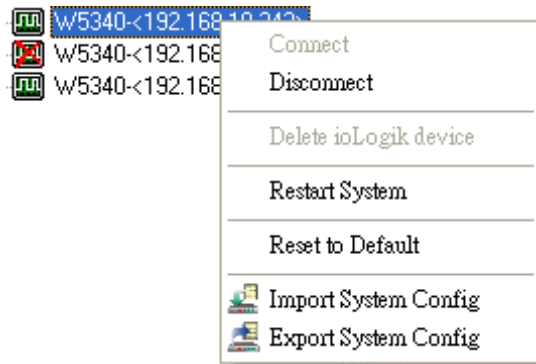

Delete ioLogik device: Select this command to remove the selected ioLogik from the navigation panel. To successfully delete a device from the device list shown in the navigation panel, the target must first be disconnected from the network. Once deleted, a device must be reconnected to the network using the ioAdmin search process, described above.

Restart System: Select this command to restart a selected ioLogik RTU.

Reset to Default: Select this command to reset all settings on the selected ioLogik, including the password and all configuration settings, to factory default values.

Export System Config: Select this command to export the selected ioLogik's configuration to a text file. We strongly recommend that you use this to back up your configuration after you have finished configuring the ioLogik for your application.

Import System Config: Select this command to load a configuration for the selected ioLogik from a configuration file. The new configuration will not take effect until the ioLogik has been restarted. This command can be used to restore a configuration after loading the factory defaults, or to duplicate a configuration to multiple ioLogik units.

```

ioLogik W5340 Network I/O Server Configuration
-----
[System Information]
Date: 2009/02/22
Time: 17:34:04
Click&Go= 02.0
MOS= U3.2.26

[1. Model]
-----
MOD_TYPE=W5340 - Active GPRS I/O Server (8DI0 + 4AI + 2Relay)
MOD_LOC=
MOD_NAME=

[2. I/O Configurations]
-----
DI00=0,(DI),          DI00_FILTER=100,(50.000ms)
DI01=0,(DI),          DI01_FILTER=100,(50.000ms)
DI02=0,(DI),          DI02_FILTER=100,(50.000ms)
DI03=0,(DI),          DI03_FILTER=100,(50.000ms)

DO04=0,(DO),          DO04_PWN=0,(OFF),          DO04_SAFE=0,(OFF)
DO05=0,(DO),          DO05_PWN=0,(OFF),          DO05_SAFE=0,(OFF)
DO06=0,(DO),          DO06_PWN=0,(OFF),          DO06_SAFE=0,(OFF)
DO07=0,(DO),          DO07_PWN=0,(OFF),          DO07_SAFE=0,(OFF)

Relay00=1,(Pulse),    Relay00_PWN=0,(Stop),    Relay00_SAFE=0,(Stop),  Relay00_LOW=1,(1500.000ms),  Relay00_HIGH=1,(1500.000ms)
Relay01=0,(DO),      Relay01_PWN=0,(OFF),    Relay01_SAFE=1,(On)
    
```

Main Window

The main window allows users to view I/O status, ioLogik system information, and check messages from the message monitor without requiring logging in to the ioLogik. However, you will need to log in to perform configuration and operation tasks.

I/O Configuration Panel (General)

The **I/O Configuration** panel shows the status of every I/O channel. This is the default panel when you first open ioAdmin. Input channels are listed on the left and output channels are listed on the right. For more information about configuring I/O, see the section **The I/O Configuration Panel**, below.

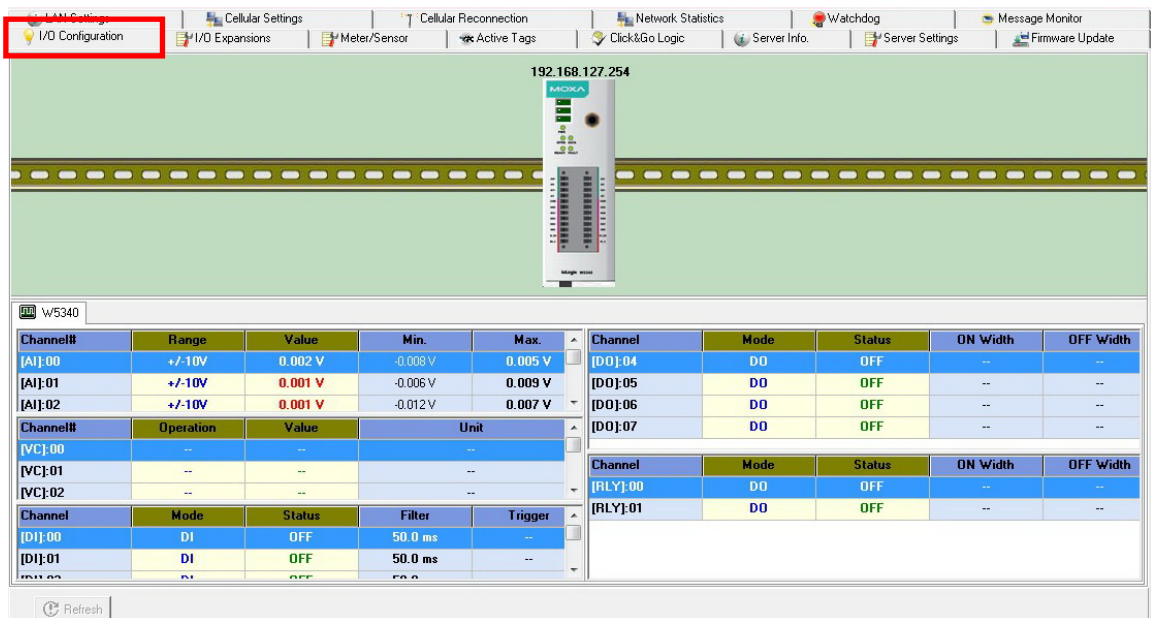

Server Info Panel

Information such as the device name, configured IP address, and firmware version, is displayed on the **Server Info** panel. This panel allows you to look up the Cellular IP address whenever you need it.

Address	Value/Status	Access	Description
34097	0x1393	Read	Vendor ID
34098	0x0001	Read	Unit ID for MODBUS/RTU
34100	Moxa Technologies Inc.,	Read	Vendor Name
34101	W5340 Active GPRS I/O Server	Read	Product Name
34103	V1.9	Read	Firmware Version
34104	Build14012115 (01/21/2014)	Read	Firmware Release Date
34117	V2.0	Read	Click&Go Version
34118	V3.2.48	Read	MDS Version
34120	V1.1	Read	ADC Version
34105	3	Read	Number of TCP connection
34106	0x0100	Read	Ethernet Interface Speed, 10/100
34107	00-90-E8-27-17-21	Read	LAN MAC Address
44097	192.168.127.254	Read/Write	LAN IP Address
44098	255.255.255.0	Read/Write	LAN Subnet Mask
44099	0.0.0.0	Read/Write	LAN Gateway
34163	356611020233163	Read/Write	Cellular IMEI
34123	0.0.0.0	Read	GPRS IP
34111	1119	Read	System Elapsed Time (in sec)
44100	60	Read/Write	Modbus/TCP Alive Check Timeout
44101	0048 0034 0011 0024 0006 2000	Read/Write	System Local Time
44102	54	Read/Write	System Time Zone
44104	255.255.255.255	Read/Write	DNS1 Server Address

Server Settings Panel (General)

Click the **Server Settings** tab to log in as an ioAdmin administrator. This is required to gain access to the ioLogik configuration options. If a password has not been set up, simply click **Login** and leave the **Password** field blank.

Enter Password :

Management Settings

Change Password :

Reconfirm Password :

Server Name :

Server Location :

Time Settings

Local :
Date : 2000 / 3 / 1
Time : 16 : 11 : 42

Time Zone : (GMT)Greenwich Mean Time: Dut

Time Server :

Daylight Saving

Message Monitor Panel (General)

The **Message Monitor** will display any TCP/UDP **Active Messages** reported by the ioLogik W5300. When you install the unit for the first time, the ruleset will not have been defined yet, so there will be no messages on the monitor. When a ruleset has been defined and activated, any TCP/UDP messages that have been triggered by sensor events will be shown on the monitor.

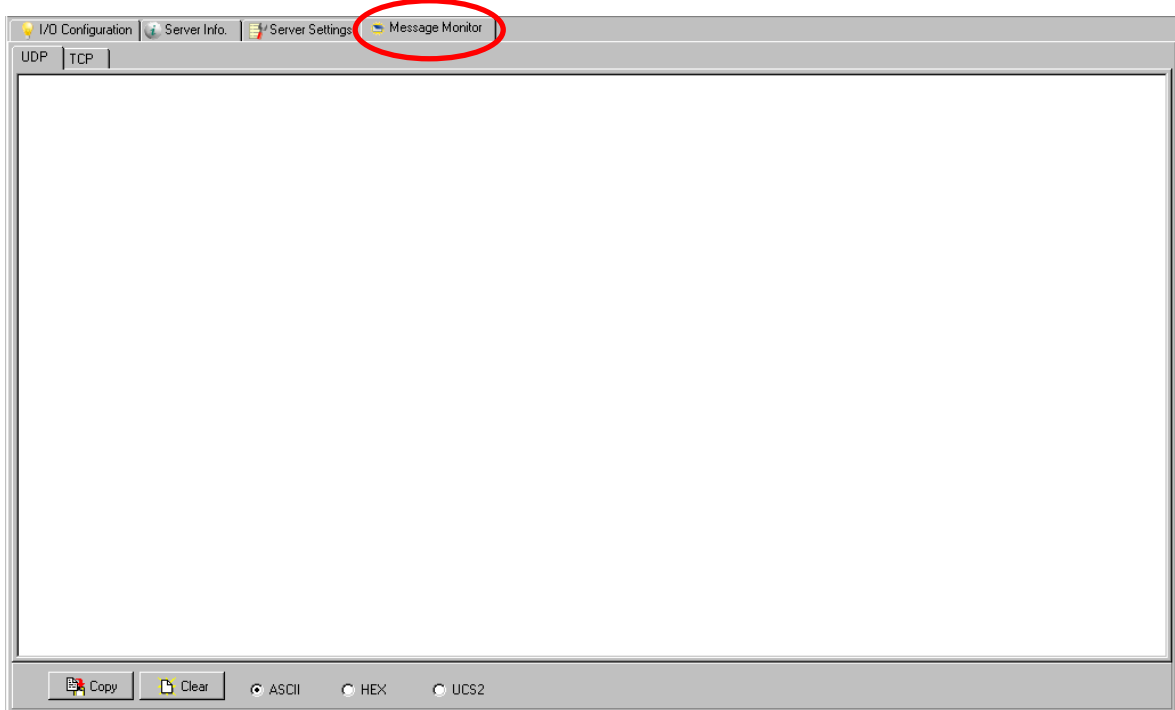

Messages can be displayed in ASCII, HEX, or 2-byte Unicode (UCS2). To select your preferred code, check the appropriate button at the bottom of the window. **Unicode** supports multiple languages.

Synchronization Rate Status Bar

The current sync rate is displayed on the bar at the bottom of the window. The number shows how often the ioLogik is polled for device status from the ioAdmin utility. The rate can be adjusted by clicking **Menu Bar** → **System** → **I/O Status Refresh Rate**. Higher sync rates result in a higher network load.

ioAdmin Status Bar

The status bar shows ioAdmin status information, such as program status (ready, searching), ioLogik I/O details, and system time.

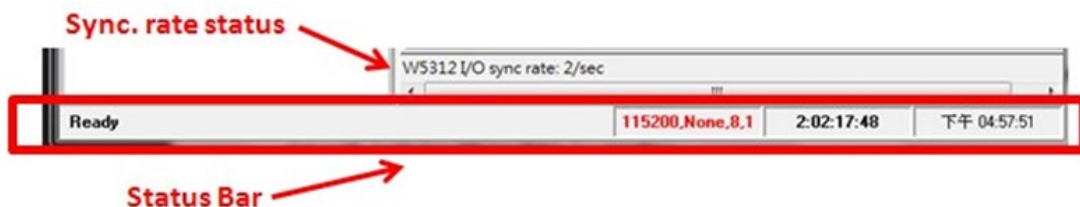

ioAdmin Configuration Panels

For full access to all configuration options users must log in as administrator from the **Server Settings** panel. This is required whenever you start up ioAdmin, re-boot, or restart the ioLogik. When you install an ioLogik for the first time the password will be blank; in this case, just click **Login**, no password is required. Additional functions are available after logging in, including the following tabs:

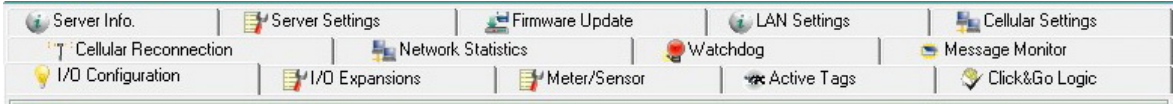

When making configuration changes, you will need to click **Update** or **Apply** to save the changes. Some changes will require that the unit be restarted in order to take effect.



ATTENTION

You **MUST** log in as administrator to access the **Network**, **Watchdog Timer**, and **Firmware Update** panels. If you forget the password, hold down the reset button to clear the password and load factory defaults. **This will result in the loss of all configuration settings and any Click&Go logic that may have already been configured.**

The Server Settings Panel

In the **Server Settings** panel you can configure **Management Settings** like password (up to 16 characters), server name, and server location. ioAdmin supports long server names and a location description of up to 58 chars. You can also configure **Time Settings** such as local date and time, time zone, and time server under the **Server Setting Panel**. For example, you can use `tock.stdtime.gov.tw`.

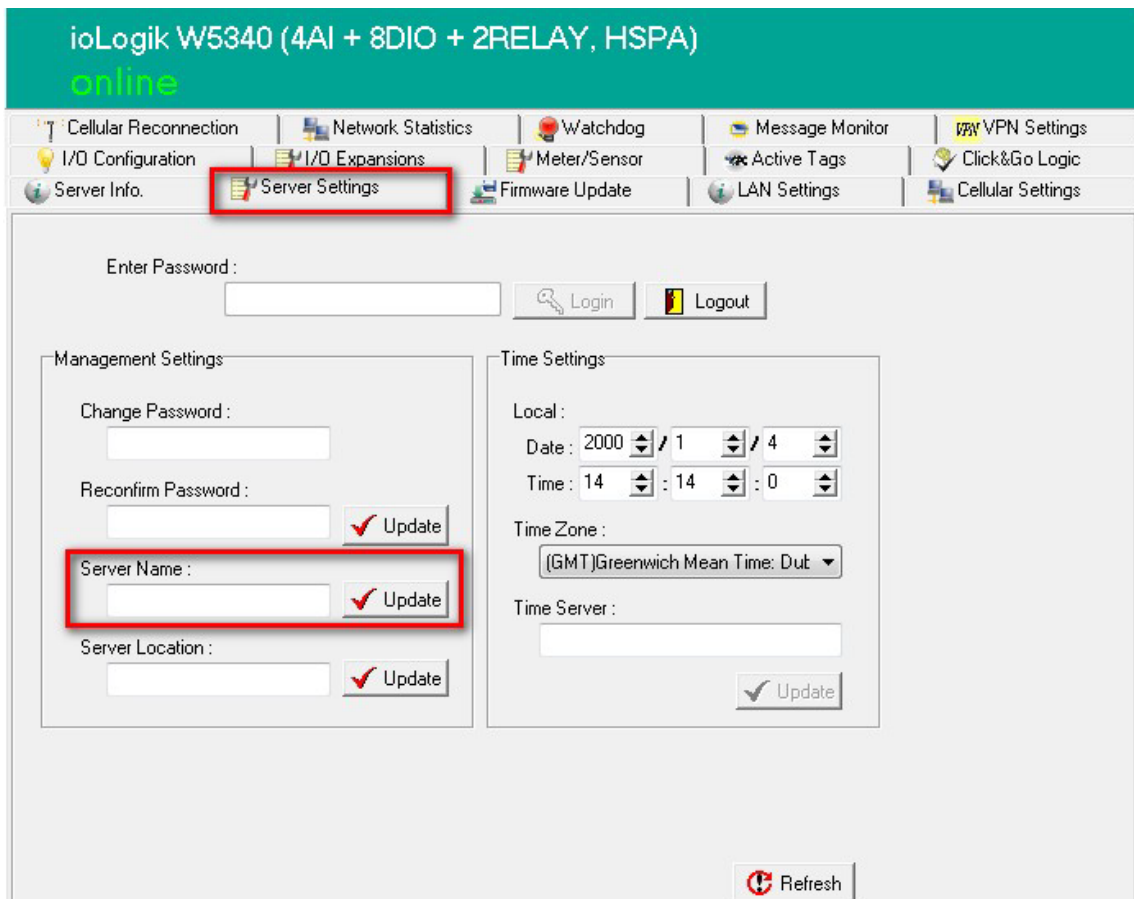

NOTE The server also relates to the node created in the Active OPC Server.

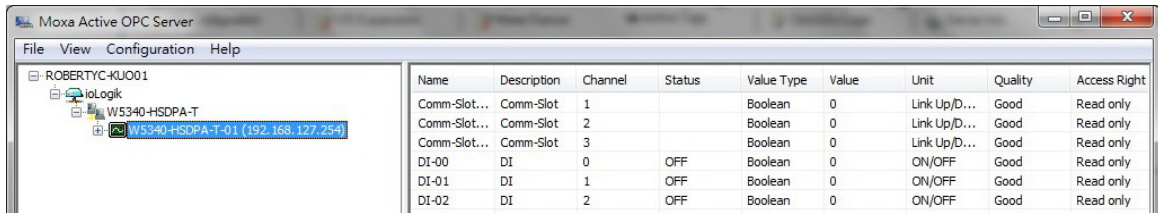

Name	Description	Channel	Status	Value Type	Value	Unit	Quality	Access Right
Comm-Slot...	Comm-Slot	1		Boolean	0	Link Up/D...	Good	Read only
Comm-Slot...	Comm-Slot	2		Boolean	0	Link Up/D...	Good	Read only
Comm-Slot...	Comm-Slot	3		Boolean	0	Link Up/D...	Good	Read only
DI-00	DI	0	OFF	Boolean	0	ON/OFF	Good	Read only
DI-01	DI	1	OFF	Boolean	0	ON/OFF	Good	Read only
DI-02	DI	2	OFF	Boolean	0	ON/OFF	Good	Read only

The LAN Settings Panel

The **LAN Settings** panel is available after you log in as administrator. You will be able to configure **IP**, **Modbus/TCP Alive Check Timeout**, **DNS**, and **SNMP** settings.

IP Settings

You can set up a static or dynamic IP address for the ioLogik, as well as a subnet mask and gateway address. To allow only authorized IP addresses to have access to the ioLogik and attached sensors, click **Accessible IP**. Access will be granted only to addresses listed in the **Accessible IP** screen. Any requests from sources that are not on the accessible IP list will be unable to use Modbus/TCP or ioAdmin to access the ioLogik.

Modbus/TCP Alive Check Timeout Settings

Modbus/TCP Alive Check Timeout is designed to avoid TCP congestion due to a connection failure. If the network host is unable to respond due to a hardware failure or a network problem, the ioLogik will continue to wait for a response from the host. This will cause the TCP port to be occupied indefinitely by the host. On the other hand, if an **idle connection timeout interval** is enabled for Modbus/TCP, then when the ioLogik's connection to the server exceeds a specified time period the device will automatically release its modbus/TCP connection to the server, freeing up the port for a new connection.

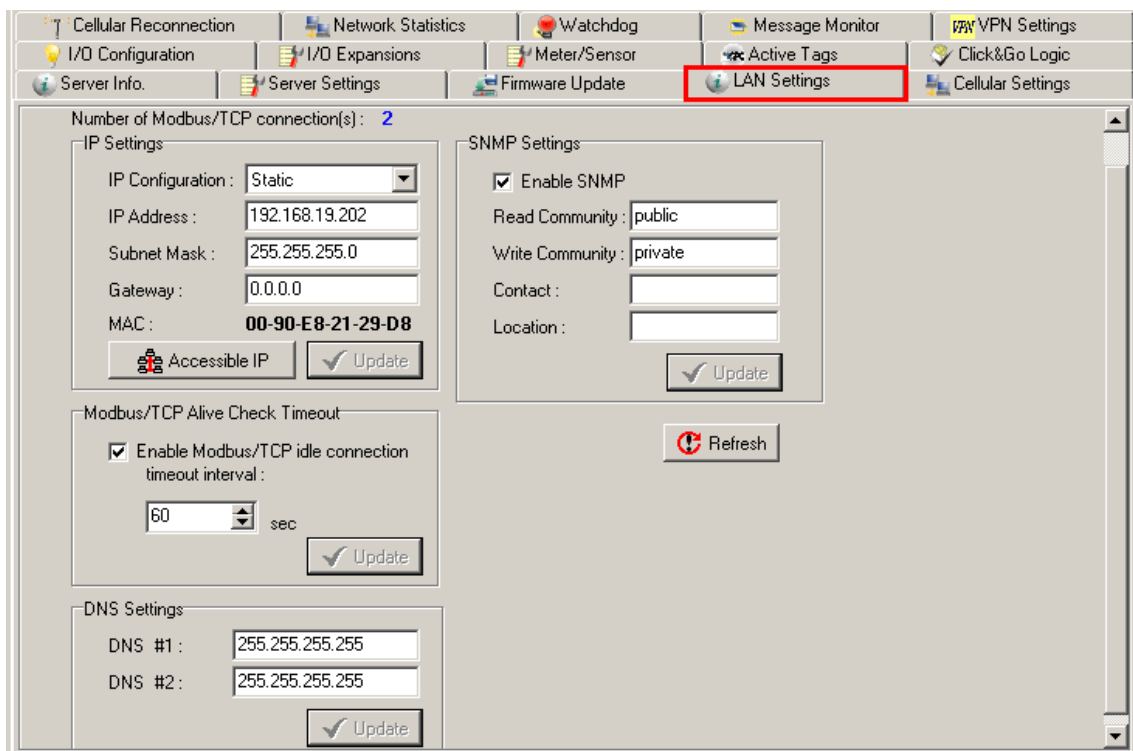

Cellular Reconnection | Network Statistics | Watchdog | Message Monitor | VPN Settings

I/O Configuration | I/O Expansions | Meter/Sensor | Active Tags | Click&Go Logic

Server Info | Server Settings | Firmware Update | **LAN Settings** | Cellular Settings

Number of Modbus/TCP connection(s): 2

IP Settings

IP Configuration: Static

IP Address: 192.168.19.202

Subnet Mask: 255.255.255.0

Gateway: 0.0.0.0

MAC: 00-90-E8-21-29-D8

Accessible IP | Update

Modbus/TCP Alive Check Timeout

Enable Modbus/TCP idle connection timeout interval:

60 sec | Update

DNS Settings

DNS #1: 255.255.255.255

DNS #2: 255.255.255.255 | Update

SNMP Settings

Enable SNMP

Read Community: public

Write Community: private

Contact: | Location: | Update

Refresh

DNS Settings

Use this field to specify the IP addresses of one or two DNS servers. DNS servers can be used to find available e-mail addresses when setting up Click&Go rules. By default, DNS is set to automatic. If you want to configure a specific setting, contact your local cellular provider for details.

SNMP Settings

The ioLogik W5300 supports SNMP v1 and v2c (Simple Network Management Protocol) to monitor network and I/O devices. It is useful for building automation and telecom applications. Use these fields to enable SNMP and to set **read** and **write** strings.

The I/O Configuration Panel

When logged in as administrator, click on the **I/O Configuration** tab and double click on one of the channels listed below to configure that channel's settings. A window for that channel will open, showing the configuration options. After the channel has been configured, click **Apply** to implement the new settings.

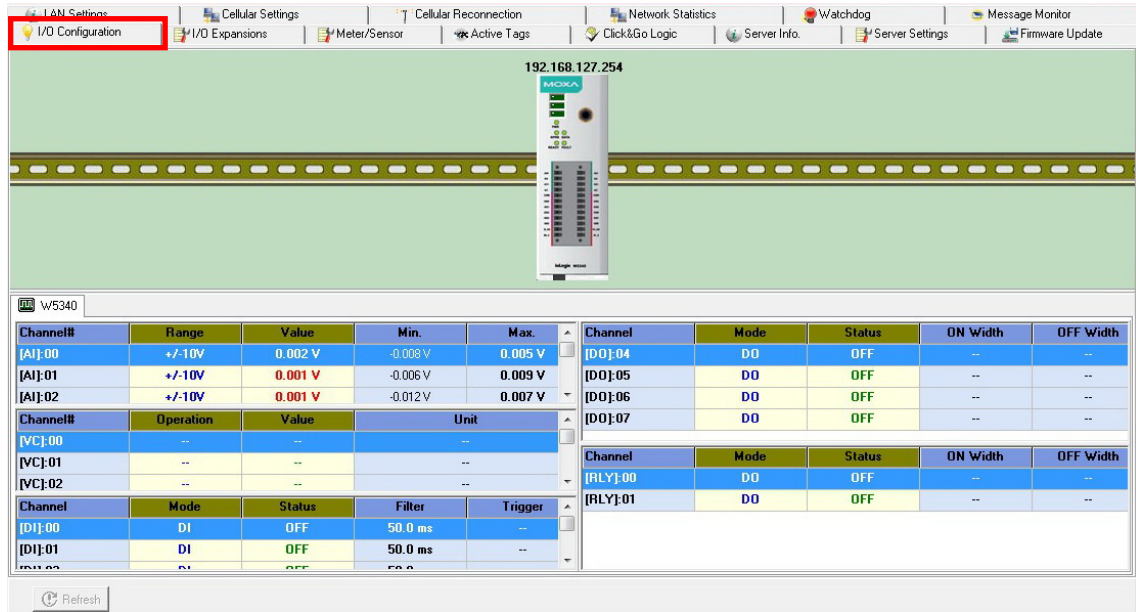

NOTE Right click the window to change the view to show or not show the product picture. **Horizontal View** includes the product picture, whereas **Vertical View** does not show the product picture.

Configuring AI Channels

The ioLogik W5340 and W5340-HSPA are both equipped with 4 AI (analog input) channels that can be set individually to ± 5 V, ± 10 V, 0 to 10 V, 0 to 20 mA, and 4 to 20 mA. You may also set all channels at once using the **Apply to all channels** check box (left figure, below).

Channel#	Range	Value	Min.	Max.
[AI]:00	± 10 V	0.000 V	0.000 V	0.683 V
[AI]:01	± 10 V	0.000 V	0.000 V	0.672 V
[AI]:02	± 10 V	0.001 V	0.000 V	0.001 V
[AI]:03	± 10 V	0.001 V	0.000 V	0.001 V

Alias Name (right figure, below) lets users configure the alias of an AI channel. The alias can be monitored by the ioAdmin utility, or can be queried using either a user-defined program based on the Moxa MXIO library, or a standard Modbus/TCP protocol.

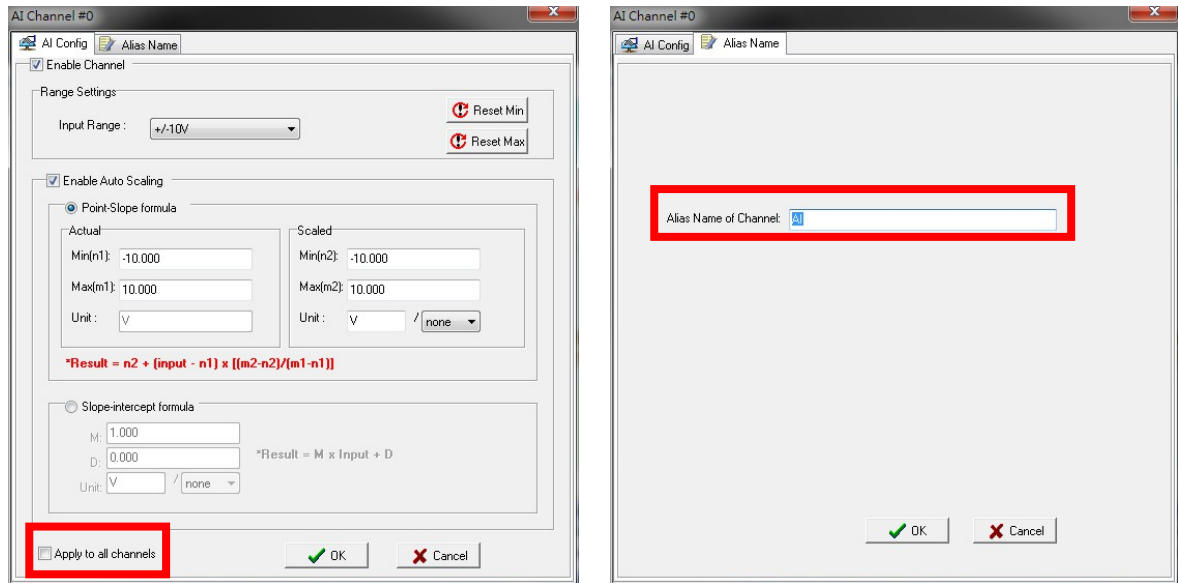

Users can increase the sampling rate on devices using one channel by disabling the unused AI channel by un-checking the **Enable Channel** checkbox, in the upper left corner of the window.

Enabling Auto Scaling will linearly convert the actual current or voltage value into other user defined units, such as percentage or ppm (parts per million)

Two scaling methods: slope formula, and slope-intercept

Auto Scaling with the point-slope formula can help to eliminate high- and low-end extremes. For example, if 17 mA represents the highest allowable temperature, then it is not necessary to allow higher temperature values. You may then cut off any values beyond 17 mA and convert those to a proprietary danger level, such as Level 5.

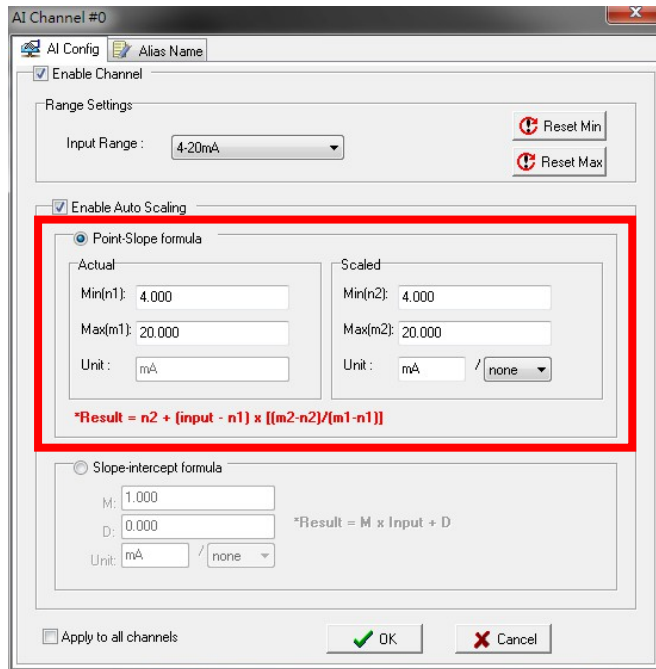

Auto Scaling with the slope-intercept formula provides linear conversion with one ratio (M) and offset (D). Offset can be an initial value of field device. Ratio can help enlarge or reduce the scale by specifying a proportion. It is also easy to modify the values in the database if we need to use new ratio and offset values in the future.

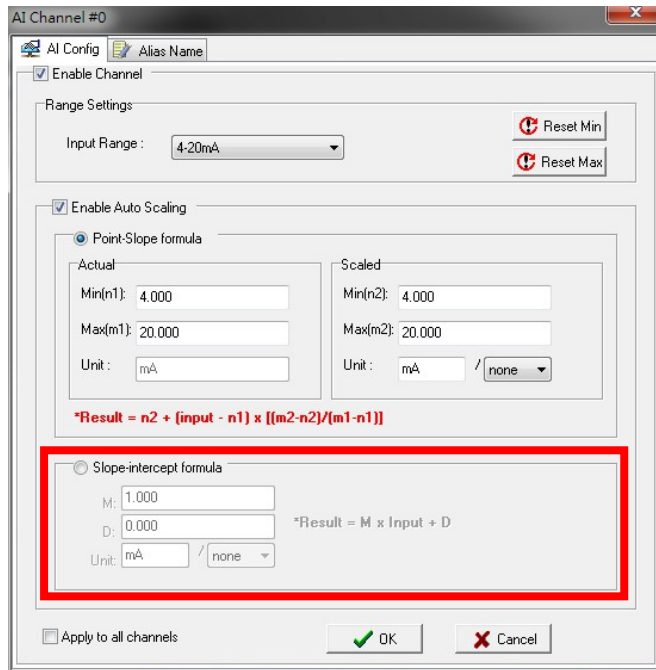

The **Reset Min** and **Reset Max** buttons will clear the minimum or maximum values recorded and displayed in the ioAdmin main window.

Channel#	Range	Value	Min.	Max.
[AI]:00	+/-10V	0.000 V	0.000 V	0.683 V
[AI]:01	+/-10V	0.000 V	0.000 V	0.672 V
[AI]:02	+/-10V	0.001 V	0.000 V	0.001 V
[AI]:03	+/-10V	0.001 V	0.000 V	0.001 V

Configuring Virtual Channels

Channel#	Operation	Value	Unit
[VC]:00	--	--	--
[VC]:01	--	--	--
[VC]:02	--	--	--
[VC]:03	--	--	--
[VC]:04	--	--	--
[VC]:05	--	--	--

The ioLogik W5300 has 10 internal virtual channels to support front-end statistics functions like **Maximum Value (Max)**, **Minimum Value (Min)**, **Average Value**, **Accumulation**, **Instantaneous**, and **Incremental**. The data source is the real I/O channel, such as AI and DI counters, some of which need to be converted to the appropriate time unit. The operation is illustrated below.

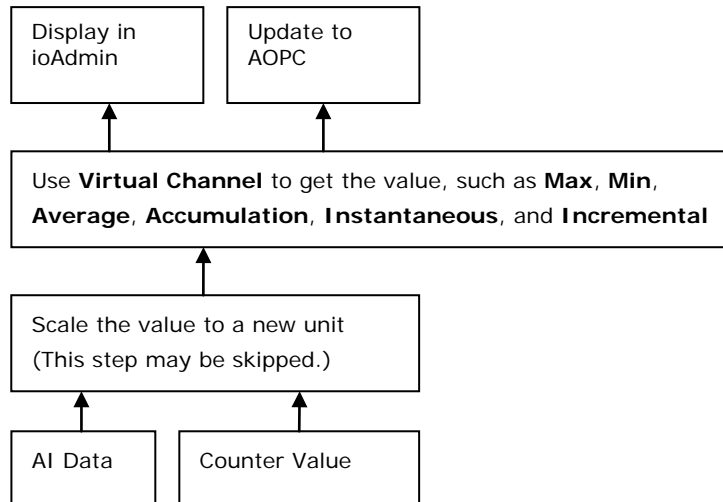

After double-clicking on a virtual channel a popup window will appear (see below). First select the physical source I/O. There are three types: **AI**, **Counter**, and I/O via **Expansion Modules**.

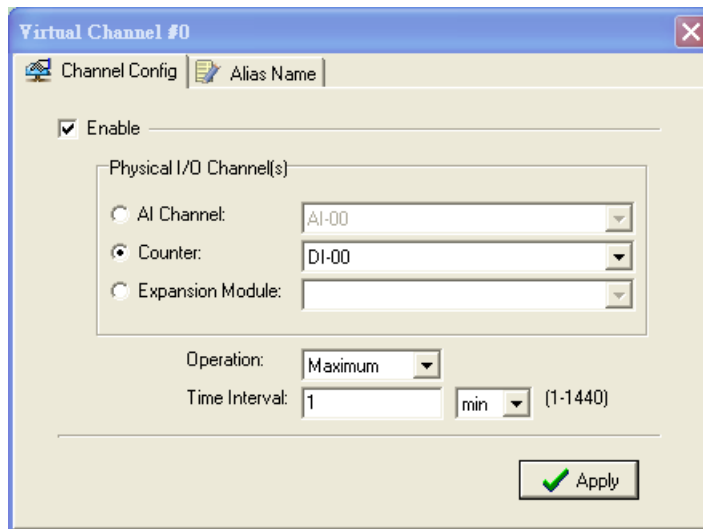

Next, choose the statistics function and time interval. There are six functions: **Max**, **Min**, **Average**, **Accumulation**, **Instantaneous**, and **Incremental**. The time unit can be set to minutes or hours, with a maximum value of 1440.

For example, if you want to monitor the daily flow at a point in a pipeline, you can use a pulse output flow meter where 1 pulse indicates 5 ml. We can set the virtual channel's **scaling function** so that 1 tick of counter input equals 5 ml. Next, we set the **Accumulation** flag, and configure the **Time Interval** to 24 hours. This will set up the virtual channel to log the total water flow volume over a period of 24 hours.

NOTE *Virtual channels are required to configure AI or counter channels.* For counter channels, configure the **Counter Scaling** on the I/O Configuration panel before setting other operations in the virtual channels.

Configuring Digital I/O Channels

Digital I/O channels may be configured for either input or output. When the ioLogik W5300 is turned on, each digital I/O channel will be configured to act as either DI or DO, according to the **Power On Settings**. To switch a channel between input and output, select the desired mode in the **I/O Direction** field under **Power On Settings**. After clicking **Apply**, you will need to restart the ioLogik W5300 for the new setting to take effect.

Channel	Mode	Status	Filter	Trigger
[DI]:00*	DI	OFF	50.0 ms	--
[DI]:01*	DI	OFF	50.0 ms	--
[DI]:02*	DI	OFF	50.0 ms	--
[DI]:03*	DI	OFF	50.0 ms	--

Channel	Mode	Status	ON Width	OFF Width
[DO]:04*	DO	OFF	--	--
[DO]:05*	DO	OFF	--	--
[DO]:06*	DO	OFF	--	--
[DO]:07*	DO	OFF	--	--

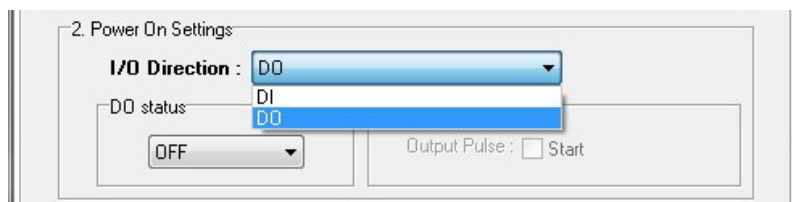

Configuring Digital Input Channels

The ioLogik W5300 can provide up to 12 digital input (DI) channels. To configure software filtering for a channel, set the **Mode** dropdown in section 1 **Mode Settings** to **Filter**. Software filtering is used to avoid switch bounces. The filter is configurable in multiples of 0.5 ms and accepts values between 1 and 65535. For example, a setting of 100 would mean a 50 ms filter (100 × 0.5 ms).

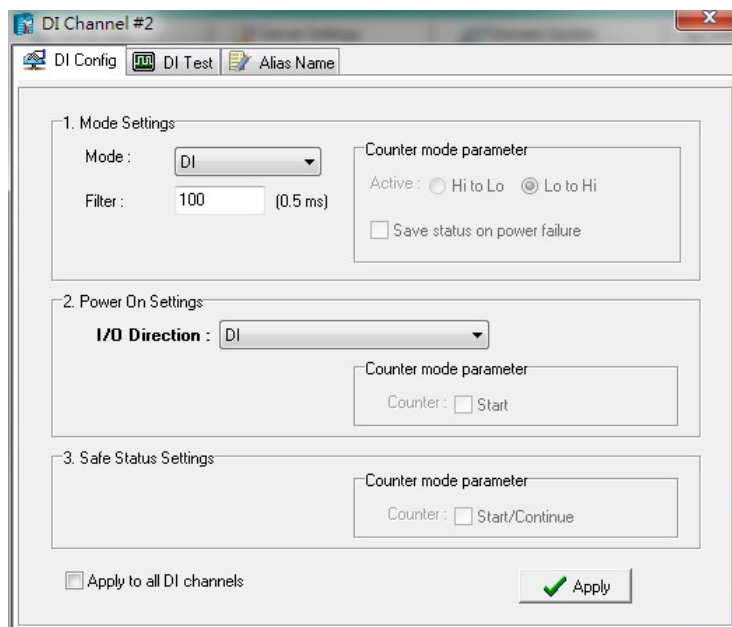

The **Mode** dropdown may also be used to set the channel as straight **Input (DI)**, or as an **Event Counter**.

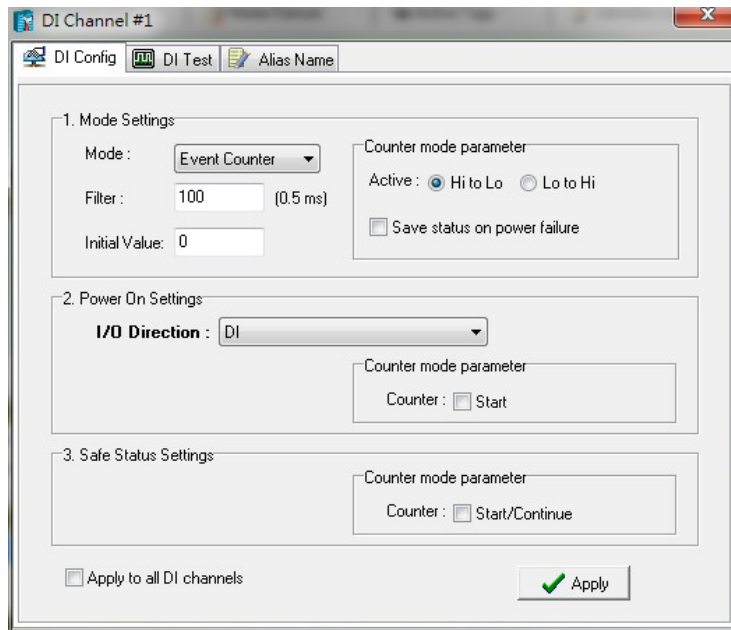

Type	On	Off
Dry contact	Short to GND	Open
Wet contact	0 to 3 VDC	10 to 30 VDC

When set as an **Event Counter**, the channel will accept limit or proximity switches, and will tabulate ON/OFF signal events. When **Lo to Hi** is selected, the counter value increases when an attached switch/circuit is closed. When **Hi to Lo** is selected, the counter value increases when an attached switch/circuit is released. When **Both** is selected, the counter value increases when attached the switch/circuit is successively closed and opened.

Counter Scaling

After configuring a DI channel as an **Event Counter**, an additional **Counter Scaling** tab will indicate how often the counter should be updated during the time unit specified for the virtual channel. For example, if the device is configured to **Update every 5 sec** in the Counter Scaling tab, and the Virtual Channel is configured for **Time Interval = 1 min**, and has **Accumulation** flagged, then as each minute passes this virtual channel will log the total of the last 12 counter updates.

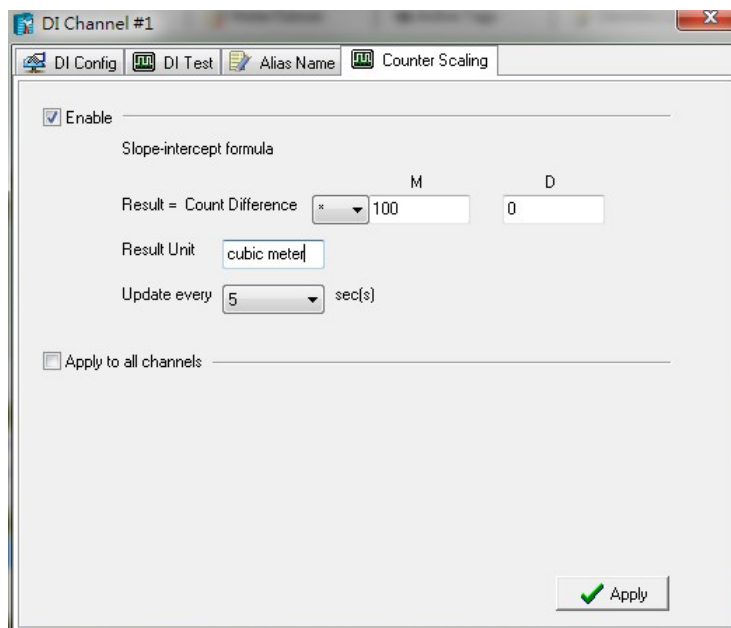

The counter value resets to zero whenever power is disconnected. To make sure the counter value is saved whenever power is disconnected, select **Save Status on Power Failure**. Once power is reconnected the value will remain the same as when power was cut.

To enable the counter to resume counting immediately upon powering up, go to the **Power On Settings** section of the **DI Config** tab. The counter starts logging signals only after configured to do so by a Modbus or a Click&Go command. You can also specify counting to begin automatically whenever the ioLogik is powered on. To configure automatic counting, select **Start** under **Counter mode parameter** in the **Power On Settings**, which is located under the **DI Config** tab within the DI Channel Window.

You can configure how a counter behaves during a network disconnect by navigating to the **Watchdog** panel (click on the Watchdog tab in the main window) and configuring the **Safe Status Settings** and **Host Connection Watchdog**. When the watchdog is enabled, any disconnection from the network will activate a safe state; the counter may be configured to continue counting throughout the safe state by selecting **Start/Continue** (found under the **Counter Mode Parameters**). If **Start/Continue** is not enabled, the counter will suspend counting. If the **Host Connection Watchdog** is not enabled, then **Safe Status Settings** will be ignored and the counter will continue counting during a network disconnection.



ATTENTION

The **Host Connection Watchdog** is disabled by default and must be enabled for **Safe Status Settings** to take effect.

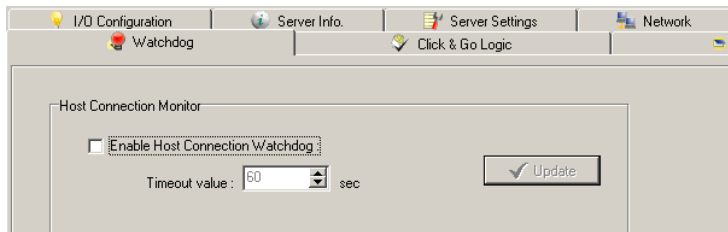

The **Apply to All Channels** option applies all settings to all DI channels on the selected device.

Configuring Digital Output / Relay Output Channels

The ioLogik W5340 and W5340 HSPA can be configured to provide up to 8 digital output channels and 2 relay output channels, while the ioLogik W5312 provides up to 12 digital output channels. All of these channels may be treated as output channels. A DO channel can be set to either **DO** or **Pulse Output** mode.

Channel	Mode	Status	ON Width	OFF Width
[DO]:04*	DO	OFF	--	--
[DO]:05*	DO	OFF	--	--
[DO]:06*	Pulse	STOP	0.5 ms	0.5 ms
[DO]:07*	Pulse	STOP	0.5 ms	0.5 ms

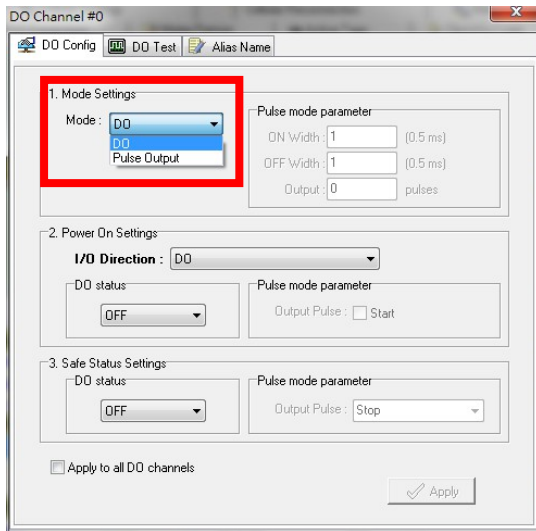

Digital Output Mode

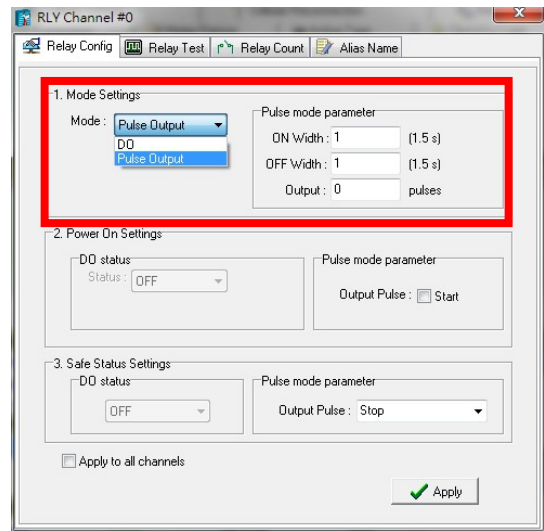

Pulse Output Mode

In digital output mode, the specifications are as follows.

Type	OFF	ON
DO mode	Open	Short

In **Pulse Output mode**, the selected digital output channel will generate a square wave as specified in the pulse mode parameters. The low and high level widths are specified in multiples of 0.5 ms for Digital Output (1.5 s for Relay output), with a maximum setting of 65,535. For digital output, you would enter 1000 for a width of 500 ms. If the OFF width value is 5000 and the ON width value is 5000, the pulse output would be a square wave with a 5-second pulse cycle. You can specify between 1 and 4,294,967,295 pulses; 0 indicates a continuous pulse output.

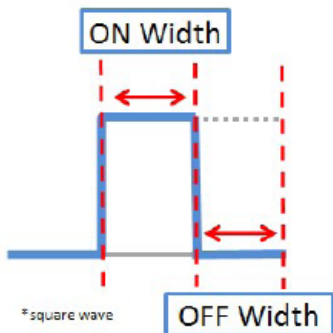

When the ioLogik is first powered on, the status of each DO channel is set to **OFF** by default. This behavior can be modified using the **Power On Settings**, located on the **DO Config** tab. You can set a DO channel to turn **ON** or to commence pulse output whenever the ioLogik is powered on.

Relay Count Monitoring

Two types of relay counts can be recorded in the ioLogik W5340: **Total Counts** and **Current Counts**. **Relay Total Counts** records the total number of times a relay output channel has been triggered in its lifetime. In general, each relay output channel can be used an average of 100,000 times. Users can monitor these counts to see when the module should be replaced, or to switch to a different channel if the total count approaches the upper limit.

Channel	Mode	Status	ON Width	OFF Width
[RLY]:00	DO	OFF	--	--
[RLY]:01	DO	OFF	--	--

Current Counts allows the counter to be reset to zero so that relay triggers may be measured in batches. For example, if RLY-0 is connected to an external relay control board, you can monitor the current counts to see when to replace the external relay component before it fails. **Last Reset Time** records the last time **Current Counts** was reset. Both **Total Counts** and **Current Counts** will be saved when there is a power failure. The **Last Reset Time** will be saved whenever the user manually presses the **Reset to Zero** button.

You can control how a digital output / relay output channel acts when the network is disconnected by navigating to the Watchdog tab in the main window panel and setting the appropriate parameters in the **Safe Status Settings** and the **Host Connection Watchdog** panels. When the **Host Connection Watchdog** is enabled, a network disconnection will activate a **safe state**. The DO channel can be configured to turn on, turn off, or commence pulse output during the safe state. If the **Host Connection Watchdog** is not enabled, then the DO/Relay Output channel status will remain unchanged during a network disconnection.

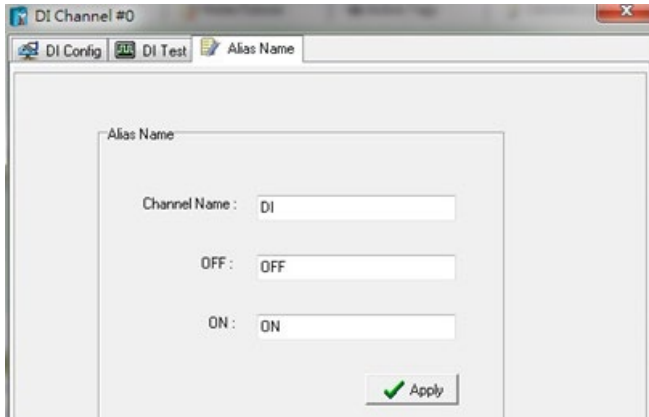

ATTENTION

The **Host Connection Watchdog** is disabled by default and must be enabled for **Safe Status Settings** to take effect.

Testing DI and DO Channels

You can test each channel by opening the channel's configuration window (by clicking on its entry in the I/O configuration panel in the main window) and selecting the **Test** tab.

Digital Input Test:



Digital Output Test:



Use the **Test** panel to see how a channel's status affects or is affected by the attached device. For DO/Relay Output channels, you can set the on/off status or start and stop pulse output. For DI channels, you can monitor the attached device's on/off status, or monitor the counter.

Alias Name

Alias Name helps users configure the alias of a DI or DO/Relay Output channel and define the status for On/Off as Open/Closed or Closed/Open. The alias can be monitored by the ioAdmin utility, and can be queried using a user-defined program based on the Moxa MXIO library, or a standard TCP/Modbus protocol.

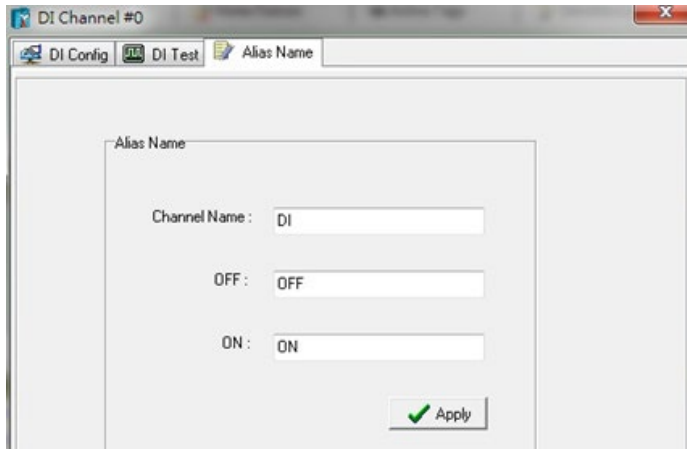

The I/O Expansion Panel

The ioLogik W5300 may be configured to serve up to **three daisy-chained** ioLogik E1200 external I/O expansion units. The ioAdmin utility cannot be used to define signal parameters for the the ioLogik E1200s input and output channels; this must be done by connecting to the ioLogik E1200 using the **ioSearch** utility. However, once the basic signal and channel parameters are defined this hardware configuration may be exported to the ioLogik W5300 and then higher-order logic may be configured using the ioAdmin **Click&Go**, **Active Tags**, and **Data Logging** panels. The maximum number of expansion modules allowed is three.

E1200 expansion units do not need to be directly connected (e.g., they may be connected using a switch), but they must be installed on the same network segment as the ioLogik W5300, or they will not be detected. To configure an E1200 expansion unit for use with the ioLogik W5300, follow these steps:

1. Start ioSearch, and use it to detect your ioLogik E1200 external expansion modules.
2. Configure the signal parameters for each I/O channel.
3. Save the configuration to a file.
4. Use ioSearch to import the configuration file to your local drive.
5. Open ioAdmin, and open the I/O Expansions panel.
6. Load the E1200 configuration file into ioAdmin by pressing the Add button and indicating the filepath.
7. Repeat steps 1 through 6 for any other ioLogik E1200 units you wish to configure.
8. Restart the ioLogik W5300.

After the restart ioAdmin should automatically detect your ioLogik E1200 devices. You may now use ioAdmin's **Click&Go**, **Active Tags**, and **Data Logging** panels to complete the configuration of the I/O expansion units. Once the devices are detected, you should see them listed in the **I/O Expansions** panel as shown below.

The screenshot shows the ioAdmin utility interface. The 'I/O Expansions' panel is highlighted with a red box. It displays the following data:

Slot#	Module	Connection	Description	Status
1	E1210	192.168.19.243	Ethernet Remote I/O(16DI)	online
2	E1211	192.168.19.244	Ethernet Remote I/O(16DO)	online
3	--	--	--	--

* You must restart the device for new change(s) to take effect

Modbus Addresses

Slot#	Channel	Type	Address(hex)	Address(dec)	Quantities
2	DO-10	Coil	0x021A	000539	1
2	DO-11	Coil	0x021B	000540	1
2	DO-12	Coil	0x021C	000541	1
2	DO-13	Coil	0x021D	000542	1
2	DO-14	Coil	0x021E	000543	1
2	DO_15_PULS	Coil	0x02BF	000704	1

* The addresses will be update on next system restart.

The **Slot#** column shown in the I/O Expansion panel will list the ioLogik E1200 units *in the order their configuration files are added*. This means that if you first import the device closest to your ioLogik W5300, that device will be listed as **Slot# 1**. If you then add the E1200 that is most distant from the W5300 (i.e.: the module that is last in the chain), that module will be listed as **Slot# 2**, while the middle device (second in the chain) will be added last, and so listed as **Slot# 3**. To avoid confusion, please make sure that you add the devices in the order that makes the most sense for your topology.

The **I/O Expansion** panel will show the **Modbus Address**; the list of Modbus addresses may be exported to a local file using the **Export** button.



ATTENTION

The following ioLogik E1200 models may be used as external I/O expansion units:

E1210 (16 DIs), **E1211** (16 DOs), **E1212** (8 DIs and 8 DIOs), **E1213** (4DI, 4 source DO, 4 DIO (source DO)), **E1214** (6 DIs and 6 Relays), **E1240** (8 DIs), **E1241** (4 AOs), **E1242** (4 AIs, 4 DIs, and 4 DIOs), **E1260** (6 RTDs), and **E1262** (8TCs).

In addition to the models listed above, all **E12XX-T** models may also be used for external I/O expansion.

Please keep in mind that ioLogik E12000 expansion units can only be used with ioLogik W5300 series using the following firmware versions:

W5312: V1.3 and above; **W5340**: V1.6 and above; **W5340-HSPA**: V1.3 and above

W5340 models with firmware v1.5 can support these 5 models: E1210, E1211, E1212, E1214, and E1240.

I/O Expansion: Step-by-Step

Step 1: Use ioSearch to configure the signal parameters for each ioLogik E1200 I/O channels

First, configure the E1200 device for connection to the network. For details on how to do this, please refer to your ioLogik E1200 Users' Manual. Please note that all expansion modules must reside on the same network segment as the ioLogik W5300.

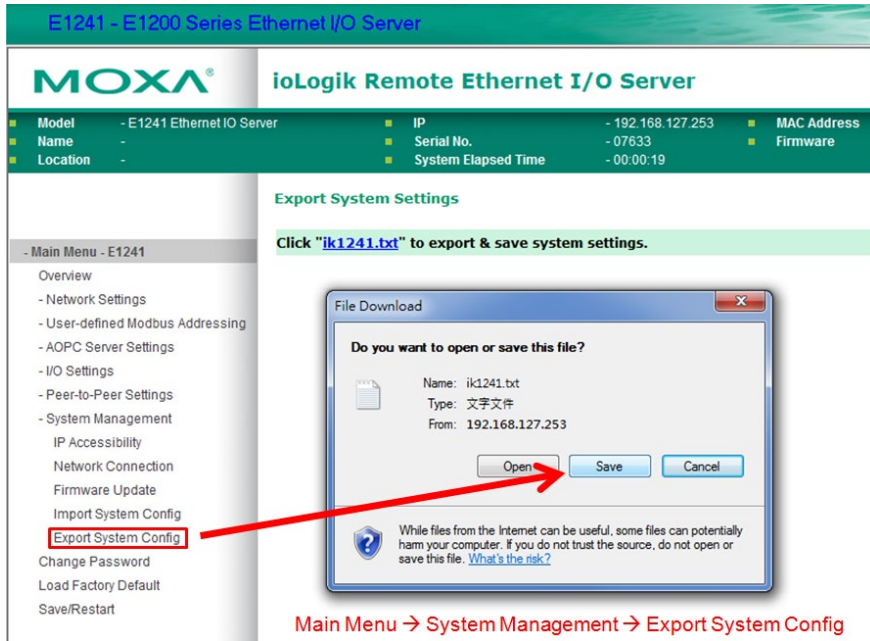

Next, use the ioSearch Utility to detect all available E1200 devices on the network. If you do not have ioSearch installed on your local computer, you may also enter the IP address of a remote E1200 into a web browser to connect the E1200's web console, which will automatically serve the E1200's configuration utility over HTTP. A screenshot of the configuration utility is shown below.

After bringing up the configuration utility you may now use the left menu to navigate the utility and configure signal parameters for the I/O channels. When you are done, save these into the E1200's configuration file.

Step 2: Export the configuration file from the remote ioLogik E1200 to your local host.

You may save the E1200's configuration file on your local machine by using the **Export System Config** button located on the menu at the left of the configuration utility (shown on the screenshot just above).

Step 3: Use ioAdmin to add the configuration file to the ioLogik W5300.

Open ioAdmin and choose the **I/O Expansions** tab. Export the E1200's configuration file to the W5300 by pressing the **Add** button. This will bring up a dialog that will allow you to browse your file system and select the correct filepath.

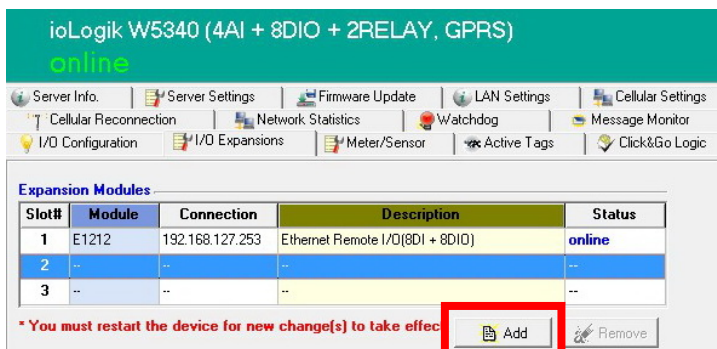

Step 3: Connect the ioLogik W5300 and E1200.

Connect the W5300 to the first E1200 I/O expansion module using an Ethernet cable via the RJ45 port. You may then daisy chain the second and third expansion modules using the E1200's switched Ethernet ports.

Step 4: Restart the ioLogik W5300.

After you have exported the configuration files into the w5300's ioAdmin utility, restart the ioLogik W5300. Open ioAdmin and log in. The ioLogik W5300 and expansion modules will be shown on the screen, with the IP address of a device listed above the device. When you add an I/O expansion module, such as the ioLogik E1210 or E1211, additional tabs will appear, as shown below.

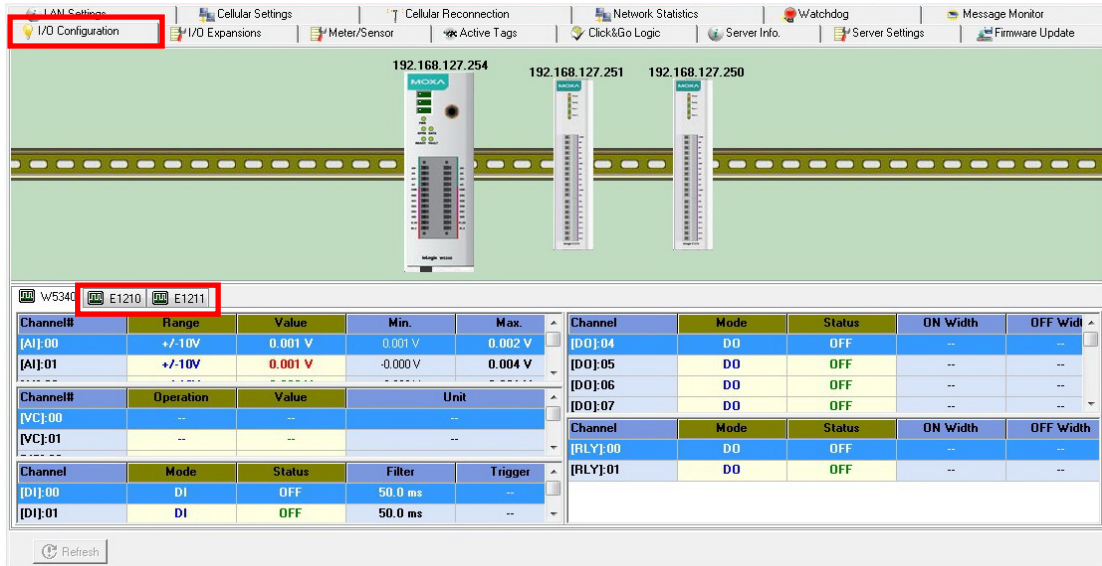

Step 5: Use ioAdmin to configure the higher order logic for the expansion modules.

Click on the **I/O Expansion** tab to check I/O status for individual devices, or to set the alias for a selected I/O channel. You may also use the **Click&Go**, **Data Logging**, and **Active Tags** panels to configure automated behavior and routines for each E1200 I/O terminal.

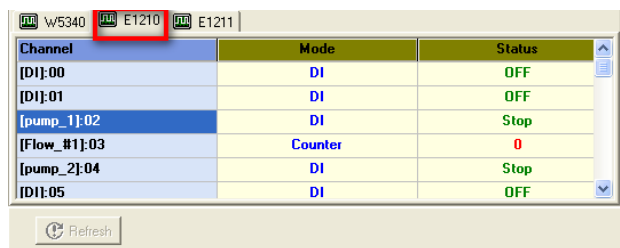

NOTE You cannot configure the E1200's I/O channels using ioAdmin. The configuration must be done with the E1200 configuration tool, either over the web console or using ioSearch.

The Active Tags Panel

When logged in as administrator, fill in the fixed IP address on the **Active Tags** panel to configure address and port settings for Active OPC. The **Active OPC Server Address** may use either an IP address or a URL. The default port number is 9900. The port number should be the same as the one set as the Active OPC Server's **Active Tag Listen Port**. After the OPC and channel tags have been configured, click **Create Tags**. The ioLogik W5300 must be rebooted in order for the settings to take effect.

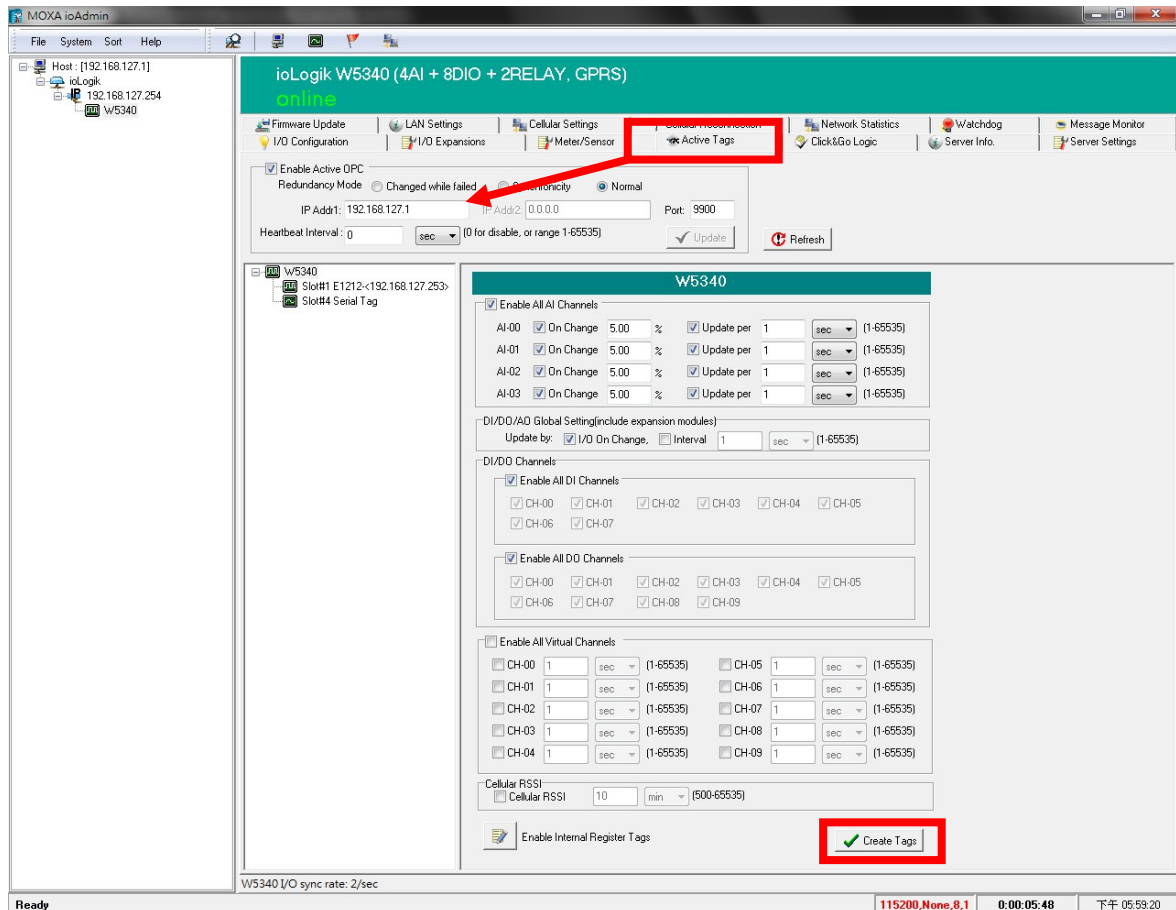

The **Heartbeat Interval** configures the period of time for the heartbeat signal to the AOPC server; this is used to confirm the connection between an ioLogik device and the Active OPC server is live. If the heartbeat interval is set and the network between the ioLogik and Active OPC server is down, the AOPC panel will detect the heartbeat has stopped and will display **BAD** in the **Quality** column to indicate the loss of connectivity.

Setting the heartbeat interval to **0** disables it. When the heartbeat is disabled, the **SysConnect** tag on the Active OPC server will always be 1, indicating that the AOPC server will not know if the connection state is live or dead.

Active OPC: Redundancy Mode

The Active Tags panel offers three AOPC redundancy modes: **Normal**, **Synchronicity**, and **Change while failed**.

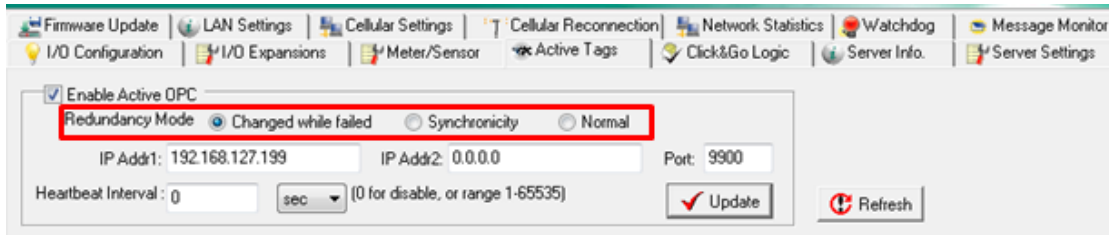

<p>Normal</p>		<p>No redundancy: connects to a single Active OPC.</p>
<p>Synchronicity</p>		<p>Synchronizes with 2 Active OPC servers at the same time.</p>
<p>Change while failed</p>		<p>Tries to connect with the first Active OPC Server IP. If it cannot connect, it will automatically connect with the second IP, and when the connection to the second IP fails, it will switch back to the first IP.</p>

Heartbeat Interval

Tag updates are event-driven, and only change when a configured I/O event occurs; if the status remains unchanged, tags are not updated to Active OPC server, and so the server will not know if a device remains active or has gone down. To remedy this, a heartbeat signal can be used to verify for the AOPC server that the ioLogik device remains active, over a live connection. If a heartbeat is configured and the connection between the ioLogik and AOPC server is broken, the AOPC server will detect that the heartbeat has stopped and then display in the **Quality** column the **BAD** label, to indicate the device is down.

The ioLogik W5300 heartbeat is especially useful for monitoring the connection state over cellular links, to detect when a cellular connection experiences connectivity issues because of low bandwidth.

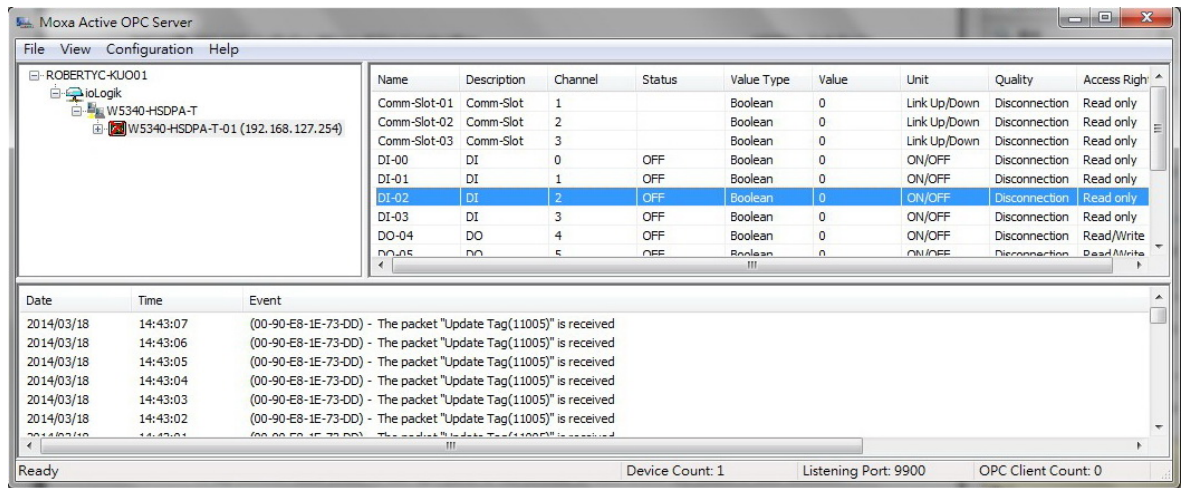

For the W5300 series, we suggest using a value greater than **60 seconds**.

Read/Write Privilege

An input channel can only be read when Active OPC server lists an output channel as read/write. Note that a channel is only read if an output channel was associated in the Click&Go logic tag of that channel.

Active Tags

A tag selection table shown in the right panel of the browser window shows the details of your selection. The I/O status of a channel can be updated to the Active OPC Server once it is changed, or updated periodically.

1. Check the **On Change** checkbox to force an update when there is a signal change for that channel (On-to-Off or Off-to-On for digital channels, or any fractional change for analog channels).
2. To periodically update the status of the Active OPC Server, specify a time interval after the **Update per** checkbox.

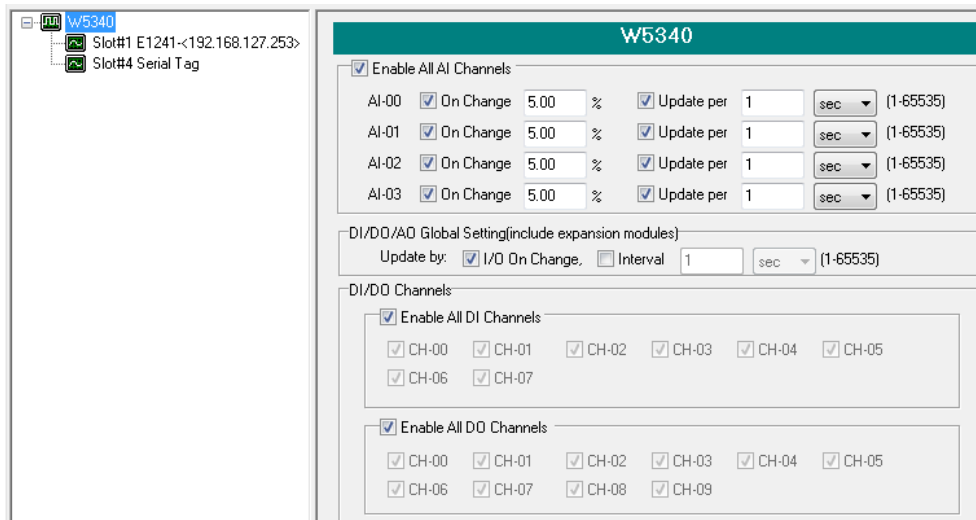

NOTE:

1. A **Virtual Channel** is updated periodically; the time interval for updates can be set to seconds, minutes, hours, or days, with values ranging from 1 to 65535.

2. If AI is configured to update **on change**, the percentage settings represent the percentage of the full analog range. For example, if the AI is configured for 0 to 10 V, **on change 1%** means the ioLogik will update the Active OPC Server every time there is a change of 0.1 V.

3. Expansion modules added to the system are displayed in the modules list. Select a module to see detailed tags in the right panel of the browser window. After selecting the needed tags click the **Create Tags** button. The Active OPC server will receive these updated tags the next time you use Active OPC server.

Refer to the **Active OPC Server** section for more details about how to use Active OPC server.



ATTENTION

1. **Active OPC Setting** should be configured before connecting to the cellular network. If the settings are not configured, the ioLogik W5300 won't connect. When the ioLogik W5300 is in sleep mode, the heartbeat signal will be disabled.
2. The **RSSI** and **Internal Registers** tags require firmware version 1.3 or above for the ioLogik W5312 series, and 1.5 or above for the ioLogik W5340 series.

The Cellular Settings Panel

The Cellular Settings Panel includes:

- **Dial-up Settings**
- **Caller IDs**
- **Operation Modes**
- **DDNS Settings**
- **Port Forwarding Settings**

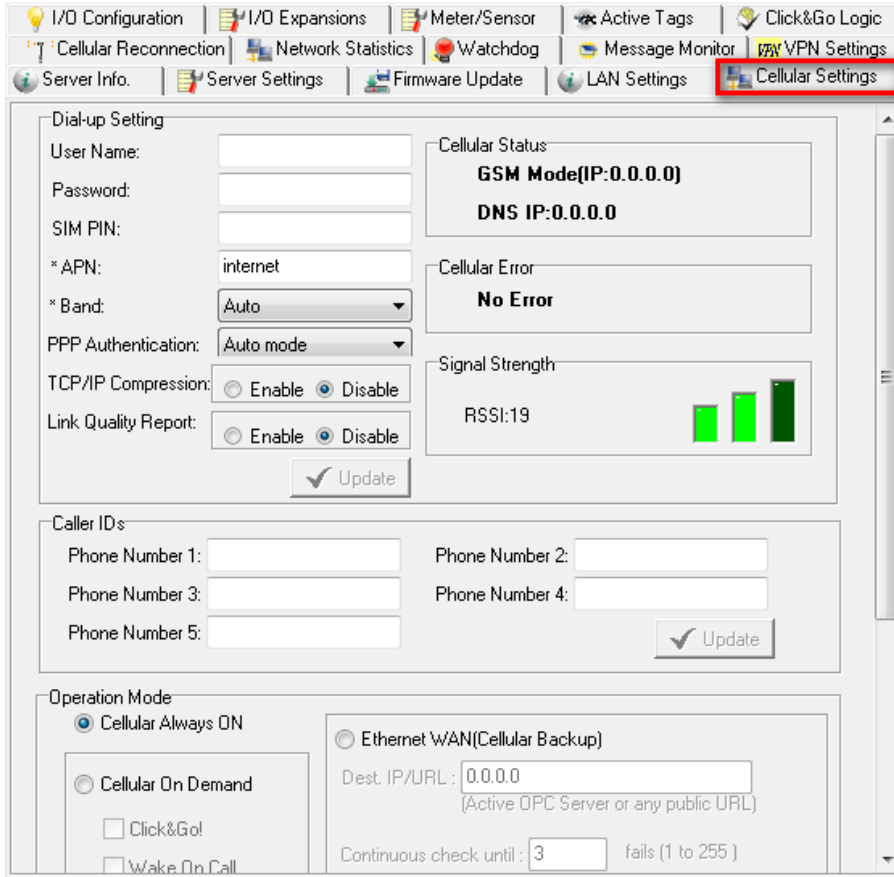

Dial-up Setting

The cellular **Access Point Name**—or **APN**—is a critical field one must configure when connecting a device to a cellular network. Check with your cellular service provider for details. Some cellular connections require more detailed setups, such as **PPP Authentication**, **TCP/IP Compression**, and **Link Quality Reports**, as well.

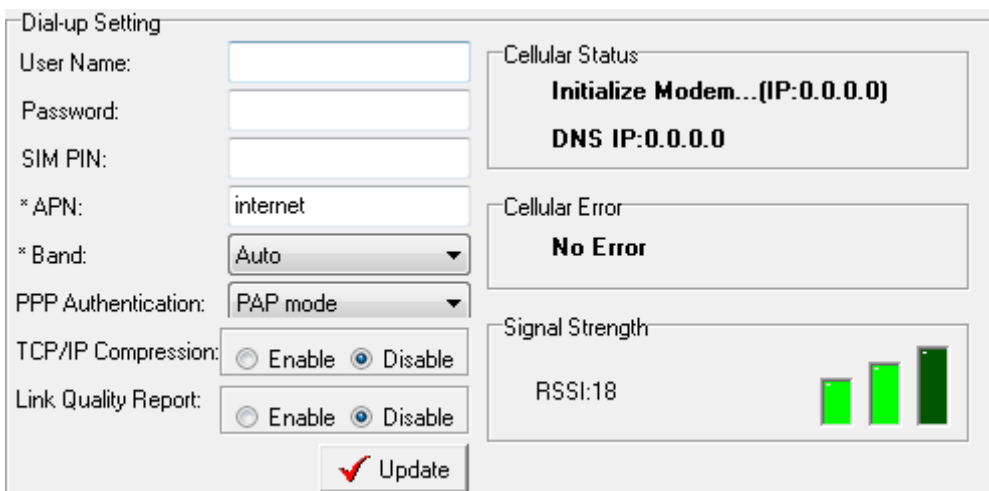

If you already have a PIN configured for your SIM card, be careful to enter it correctly because after three failed attempts you will be locked out. To avoid this problem, the ioLogik W5300 will try to connect to the cellular network one time only. If it fails, then the W5300 will stop trying to connect to the cellular network. You can leave the **username**, **password**, and **SIM PIN** fields blank for most cases because they are seldom used.

After all information has been configured correctly, click **Update**. The ioLogik W5300 must reboot in order for the settings to take effect. Connection information is displayed on the right side of the block, such as Signal Strength (RSSI), Cellular Status, which includes the device's IP address for the Cellular Network, and Cellular Error.

NOTE Band, PPP authentication, TCP/IP Compression and Link Quality Report are only supported on the ioLogik W5340-HSPA.

Caller IDs

In order to use the the ioLogik W5300 cellular wake up feature, you must configure a series of **caller ID** settings. This is because, when the ioLogik W5300 is in **Sleep Mode**, it switches to **GSM standby**; it is only once the ioLogik receives a phone call from an authorized caller ID that the W5300 hangs up the phone, switches to cellular mode, and reconnects to the cellular network. After successfully associating with a cellular access point, the device will forward its new IP address to AOPC server.

Caller IDs

Phone Number 1: Phone Number 2:

Phone Number 3: Phone Number 4:

Phone Number 5:

Operation Mode

The ioLogik W5300 provides two operation modes to connect to a Cellular network, and a network redundancy mode (Ethernet WAN: Cellular Backup).

Operation Mode

Cellular Always ON

Ethernet WAN(Cellular Backup)

Cellular On Demand

Click&Go

Wake On Call

Dest. IP/URL :
(Active OPC Server or any public URL)

Continuous check until : fails (1 to 255)

Retry Interval : (10 to 600 seconds)

1. Cellular Always ON:

The ioLogik W5300 is connected to the cellular network at all times.

2. Cellular On Demand:

This mode allows the ioLogik W5300 to conserve a very low power consumption by flipping into sleep mode whenever there is no need to transmit information. When in **sleep mode**, the ioLogik W5300 disables the cellular connection and stays in GSM standby mode, saving all I/O records in the data log, on the SD card. The ioLogik W5300 will only wake up when either:

- 1) it receives an activate message from Click&Go, or
- 2) it receives a call from an authorized caller ID.

3. Ethernet WAN (Cellular Backup):

The ioLogik W5300 may also be configured with redundant network interfaces, so that it uses cellular networks only as a backup connection. When this mode is selected, the primary interface will be the Ethernet connection, over the Internet. Should this primary interface fail, the ioLogik W5300 will automatically switch to the cellular interface, and then switch back to the primary Ethernet interface when it again becomes available. Note to configure the cellular backup mode, you must specify an IP/URL that the ioLogik will use to test Internet connectivity. We recommend using either large, established sites like Google or Yahoo! to configure this test IP/URL, or using the IP/URL of your own central servers.

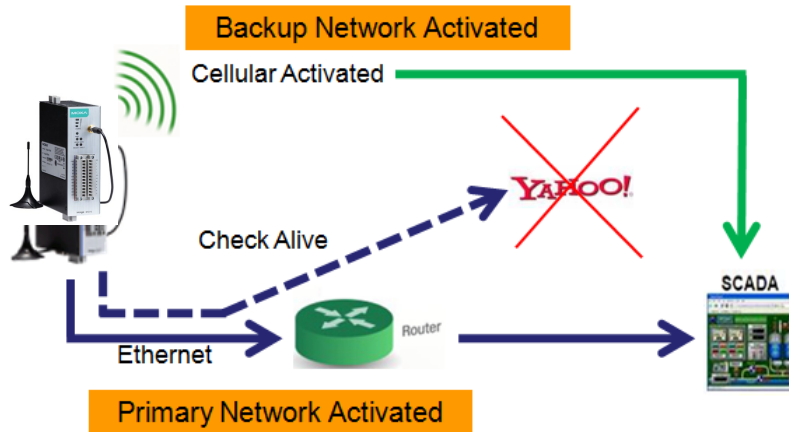

DDNS Settings

If you are unable to configure your AOPC server with a static IP address, you can still configure your network with push communications for edge I/O. To do this, you will configure the ioLogik W5300 with a URL that it can use to register with a dynamic DNS service. This will first require you to register with a DDNS service provider, and enter its information into the **DDNS** function in the ioLogik W5300.

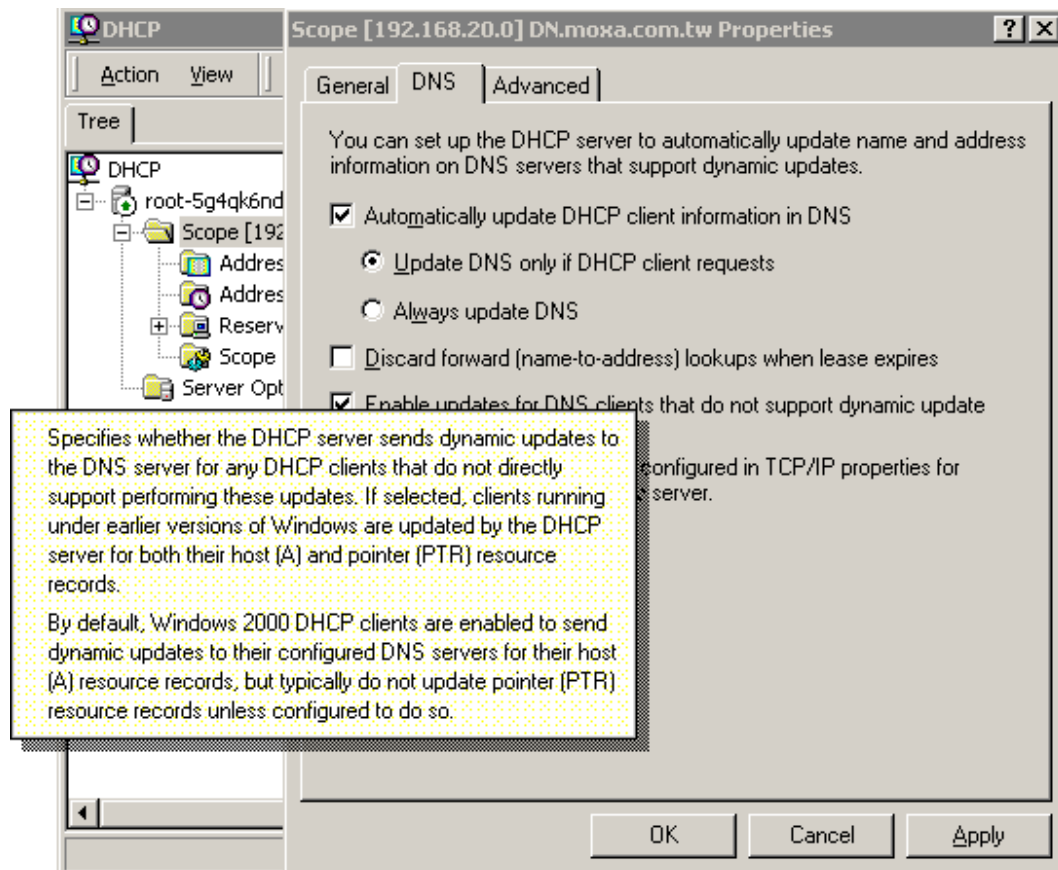

The purpose of DDNS is to provide the customer with an alternative cost effective cellular plan. The customer will not need to establish a server or pay for a Static IP. Setting up DDNS allows the ioLogik W5300 to behave like a server and perform functions such as email, ftp, etc. Regardless of whether the device has a floating IP or a private IP, the user can establish a connection with their remote device through DDNS. DDNS allows the SCADA/HMI server to establish a connection through the DDNS server to find the remote device.

The screenshot at right shows how a device may be set up to use DHCP to update a DDNS server. The screenshot at right gives you an overview of the configuration parameters.

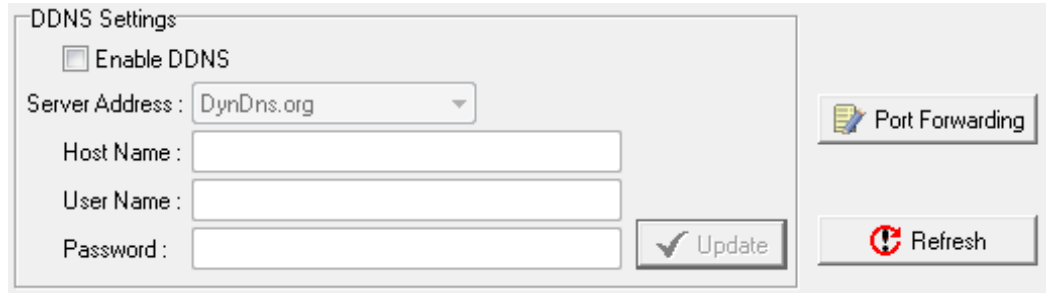

- **Server address** (default=DynDns.org): Currently, DynDns.org is the only option available for Server address.
- **Host name:** Enter the name you created on www.dyndns.com in this field. The ioLogik W5300 will update the DynDNS server with this host name.
- **Username:** This is the user name used for updating DDNS Server authentication.
- **Password:** This is the password used for updating DDNS Server authentication.

NOTE Currently, the ioLogik W5300 supports DNS service as provided by DynDNS. For detailed information on this option, please visit <https://www.dyndns.com>.

Port Forwarding

The ioLogik W5300 supports **port forwarding** on its cellular and Ethernet interfaces for WAN-to-LAN communication. Using port forwarding, the ioLogik W5300 allows external WAN hosts such as SCADA/HMI systems to connect to specific field devices within the LAN by linking with the ioLogik W5300.

Port Forwarding

Index	Active	Protocol	Public Port	Internal IP	Internal Port
00	<input checked="" type="checkbox"/>	UDP	4001	192.168.127.201	80
01	<input type="checkbox"/>	TCP	4001	192.168.127.201	80
02	<input type="checkbox"/>	TCP	1	0.0.0.0	1

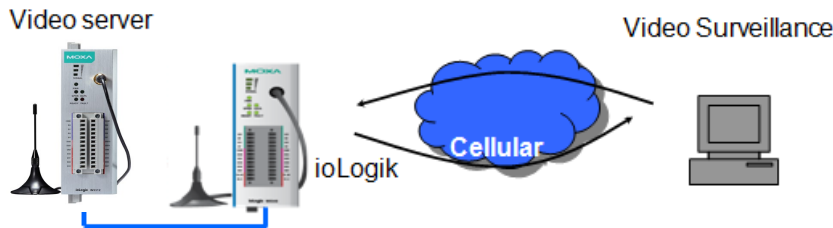

Settings

Setting	Description	Factory Default
Active	Click here to activate a specific Index Channel	Unchecked
Protocol	Choose between TCP and UDP protocols	TCP
Public Port	Refer to the following example	IP: 0 Port: 0
Internal IP		
Internal Port		

VPN Settings Panel (ioLogik W5340-HSPA(-T) only)

What are Virtual Private Networks (VPNs)?

Computers that are part of a VPN use a second, "virtual" IP address to connect to the Internet. Instead of running across a single private network, some of the links between nodes that are part of a VPN use open network connections or virtual circuits on a larger network, such as the Internet. With the help of VPNs, cellular devices acting as a VPN client can initiate a connection with a VPN server. Once the connection is established, cellular devices can communicate with other network devices on the same private network.

ioLogik IPsec/VPN Specifications

- IPsec is an encryption and authentication protocol for IP packets
- In the example below, an encrypted VPN connection is established with a remote VPN server
- ioLogik connects to the server in tunnel mode, using the IPsec protocol suite
- The following encryption ciphers and authentication, authorization, and accounting (AAA) protocols are available using this setup:
 - Manual Key/ESP, IKE/PSK
 - DES/3DES/AES128/AES192/AES256 encryption
 - MD5/SHA1 authentication
 - IPsec NAT traversal, Anti-Replay, and PFS (Perfect Forwarding Secrecy).

Example: Gateway to gateway connection between ioLogik and IPsec servers

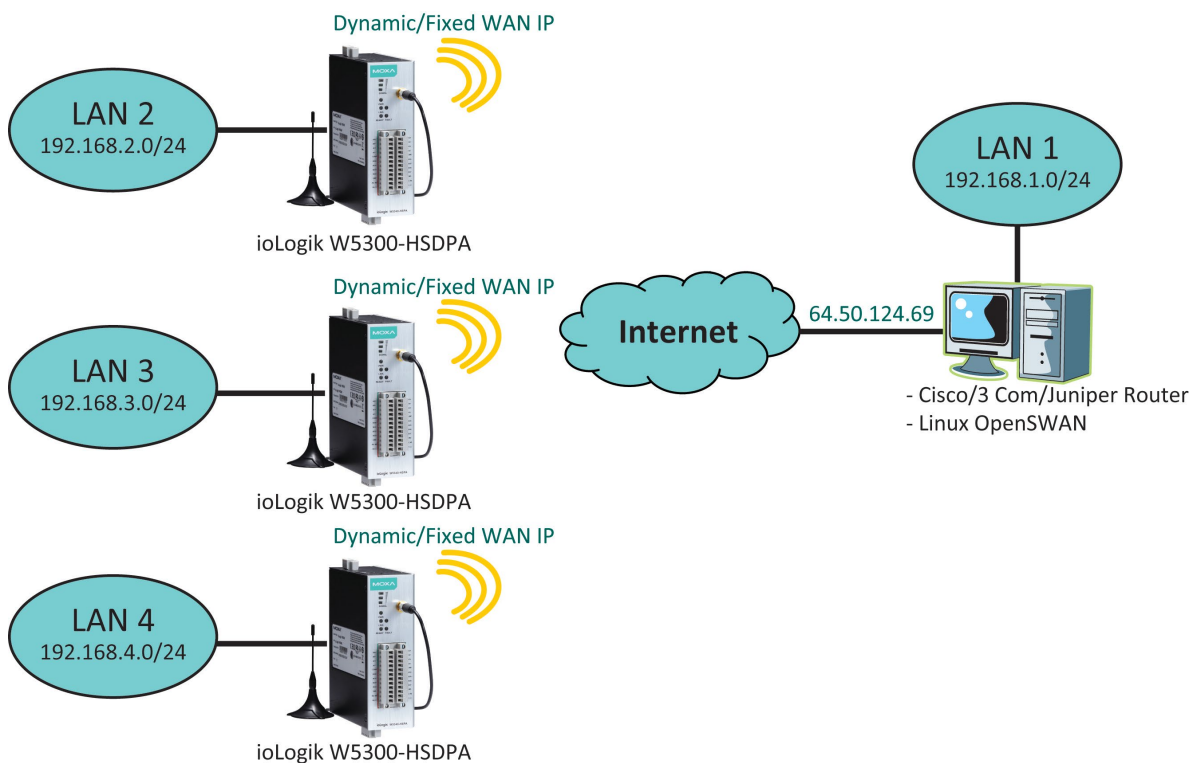

ioAdmin VPN Settings Tab

General Settings

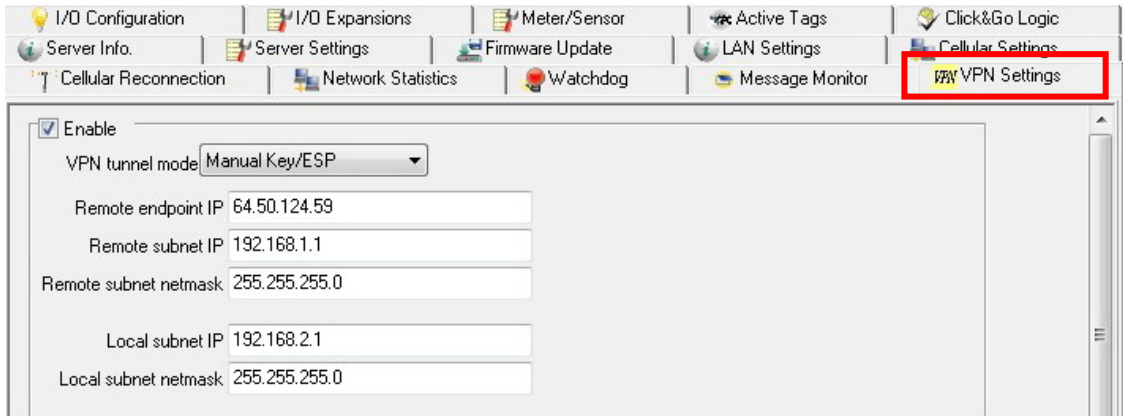

VPN Tunnel Mode: Manual Key/ESP or ISAKMP/PSK selection

Remote Endpoint IP: Enter the WAN IP of the remote VPN server endpoint

Remote Subnet IP: Enter the remote VPN server subnet (LAN) IP of the remote network

Remote Subnet netmask: Enter the remote VPN server subnet netmask of the remote network

Local subnet IP: Enter the ioLogik W5300-HSPA subnet (LAN) IP

Local Subnet netmask: Enter the ioLogik W5300-HSPA subnet netmask

Manual Key/ESP

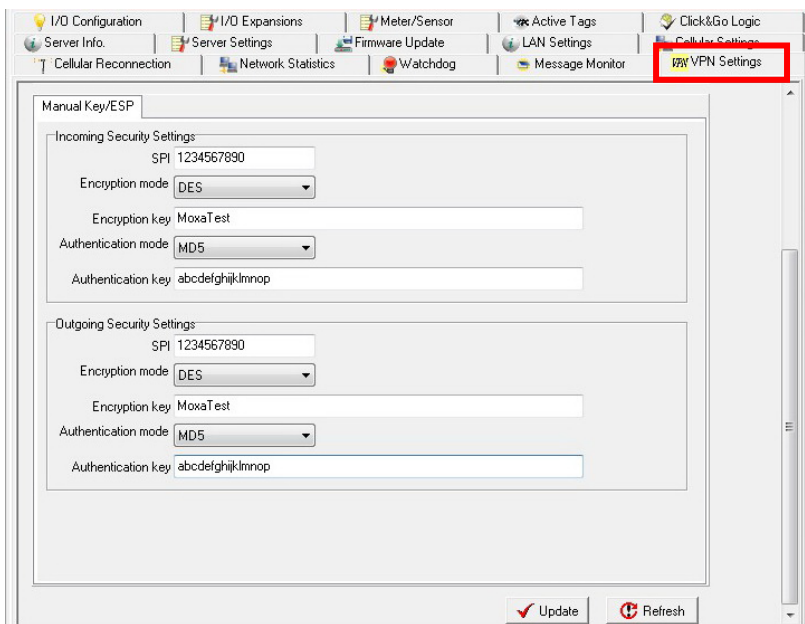

SPI: Sets the VPN manual key incoming/outgoing SPI between 257 and 4294967295

Encryption mode: Selects the incoming/outgoing encryption mode

Encryption key: Enters the incoming/outgoing encryption key

Encryption mode	Length (Bytes)
DES	8
3DES	24
AES 128bit	16
AES 192bit	24
AES 256bit	32

Authentication mode: Select the incoming/outgoing authentication mode

Authentication key: Enter the incoming/outgoing authentication key

Authentication mode	Length (Bytes)
MDS	16
SHA1	20

ISAKMP/PSK

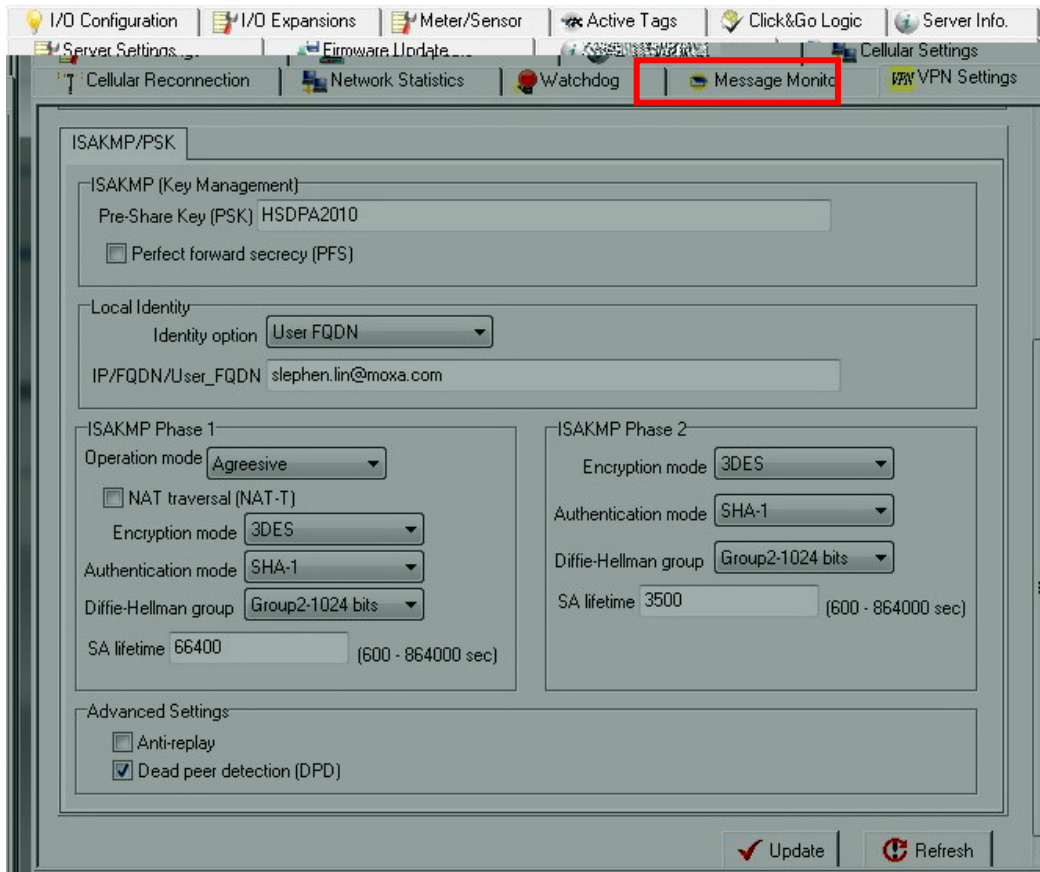

Local Identify

Pre-Share Key (PSK): Sets the VPN ISAKMP Pre-Shared key settings

Perfect forward secrecy (PFS): Enable or disable Perfect Forward Secrecy. PFS is an additional security protocol (default = disable)

Identity option: Select additional ID authentication requirements for the VPN using a specific IP Address, FQDN, or User FQDN settings

IP/FQDN/User_FQDN: Enter an ID (IP/FQDN/User_FQDN) to identify and authenticate the local VPN Endpoint

ISAKMP phase 1

Operation Mode: Select main mode or aggressive mode to configure the standard negotiation parameters for IKE Phase 1 of the VPN Tunnel

NAT traversal (NAT-T): Enabling this option will allow IPsec traffic from this endpoint to traverse through the translation process during NAT. The remote VPN endpoint must also support this feature and it must be enabled to function properly over the VPN (default = disable)

Encryption mode: Select the VPN ISAKMP phase 1 encryption mode

Authentication mode: Select the VPN ISAKMP phase 1 authentication mode

Diffie-Hellman group: Select the VPN ISAKMP phase 1 DH group. Increasing the DH Group number increases the level of encryption implemented for PFS.

SA life time (default = 86400): Enter the number of seconds for the VPN ISAKMP phase 1 Lifetime, which is the period of time to pass before establishing a new IPsec security association (SA) with the remote endpoint.

ISAKMP phase 2

Encryption mode: Select the VPN ISAKMP phase 2 encryption mode.

Authentication mode: Select the VPN ISAKMP phase 2 authentication mode.

Diffie-Hellman group: Select the VPN ISAKMP phase 2 DH group. Increasing the DH Group number increases the level of encryption implemented for PFS.

SA life time (default = 28800): Enter the number of seconds for the VPN ISAKMP phase 2 Lifetime, which is the period of time that passes before establishing a new IPsec security association (SA) with the remote endpoint.

Advanced Settings

Anti-replay: Anti-replay is the method of not allowing an intercepted packet message to be sent to the recipient multiple times without the original sender knowing (default = Disable).

Dead Peer Detection (DPD): Enable or disable the Dead Peer Detection. DPD is a method of detecting a dead Internet Key Exchange (IKE) peer. It sends a DPD packet to the peer every 60 seconds with no traffic and attempts to connect normally. If the DPD packet fails 5 times the VPN will continuously re-establish a connection (default = Disable).

VPN System Log Events and Error Codes

VPN system log	Description
UNLINK_TIME_REACH	SA Lifetime timeout
UNLINK_TIME_OUT	No response from remote VPN server
UNLINK_NO_PROPOSAL	The remote VPN server does not have matched VPN settings(proposal)
UNLINK_DPD	DPD detecting
IKE_PHASE1_MAIN_START	IKE phase1 Main mode starts
IKE_PHASE1_AGGR_START	IKE phase1 Aggressive mode starts
IKE_PHASE1_ENCRY_START	IKE phase1 VPN tunnel encrypting
IKE_PHASE1_OK	Passing the VPN tunnel phase1
IKE_PHASE2_OK	Passing the VPN tunnel phase2
IKE_RENEW_START	Rekeying
IKE_RENEW_OK	Rekey successfully
PHASE1_TIME_REACH	Phase1 SA lifetime timeout
OLD_SA_TIME_REACH	Earlier SA lifetime is deleted by the ioLogik
REMOTE_DEL_ISAKMP	Key of VPN tunnel phase1 is deleted by the remote
REMOTE_DEL_ESP	Key of VPN tunnel phase2 is deleted by the remote
REMOTE_DEL_ESP_OLD	Earlier SA lifetime is deleted by the remote VPN Server

NOTE Since there is a limit to the number of times you can write to system memory, we strongly recommend installing at least a 1 GB SD that the ioLogik W5300 can use for logging.

Cellular Reconnection

Carriers disconnect idle mobile device connections in order to save bandwidth for other on-line users and applications. To keep the ioLogik W5300 **Always On**, the ioLogik W5340 must not only have the capability to detect the cellular connection and reconnect to the network once it is disconnected, but also needs to send out signals (ICMP package) to notify carriers that the ioLogik W5340 is still alive.

The screenshot shows the 'Cellular Reconnection' configuration window. The 'Cellular Reconnection' menu item in the top navigation bar is highlighted with a red box. The main content area contains several sections:

- Carrier check before system restart** (checked):
 - GSM Timeout: 30 (30 to 65,535 seconds)
 - GPRS Retry: 3 (3 to 65,535, 10 to 30 seconds per retry)
- PING check before system restart** (checked):
 - Dest. IP/URL: 125.227.129.167 (Active OPC Server or any public URL)
 - Auto Retry: 3
 - Continuous check until 3 fails (selected)
 - Retry Interval: 10 (10 to 600 seconds)
- System Reconnect after** 1 hours (1 to 24):

If the wireless signal is unstable and disconnects, the ioLogik W5300 will first reboot the modem to restore the physical layer connection. Enable "System Reconnect" to reinitiate the W5300. If rebooting the modem does not recover your connection, the disconnection may be caused by a higher layer communication problem.
- Network Log** (checked)

An 'Update' button is located at the bottom right of the configuration area.

NOTE The default setting of the Cellular Reconnection function is **disabled**, which prevents it from producing extra packets. If the Cellular Operation Mode is set to **On-Demand**, we recommended *NOT* activating the Cellular Reconnection function.

Carrier Check before system restart: Carrier Check settings define the timeout for detecting the physical cellular connection. Once the ioLogik reaches the timeout, it will perform a system restart.

- **GSM Timeout:** When you turn on the ioLogik W5300, the device will continue to connect to the GSM for a period of 60 seconds (the default setting). If it fails to connect, the device will automatically restart the modem board after sixty seconds.
- **GPRS Retry:** After the connection between the device and GSM (carrier) has been made. The device will try to connect with the Internet. After XX time of failed retry, the W5300 will restart the modem board.

The Chart below shows the Carrier Check behavior:

PING Check before system restart: A remote destination is used in this setting to indicate if the Internet connection is still alive. The user can specify a public IP or URL and the number of retries that are allowed.

- **Dest IP/URL:** Can either be an AOPC server IP or any public URL for the device to check its connection with the internet.
- **Auto Retry:** Will be activated when the AOPC can't connect with the AOPC server. The W5300 will tell the machine to ping the Dest IP/URL to check for an Internet connection.
- **Continuous Check Until 3 failures:** The W5300 continuously check its connection with the IP/URL to ensure that it is constantly connected to the internet (could incur a high cose, depending on your cellular plan).
- **Network Log:** The Network Log records the activity of the cellular connections. Click the **Export Log** button to retrieve the log file.

System Reconnect after ____ hours

- If **Carrier Check before system restart** or **PING Check before system restart** is selected, the system will check if there is still a wireless connection.
- If the wireless signal is unstable and disconnects, the ioLogik W5300 will first reboot the modem to restore the physical layer connection. Enable **System Reconnect** to reinitiate the W5300. If rebooting the modem does not recover your connection, the disconnection may be caused by a higher layer communication problem. You may select a **System Reconnect** interval from 1 to 24 hours.

Meter/Sensor

OP Mode

The ioLogik W5300 supports four OP modes, **Transparent Serial Tunnel (TCP Server and TCP Client)**, **Modbus TCP <-> Modbus RTU Gateway**, and **Modbus Serial Tags**.

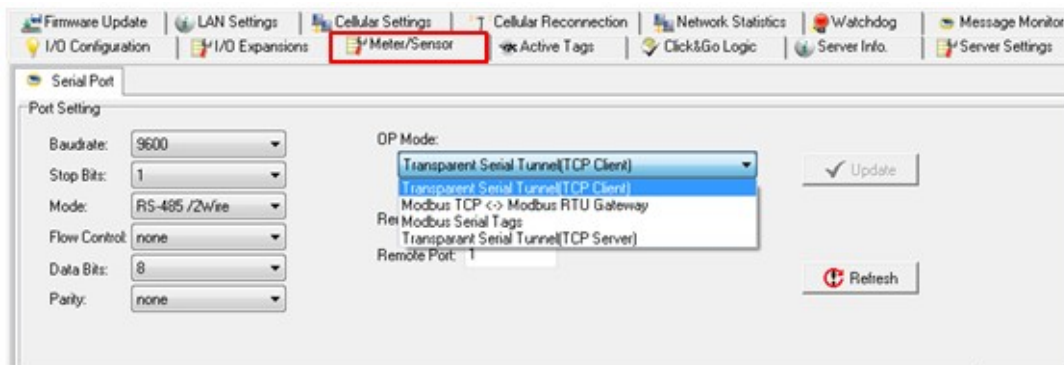

- **Transparent Serial Tunnel:** Transparent Serial Tunnel mode creates a TCP socket to a remote host program and transparently sends and receives data to attached legacy serial devices.

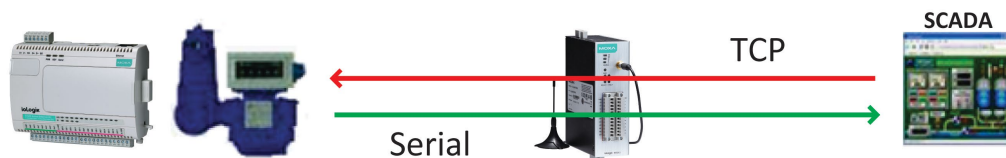

- **Modbus RTU Gateway:** This function allows users to attach a serial Modbus/RTU meter to the ioLogik W5300's serial port; in this case, the ioLogik W5300 will act as a Modbus/RTU to Modbus/TCP gateway.



- **Modbus Serial Tags:** This function allows users to attach a serial Modbus/RTU meter to the ioLogik W5300's serial port and create the serial tags in the Active OPC Server so that a SCADA system can access this serial data directly via OPC connections. In this case, the Modbus/RTU serial devices will appear to be embedded in the ioLogik W5300.



ATTENTION

If the Serial Tunnel setting is used, **Cellular Setting → Operation Mode → Cellular** should be set to “Cellular Always On.” Otherwise, the Cellular connection will disconnect and a serial tunnel will not be created.



ATTENTION

Because there are major structural differences between firmware versions, you should upgrade from earlier versions to firmware V1.3 or above for the ioLogik W5312 series, and V1.5 or above for the ioLogik W5340 series to reset all settings to the factory defaults. You should NOT perform the upgrade remotely over the Internet.

Network Statistics

Network Statistics help monitor the usage of all applications' network flow. The applications include Active OPC server, active message server, serial TCP, SNMP trap, Email, FTP, Modbus, DA Center, Event Log, and ICMP.

The Network Statistics Page will help you understand the overall usage of the network.

Application	Network Tx (%)	Network Rx (%)
Active OPC Server	0.0	0.0
Active Message	0.0	0.0
Serial TCP	0.0	0.0
SNMP Trap	0.0	0.0
Email	0.0	0.0
FTP	0.0	0.0
Modbus	100.0	100.0
DA-Center	0.0	0.0
Event Log	0.0	0.0
ICMP	0.0	0.0

Watchdog Panel

The **Watchdog** panel is available after you log in as administrator. When enabled, the **Host Connection Watchdog** monitors the network connection. If the connection is lost for the specified **Timeout Value**, the watchdog will display a warning and activate the **Safe Status** settings for each DO channel and event counter channel. By default, the watchdog is disabled. To enable the watchdog, make sure that **Enable Host Connection Watchdog** is checked, set the **Timeout Value**, and then click **Update**.

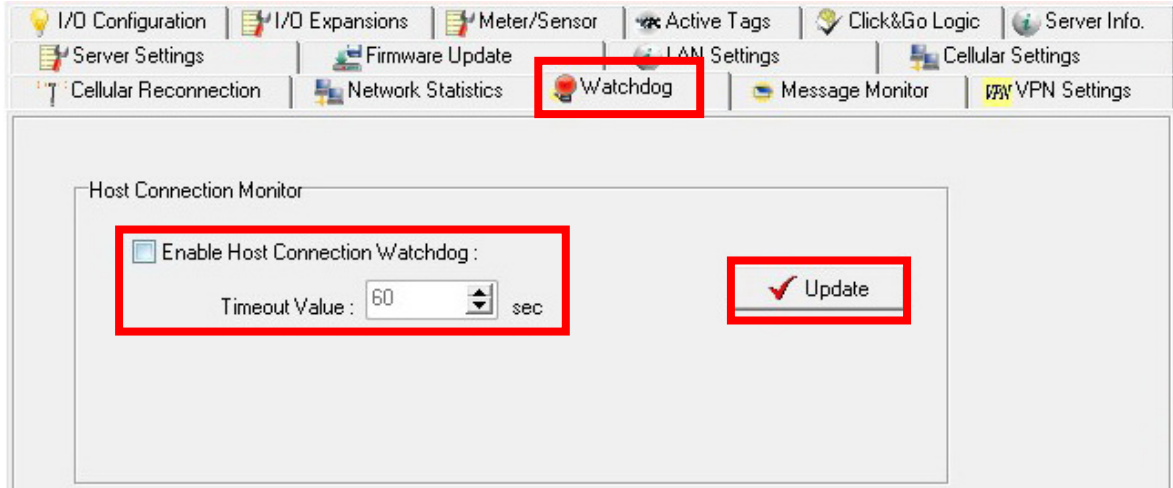

After the watchdog is enabled, a warning will be displayed on the **Watchdog Panel** if the network connection is lost.

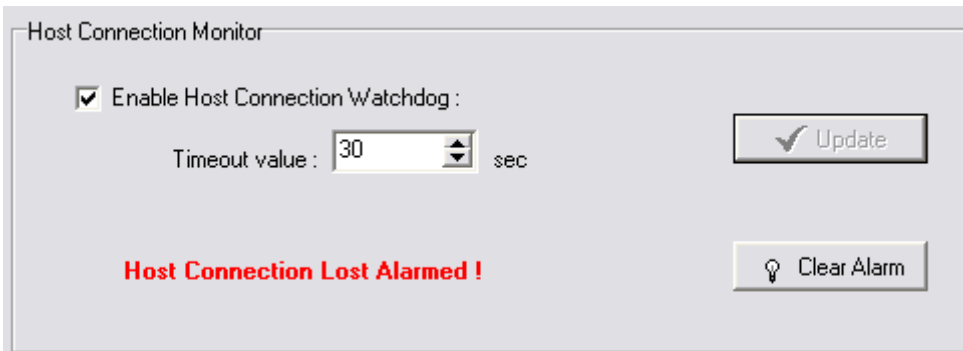

After you restore the network connection, click **Clear Alarm** to reset the Watchdog and return to normal operation.

Click&Go Logic Panel

The Click&Go Logic panel is available after logging in as an administrator. This is where the ioLogik W5300 is configured. With a set of rules (known as a ruleset) defined through Click&Go, the ioLogik can report I/O status to a host as soon as user-defined I/O conditions have been met. **Refer to Chapter 4 for more detailed information on defining rules.**

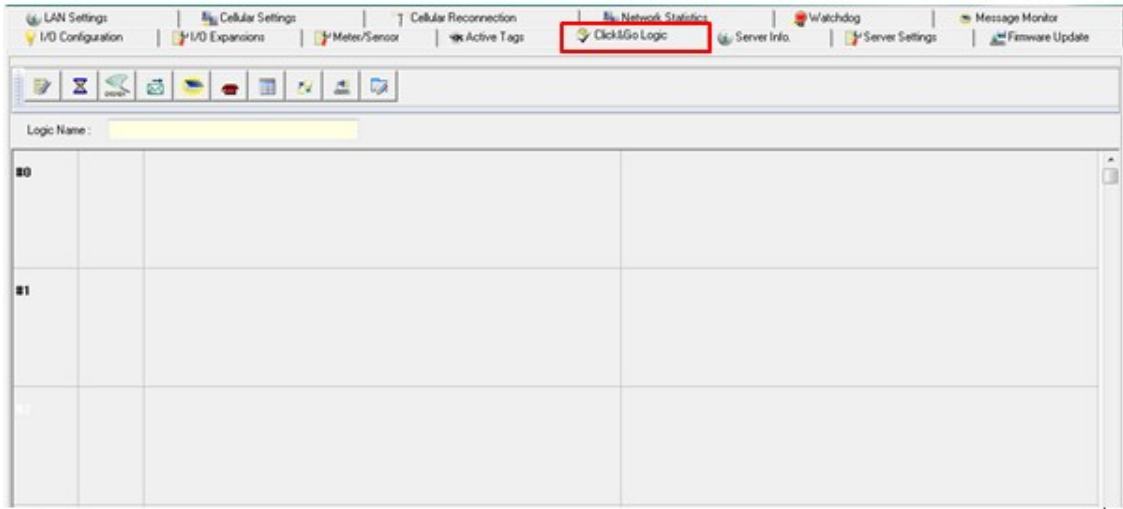

Changes on the Click&Go Logic panel are not effective until the ioLogik W5300 is restarted, as is true with changes made on other panels. After logging back in as administrator and returning to the Click&Go Logic panel, click **Download** to view the current ruleset. Click **Run** to activate the ruleset and **Stop** to deactivate it.

NOTE Refer to the following website to learn more about Click&Go: http://www.moxa.com/remote_io/ClicknGo.htm



ATTENTION

I/O channels used by Click&Go Logic **cannot be controlled externally** using ioAdmin's "Test" function, other Modbus/TCP master software, SCADA software, or SMS commands.

Click&Go Logic was developed by Moxa to provide an easy way to program your ioLogik W5300. In this chapter, we explain how Click&Go Logic works and how to use it to deploy a remote I/O solution.

The following topics are covered in this chapter:

❑ To Get a Quick Start...

❑ Overview

- Features
- Click&Go Logic Basics
- Working with the Rules

❑ Click&Go Development Process

❑ I/O Configuration

- Configurable DIO Channel Mode Selection
- Digital Input Mode Selection
- Digital Output Mode Selection
- Analog Input Mode Selection
- Alias Configuration
- Testing the I/O Channels

❑ Defining Global Variables

- Internal Register (Integer) Settings
- Timer Settings
- SNMP Trap Server
- E-Mail Server
- Active Message Server
- SMS Phone Book
- Working/Off Working Days
- FTP Settings
- Data Logging Profile List
- Internal Register (Float) Settings

❑ Working with Logic

- Click&Go Logic Basics
- IF...THEN/ELSE Conditionals
- THEN/ELSE Actions

❑ Activating the Rule-set

- Upload, Restart, and Run
- Rule-set Management Bar

❑ Import/Export Configuration

To Get a Quick Start...

Below, we highlight a series of entries to provide a quick review for readers already familiar with Click&Go.

I. Overview

- [Software Overview](#)
- [Click&Go Logic Basics](#)
- [Working with the Rules](#)

II. Getting Started

Quickly set up your I/O and global variables so you can start working with rules:

- [I/O configuration](#)
- [Defining Global Variables](#)

III. Start Working with the Logic

Learn the basics of Click&Go's If-Then-Else Logic:

- [If Logic](#)
- [Then and Else Logic](#)
- [Active Rule Set](#)
- [Import and Export Your Configuration](#)

Overview

The ioLogik W5300 series system eliminates the need for host computers to continually poll I/O devices for their status. Instead, the server itself is able to monitor the status of each I/O device and take the appropriate action when the I/O status satisfies a user-defined condition. For example, the ioLogik could be configured to send a TCP/UDP message only when the switch attached to DI-0 is turned on. This event-based structure results in a much improved response time and a much reduced load on the host computer's CPU and network bandwidth.

The ioLogik W5300 supports Moxa's Click&Go Logic. With Click&Go Logic, you can easily and intuitively configure when and how I/O information is transmitted over the network. Simple **IF-Then-Else** statements are used to specify conditions that are required for certain actions to take place. Up to three conditions and three actions can be combined in a rule, and you can define up to 24 rules. Supported actions include sending SNMP traps or TCP/UDP messages to up to 10 hosts at a time.

Click&Go Function Comparison Table by Product Line

Click&Go Function	ioLogik E2000	ioLogik W5300
Peer-to-Peer	Yes	No
Remote Action	Yes	No
CGI Command	Yes	No
Trigger Logic		
IF-Then-Else rule	24 rules	24 rules
Internal Register	24	24 + 28 float points
Timer	24	24
Schedule	Yes	Yes
Alarms		
TCP/UDP Active Message	Yes	Yes, Unicode support
SNMP Traps	Yes	Yes
E-Mail	Yes	Yes, Unicode support
SMS	No	Yes, Unicode support

Features

Click&Go Logic has the following key features:

- Easy local logic control using intuitive **IF-Then-Else** style construction.
- Up to 24 user-defined rules.
- Up to 3 I/O-based conditions and 3 DO or network actions per rule.
- Choice of email, TCP, UDP, SNMP trap, and SMS for active I/O messaging.
- Customizable message content with dynamic fields for time, date, IP address, and more.
- Up to 10 simultaneous IP destinations for TCP/UDP messaging.
- Internal register function for remote output control when Click&Go is running.
- Timer Delay function for timing events.
- Configurable interval for time-triggered events.

NOTE In this chapter, all the descriptions are based on the ioAdmin 3.10. Be sure to use firmware V1.3 or above for the ioLogik W5312 series, firmware V1.5 or above for the ioLogik W5340 series, and Active OPC Server V1.11 or above.

Click&Go Logic Basics

To use Click&Go Logic, start ioAdmin and log on as an ioLogik administrator on the Server Settings panel. Once you are logged on, go to the Click&Go Logic panel. It should appear as below:

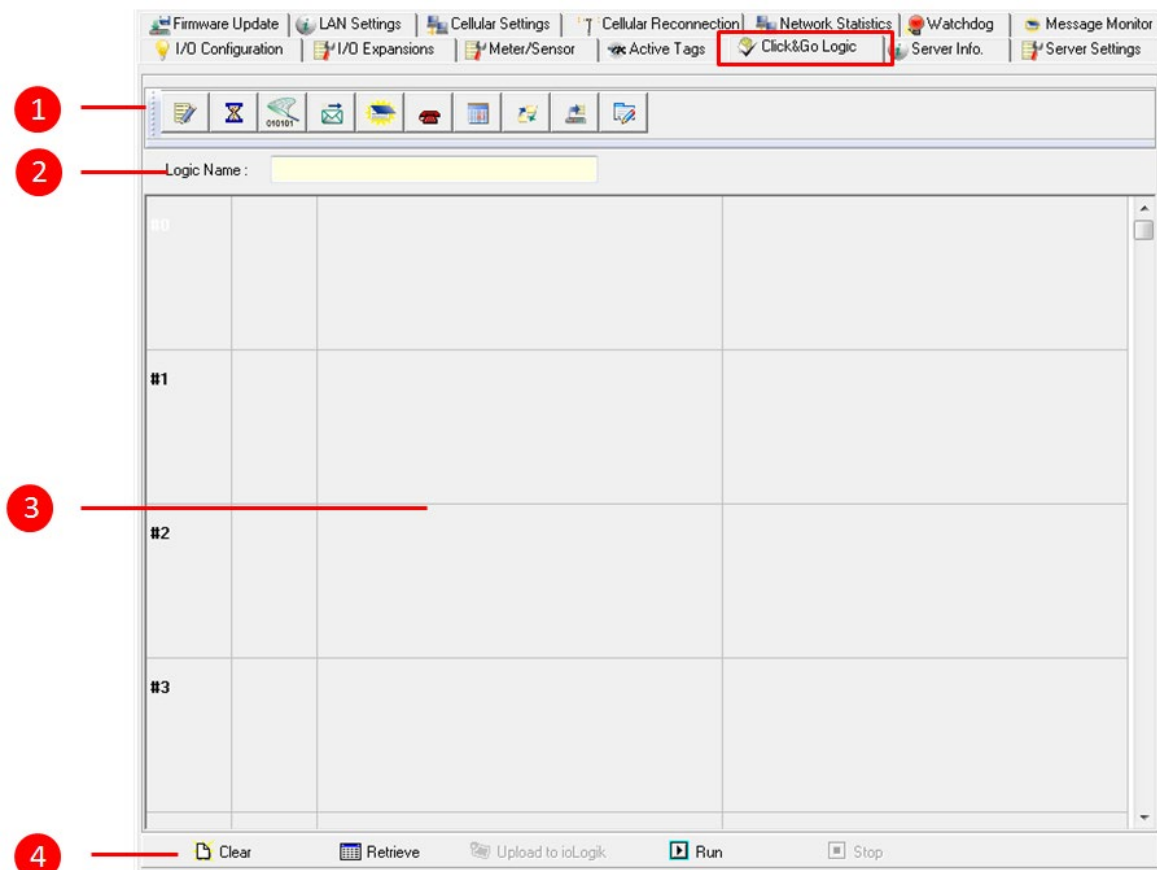

Click&Go Logic Panel

1. Global Variable: In this field, you can assign a Global Variable for the set of rules.
2. Logic Name: In this field, you can assign a name for the set of rules.
3. Rules List: In this area, each rule's conditions, actions, and status are displayed.
4. Ruleset Management Bar: In this area, you manage the ruleset.

Working with the Rules

Rules are the building blocks of your ioLogik W5300. With rules, you define the exact trigger conditions for transmission of I/O information as well as the content and destination of that information. A DO's reaction can also be automated through DI trigger conditions.

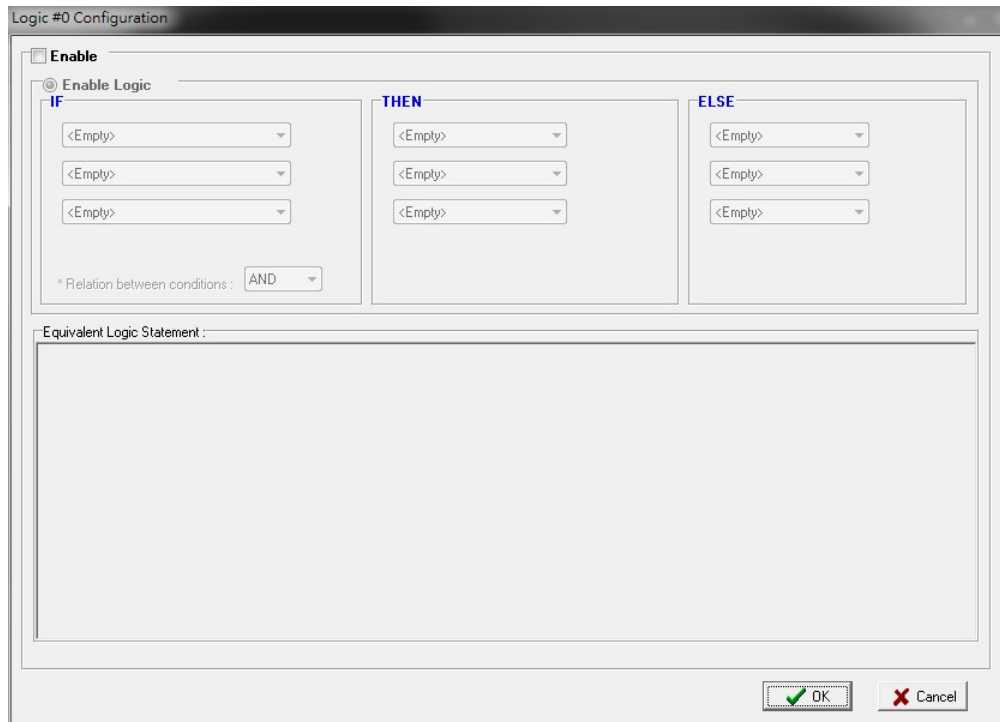

In the main screen, you will see a list of the rules in the current rule set. Double click on a rule to open that rule's configuration window, or double click on an empty rule to start a new rule.

The **Equivalent Logic Statement** at the bottom shows a real-time text-based summary of the rule that you are defining, and provides a useful means of making sure that the rule is designed as you intended.



ATTENTION

When configuring input and output control and response values, **you must select the unit of measurement before entering a value**. If you select a unit of measurement after entering a value, the value will not be retained. In addition, when an I/O channel is being used in a Click&Go Logic rule, the channel's range and units cannot be modified.

Click&Go Development Process

After searching and setting up the IP address of an ioLogik Ethernet I/O server, Click&Go logic can be developed by following the procedures below:

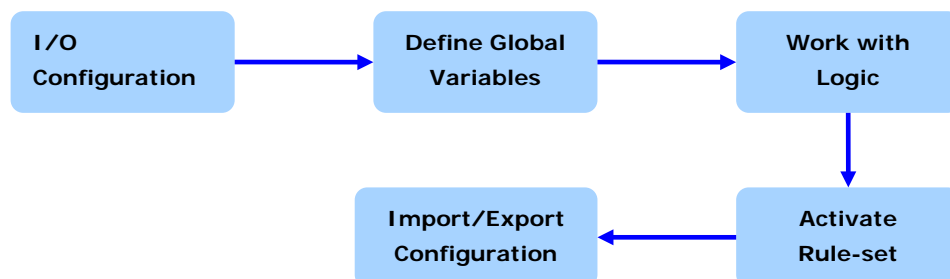

I/O Configuration

ioLogik products are embedded with various types of I/O channels, and the mode of each input/output channel must be configured before using the channels. Channels are divided into five categories: digital inputs, digital outputs, analog inputs, analog outputs, and virtual channels.

Configurable DIO Channel Mode Selection

For models that support the configurable DIO channels, configure the specific DIO to **DI** or **DO** to meet the requirements.

Model	Number of Configurable DIO Channels	Mode Settings	
		Digital Input	Digital Output
ioLogik W5340-HSPA	8	✓	✓
ioLogik W5340	8	✓	✓
ioLogik W5312	4	✓	✓

When logged in as an administrator, double click on a channel in the **I/O Configuration** panel to configure that channel's settings. A window will open with configuration options for the channel. Each DIO channel will be configured to act as either a DI or DO channel, according to the **Power On Settings**. To switch between DI and DO channel operation, select the desired mode in the **I/O Direction** field under **Power On Settings**. After clicking **Apply**, you will need to restart the ioLogik for the new setting to take effect.

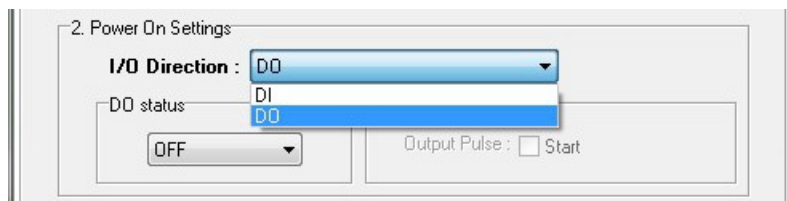

ATTENTION

Switching between DI and DO channel requires restarting the ioLogik for the new setting to take effect. You must restart the ioLogik before proceeding with configuration or programming.

Digital Input Mode Selection

A DI channel can be set to **DI** or **Event Counter** mode. In DI mode, the channel connects to wet/dry contacts. In Event Counter mode, the channel accepts limit or proximity switches and counts events according to the ON/OFF status. When **Lo to Hi** is selected, the counter value increases when the attached switch is pushed. When **Hi to Lo** is selected, the counter value increases when the switch is pushed and released.

Model	Number of Digital Input Channels	Mode Settings	
		DI	Event Counter
ioLogik W5340-HSPA	8	✓	✓
ioLogik W5340	8	✓	✓
ioLogik W5312	8 DIs+4 DIOs	✓	✓

When logged in as administrator, double click on a channel in the **I/O Configuration** panel to configure that channel's settings. A window will open with configuration options for that channel. Each DI channel will be configured to act as either a DI or Event Counter channel, according to the **Mode Settings**. To switch between DI and Event Counter channel operation, select the desired mode under **Mode Settings**.

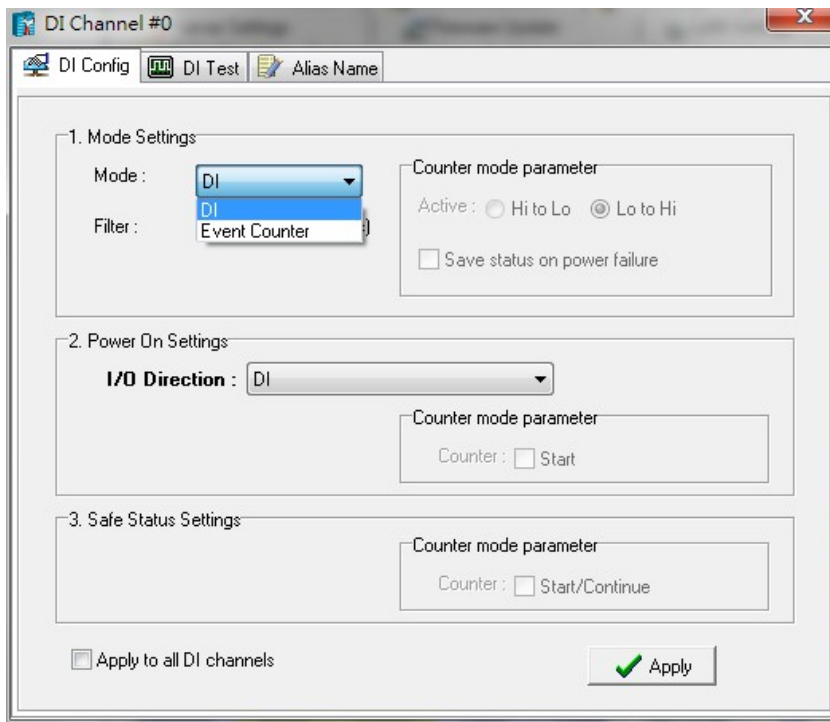

ATTENTION

On this panel, be sure to select **Start** under **Counter mode parameter** on **Power On Settings** to activate the Event Counter channel.

Digital Output Mode Selection

A DO channel can be set to **DO** or **Pulse Output** mode. The Relay Output behavior is the same as DO.

Model	Number of Digital Output Channels	Mode Selection	
		DO	Pulse Output
ioLogik W5340-HSPA	8 DIOs + 2 Relays	✓	✓
ioLogik W5340	8 DIOs + 2 Relays	✓	✓
ioLogik W5312	8 DOs + 4 DIOs	✓	✓

When logged in as an administrator, double click on a channel on the **I/O Configuration** panel to configure that channel's settings. A window will open with configuration options for that channel. Each DO channel will be configured to act as either a DO or Pulse Output channel, according to the **Mode Settings**. To switch between DO and Pulse Output channel operation, select the desired mode under **Mode Settings**.

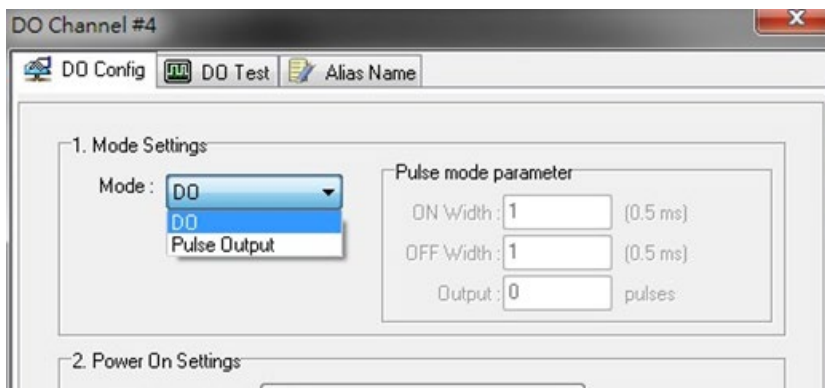

Analog Input Mode Selection

Analog input channels can use either voltage or current to transmit signals.

Model	Number of Analog Input Channels		Mode Selection	
			Voltage	Current
ioLogik W5340-HSPA	4	±5 V, ±10 V, 0-10 V	0 to 20 mA,	
ioLogik W5340			4 to 20 mA	

When logged in as administrator, double click on a channel on the **I/O Configuration** panel to configure that channel's settings. A window will open with configuration options for that channel. Each AI channel will be configured to measure either voltage or current according to the **Range Settings**.

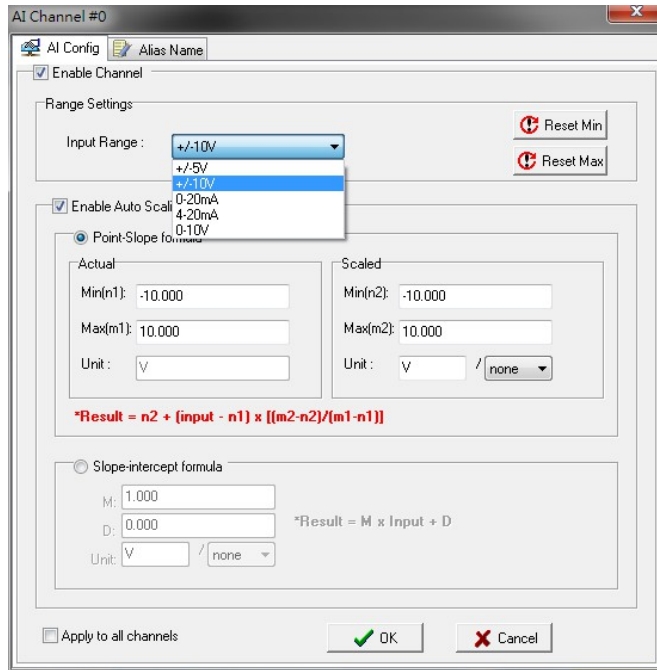

Alias Configuration

Alias Name helps users configure the alias of a DI or DO channels and define the logic level (0 or 1) for the ON/OFF status. The Alias can be monitored by the ioAdmin utility, or queried by using a user-defined program based on the Moxa MXIO library or standard Modbus/TCP protocols.

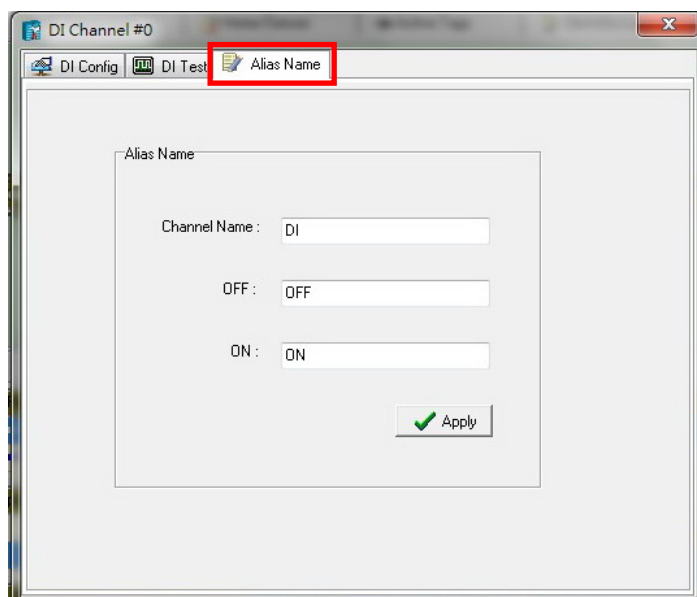

For Click&Go programming, the Alias Name will display the user-defined name when the specified channel is selected. For example, although the first DI channel is represented by **DI-0** in Click&Go, you can change the Alias Name to **Door_0** for easier recognition when programming.

When logged in as administrator, double click on a channel on the **I/O Configuration** panel to configure that channel's settings. A window will open with configuration options for that channel. The Alias name of each input/output channel can be configured by selecting the **Alias Name** panel.



ATTENTION

We strongly recommend configuring the alias name for the I/O channel being used before performing any further configuration or programming.

Testing the I/O Channels

Each I/O channel can be tested and monitored individually. When logged in as administrator, double click on a channel from the **I/O Configuration** panel to configure that channel's settings. A window will open with configuration options for the channel. Tests can be done by opening the channel's configuration window and selecting the Test panel.

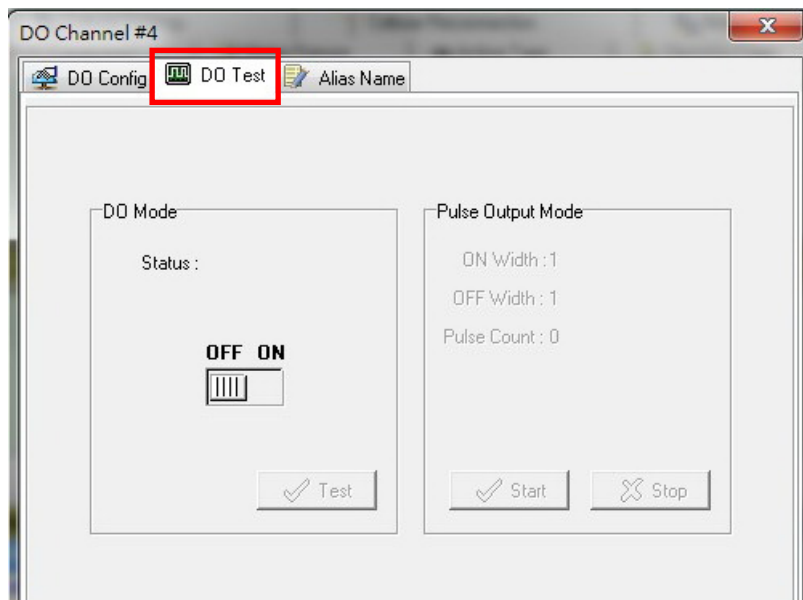

The Test panel shows how a channel's status affects, or is affected by, the attached device. For output channels, you can set the on/off status, start and stop a pulse, or output a voltage or current. For input channels, you can monitor the attached device's on/off status, counter, or input voltage/current.

Defining Global Variables

Global Variables include **Internal Register Settings**, **Timer Settings**, **SNMP Trap Server**, **E-Mail Server**, **Active Message Server** and **SMS Phone Book**. If these functions will be used in a Click&Go V2 rule-set, the default configuration must first be set from the Global Variable Menu Bar.

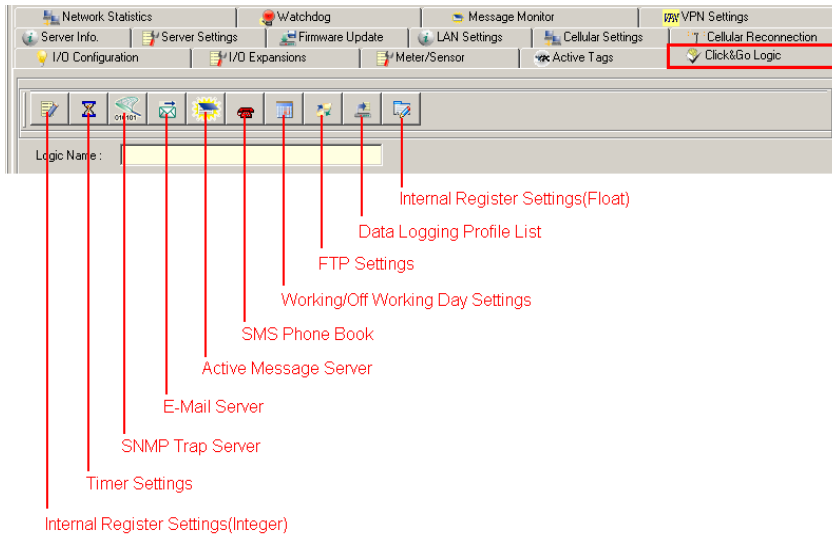

The following global variables are only supported by the ioLogik W5300:

SMS Phone Book, **Working/Off Working Day**, **FTP**, **Data Logging Profile List**, and **Internal Register (Float)**.

Internal Register (Integer) Settings

Internal Register (Integer) is a flag that can be used with the Click&Go logic internally or externally. The 24 sets of internal registers can be polled and controlled by SCADA software using standard Modbus/TCP format, or implemented to redirect the result of one Click&Go logic to another.

The default value of an internal register is "0".

	Register Number	Initial Value
Internal Register	Reg-0 to Reg-23	*0 to 255

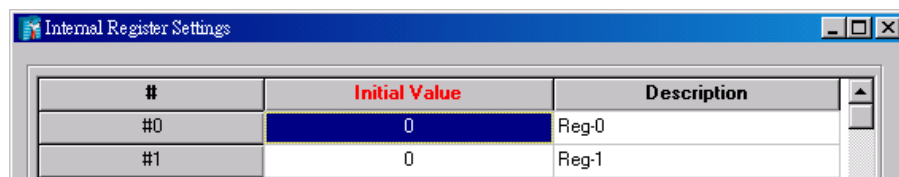

Timer Settings

The **Timer** function allows users to delay an action, trigger an action to run, or repeat an action. A timer is activated by a change of the logic event. After the timed interval has expired, the output will be performed.

The 24 timers that can be implemented with Click&Go V2 logic have the default time interval set to "5 seconds" in the "STOP" state. Be sure to configure the interval before using a timer.

With the default state set to "START" the timer will start when the Click&Go logic is activated.

	Timer Number	Initial State Configuration
Timer	Timer-0 to Timer-23	START, *STOP

#	Initial Value	Description
#0	0	Reg-0
#1	0	Reg-1

SNMP Trap Server

The ioLogik W5300 supports SNMP v2 (Simple Network Management Protocol) to allow monitoring of the network and I/O devices with SNMP Network Management software. It is useful for building automation and telecom applications. Before monitoring the system information of an ioLogik via SNMP trap, first define a rule in Click &Go logic to update the I/O status (up to 10 SNMP trap servers can be defined).

#	Manager Address
#1	192.168.127.1
#2	192.168.127.2
#3	

E-Mail Server

The **E-mail Server** configures the parameters of the target e-mail servers and the recipient e-mail addresses. The **Recipient Database** should contain a list of available e-mail addresses for your network environment. The e-mail message defined in the Click&Go logic will be sent to all addresses listed in the **Receiver(s) list**. To add e-mail addresses to the **Available receiver(s) list**, enter the **Name** and **Mail Address** and click the **Add** finger icon to move addresses to the **Recipient Database**; use the **Remove** finger icon to remove it.

Mail Address Settings

Name : Mail Address :

Recipient Database

Name	e-Mail Address

Mail Server Settings

SMTP Server Address: Login Name :

SMTP Server Port: Login Password :

Retry Interval

Under Mail Server Settings, you must configure the address of the SMTP server with your username and password. When using an FQDN (Fully Qualified Domain Name) address, such as ms.moxa.com, you must specify the ioLogik's DNS settings or check the Cellular Settings to see if the DNS settings were retrieved by the cellular connection.

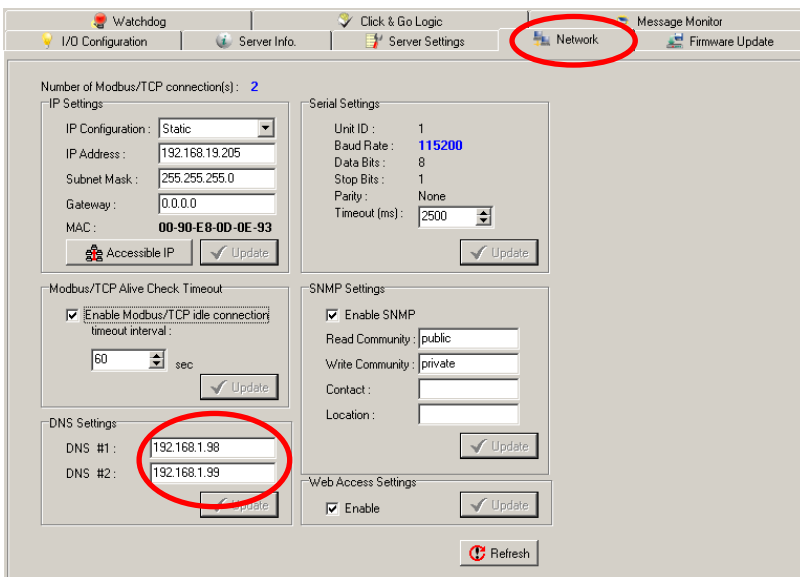
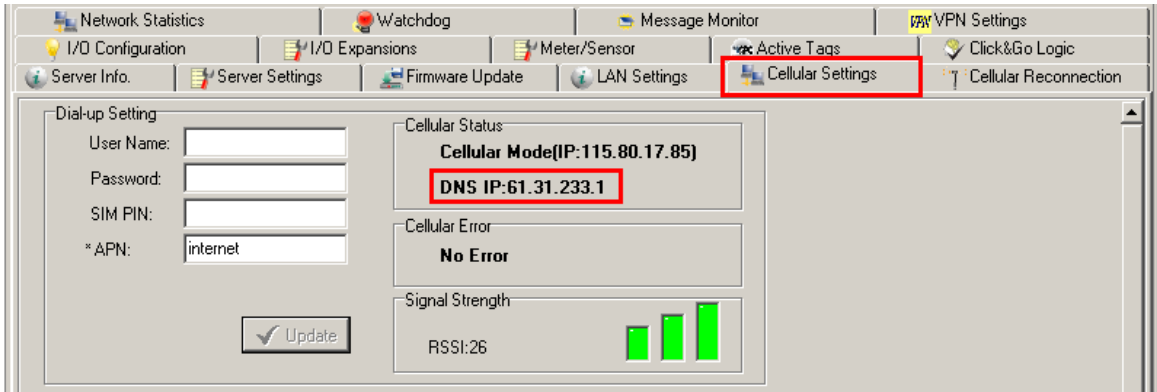

Active Message Server

The **Active Message Server** configures one or more destination IP addresses of the Message Servers that receive event messages generated by the Click&Go logic. The message protocol (TCP or UDP) and the message socket port must also be configured.

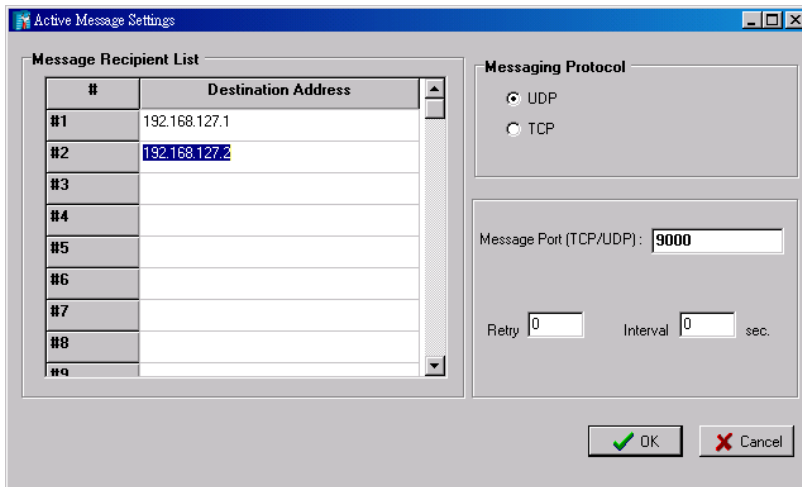

The active message defined in the Click&Go logic will be sent to all addresses listed in the **Message Recipient List**.

Message Port (TCP/UDP): The Port the computer uses to communicate with the device; the default port for TCP/UDP is 9000

SMS Phone Book

The **SMS Phone Book** configures one or more destination phone numbers that will receive SMS (Short Message Servers) event messages generated by the Click&Go logic. The SMS defined in the Click&Go logic will be sent to all mobile phones listed in the **Phone Book**. A total of 20 receivers can be configured in the phonebook.

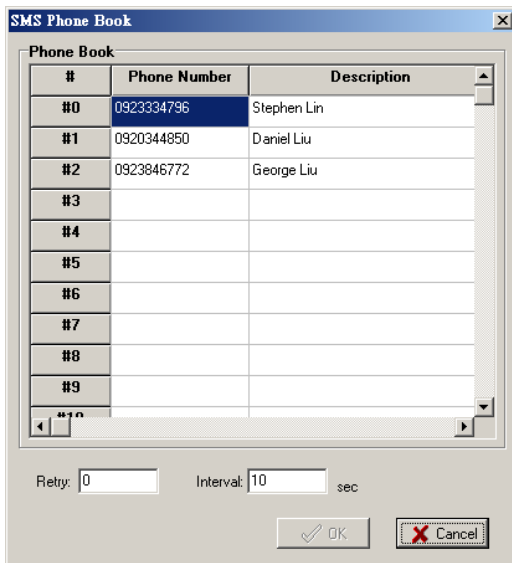

Working/Off Working Days

The **Working/OffWorking Days** defines the workweek days, hours, and off days to be used in the Click&Go **Schedule** function. Specify the work days and hours first, double click to select the date in the calendar, and then click the **Replace** button to update the selected entry of the off days.

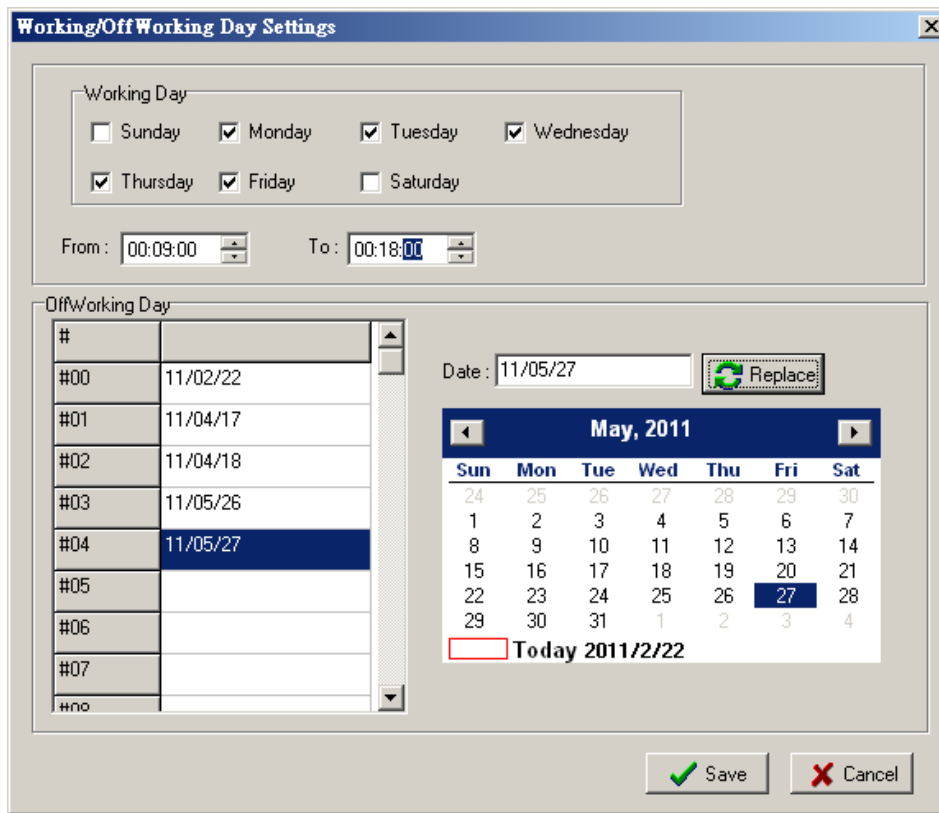

FTP Settings

The **FTP Settings** dialog defines the target FTP server's IP and user accounts to allow the ioLogik W5300 to upload log files. Specify the FTP Server's IP address and accounts and press the **Add** button to create a new entry in the list.

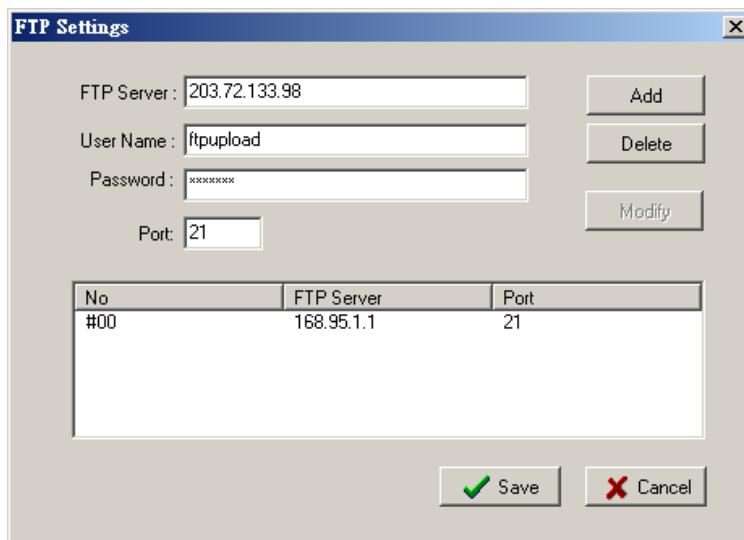

Data Logging Profile List

The **Data Logging Profile List** defines how to log the I/O data into the SD card. A total of 5 profiles can be created, and multiple/duplicate channels can be included in different profiles.

Take the following steps to create a profile:

1. Click the **New** button to create a new profile.

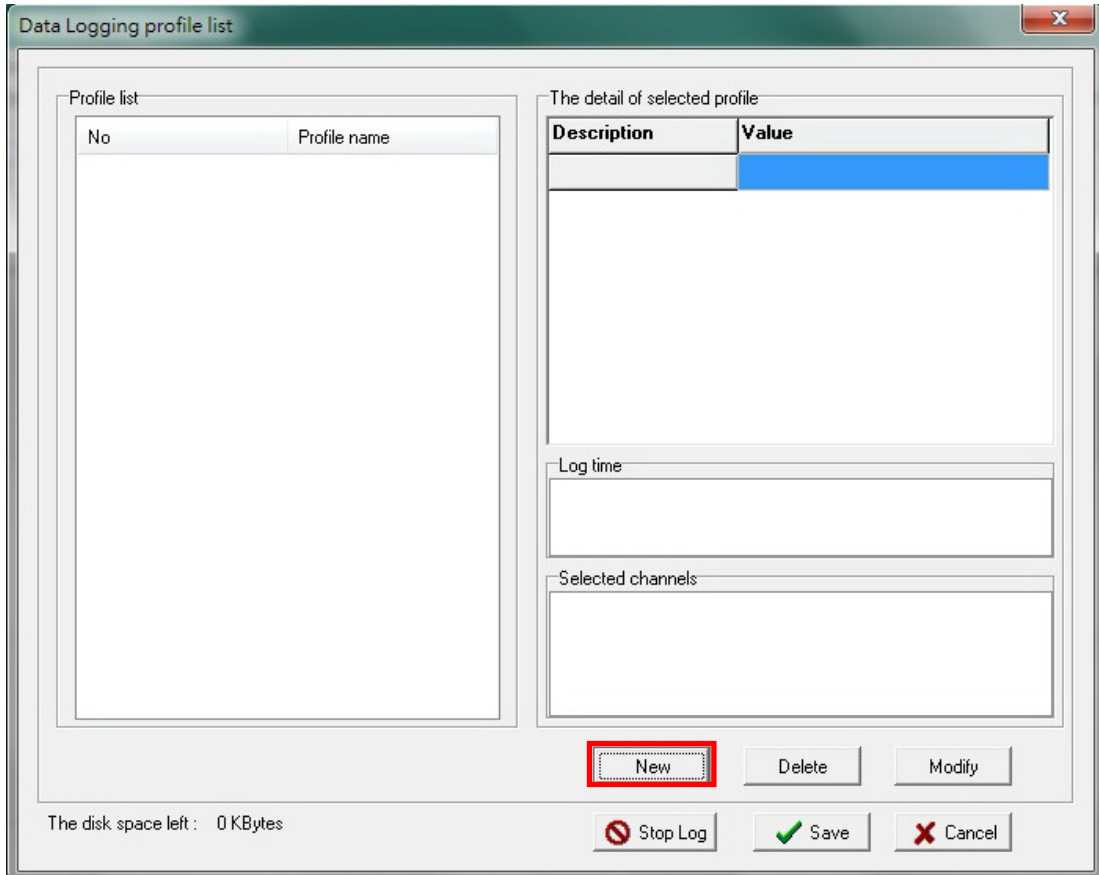

2. Click **Enable** and specify a name for the profile. In addition, specify the **Initial State** and capacity of a log file. If you select **Start** as the initial state, logging will start immediately once the profile is established. If you select **Stop**, a Click&Go logic must be performed to start the logging.

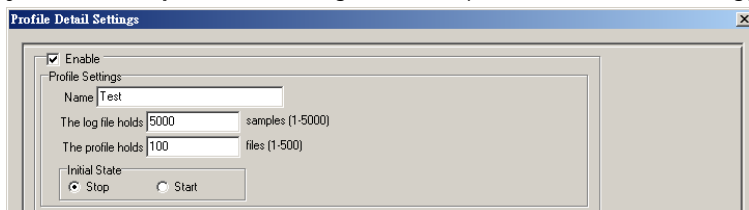

3. Define how to log the data by specifying the **Logging Type**. Users can choose to log when the I/O status changes (On Change), to log periodically (Periodical), or by pre-configured schedule (Schedule).

The screenshot shows the 'Logging Type' configuration window. The 'Schedule' radio button is selected. Under the 'Every month' section, the 'Day' is set to 1 and the 'Time' is 12:00. The 'Add' button is highlighted with a red box. The 'Next' button is also highlighted with a red box.

The Schedule settings are extremely flexible and can log by day, week, or month. Specify the hours and then click the **Add** button to add a setting of the schedule to the list.

Click **Next** to proceed.

4. Specify the channels to be logged. The percentage indicates the change of an analog channel when choosing the **On Change** logging type. Specify the percentage for an analog channel before selecting the channel in the right column.

The screenshot shows the 'Profile Detail Settings' window. The 'Channels Selection' section is visible, showing a list of available channels on the left and a list of selected channels on the right. The 'Analog Percentage' field is highlighted with a red box and set to 5.00%.

5. Click **Finish**.
6. Click **Save**.

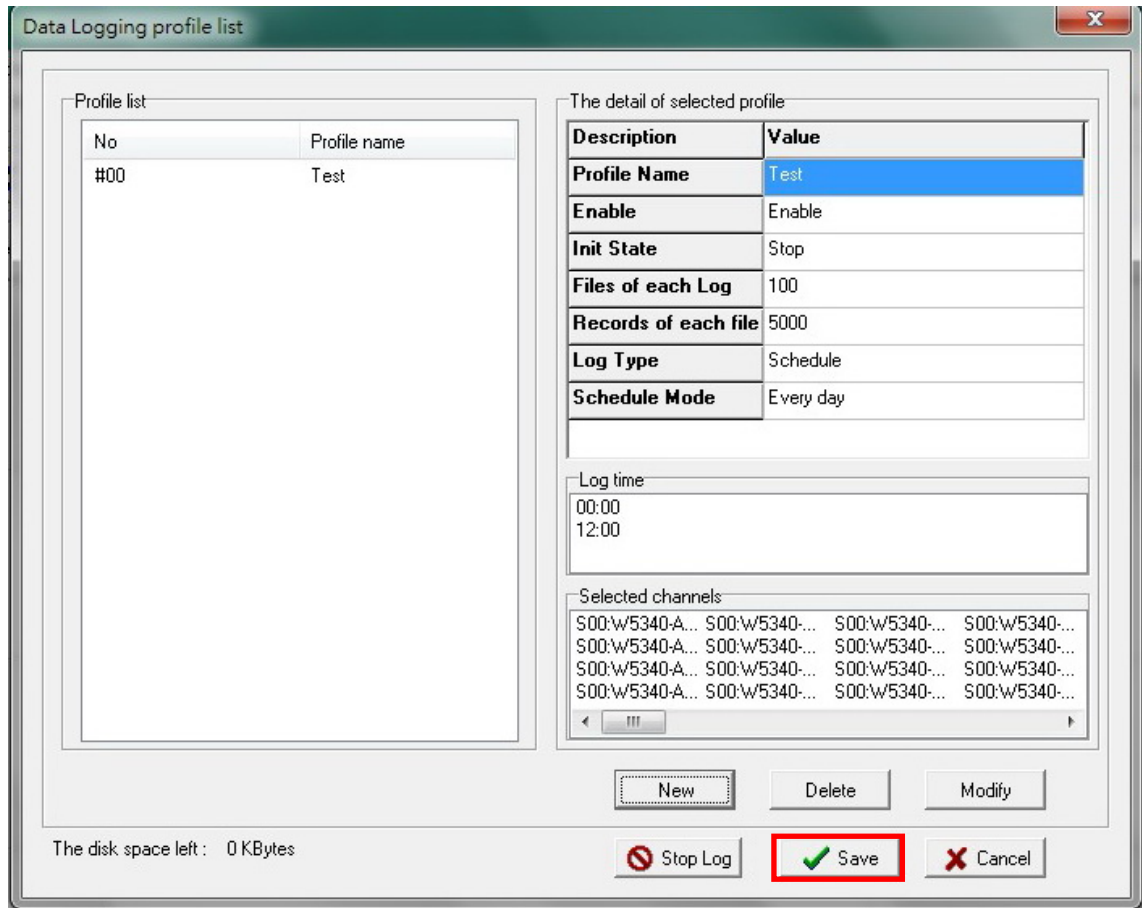

Internal Register (Float) Settings

Internal Register(Float) can be used as an analog comparison (dynamic throughput setting) and flag with the Click&Go logic internally or externally. The 28 sets of internal registers (float) can be polled and controlled by SCADA software using the standard Modbus/TCP format, or implemented to redirect the result of one Click&Go logic to another. The default value of an internal register is **0**.

	Register Number	Initial Value
Internal Register	FloatReg-0 to FloatReg-27	0.000 (4-byte float point)

Working with Logic

Click&Go Logic Basics

The Click&Go Logic panel is available after logging in as administrator. This is where Click&Go logic is configured. With a set of rules (known as a rule-set) defined through Click&Go, the ioLogik can perform local and remote I/O control, report I/O status, and actively send out messages, e-mails, or SNMP traps to a host as soon as the user-defined I/O conditions have been met.

To use Click&Go Logic, start ioAdmin and log in as ioLogik administrator from the Server Settings panel. Once you are logged in, go to the Click&Go Logic panel. The following screen should appear:

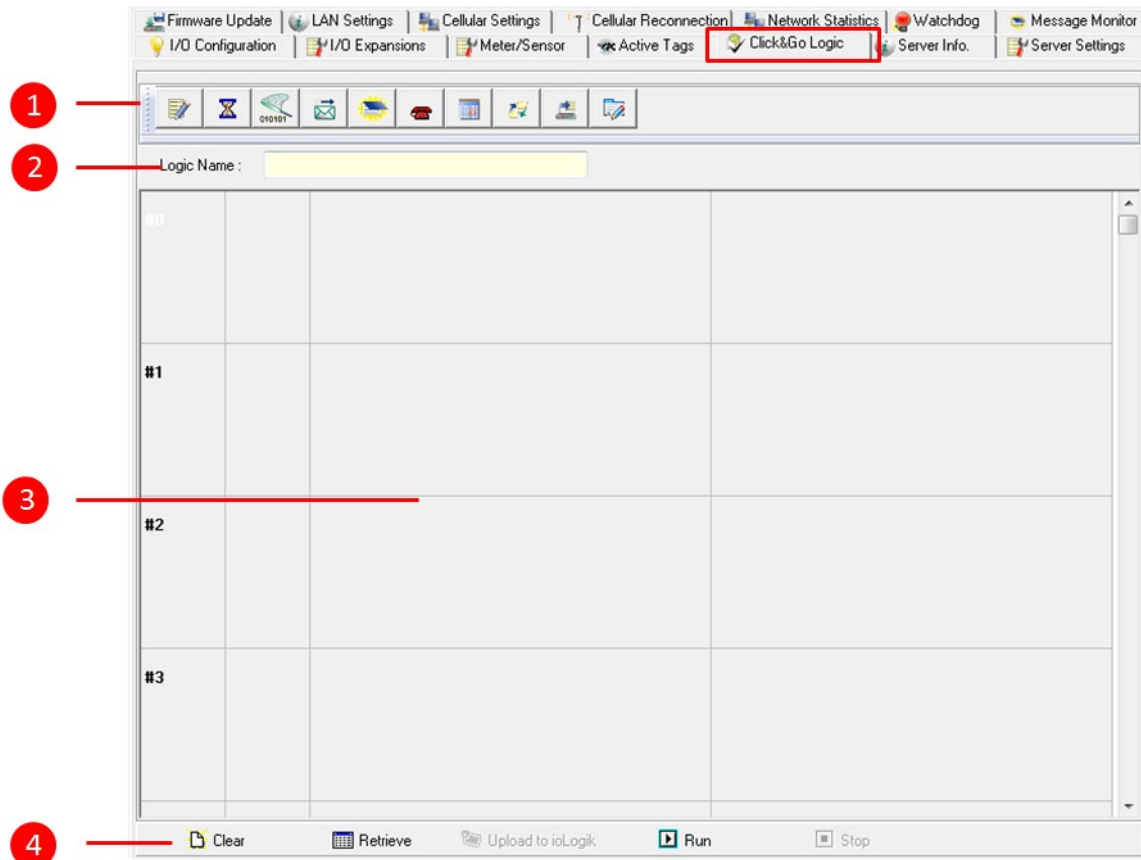

Click&Go Logic Panel	
1.	Global Variable: In this field, you can configure global variable rules.
2.	Logic Name: In this field, you can assign a name to the set of rules.
3.	Rule-set: In this area, each rule's conditions, actions, and status are displayed.
4.	Rule-set Management Bar: In this area, you manage the rule-set.

Rules are the building blocks of your ioLogik system. With rules, you define the exact trigger conditions for transmission of I/O information as well as the content and destination of that information.

Click&Go Logic can be defined in the following ways:

IF "A" THEN "B", ELSE "C"

For one control logic rule, there are three "A's" that can be configured. "A" refers to the IF conditions that trigger an action. These three conditions can be operated by "AND" or "OR" logic. If "AND" logic is used, all three conditions must be true to create a positive result. If "OR" logic is used, one or more true conditions must be met to trigger the action.

A1	A2	A3	Result of AND Logic	A1	A2	A3	Result of OR Logic
0	0	0	0	0	0	0	0
0	0	1	0	0	0	1	1
0	1	0	0	0	1	0	1
0	1	1	0	0	1	1	1
1	0	0	1	1	0	0	1
1	0	1	1	1	0	1	1
1	1	0	1	0	0	0	1
1	1	1	1	1	1	1	1

The 24 rules are defined individually and are executed one by one in a loop. The 2nd rule can only be processed after running the 1st rule, and the entire rule-set will start running from the beginning after the last rule is processed.

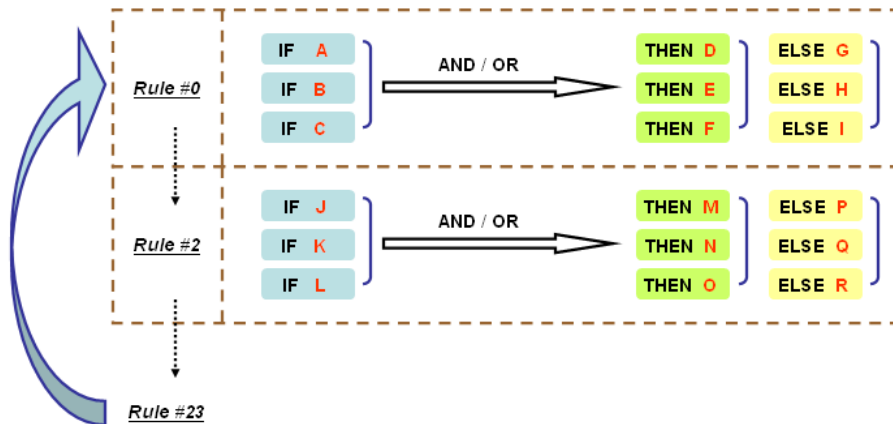

You will see a list of the rules in the current rule-set on the main screen. **Double Click** on a rule to open that rule's configuration window, as shown in the following figure, or double click on an empty rule to start a new rule.

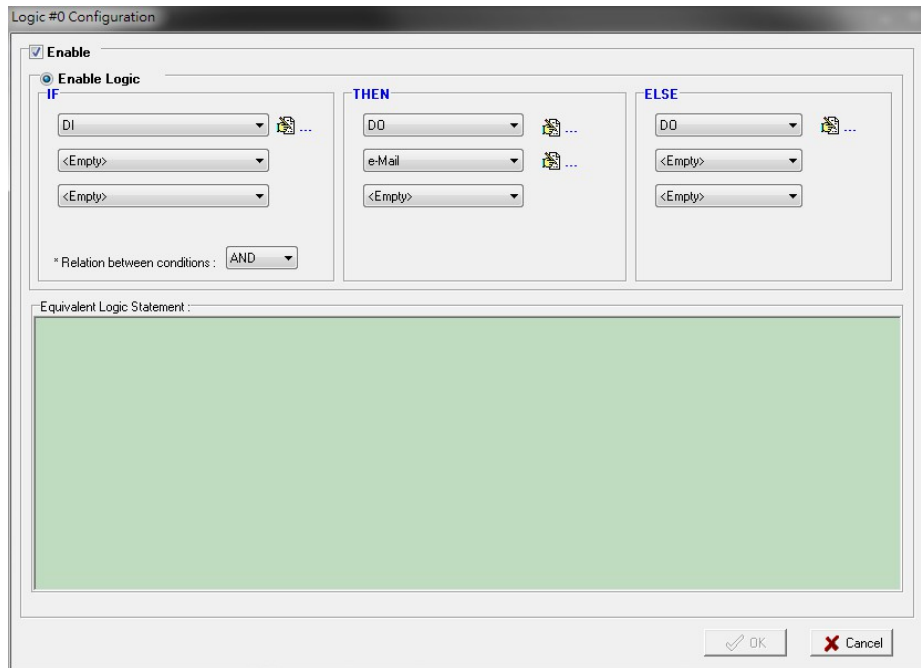

Under **Relation between conditions**, select **AND** to specify that all conditions must be satisfied for the actions to take place; select **OR** to specify that any one of the conditions can be satisfied for the actions to take place. The **Equivalent Logic Statement** at the bottom shows a real-time text-based summary of the rule that you are defining. It provides a useful way to make sure the rule is designed as you intended.

IF...THEN/ELSE Conditionals

IF statements are trigger **THEN/ELSE actions**. Under the **IF** column, you can set up to 3 conditions that must be satisfied (when more than one condition is defined, **AND** or **OR** determinants are used to complete the logic), and which will, according to the inputs, determine whether actions under the **THEN** or **ELSE** column will take effect. For example, an alarm can be activated when a door is opened. Use the pull downs to specify the conditions and units of measurement (e.g., DI-0=OFF).

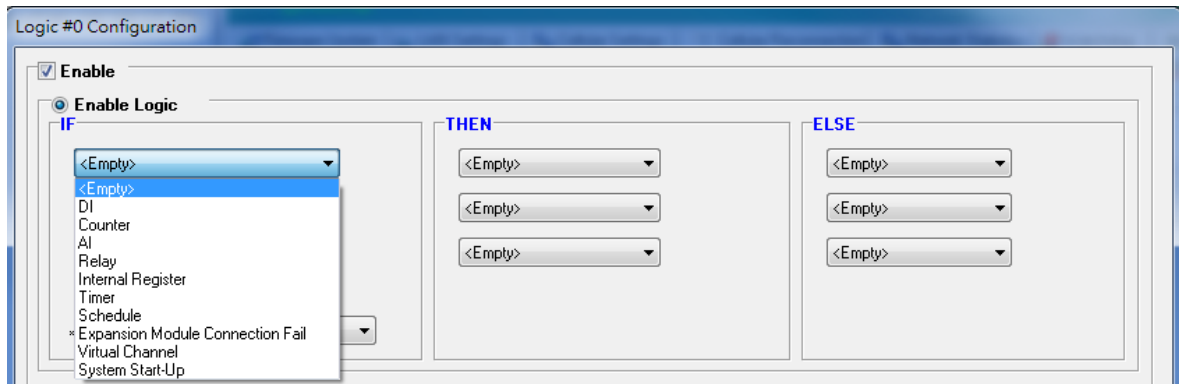

IF conditions may be defined as follows:

IF Conditions	Operators	Remark
DI	ON, OFF, ON to OFF, OFF to ON, Change	DI-x represents the channel number
Counter	=, >, <, >=, <=, Change	Counter-x represents the channel number. Max Counter Value: 4,294,967,295
AI	=, >, <, >=, <=	AI-x represents the number of the channel. Max Value: Depends on the analog modes or the result of scaling. Internal Register(Float) can be used as the comparison or throughput setting controlled by remote SCADA or a Modbus/TCP program.
Relay	=, >, <, >=, <=	CurRelayCNT-x represents the current relay counts for the channel. Max Value: 4,294,967,295
Internal Register	=	Reg-x represents the number of the internal register. x = 00 to 23 / Trigger Value: 0 to 255
Timer	TIMEOUT	Timer-x, x = 00 to 23 Max value: 4,294,967,295 seconds
Schedule		Time, Range and Recurrence
Expansion Module Connection Failure	0, 1	
Virtual Channel	=, >, <, >=, <=	VC-x represents the channel number
System Start up	N/A	Activate when the system is starting up at System Start

NOTE The following IF Conditions are only supported by the ioLogik W5300: **Expansion Module Connection Failure, Virtual Channel, and System Start-up.**

DI: Digital Input

DI refers to the status of a digital input channel. **Edge detection** may be used to further define the electrical requirements for signaling. For example, the condition **DI-0=OFF** is satisfied for as long as DI-0 remains off. The condition **DI-0=ON to OFF**, however, is only satisfied the instant the DI-0 turns off. The transition of the status change can also be handled using the **Change** operator, so that actions are triggered both for **ON-to-OFF** and **OFF-to-ON** transitions.

Scroll to select DI and click on the property () button to enter the DI Settings window.

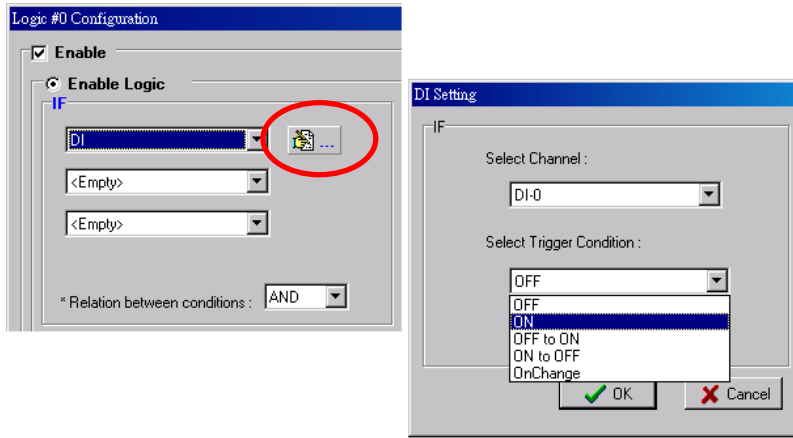

Counter

Counter refers to the counts of an Event Counter channel. The counts are stored in the ioLogik internally. Specifying the counts with a proper operator will lead to triggering the action. For example, if 10 items should be packed in a box, the Counter-x should be reset every 10 counts (**Counter-1=10**). Select the IF condition to Counter and click on the property button () to enter the Counter Settings window.

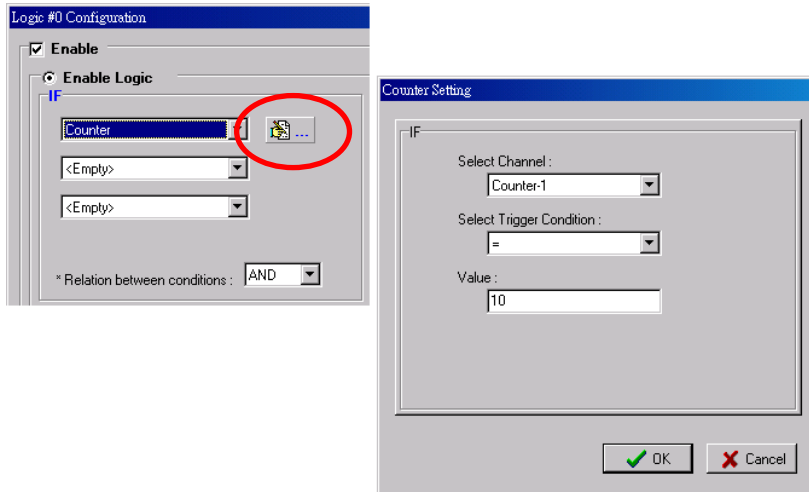

AI: Analog Input

AI refers to the readings of an analog input channel. An analog input value is specified to trigger an action. Units of the value are defined by the selected analog modes (voltage or current), or the scaling results. For example, **AI-0 > 15 mA** represents the high level of a water tank.

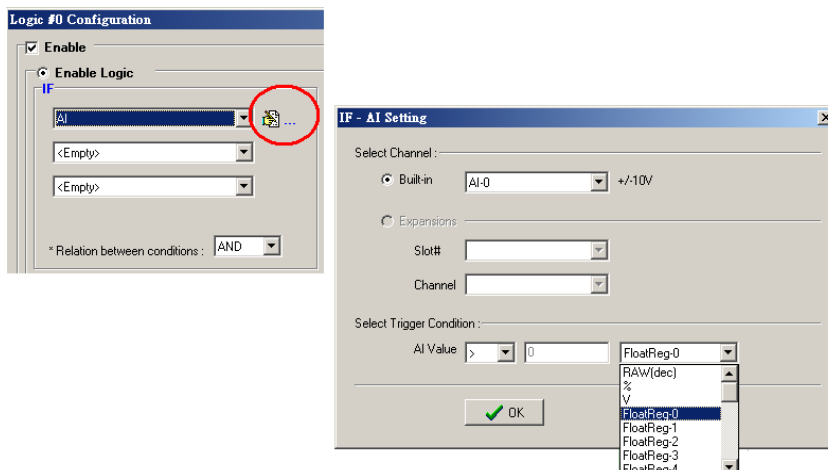

Virtual Channel

VC refers to the readings of a statistics channel. The value can be recorded in the data log file, or specified to trigger an action. Units for the value are determined by the user defined unit, or the scaling results. For example, $VC-0 > 15$ ml/s represents a water flow amount greater than 15 ml/s.

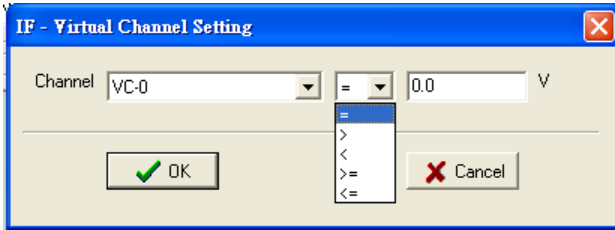

Relay (Counter)

Relay refers to the current counts of the relay usage. Checking the current counts of a relay will produce the action. For example, if the average life-cycle of a relay is 25,000 times, an alarm e-mail may be generated when the counter reaches 20,000 times ($CurRelayCNT-0 > 20000$) to report the need for a replacement.

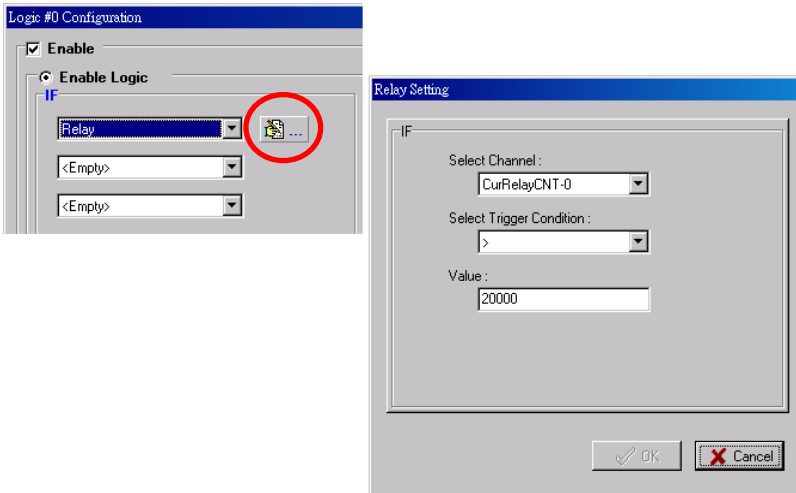

Internal Register (Integer)

Internal Register (Integer) represents a status flag to link the status of the first logic to the second one. It is used most often with the Timer function, or to combine other input statuses together. The Internal Register function also allows a PC to control the ioLogik’s local output when the remote output is controlled by a Click&Go log (e.g., digital output, active message, e-mail, or SNMP Trap). Select the IF condition for the

Internal Register and click on the property button () to enter the Set Internal Register window.

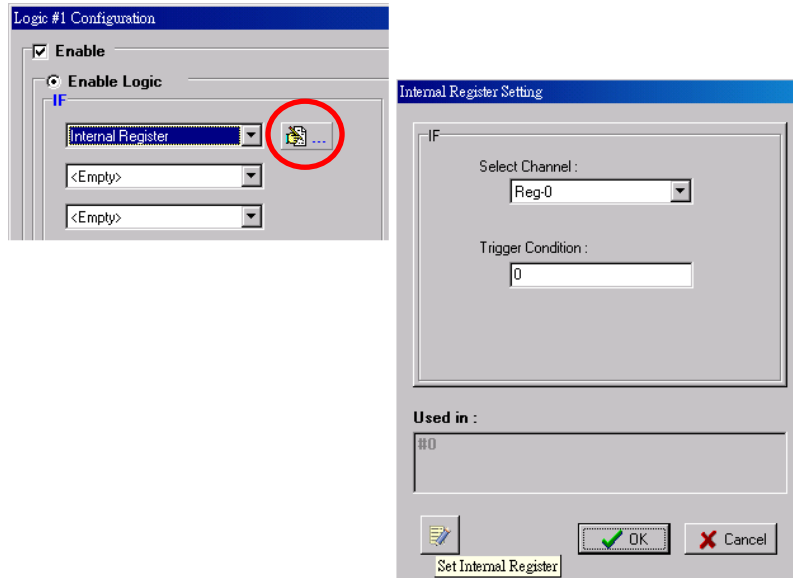

In the above figure, the “Used in:” column indicates that this Internal Register is also used with Rule-0, which helps the user identify the relationship between the rules. Also, the Set Internal Register button () will help to define the default values of all Internal Registers.

NOTE Internal Registers can be controlled by Modbus/TCP protocol. Refer to the appendix for the address list for all Internal Registers.

Timer

The **Timer** function can be used to control the timing of a logic rule in the IF conditions. “TIMEOUT” is the only operator here. For example, you can delay the triggering of an action or repeat an action periodically. Select the

IF condition for Timer and click on the property button () to enter the Timer Settings window.

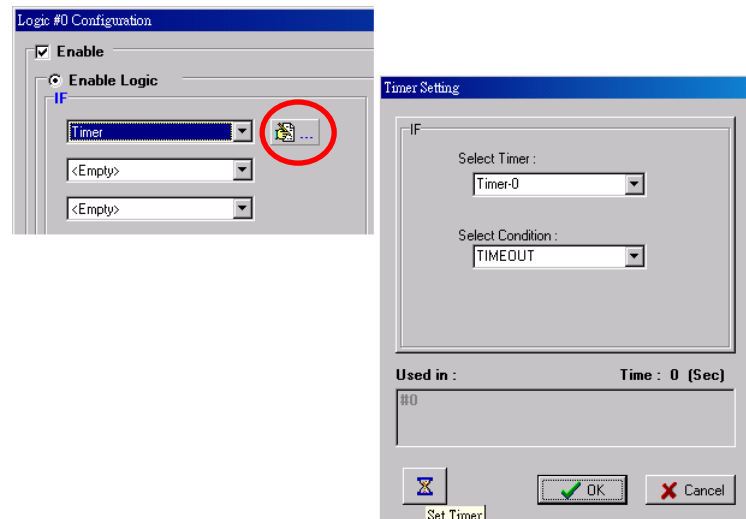

In the above figure, the "Used in:" column indicates this Timer is also used in Rule-0, which helps the user

identify the relationship between rules. In addition, the Set Timer button () will help define the default value for the Timer.

Schedule

The **Schedule** function allows users to set a starting point or time period for a task. For example, the Schedule function could be used if a pump needs to start at 9:00 PM and stop at 11:00 PM every Monday, Wednesday, and Friday.

Select the IF condition for Schedule and click on the property button () to enter the setting window. For recurrent actions, select the Recurrence checkbox and select the relevant weekdays. If a time period needs to be defined, specify the stop date in the range column.

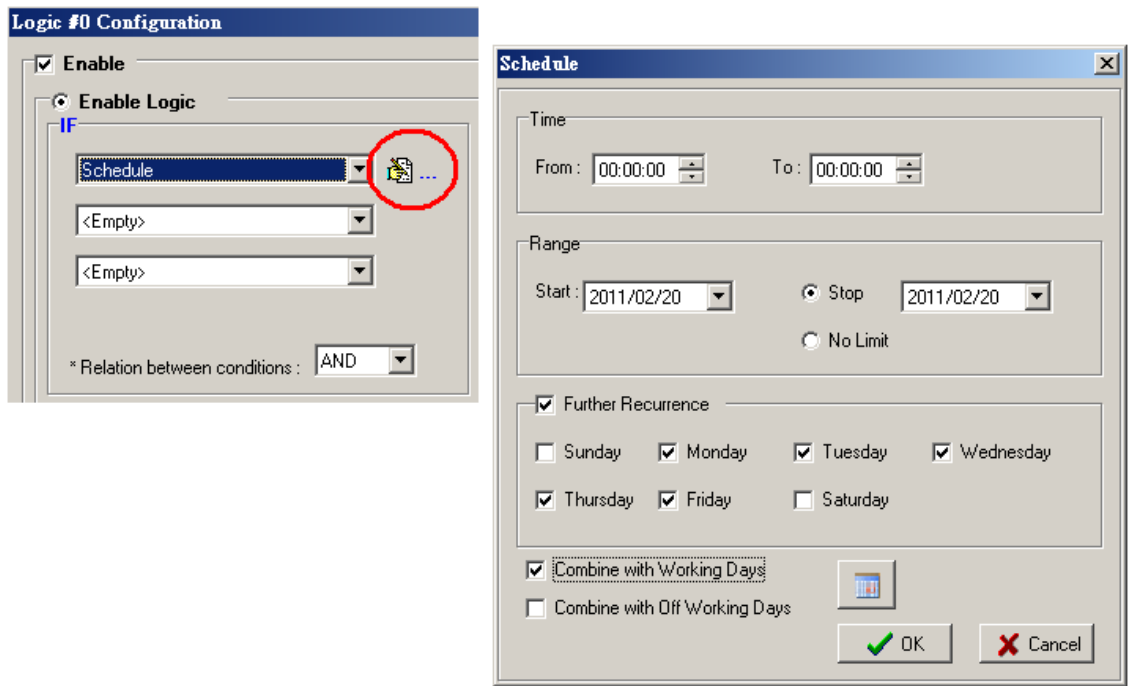

Expansion Module Connection Fail

The slot you select in the **Expansion Module Connection Fail** window will monitor while Click&Go is running. The monitored target is specified for these expansion modules.

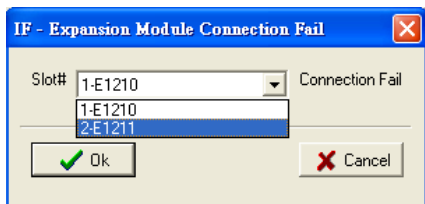

System Start-up

Click&Go logic provides the IF condition to perform an action, such as triggering the local output or SMS alarm to indicate that the system is restarting.

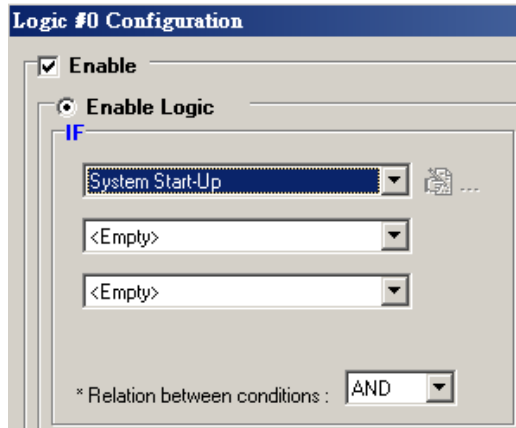

More Information about Repeat Interval vs. Edge Detection

Combining the Timer function with other IF conditions allows actions to be repeated when the specified logic is sustained over a period of time. However, if a condition is based on edge detection (i.e., **ON to OFF** or **OFF to ON**), it can only be triggered once.

The following scenarios illustrate how edge detection affects the **Timer = N sec**. In each diagram, the statuses of three sensors are shown over a period of time, with a high signal corresponding to a “true” condition. The green shaded area shows the duration of time that the IF conditions have been met.

No Edge Detection		
In this scenario, the rule checks each sensor for “on” status, so edge detection is not involved. As long as the sensors remain on, the required conditions are satisfied, and the THEN actions will repeat at interval N.		
DI-0 = ON DI-1 = ON DI-2 = ON		
Relation between conditions	AND	OR
“IF” conditions satisfied		
Repeat interval	“Timer = N sec”	“Timer = N sec”
“THEN” action triggered		

Edge Detection for All Conditions		
<p>In this scenario, the rule checks each sensor for a change from "off" to "on" status, meaning only edge detection conditions are used. As soon as a sensor changes from "off" to "on", the condition is satisfied, but only for that instant. Right after that instant, the condition is no longer satisfied because it is no longer changing from "off" to "on". The repeat interval will have no effect, since edge conditions cannot be sustained over a period of time.</p>		
DI-0 = OFF to ON DI-1 = OFF to ON DI-2 = OFF to ON		
Relation between conditions	AND	OR
"IF" conditions satisfied		
Repeat interval	N/A	N/A
"THEN" action triggered		
Edge Detection for Two Conditions		
<p>In this scenario, the rule checks DI-0 and DI-1 for a change in status and DI-2 for status only. The repeat interval will not have an effect if the AND relationship is used, because the two edge conditions can never be sustained over a length of time. With the OR relationship, the IF conditions will be satisfied as long as DI-2 is "on", and the THEN actions will be triggered over interval N.</p>		
DI-0 = OFF to ON DI-1 = OFF to ON DI-2 = ON		
Relation between conditions	AND	OR
"IF" conditions satisfied		
Repeat interval	N/A	N/A
"THEN" action triggered		

Edge Detection for One Condition		
<p>In this scenario, the rule checks DI-0 for a change in status and DI-1 and DI-2 for status only. The repeat interval will not have an effect if the AND relationship is used, because the edge condition for DI-0 can never be sustained over a length of time. With the OR relationship, the IF conditions will be satisfied as long as DI-1 or DI-2 is "on", and the THEN actions will be triggered over interval N.</p>		
<p>DI-0 = OFF to ON DI-1 = ON DI-2 = ON</p>		
Relation between conditions	AND	OR
"IF" conditions satisfied		
Repeat interval	N/A	"Timer = N sec"
"THEN" action triggered		

THEN/ELSE Actions

Under the **THEN** column, you can specify up to 3 actions that will be performed when the **IF** conditions are satisfied. 3 actions under the **ELSE** column will also be performed when the **IF** is **NOT** satisfied. Possible actions include changing the status of a DO channel, starting or stopping an Event Counter, or sending a message by SNMP trap, TCP, UDP, or e-mail.

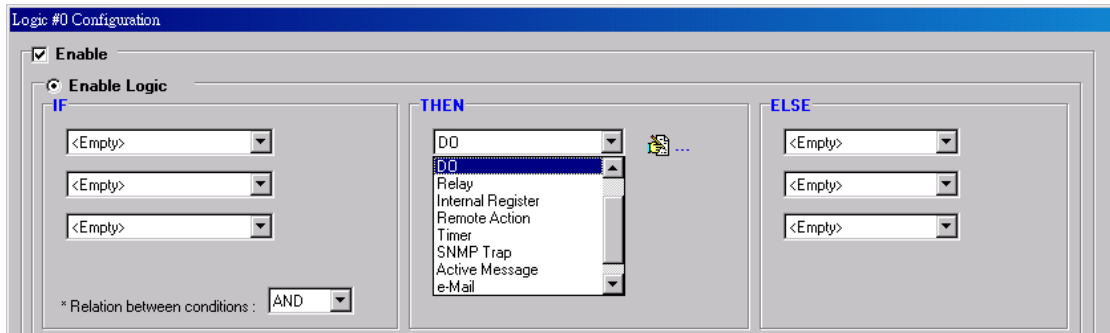

If Conditions			Result of AND Logic	Trigger of Then Actions	Trigger of ELSE Actions
A1	A2	A3			
0	0	0	0	NO	YES
0	0	1	0	NO	YES
0	1	0	0	NO	YES
0	1	1	0	NO	YES
1	0	0	0	NO	YES
1	0	1	0	NO	YES
1	1	0	0	NO	YES
1	1	1	1	YES	YES

If Conditions			Result of OR Logic	Trigger of Then Actions	Trigger of ELSE Actions
A1	A2	A3			
0	0	0	0	NO	YES
0	0	1	1	YES	NO
0	1	0	1	YES	NO
0	1	1	1	YES	NO
1	0	0	1	YES	NO
1	0	1	1	YES	NO
1	1	0	1	YES	NO
1	1	1	1	YES	NO

THEN/ELSE actions can be specified as follows:

THEN/ELSE Actions	Operators	Remark
Counter	RESET	Counter-x represents the number of the Event Counter channel
DO	ON, OFF	DO-[X] represents the number of the channel.
Pulse Output	STOP, START	Pulse Output-[X] represents the number of the channel
AO		For ioLogik E1241 expansion
Relay Output	RESET	ResetCNT-[X] represents the number of the relay channel.
Internal Register		Reg-x represents the number of the internal register. x = 00 to 23 / Trigger Value: 0 to 255
Timer	STOP, START, RESTART	Timer-x, x = 00 to 23 Max value: 4,294,967,295 seconds
SNMP Trap		I/O Status Bindings: 3 sets
Active Message	ID / Source IP	Unicode supported
e-Mail		Create the contents of the email
Short Message Service		Select recipients from the phone book, define the content, and configure the escalation
Data Log Start/Stop	Start, Stop	Select which profile to start or stop
FTP Service		Select which profile and FTP server to upload the log file

NOTE The following THEN Actions are only supported by the ioLogik W5300: **Short Message Service, Data Log Start/Stop, and FTP Service.**

NOTE Click&Go only allows one message-type action (Active Message, e-Mail, or Short Message Service) in each THEN/ELSE row.

Counter

In this THEN/ELSE action, the only operator for the **Counter** function is “RESET”, which clears the counts of an Event Counter channel. This function is often used in a charging system to clear the readings of a meter. Select the THEN/ELSE action to **Counter** and click on the property button () to enter the Counter Settings window.

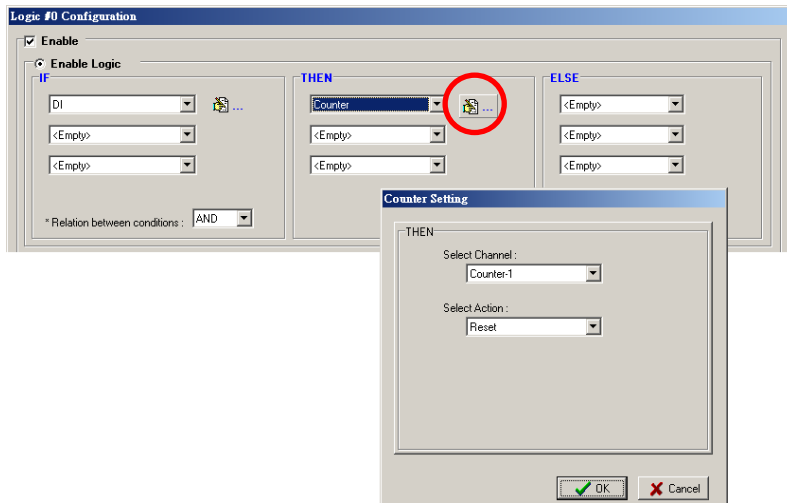

DO

DO refers to the action of controlling the local digital output channels that react to the IF conditions. Select the THEN/ELSE action to **DO** and click on the property button () to enter the DO Settings window.

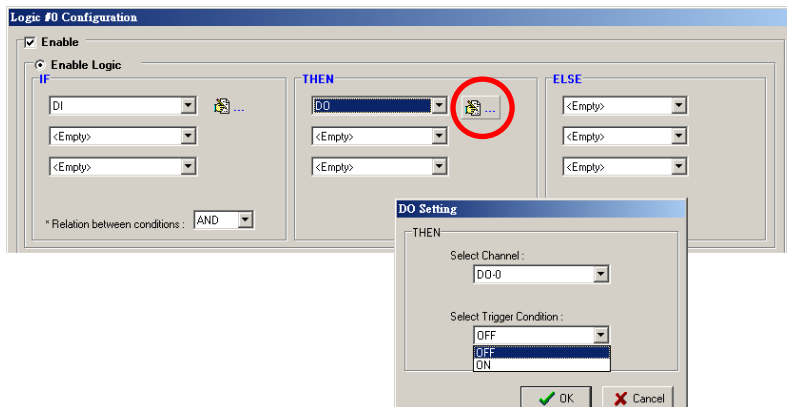

NOTE A Relay output channel is also referred to as a DO channel in the THEN/ELSE action fields.

Pulse Output

Pulse Output starts or stops a pulse. It is usually used to create the flash for an alarm light. Select the THEN/ELSE action to Pulse Output and click on the property button () to enter the Pulse Output Settings window.

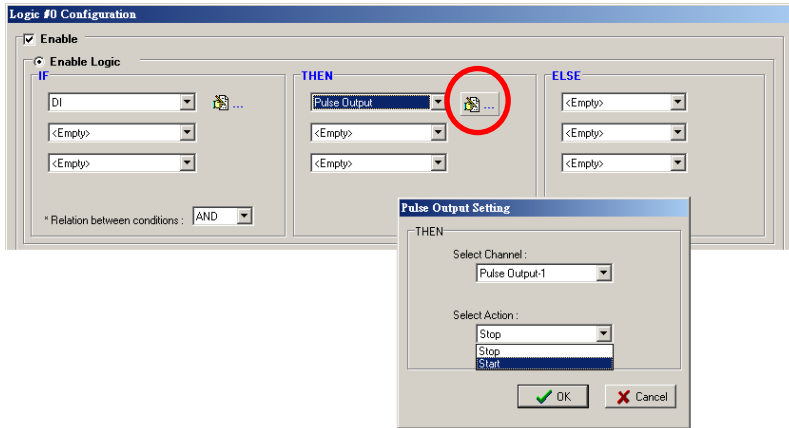

AO

Analog Output (AO) refers to the action of controlling the local Analog Output channels that react to the IF conditions. Select the THEN/ELSE action to AO and click on the property button () to enter the AO Settings window.

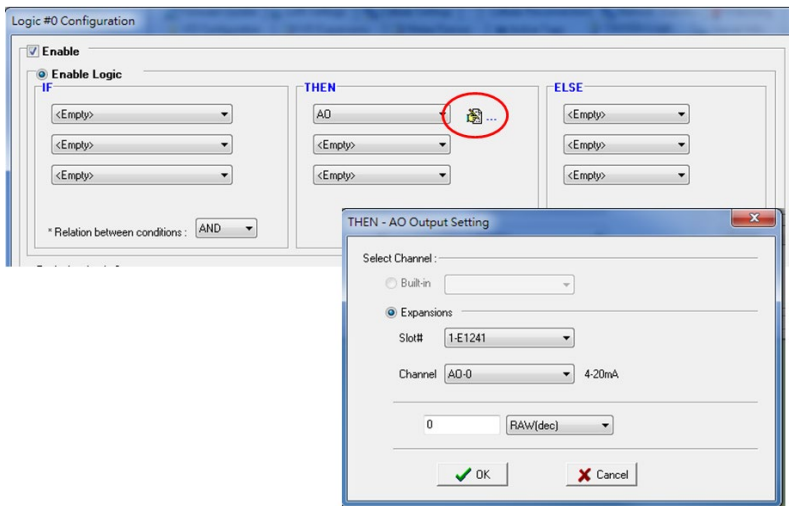

Relay (Counts)

In the THEN/ELSE action, **Relay** refers to the current counts specifying how many times a relay has been triggered. The counts are stored internally and can be cleared. "RESET" is the only operator. Select the THEN/ELSE action to Relay and click on the property button () to enter the Relay Settings window.

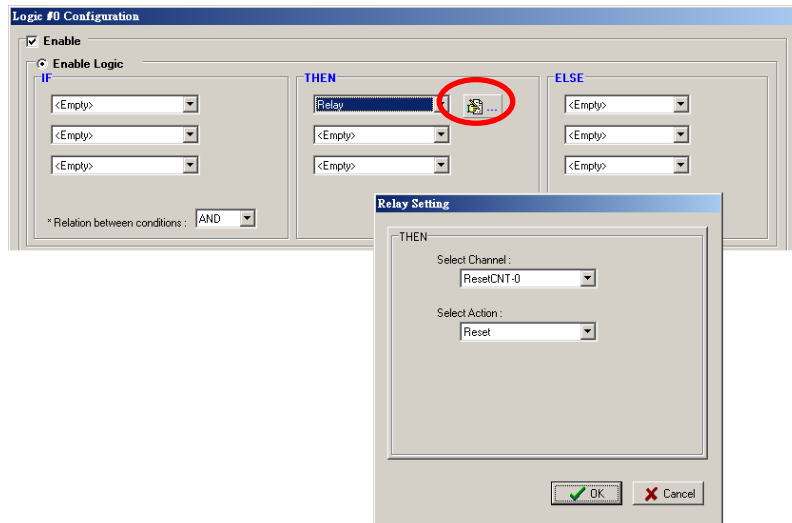

Internal Register (Integer)

Internal Register (Integer) represents a status flag to link the status of the first logic to the second one by specifying other actions in the THEN/ELSE fields. Values from 0 to 255 can be used here. Select the THEN/ELSE action for Timer and click on the property button () to enter the Internal Register Settings window.

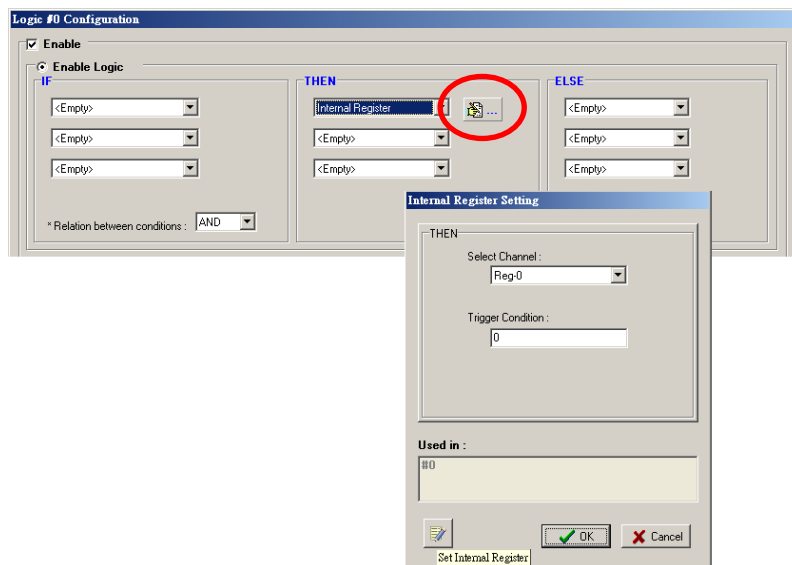

In the above figure, the "Used in:" column indicates that this Internal Register is also used in Rule-0, which helps the user identify the relationship between the rules. In addition, the Set Internal Register button () can be used to define the default values of all registers.

NOTE Internal Register can be controlled by Modbus/TCP protocol. Refer to the appendix for the address list of all Internal Registers.

Timer

The **Timer** function can be used to control the time settings of a logic rule. Actions such as **START**, **STOP**, and **RESTART** can be configured here.

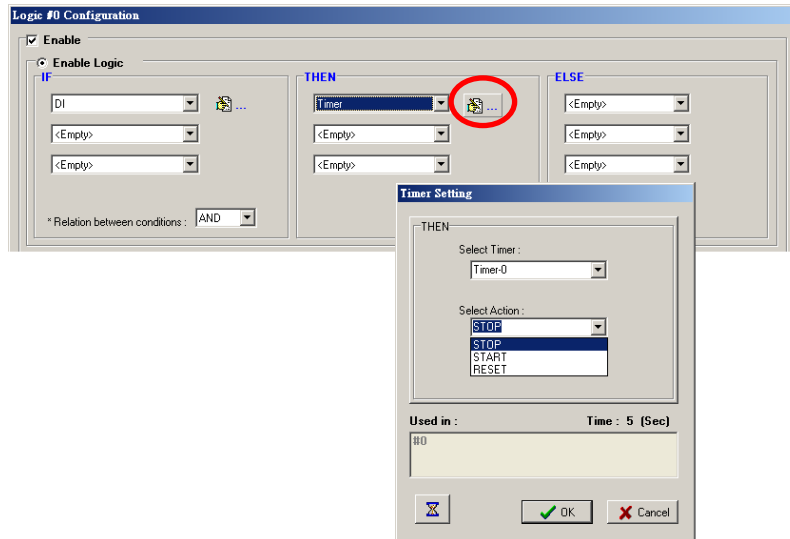

Select the IF condition for Timer and click on the property button () to enter the Timer Settings window.

In the above figure, the “Used in:” column indicates this Timer is also used in Rule-0, which helps the user identify the relationship between the rules. In addition, the Set Timer button () can be used to define the default value of the Timer.

NOTE The “STOP” operator stops the timer and returns to “0”, and the “RESTART” operator clears and restarts the timer.



ATTENTION

The STOP or RESTART operator should always be used to reset or to restart the timer. If you do not use these operators, the Timer function can only be triggered once.

SNMP Trap

The **SNMP Trap** function sends an SNMP trap to one or more IP destinations. The trap number can be any number between 1 and 20. (You may need to consult with your network administrator to determine how trap numbers will be used and defined on your network.) Select the THEN/ELSE action for SNMP Trap and click the property button (🔗) to enter the SNMP Settings window. You can also bind the status of up to three I/O channels within each trap. Click the Set SNMP button (📡) to specify up to 10 recipients for the SNMP trap.

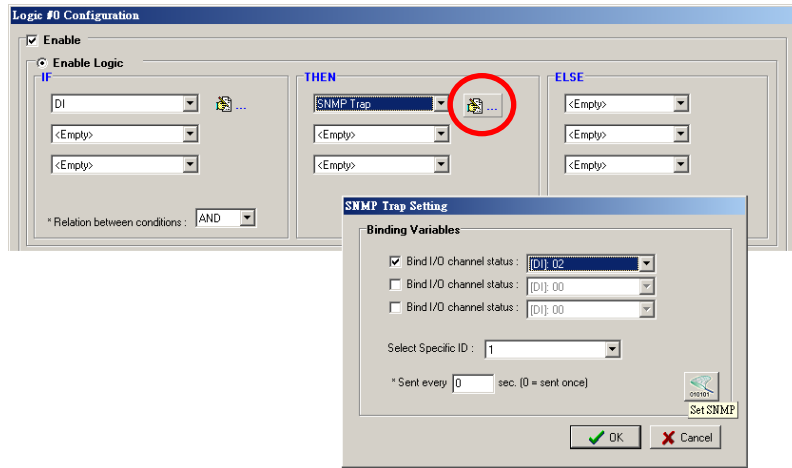

Active Message

In response to a proper IF condition, the **Active Message** function sends a customized message to one or more IP destinations by TCP or UDP packets. Select the THEN/ELSE action for Active Message and then click the property button (🔗) to enter the Message Content Settings window. Enter your desired message in the **Message Content** column. Dynamic fields such as time, date, IP address, and I/O status can be inserted in your message by clicking **Keyword Lookup**. Messages are sent in ASCII by default, but can be sent in HEX by selecting the “**Send as HEX (separated by ',')**” checkbox.

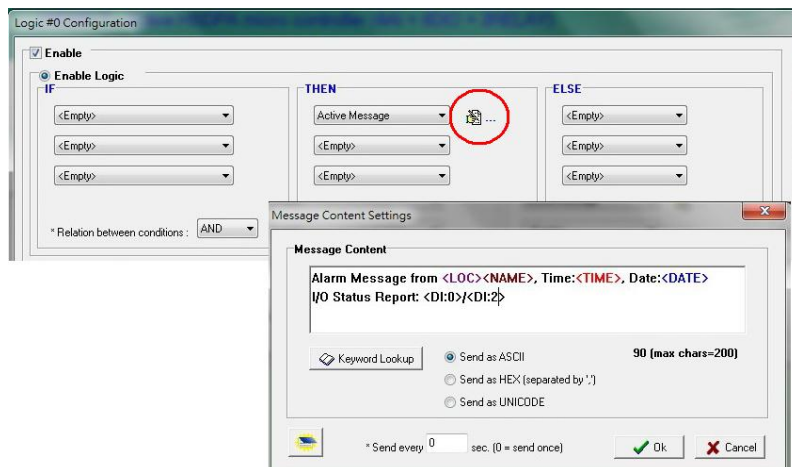

Click the Set Active Message button (📡) to configure the default parameters such as the messaging protocol (TCP or UDP), socket port (9000 by default), and the up to 10 target message servers.

Active Messages can be received by a program using standard sockets, Moxa MXIO library, or ioAdmin’s Message Monitor, as shown in the following screen shot:

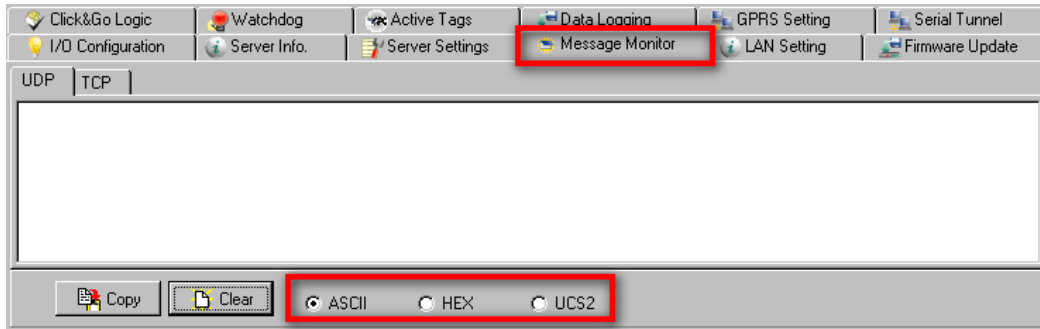

When sending a message in HEX, each HEX value must be separated by commas. View the incoming message on the Message Monitor panel and select the **HEX** checkbox. Note that certain numbers are control characters that will not show up in the Message Monitor. When sending a unicode message, the **UCS2** checkbox must be selected. View incoming messages on the **Message Monitor** panel and select the **UCS2** checkbox. Note that certain numbers are control characters that will not show up on the **Message Monitor** panel. The maximum number of characters is 200.

Email

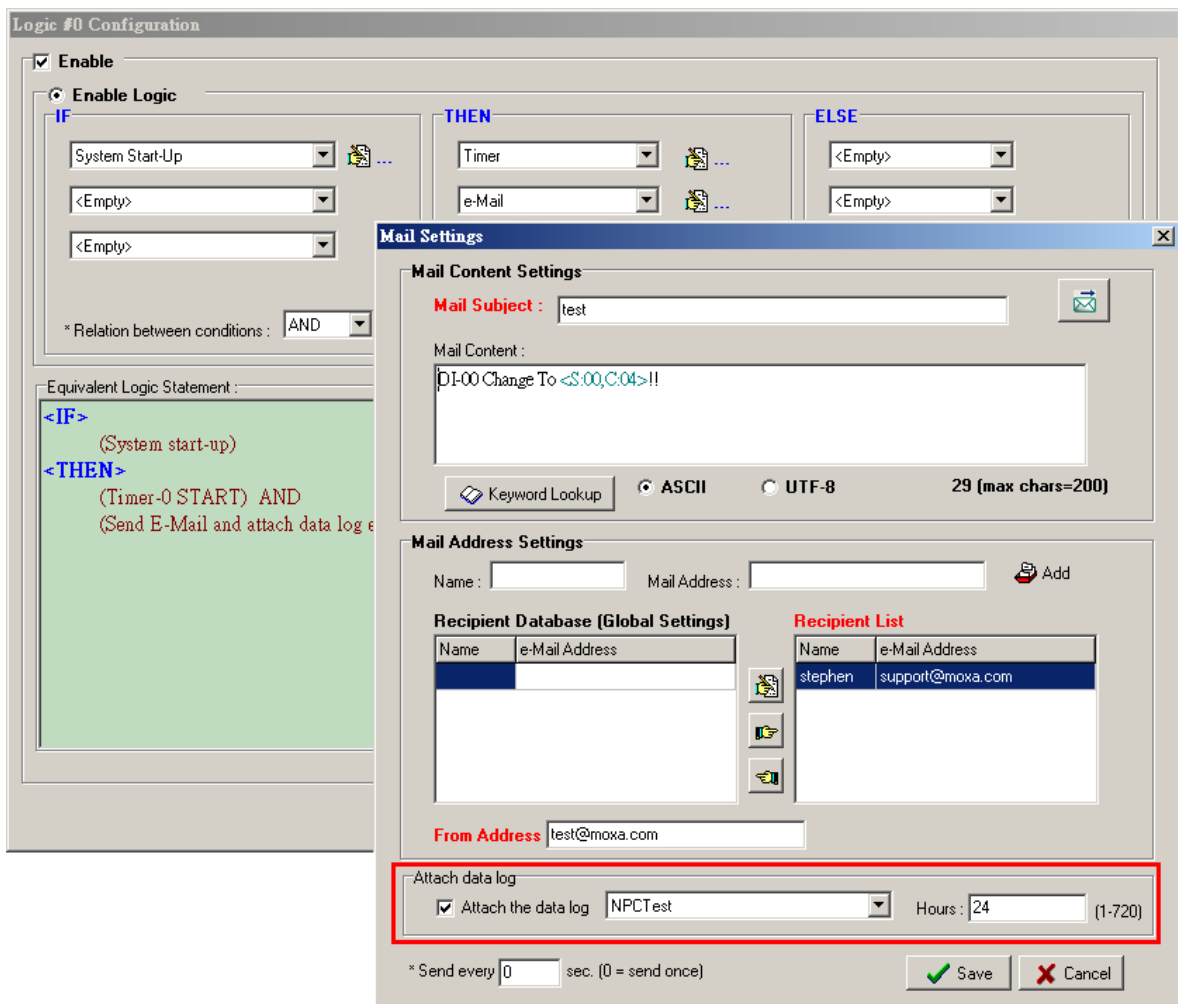

The **E-mail** function sends a customizable e-mail to one or more mail boxes or Blackberry devices. Select the THEN/ELSE action to e-mail and click the property button () to enter the Mail Settings window.



After entering the subject of an e-mail, enter the message in the **Mail Content** area. Dynamic fields such as time, date, IP address, and I/O status can be inserted in your message by clicking **Keyword Lookup**.

NOTE Content in the same logic entry can be sent by either Active Message or e-mail, in which case the content of the messages will be the same. If you would like to send an Active Message and e-mail based on the same event but with different content, you will need to use two separate logic entries—one for the Active Message and one for the e-mail.

SMTP server information including username/password, and the recipient database can be configured by

clicking the Set Mail Address button (). Click the finger icon () to move the selected address from the Recipient Database to the Recipient List.

To manually add e-mail addresses to the Recipient Database, enter the **Name** and **Mail Address** and click **Add**. Once the address has been added to the **Recipient Database**, use the finger icons to move it to or from the **Recipient List**. Select **Attach data log** to specify that the log profile and period will be attached to the email. Set **Hours** to 24 if you would like to receive all logs generated in the past 24 hours.

Short Message Service

The **Short Message Service** function allows the user to configure the SMS in detail, including selecting recipients from the phone book, defining the escalation and acknowledgements, and defining the content of the SMS. If you select **Send every__sec**, the SMS will be sent to all the recipients at the same time; if you select **SMS Escalation**, the SMS will be sent out in the sequence listed in the recipient list, and using the timeout interval. A recipient will stop receiving the SMS alarm when the preset maximum repeat times is reached, or when one receiver acknowledges receiving the SMS.

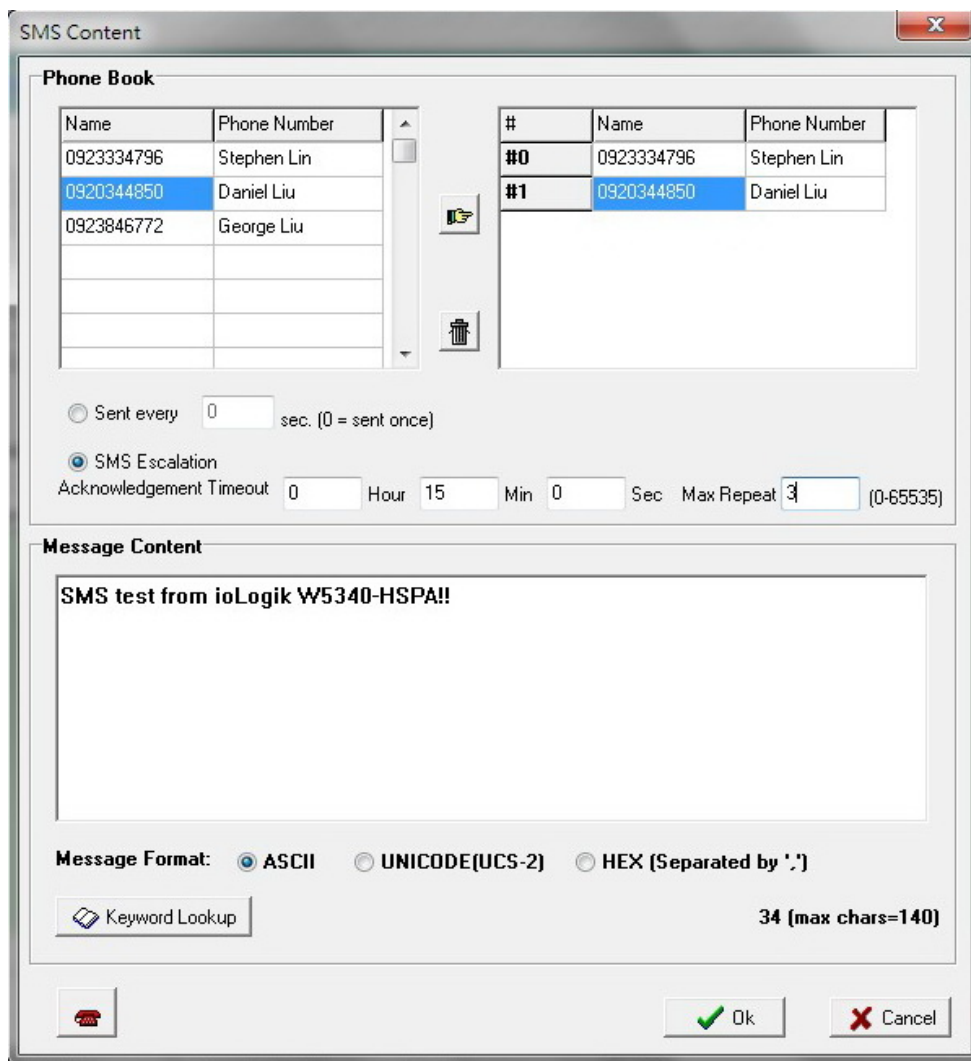

NOTE Send every means to send the SMS to all the recipients; SMS Escalation will send SMS to the recipients sequentially and wait for the response (acknowledgement).

Data Log Start/Stop

The **Data Log Start/Stop** function provides the capability to start or stop logging based on a specific event (IF Conditions), such as to start logging when the pressure (AI) reaches the maximum limit and to stop logging when it returns to normal.

FTP Service

The **FTP Service** function provides upload service for data log files stored on the SD card. Combining this function with Schedule or Timer in the IF condition will create periodical or scheduled uploads of the log file.

Profile: Select a pre-configured FTP server.

Hours: The ioLogik W5300 will send all the log files containing all the entries within this specified time period.

Send Every: The datalogging file will be sent every this number of seconds.

The following diagram gives an example. Log_01 to Log_05 were created by the same profile. If configuring the Hours to 24, the ioLogik will upload the entire Log_01, Log_02, and Current Log_03. In the Next 24 hrs, the ioLogik will upload the entire Log_03, Log_04, and Current Log_05. On the FTP Server, the Current Log_03 will be overwritten by the entire Log_03 when an additional 24 hrs has passed.

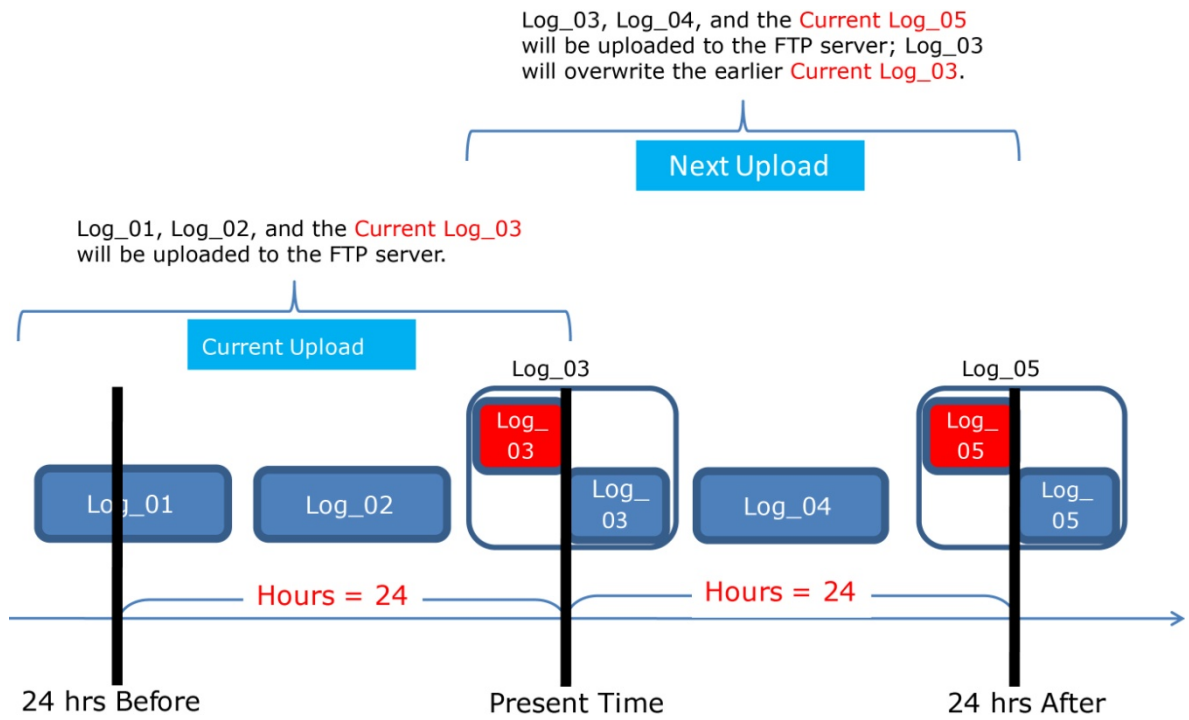

Activating the Rule-set

Upload, Restart, and Run

The rules that are displayed on the Click&Go Logic panel include the current rule-set, which acts as the brain of your ioLogik system. The rule-set must be activated as follows for the ioLogik to commence local control operation:

1. The rule-set must first be downloaded from ioAdmin to the ioLogik. To download the rule-set, click **Upload to ioLogik** from the Rule-set Management bar.
2. After the rule-set has been downloaded, ioAdmin will prompt to restart the ioLogik automatically after clicking “yes” to confirm. Do not use the reset button, since doing so will load all factory defaults and erase your rule-set from memory.

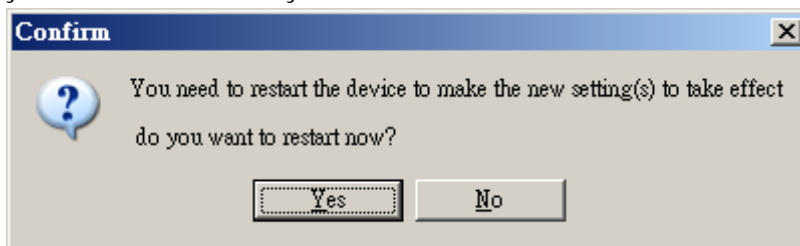

3. After the ioLogik has been restarted, the rule-set must be activated. Log in to ioAdmin as administrator, go to the Click&Go Logic panel and click **Run** in the Rule-set Management bar. The rules in the rule-set will now be active.

When the rule-set has been activated, it will remain active even when the ioLogik is disconnected from the host computer or from the network. If the ioLogik is turned off, cellular I/O operations will resume when it is turned back on, allowing you to use the ioLogik W5300 for PC-independent automation.

Rule-set Management Bar

When the rule-set has been activated from the Click&Go panel it will remain active even when the ioLogik is disconnected from the host computer or from the network. If the ioLogik is turned off, cellular I/O operations will resume when it is turned back on, allowing you to use the ioLogik W5300 for PC-independent automation.



- **Clear:** Erases the rule-set in both ioAdmin and the ioLogik W5300 series.
- **Retrieve:** Copies the rule-set from the ioLogik W5300 into ioAdmin.
- **Upload to ioLogik:** Copies the rule-set from ioAdmin to the ioLogik W5300.
- **Run:** Activates the rule-set that the ioLogik booted up with.
- **Stop:** De-activates the Click&Go rule-set and returns the ioLogik to normal, passive operation.

Import/Export Configuration

The ioLogik's system configuration, including the current Click&Go rule-set, can be imported and exported. As you make changes to a rule-set, you can export the system configuration in order to save that rule-set. Details can be found in Chapter 2.

Log in as ioAdmin administrator from the **Server Settings** panel. You must log in as administrator to gain access to the ioLogik's configuration options. If a password has not been configured, simply click **Login** and leave the **Password** entry field blank.

NOTE Since there are major structural changes between firmware versions, configuration files generated by firmware versions preceding V1.2 (included) for the ioLogik W5312 series, and firmware V1.4 (included) for the ioLogik W5340 series, cannot be imported to the latest version of the firmware.

Planning and Assistance

In this chapter, we will provide variety of real-life scenarios to help explain to you how to use the ioLogik W5300 to configure your system.

The following topics are covered in this chapter:

- ❑ **Known Issues of Cellular Monitoring Systems**
- ❑ **Active OPC Server with a Static IP Address**
- ❑ **Cellular Remote I/O Architecture**
- ❑ **Using ioAdmin to Perform Simple Data Monitoring from a Remote Site**
- ❑ **Expanding Input/Output Channels**
- ❑ **Using Modbus/TCP Protocol with Your Program**
- ❑ **Using the Counter to Get Meter Readings and Statistics**
- ❑ **Record your I/O Data in the Data Log File**
- ❑ **Connecting a Modbus/RTU Serial Device Attached to the ioLogik over a Cellular Network**
- ❑ **Connecting to a SCADA System**
- ❑ **Updating Serial Tags to SCADA System with Active OPC Server over a Cellular Network**
- ❑ **Handling Front-End Events and Alarms**
- ❑ **SMS Escalation and Acknowledgement**
- ❑ **SMS Commands for Monitoring and Control**
- ❑ **Enabling the Power Saving Function and Secure Wake on Call**
- ❑ **Enabling Ethernet and Cellular Redundancy**

Known Issues of Cellular Monitoring Systems

Cellular technology is well-suited for remote monitoring and alarm systems that cover a wide area, such as pipeline monitoring of public water supplies or natural gas systems. Using cellular technology to implement a remote monitoring system can save development, deployment, and maintenance time.

However, problems such as dynamic IPs, low bandwidth, and unexpected disconnections must be overcome for the cellular monitoring system to achieve greater stability.

Known Issue 1: Dynamic or Private IP over a Cellular Network

Although cellular technology can make device communication easier, cellular networks were not designed for industrial devices, but for mobile phones. Since mobile phones only need a temporary IP to connect to the Internet, cell phones get a different temporary IP each time the mobile phone accesses the Internet. This is referred to as the Dynamic IP issue. Most telecom service providers assign temporary IPs when a mobile phone requests access to the Internet. A remote monitoring system using a cellular communications ioLogik W5300 should request a permanent IP to ensure stable bidirectional communications. For this reason, you may need to apply for a special data plan from the service providers or the mobile virtual network providers (MVNOs).

As opposed to using the so-called "pull" or "passive" architecture, Moxa's ioLogik W5300 utilizes active edge communications, which works with the powerful cellular device management middleware, Active OPC Server. **Active OPC Server runs on a central network computer that uses a static IP.** Even if the cellular I/O units work in a dynamic or private IP environment with a general data plan that is for a mobile phone, since the ioLogik W5300 contacts the Active OPC Server (and not the other way around), once a connection is established the two sides of the connection can proceed with bi-directional communication. In addition, the built-in front-end intelligence called Click&Go control logic enables the ioLogik to report its I/O status, and send alarms and log data actively. Centralized software such as a SCADA system is now able to leverage this technology by connecting the Active OPC Server using Modbus/TCP or OPC Client Drivers instead of connecting to the remote ioLogik's IP address directly.

Known Issue 2: Low Bandwidth and slow response time

Cellular networks provide only low bandwidth transmission compared with wired CAT-5 Ethernet networks. Generally speaking, the response time of the GPRS network is about 4 to 10 seconds, and 1 to 3 seconds for 3G/HSPA networks.

This means that the latency of data for one round trip is much slower than a millisecond level Ethernet network, resulting in system overload or shutdown when a large number of remote sites and large amount of information need to be exchanged. A better approach is to use an "active" architecture such as the ioLogik, and the Active OPC Server to reduce traffic and improve response time and decrease the use of the bandwidth.

Another factor that could cause unexpected disconnection is the cellular signal strength. In some places, several communication channels could exist simultaneously, with each device accessing a different channel and using a different signal strength. This kind of random signal strength could result in unexpected disconnection.

SMS (short messages) will not respond in time as expected, especially when using a data plan that is only for data transmission or at specific times, such the end of the year, when traffic volume is much higher.

Known Issue 3: Unexpected Disconnection from Cellular Networks (Carriers)

Although cellular network transmissions are charged by number of packets and not connection time, most vendors still refer to their service as "Always On." However, a better description might be "always accessible" since in reality, cellular carriers optimize their IP resources, time slots, and the base station capacity by disconnecting connections that have been idle for a certain period of time. During this period, the mobile devices will not be aware of the disconnection, and this lapse in the actual connection could introduce a certain amount of unreliability in your remote monitoring and alarm system. If using "Always On" to keep your connection alive is not stable enough for your purposes, you must configure additional "Cellular Reconnection" settings to prevent being kicked off the network accidentally or without notification. See Chapter 4 for detailed settings.

Known Issue 4: Large Power Consumption when Attached to Base Stations

There will be a peak power usage when attaching to base stations (900 mA @ 12 VDC). Although the ioLogik uses a low amount of power during normal usage (3-4 watts), we still recommend using a power supply that is greater than 5 watts.

Active OPC Server with a Static IP Address

Configuring an ioLogik W5300 for use with an Active OPC host using a static IP address will ensure that the ioLogik W5300 works properly in any of the following environments:

1. Virtual Private Network

A VPN (Virtual Private Network) is a service that groups all related devices into one network, but users need to purchase cellular on-line services and apply for VPN membership. When the Cellular device dials up, it will get a private static IP assigned by the telecom service provider (Carrier or MVNO). The private IP is on the same network segment as the host. The host and devices can communicate bi-directionally using a polling architecture. Most telecom service providers will not offer small volume service packages to enterprise clients. A mobile virtual network operator (MVNO) is a company that provides cellular services but does not have its own licensed frequency allocation of the radio spectrum, and does not necessarily have the infrastructure needed to provide mobile telephone services. An MVNO subscribes to several cellular services and then rents the services out to customers who only need a small quantity of IP service. Normally, the MVNO also builds up a VPN server to separate their groups, and in effect provide the same services provided by a VPN.

2. Network with Public Static IP Devices

A Public Static IP can be accessed anywhere and anytime, such as over the Internet. Although most carriers use private dynamic IPs for mobile phones, some carriers will provide Public Static IPs for specific applications. The downside of Public Static IP service is that it comes at a much higher price. Some telecom service providers can assign a fixed IP to one specific SIM card. While all I/O devices have their own fixed IP address, the entire system will run as a traditional monitoring system with physical wires. This solution has the benefit exhibiting the same behavior as a wired solution. However, not all telecom service providers offer this kind of service, and those that do offer it at a relatively high cost.

3. New Cellular Network with Active Architecture

A new type of cellular network based on push technology is now available. This type of service requires a host PC with a public static IP, allowing all remote cellular devices to connect to the host PC, regardless of whether or not the device has a public or private IP. The Active OPC Server software running on a PC with a static IP is required to update the devices' IP and the fixed device name. After connecting to the cellular network, all operations can follow the original infrastructure of the mobile phone provider. Moxa's ioLogik W5000 series cellular remote I/O units are based on push technology with Active OPC Server. Active OPC Server, which runs on a PC with static IP, will receive and register the device's IP and create a connection while the ioLogik W5300 is on line. Once the connection has been created, bi-directional communication can ensue. The built-in front-end intelligence, Click&Go logic, enables the ioLogik to report its I/O status, alarms, and log data actively.

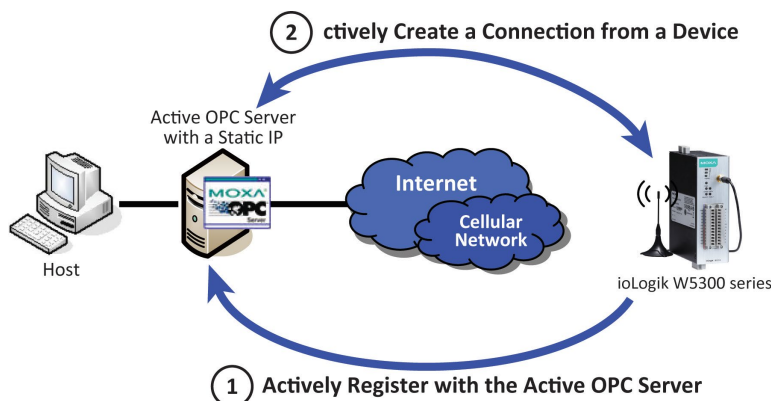

NOTE If the Active OPC Server is installed in the DMZ or even the LAN, be sure to configure the router or firewall settings to allow and redirect those necessary TCP ports such 9300, 9900, 9500, and 502 for remote access from the ioLogik W5300. See Appendix F for details.

Cellular Remote I/O Architecture

The following diagram illustrates the overall architecture of the ioLogik 5300 series cellular remote I/O device. The ioLogik 5300 supports remote monitoring, and you can configure the machine via ioAdmin and connect to a SCADA system through an OPC client/server or Modbus/TCP. You can push datalog files to the FTP server, and connect field serial devices through a serial tunnel. In addition, the ioLogik W5300 supports event alarms by email, SNMP Trap, and SMS.

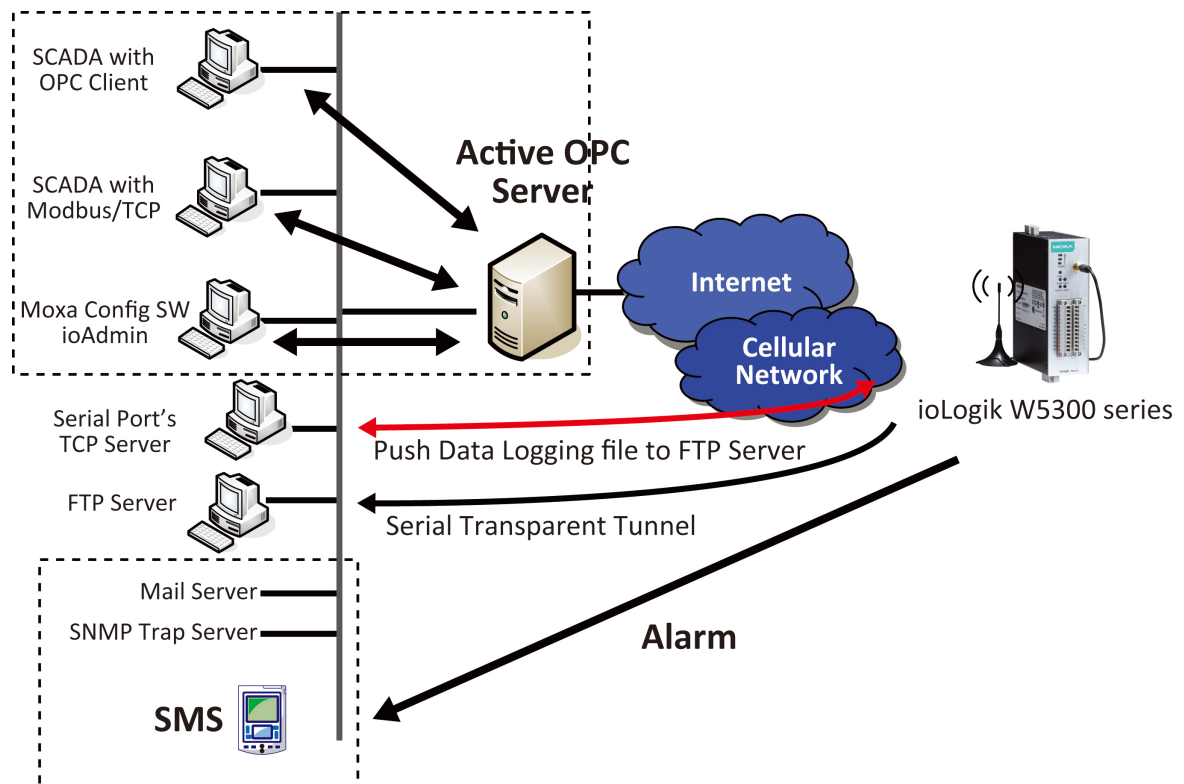

In the following sections, we illustrate how to set up an environment for the ioLogik W5300.

Using ioAdmin to Perform Simple Data Monitoring from a Remote Site

Scenario: Users would like to check the I/O status at the central site. The ioAdmin monitoring and configuration utility will be used to monitor the remote site I/O status. The related network structure and diagram are shown below.

Environment:

1. Active OPC server: Public Static IP: 59.124.42.169
Internal Static IP: 192.168.19.19
2. Central site: Internal Static IP: 192.168.19.207

Diagram:

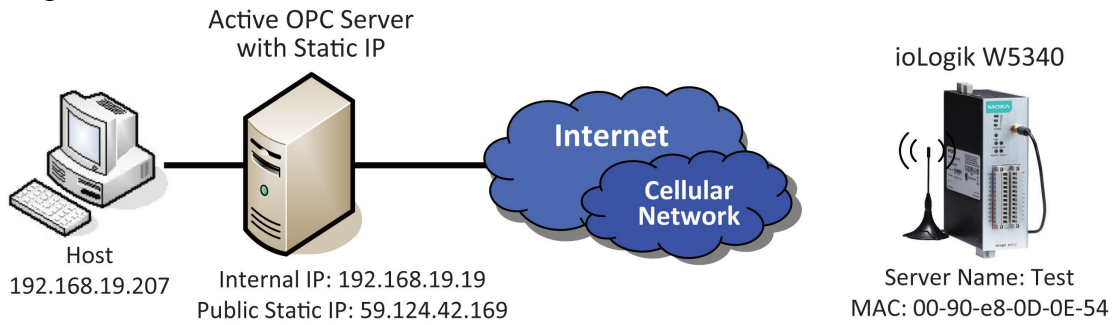

Implementation:

- Step 1:** Following the instructions from Chapter 2, insert a SIM card and connect the sensors.
- Step 2:** Install and run ioAdmin on the remote host.
- Step 3:** Connect the host to the ioLogik W5340 over the Ethernet console.
- Step 4:** Configure the **Cellular settings**, including the **Dial-up settings** and **Operation Modes**.
- Step 5:** Enter the host's server address on the **Active Tags** panel, as the Active OPC Server address.
- Step 6:** Install the AOPC Server on a PC with a static IP address, and ensure the IP address of the AOPC server is available and accessible from the remote ioLogik.
- Step 7:** Before starting the Active OPC server, make sure that any local routers or firewalls which it is running behind are configured to forward TCP ports 9900, 9500, 9300, and 502.
- Step 8:** Start ioAdmin and add Active OPC server manually.

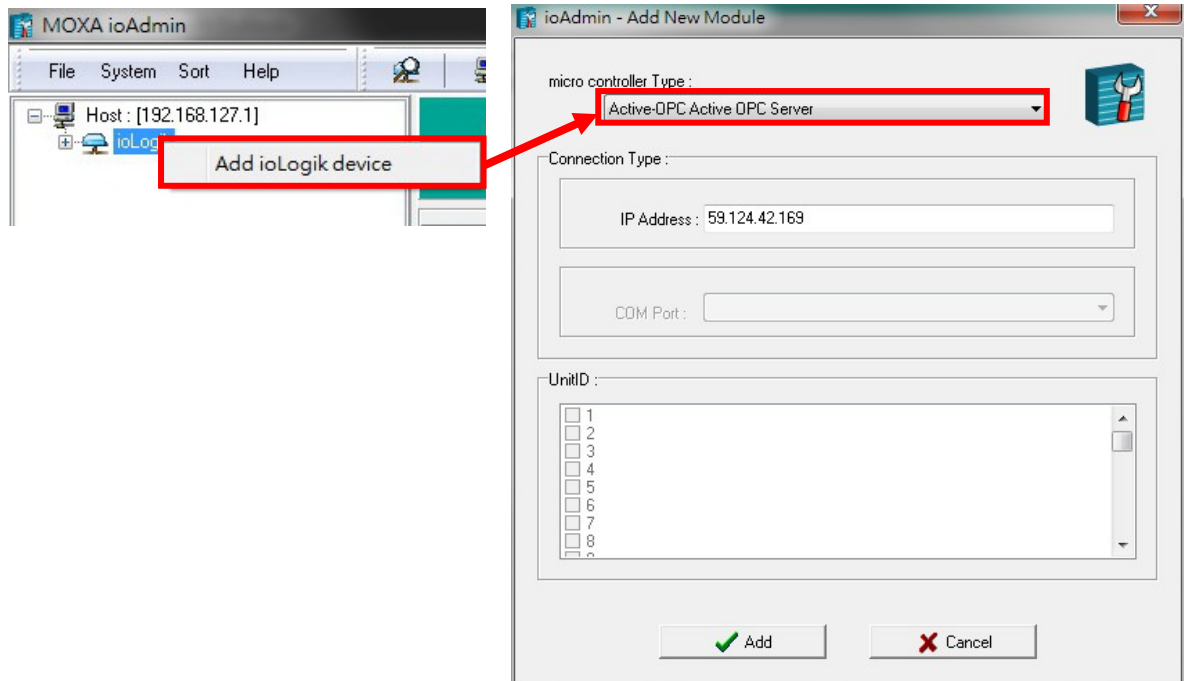

Note: Selecting "AOPC" from the broadsearch menu is also OK if the AOPC and the ioAdmin are installed on the same PC or the same local network.

Step 9: After adding Active OPC Server you should see the following screen. Click the **Refresh** button to use ioAdmin to monitor and configure the ioLogik W5300.

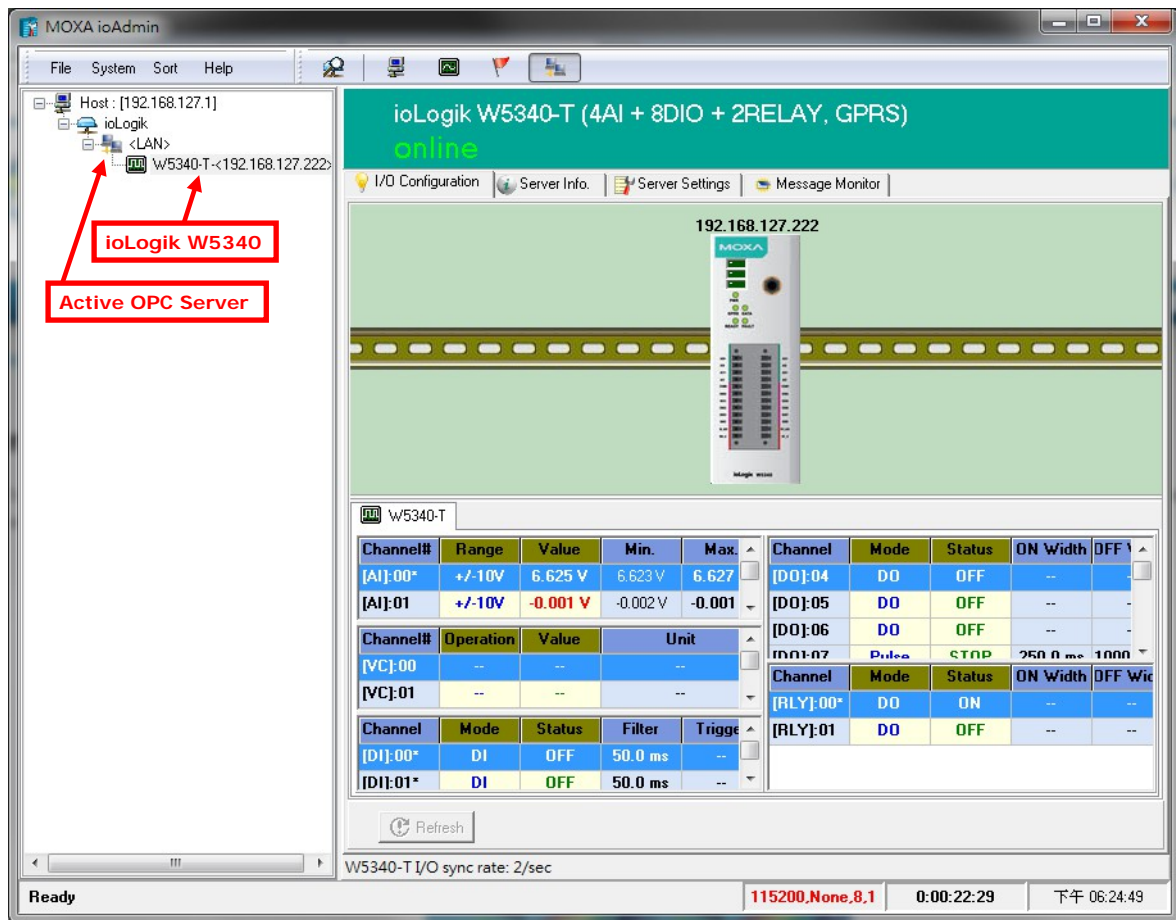

Expanding Input/Output Channels

Scenario: A monitoring system for a pumping station does not have enough I/O channels, and the user would like to add more I/O channels to meet system requirements. In addition to the existing 4 AIs, 8 DIos, and 2 Relay Outputs, they are using the ioLogik E1210 and E1211 to add an additional 16 DIos and 16 DOs.

Implementation:

Step 1: Connect to the ioLogik E1210 and E1211 and start the Web Consoles for these two products.

Step 2: Configure and export the configuration files of these two models. The file names will be ik1210.txt and ik1211.txt.

Step 3: Use Ethernet cables to daisy-chain the W5340, E1210, and E1211, and connect to the host PC through the E1211's Ethernet port.

Step 4: Start ioAdmin with the selected W5340 and choose **I/O Expansion**.

Step 5: Click the **Expansion Modules** row and then click the **ADD** button. ioAdmin will prompt you to import the E1200 series configuration.

ioLogik W5340-T (4AI + 8DIO + 2RELAY, GPRS)
online

Cellular Reconnection | Network Statistics | Watchdog | Message Monitor
 Server Settings | Firmware Update | LAN Settings | Cellular Settings
 I/O Configuration | **I/O Expansions** | Meter/Sensor | Active Tags | Click&Go Logic | Server Info.

Expansion Modules

Slot#	Module	Connection	Description	Status
1	E1211	192.168.127.252	Ethernet Remote I/O(16DO)	online
2	--	--	--	--
3	--	--	--	--

* You must restart the device for new change(s) to take effect

Add Remove

Modbus Addresses

Slot#	Channel	Type	Address(hex)	Address(dec)	Quantities
1	DO-00	Coil	0x0200	000513	1
1	DO-01	Coil	0x0201	000514	1
1	DO-02	Coil	0x0202	000515	1
1	DO-03	Coil	0x0203	000516	1
1	DO-04	Coil	0x0204	000517	1
1	DO-05	Coil	0x0205	000518	1
1	DO-06	Coil	0x0206	000519	1

* The addresses will be update on next system restart.

Export Refresh

W5340-T I/O sync rate: 2/sec

Step 6: In the open file window, choose the configuration file for the E1210 (e.g., ik1210.txt).

Step 7: You can find the E1210 in the “Expansion Modules” table. Repeat steps 5 and 6 to add the E1211.

Step 8: After adding the E1210 and E1211, reboot the W5340 to activate this function.

Step 9: After rebooting, log in to ioAdmin as Administrator and choose "I/O Configuration." You will see the following screen, which indicates that the additional I/O channels were successfully installed.

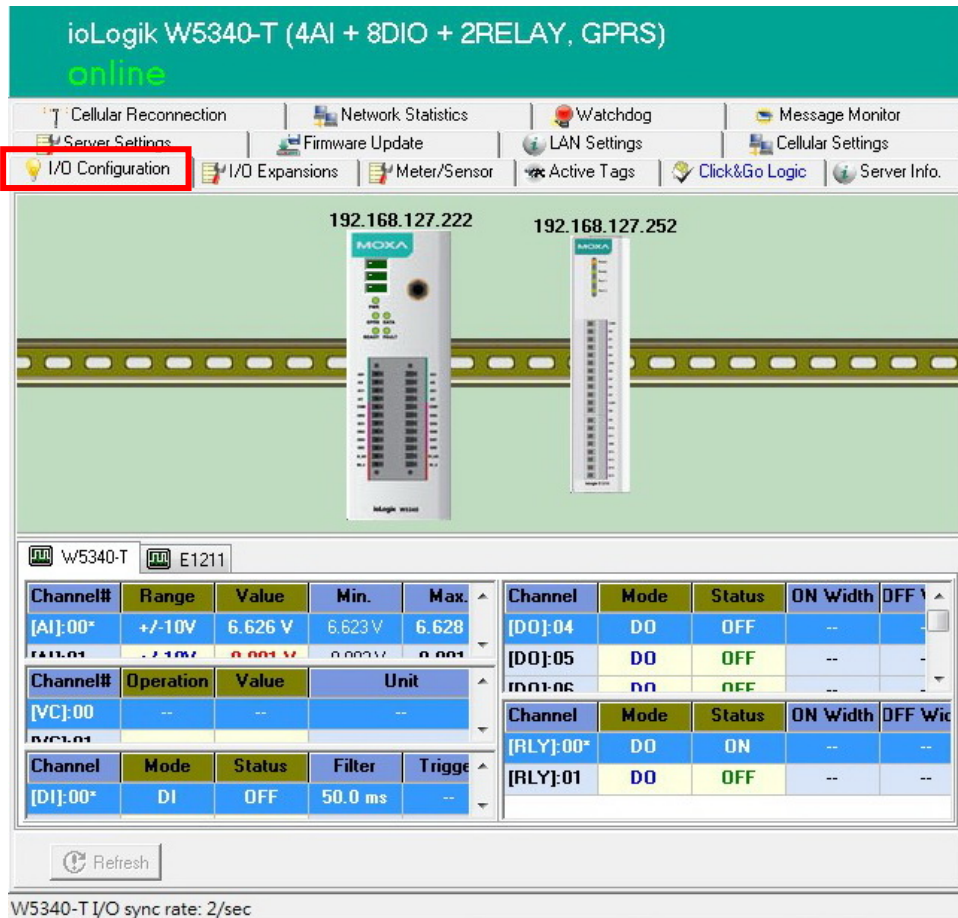

Step 10: Click&Go will continue running when the connection between the ioLogik W5300 and expansion modules is down. You can use the trigger condition "Expansion module connection fail" to let Click&Go warn you when the connection is down. To do this, choose the Click&Go Tab, adding the rules as shown in the following figure.

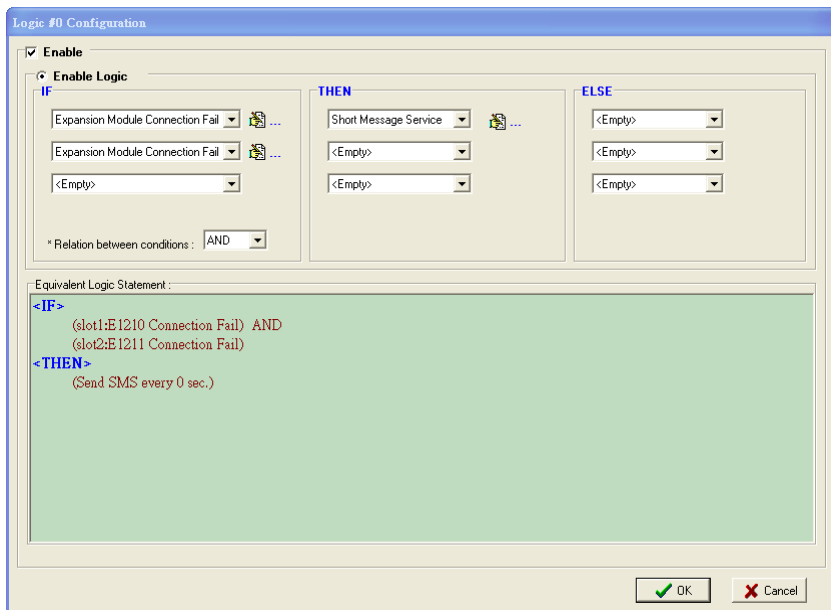

Step 11: Save the logic settings and restart the system. After restarting, click the "Run" button on the Click&Go panel to make sure the Click&Go rule is running.

Step 12: When a disconnection occurs, an SMS alarm message will be sent to the predefined mobile phone.

NOTE Three devices can be added to the “Expansion Modules” table in any order. The slot No. is based on the order of the list, and does not depend on the order in the which the expansion modules were added.

NOTE The following ioLogik E1200 models are supported for the I/O expansion: E1210 (16 DIs), E1211 (16 DOs), E1212 (8 DIs and 8 DIOs), E1213 (4 DIs, 4 Source DOs and 4 DIO (source DO)), E1214 (6 DIs and 6 Relays), E1240 (8 DIs), E1241 (4AOs), E1242(4AI, 4DIs, and 4DIOs), E1260(6RTDs), and E1262(8TCs). (Plus all Wide-Temperature ioLogik 1200 models)

Using Modbus/TCP Protocol with Your Program

Scenario: Most customers would like to use their own HMI program to collect relevant information from different remote sites. The most common way of doing this is to use Modbus/TCP. The following example illustrates the procedure:

Environment:

1. Active OPC server: Public Static IP: 59.124.42.169
Internal Static IP: 192.168.19.19
2. Central site: Internal Static IP: 59.124.42.169
3. W5300 IP: 116.59.60.232 (a public IP is required)

Diagram:

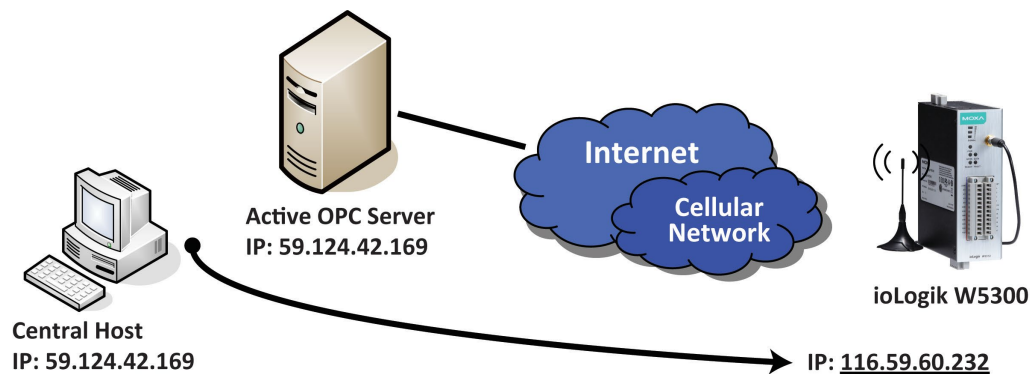

We use ModScan32 to illustrate (ModScan32 is a product of WinTech, and can be downloaded from the WinTech website).

Step 1: Install ModScan32 on your central host, with IP address 59.124.42.169.

Step 2: Set up your ioLogik W5300 as follows:

- Connect DO-4 to DI-0 and DI-1
- Set DO-4 as 1Hz pulse output.

Step 3: Power on the W5300 and check the I/O status in ioAdmin. The status of DI-0 and DI-1 should have changed to 1 Hz frequency.

Step 4: Configure the cellular settings on the Cellular Settings panel and the Active OPC Server’s IP Address on the Active Tags panel, and then restart the ioLogik W5300. After restarting the system, the ioLogik W5300 should be assigned an IP address.

Step 5: If step 4 was completed successfully, remove the Ethernet console cable to force the W5300 get a response from the cellular network.

Step 6: From your computer’s command line mode, ping IP address 116.59.60.232. If the ping is successful, proceed to the next step.

NOTE Some service providers (carriers) forbid and will filter this action.

Step 7: Click on the ModScan32 icon to open ModScan32, as shown below.

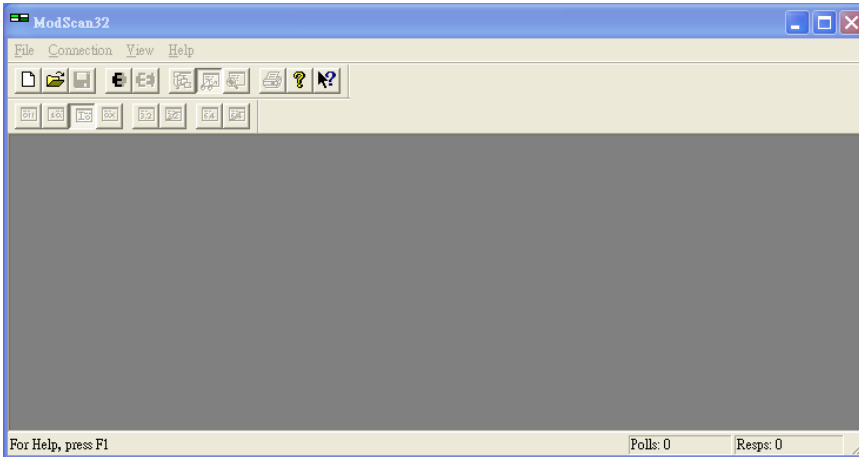

Step 8: Click **Connection** on the toolbar and choose **Remote TCP/IP server** in the **Connect Using** column. Input the W5300's IP address in the **IP Address** column and then click **OK**.

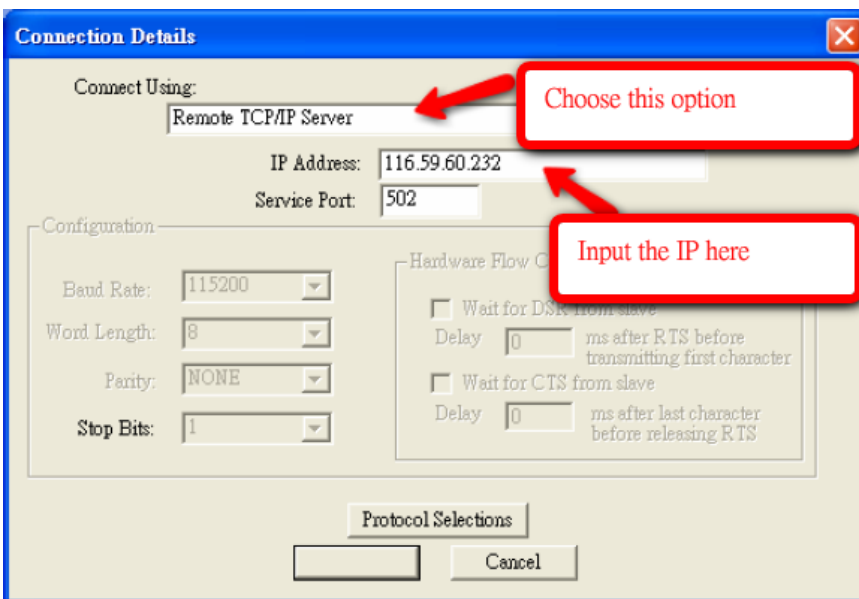

Step 9: Choose **New** from the **File** menu.

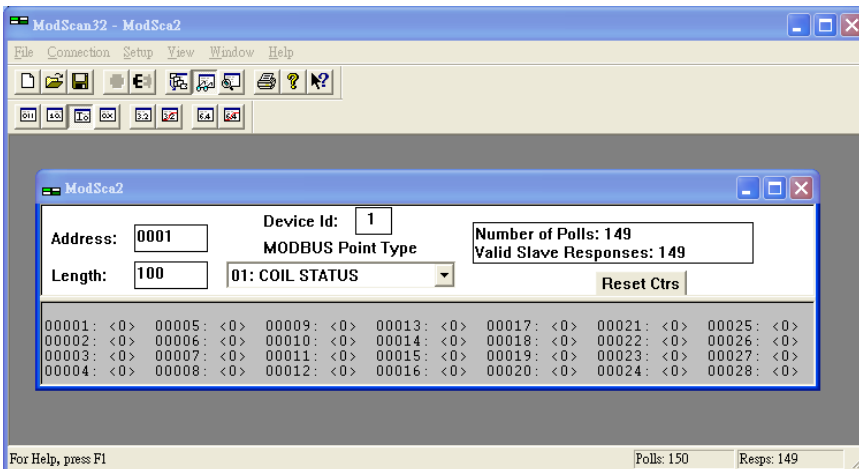

Step 10: Look up the DI-0 and DI-1 Modbus addresses in the user's manual, as shown below.

▪ 8.2. 1xxxx Read only Coils (Support function 2)

Reference	Address	Data Type	Description
10001	0x0000	1 bit	CH0 DI Value
10002	0x0001	1 bit	CH1 DI Value
10003	0x0002	1 bit	CH2 DI Value
10004		1 bit	CH3 DI Value
10005		1 bit	CH4 DI Value
10006		1 bit	CH5 DI Value
10007		1 bit	CH6 DI Value
10008	0x0007	1 bit	CH7 DI Value
10013	0x000C	1 bit	CH0 AI LED 1: On 0: Off
10014	0x000D	1 bit	CH1 AI LED 1: On 0: Off
10015	0x000E	1 bit	CH2 AI LED 1: On 0: Off
10016	0x000F	1 bit	CH3 AI LED 1: On 0: Off

Step 11: Input relevant information.

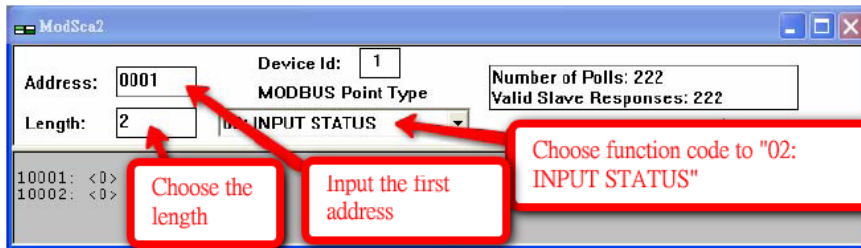

Step 12: Choose the **Setup** option from the toolbar and click on **Data definition**. Next, change the **Scan Rate** value from 1000 ms to 200 ms.

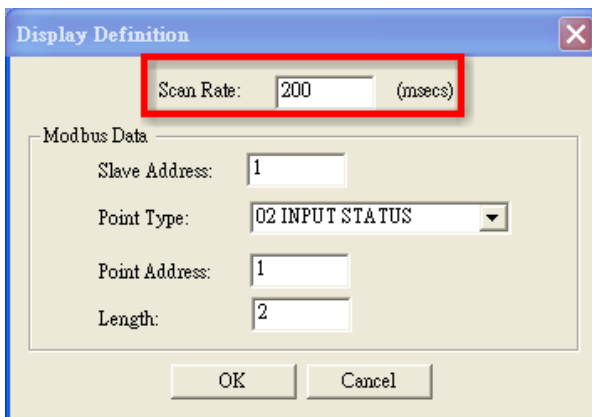

Step 13: You should now be able to see the DI-0 and DI-1 real time status.

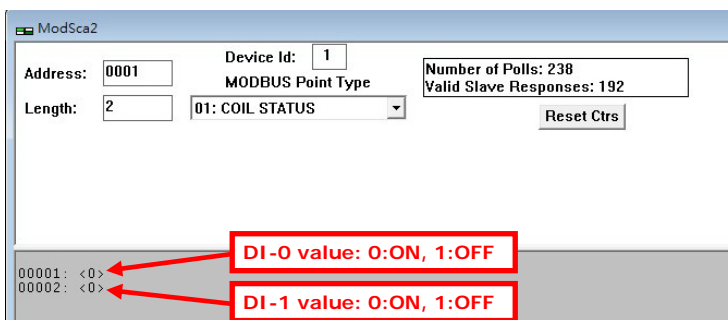

Using the Counter to Get Meter Readings and Statistics

Scenario: In water pipeline monitoring applications, water flow volume is a very important monitoring factor, since it can be used as an indication of leaking. The sensor used to monitor water flow volume is called a flow meter. Most flow meters have a pulse output of 4 to 20 mA signal output, which the user needs to convert to water flow in their own PC software. In this case, we will show you how to use the ioLogik W5300's virtual channel function to convert the counter input signal to the actual flow volume.

Setup Procedure:

Step 1: Open ioAdmin and set up your ioLogik W5300 as follows:

- Connect DO-4 to DI-0.
- 1.2. Configure DO-4 for 1 Hz pulse output.
- 1.3. Configure DI-0 for counter input mode.

Step 2: We assume that DI-0 is already connected to the flow meter.

Step 3: Right click on DI-0 from the **I/O Configuration** panel.

Step 4: Select the **Counter Scaling** tab in the popup window.

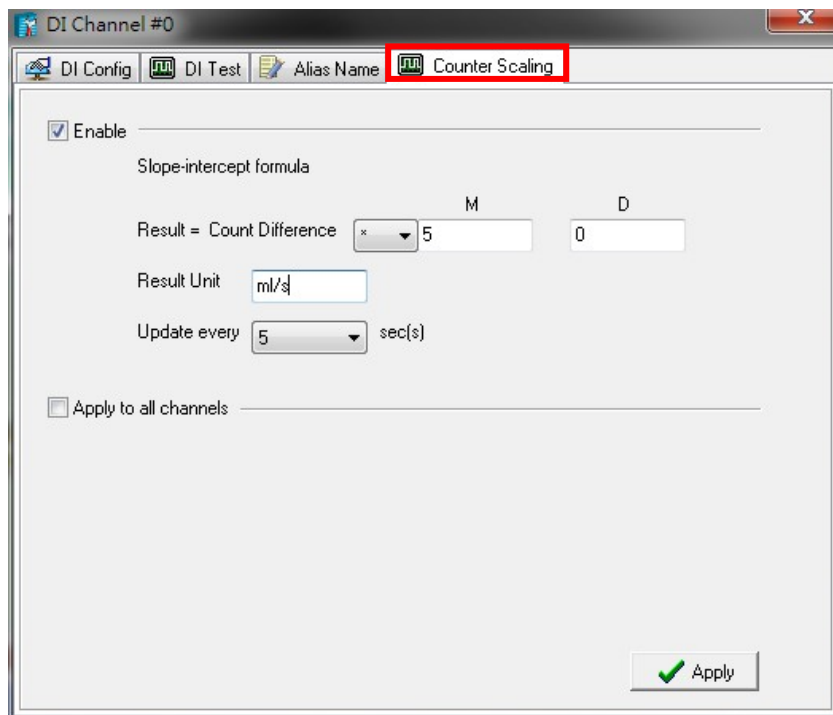

Step 5: Configure the scaling formula and update the sampling time.

Step 6: Close the popup window.

Step 7: Choose virtual channel (shown as VC-00), and select the source channel. We use DI-00 for this example.

Step 8: Select the operation mode from Max, Min., Average, Accumulation, Instantaneous, and Incremental.

Step 9: Close the popup window.

Step 10: Check the value on the I/O configuration Panel. The virtual channel value can be updated to AOPC with the Active Tags function.

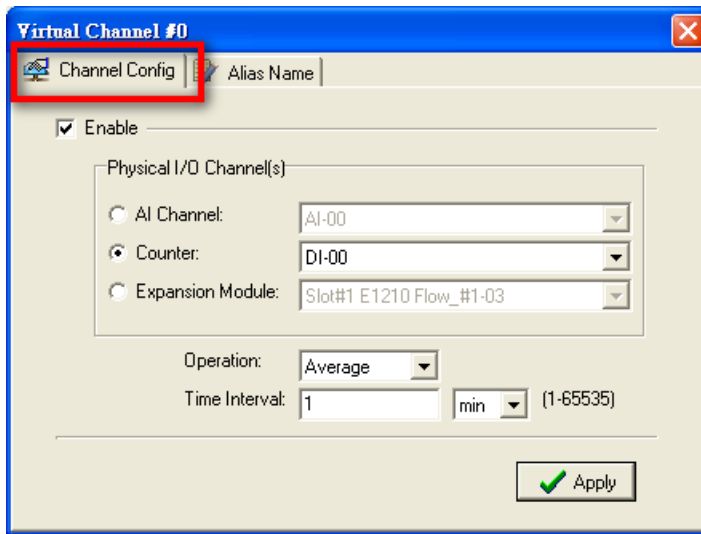

Record your I/O Data in the Data Log File

Scenario: A cellular communication system has lost its connection unexpectedly. If the user stores data in a PC database, the database may lose data when the cellular network is disconnected. For this reason, the ioLogik W5300 provides a front-end data logging function with its own built-in SD slot for storing the I/O data. The data file can be uploaded to the host PC via the FTP protocol and Click&Go logic. By using the SD card solution, users can avoid the “missing data” problem that plagues traditional solutions.

Log Profile Creation

Step 1: Insert a 2 GB or smaller SD card into the SD slot, and insert a SIM card.

Step 2: Start ioAdmin in administrator mode. Configure the Cellular Settings first.

Step 3: Go to the Click&Go tab and click on the Data logging icon on the Global Variable Toolbar.

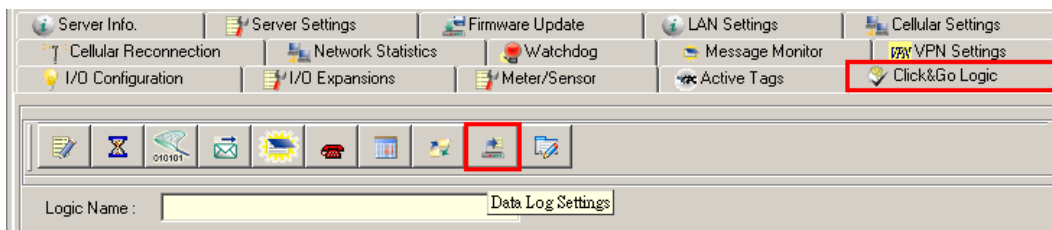

Step 4: Click the **New** button to create a new log profile.

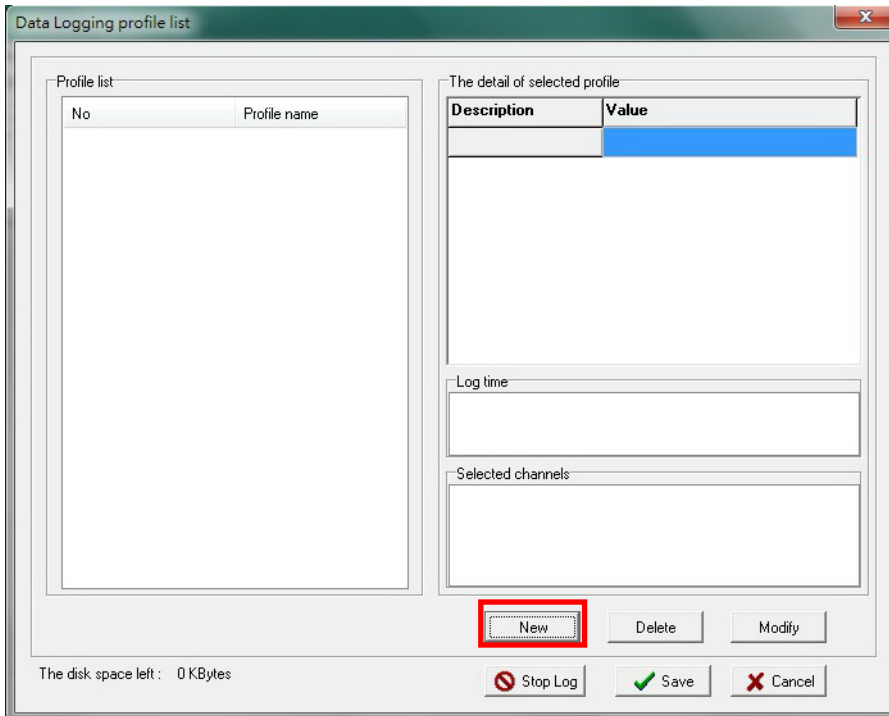

Step 5: In the new profile, click **Enable** to activate the profile, specify the settings, and then click **Next** to proceed.

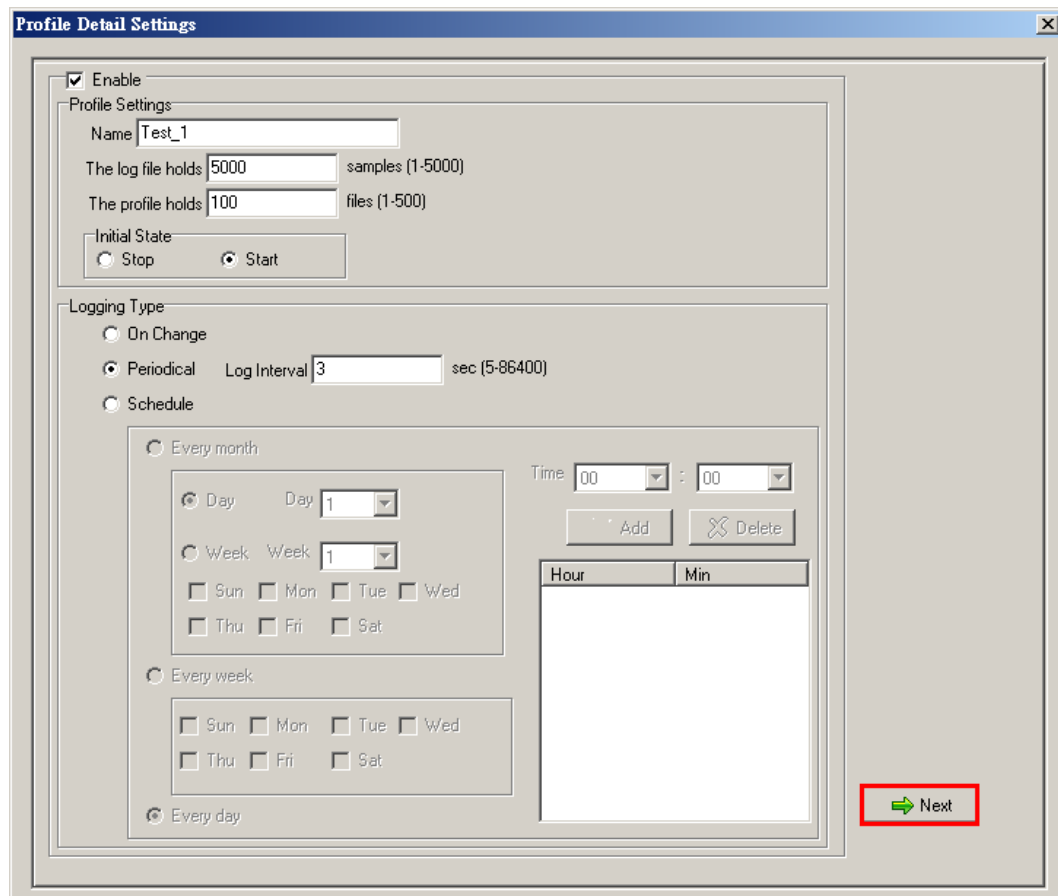

Step 6: Select the channels that needed to be logged, and then click the **Finish** button.

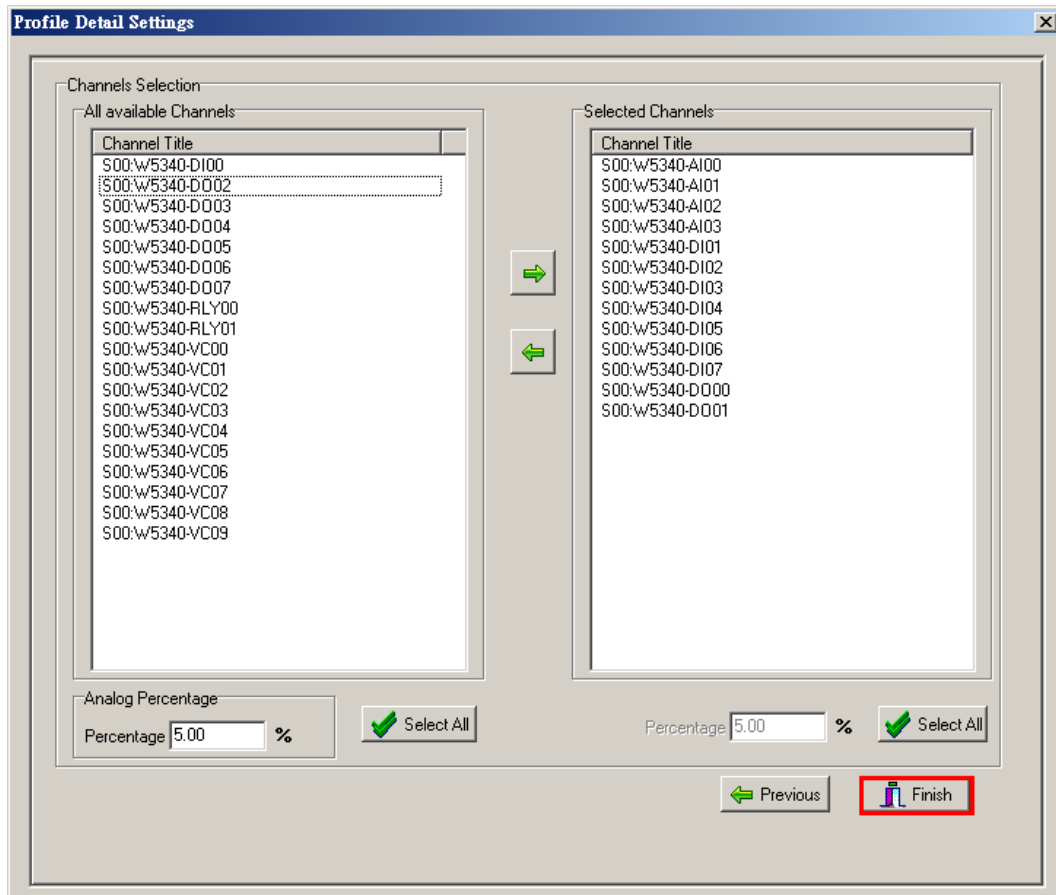

Step 7: Click the **Save** button.

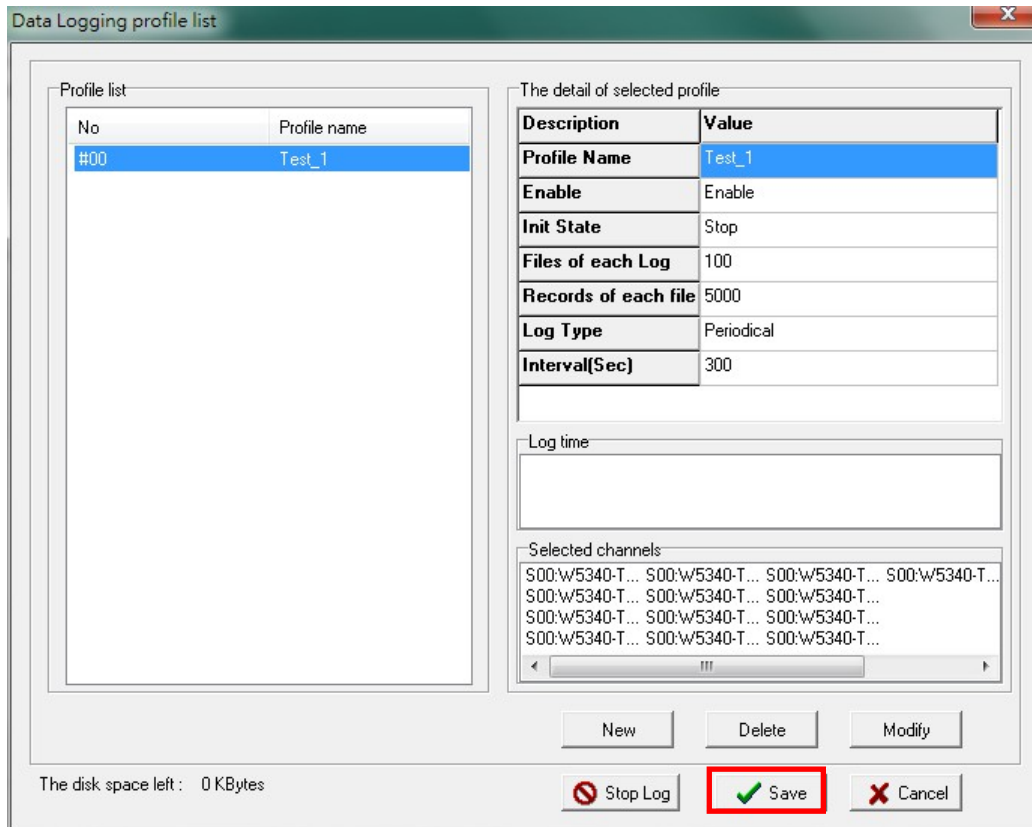

If you select **Start** for the initial state in Step 5, data logging will start immediately when the profile is created.

Log File upload with FTP

Step 1: Click the FTP settings icon on the Click&Go Global Variables toolbar.

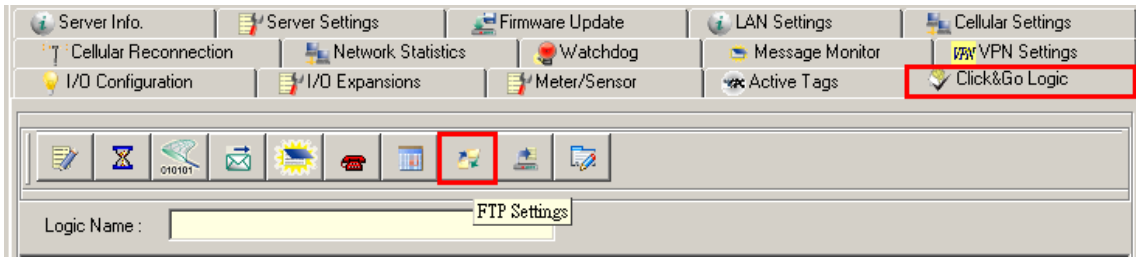

Step 2: Specify the FTP server address and account, and then click **Add**.

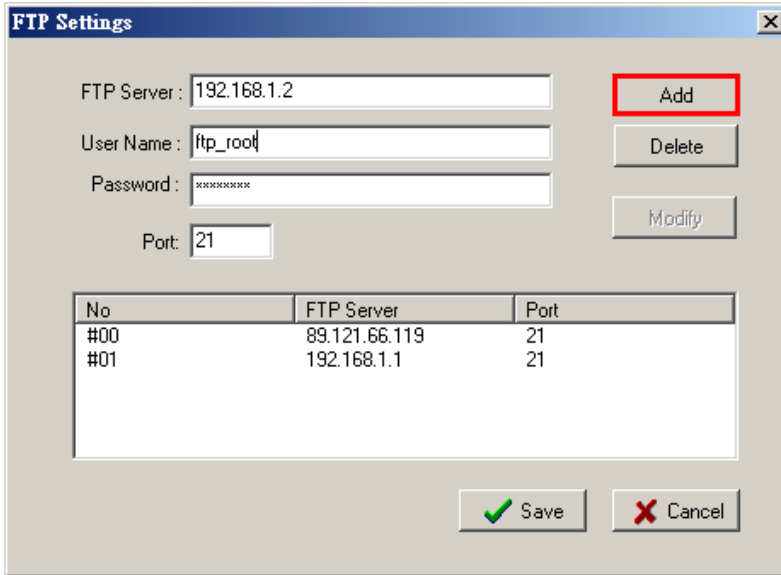

Step 3: Double click on the Click&Go rule entry.

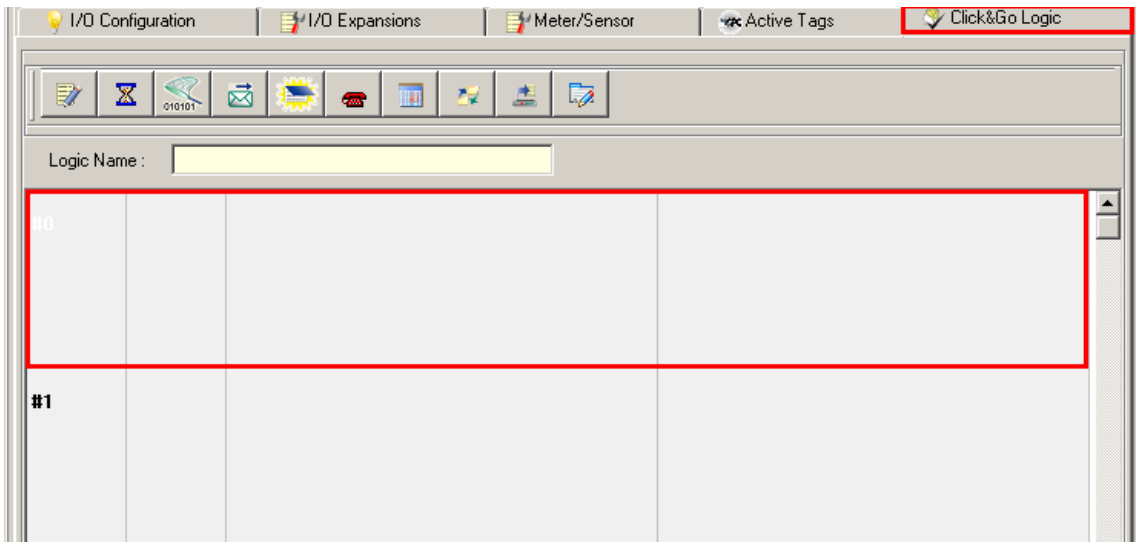

Step 4: In the IF Condition, select **Schedule** and then configure its properties to upload every midnight 00:00 to 00:15.

NOTE The **Timer** function can also be used for other applications.

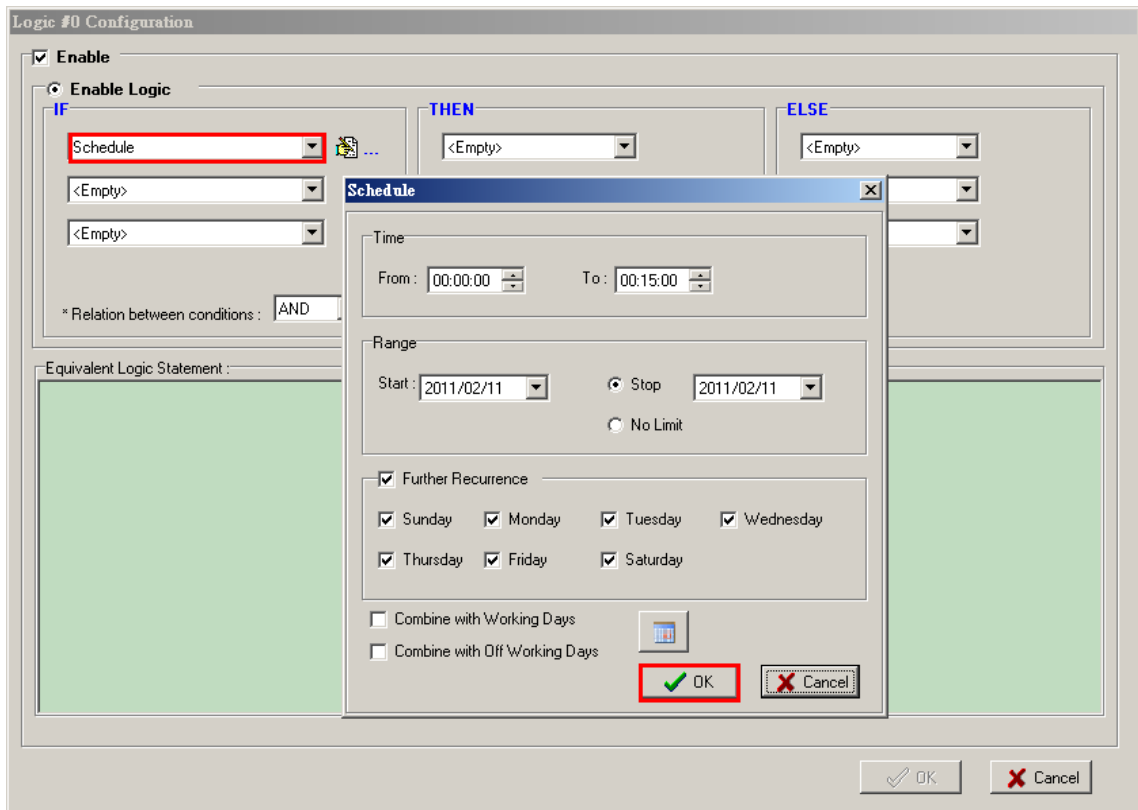

Step 5: In the THEN Action, select **FTP Service** and specify which profile's log files will be uploaded.

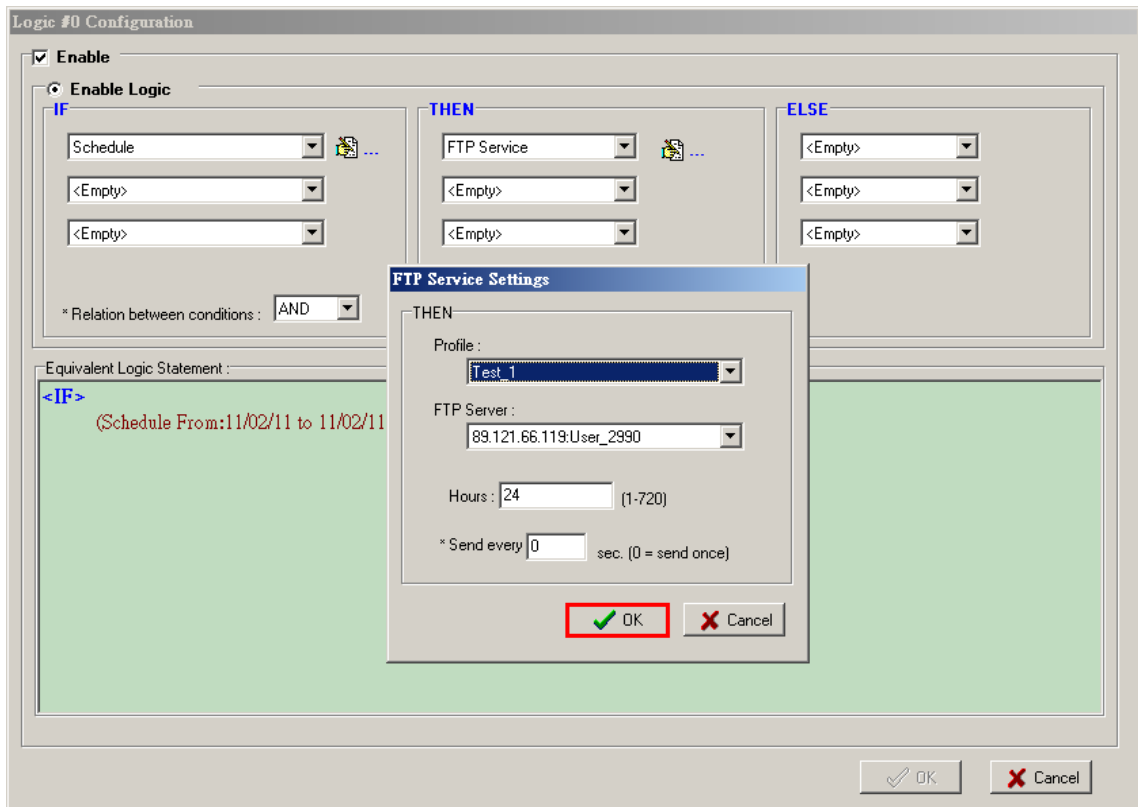

Step 6: On the Click&Go panel, click **Upload to ioLogik** to upload to the ioLogik W5300. Click **Yes** to restart the ioLogik system.

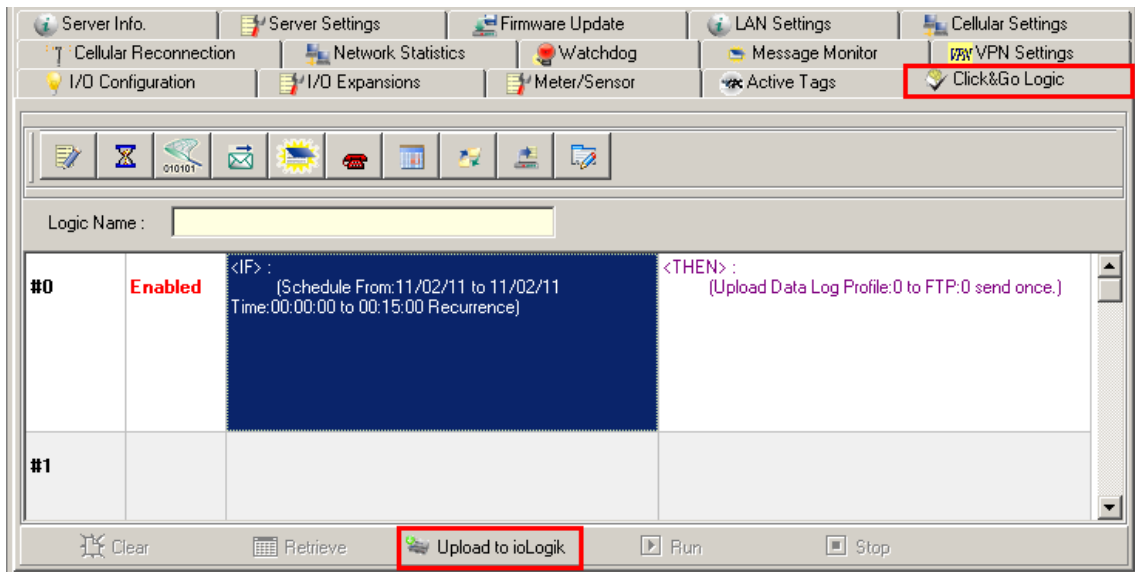

Step 7: On the Click&Go panel, click **Run** to activate the logic.

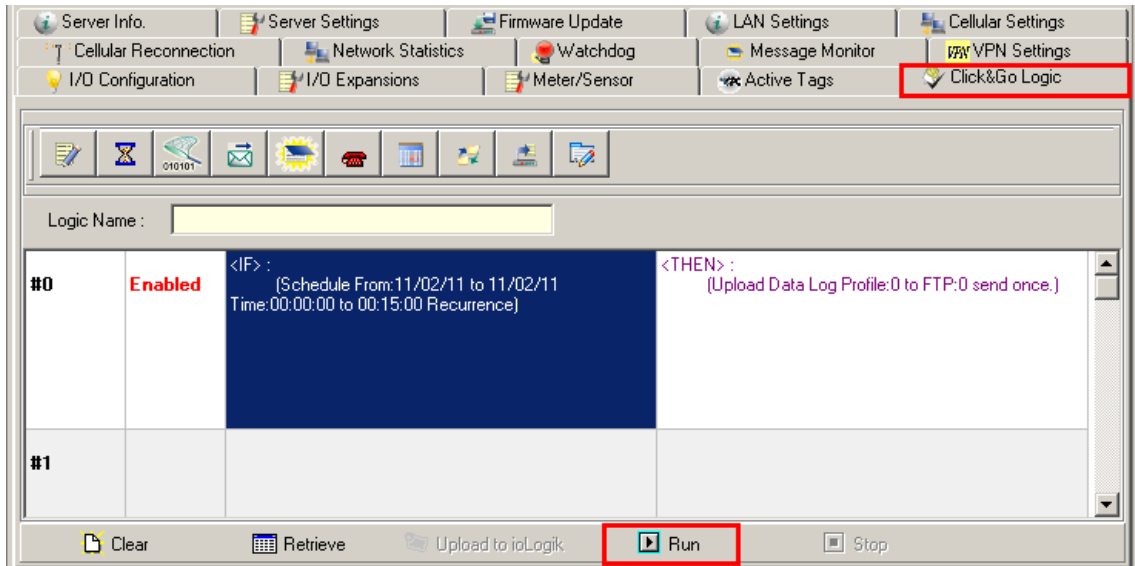

The Log file will be uploaded based on the current settings.

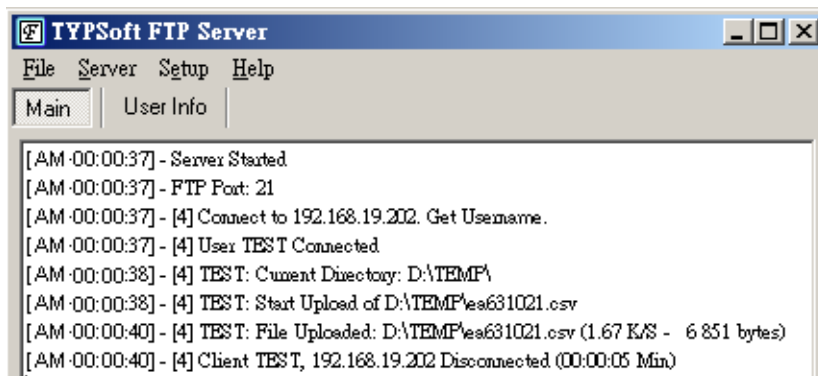

NOTE The function is dependent on the firmware version. Be sure to use firmware V1.3 or above for the ioLogik W5312 series, and firmware V1.5 or above for the ioLogik W5340 series.

Connecting a Modbus/RTU Serial Device Attached to the ioLogik over a Cellular Network

Scenario: In the water industry, warning systems use both IOs and serial meters to get complete status information. The ioLogik W5300 has built-in serial ports that support attaching Modbus/RTU serial meters with RS-232 or RS-485.

Setup Procedure:

Step 1: Start ioAdmin as administrator.

Step 2: Choose the **Meter/Sensor** tab.

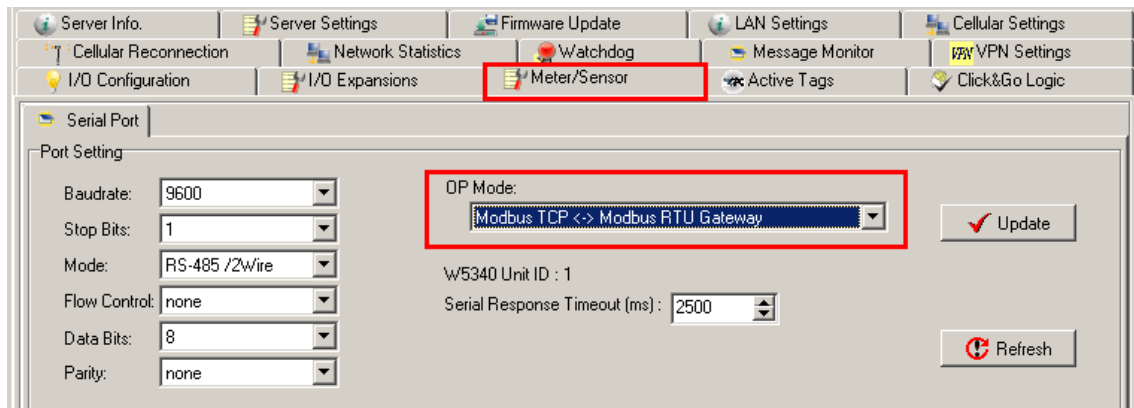

Step 3: Set the serial port parameters: RS-232, RS-485, Baudrate, Stop Bits, etc.

Step 4: Click **Modbus TCP → Modbus RTU Gateway** to choose the operation mode. There are two modes to choose from: transparent mode and Modbus/RTU mode.

Step 5: Connect the field serial device via the serial port, making sure that the signal wiring is correct.

Step 6: By specifying the W5340's IP address and the ID of the attached serial devices, you can use the Modbus/TCP master to query the remote serial device.

NOTE The Modbus Slave ID for the ioLogik W5300 is fixed at **1**, which means that the ID of the Modbus/RTU meters attached to the ioLogik should start from **2** to **247**.

Connecting to a SCADA System

Scenario: Most control centers use SCADA systems, such as InTouch, to monitor the status of their entire system. The ioLogik W5300 with Active OPC server can feed data into the SCADA system. In this situation, the SCADA system can use its built-in OPC Client/Server architecture to control the system.

Environment

SCADA System and Active OPC Server:

Public Static IP: 59.124.42.169

Internal Static IP: 192.168.19.19

Central site:

Internal Static IP: 192.168.19.19

Diagram

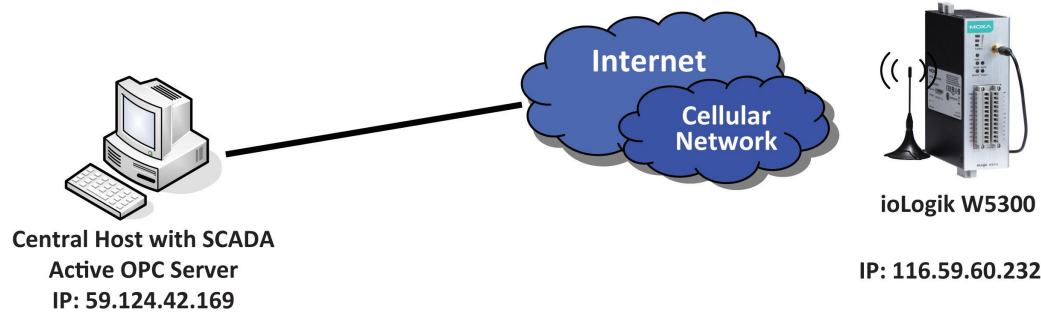

Setup Procedure

Step 1: Install the SCADA system and Active OPC server on the same host PC with IP address 59.124.42.169.

Step 2: Open ioAdmin as administrator.

Step 3: Choose **Active Tags** and input the host PC IP address in the Active OPC Server Address column.

Step 4: Select 4 AIs for update tags and then click the **Create Tags** button.

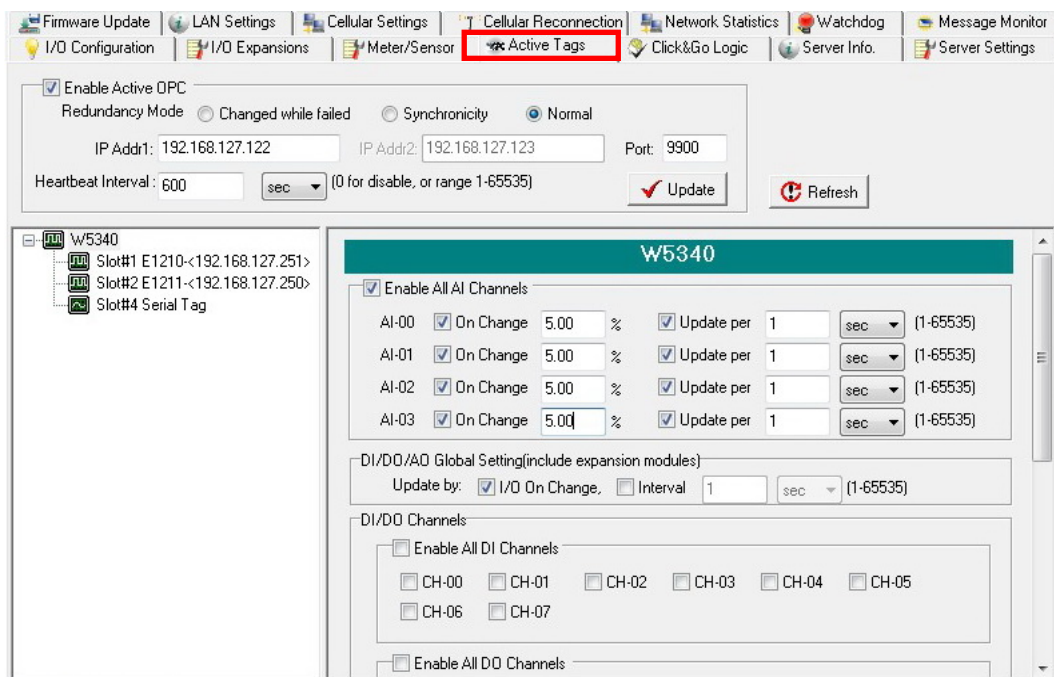

Step 5: ioAdmin will prompt you to restart the device.

Step 6: Open Active OPC server. You will see the device and data for 4 AIs in the display window.

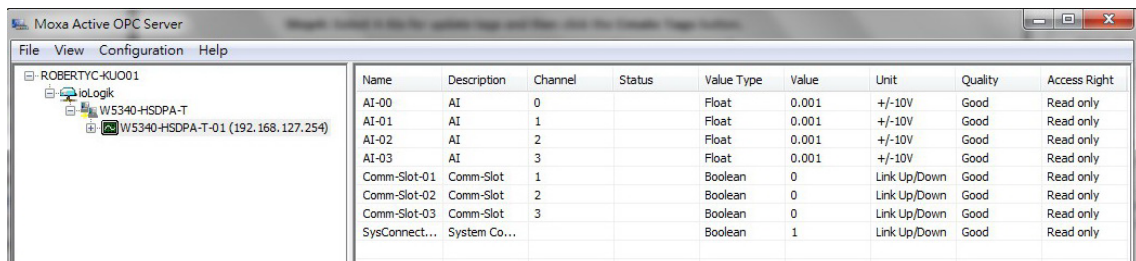

Step 7: Connect to the SCADA system and choose the OPC server as **Moxa Active OPC Server**.

Step 8: Follow SCADA instruments to create data tags for these 4 analog inputs.

Step 9: After creating these 4 tags, place them in a suitable position on the SCADA screen. You can find these values in the SCADA display.

Updating Serial Tags to SCADA System with Active OPC Server over a Cellular Network

Scenario: For many applications, a remote site not only needs to be monitored for physical IOs that measure environmental or facility conditions, but must also coordinate data output from serial meters. The ioLogik W5300 has a 3-in-1 serial port built in that supports attaching field serial Modbus/RTU meters (either RS-232 or RS-485), and allows the integration of this serial data so that it can be uploaded to the SCADA system via the Moxa Active OPC Server software.

Setup Procedure

Step 1: Start ioAdmin as administrator.

Step 2: Choose the **Meter/Sensor** tab.

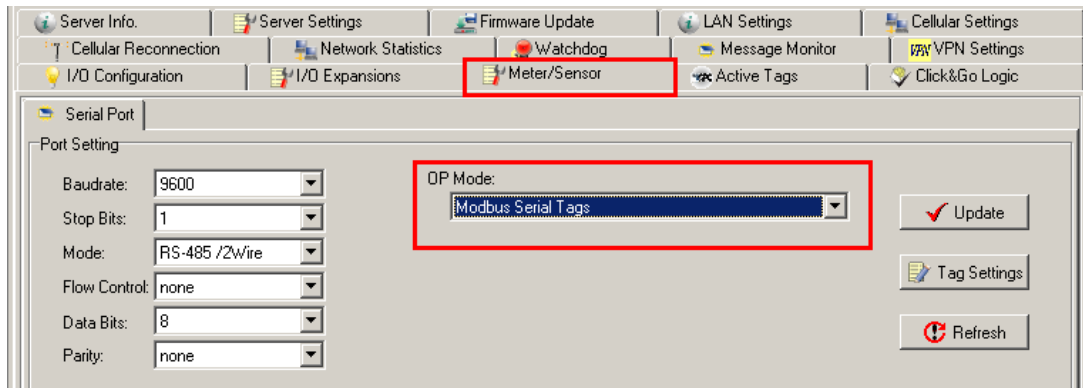

Step 3: Set the serial port parameters: RS-232, RS-485, Baudrate, Stop Bits, etc.

Step 4: Click **Modbus Serial Tags** to choose the operation mode.

Step 6: Click on the **Tag Settings** button at the right.

Step 7: Add the serial Tags. Refer to the attached serial device's Modbus Address table for further details.

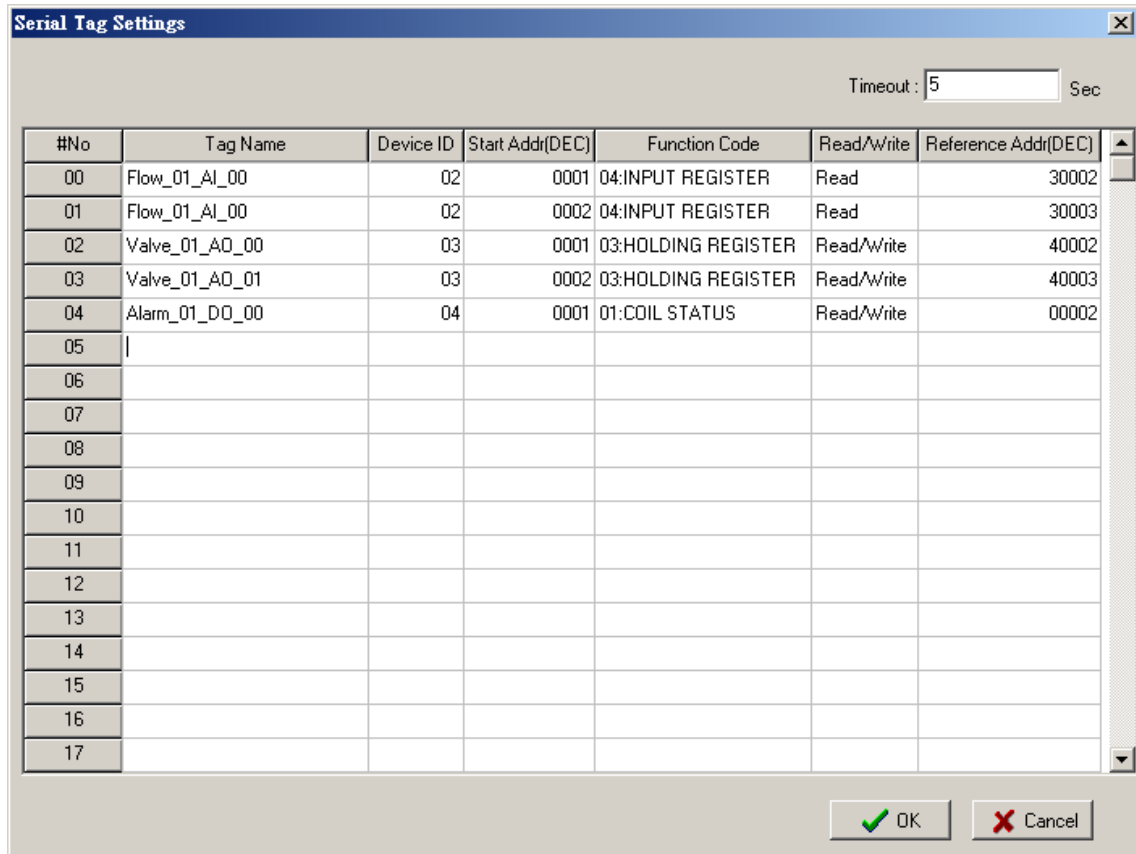

Step 8: After clicking **OK**, restart the ioLogik by right clicking the selected ioLogik from ioAdim.

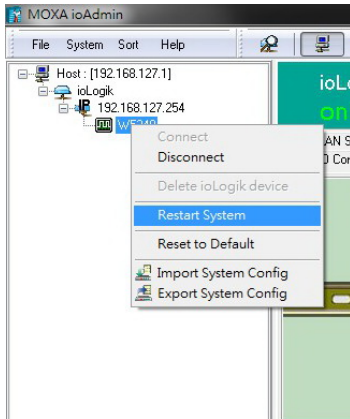

Step 9: On the **Active Tags** panel, specify the Active OPC Server's IP Address, and then click the **Update** button. Repeat Step 8 to restart the ioLogik. Click on **Slot#04 Serial Tag** and specify which tags need to be created for the Active OPC server. Next, click the **Create** button.

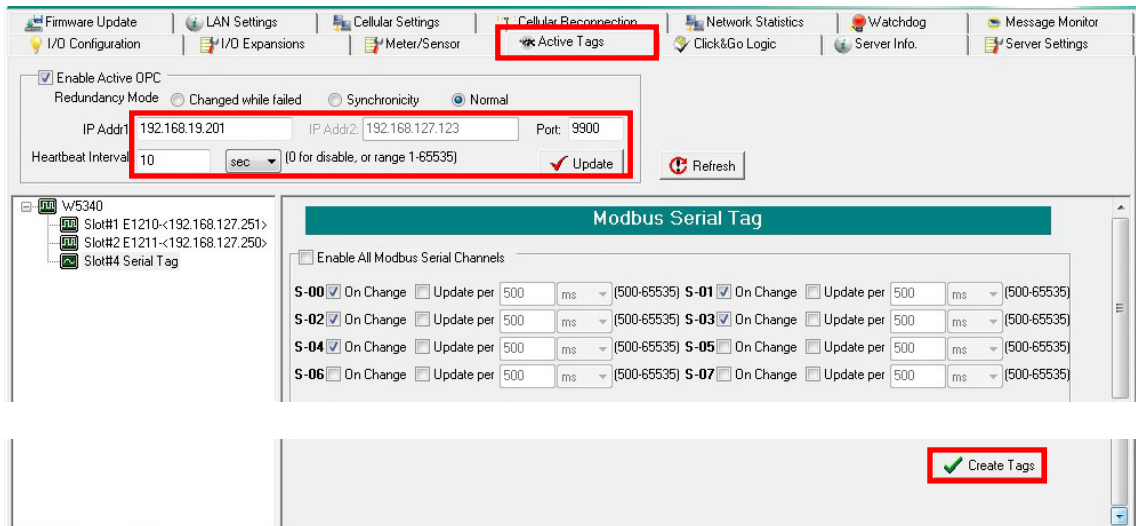

Step 10: The new serial tags will be created under the S04-Serial node in Active OPC Server.

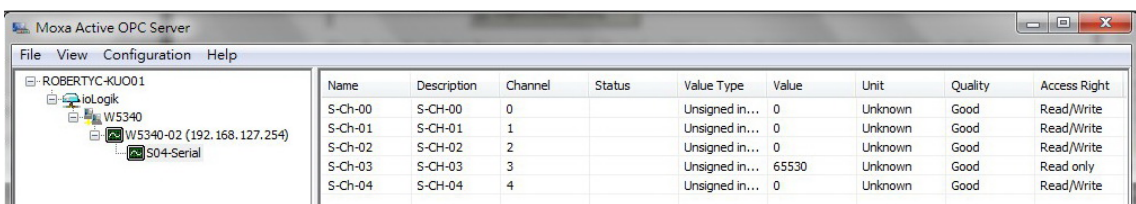

NOTE The function is dependent on the firmware version. Be sure to use firmware V1.3 or above for the ioLogik W5312 series and firmware V1.5 or above for the ioLogik W5340 series.

Handling Front-End Events and Alarms

Scenario: This application uses many unmanned sites, and the customer would like to receive an alarm if the monitored status changes. We assume that the water level of the water tank is measured with DI-1. The DI-1 starts as OFF, which indicates a normal water level. If the water's level reaches the high limit, the DI-1 status will change to ON. In addition, the SMS alarm will be initiated and sent directly to your mobile phone.

Setup Procedure

Step 1: We will assume that DI-1 is already connected with the water level (On/Off) sensor.

Step 2: Start ioAdmin as administrator.

Step 3: Click the **Click&Go Logic** tab and double click the blank rule.

Step 4: Input the Click&Go logic shown below (refer to Chapter 4 for details).
If DI=On Then Send SMS

Step 5: Don't forget to set up the phone number shown at the bottom of the message window.

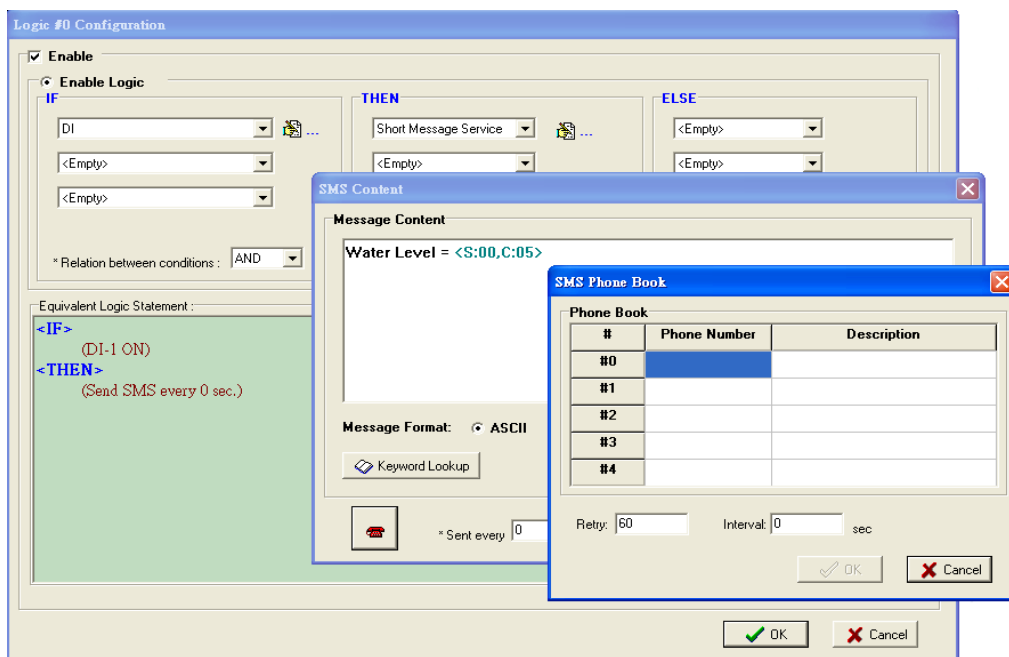

Step 6: Close the popup window, click **Upload to ioLogik**, and then reboot the device.

Step 7: After rebooting, click **Run**. The logic will go live. Once the water level is detected by a sensor, your mobile phone will receive the SMS.

- NOTE**
1. The above procedure can be handled over the LAN or from a remote location.
 2. The E-Mail, SNMP Trap, and TCP/UDP alarm can be configured in the same way.

SMS Escalation and Acknowledgement

Scenario: In this example we describe how to use the SMS alarm function to configure escalation and acknowledgement.

Setup Procedure

Step 1: First specify the SMS Phone Book on the Click&Go Logic panel.

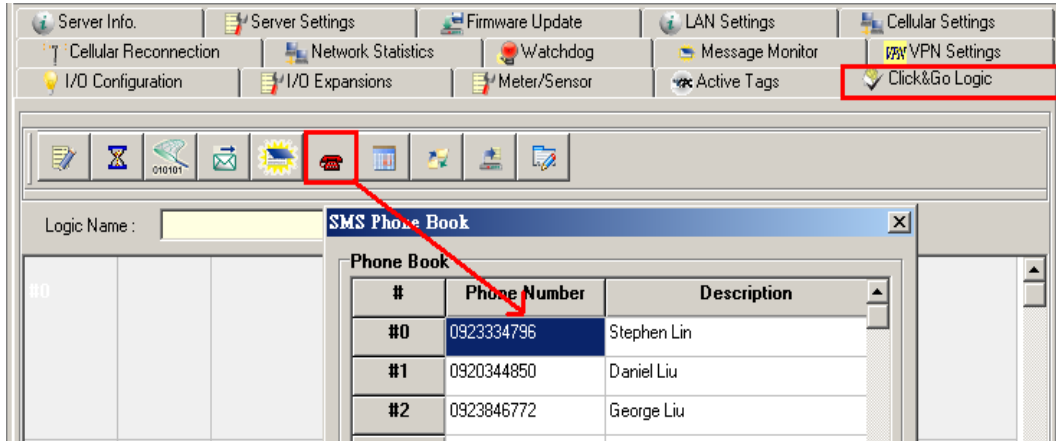

Step 2: Double click the 1st rule to configure the logic to send out an SMS. In this example, DI = Off-to-On triggers the SMS.

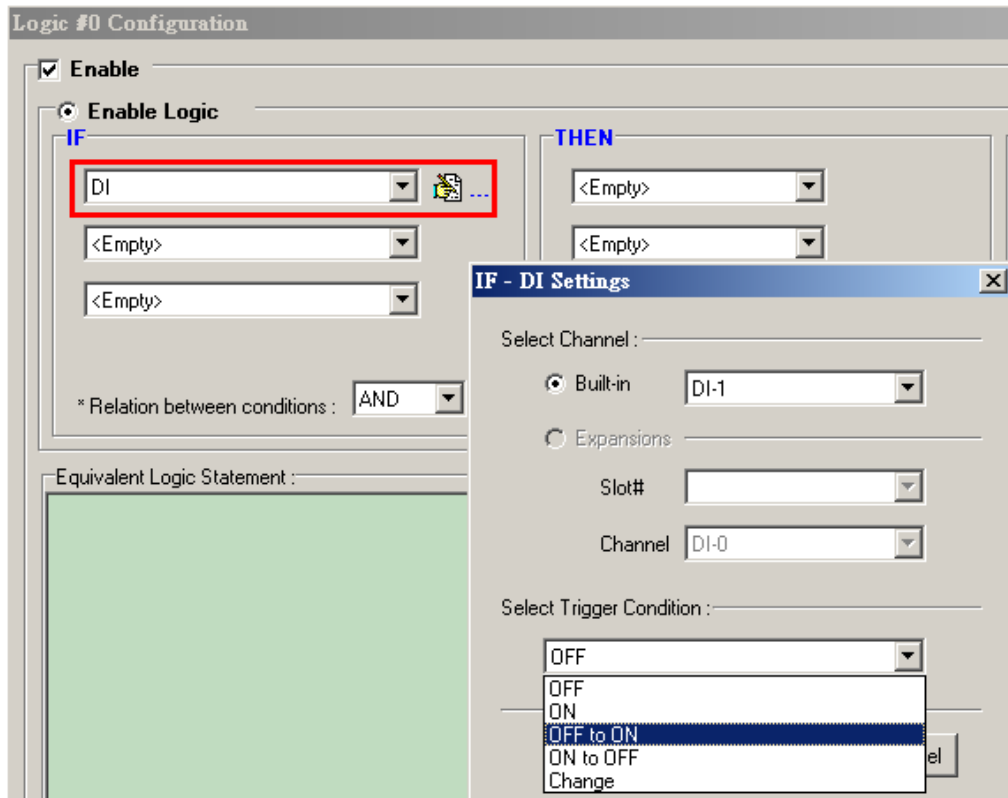

Step 3: In the THEN settings, select **Short Message Service** and click the **Properties** button to see detailed settings. On the **SMS Content** panel, select the receivers from the phone book. Note that multiple receivers can be selected. Select **SMS Escalation** to activate this function.

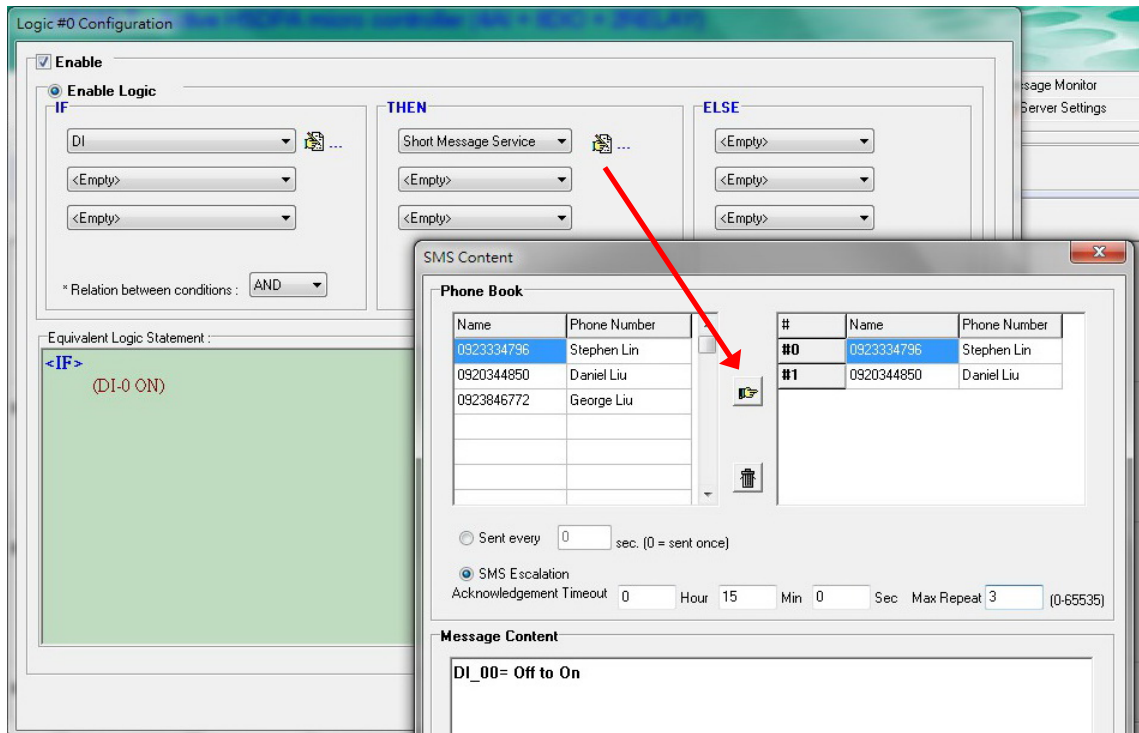

Step 4: Click **Upload to ioLogik** and **Run** to activate the logic.

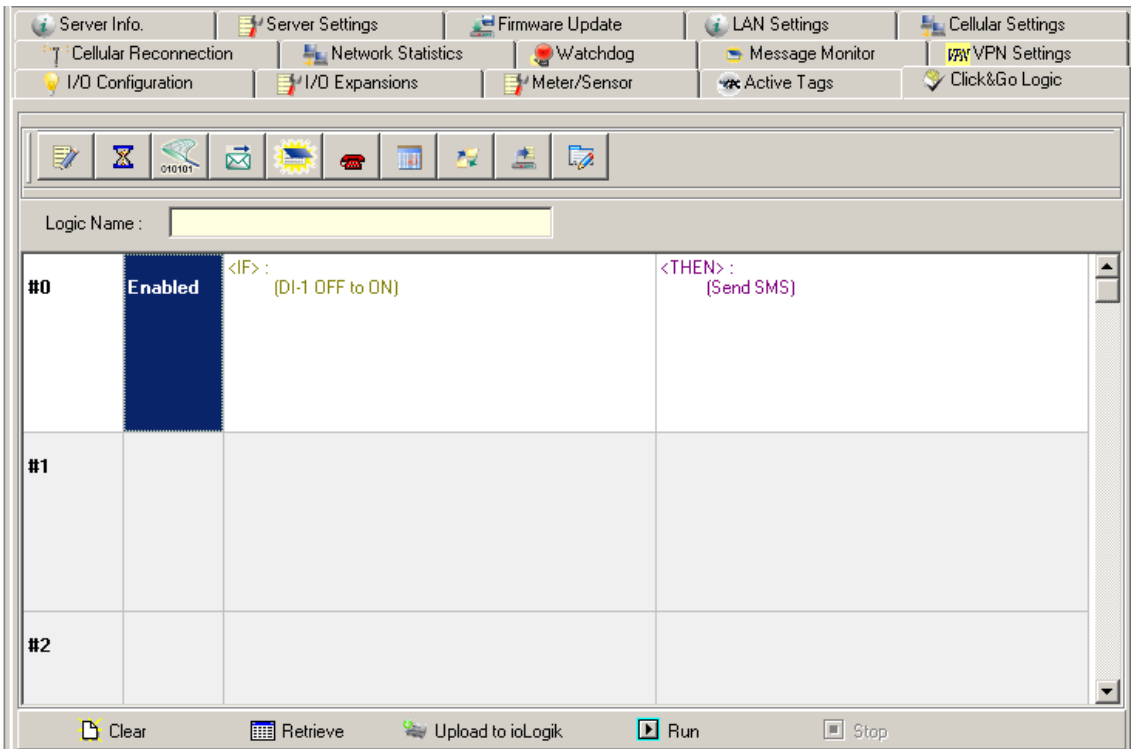

Step 5: If the SMS alarm is triggered, an alarm message will be received with the reply notice.



Step 6: Follow this example's settings. If the 1st receiver does not acknowledge with an SMS reply within 15 minutes, the ioLogik will send an alarm to the 2nd receiver. This loop will be repeated a total of 3 times.

For more SMS commands please refer to Appendix C

NOTE When using the SMS related function, be sure to get an appropriate data plan from your cellular provider. For example, a SIM card that only supports data service has the lowest priority to send or receive an SMS. In such cases, users must activate the voice service on this SIM to ensure faster response for the SMS.

We strongly recommend checking with your service provider for details.

NOTE The function is dependent on the firmware version. Be sure to use firmware V1.3 or above for the ioLogik W5312 series and firmware V1.5 or above for the ioLogik W5340 series.

SMS Commands for Monitoring and Control

Scenario: In this example we specify how to use SMS commands to monitor the status and provide an ioLogik W5300 with output control.

Setup Procedure

Step 1: The SMS command starts and ends with a # sign, and is divided into **get** and **set** commands. Refer to the appendix for details. Multiple commands can be integrated with an ampersand (&) sign. SMS commands are not case sensitive.

Step 2: Wait for the SMS message to return. The ioLogik W5300 will always reply to a correct command.

Step 3: Syntax and examples:

■ Format:

#GetSMS?command_channel=?&command_channel=?.....#

#SetSMS?command_channel=?&command_channel=?.....#

■ SMS set and get I/O status

- Get command :

#GETSMS?LOC=?&TIME=?&AIValue_00=?#

- Set command :

#SETSMS?AOValue_00=4095&DOSstatus_00=1#

■ SMS change internal register value

#SETSMS?IR_00=1# (IR value range 0-255)

For more SMS commands please refer to [Appendix C](#)

NOTE Output control via SMS is forbidden if the output channel is currently in use by the Click&Go logic. Integrate the **Internal Register** function for output control.

NOTE When using the SMS related function, be sure to get an appropriate data plan from your cellular provider. For example, a SIM card that only supports data service has the lowest priority to send or receive an SMS. In such cases, users must activate the voice service on this SIM to ensure faster response for the SMS. We strongly recommend checking with your service provider for details.

NOTE The function is dependent on the firmware version. Be sure to use firmware V1.3 or above for the ioLogik W5312 series and firmware V1.5 or above for the ioLogik W5340 series.

Enabling the Power Saving Function and Secure Wake on Call

Scenario: In this example we describe how to use the ioLogik W5300's power management function.

Setup Procedure

Step 1: Start ioAdmin as administrator.

Step 2: Select the **Cellular Settings** tab and set the operation mode to **On Demand**. The Cellular will remain in GSM standby mode. The I/O function, Click&Go, and Data Logging functions will continue to work properly.

Step 3: Checkmark the "Wake on Call" checkbox.

Step 4: Input the appropriate phone numbers in the Caller ID column. You may input a maximum of 5 phone numbers.

Step 5: After restarting the system, you can use your cell phone to connect the device to the Cellular network.

Enabling Ethernet and Cellular Redundancy

Scenario: In this example we describe how to enable the Ethernet port as the primary interface and use the cellular interface as backup.

Setup Procedure

Step 1: On the **Cellular Settings** tab, select **Ethernet Wan (Cellular Backup)** as the Operation Mode.

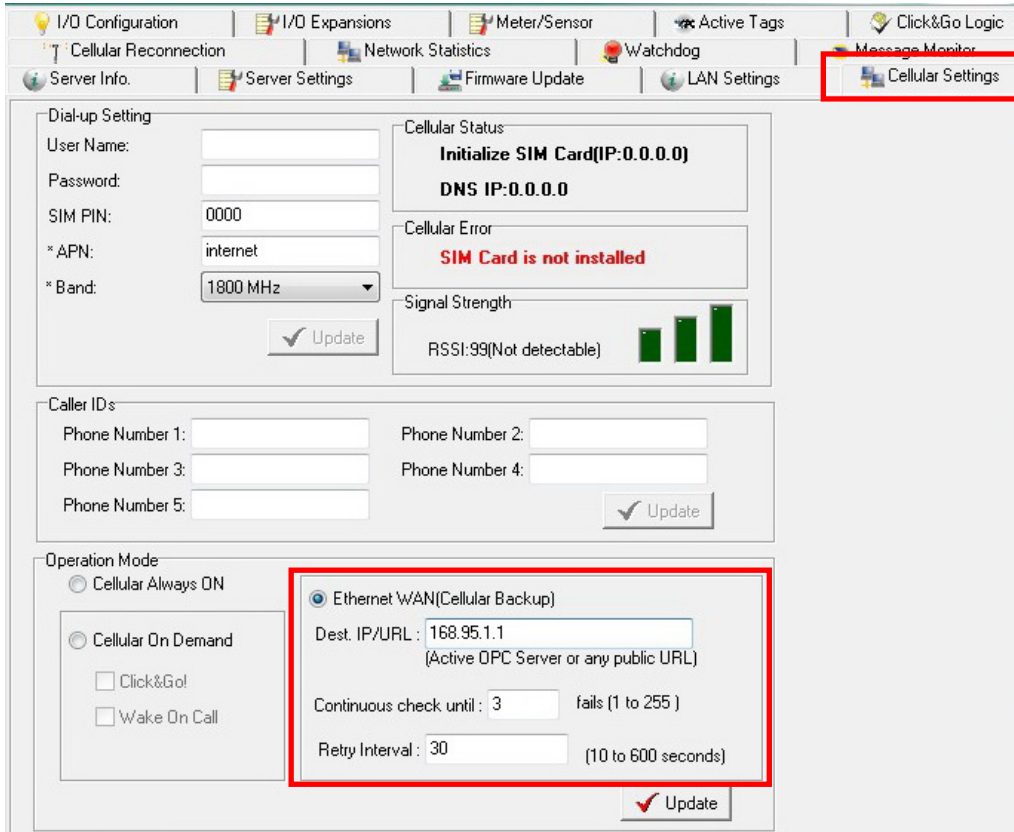

Step 2: Specify the Dest.IP/URL for the alive check for the Ethernet interface. Click **Update** and restart the ioLogik to activate this function.

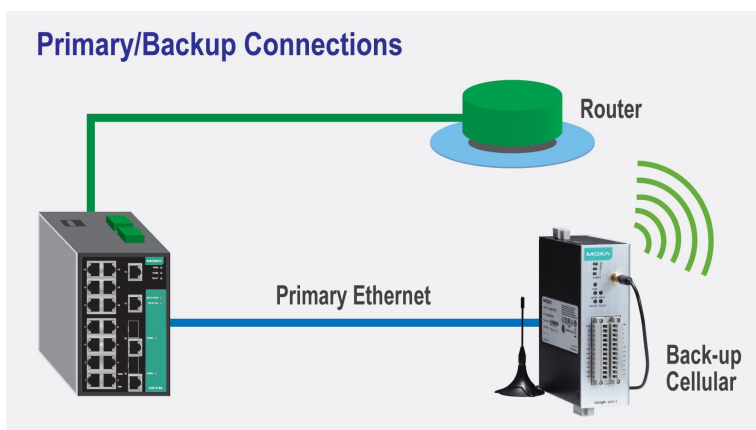

NOTE The Dest.IP/URL must be specified so the Ethernet port will detect and switch to the backup cellular interface when the primary Ethernet Interface fails.

A

Pin-outs and Cable Wiring

The following topics are covered in this appendix:

□ Pinouts

- CN1: SMA, Cellular Antenna Connector
- CN2: DB9, Male, RS-232 Connector
- CN3: RJ-45, Ethernet Connector
- TB1: Power Input Terminal Block
- TB2: I/O Terminal Block (W5340)
- TB3: 5-pin, 4-wire/2-wire RS-422/485 Terminal Block
- TB2: I/O Terminal Block (W5312)

□ Cable Wiring

- Digital Input Dry Contact
- Digital Input Wet Contact
- Digital Output Sink Mode
- Relay Output
- Analog Input

Pinouts

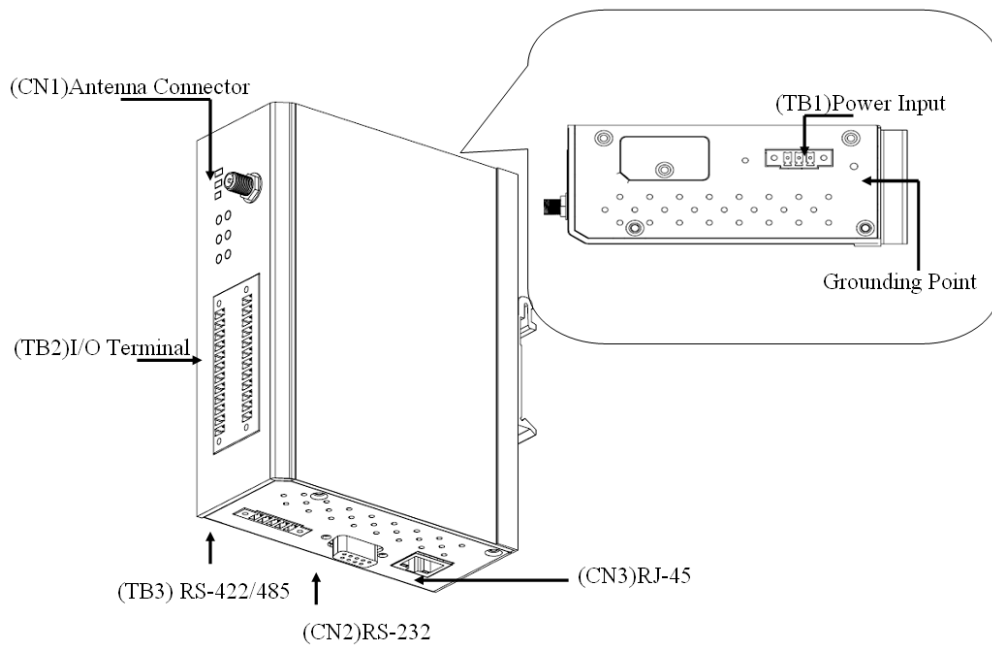

CN1: SMA, Cellular Antenna Connector

CN2: DB9, Male, RS-232 Connector

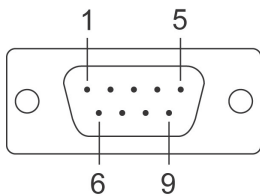

PIN	RS-485 Signals
1	DCD
2	RxD
3	TxD
4	DTR
5	Signal GND
6	DSR
7	RTS
8	CTS
9	N.C.

CN3: RJ-45, Ethernet Connector

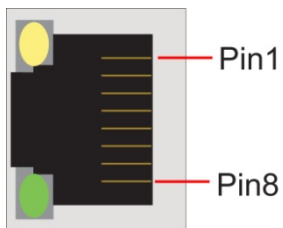

PIN	Signals
1	TxD+
2	TxD-
3	RxD+
4	-
5	-
6	RxD-
7	-
8	-

TB1: Power Input Terminal Block

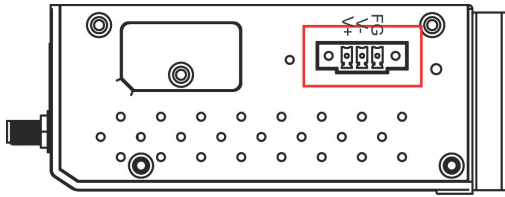

TB2: I/O Terminal Block (W5340)

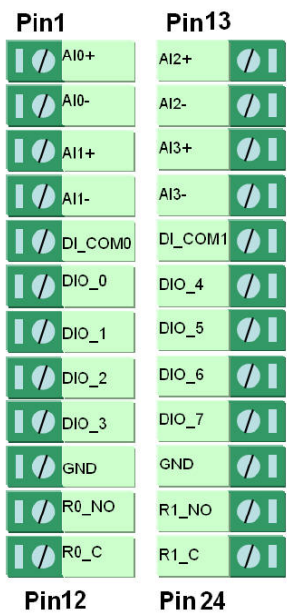

Terminal Block (Left)	
PIN	Signals
1	VINO+
2	VINO-
3	VIN1+
4	VIN1-
5	DI_COM1
6	DIO0
7	DIO1
8	DIO2
9	DIO3
10	GND
11	R0_NO
12	R0_C

Terminal Block (Right)	
PIN	Signals
13	VIN2+
14	VIN2-
15	VIN3+
16	VIN3-
17	DI_COM2
18	DIO4
19	DIO5
20	DIO6
21	DIO7
22	GND
23	R1_NO
24	R1_C

TB3: 5-pin, 4-wire/2-wire RS-422/485 Terminal Block

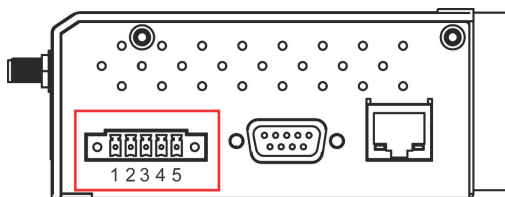

Pin	RS-422/485(4W)	RS-485(2W)
1	Signal GND	GND
2	TxD-(A)	-
3	TxD+(B)	-
4	RxD-(A)	Data-(A)
5	RxD+(B)	Data+(B)

TB2: I/O Terminal Block (W5312)

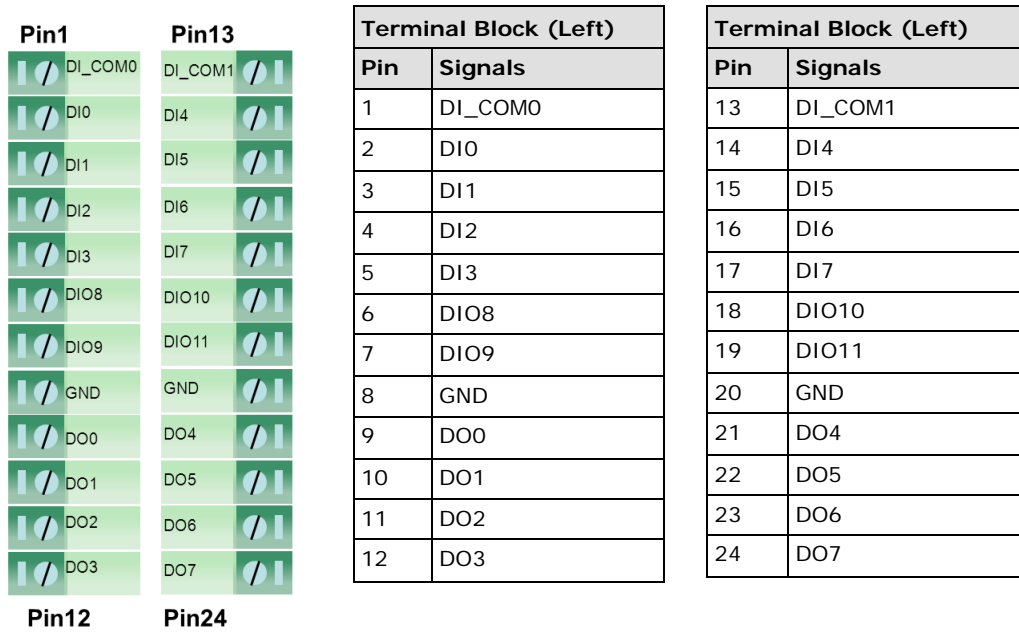

Cable Wiring

Digital Input Dry Contact

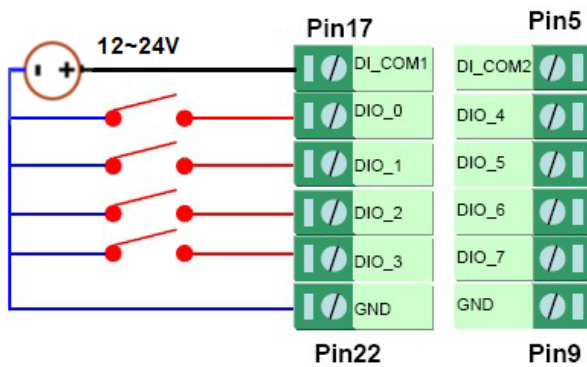

Digital Input Wet Contact

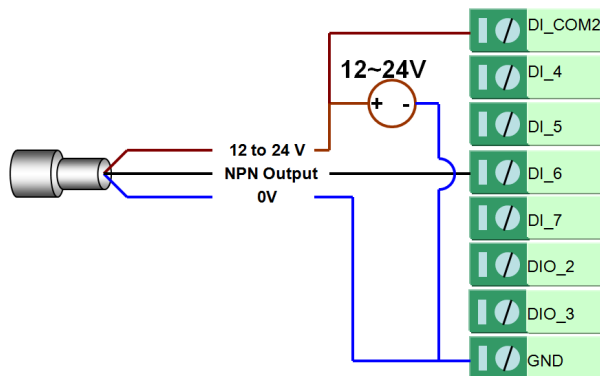

NPN Type Sensors Connection

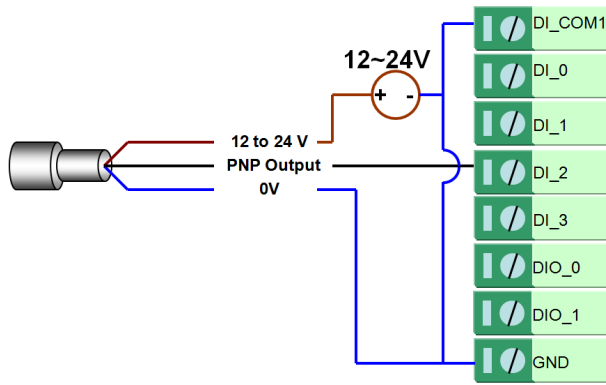

PNP Type Sensors Connection

Digital Output Sink Mode

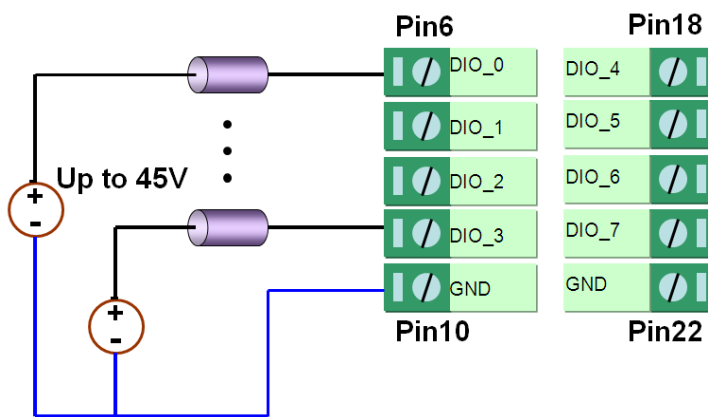

Relay Output

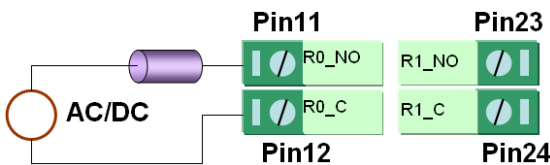

Analog Input

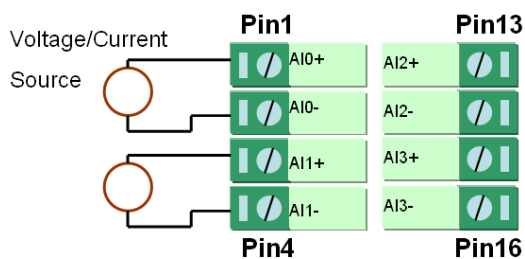

ATTENTION

When connecting the I/O device to the ioLogik's dry contacts, we strongly recommended connecting DI.Com to the power of the external sensor to avoid affecting other channels.

B

SMS Commands

SMS commands help users use short messages to monitor or control the I/O status of an ioLogik W5300 unit.

The following topics are covered in this appendix:

- ❑ **SMS Command Syntax:**
- ❑ **SMS Command Table**

SMS Command Syntax:

```
#GetSMS?command_channel=?&command_channel=?...#
```

```
#SetSMS?command_channel=X&command_channel=X...#
```

Details:

1. SMS commands start and end with a "#" sign.
2. Multiple commands can be integrated using an "&" sign.
3. No space or carriage return/linefeed (enter) are allowed between characters.
4. Commands are NOT case sensitive.
5. To query status, use "GetSMS?" after the 1st "#" sign.
 - a. Use "=?" after a query command (Read, or Read/Write privilege)
6. To control an output, use "SetSMS?" after the 1st "#" sign.
 - a. Use "=X" after a control command (Read/Write privilege), where X means the actual command parameters such as 0 (On), 1 (Off), or value (expansion AO channels).
 - b. The ioLogik will response with the current output status if the commands are received and processed correctly.
 - c. Output control is forbidden if the target channel is currently in use by the Click&Go logic. Integrate the Internal Register function in the Click&Go logic to perform such tasks by controlling the Internal Registers.
7. The ioLogik will not respond to illegal commands or wrong control parameters.
8. Only the first 140 characters of a response will be kept; the rest will be discarded.
9. SMS message content:
 - a. Format: ASCII
 - b. Maximum number characters: 140

SMS Command Table

System Information Commands:

SMS Command	Attribute	Note
DATE	Read	Current Date
TIME	Read	Current Time
IP	Read	Current LAN IP address
WIP	Read	Current WAN(Cellular) IP address
LOC	Read	Server Location
DESC	Read	Server Description
FWR_V	Read	Current Firmware Version
MOD_NAME	Read	Model Name
SN_NUM	Read	Serial Number
MAC_ADDR	Read	MAC Address
EXP_MOD_NUM	Read	Number of attached E1200 modules
EXP_DEV_MOD_TYPE	Read	Expansion ioLogik E1200 Type DEV=Device slot number, start index:01

Example:

1. Query ioLogik W5300 system date:
#GetSMS?DATE=?#
2. Query the ioLogik W5300 Server Location:
#GetSMS?LOC=?#
3. Query the ioLogik W5300 Server Time and LAN IP:
#GetSMS?TIME=?&IP=?#

Local I/O Commands:

SMS Command	Attribute	Note
AIEnable_CH	Read	AI channel is enabled or not 0=Off, 1=On CH = Channel number, start index:00
AIValue_CH	Read	AI Value CH = Channel number, start index:00
AI_CH	Read	Scaled AI value CH = Channel number, start index:00 to 04
AIRange_CH	Read	Current AI mode, +/-5V, 0-10V, +/-10V · 0-20mA, or 4-20mA CH = Channel number, start index:00
AIMin_CH	Read	Minimal AI Value CH = Channel number, start index:00
AIMax_CH	Read	Maximal AI Value CH = Channel number, start index:00
DIO_DIRECT_CH	Read	DIO Direction, DI or DO CH = Channel number, start index:00
DIMode_CH	Read	DI Mode, DI or Counter CH = Channel number, start index:00,
DIStatus_CH	Read	DI Status, ON or OFF CH = Channel number, start index:00
DIFilter_CH	Read	DI Filter, unit: ms CH = Channel number, start index:00,
DITrigger_CH	Read	DI Trigger, LtoH, or HtoL CH = Channel number, start index:00
DICntStart_CH	Read	DO Counter is started or not, 0=OFF, 1=ON CH = Channel number, start index:00
DICNT_CH	Read	DI Counts. CH = Channel number, start index:00
DOMode_CH	Read	DO Mode, DO or PWM(pulse output) CH = Channel number, start index:00
DOStatus_CH	Read/Write	DO Status, 0=OFF, 1=ON. CH = Channel number, start index:00
DOLowWidth_CH	Read	DO Low Width, unit: ms CH = Channel number, start index:00
DOHighWidth_CH	Read	DO High Width, unit: ms CH = Channel number, start index:00
DOPulseStart_CH	Read/Write	DO Pulse is started or not, 0=OFF, 1=ON CH = Channel number, start index:00
DOTotalRelayCNT_CH	Read	Relay Total Counts CH = Channel number, start index:00
DOCurrentRelayCNT_CH	Read	Relay Current Counts. CH = Channel number, start index:00

Example:

- Query the 1st DI the ioLogik W5300 system:
#GetSMS?DIStatus_00=?#
- Configure the 2nd relay output(DO_09) of the ioLogik W5340 to On:
#SetSMS?DOStatus_09=1#

Expansion I/O Commands:

SMS Command	Attribute	Note
EXP_DEV_AIValue_CH	Read	Expansion AI Value DEV=Device slot number, start index:01 CH = Channel number, start index:00
EXP_DEV_AI_CH	Read	Scaled Expansion AI Value DEV=Device slot number, start index:01 CH = Channel number, start index:00
EXP_DEV_AIRange_CH	Read	Expansion AI Range, 4-20mA or 0-10VDC DEV=Device slot number, start index:01 CH = Channel number, start index:00
EXP_DEV_AIMin_CH	Read	Expansion Minimal AI Value. DEV=Device slot number, start index:01 CH = Channel number, start index:00
EXP_DEV_AIMax_CH	Read	Expansion Maximal AI Value DEV=Device slot number, start index:01 CH = Channel number, start index:00
EXP_DEV_AOMode_CH	Read	Expansion AO Mode, 4-20mA or 0-10VDC DEV=Device slot number, start index:01 CH = Channel number, start index:00
EXP_DEV_AOValue_CH	Read/Write	Expansion AO Value, 12 bit, Range=0-4095 DEV=Device slot number, start index:01 CH = Channel number, start index:00
EXP_DEV_AO_CH	Read	Expansion Scaled AI Value DEV=Device slot number, start index:01 CH = Channel number, start index:00
EXP_DEV_DIO_DIRECT_CH	Read	Expansion DIO Direction, DI or DO. DEV=Device slot number, start index:01 CH = Channel number, start index:00
EXP_DEV_DIMode_CH	Read	Expansion DI Mode, DI or Counter DEV=Device slot number, start index:01 CH = Channel number, start index:00
EXP_DEV_DIStatus_CH	Read	Expansion DI Status. ON or OFF DEV=Device slot number, start index:01 CH = Channel number, start index:00
EXP_DEV_DICNT_CH	Read	Expansion DI Counts DEV=Device slot number, start index:01 CH = Channel number, start index:00
EXP_DEV_DOMode_CH	Read	Expansion DO Mode, DO or PWM(pulse output) DEV=Device slot number, start index:01 CH = Channel number, start index:00
EXP_DEV_DOSStatus_CH	Read/Write	Expansion DO Status, 0=OFF, 1=ON DEV=Device slot number, start index:01 CH = Channel number, start index:00
EXP_DEV_DOPulseStart_CH	Read/Write	Expansion DO Pulse is started or not, 0=OFF, 1=ON DEV=Device slot number, start index:01 CH = Channel number, start index:00
EXP_DEV_DOTotalRelayCNT_CH	Read	Expansion Relay Total Counts DEV=Device slot number, start index:01 CH = Channel number, start index:00
EXP_DEV_RTDValue_CH	Read	Expansion RTD Value DEV=Device slot number, start index:01 CH = Channel number, start index:00

SMS Command	Attribute	Note
EXP_DEV_RTDDType_CH	Read	Expansion RTD Type DEV=Device slot number, start index:01 CH = Channel number, start index:00
EXP_DEV_RTDDUnit_CH	Read	Expansion RTD Unit, C/F or Ohm DEV=Device slot number, start index:01 CH = Channel number, start index:00
EXP_DEV_TCValue_CH	Read	Expansion TC Value DEV=Device slot number, start index:01 CH = Channel number, start index:00
EXP_DEV_TCType_CH	Read	Expansion TC Type DEV=Device slot number, start index:01 CH = Channel number, start index:00
EXP_DEV_TCUnit_CH	Read	Expansion TC Unit, C/F, or mV. DEV=Device slot number, start index:01 CH = Channel number, start index:00

Example:

1. Query 1st AI channel of the expansion iologik E1240(8AI) in the 1st slot of the ioLogik W5300 system:
#GetSMS?EXP_01_AIValue_00=?#
2. Configure the output of the expansion ioLogik E1241(4AO) in the 3rd slot of the ioLogik W5300 system:
#SetSMS?EXP_03_AOValue_00=1023#

Internal Registers (Integer):

SMS Command	Attribute	Note
IR_CH	Read/Write	Internal Registers, CH= Channel Number, Range: 00 to 23. Content: 0 to 255

Example:

Configure the 1st internal register (IR_00) to 128:

#SetSMS?IR_00=128#

Optional Commands:

SMS Command	Attribute	Note
pwd="password"	–	Attach Console Password
Due=Date	–	Attach an expiration date, format: Date Format: YYYYMMDDHHMM
SAVE_RESTART	–	Restart the ioLogik device

Details:

1. Option commands should be combined with the GetSMS?, SetSMS? Commands, and "<">" signs at the beginning of the entire command line..
2. Console passwords should be included with double quotation marks (")
3. Multiple Option commands can be integrated using a ":" sign

Example:

1. Attaching the console password:
#SetSMS<pwd="admin">?DOStatus_03=1#
2. Attaching an expiration date:
#SetSMS<DUE=201102180955>?DOStatus_03=1#
3. Attaching the console password and an expiration date:
#SetSMS<DUE=201102180955:pwd="admin">?DOStatus_03=1#
4. Restart ioLogik W5300 by SMS command:
#SetSMS<SAVE_RESTART>

Modbus/TCP Address Mapping

There are two kinds of Modbus Address mapping for the ioLogik W5300: one for the main system and the other for the expansion modules.

This appendix provides the Modbus Address tables for the ioLogik W5300 series. Modbus Address maps for the expansion modules can be exported from the **I/O Expansion** tab in **ioAdmin**.

The following topics are covered in this appendix:

❑ **ioLogik W5340 and ioLogik W5340-HSPA Modbus Mapping**

- 0xxxx Read/Write Coils (support functions 1, 5, 15)
- 1xxxx Read only Coils (supports function 2)
- 3xxxx Read-only Registers (supports function 4)
- 4xxxx Read/Write Registers (supports functions 3, 6, 16)
- 5xxxx Write Registers (supports function 8)

❑ **ioLogik W5312 Modbus Mapping**

- 0xxxx Read/Write Coils (supports functions 1, 5, 15)
- 1xxxx Read only Coils (supports function 2)
- 3xxxx Read only Registers (supports function 4)
- 4xxxx Read/Write Registers (supports functions 3, 6, 16)
- 5xxxx Write Registers (supports function 8)

ioLogik W5340 and ioLogik W5340-HSPA

Modbus Mapping

NOTE For Modbus addresses of the ioLogik E1200 expansion modules attached to the ioLogik W5340, check the ioAdmin **I/O Expansion** tabs for details.

0xxxx Read/Write Coils (support functions 1, 5, 15)

Reference	Address	Data Type	Description
DIO Channels			
00001	0x0000	1 bit	CH0 DO Value 0: Off 1: On
00002	0x0001	1 bit	CH1 DO Value 0: Off 1: On
00003	0x0002	1 bit	CH2 DO Value 0: Off 1: On
00004	0x0003	1 bit	CH3 DO Value 0: Off 1: On
00005	0x0004	1 bit	CH4 DO Value 0: Off 1: On
00006	0x0005	1 bit	CH5 DO Value 0: Off 1: On
00007	0x0006	1 bit	CH6 DO Value 0: Off 1: On
00008	0x0007	1 bit	CH7 DO Value 0: Off 1: On
00009	0x0008	1 bit	CH8 DO Value 0: Off 1: On (Relay)
00010	0x0009	1 bit	CH9 DO Value 0: Off 1: On (Relay)
00013	0x000C	1 bit	CH0 DO Power On Value 0: Off 1: On
00014	0x000D	1 bit	CH1 DO Power On Value 0: Off 1: On
00015	0x000E	1 bit	CH2 DO Power On Value 0: Off 1: On
00016	0x000F	1 bit	CH3 DO Power On Value 0: Off 1: On
00017	0x0010	1 bit	CH4 DO Power On Value 0: Off 1: On
00018	0x0011	1 bit	CH5 DO Power On Value 0: Off 1: On
00019	0x0012	1 bit	CH6 DO Power On Value 0: Off 1: On
00020	0x0013	1 bit	CH7 DO Power On Value 0: Off 1: On
00021	0x0014	1 bit	CH8 DO Power On Value 0: Off 1: On (Relay)
00022	0x0015	1 bit	CH9 DO Power On Value 0: Off 1: On (Relay)
00037	0x0024	1 bit	CH0 DO Pulse Operate Status 0: Off 1: On
00038	0x0025	1 bit	CH1 DO Pulse Operate Status 0: Off 1: On
00039	0x0026	1 bit	CH2 DO Pulse Operate Status 0: Off 1: On
00040	0x0027	1 bit	CH3 DO Pulse Operate Status 0: Off 1: On
00041	0x0028	1 bit	CH4 DO Pulse Operate Status 0: Off 1: On
00042	0x0029	1 bit	CH5 DO Pulse Operate Status 0: Off 1: On
00043	0x002A	1 bit	CH6 DO Pulse Operate Status 0: Off 1: On
00044	0x002B	1 bit	CH7 DO Pulse Operate Status 0: Off 1: On
00045	0x002C	1 bit	CH8 DO Pulse Operate Status 0: Off 1: On (Relay)
00046	0x002D	1 bit	CH9 DO Pulse Operate Status 0: Off 1: On (Relay)
00049	0x0030	1 bit	CH0 DO PowerOn Pulse Operate Status 0: Off 1: On
00050	0x0031	1 bit	CH1 DO PowerOn Pulse Operate Status 0: Off 1: On
00051	0x0032	1 bit	CH2 DO PowerOn Pulse Operate Status 0: Off 1: On
00052	0x0033	1 bit	CH3 DO PowerOn Pulse Operate Status 0: Off 1: On
00053	0x0034	1 bit	CH4 DO PowerOn Pulse Operate Status 0: Off 1: On
00054	0x0035	1 bit	CH5 DO PowerOn Pulse Operate Status 0: Off 1: On
00055	0x0036	1 bit	CH6 DO PowerOn Pulse Operate Status 0: Off 1: On
00056	0x0037	1 bit	CH7 DO PowerOn Pulse Operate Status 0: Off 1: On
00057	0x0038	1 bit	CH8 DO PowerOn Pulse Operate Status 0: Off 1: On (Relay)
00058	0x0039	1 bit	CH9 DO PowerOn Pulse Operate Status 0: Off 1: On (Relay)

Reference	Address	Data Type	Description
00061	0x003C	1 bit	CH0 DO Safe Pulse Operate Status 0: Off 1: On
00062	0x003D	1 bit	CH1 DO Safe Pulse Operate Status 0: Off 1: On
00063	0x003E	1 bit	CH2 DO Safe Pulse Operate Status 0: Off 1: On
00064	0x003F	1 bit	CH3 DO Safe Pulse Operate Status 0: Off 1: On
00065	0x0040	1 bit	CH4 DO Safe Pulse Operate Status 0: Off 1: On
00066	0x0041	1 bit	CH5 DO Safe Pulse Operate Status 0: Off 1: On
00067	0x0042	1 bit	CH6 DO Safe Pulse Operate Status 0: Off 1: On
00068	0x0043	1 bit	CH7 DO Safe Pulse Operate Status 0: Off 1: On
00069	0x0044	1 bit	CH8 DO Safe Pulse Operate Status 0: Off 1: On (Relay)
00070	0x0045	1 bit	CH9 DO Safe Pulse Operate Status 0: Off 1: On (Relay)
00073	0x0048	1 bit	CH0 DI Counter Status 0: Off 1: On
00074	0x0049	1 bit	CH1 DI Counter Status 0: Off 1: On
00075	0x004A	1 bit	CH2 DI Counter Status 0: Off 1: On
00076	0x004B	1 bit	CH3 DI Counter Status 0: Off 1: On
00077	0x004C	1 bit	CH4 DI Counter Status 0: Off 1: On
00078	0x004D	1 bit	CH5 DI Counter Status 0: Off 1: On
00079	0x004E	1 bit	CH6 DI Counter Status 0: Off 1: On
00080	0x004F	1 bit	CH7 DI Counter Status 0: Off 1: On
00085	0x0054	1 bit	CH0 DI Clear Count Value read always :0 Write: 1 : Clear counter value 0 : return Illegal Data Value
00086	0x0055	1 bit	CH1 DI Clear Count Value read always :0 Write: 1 : Clear counter value 0 : return Illegal Data Value
00087	0x0056	1 bit	CH2 DI Clear Count Value read always :0 Write: 1 : Clear counter value 0 : return Illegal Data Value
00088	0x0057	1 bit	CH3 DI Clear Count Value read always :0 Write: 1 : Clear counter value 0 : return Illegal Data Value
00089	0x0058	1 bit	CH4 DI Clear Count Value read always :0 Write: 1 : Clear counter value 0 : return Illegal Data Value
00090	0x0059	1 bit	CH5 DI Clear Count Value read always :0 Write: 1 : Clear counter value 0 : return Illegal Data Value
00091	0x005A	1 bit	CH6 DI Clear Count Value read always :0 Write: 1 : Clear counter value 0 : return Illegal Data Value
00092	0x005B	1 bit	CH7 DI Clear Count Value read always :0 Write: 1 : Clear counter value 0 : return Illegal Data Value
00097	0x0060	1 bit	CH0 DI OverFlow Status Read : 0 : Normal 1 : Overflow Write : 0 : clear overflow status 1 : return Illegal Data Value
00098	0x0061	1 bit	CH1 DI OverFlow Status Read : 0 : Normal 1 : Overflow Write : 0 : clear overflow status 1 : return Illegal Data Value

Reference	Address	Data Type	Description
00099	0x0062	1 bit	CH2 DI OverFlow Status Read : 0 : Normal 1 : Overflow Write : 0 : clear overflow status 1 : return Illegal Data Value
00100	0x0063	1 bit	CH3 DI OverFlow Status Read : 0 : Normal 1 : Overflow Write : 0 : clear overflow status 1 : return Illegal Data Value
00101	0x0064	1 bit	CH4 DI OverFlow Status Read : 0 : Normal 1 : Overflow Write : 0 : clear overflow status 1 : return Illegal Data Value
00102	0x0065	1 bit	CH5 DI OverFlow Status Read : 0 : Normal 1 : Overflow Write : 0 : clear overflow status 1 : return Illegal Data Value
00103	0x0066	1 bit	CH6 DI OverFlow Status Read : 0 : Normal 1 : Overflow Write : 0 : clear overflow status 1 : return Illegal Data Value
00104	0x0067	1 bit	CH7 DI OverFlow Status Read : 0 : Normal 1 : Overflow Write : 0 : clear overflow status 1 : return Illegal Data Value
00109	0x006C	1 bit	CH0 DI Count Trigger
00110	0x006D	1 bit	CH1 DI Count Trigger
00111	0x006E	1 bit	CH2 DI Count Trigger
00112	0x006F	1 bit	CH3 DI Count Trigger
00113	0x0070	1 bit	CH4 DI Count Trigger
00114	0x0071	1 bit	CH5 DI Count Trigger
00115	0x0072	1 bit	CH6 DI Count Trigger
00116	0x0073	1 bit	CH7 DI Count Trigger
00121	0x0078	1 bit	CH0 DI Power On Status 0: Off 1: On
00122	0x0079	1 bit	CH1 DI Power On Status 0: Off 1: On
00123	0x007A	1 bit	CH2 DI Power On Status 0: Off 1: On
00124	0x007B	1 bit	CH3 DI Power On Status 0: Off 1: On
00125	0x007C	1 bit	CH4 DI Power On Status 0: Off 1: On
00126	0x007D	1 bit	CH5 DI Power On Status 0: Off 1: On
00127	0x007E	1 bit	CH6 DI Power On Status 0: Off 1: On
00128	0x007F	1 bit	CH7 DI Power On Status 0: Off 1: On
00133	0x0084	1 bit	CH0 DI Safe Pulse Operate Status 0: Off 1: On
00134	0x0085	1 bit	CH1 DI Safe Pulse Operate Status 0: Off 1: On
00135	0x0086	1 bit	CH2 DI Safe Pulse Operate Status 0: Off 1: On
00136	0x0087	1 bit	CH3 DI Safe Pulse Operate Status 0: Off 1: On
00137	0x0088	1 bit	CH4 DI Safe Pulse Operate Status 0: Off 1: On
00138	0x0089	1 bit	CH5 DI Safe Pulse Operate Status 0: Off 1: On
00139	0x008A	1 bit	CH6 DI Safe Pulse Operate Status 0: Off 1: On

Reference	Address	Data Type	Description
00140	0x008B	1 bit	CH7 DI Safe Pulse Operate Status 0: Off 1: On
00145	0x0090	1 bit	CH0 DI set channel Power-off storage enable ON/OFF 1: ON 0: OFF
00146	0x0091	1 bit	CH1 DI set channel Power-off storage enable ON/OFF 1: ON 0: OFF
00147	0x0092	1 bit	CH2 DI set channel Power-off storage enable ON/OFF 1: ON 0: OFF
00148	0x0093	1 bit	CH3 DI set channel Power-off storage enable ON/OFF 1: ON 0: OFF
00149	0x0094	1 bit	CH4 DI set channel Power-off storage enable ON/OFF 1: ON 0: OFF
00150	0x0095	1 bit	CH5 DI set channel Power-off storage enable ON/OFF 1: ON 0: OFF
00151	0x0096	1 bit	CH6 DI set channel Power-off storage enable ON/OFF 1: ON 0: OFF
00152	0x0097	1 bit	CH7 DI set channel Power-off storage enable ON/OFF 1: ON 0: OFF
00157	0x009C	1 bit	DIO 00 1: OUTPUT 0: INPUT (Default: INPUT)
00158	0x009D	1 bit	DIO 01 1: OUTPUT 0: INPUT (Default: INPUT)
00159	0x009E	1 bit	DIO 02 1: OUTPUT 0: INPUT (Default: INPUT)
00160	0x009F	1 bit	DIO 03 1: OUTPUT 0: INPUT (Default: INPUT)
00161	0x00A0	1 bit	DIO 04 1: OUTPUT 0: INPUT (Default: OUTPUT)
00162	0x00A1	1 bit	DIO 05 1: OUTPUT 0: INPUT (Default: OUTPUT)

Reference	Address	Data Type	Description
00163	0x00A2	1 bit	DIO 06 1: OUTPUT 0: INPUT (Default: OUTPUT)
00164	0x00A3	1 bit	DIO 07 1: OUTPUT 0: INPUT (Default: OUTPUT)
AI Channels			
00257	0x0100	1bit	Reset CH0 AI Min Value Read: always 0 Write : 1: reset AI Min value 0: return Illegal Data Value
00258	0x0101	1bit	Reset CH1 AI Min Value Read: always 0 Write : 1: reset AI Min value 0: return Illegal Data Value
00259	0x0102	1bit	Reset CH2 AI Min Value Read: always 0 Write : 1: reset AI Min value 0: return Illegal Data Value
00260	0x0103	1bit	Reset CH3 AI Min Value Read: always 0 Write : 1: reset AI Min value 0: return Illegal Data Value
00265	0x0104	1bit	Reset CH0 AI Max Value Read: always 0 Write : 1: reset AI Max value 0: return Illegal Data Value
00266	0x0105	1bit	Reset CH1 AI Max Value Read: always 0 Write : 1: reset AI Max value 0: return Illegal Data Value
00267	0x0106	1bit	Reset CH2 AI Max Value Read: always 0 Write : 1: reset AI Max value 0: return Illegal Data Value
00268	0x0107	1bit	Reset CH3 AI Max Value Read: always 0 Write : 1: reset AI Max value 0: return Illegal Data Value

1xxxx Read only Coils (supports function 2)

Reference	Address	Data Type	Description
10001	0x0000	1 bit	CH0 DI Value
10002	0x0001	1 bit	CH1 DI Value
10003	0x0002	1 bit	CH2 DI Value
10004	0x0003	1 bit	CH3 DI Value
10005	0x0004	1 bit	CH4 DI Value
10006	0x0005	1 bit	CH5 DI Value
10007	0x0006	1 bit	CH6 DI Value
10008	0x0007	1 bit	CH7 DI Value

3xxxx Read-only Registers (supports function 4)

Reference	Address	Data Type	Description
30001	0x0000	word	CH0 DI Counter Value Hi- Word
30002	0x0001	word	CH0 DI Counter Value Lo- Word
30003	0x0002	word	CH1 DI Counter Value Hi- Word
30004	0x0003	word	CH1 DI Counter Value Lo- Word
30005	0x0004	word	CH2 DI Counter Value Hi- Word
30006	0x0005	word	CH2 DI Counter Value Lo- Word
30007	0x0006	word	CH3 DI Counter Value Hi- Word
30008	0x0007	word	CH3 DI Counter Value Lo- Word
30009	0x0008	word	CH4 DI Counter Value Hi- Word
30010	0x0009	word	CH4 DI Counter Value Lo- Word
30011	0x000A	word	CH5 DI Counter Value Hi- Word
30012	0x000B	word	CH5 DI Counter Value Lo- Word
30013	0x000C	word	CH6 DI Counter Value Hi- Word
30014	0x000D	word	CH6 DI Counter Value Lo- Word
30015	0x000E	word	CH7 DI Counter Value Hi- Word
30016	0x000F	word	CH7 DI Counter Value Lo- Word
30017	0x0010	word	CH8 DO Totoal Relay Count Value Hi-Byte (Relay)
30018	0x0011	word	CH8 DO Totoal Relay Count Value Lo-Byte (Relay)
30019	0x0012	word	CH9 DO Totoal Relay Count Value Hi-Byte (Relay)
30020	0x0013	word	CH9 DO Totoal Relay Count Value Lo-Byte (Relay)
30025	0x0018	word	CH0 Read AI Value
30026	0x0019	word	CH1 Read AI Value
30027	0x001A	word	CH2 Read AI Value
30028	0x001B	word	CH3 Read AI Value
30033	0x001C	word	CH0 Read AI Min Value
30034	0x001D	word	CH1 Read AI Min Value
30035	0x001E	word	CH2 Read AI Min Value
30036	0x001F	word	CH3 Read AI Min Value
30037	0x0020	word	CH0 Read AI Max Value
30038	0x0021	word	CH1 Read AI Max Value
30039	0x0022	word	CH2 Read AI Max Value
30040	0x0023	word	CH3 Read AI Max Value
30041	0x0024	word	CH0 Relay Totoal Relay Count Value (Relay)
30042	0x0025	word	CH1 Relay Totoal Relay Count Value (Relay)
30043	0x0026	word	CH0 Relay Last Reset Time for Current Relay Count(Relay)
30044	0x0027	word	CH1 Relay Last Reset Time for Current Relay Count(Relay)
System information (read)			
34122	0x1019	1 word	GSM/Cellular signal strength Value
34123	0x101A	2 word	Cellular IP
34125	0x101C	1 word	GSM/Cellular error message code
34126	0x101D	1 word	GSM/Cellular status
Virtual Channel			
	0x30AE-0x30C1	2x10 words	W5340 virtual channel value (in floating format) Each VC channel occupies 2 words

4xxxx Read/Write Registers (supports functions 3, 6, 16)

Reference	Address	Data Type	Description
40001	0x0000	1 word	CH0 DO Pulse Output Count Value Hi-Word
40002	0x0001	1 word	CH0 DO Pulse Output Count Value Lo-Word
40003	0x0002	1 word	CH1 DO Pulse Output Count Value Hi-Word
40004	0x0003	1 word	CH1 DO Pulse Output Count Value Lo- Word
40005	0x0004	1 word	CH2 DO Pulse Output Count Value Hi- Word
40006	0x0005	1 word	CH2 DO Pulse Output Count Value Lo- Word
40007	0x0006	1 word	CH3 DO Pulse Output Count Value Hi- Word
40008	0x0007	1 word	CH3 DO Pulse Output Count Value Lo- Word
40009	0x0008	1 word	CH4 DO Pulse Output Count Value Hi- Word
40010	0x0009	1 word	CH4 DO Pulse Output Count Value Lo- Word
40011	0x000A	1 word	CH5 DO Pulse Output Count Value Hi- Word
40012	0x000B	1 word	CH5 DO Pulse Output Count Value Lo- Word
40013	0x000C	1 word	CH6 DO Pulse Output Count Value Hi- Word
40014	0x000D	1 word	CH6 DO Pulse Output Count Value Lo- Word
40015	0x000E	1 word	CH7 DO Pulse Output Count Value Hi- Word
40016	0x000F	1 word	CH7 DO Pulse Output Count Value Lo- Word
40017	0x0010	1 word	CH8 DO Pulse Output Count Value Hi- Word (Relay)
40018	0x0011	1 word	CH8 DO Pulse Output Count Value Lo- Word (Relay)
40019	0x0012	1 word	CH9 DO Pulse Output Count Value Hi- Word (Relay)
40020	0x0013	1 word	CH9 DO Pulse Output Count Value Lo- Word (Relay)
40025	0x0018	1 word	CH0 DO Pulse Low Signal Width Hi- Word
40026	0x0019	1 word	CH0 DO Pulse Low Signal Width Lo- Word
40027	0x001A	1 word	CH1 DO Pulse Low Signal Width Hi- Word
40028	0x001B	1 word	CH1 DO Pulse Low Signal Width Lo- Word
40029	0x001C	1 word	CH2 DO Pulse Low Signal Width Hi- Word
40030	0x001D	1 word	CH2 DO Pulse Low Signal Width Lo- Word
40031	0x001E	1 word	CH3 DO Pulse Low Signal Width Hi- Word
40032	0x001F	1 word	CH3 DO Pulse Low Signal Width Lo- Word
40033	0x0020	1 word	CH4 DO Pulse Low Signal Width Hi- Word
40034	0x0021	1 word	CH4 DO Pulse Low Signal Width Lo- Word
40035	0x0022	1 word	CH5 DO Pulse Low Signal Width Hi- Word
40036	0x0023	1 word	CH5 DO Pulse Low Signal Width Lo- Word
40037	0x0024	1 word	CH6 DO Pulse Low Signal Width Hi- Word
40038	0x0025	1 word	CH6 DO Pulse Low Signal Width Lo- Word
40039	0x0026	1 word	CH7 DO Pulse Low Signal Width Hi- Word
40040	0x0027	1 word	CH7 DO Pulse Low Signal Width Lo- Word
40041	0x0028	1 word	CH8 DO Pulse Low Signal Width Hi- Word (Relay)
40042	0x0029	1 word	CH8 DO Pulse Low Signal Width Lo- Word (Relay)
40043	0x002A	1 word	CH9 DO Pulse Low Signal Width Hi- Word (Relay)
40044	0x002B	1 word	CH9 DO Pulse Low Signal Width Lo- Word (Relay)
40049	0x0030	1 word	CH0 DO Pulse High Signal Width Hi- Word
40050	0x0031	1 word	CH0 DO Pulse High Signal Width Lo- Word
40051	0x0032	1 word	CH1 DO Pulse High Signal Width Hi- Word
40052	0x0033	1 word	CH1 DO Pulse High Signal Width Lo- Word
40053	0x0034	1 word	CH2 DO Pulse High Signal Width Hi- Word
40054	0x0035	1 word	CH2 DO Pulse High Signal Width Lo- Word
40055	0x0036	1 word	CH3 DO Pulse High Signal Width Hi- Word
40056	0x0037	1 word	CH3 DO Pulse High Signal Width Lo- Word
40057	0x0038	1 word	CH4 DO Pulse High Signal Width Hi- Word

Reference	Address	Data Type	Description
40058	0x0039	1 word	CH4 DO Pulse High Signal Width Lo- Word
40059	0x003A	1 word	CH5 DO Pulse High Signal Width Hi- Word
40060	0x003B	1 word	CH5 DO Pulse High Signal Width Lo- Word
40061	0x003C	1 word	CH6 DO Pulse High Signal Width Hi- Word
40062	0x003D	1 word	CH6 DO Pulse High Signal Width Lo- Word
40063	0x003E	1 word	CH7 DO Pulse High Signal Width Hi- Word
40064	0x003F	1 word	CH7 DO Pulse High Signal Width Lo- Word
40065	0x0040	1 word	CH8 DO Pulse High Signal Width Hi- Word (Relay)
40066	0x0041	1 word	CH8 DO Pulse High Signal Width Lo- Word (Relay)
40067	0x0042	1 word	CH9 DO Pulse High Signal Width Hi- Word (Relay)
40068	0x0043	1 word	CH9 DO Pulse High Signal Width Lo- Word (Relay)
40073	0x0048	1 word	CH0 DO Mode 0: DO 1: Pulse
40074	0x0049	1 word	CH1 DO Mode 0: DO 1: Pulse
40075	0x004A	1 word	CH2 DO Mode 0: DO 1: Pulse
40076	0x004B	1 word	CH3 DO Mode 0: DO 1: Pulse
40077	0x004C	1 word	CH4 DO Mode 0: DO 1: Pulse
40078	0x004D	1 word	CH5 DO Mode 0: DO 1: Pulse
40079	0x004E	1 word	CH6 DO Mode 0: DO 1: Pulse
40080	0x004F	1 word	CH7 DO Mode 0: DO 1: Pulse
40081	0x0050	1 word	CH8 DO Mode 0: DO (Relay) 1: Pulse
40082	0x0051	1 word	CH9 DO Mode 0: DO (Relay) 1: Pulse
40085	0x0054	1 word	CH0 DI Count Filter
40086	0x0055	1 word	CH1 DI Count Filter
40087	0x0056	1 word	CH2 DI Count Filter
40088	0x0057	1 word	CH3 DI Count Filter
40089	0x0058	1 word	CH4 DI Count Filter
40090	0x0059	1 word	CH5 DI Count Filter
40091	0x005A	1 word	CH6 DI Count Filter
40092	0x005B	1 word	CH7 DI Count Filter
40097	0x0060	1 word	CH0 DI Mode 0: DI 1: Count Others : return Illegal Data Value
40098	0x0061	1 word	CH1 DI Mode 0: DI 1: Count Others : return Illegal Data Value
40099	0x0062	1 word	CH2 DI Mode 0: DI 1: Count Others : return Illegal Data Value

Reference	Address	Data Type	Description
40100	0x0063	1 word	CH3 DI Mode 0: DI 1: Count Others : return Illegal Data Value
40101	0x0064	1 word	CH4 DI Mode 0: DI 1: Count Others : return Illegal Data Value
40102	0x0065	1 word	CH5 DI Mode 0: DI 1: Count Others : return Illegal Data Value
40103	0x0066	1 word	CH6 DI Mode 0: DI 1: Count Others : return Illegal Data Value
40104	0x0067	1 word	CH7 DI Mode 0: DI 1: Count Others : return Illegal Data Value
40109	0x006C	1 word	CH0 AI set/get Enable 1: Enable , 0: Disable
40110	0x006D	1 word	CH1 AI set/get Enable 1: Enable , 0: Disable
40111	0x006E	1 word	CH2 AI set/get Enable 1: Enable , 0: Disable
40112	0x006F	1 word	CH3 AI set/get Enable 1: Enable , 0: Disable
40285	0x011C	1 word	AI Channel 0 Scaling Enable
40286	0x011D	1 word	AI Channel 1 Scaling Enable
40287	0x011E	1 word	AI Channel 2 Scaling Enable
40288	0x011F	1 word	AI Channel 3 Scaling Enable
40289	0x0120	1 word	AI Channel 0 RAW Min Value
40290	0x0121	1 word	AI Channel 1 RAW Min Value
40291	0x0122	1 word	AI Channel 2 RAW Min Value
40292	0x0123	1 word	AI Channel 3 RAW Min Value
40293	0x0124	1 word	AI Channel 0 RAW Max Value
40294	0x0125	1 word	AI Channel 1 RAW Max Value
40295	0x0126	1 word	AI Channel 2 RAW Max Value
40296	0x0127	1 word	AI Channel 3 RAW Max Value
40297	0x0128	1 word	AI Channel 0 Scale Min Value
40298	0x0129	1 word	AI Channel 1 Scale Min Value
40299	0x012A	1 word	AI Channel 2 Scale Min Value
40300	0x012B	1 word	AI Channel 3 Scale Min Value
40301	0x012C	1 word	AI Channel 0 Scale Max Value
40302	0x012D	1 word	AI Channel 1 Scale Max Value
40303	0x012E	1 word	AI Channel 2 Scale Max Value
40304	0x012F	1 word	AI Channel 3 Scale Max Value
40305	0x0130	1 word	AI Channel 0 Scale Value Hi-Word (float)
40306	0x0131	1 word	AI Channel 0 Scale Value Lo-Word (float)
40307	0x0132	1 word	AI Channel 1 Scale Value Hi-Word (float)
40308	0x0133	1 word	AI Channel 1 Scale Value Lo-Word (float)
40309	0x0134	1 word	AI Channel 2 Scale Value Hi-Word (float)
40310	0x0135	1 word	AI Channel 2 Scale Value Lo-Word (float)
40311	0x0136	1 word	AI Channel 3 Scale Value Hi-Word (float)

Reference	Address	Data Type	Description
40312	0x0137	1 word	AI Channel 3 Scale Value Lo-Word (float)
40337	0x0150	1 word	Internal Register 00 Initial Value
40338	0x0151	1 word	Internal Register 01 Initial Value
40339	0x0152	1 word	Internal Register 02 Initial Value
40340	0x0153	1 word	Internal Register 03 Initial Value
40341	0x0154	1 word	Internal Register 04 Initial Value
40342	0x0155	1 word	Internal Register 05 Initial Value
40343	0x0156	1 word	Internal Register 06 Initial Value
40344	0x0157	1 word	Internal Register 07 Initial Value
40345	0x0158	1 word	Internal Register 08 Initial Value
40346	0x0159	1 word	Internal Register 09 Initial Value
40347	0x015A	1 word	Internal Register 10 Initial Value
40348	0x015B	1 word	Internal Register 11 Initial Value
40349	0x015C	1 word	Internal Register 12 Initial Value
40350	0x015D	1 word	Internal Register 13 Initial Value
40351	0x015E	1 word	Internal Register 14 Initial Value
40352	0x015F	1 word	Internal Register 15 Initial Value
40353	0x0160	1 word	Internal Register 16 Initial Value
40354	0x0161	1 word	Internal Register 17 Initial Value
40355	0x0162	1 word	Internal Register 18 Initial Value
40356	0x0163	1 word	Internal Register 19 Initial Value
40357	0x0164	1 word	Internal Register 20 Initial Value
40358	0x0165	1 word	Internal Register 21 Initial Value
40359	0x0166	1 word	Internal Register 22 Initial Value
40360	0x0167	1 word	Internal Register 23 Initial Value
40361	0x0168	2 word	Time Init 00 Value
40362	0x0169	2 word	Time Init 01 Value
40363	0x016A	2 word	Time Init 02 Value
40364	0x016B	2 word	Time Init 03 Value
40365	0x016C	2 word	Time Init 04 Value
40366	0x016D	2 word	Time Init 05 Value
40367	0x016E	2 word	Time Init 06 Value
40368	0x016F	2 word	Time Init 07 Value
40369	0x0170	2 word	Time Init 08 Value
40370	0x0171	2 word	Time Init 09 Value
40371	0x0172	2 word	Time Init 10 Value
40372	0x0173	2 word	Time Init 11 Value
40373	0x0174	2 word	Time Init 12 Value
40374	0x0175	2 word	Time Init 13 Value
40375	0x0176	2 word	Time Init 14 Value
40376	0x0177	2 word	Time Init 15 Value
40377	0x0178	2 word	Time Init 16 Value
40378	0x0179	2 word	Time Init 17 Value
40379	0x017A	2 word	Time Init 18 Value
40380	0x017B	2 word	Time Init 19 Value
40381	0x017C	2 word	Time Init 20 Value
40382	0x017D	2 word	Time Init 21 Value
40383	0x017E	2 word	Time Init 22 Value
40384	0x017F	2 word	Time Init 23 Value
40385	0x0180	1 word	Timer Interval 00 Value
40386	0x0181	1 word	Timer Interval 01 Value
40387	0x0182	1 word	Timer Interval 02 Value

Reference	Address	Data Type	Description
40388	0x0183	1 word	Timer Interval 03 Value
40389	0x0184	1 word	Timer Interval 04 Value
40390	0x0185	1 word	Timer Interval 05 Value
40391	0x0186	1 word	Timer Interval 06 Value
40392	0x0187	1 word	Timer Interval 07 Value
40393	0x0188	1 word	Timer Interval 08 Value
40394	0x0189	1 word	Timer Interval 09 Value
40395	0x018A	1 word	Timer Interval 10 Value
40396	0x018B	1 word	Timer Interval 11 Value
40397	0x018C	1 word	Timer Interval 12 Value
40398	0x018D	1 word	Timer Interval 13 Value
40399	0x018E	1 word	Timer Interval 14 Value
40400	0x018F	1 word	Timer Interval 15 Value
40401	0x0190	1 word	Timer Interval 16 Value
40402	0x0191	1 word	Timer Interval 17 Value
40403	0x0192	1 word	Timer Interval 18 Value
40404	0x0193	1 word	Timer Interval 19 Value
40405	0x0194	1 word	Timer Interval 20 Value
40406	0x0195	1 word	Timer Interval 21 Value
40407	0x0196	1 word	Timer Interval 22 Value
40408	0x0197	2 word	Timer Interval 23 Value
40409	0x0198	10 word	Timer Description 00 Value
40410	0x0199	10 word	Timer Description 01 Value
40411	0x019A	10 word	Timer Description 02 Value
40412	0x019B	10 word	Timer Description 03 Value
40413	0x019C	10 word	Timer Description 04 Value
40414	0x019D	10 word	Timer Description 05 Value
40415	0x019E	10 word	Timer Description 06 Value
40416	0x019F	10 word	Timer Description 07 Value
40417	0x01A0	10 word	Timer Description 08 Value
40418	0x01A1	10 word	Timer Description 09 Value
40419	0x01A2	10 word	Timer Description 10 Value
40420	0x01A3	10 word	Timer Description 11 Value
40421	0x01A4	10 word	Timer Description 12 Value
40422	0x01A5	10 word	Timer Description 13 Value
40423	0x01A6	10 word	Timer Description 14 Value
40424	0x01A7	10 word	Timer Description 15 Value
40425	0x01A8	10 word	Timer Description 16 Value
40426	0x01A9	10 word	Timer Description 17 Value
40427	0x01AA	10 word	Timer Description 18 Value
40428	0x01AB	10 word	Timer Description 19 Value
40429	0x01AC	10 word	Timer Description 20 Value
40430	0x01AD	10 word	Timer Description 21 Value
40431	0x01AE	10 word	Timer Description 22 Value
40432	0x01AF	10 word	Timer Description 23 Value
40433	0x01B0	10 word	Internal Register Description 00 Value
40434	0x01B1	10 word	Internal Register Description 01 Value
40435	0x01B2	10 word	Internal Register Description 02 Value
40436	0x01B3	10 word	Internal Register Description 03 Value
40437	0x01B4	10 word	Internal Register Description 04 Value
40438	0x01B5	10 word	Internal Register Description 05 Value
40439	0x01B6	10 word	Internal Register Description 06 Value

Reference	Address	Data Type	Description
40440	0x01B7	10 word	Internal Register Description 07 Value
40441	0x01B8	10 word	Internal Register Description 08 Value
40442	0x01B9	10 word	Internal Register Description 09 Value
40443	0x01BA	10 word	Internal Register Description 10 Value
40444	0x01BB	10 word	Internal Register Description 11 Value
40445	0x01BC	10 word	Internal Register Description 12 Value
40446	0x01BD	10 word	Internal Register Description 13 Value
40447	0x01BE	10 word	Internal Register Description 14 Value
40418	0x01BF	10 word	Internal Register Description 15 Value
40419	0x01C0	10 word	Internal Register Description 16 Value
40420	0x01C1	10 word	Internal Register Description 17 Value
40421	0x01C2	10 word	Internal Register Description 18 Value
40422	0x01C3	10 word	Internal Register Description 19 Value
40423	0x01C4	10 word	Internal Register Description 20 Value
40424	0x01C5	10 word	Internal Register Description 21 Value
40425	0x01C6	10 word	Internal Register Description 22 Value
40426	0x01C7	10 word	Internal Register Description 23 Value
40427	0x01C8	1 word	Message Retry Times
40428	0x01C9	1 word	Message Retry Interval
40429	0x01CA	1 word	Mail Retry Times
40430	0x01CB	1 word	Mail Retry Interval
40431	0x01CC	1 word	SMS Retry Times
40432	0x01CD	1 word	SMS Retry Interval
40577	0x0240	20 word	Message Server Address 00
40578	0x0241	20 word	Message Server Address 01
40579	0x0242	20 word	Message Server Address 02
40580	0x0243	20 word	Message Server Address 03
40581	0x0244	20 word	Message Server Address 04
40582	0x0245	20 word	Message Server Address 05
40583	0x0246	20 word	Message Server Address 06
40584	0x0247	20 word	Message Server Address 07
40585	0x0248	20 word	Message Server Address 08
40586	0x0249	20 word	Message Server Address 09
48962	0x2301	2 word	CH8 DO Current Relay Count Value
48963	0x2302	2 word	CH9 DO Current Relay Count Value
40513	0x0200	1 word	CH0 AI Range 00: +/-150mV 01: +/-500mV 02: +/-5V 03: +/-10V 04: 0-20mA 05: 4-20mA 06: 0 -150mV 07: 0 - 500mV 08: 0 - 5V 09: 0 -10V Others: return Illegal Data Value

Reference	Address	Data Type	Description
40514	0x0201	1 word	CH1 AI Range 00: +/-150mV 01: +/-500mV 02: +/-5V 03: +/-10V 04: 0-20mA 05: 4-20mA 06: 0 -150mV 07: 0 - 500mV 08: 0 - 5V 09: 0 -10V Others: return Illegal Data Value
40515	0x0202	1 word	CH2 AI Range 00: +/-150mV 01: +/-500mV 02: +/-5V 03: +/-10V 04: 0-20mA 05: 4-20mA 06: 0 -150mV 07: 0 - 500mV 08: 0 - 5V 09: 0 -10V Others: return Illegal Data Value
40516	0x0203	1 word	CH3 AI Range 00: +/-150mV 01: +/-500mV 02: +/-5V 03: +/-10V 04: 0-20mA 05: 4-20mA 06: 0 -150mV 07: 0 - 500mV 08: 0 - 5V 09: 0 -10V Others: return Illegal Data Value
40517	0x0204	1 word	Virtual CH4 AI Range 00: +/-150mV 01: +/-500mV 02: +/-5V 03: +/-10V 04: 0-20mA 05: 4-20mA 06: 0 -150mV 07: 0 - 500mV 08: 0 - 5V 09: 0 -10V Others: return Illegal Data Value

Reference	Address	Data Type	Description
40518	0x0205	1 word	Virtual CH5 AI Range 00: +/-150mV 01: +/-500mV 02: +/-5V 03: +/-10V 04: 0-20mA 05: 4-20mA 06: 0 -150mV 07: 0 - 500mV 08: 0 - 5V 09: 0 -10V Others: return Illegal Data Value
40519	0x0206	1 word	Virtual CH6 AI Range 00: +/-150mV 01: +/-500mV 02: +/-5V 03: +/-10V 04: 0-20mA 05: 4-20mA 06 : 0 -150mV 07 : 0 - 500mV 08: 0 - 5V 09: 0 -10V Others: return Illegal Data Value
40520	0x0207	1 word	Virtual CH7 AI Range 00 : +/-150mV 01: +/-500mV 02: +/-5V 03: +/-10V 04: 0-20mA 05: 4-20mA 06 : 0 -150mV 07 : 0 - 500mV 08: 0 - 5V 09: 0 -10V Others: return Illegal Data Value
Internal Register (Integer)			
412840	0x3227	Word	Internal Registers 00 Working Value
412841	0x3228	Word	Internal Registers 01 Working Value
412842	0x3229	Word	Internal Registers 02 Working Value
412843	0x322A	Word	Internal Registers 03 Working Value
412844	0x322B	Word	Internal Registers 04 Working Value
412845	0x322C	Word	Internal Registers 05 Working Value
412846	0x322D	Word	Internal Registers 06 Working Value
412847	0x322E	Word	Internal Registers 07 Working Value
412848	0x322F	Word	Internal Registers 08 Working Value
412849	0x3230	Word	Internal Registers 09 Working Value
412850	0x3231	Word	Internal Registers 10 Working Value
412851	0x3232	Word	Internal Registers 11 Working Value
412852	0x3233	Word	Internal Registers 12 Working Value
412853	0x3234	Word	Internal Registers 13 Working Value
412854	0x3235	Word	Internal Registers 14 Working Value
412855	0x3236	Word	Internal Registers 15 Working Value

Reference	Address	Data Type	Description
412856	0x3237	Word	Internal Registers 16 Working Value
412857	0x3238	Word	Internal Registers 17 Working Value
412858	0x3239	Word	Internal Registers 18 Working Value
412859	0x323A	Word	Internal Registers 19 Working Value
412860	0x323B	Word	Internal Registers 20 Working Value
412861	0x323C	Word	Internal Registers 21 Working Value
412862	0x323D	Word	Internal Registers 22 Working Value
412863	0x323E	Word	Internal Registers 23 Working Value
Internal Register (Float)			
419413	0x4BD4	word	Internal Register (Float) 00 Initial Value Hi-Word
419414	0x4BD5	word	Internal Register (Float) 00 Initial Value Lo-Word
419415	0x4BD6	word	Internal Register (Float) 01 Initial Value Hi-Word
419416	0x4BD7	word	Internal Register (Float) 01 Initial Value Lo-Word
419417	0x4BD8	word	Internal Register (Float) 02 Initial Value Hi-Word
419418	0x4BD9	word	Internal Register (Float) 02 Initial Value Lo-Word
419419	0x4BDA	word	Internal Register (Float) 03 Initial Value Hi-Word
419420	0x4BDB	word	Internal Register (Float) 03 Initial Value Lo-Word
419421	0x4BDC	word	Internal Register (Float) 04 Initial Value Hi-Word
419422	0x4BDD	word	Internal Register (Float) 04 Initial Value Lo-Word
419423	0x4BDE	word	Internal Register (Float) 05 Initial Value Hi-Word
419424	0x4BDF	word	Internal Register (Float) 05 Initial Value Lo-Word
419425	0x4BE0	word	Internal Register (Float) 06 Initial Value Hi-Word
419426	0x4BE1	word	Internal Register (Float) 06 Initial Value Lo-Word
419427	0x4BE2	word	Internal Register (Float) 07 Initial Value Hi-Word
419428	0x4BE3	word	Internal Register (Float) 07 Initial Value Lo-Word
419429	0x4BE4	word	Internal Register (Float) 08 Initial Value Hi-Word
419430	0x4BE5	word	Internal Register (Float) 08 Initial Value Lo-Word
419431	0x4BE6	word	Internal Register (Float) 09 Initial Value Hi-Word
419432	0x4BE7	word	Internal Register (Float) 09 Initial Value Lo-Word
419433	0x4BE8	word	Internal Register (Float) 10 Initial Value Hi-Word
419434	0x4BE9	word	Internal Register (Float) 10 Initial Value Lo-Word
419435	0x4BEA	word	Internal Register (Float) 11 Initial Value Hi-Word
419436	0x4BEB	word	Internal Register (Float) 11 Initial Value Lo-Word
419437	0x4BEC	word	Internal Register (Float) 12 Initial Value Hi-Word
419438	0x4BED	word	Internal Register (Float) 12 Initial Value Lo-Word
419439	0x4BEE	word	Internal Register (Float) 13 Initial Value Hi-Word
419440	0x4BEF	word	Internal Register (Float) 13 Initial Value Lo-Word
419441	0x4BF0	word	Internal Register (Float) 14 Initial Value Hi-Word
419442	0x4BF1	word	Internal Register (Float) 14 Initial Value Lo-Word
419443	0x4BF2	word	Internal Register (Float) 15 Initial Value Hi-Word
419444	0x4BF3	word	Internal Register (Float) 15 Initial Value Lo-Word
419445	0x4BF4	word	Internal Register (Float) 16 Initial Value Hi-Word
419446	0x4BF5	word	Internal Register (Float) 16 Initial Value Lo-Word
419447	0x4BF6	word	Internal Register (Float) 17 Initial Value Hi-Word
419448	0x4BF7	word	Internal Register (Float) 17 Initial Value Lo-Word
419449	0x4BF8	word	Internal Register (Float) 18 Initial Value Hi-Word
419450	0x4BF9	word	Internal Register (Float) 18 Initial Value Lo-Word
419451	0x4BFA	word	Internal Register (Float) 19 Initial Value Hi-Word
419452	0x4BFB	word	Internal Register (Float) 19 Initial Value Lo-Word
419453	0x4BFC	word	Internal Register (Float) 20 Initial Value Hi-Word
419454	0x4BFD	word	Internal Register (Float) 20 Initial Value Lo-Word
419455	0x4BFE	word	Internal Register (Float) 21 Initial Value Hi-Word

Reference	Address	Data Type	Description
419456	0x4BFF	word	Internal Register (Float) 21 Initial Value Lo-Word
419457	0x4C00	word	Internal Register (Float) 22 Initial Value Hi-Word
419458	0x4C01	word	Internal Register (Float) 22 Initial Value Lo-Word
419459	0x4C02	word	Internal Register (Float) 23 Initial Value Hi-Word
419460	0x4C03	word	Internal Register (Float) 23 Initial Value Lo-Word
419461	0x4C04	word	Internal Register (Float) 24 Initial Value Hi-Word
419462	0x4C05	word	Internal Register (Float) 24 Initial Value Lo-Word
419463	0x4C06	word	Internal Register (Float) 25 Initial Value Hi-Word
419464	0x4C07	word	Internal Register (Float) 25 Initial Value Lo-Word
419465	0x4C08	word	Internal Register (Float) 26 Initial Value Hi-Word
419466	0x4C09	word	Internal Register (Float) 26 Initial Value Lo-Word
419467	0x4C0A	word	Internal Register (Float) 27 Initial Value Hi-Word
419468	0x4C0B	word	Internal Register (Float) 27 Initial Value Lo-Word
419469	0x4C0C	word	Internal Register (Float) 00 Working Value Hi-Word
419470	0x4C0D	word	Internal Register (Float) 00 Working Value Lo-Word
419471	0x4C0E	word	Internal Register (Float) 01 Working Value Hi-Word
419472	0x4C0F	word	Internal Register (Float) 01 Working Value Lo-Word
419473	0x4C10	word	Internal Register (Float) 02 Working Value Hi-Word
419474	0x4C11	word	Internal Register (Float) 02 Working Value Lo-Word
419475	0x4C12	word	Internal Register (Float) 03 Working Value Hi-Word
419476	0x4C13	word	Internal Register (Float) 03 Working Value Lo-Word
419477	0x4C14	word	Internal Register (Float) 04 Working Value Hi-Word
419478	0x4C15	word	Internal Register (Float) 04 Working Value Lo-Word
419479	0x4C16	word	Internal Register (Float) 05 Working Value Hi-Word
419480	0x4C17	word	Internal Register (Float) 05 Working Value Lo-Word
419481	0x4C18	word	Internal Register (Float) 06 Working Value Hi-Word
419482	0x4C19	word	Internal Register (Float) 06 Working Value Lo-Word
419483	0x4C1A	word	Internal Register (Float) 07 Working Value Hi-Word
419484	0x4C1B	word	Internal Register (Float) 07 Working Value Lo-Word
419485	0x4C1C	word	Internal Register (Float) 08 Working Value Hi-Word
419486	0x4C1D	word	Internal Register (Float) 08 Working Value Lo-Word
419487	0x4C1E	word	Internal Register (Float) 09 Working Value Hi-Word
419488	0x4C1F	word	Internal Register (Float) 09 Working Value Lo-Word
419489	0x4C20	word	Internal Register (Float) 10 Working Value Hi-Word
419490	0x4C21	word	Internal Register (Float) 10 Working Value Lo-Word
419491	0x4C22	word	Internal Register (Float) 11 Working Value Hi-Word
419492	0x4C23	word	Internal Register (Float) 11 Working Value Lo-Word
419493	0x4C24	word	Internal Register (Float) 12 Working Value Hi-Word
419494	0x4C25	word	Internal Register (Float) 12 Working Value Lo-Word
419495	0x4C26	word	Internal Register (Float) 13 Working Value Hi-Word
419496	0x4C27	word	Internal Register (Float) 13 Working Value Lo-Word
419497	0x4C28	word	Internal Register (Float) 14 Working Value Hi-Word
419498	0x4C29	word	Internal Register (Float) 14 Working Value Lo-Word
419499	0x4C2A	word	Internal Register (Float) 15 Working Value Hi-Word
419500	0x4C2B	word	Internal Register (Float) 15 Working Value Lo-Word
419501	0x4C2C	word	Internal Register (Float) 16 Working Value Hi-Word
419502	0x4C2D	word	Internal Register (Float) 16 Working Value Lo-Word
419503	0x4C2E	word	Internal Register (Float) 17 Working Value Hi-Word
419504	0x4C2F	word	Internal Register (Float) 17 Working Value Lo-Word
419505	0x4C30	word	Internal Register (Float) 18 Working Value Hi-Word
419506	0x4C31	word	Internal Register (Float) 18 Working Value Lo-Word
419507	0x4C32	word	Internal Register (Float) 19 Working Value Hi-Word

Reference	Address	Data Type	Description
419508	0x4C33	word	Internal Register (Float) 19 Working Value Lo-Word
419509	0x4C34	word	Internal Register (Float) 20 Working Value Hi-Word
419510	0x4C35	word	Internal Register (Float) 20 Working Value Lo-Word
419511	0x4C36	word	Internal Register (Float) 21 Working Value Hi-Word
419512	0x4C37	word	Internal Register (Float) 21 Working Value Lo-Word
419513	0x4C38	word	Internal Register (Float) 22 Working Value Hi-Word
419514	0x4C39	word	Internal Register (Float) 22 Working Value Lo-Word
419515	0x4C3A	word	Internal Register (Float) 23 Working Value Hi-Word
419516	0x4C3B	word	Internal Register (Float) 23 Working Value Lo-Word
419517	0x4C3C	word	Internal Register (Float) 24 Working Value Hi-Word
419518	0x4C3D	word	Internal Register (Float) 24 Working Value Lo-Word
419519	0x4C3E	word	Internal Register (Float) 25 Working Value Hi-Word
419520	0x4C3F	word	Internal Register (Float) 25 Working Value Lo-Word
419521	0x4C40	word	Internal Register (Float) 26 Working Value Hi-Word
419522	0x4C41	word	Internal Register (Float) 26 Working Value Lo-Word
419523	0x4C42	word	Internal Register (Float) 27 Working Value Hi-Word
419524	0x4C43	word	Internal Register (Float) 27 Working Value Lo-Word
419525	0x4C44	10 word	Internal Register (Float) 00 Description
419526	0x4C45	10 word	Internal Register (Float) 01 Description
419527	0x4C46	10 word	Internal Register (Float) 02 Description
419528	0x4C47	10 word	Internal Register (Float) 03 Description
419529	0x4C48	10 word	Internal Register (Float) 04 Description
419530	0x4C49	10 word	Internal Register (Float) 05 Description
419531	0x4C4A	10 word	Internal Register (Float) 06 Description
419532	0x4C4B	10 word	Internal Register (Float) 07 Description
419533	0x4C4C	10 word	Internal Register (Float) 08 Description
419534	0x4C4D	10 word	Internal Register (Float) 09 Description
419535	0x4C4E	10 word	Internal Register (Float) 10 Description
419536	0x4C4F	10 word	Internal Register (Float) 11 Description
419537	0x4C50	10 word	Internal Register (Float) 12 Description
419538	0x4C51	10 word	Internal Register (Float) 13 Description
419539	0x4C52	10 word	Internal Register (Float) 14 Description
419540	0x4C53	10 word	Internal Register (Float) 15 Description
419541	0x4C54	10 word	Internal Register (Float) 16 Description
419542	0x4C55	10 word	Internal Register (Float) 17 Description
419543	0x4C56	10 word	Internal Register (Float) 18 Description
419544	0x4C57	10 word	Internal Register (Float) 19 Description
419545	0x4C58	10 word	Internal Register (Float) 20 Description
419546	0x4C59	10 word	Internal Register (Float) 21 Description
419547	0x4C5A	10 word	Internal Register (Float) 22 Description
419548	0x4C5B	10 word	Internal Register (Float) 23 Description
419549	0x4C5C	10 word	Internal Register (Float) 24 Description
419550	0x4C5D	10 word	Internal Register (Float) 25 Description
419551	0x4C5E	10 word	Internal Register (Float) 26 Description
419552	0x4C5F	10 word	Internal Register (Float) 27 Description

5xxxx Write Registers (supports function 8)

Sub-function	Data Field (Request)	Data Field (Response)	Description
0x0001	0xFF00	Echo Request Data	Reboot
0x0001	0x55AA	Echo Request Data	Reset with Factory default

ioLogik W5312 Modbus Mapping

NOTE For Modbus addresses of the ioLogik E1200 expansion modules attached to the ioLogik W5312, check the ioAdmin **I/O Expansion** tabs for details.

0xxxx Read/Write Coils (supports functions 1, 5, 15)

Reference	Address	Data Type	Description
DIO Channels			
00001	0x0000	1 bit	CH0 DO Value 0: Off 1: On
00002	0x0001	1 bit	CH1 DO Value 0: Off 1: On
00003	0x0002	1 bit	CH2 DO Value 0: Off 1: On
00004	0x0003	1 bit	CH3 DO Value 0: Off 1: On
00005	0x0004	1 bit	CH4 DO Value 0: Off 1: On
00006	0x0005	1 bit	CH5 DO Value 0: Off 1: On
00007	0x0006	1 bit	CH6 DO Value 0: Off 1: On
00008	0x0007	1 bit	CH7 DO Value 0: Off 1: On
00009	0x0008	1 bit	CH8 DO Value 0: Off 1: On (DIO)
00010	0x0009	1 bit	CH9 DO Value 0: Off 1: On (DIO)
00011	0x0010	1 bit	CH10 DO Value 0: Off 1: On (DIO)
00012	0x0011	1 bit	CH11 DO Value 0: Off 1: On (DIO)
00013	0x000C	1 bit	CH0 DO Power On Value 0: Off 1: On
00014	0x000D	1 bit	CH1 DO Power On Value 0: Off 1: On
00015	0x000E	1 bit	CH2 DO Power On Value 0: Off 1: On
00016	0x000F	1 bit	CH3 DO Power On Value 0: Off 1: On
00017	0x0010	1 bit	CH4 DO Power On Value 0: Off 1: On
00018	0x0011	1 bit	CH5 DO Power On Value 0: Off 1: On
00019	0x0012	1 bit	CH6 DO Power On Value 0: Off 1: On
00020	0x0013	1 bit	CH7 DO Power On Value 0: Off 1: On
00021	0x0014	1 bit	CH8 DO Power On Value 0: Off 1: On (DIO)
00022	0x0015	1 bit	CH9 DO Power On Value 0: Off 1: On (DIO)
00023	0x0016	1 bit	CH10 DO Power On Value 0: Off 1: On (DIO)
00024	0x0017	1 bit	CH11 DO Power On Value 0: Off 1: On (DIO)
00037	0x0024	1 bit	CH0 DO Pulse Operate Status 0: Off 1: On
00038	0x0025	1 bit	CH1 DO Pulse Operate Status 0: Off 1: On
00039	0x0026	1 bit	CH2 DO Pulse Operate Status 0: Off 1: On
00040	0x0027	1 bit	CH3 DO Pulse Operate Status 0: Off 1: On
00041	0x0028	1 bit	CH4 DO Pulse Operate Status 0: Off 1: On
00042	0x0029	1 bit	CH5 DO Pulse Operate Status 0: Off 1: On
00043	0x002A	1 bit	CH6 DO Pulse Operate Status 0: Off 1: On
00044	0x002B	1 bit	CH7 DO Pulse Operate Status 0: Off 1: On
00045	0x002C	1 bit	CH8 DO Pulse Operate Status 0: Off 1: On (DIO)
00046	0x002D	1 bit	CH9 DO Pulse Operate Status 0: Off 1: On (DIO)
00047	0x002E	1 bit	CH10 DO Pulse Operate Status 0: Off 1: On (DIO)
00048	0x002F	1 bit	CH11 DO Pulse Operate Status 0: Off 1: On (DIO)
00049	0x0030	1 bit	CH0 DO PowerOn Pulse Operate Status 0: Off 1: On
00050	0x0031	1 bit	CH1 DO PowerOn Pulse Operate Status 0: Off 1: On
00051	0x0032	1 bit	CH2 DO PowerOn Pulse Operate Status 0: Off 1: On
00052	0x0033	1 bit	CH3 DO PowerOn Pulse Operate Status 0: Off 1: On
00053	0x0034	1 bit	CH4 DO PowerOn Pulse Operate Status 0: Off 1: On
00054	0x0035	1 bit	CH5 DO PowerOn Pulse Operate Status 0: Off 1: On

Reference	Address	Data Type	Description
00055	0x0036	1 bit	CH6 DO PowerOn Pulse Operate Status 0: Off 1: On
00056	0x0037	1 bit	CH7 DO PowerOn Pulse Operate Status 0: Off 1: On
00057	0x0038	1 bit	CH8 DO PowerOn Pulse Operate Status 0: Off 1: On (DIO)
00058	0x0039	1 bit	CH9 DO PowerOn Pulse Operate Status 0: Off 1: On (DIO)
00059	0x003A	1 bit	CH10 DO PowerOn Pulse Operate Status 0: Off 1: On (DIO)
00060	0x003B	1 bit	CH11 DO PowerOn Pulse Operate Status 0: Off 1: On (DIO)
00061	0x003C	1 bit	CH0 DO Safe Pulse Operate Status 0: Off 1: On
00062	0x003D	1 bit	CH1 DO Safe Pulse Operate Status 0: Off 1: On
00063	0x003E	1 bit	CH2 DO Safe Pulse Operate Status 0: Off 1: On
00064	0x003F	1 bit	CH3 DO Safe Pulse Operate Status 0: Off 1: On
00065	0x0040	1 bit	CH4 DO Safe Pulse Operate Status 0: Off 1: On
00066	0x0041	1 bit	CH5 DO Safe Pulse Operate Status 0: Off 1: On
00067	0x0042	1 bit	CH6 DO Safe Pulse Operate Status 0: Off 1: On
00068	0x0043	1 bit	CH7 DO Safe Pulse Operate Status 0: Off 1: On
00069	0x0044	1 bit	CH8 DO Safe Pulse Operate Status 0: Off 1: On (DIO)
00070	0x0045	1 bit	CH9 DO Safe Pulse Operate Status 0: Off 1: On (DIO)
00071	0x0046	1 bit	CH10 DO Safe Pulse Operate Status 0: Off 1: On (DIO)
00072	0x0047	1 bit	CH11 DO Safe Pulse Operate Status 0: Off 1: On (DIO)
00073	0x0048	1 bit	CH0 DI Counter Status 0: Off 1: On
00074	0x0049	1 bit	CH1 DI Counter Status 0: Off 1: On
00075	0x004A	1 bit	CH2 DI Counter Status 0: Off 1: On
00076	0x004B	1 bit	CH3 DI Counter Status 0: Off 1: On
00077	0x004C	1 bit	CH4 DI Counter Status 0: Off 1: On
00078	0x004D	1 bit	CH5 DI Counter Status 0: Off 1: On
00079	0x004E	1 bit	CH6 DI Counter Status 0: Off 1: On
00080	0x004F	1 bit	CH7 DI Counter Status 0: Off 1: On
00081	0x0050	1 bit	CH8 DI Counter Status 0: Off 1: On (DIO)
00082	0x0051	1 bit	CH9 DI Counter Status 0: Off 1: On (DIO)
00083	0x0052	1 bit	CH10 DI Counter Status 0: Off 1: On (DIO)
00084	0x0053	1 bit	CH11 DI Counter Status 0: Off 1: On (DIO)
00085	0x0054	1 bit	CH0 DI Clear Count Value read aways :0 Write: 1 : Clear counter value 0 : return Illegal Data Value
00086	0x0055	1 bit	CH1 DI Clear Count Value read aways :0 Write: 1 : Clear counter value 0 : return Illegal Data Value
00087	0x0056	1 bit	CH2 DI Clear Count Value read aways :0 Write: 1 : Clear counter value 0 : return Illegal Data Value
00088	0x0057	1 bit	CH3 DI Clear Count Value read aways :0 Write: 1 : Clear counter value 0 : return Illegal Data Value
00089	0x0058	1 bit	CH4 DI Clear Count Value read aways :0 Write: 1 : Clear counter value 0 : return Illegal Data Value
00090	0x0059	1 bit	CH5 DI Clear Count Value read aways :0 Write: 1 : Clear counter value 0 : return Illegal Data Value
00091	0x005A	1 bit	CH6 DI Clear Count Value read aways :0 Write: 1 : Clear counter value 0 : return Illegal Data Value

Reference	Address	Data Type	Description
00092	0x005B	1 bit	CH7 DI Clear Count Value read aways :0 Write: 1 : Clear counter value 0 : return Illegal Data Value
00093	0x005C	1 bit	CH8 DI Clear Count Value read aways :0 Write: 1 : Clear counter value (DIO) 0 : return Illegal Data Value
00094	0x005D	1 bit	CH9 DI Clear Count Value read aways :0 Write: 1 : Clear counter value 0 : return Illegal Data Value (DIO)
00095	0x005E	1 bit	CH10 DI Clear Count Value read aways :0 Write: 1 : Clear counter value 0 : return Illegal Data Value (DIO)
00096	0x005F	1 bit	CH11 DI Clear Count Value read aways :0 Write: 1 : Clear counter value 0 : return Illegal Data Value (DIO)
00097	0x0060	1 bit	CH0 DI OverFlow Status Read : 0 : Normal 1 : Overflow Write : 0 : clear overflow status 1 : return Illegal Data Value
00098	0x0061	1 bit	CH1 DI OverFlow Status Read : 0 : Normal 1 : Overflow Write : 0 : clear overflow status 1 : return Illegal Data Value
00099	0x0062	1 bit	CH2 DI OverFlow Status Read : 0 : Normal 1 : Overflow Write : 0 : clear overflow status 1 : return Illegal Data Value
00100	0x0063	1 bit	CH3 DI OverFlow Status Read : 0 : Normal 1 : Overflow Write : 0 : clear overflow status 1 : return Illegal Data Value
00101	0x0064	1 bit	CH4 DI OverFlow Status Read : 0 : Normal 1 : Overflow Write : 0 : clear overflow status 1 : return Illegal Data Value
00102	0x0065	1 bit	CH5 DI OverFlow Status Read : 0 : Normal 1 : Overflow Write : 0 : clear overflow status 1 : return Illegal Data Value
00103	0x0066	1 bit	CH6 DI OverFlow Status Read : 0 : Normal 1 : Overflow Write : 0 : clear overflow status 1 : return Illegal Data Value

Reference	Address	Data Type	Description
00104	0x0067	1 bit	CH7 DI OverFlow Status Read : 0 : Normal 1 : Overflow Write : 0 : clear overflow status 1 : return Illegal Data Value
00105	0x0068	1 bit	CH8 DI OverFlow Status Read : 0 : Normal 1 : Overflow Write : 0 : clear overflow status 1 : return Illegal Data Value (DIO)
00106	0x0069	1 bit	CH9 DI OverFlow Status Read : 0 : Normal 1 : Overflow Write : 0 : clear overflow status 1 : return Illegal Data Value (DIO)
00107	0x006A	1 bit	CH10 DI OverFlow Status Read : 0 : Normal 1 : Overflow Write : 0 : clear overflow status 1 : return Illegal Data Value (DIO)
00108	0x006B	1 bit	CH11 DI OverFlow Status Read : 0 : Normal 1 : Overflow Write : 0 : clear overflow status 1 : return Illegal Data Value (DIO)
00109	0x006C	1 bit	CH0 DI Count Trigger
00110	0x006D	1 bit	CH1 DI Count Trigger
00111	0x006E	1 bit	CH2 DI Count Trigger
00112	0x006F	1 bit	CH3 DI Count Trigger
00113	0x0070	1 bit	CH4 DI Count Trigger
00114	0x0071	1 bit	CH5 DI Count Trigger
00115	0x0072	1 bit	CH6 DI Count Trigger
00116	0x0073	1 bit	CH7 DI Count Trigger
00117	0x0074	1 bit	CH8 DI Count Trigger (DIO)
00118	0x0075	1 bit	CH9 DI Count Trigger (DIO)
00119	0x0076	1 bit	CH10 DI Count Trigger (DIO)
00120	0x0077	1 bit	CH11 DI Count Trigger (DIO)
00121	0x0078	1 bit	CH0 DI Power On Status 0: Off 1: On
00122	0x0079	1 bit	CH1 DI Power On Status 0: Off 1: On
00123	0x007A	1 bit	CH2 DI Power On Status 0: Off 1: On
00124	0x007B	1 bit	CH3 DI Power On Status 0: Off 1: On
00125	0x007C	1 bit	CH4 DI Power On Status 0: Off 1: On
00126	0x007D	1 bit	CH5 DI Power On Status 0: Off 1: On
00127	0x007E	1 bit	CH6 DI Power On Status 0: Off 1: On
00128	0x007F	1 bit	CH7 DI Power On Status 0: Off 1: On
00129	0x0080	1 bit	CH8 DI Power On Status 0: Off 1: On (DIO)
00130	0x0081	1 bit	CH9 DI Power On Status 0: Off 1: On (DIO)
00131	0x0082	1 bit	CH10 DI Power On Status 0: Off 1: On (DIO)
00132	0x0083	1 bit	CH11 DI Power On Status 0: Off 1: On (DIO)
00133	0x0084	1 bit	CH0 DI Safe Pulse Operate Status 0: Off 1: On
00134	0x0085	1 bit	CH1 DI Safe Pulse Operate Status 0: Off 1: On
00135	0x0086	1 bit	CH2 DI Safe Pulse Operate Status 0: Off 1: On

Reference	Address	Data Type	Description
00136	0x0087	1 bit	CH3 DI Safe Pulse Operate Status 0: Off 1: On
00137	0x0088	1 bit	CH4 DI Safe Pulse Operate Status 0: Off 1: On
00138	0x0089	1 bit	CH5 DI Safe Pulse Operate Status 0: Off 1: On
00139	0x008A	1 bit	CH6 DI Safe Pulse Operate Status 0: Off 1: On
00140	0x008B	1 bit	CH7 DI Safe Pulse Operate Status 0: Off 1: On
00141	0x008C	1 bit	CH8 DI Safe Pulse Operate Status 0: Off 1: On (DIO)
00142	0x008D	1 bit	CH9 DI Safe Pulse Operate Status 0: Off 1: On (DIO)
00143	0x008E	1 bit	CH10 DI Safe Pulse Operate Status 0: Off 1: On (DIO)
00144	0x008F	1 bit	CH11 DI Safe Pulse Operate Status 0: Off 1: On (DIO)
00145	0x0090	1 bit	CH0 DI set channel Power-off storage enable ON/OFF 1: ON 0: OFF
00146	0x0091	1 bit	CH1 DI set channel Power-off storage enable ON/OFF 1: ON 0: OFF
00147	0x0092	1 bit	CH2 DI set channel Power-off storage enable ON/OFF 1: ON 0: OFF
00148	0x0093	1 bit	CH3 DI set channel Power-off storage enable ON/OFF 1: ON 0: OFF
00149	0x0094	1 bit	CH4 DI set channel Power-off storage enable ON/OFF 1: ON 0: OFF
00150	0x0095	1 bit	CH5 DI set channel Power-off storage enable ON/OFF 1: ON 0: OFF
00151	0x0096	1 bit	CH6 DI set channel Power-off storage enable ON/OFF 1: ON 0: OFF
00152	0x0097	1 bit	CH7 DI set channel Power-off storage enable ON/OFF 1: ON 0: OFF
00153	0x0098	1 bit	CH8 DI set channel (DIO) Power-off storage enable ON/OFF 1: ON 0: OFF
00154	0x0099	1 bit	CH9 DI set channel (DIO) Power-off storage enable ON/OFF 1: ON 0: OFF
00155	0x009A	1 bit	CH10 DI set channel (DIO) Power-off storage enable ON/OFF 1: ON 0: OFF

Reference	Address	Data Type	Description
00156	0x009B	1 bit	CH11 DI set channel (DIO) Power-off storage enable ON/OFF 1: ON 0: OFF
00165	0x00A4	1 bit	DIO 8 Set DIO direction 1: OUTPUT 0: INPUT (Default: INPUT)
00166	0x00A5	1 bit	DIO 9 Set DIO direction 1: OUTPUT 0: INPUT (Default: INPUT)
00167	0x00A6	1 bit	DIO 10 Set DIO direction 1: OUTPUT 0: INPUT (Default: INPUT)
00168	0x00A7	1 bit	DIO 11 Set DIO direction 1: OUTPUT 0: INPUT (Default: INPUT)

1xxxx Read only Coils (supports function 2)

Reference	Address	Data Type	Description
10001	0x0000	1 bit	CH0 DI Value
10002	0x0001	1 bit	CH1 DI Value
10003	0x0002	1 bit	CH2 DI Value
10004	0x0003	1 bit	CH3 DI Value
10005	0x0004	1 bit	CH4 DI Value
10006	0x0005	1 bit	CH5 DI Value
10007	0x0006	1 bit	CH6 DI Value
10008	0x0007	1 bit	CH7 DI Value
10009	0x0008	1 bit	CH8 DI Value (DIO)
10010	0x0009	1 bit	CH9 DI Value (DIO)
10011	0x000A	1 bit	CH10 DI Value (DIO)
10012	0x000B	1 bit	CH11 DI Value (DIO)

3xxxx Read only Registers (supports function 4)

Reference	Address	Data Type	Description
30001	0x0000	word	CH0 DI Counter Value Hi- Word
30002	0x0001	word	CH0 DI Counter Value Lo- Word
30003	0x0002	word	CH1 DI Counter Value Hi- Word
30004	0x0003	word	CH1 DI Counter Value Lo- Word
30005	0x0004	word	CH2 DI Counter Value Hi- Word
30006	0x0005	word	CH2 DI Counter Value Lo- Word
30007	0x0006	word	CH3 DI Counter Value Hi- Word
30008	0x0007	word	CH3 DI Counter Value Lo- Word
30009	0x0008	word	CH4 DI Counter Value Hi- Word
30010	0x0009	word	CH4 DI Counter Value Lo- Word
30011	0x000A	word	CH5 DI Counter Value Hi- Word
30012	0x000B	word	CH5 DI Counter Value Lo- Word
30013	0x000C	word	CH6 DI Counter Value Hi- Word
30014	0x000D	word	CH6 DI Counter Value Lo- Word
30015	0x000E	word	CH7 DI Counter Value Hi- Word

Reference	Address	Data Type	Description
30016	0x000F	word	CH7 DI Counter Value Lo- Word
30017	0x0010	word	CH8 DI Counter Value Hi- Word (DIO)
30018	0x0011	word	CH8 DI Counter Value Lo- Word
30019	0x0012	word	CH9 DI Counter Value Hi- Word (DIO)
30020	0x0013	word	CH9 DI Counter Value Lo- Word
30021	0x0014	word	CH10 DI Counter Value Hi- Word (DIO)
30022	0x0015	word	CH10 DI Counter Value Lo- Word
30023	0x0016	word	CH11 DI Counter Value Hi- Word (DIO)
30024	0x0017	word	CH11 DI Counter Value Lo- Word
System Information (read)			
34097	0x1000(4096)	1 word	Vendor ID=0x1393
34098	0x1001(4097)	1 word	Unit ID (Ethernet=1)
34099	0x1002(4098)	1 word	Product Code=0x5312
34100	0x1003	20 word	Vendor name string="Moxa Technologies Inc.," Word 0 Hi byte = 'M'(0x4D) Word 0 Lo byte = 'o' (0x6F) Word 1 Hi byte = 'x' (0x78) Word 1 Lo byte = 'a' (0x61) ... Word 10 Hi byte = 'c' Word 10 Lo byte = '.' Word 11 Hi byte = ',' Word 11 Lo byte = '\0' ... String ending next byte value is 0
34101	0x1004	20 word	Product name string=W5312 Cellular Micro RTU Controllers Word 0 Hi byte = 'W' (0x57) Word 0 Lo byte = '5' (0x35) Word 1 Hi byte = '3' (0x33) Word 1 Lo byte = '1' (0x34) ... Word 10 Hi byte = 'v' Word 10 Lo byte = 'e' Word 11 Hi byte = 'r' Word 11 Lo byte = '\0' ...
34102	0x1005	2 word	Product serial number (decimal)
34103	0x1006	2 word	Firmware revision: Word 0 Hi byte = major (A) Word 0 Lo byte = minor (B) Word 1 Hi byte = release (C) Word 1 Lo byte = build (D) format is A.B.C.D
34104	0x1007	2 word	Firmware release date Ex. High word = 0x2009 Low word = 0x1231 firmware release date is Dec. 31, 2009
34105	0x1008	1 word	Number of TCP connected
34106	0x1009	1 word	Ethernet Interface speed, 0x10(10Mbps) or 0x100(100Mbps)

Reference	Address	Data Type	Description
34107	0x100A	3 word	Ethernet physical address(MAC-ID) Word 0 Hi byte = 0 Word 0 Lo byte = 1 Word 1 Hi byte = 2 Word 1 Lo byte = 3 Word 2 Hi byte = 4 Word 2 Lo byte = 5 MAC-ID is 00-01-02-03-04-05
34111	0x100E	2 word (ULONG)	System Elapsed Time (in sec)
34113	0x1010	1 word	Click&Go Ready to Run Flag
34114	0x1011	16 word	Get DI channels that are locked by Click&Go
34115	0x1012	16 word	Get DO channels that are locked by Click&Go
34117	0x1014	2 word	Get Click&Go revision
34118	0x1015	2 word	Get MOS revision
34119	0x1016	1 word	Modbus/RTU Unit ID=1
34121	0x1018	1 word	MIB Date Value
34122	0x1019	1 word	GSM/Cellular signal strength value
34123	0x101A	2 word	Cellular IP
34125	0x101C	1 word	GSM/Cellular error message code
34126	0x101D	1 word	GSM/Cellular status

4xxxx Read/Write Registers (supports functions 3, 6, 16)

Reference	Address	Data Type	Description
40001	0x0000	1 word	CH0 DO Pulse Output Count Value Hi-Word
40002	0x0001	1 word	CH0 DO Pulse Output Count Value Lo-Word
40003	0x0002	1 word	CH1 DO Pulse Output Count Value Hi-Word
40004	0x0003	1 word	CH1 DO Pulse Output Count Value Lo- Word
40005	0x0004	1 word	CH2 DO Pulse Output Count Value Hi- Word
40006	0x0005	1 word	CH2 DO Pulse Output Count Value Lo- Word
40007	0x0006	1 word	CH3 DO Pulse Output Count Value Hi- Word
40008	0x0007	1 word	CH3 DO Pulse Output Count Value Lo- Word
40009	0x0008	1 word	CH4 DO Pulse Output Count Value Hi- Word
40010	0x0009	1 word	CH4 DO Pulse Output Count Value Lo- Word
40011	0x000A	1 word	CH5 DO Pulse Output Count Value Hi- Word
40012	0x000B	1 word	CH5 DO Pulse Output Count Value Lo- Word
40013	0x000C	1 word	CH6 DO Pulse Output Count Value Hi- Word
40014	0x000D	1 word	CH6 DO Pulse Output Count Value Lo- Word
40015	0x000E	1 word	CH7 DO Pulse Output Count Value Hi- Word
40016	0x000F	1 word	CH7 DO Pulse Output Count Value Lo- Word
40017	0x0010	1 word	CH8 DO Pulse Output Count Value Hi- Word (DIO)
40018	0x0011	1 word	CH8 DO Pulse Output Count Value Lo- Word
40019	0x0012	1 word	CH9 DO Pulse Output Count Value Hi- Word (DIO)
40020	0x0013	1 word	CH9 DO Pulse Output Count Value Lo- Word
40021	0x0014	1 word	CH10 DO Pulse Output Count Value Hi-Word (DIO)
40022	0x0015	1 word	CH10 DO Pulse Output Count Value Lo- Word
40023	0x0016	1 word	CH11 DO Pulse Output Count Value Hi-Word (DIO)
40024	0x0017	1 word	CH11 DO Pulse Output Count Value Lo- Word
40025	0x0018	1 word	CH0 DO Pulse Low Signal Width Hi- Word
40026	0x0019	1 word	CH0 DO Pulse Low Signal Width Lo- Word
40027	0x001A	1 word	CH1 DO Pulse Low Signal Width Hi- Word

Reference	Address	Data Type	Description
40028	0x001B	1 word	CH1 DO Pulse Low Signal Width Lo- Word
40029	0x001C	1 word	CH2 DO Pulse Low Signal Width Hi- Word
40030	0x001D	1 word	CH2 DO Pulse Low Signal Width Lo- Word
40031	0x001E	1 word	CH3 DO Pulse Low Signal Width Hi- Word
40032	0x001F	1 word	CH3 DO Pulse Low Signal Width Lo- Word
40033	0x0020	1 word	CH4 DO Pulse Low Signal Width Hi- Word
40034	0x0021	1 word	CH4 DO Pulse Low Signal Width Lo- Word
40035	0x0022	1 word	CH5 DO Pulse Low Signal Width Hi- Word
40036	0x0023	1 word	CH5 DO Pulse Low Signal Width Lo- Word
40037	0x0024	1 word	CH6 DO Pulse Low Signal Width Hi- Word
40038	0x0025	1 word	CH6 DO Pulse Low Signal Width Lo- Word
40039	0x0026	1 word	CH7 DO Pulse Low Signal Width Hi- Word
40040	0x0027	1 word	CH7 DO Pulse Low Signal Width Lo- Word
40041	0x0028	1 word	CH8 DO Pulse Low Signal Width Hi- Word (DIO)
40042	0x0029	1 word	CH8 DO Pulse Low Signal Width Lo- Word
40043	0x002A	1 word	CH9 DO Pulse Low Signal Width Hi- Word (DIO)
40044	0x002B	1 word	CH9 DO Pulse Low Signal Width Lo- Word
40045	0x002C	1 word	CH10 DO Pulse Low Signal Width Hi- Word (DIO)
40046	0x002D	1 word	CH10 DO Pulse Low Signal Width Lo- Word
40047	0x002E	1 word	CH11 DO Pulse Low Signal Width Hi- Word (DIO)
40048	0x002F	1 word	CH11 DO Pulse Low Signal Width Lo- Word
40049	0x0030	1 word	CH0 DO Pulse High Signal Width Hi- Word
40050	0x0031	1 word	CH0 DO Pulse High Signal Width Lo- Word
40051	0x0032	1 word	CH1 DO Pulse High Signal Width Hi- Word
40052	0x0033	1 word	CH1 DO Pulse High Signal Width Lo- Word
40053	0x0034	1 word	CH2 DO Pulse High Signal Width Hi- Word
40054	0x0035	1 word	CH2 DO Pulse High Signal Width Lo- Word
40055	0x0036	1 word	CH3 DO Pulse High Signal Width Hi- Word
40056	0x0037	1 word	CH3 DO Pulse High Signal Width Lo- Word
40057	0x0038	1 word	CH4 DO Pulse High Signal Width Hi- Word
40058	0x0039	1 word	CH4 DO Pulse High Signal Width Lo- Word
40059	0x003A	1 word	CH5 DO Pulse High Signal Width Hi- Word
40060	0x003B	1 word	CH5 DO Pulse High Signal Width Lo- Word
40061	0x003C	1 word	CH6 DO Pulse High Signal Width Hi- Word
40062	0x003D	1 word	CH6 DO Pulse High Signal Width Lo- Word
40063	0x003E	1 word	CH7 DO Pulse High Signal Width Hi- Word
40064	0x003F	1 word	CH7 DO Pulse High Signal Width Lo- Word
40065	0x0040	1 word	CH8 DO Pulse High Signal Width Hi- Word (DIO)
40066	0x0041	1 word	CH8 DO Pulse High Signal Width Lo- Word
40067	0x0042	1 word	CH9 DO Pulse High Signal Width Hi- Word (DIO)
40068	0x0043	1 word	CH9 DO Pulse High Signal Width Lo- Word
40069	0x0044	1 word	CH10 DO Pulse High Signal Width Hi- Word (DIO)
40070	0x0045	1 word	CH10 DO Pulse High Signal Width Lo- Word
40071	0x0046	1 word	CH11 DO Pulse High Signal Width Hi- Word (DIO)
40072	0x0047	1 word	CH11 DO Pulse High Signal Width Lo- Word
40073	0x0048	1 word	CH0 DO Mode 0: DO 1: Pulse
40074	0x0049	1 word	CH1 DO Mode 0: DO 1: Pulse
40075	0x004A	1 word	CH2 DO Mode 0: DO 1: Pulse

Reference	Address	Data Type	Description
40076	0x004B	1 word	CH3 DO Mode 0: DO 1: Pulse
40077	0x004C	1 word	CH4 DO Mode 0: DO 1: Pulse
40078	0x004D	1 word	CH5 DO Mode 0: DO 1: Pulse
40079	0x004E	1 word	CH6 DO Mode 0: DO 1: Pulse
40080	0x004F	1 word	CH7 DO Mode 0: DO 1: Pulse
40081	0x0050	1 word	CH8 DO Mode 0: DO (DIO) 1: Pulse
40082	0x0051	1 word	CH9 DO Mode 0: DO (DIO) 1: Pulse
40083	0x0052	1 word	CH10 DO Mode 0: DO (DIO) 1: Pulse
40084	0x0053	1 word	CH11 DO Mode 0: DO (DIO) 1: Pulse
40085	0x0054	1 word	CH0 DI Count Filter
40086	0x0055	1 word	CH1 DI Count Filter
40087	0x0056	1 word	CH2 DI Count Filter
40088	0x0057	1 word	CH3 DI Count Filter
40089	0x0058	1 word	CH4 DI Count Filter
40090	0x0059	1 word	CH5 DI Count Filter
40091	0x005A	1 word	CH6 DI Count Filter
40092	0x005B	1 word	CH7 DI Count Filter
40093	0x005C	1 word	CH8 DI Count Filter (DIO)
40094	0x005D	1 word	CH9 DI Count Filter (DIO)
40095	0x005E	1 word	CH10 DI Count Filter (DIO)
40096	0x005F	1 word	CH11 DI Count Filter (DIO)
40097	0x0060	1 word	CH0 DI Mode 0: DI 1: Count Others : return Illegal Data Value
40098	0x0061	1 word	CH1 DI Mode 0: DI 1: Count Others : return Illegal Data Value
40099	0x0062	1 word	CH2 DI Mode 0: DI 1: Count Others : return Illegal Data Value
40100	0x0063	1 word	CH3 DI Mode 0: DI 1: Count Others : return Illegal Data Value
40101	0x0064	1 word	CH4 DI Mode 0: DI 1: Count Others : return Illegal Data Value

Reference	Address	Data Type	Description
40102	0x0065	1 word	CH5 DI Mode 0: DI 1: Count Others : return Illegal Data Value
40103	0x0066	1 word	CH6 DI Mode 0: DI 1: Count Others : return Illegal Data Value
40104	0x0067	1 word	CH7 DI Mode 0: DI 1: Count Others : return Illegal Data Value
40105	0x0068	1 word	CH8 DI Mode (DIO) 0: DI 1: Count Others : return Illegal Data Value
40106	0x0069	1 word	CH9 DI Mode (DIO) 0: DI 1: Count Others : return Illegal Data Value
40107	0x006A	1 word	CH10 DI Mode (DIO) 0: DI 1: Count Others : return Illegal Data Value
40108	0x006B	1 word	CH11 DI Mode (DIO) 0: DI 1: Count Others : return Illegal Data Value
For SCADA			
40129	0x0080	1 word	CH0 DO set/get wordvalue
40130	0x0081	1 word	CH1 DO set/get wordvalue
40131	0x0082	1 word	CH2 DO set/get wordvalue
40132	0x0083	1 word	CH3 DO set/get wordvalue
40133	0x0084	1 word	CH4 DO set/get wordvalue
40134	0x0085	1 word	CH5 DO set/get wordvalue
40135	0x0086	1 word	CH6 DO set/get wordvalue
40136	0x0087	1 word	CH7 DO set/get wordvalue
40137	0x0088	1 word	CH8 DO set/get wordvalue (DIO)
40138	0x0089	1 word	CH9 DO set/get wordvalue (DIO)
40139	0x008A	1 word	CH10 DO set/get wordvalue (DIO)
40140	0x008B	1 word	CH11 DO set/get wordvalue (DIO)
40141	0x008C	1 word	CH0 DO set/get poweron wordvalue
40142	0x008D	1 word	CH1 DO set/get poweron wordvalue
40143	0x008E	1 word	CH2 DO set/get poweron wordvalue
40144	0x008F	1 word	CH3 DO set/get poweron wordvalue
40145	0x0090	1 word	CH4 DO set/get poweron wordvalue
40146	0x0091	1 word	CH5 DO set/get poweron wordvalue
40147	0x0092	1 word	CH6 DO set/get poweron wordvalue
40148	0x0093	1 word	CH7 DO set/get poweron wordvalue
40149	0x0094	1 word	CH8 DO set/get poweron wordvalue (DIO)
40150	0x0095	1 word	CH9 DO set/get poweron wordvalue (DIO)
40151	0x0096	1 word	CH10 DO set/get poweron wordvalue (DIO)

Reference	Address	Data Type	Description
40152	0x0097	1 word	CH11 DO set/get poweron wordvalue (DIO)
40153	0x0098	1 word	CH0 DO set/get safe mode wordvalue 0: Off 1: On
40154	0x0099	1 word	CH1 DO set/get safe mode wordvalue 0: Off 1: On
40155	0x009A	1 word	CH2 DO set/get safe mode wordvalue 0: Off 1: On
40156	0x009B	1 word	CH3 DO set/get safe mode wordvalue 0: Off 1: On
40157	0x009C	1 word	CH4 DO set/get safe mode wordvalue 0: Off 1: On
40158	0x009D	1 word	CH5 DO set/get safe mode wordvalue 0: Off 1: On
40159	0x009E	1 word	CH6 DO set/get safe mode wordvalue 0: Off 1: On
40160	0x009F	1 word	CH7 DO set/get safe mode wordvalue 0: Off 1: On
40161	0x00A0	1 word	CH8 DO set/get safe mode wordvalue (DIO) 0: Off 1: On
40162	0x00A1	1 word	CH9 DO set/get safe mode wordvalue (DIO) 0: Off 1: On
40163	0x00A2	1 word	CH10 DO set/get safe mode wordvalue (DIO) 0: Off 1: On
40164	0x00A3	1 word	CH11 DO set/get safe mode wordvalue (DIO) 0: Off 1: On
40165	0x00A4	1 word	CH0 DO set/get pwm start wordvalue (Pulse Operate Status) 0: Stop 1: Start
40166	0x00A5	1 word	CH1 DO set/get pwm start wordvalue
40167	0x00A6	1 word	CH2 DO set/get pwm start wordvalue
40168	0x00A7	1 word	CH3 DO set/get pwm start wordvalue
40169	0x00A8	1 word	CH4 DO set/get pwm start wordvalue
40170	0x00A9	1 word	CH5 DO set/get pwm start wordvalue
40171	0x00AA	1 word	CH6 DO set/get pwm start wordvalue
40172	0x00AB	1 word	CH7 DO set/get pwm start wordvalue
40173	0x00AC	1 word	CH8 DO set/get pwm start wordvalue (DIO)
40174	0x00AD	1 word	CH9 DO set/get pwm start wordvalue (DIO)
40175	0x00AE	1 word	CH10 DO set/get pwm start wordvalue (DIO)
40176	0x00AF	1 word	CH11 DO set/get pwm start wordvalue (DIO)
40177	0x00B0	1 word	CH0 DO set/get pwm poweron wordvalue 0: Stop 1: Start
40178	0x00B1	1 word	CH1 DO set/get pwm poweron wordvalue
40179	0x00B2	1 word	CH2 DO set/get pwm poweron wordvalue
40180	0x00B3	1 word	CH3 DO set/get pwm poweron wordvalue
40181	0x00B4	1 word	CH4 DO set/get pwm poweron wordvalue
40182	0x00B5	1 word	CH5 DO set/get pwm poweron wordvalue
40183	0x00B6	1 word	CH6 DO set/get pwm poweron wordvalue
40184	0x00B7	1 word	CH7 DO set/get pwm poweron wordvalue
40185	0x00B8	1 word	CH8 DO set/get pwm poweron wordvalue (DIO)
40186	0x00B9	1 word	CH9 DO set/get pwm poweron wordvalue (DIO)
40187	0x00BA	1 word	CH10 DO set/get pwm poweron wordvalue (DIO)
40188	0x00BB	1 word	CH11 DO set/get pwm poweron wordvalue (DIO)

Reference	Address	Data Type	Description
40189	0x00BC	1 word	CH0 DO set/get pwm safe mode wordvalue Safe Mode Pulse Operate Status 0: Stop 1: Start
40190	0x00BD	1 word	CH1 DO set/get pwm safe mode wordvalue
40191	0x00BE	1 word	CH2 DO set/get pwm safe mode wordvalue
40192	0x00BF	1 word	CH3 DO set/get pwm safe mode wordvalue
40193	0x00C0	1 word	CH4 DO set/get pwm safe mode wordvalue
40194	0x00C1	1 word	CH5 DO set/get pwm safe mode wordvalue
40195	0x00C2	1 word	CH6 DO set/get pwm safe mode wordvalue
40196	0x00C3	1 word	CH7 DO set/get pwm safe mode wordvalue
40197	0x00C4	1 word	CH8 DO set/get pwm safe mode wordvalue (DIO)
40198	0x00C5	1 word	CH9 DO set/get pwm safe mode wordvalue (DIO)
40199	0x00C6	1 word	CH10 DO set/get pwm safe mode wordvalue (DIO)
40200	0x00C7	1 word	CH11 DO set/get pwm safe mode wordvalue (DIO)
40201	0x00C8	1 word	CH0 DI set/get counter start word Counter Operate Status 0: Stop 1: Start
40202	0x00C9	1 word	CH1 DI set/get counter start word
40203	0x00CA	1 word	CH2 DI set/get counter start word
40204	0x00CB	1 word	CH3 DI set/get counter start word
40205	0x00CC	1 word	CH4 DI set/get counter start word
40206	0x00CD	1 word	CH5 DI set/get counter start word
40207	0x00CE	1 word	CH6 DI set/get counter start word
40208	0x00CF	1 word	CH7 DI set/get counter start word
40209	0x00D0	1 word	CH8 DI set/get counter start word (DIO)
40210	0x00D1	1 word	CH9 DI set/get counter start word (DIO)
40211	0x00D2	1 word	CH10 DI set/get counter start word (DIO)
40212	0x00D3	1 word	CH11 DI set/get counter start word (DIO)
40213	0x00D4	1 word	CH0 DI set/get counter clear word Read: always return: 0 Write: 1 : Clear counter value 0 : Return illegal data value(0x03)
40214	0x00D5	1 word	CH1 DI set/get counter clear word
40215	0x00D6	1 word	CH2 DI set/get counter clear word
40216	0x00D7	1 word	CH3 DI set/get counter clear word
40217	0x00D8	1 word	CH4 DI set/get counter clear word
40218	0x00D9	1 word	CH5 DI set/get counter clear word
40219	0x00DA	1 word	CH6 DI set/get counter clear word
40220	0x00DB	1 word	CH7 DI set/get counter clear word
40221	0x00DC	1 word	CH8 DI set/get counter clear word (DIO)
40222	0x00DD	1 word	CH9 DI set/get counter clear word (DIO)
40223	0x00DE	1 word	CH10 DI set/get counter clear word (DIO)
40224	0x00DF	1 word	CH11 DI set/get counter clear word (DIO)
40225	0x00E0	1 word	CH0 DI clear/get overflow word Read : 0 : Normal 1 : Overflow Write : 0 : Clear overflow status 1 : Return illegal data value (0x03)
40226	0x00E1	1 word	CH1 DI clear/get overflow word
40227	0x00E2	1 word	CH2 DI clear/get overflow word
40228	0x00E3	1 word	CH3 DI clear/get overflow word
40229	0x00E4	1 word	CH4 DI clear/get overflow word
40230	0x00E5	1 word	CH5 DI clear/get overflow word
40231	0x00E6	1 word	CH6 DI clear/get overflow word

Reference	Address	Data Type	Description
40232	0x00E7	1 word	CH7 DI clear/get overflow word
40233	0x00E8	1 word	CH8 DI clear/get overflow word (DIO)
40234	0x00E9	1 word	CH9 DI clear/get overflow word (DIO)
40235	0x00EA	1 word	CH10 DI clear/get overflow word (DIO)
40236	0x00EB	1 word	CH11 DI clear/get overflow word (DIO)
40237	0x00EC	1 word	CH0 DI set/get trigger word 0=Low to High, 1=High to Low
40238	0x00ED	1 word	CH1 DI set/get trigger word
40239	0x00EE	1 word	CH2 DI set/get trigger word
40240	0x00EF	1 word	CH3 DI set/get trigger word
40241	0x00F0	1 word	CH4 DI set/get trigger word
40242	0x00F1	1 word	CH5 DI set/get trigger word
40243	0x00F2	1 word	CH6 DI set/get trigger word
40244	0x00F3	1 word	CH7 DI set/get trigger word
40245	0x00F4	1 word	CH8 DI set/get trigger word (DIO)
40246	0x00F5	1 word	CH9 DI set/get trigger word (DIO)
40247	0x00F6	1 word	CH10 DI set/get trigger word (DIO)
40248	0x00F7	1 word	CH11 DI set/get trigger word (DIO)
40249	0x00F8	1 word	CH0 DI set/get power on start word (PowerOn Counter Operate Status) 0: Stop 1: Start
40250	0x00F9	1 word	CH1 DI set/get power on start word
40251	0x00FA	1 word	CH2 DI set/get power on start word
40252	0x00FB	1 word	CH3 DI set/get power on start word
40253	0x00FC	1 word	CH4 DI set/get power on start word
40254	0x00FD	1 word	CH5 DI set/get power on start word
40255	0x00FE	1 word	CH6 DI set/get power on start word
40256	0x00FF	1 word	CH7 DI set/get power on start word
40257	0x0100	1 word	CH8 DI set/get power on start word (DIO)
40258	0x0101	1 word	CH9 DI set/get power on start word (DIO)
40259	0x0102	1 word	CH10 DI set/get power on start word (DIO)
40260	0x0103	1 word	CH11 DI set/get power on start word (DIO)
40261	0x0104	1 word	CH0 DI set/get safe start word (Safe Mode Counter Operate Status) 0: Stop 1: Start
40262	0x0105	1 word	CH1 DI set/get safe start word
40263	0x0106	1 word	CH2 DI set/get safe start word
40264	0x0107	1 word	CH3 DI set/get safe start word
40265	0x0108	1 word	CH4 DI set/get safe start word
40266	0x0109	1 word	CH5 DI set/get safe start word
40267	0x010A	1 word	CH6 DI set/get safe start word
40268	0x010B	1 word	CH7 DI set/get safe start word
40269	0x010C	1 word	CH8 DI set/get safe start word (DIO)
40270	0x010D	1 word	CH9 DI set/get safe start word (DIO)
40271	0x010E	1 word	CH10 DI set/get safe start word (DIO)
40272	0x010F	1 word	CH11 DI set/get safe start word (DIO)
40273	0x0110	1 word	CH0 Power-off storage enable (DI count value recorded when power-off) 1:ON 0:OFF
40274	0x0111	1 word	CH1 Power-off storage enable
40275	0x0112	1 word	CH2 Power-off storage enable
40276	0x0113	1 word	CH3 Power-off storage enable

Reference	Address	Data Type	Description
40277	0x0114	1 word	CH4 Power-off storage enable
40278	0x0115	1 word	CH5 Power-off storage enable
40279	0x0116	1 word	CH6 Power-off storage enable
40280	0x0117	1 word	CH7 Power-off storage enable
40281	0x0118	1 word	CH8 Power-off storage enable (DIO)
40282	0x0119	1 word	CH9 Power-off storage enable (DIO)
40283	0x011A	1 word	CH10 Power-off storage enable (DIO)
40284	0x011B	1 word	CH11 Power-off storage enable (DIO)
40337	0x0150	1 word	Internal Register 00 Initial Value
40338	0x0151	1 word	Internal Register 01 Initial Value
40339	0x0152	1 word	Internal Register 02 Initial Value
40340	0x0153	1 word	Internal Register 03 Initial Value
40341	0x0154	1 word	Internal Register 04 Initial Value
40342	0x0155	1 word	Internal Register 05 Initial Value
40343	0x0156	1 word	Internal Register 06 Initial Value
40344	0x0157	1 word	Internal Register 07 Initial Value
40345	0x0158	1 word	Internal Register 08 Initial Value
40346	0x0159	1 word	Internal Register 09 Initial Value
40347	0x015A	1 word	Internal Register 10 Initial Value
40348	0x015B	1 word	Internal Register 11 Initial Value
40349	0x015C	1 word	Internal Register 12 Initial Value
40350	0x015D	1 word	Internal Register 13 Initial Value
40351	0x015E	1 word	Internal Register 14 Initial Value
40352	0x015F	1 word	Internal Register 15 Initial Value
40353	0x0160	1 word	Internal Register 16 Initial Value
40354	0x0161	1 word	Internal Register 17 Initial Value
40355	0x0162	1 word	Internal Register 18 Initial Value
40356	0x0163	1 word	Internal Register 19 Initial Value
40357	0x0164	1 word	Internal Register 20 Initial Value
40358	0x0165	1 word	Internal Register 21 Initial Value
40359	0x0166	1 word	Internal Register 22 Initial Value
40360	0x0167	1 word	Internal Register 23 Initial Value
40361	0x0168	2 word	Time Init 00 Value
40362	0x0169	2 word	Time Init 01 Value
40363	0x016A	2 word	Time Init 02 Value
40364	0x016B	2 word	Time Init 03 Value
40365	0x016C	2 word	Time Init 04 Value
40366	0x016D	2 word	Time Init 05 Value
40367	0x016E	2 word	Time Init 06 Value
40368	0x016F	2 word	Time Init 07 Value
40369	0x0170	2 word	Time Init 08 Value
40370	0x0171	2 word	Time Init 09 Value
40371	0x0172	2 word	Time Init 10 Value
40372	0x0173	2 word	Time Init 11 Value
40373	0x0174	2 word	Time Init 12 Value
40374	0x0175	2 word	Time Init 13 Value
40375	0x0176	2 word	Time Init 14 Value
40376	0x0177	2 word	Time Init 15 Value
40377	0x0178	2 word	Time Init 16 Value
40378	0x0179	2 word	Time Init 17 Value
40379	0x017A	2 word	Time Init 18 Value
40380	0x017B	2 word	Time Init 19 Value

Reference	Address	Data Type	Description
40381	0x017C	2 word	Time Init 20 Value
40382	0x017D	2 word	Time Init 21 Value
40383	0x017E	2 word	Time Init 22 Value
40384	0x017F	2 word	Time Init 23 Value
40385	0x0180	1 word	Timer Interval 00 Value
40386	0x0181	1 word	Timer Interval 01 Value
40387	0x0182	1 word	Timer Interval 02 Value
40388	0x0183	1 word	Timer Interval 03 Value
40389	0x0184	1 word	Timer Interval 04 Value
40390	0x0185	1 word	Timer Interval 05 Value
40391	0x0186	1 word	Timer Interval 06 Value
40392	0x0187	1 word	Timer Interval 07 Value
40393	0x0188	1 word	Timer Interval 08 Value
40394	0x0189	1 word	Timer Interval 09 Value
40395	0x018A	1 word	Timer Interval 10 Value
40396	0x018B	1 word	Timer Interval 11 Value
40397	0x018C	1 word	Timer Interval 12 Value
40398	0x018D	1 word	Timer Interval 13 Value
40399	0x018E	1 word	Timer Interval 14 Value
40400	0x018F	1 word	Timer Interval 15 Value
40401	0x0190	1 word	Timer Interval 16 Value
40402	0x0191	1 word	Timer Interval 17 Value
40403	0x0192	1 word	Timer Interval 18 Value
40404	0x0193	1 word	Timer Interval 19 Value
40405	0x0194	1 word	Timer Interval 20 Value
40406	0x0195	1 word	Timer Interval 21 Value
40407	0x0196	1 word	Timer Interval 22 Value
40408	0x0197	2 word	Timer Interval 23 Value
40409	0x0198	10 word	Timer Description 00 Value
40410	0x0199	10 word	Timer Description 01 Value
40411	0x019A	10 word	Timer Description 02 Value
40412	0x019B	10 word	Timer Description 03 Value
40413	0x019C	10 word	Timer Description 04 Value
40414	0x019D	10 word	Timer Description 05 Value
40415	0x019E	10 word	Timer Description 06 Value
40416	0x019F	10 word	Timer Description 07 Value
40417	0x01A0	10 word	Timer Description 08 Value
40418	0x01A1	10 word	Timer Description 09 Value
40419	0x01A2	10 word	Timer Description 10 Value
40420	0x01A3	10 word	Timer Description 11 Value
40421	0x01A4	10 word	Timer Description 12 Value
40422	0x01A5	10 word	Timer Description 13 Value
40423	0x01A6	10 word	Timer Description 14 Value
40424	0x01A7	10 word	Timer Description 15 Value
40425	0x01A8	10 word	Timer Description 16 Value
40426	0x01A9	10 word	Timer Description 17 Value
40427	0x01AA	10 word	Timer Description 18 Value
40428	0x01AB	10 word	Timer Description 19 Value
40429	0x01AC	10 word	Timer Description 20 Value
40430	0x01AD	10 word	Timer Description 21 Value
40431	0x01AE	10 word	Timer Description 22 Value
40432	0x01AF	10 word	Timer Description 23 Value

Reference	Address	Data Type	Description
40433	0x01B0	10 word	Internal Register Description 00 Value
40434	0x01B1	10 word	Internal Register Description 01 Value
40435	0x01B2	10 word	Internal Register Description 02 Value
40436	0x01B3	10 word	Internal Register Description 03 Value
40437	0x01B4	10 word	Internal Register Description 04 Value
40438	0x01B5	10 word	Internal Register Description 05 Value
40439	0x01B6	10 word	Internal Register Description 06 Value
40440	0x01B7	10 word	Internal Register Description 07 Value
40441	0x01B8	10 word	Internal Register Description 08 Value
40442	0x01B9	10 word	Internal Register Description 09 Value
40443	0x01BA	10 word	Internal Register Description 10 Value
40444	0x01BB	10 word	Internal Register Description 11 Value
40445	0x01BC	10 word	Internal Register Description 12 Value
40446	0x01BD	10 word	Internal Register Description 13 Value
40447	0x01BE	10 word	Internal Register Description 14 Value
40418	0x01BF	10 word	Internal Register Description 15 Value
40419	0x01C0	10 word	Internal Register Description 16 Value
40420	0x01C1	10 word	Internal Register Description 17 Value
40421	0x01C2	10 word	Internal Register Description 18 Value
40422	0x01C3	10 word	Internal Register Description 19 Value
40423	0x01C4	10 word	Internal Register Description 20 Value
40424	0x01C5	10 word	Internal Register Description 21 Value
40425	0x01C6	10 word	Internal Register Description 22 Value
40426	0x01C7	10 word	Internal Register Description 23 Value
40427	0x01C8	1 word	Message Retry Times
40428	0x01C9	1 word	Message Retry Interval
40429	0x01CA	1 word	Mail Retry Times
40430	0x01CB	1 word	Mail Retry Interval
40431	0x01CC	1 word	SMS Retry Times
40432	0x01CD	1 word	SMS Retry Interval
40577	0x0240	20 word	Message Server Address 00
40578	0x0241	20 word	Message Server Address 01
40579	0x0242	20 word	Message Server Address 02
40580	0x0243	20 word	Message Server Address 03
40581	0x0244	20 word	Message Server Address 04
40582	0x0245	20 word	Message Server Address 05
40583	0x0246	20 word	Message Server Address 06
40584	0x0247	20 word	Message Server Address 07
40585	0x0248	20 word	Message Server Address 08
40586	0x0249	20 word	Message Server Address 09
Internal Register(Integer)			
412840	0x3227	Word	Internal Registers 00 Working Value
412841	0x3228	Word	Internal Registers 01 Working Value
412842	0x3229	Word	Internal Registers 02 Working Value
412843	0x322A	Word	Internal Registers 03 Working Value
412844	0x322B	Word	Internal Registers 04 Working Value
412845	0x322C	Word	Internal Registers 05 Working Value
412846	0x322D	Word	Internal Registers 06 Working Value
412847	0x322E	Word	Internal Registers 07 Working Value
412848	0x322F	Word	Internal Registers 08 Working Value
412849	0x3230	Word	Internal Registers 09 Working Value
412850	0x3231	Word	Internal Registers 10 Working Value

Reference	Address	Data Type	Description
412851	0x3232	Word	Internal Registers 11 Working Value
412852	0x3233	Word	Internal Registers 12 Working Value
412853	0x3234	Word	Internal Registers 13 Working Value
412854	0x3235	Word	Internal Registers 14 Working Value
412855	0x3236	Word	Internal Registers 15 Working Value
412856	0x3237	Word	Internal Registers 16 Working Value
412857	0x3238	Word	Internal Registers 17 Working Value
412858	0x3239	Word	Internal Registers 18 Working Value
412859	0x323A	Word	Internal Registers 19 Working Value
412860	0x323B	Word	Internal Registers 20 Working Value
412861	0x323C	Word	Internal Registers 21 Working Value
412862	0x323D	Word	Internal Registers 22 Working Value
412863	0x323E	Word	Internal Registers 23 Working Value
Internal Register (Float)			
419413	0x4BD4	word	Internal Register (Float) 00 Initial Value Hi-Word
419414	0x4BD5	word	Internal Register (Float) 00 Initial Value Lo-Word
419415	0x4BD6	word	Internal Register (Float) 01 Initial Value Hi-Word
419416	0x4BD7	word	Internal Register (Float) 01 Initial Value Lo-Word
419417	0x4BD8	word	Internal Register (Float) 02 Initial Value Hi-Word
419418	0x4BD9	word	Internal Register (Float) 02 Initial Value Lo-Word
419419	0x4BDA	word	Internal Register (Float) 03 Initial Value Hi-Word
419420	0x4BDB	word	Internal Register (Float) 03 Initial Value Lo-Word
419421	0x4BDC	word	Internal Register (Float) 04 Initial Value Hi-Word
419422	0x4BDD	word	Internal Register (Float) 04 Initial Value Lo-Word
419423	0x4BDE	word	Internal Register (Float) 05 Initial Value Hi-Word
419424	0x4BDF	word	Internal Register (Float) 05 Initial Value Lo-Word
419425	0x4BE0	word	Internal Register (Float) 06 Initial Value Hi-Word
419426	0x4BE1	word	Internal Register (Float) 06 Initial Value Lo-Word
419427	0x4BE2	word	Internal Register (Float) 07 Initial Value Hi-Word
419428	0x4BE3	word	Internal Register (Float) 07 Initial Value Lo-Word
419429	0x4BE4	word	Internal Register (Float) 08 Initial Value Hi-Word
419430	0x4BE5	word	Internal Register (Float) 08 Initial Value Lo-Word
419431	0x4BE6	word	Internal Register (Float) 09 Initial Value Hi-Word
419432	0x4BE7	word	Internal Register (Float) 09 Initial Value Lo-Word
419433	0x4BE8	word	Internal Register (Float) 10 Initial Value Hi-Word
419434	0x4BE9	word	Internal Register (Float) 10 Initial Value Lo-Word
419435	0x4BEA	word	Internal Register (Float) 11 Initial Value Hi-Word
419436	0x4BEB	word	Internal Register (Float) 11 Initial Value Lo-Word
419437	0x4BEC	word	Internal Register (Float) 12 Initial Value Hi-Word
419438	0x4BED	word	Internal Register (Float) 12 Initial Value Lo-Word
419439	0x4BEE	word	Internal Register (Float) 13 Initial Value Hi-Word
419440	0x4BEF	word	Internal Register (Float) 13 Initial Value Lo-Word
419441	0x4BF0	word	Internal Register (Float) 14 Initial Value Hi-Word
419442	0x4BF1	word	Internal Register (Float) 14 Initial Value Lo-Word
419443	0x4BF2	word	Internal Register (Float) 15 Initial Value Hi-Word
419444	0x4BF3	word	Internal Register (Float) 15 Initial Value Lo-Word
419445	0x4BF4	word	Internal Register (Float) 16 Initial Value Hi-Word
419446	0x4BF5	word	Internal Register (Float) 16 Initial Value Lo-Word
419447	0x4BF6	word	Internal Register (Float) 17 Initial Value Hi-Word
419448	0x4BF7	word	Internal Register (Float) 17 Initial Value Lo-Word
419449	0x4BF8	word	Internal Register (Float) 18 Initial Value Hi-Word
419450	0x4BF9	word	Internal Register (Float) 18 Initial Value Lo-Word

Reference	Address	Data Type	Description
419451	0x4BFA	word	Internal Register (Float) 19 Initial Value Hi-Word
419452	0x4BFB	word	Internal Register (Float) 19 Initial Value Lo-Word
419453	0x4BFC	word	Internal Register (Float) 20 Initial Value Hi-Word
419454	0x4BFD	word	Internal Register (Float) 20 Initial Value Lo-Word
419455	0x4BFE	word	Internal Register (Float) 21 Initial Value Hi-Word
419456	0x4BFF	word	Internal Register (Float) 21 Initial Value Lo-Word
419457	0x4C00	word	Internal Register (Float) 22 Initial Value Hi-Word
419458	0x4C01	word	Internal Register (Float) 22 Initial Value Lo-Word
419459	0x4C02	word	Internal Register (Float) 23 Initial Value Hi-Word
419460	0x4C03	word	Internal Register (Float) 23 Initial Value Lo-Word
419461	0x4C04	word	Internal Register (Float) 24 Initial Value Hi-Word
419462	0x4C05	word	Internal Register (Float) 24 Initial Value Lo-Word
419463	0x4C06	word	Internal Register (Float) 25 Initial Value Hi-Word
419464	0x4C07	word	Internal Register (Float) 25 Initial Value Lo-Word
419465	0x4C08	word	Internal Register (Float) 26 Initial Value Hi-Word
419466	0x4C09	word	Internal Register (Float) 26 Initial Value Lo-Word
419467	0x4C0A	word	Internal Register (Float) 27 Initial Value Hi-Word
419468	0x4C0B	word	Internal Register (Float) 27 Initial Value Lo-Word
419469	0x4C0C	word	Internal Register (Float) 00 Working Value Hi-Word
419470	0x4C0D	word	Internal Register (Float) 00 Working Value Lo-Word
419471	0x4C0E	word	Internal Register (Float) 01 Working Value Hi-Word
419472	0x4C0F	word	Internal Register (Float) 01 Working Value Lo-Word
419473	0x4C10	word	Internal Register (Float) 02 Working Value Hi-Word
419474	0x4C11	word	Internal Register (Float) 02 Working Value Lo-Word
419475	0x4C12	word	Internal Register (Float) 03 Working Value Hi-Word
419476	0x4C13	word	Internal Register (Float) 03 Working Value Lo-Word
419477	0x4C14	word	Internal Register (Float) 04 Working Value Hi-Word
419478	0x4C15	word	Internal Register (Float) 04 Working Value Lo-Word
419479	0x4C16	word	Internal Register (Float) 05 Working Value Hi-Word
419480	0x4C17	word	Internal Register (Float) 05 Working Value Lo-Word
419481	0x4C18	word	Internal Register (Float) 06 Working Value Hi-Word
419482	0x4C19	word	Internal Register (Float) 06 Working Value Lo-Word
419483	0x4C1A	word	Internal Register (Float) 07 Working Value Hi-Word
419484	0x4C1B	word	Internal Register (Float) 07 Working Value Lo-Word
419485	0x4C1C	word	Internal Register (Float) 08 Working Value Hi-Word
419486	0x4C1D	word	Internal Register (Float) 08 Working Value Lo-Word
419487	0x4C1E	word	Internal Register (Float) 09 Working Value Hi-Word
419488	0x4C1F	word	Internal Register (Float) 09 Working Value Lo-Word
419489	0x4C20	word	Internal Register (Float) 10 Working Value Hi-Word
419490	0x4C21	word	Internal Register (Float) 10 Working Value Lo-Word
419491	0x4C22	word	Internal Register (Float) 11 Working Value Hi-Word
419492	0x4C23	word	Internal Register (Float) 11 Working Value Lo-Word
419493	0x4C24	word	Internal Register (Float) 12 Working Value Hi-Word
419494	0x4C25	word	Internal Register (Float) 12 Working Value Lo-Word
419495	0x4C26	word	Internal Register (Float) 13 Working Value Hi-Word
419496	0x4C27	word	Internal Register (Float) 13 Working Value Lo-Word
419497	0x4C28	word	Internal Register (Float) 14 Working Value Hi-Word
419498	0x4C29	word	Internal Register (Float) 14 Working Value Lo-Word
419499	0x4C2A	word	Internal Register (Float) 15 Working Value Hi-Word
419500	0x4C2B	word	Internal Register (Float) 15 Working Value Lo-Word
419501	0x4C2C	word	Internal Register (Float) 16 Working Value Hi-Word
419502	0x4C2D	word	Internal Register (Float) 16 Working Value Lo-Word

Reference	Address	Data Type	Description
419503	0x4C2E	word	Internal Register (Float) 17 Working Value Hi-Word
419504	0x4C2F	word	Internal Register (Float) 17 Working Value Lo-Word
419505	0x4C30	word	Internal Register (Float) 18 Working Value Hi-Word
419506	0x4C31	word	Internal Register (Float) 18 Working Value Lo-Word
419507	0x4C32	word	Internal Register (Float) 19 Working Value Hi-Word
419508	0x4C33	word	Internal Register (Float) 19 Working Value Lo-Word
419509	0x4C34	word	Internal Register (Float) 20 Working Value Hi-Word
419510	0x4C35	word	Internal Register (Float) 20 Working Value Lo-Word
419511	0x4C36	word	Internal Register (Float) 21 Working Value Hi-Word
419512	0x4C37	word	Internal Register (Float) 21 Working Value Lo-Word
419513	0x4C38	word	Internal Register (Float) 22 Working Value Hi-Word
419514	0x4C39	word	Internal Register (Float) 22 Working Value Lo-Word
419515	0x4C3A	word	Internal Register (Float) 23 Working Value Hi-Word
419516	0x4C3B	word	Internal Register (Float) 23 Working Value Lo-Word
419517	0x4C3C	word	Internal Register (Float) 24 Working Value Hi-Word
419518	0x4C3D	word	Internal Register (Float) 24 Working Value Lo-Word
419519	0x4C3E	word	Internal Register (Float) 25 Working Value Hi-Word
419520	0x4C3F	word	Internal Register (Float) 25 Working Value Lo-Word
419521	0x4C40	word	Internal Register (Float) 26 Working Value Hi-Word
419522	0x4C41	word	Internal Register (Float) 26 Working Value Lo-Word
419523	0x4C42	word	Internal Register (Float) 27 Working Value Hi-Word
419524	0x4C43	word	Internal Register (Float) 27 Working Value Lo-Word
419525	0x4C44	10 word	Internal Register (Float) 00 Description
419526	0x4C45	10 word	Internal Register (Float) 01 Description
419527	0x4C46	10 word	Internal Register (Float) 02 Description
419528	0x4C47	10 word	Internal Register (Float) 03 Description
419529	0x4C48	10 word	Internal Register (Float) 04 Description
419530	0x4C49	10 word	Internal Register (Float) 05 Description
419531	0x4C4A	10 word	Internal Register (Float) 06 Description
419532	0x4C4B	10 word	Internal Register (Float) 07 Description
419533	0x4C4C	10 word	Internal Register (Float) 08 Description
419534	0x4C4D	10 word	Internal Register (Float) 09 Description
419535	0x4C4E	10 word	Internal Register (Float) 10 Description
419536	0x4C4F	10 word	Internal Register (Float) 11 Description
419537	0x4C50	10 word	Internal Register (Float) 12 Description
419538	0x4C51	10 word	Internal Register (Float) 13 Description
419539	0x4C52	10 word	Internal Register (Float) 14 Description
419540	0x4C53	10 word	Internal Register (Float) 15 Description
419541	0x4C54	10 word	Internal Register (Float) 16 Description
419542	0x4C55	10 word	Internal Register (Float) 17 Description
419543	0x4C56	10 word	Internal Register (Float) 18 Description
419544	0x4C57	10 word	Internal Register (Float) 19 Description
419545	0x4C58	10 word	Internal Register (Float) 20 Description
419546	0x4C59	10 word	Internal Register (Float) 21 Description
419547	0x4C5A	10 word	Internal Register (Float) 22 Description
419548	0x4C5B	10 word	Internal Register (Float) 23 Description
419549	0x4C5C	10 word	Internal Register (Float) 24 Description
419550	0x4C5D	10 word	Internal Register (Float) 25 Description
419551	0x4C5E	10 word	Internal Register (Float) 26 Description
419552	0x4C5F	10 word	Internal Register (Float) 27 Description

5xxxx Write Registers (supports function 8)

Sub-function	Data Field (Request)	Data Field (Response)	Description
0x0001	0xFF00	Echo Request Data	Reboot
0x0001	0x55AA	Echo Request Data	Reset with Factory default

D

SNMP Agents with MIB II, RS-232-like Groups

The ioLogik W5300 has SNMP (Simple Network Management Protocol) agent software built in. The software supports SNMP traps, RFC1317 RS-232-like groups, and RFC 1213 MIB-II. The following table lists the standard MIB-II groups, as well as the variable implementation for the ioLogik W5300.

RFC1213 MIB II Supported SNMP Variables

System MIB	Interfaces MIB	IP MIB	ICMP MIB
SysDescr	ifNumber	ipForwarding	IcmpInMsgs
SysObjectID	ifIndex	ipDefaultTTL	IcmpInErrors
SysUpTime	ifDescr	ipInreceives	IcmpInDestUnreachs
SysContact	ifType	ipInHdrErrors	IcmpInTimeExcds
SysName	ifMtu	ipInAddrErrors	IcmpInParmProbs
SysLocation	ifSpeed	ipForwDatagrams	IcmpInSrcQuenchs
SysServices	ifPhysAddress	ipInUnknownProtos	IcmpInRedirects
SysServices	ifAdminStatus	ipInDiscards	IcmpInEchos
	ifOperStatus	ipInDelivers	IcmpInEchoReps
	ifLastChange	ipOutRequests	IcmpInTimestamps
	ifInOctets	ipOutDiscards	IcmpTimestampReps
	ifInUcastPkts	ipOutNoRoutes	IcmpInAddrMasks
	ifInNUcastPkts	ipReasmTimeout	IcmpOutMsgs
	ifInDiscards	ipReasmReqds	IcmpOutErrors
	ifInErrors	ipReasmOKs	IcmpOutDestUnreachs

Interfaces MIB	IP MIB	ICMP MIB
ifInUnknownProtos	ipReasmFails	IcmpOutTimeExcds
ifOutOctets	ipFragOKs	IcmpOutParmProbs
ifOutUcastPkts	ipFragFails	IcmpOutSrcQuenchs
ifOutNUcastPkts	ipFragCreates	IcmpOutRedirects
ifOutDiscards	ipAdEntAddr	IcmpOutEchos
ifOutErrors	ipAdEntIfIndex	IcmpOutEchoReps
ifOutQLen	ipAdEntNetMask	IcmpOutTimestamps
ifSpecific	ipAdEntBcastAddr	IcmpOutTimestampReps
	ipAdEntReasmMaxSize	IcmpOutAddrMasks
	ipRouteDest	IcmpOutAddrMaskReps
	ipRouteIfIndex	
	ipRouteMetric1	
	ipRouteMetric2	
	ipRouteMetric3	
	ipRouteMetric4	
	ipRouteNextHop	
	ipRouteType	

Interfaces MIB	IP MIB	ICMP MIB
	ipRouteProto	
	ipRouteAge	
	ipRouteMask	
	ipRouteMetric5	
	ipRouteInfo	
	IpNetToMediaIfIndex	
	IpNetToMediaPhysAddress	
	IpNetToMediaNetAddress	
	IpNetToMediaType	
	IpRoutingDiscards	

UDP MIB	TCP MIB	SNMP MIB
UdpInDatagrams	tcpRtoAlgorithm	snmpInPkts
UdpNoPorts	tcpRtoMin	snmpOutPkts
UdpInErrors	tcpRtoMax	snmpInBadVersions
UdpOutDatagrams	tcpMaxConn	snmpInBadCommunityNames
UdpLocalAddress	tcpActiveOpens	snmpInBadCommunityUses
UdpLocalPort	tcpPassiveOpens	snmpInASNParseErrs
	tcpAttempFails	snmpInTooBigs
	tcpEstabResets	snmpInNoSuchNames
Address Translation MIB	tcpCurrEstab	snmpInBadValues
AtIfIndex	tcpInSegs	snmpInReadOnlys
AtPhysAddress	tcpOutSegs	snmpInGenErrs
AtNetAddress	tcpRetransSegs	snmpInTotalReqVars
AtNetAddress	tcpConnState	snmpInTotalSetVars
	tcpConnLocalAddress	snmpInGetRequests
	tcpConnLocalPort	snmpInGetNexts
	tcpConnRemAddress	snmpInSetRequests
	tcpConnRemPort	snmpInGetResponses
	tcpInErrs	snmpInTraps
	tcpOutRsts	snmpOutTooBigs
		snmpOutNoSuchNames
		snmpOutBadValues
		snmpOutGenErrs
		snmpOutGetRequests
		snmpOutGetNexts
		snmpOutSetRequests
		snmpOutGetResponses
		snmpOutTraps
		snmpEnableAuthenTraps

Private MIB File and SNMP Variables

Moxa also provides an SNMP for the I/O MIB file to help you monitor I/O status with SNMP software. You can find the MIB file from Moxa's website. The ioLogik W5312 does not have an Analog Input (AI).

ioLogik W5340/W5340-HSPA

Moxa-IO-MIB	Moxa-IO-MIB	Moxa-IO-MIB
totalChannelNumber	dio05-Index	AI01-Index
serverMode	dio05-Type	AI01-Type
systemTime	dio05- Mode	AI01-Range
firmwareVersion	dio05- Status	AI01-Value
dio00-Index	dio05- Filter	AI01-Min
dio00-Type	dio05- Trigger	AI01-Max
dio00- Mode	dio05- CntStart	AI02-Index
dio00- Status	dio05- PulseStart	AI02-Type
dio00- Filter	dio05- LowWidth	AI02-Range
dio00- Trigger	dio05- HighWidth	AI02-Value
dio00- CntStart	dio06-Index	AI02-Min
dio00- PulseStart	dio06-Type	AI02-Max
dio00- LowWidth	dio06- Mode	AI03-Index
dio00- HighWidth	dio06- Status	AI03-Type
dio01-Index	dio06- Filter	AI03-Range
dio01-Type	dio06- Trigger	AI03-Value
dio01- Mode	dio06- CntStart	AI03-Min
dio01- Status	dio06- PulseStart	AI03-Max
dio01- Filter	dio06- LowWidth	VC00-Index
dio01- Trigger	dio06- HighWidth	VC00-Value
dio01- CntStart	dio07-Index	VC01-Index
dio01- PulseStart	dio07-Type	VC01-Value
dio01- LowWidth	dio07- Mode	VC02-Index
dio01- HighWidth	dio07- Status	VC02-Value
dio02-Index	dio07- Filter	VC03-Index
dio02-Type	dio07- Trigger	VC03-Value
dio02- Mode	dio07- CntStart	VC04-Index
dio02- Status	dio07- PulseStart	VC04-Value
dio02- Filter	dio07- LowWidth	VC05-Index
dio02- Trigger	dio07- HighWidth	VC05-Value
dio02- CntStart	relay00-Index	VC06-Index
dio02- PulseStart	relay00-Type	VC06-Value
dio02- LowWidth	relay00- Mode	VC07-Index
dio02- HighWidth	relay00- Status	VC07-Value
dio03-Index	relay00- LowWidth	VC08-Index
dio03-Type	relay00- HighWidth	VC08-Value
dio03- Mode	relay00- PulseStart	VC09-Index
dio03- Status	relay00- IRelayCNT	VC09-Value
dio03- Filter	relay00- TotalRelayCNT	
dio03- Trigger	relay01-Index	
dio03- CntStart	relay01-Type	
dio03- PulseStart	relay01- Mode	
dio03- LowWidth	relay01- Status	
dio03- HighWidth	relay01- LowWidth	
dio04-Index	relay01- HighWidth	
dio04-Type	relay01- PulseStart	

Moxa-IO-MIB	Moxa-IO-MIB	Moxa-IO-MIB
dio04- Mode	relay01- IRelayCNT	
dio04- Status	relay01- TotalRelayCNT	
dio04- Filter	AI00-Index	
dio04- Trigger	AI00-Type	
dio04- CntStart	AI00-Range	
dio04- PulseStart	AI00-Value	
dio04- LowWidth	AI00-Min	
dio04- HighWidth	AI00-Max	

Factory Default Settings

The factory default settings for firmware V1.3 for the ioLogik W5312 series, V1.5 for the ioLogik W5340 series, and V1.2 for the ioLogik W5340-HSPA series, are as follows:

IP address:	192.168.127.254
Netmask:	255.255.255.0
Gateway:	None
Communication Watchdog:	Disable
Modbus/TCP Alive Check:	ON
Modbus/TCP Timeout Interval:	60 sec
Server Address	None
Server Port	0
Baud Rate	9600
Data Bit	8
Stop Bit	1
Parity	None
Mode	RS-485, 2- Wire
Cellular Band	Auto
Cellular Operation Mode	On-Demand
Caller IDs	None
DI Mode:	DIO-0 to DIO-5 (W5340), DI-0~DI-7, DIO8~11(W5312)
DI Safe Status:	Off
Filter Time for Counter:	10 × 0.5mS
Counter Trigger Type:	Lo to Hi
Counter Status:	Stop
AI Mode:	AI-0 to AI-3, +/- 10V
DO Mode:	DIO-6 to DIO-11(W5340), DO-0~DO-7(W5312)
DO Safe Status:	Off
Pulse Low Width:	1
Pulse Hi Width:	1
No. of Pulses:	0 (continuous)
Filter Time for Counter:	10 × 0.5mS
Counter Trigger Type:	Lo to Hi
Counter Status:	Stop
Counter status:	Stop

Password:	"empty"
Module Name:	"empty"
Module Location:	"empty:"
SNMP:	Enable
Community:	Public
Contact:	"empty"
Location:	"empty"
Data Logging – AI Channel	Logging Per 1min
TFTP Server Address	None
TFTP Server Port	0
Active OPC Server Address	None
Active OPC Server Port	9900

ioLogik W5300 Network Port Usage

Port	Type	Usage
68	UDP	BOOTPC
68	UDP	DHCP
69	UDP	Export/import file
161	TCP	SNMP
502	TCP	Modbus Communication
500	UDP	IPsec VPN, NAT-T disabled
4500	UDP	IPsec VPN, NAT-T enabled
4800	UDP	Auto search
9000	TCP	Active Message (Default)
9000	UDP	Active Message (Default)
9300	TCP	ioAdmin
9500	TCP	Active OPC server
9900	TCP	Active OPC server

Troubleshooting the Cellular I/O Connection

Moxa provides the following checklist as a step-by-step troubleshooting guide. If you still can't solve the problem, please complete the checklist and mail it to Moxa. We will do a further analysis and then contact you with the results.

Type the IP addresses in the spaces provided.

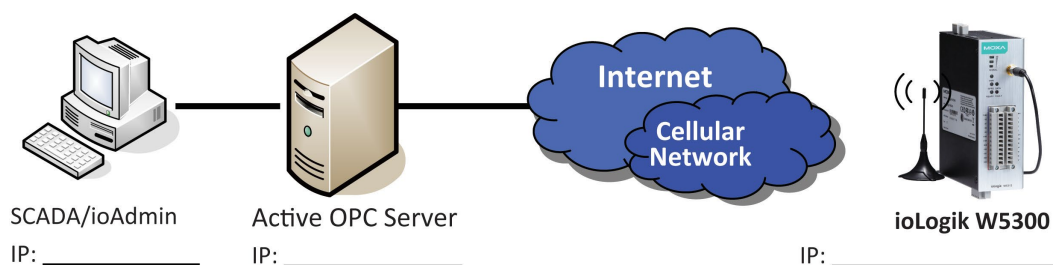

Problem Description:

- Can't Power On
- The W5300 always reboots
- Can't connect to the Cellular network
- ioAdmin can't find the device
- Received error message "Failed to execute OPCENUM"
- SCADA cannot connect to Active OPC Server

Self Checklist:

Power:

1. Is the power connector connected to a power supply? Yes: __V, __A No
2. Does power LED show a steady green? Yes No
3. What color is the READY LED? Green Blinking OFF
4. What color is the FAULT LED? Red Blinking OFF

SIM card settings:

1. Is the antenna connected properly? Yes No
2. Is the SIM card inserted correctly? Yes No
3. Does the SIM card have the capability to connect to a Cellular network? Yes If No, contact your carrier

ioAdmin

1. Is the AOPC IP Address correc? Yes, IP: _____ No
2. Is the GPRS/Link LED a steady green? Yes No
3. What status is shown on ioAdmin's Cellular Dial Up setting tab? _____
4. Check the RSSI Level: _____
5. Where ioAdmin show an error code? If yes, _____ No
6. Does ioAdmin show the Cellular IP address? If yes, IP: _____ If No, contact your carrier
7. Operation Mode: Always On On Demand

Active OPC server (AOPC):

1. Check the Firewall. Port 9900 (AOPC), 9500, 9300, 502 should be open
2. Is the AOPC IP address on the Cellular dial up setting Tab correct? Yes, IP: _____ No
3. Check the AOPC log window. Do you see a message? Yes, _____ No, nothing special
4. Does AOPC's tree view show the device? Yes No
5. Does ioAdmin show the AOPC after adding AOPC manually? Yes No
6. Choose "sort by AOPC" in ioAdmin. Does ioAdmin show the AOPC? Yes No
7. Does ioAdmin show the device in the AOPC list? Yes No
8. Can you ping the AOPC IP address? Yes, Time: _____ms No. How to ping AOPC?

Client Test:

1. Did you install OPC core components in your PC? Yes No
2. Were AOPC and the Client tested on the same PC? Yes No, please install them
3. Did you create an Active Tag in ioAdmin? Yes, No
4. Does Client test connect to AOPC? Yes No. Error Message: _____

Remote Client test:

1. Are the AOPC PC and Client test PC on same Domain? Yes No
2. Are the AOPC PC's firewall, security, and authorization settings set? Yes, check the port setting and user group settings No
3. What kind of Error Message is displayed when you use Client test? _____
4. Please return the completed form to Moxa.

Cellular modem error codes:

Error Code	Phenomena	Display Message
0	Cellular Module_OK	No Error
1	Cellular Module without SIM Card	No SIM Card Installed
2	Cellular_Module with Error PIN Code	PIN Code Error
3	Cellular_Module can't detected	Error Code 3
4	Can't registration Cellular Network	Error Code 4
5	Cellular_Module Parameters Incorrectly	Error Code 5
6	Cellular_Module Busy	Error Code 6
7	APN incorrectly	Wrong APN Setting
8	Dial to Cellular fail	dial to Cellular fail
9	PPP Connect fail	PPP connect fail
10	Cellular_Module is not Ready	Error Code 10
11	Initiate UART port error	Error Code 11
12	No any incoming call in Queue	Error Code 12
13	Communication Timeout between CPU and Module	Error Code 13
14	Unknown Fail	Error Code 13

The following information is provided as a guide that you can refer to when troubleshooting. If you still can't solve your problem, please email the details of the problem to Moxa's tech support engineers. We will do further analysis and then contact with a solution.

How to set Active OPC to get better connection quality

The oLogik W5300 uses a Heartbeat signal to check the connection quality between Active OPC server and the device. In the event of a low bandwidth cellular connection, Active OPC will lose the heartbeat signal of the "Heartbeat Interval." We suggest using a value greater than 60 seconds. For Active OPC server, the time out value of the Modbus gateway function should be greater than the heartbeat interval setting.

Service delay time

Based on our own testing results, the delay time should be less than 3 seconds.

Which TCP ports should Initial open?

Four ports should be opened: 9900, 9500, 9300, and 502. Note that 9900 is definable; please make sure that the port numbers are defined correctly.