

# V2616 Hardware User's Manual

---

First Edition, August 2011

[www.moxa.com/product](http://www.moxa.com/product)

**MOXA**®

© 2011 Moxa Inc. All rights reserved.

# V2616 Hardware User's Manual

The software described in this manual is furnished under a license agreement and may be used only in accordance with the terms of that agreement.

## Copyright Notice

© 2011 Moxa Inc., All rights reserved.

## Trademarks

The MOXA logo is a registered trademark of Moxa Inc.  
All other trademarks or registered marks in this manual belong to their respective manufacturers.

## Disclaimer

Information in this document is subject to change without notice and does not represent a commitment on the part of Moxa.

Moxa provides this document as is, without warranty of any kind, either expressed or implied, including, but not limited to, its particular purpose. Moxa reserves the right to make improvements and/or changes to this manual, or to the products and/or the programs described in this manual, at any time.

Information provided in this manual is intended to be accurate and reliable. However, Moxa assumes no responsibility for its use, or for any infringements on the rights of third parties that may result from its use.

This product might include unintentional technical or typographical errors. Changes are periodically made to the information herein to correct such errors, and these changes are incorporated into new editions of the publication.

## Technical Support Contact Information

[www.moxa.com/support](http://www.moxa.com/support)

### **Moxa Americas**

Toll-free: 1-888-669-2872  
Tel: +1-714-528-6777  
Fax: +1-714-528-6778

### **Moxa Europe**

Tel: +49-89-3 70 03 99-0  
Fax: +49-89-3 70 03 99-99

### **Moxa China (Shanghai office)**

Toll-free: 800-820-5036  
Tel: +86-21-5258-9955  
Fax: +86-10-6872-3958

### **Moxa Asia-Pacific**

Tel: +886-2-8919-1230  
Fax: +886-2-8919-1231

# Table of Contents

<b>1. Introduction</b>	<b>1-1</b>
Overview	1-2
Package Checklist	1-2
Product Features	1-2
Hardware Specifications	1-2
Hardware Block Diagram	1-5
<b>2. Hardware Introduction</b>	<b>2-1</b>
Appearance	2-2
Dimensions	2-3
LED Indicators	2-3
Real Time Clock	2-4
<b>3. Hardware Connection Description</b>	<b>3-1</b>
Installing the V2616	3-2
Wiring Requirements	3-2
Connecting the Power	3-3
Grounding the Unit	3-3
Connecting Data Transmission Cables	3-3
Connecting to the Network	3-3
Connecting to a Serial Device	3-4
Installing a CompactFlash Card	3-4
Connecting a PS/2 Keyboard and Mouse	3-5
Connecting to a USB Device	3-6
DI/DO	3-7
Connecting to a VGA Monitor	3-7
Connecting to a DVI-D Monitor	3-8
Connecting to a Speaker or a Headphone	3-8
Installing an Internal Storage Device	3-9
Installing a SATA Storage Device in the Removable Trays	3-10
Upgrading the Memory Module	3-11
<b>4. BIOS Setup</b>	<b>4-1</b>
Entering the BIOS Setup Utility	4-2
Modifying the BIOS Main Settings	4-2
Basic Configuration	4-2
System Security	4-3
Advanced Settings	4-3
Hard Disk Boot Priority	4-4
Advanced BIOS Features	4-4
CPU Features	4-4
C1E Function	4-4
Virtualization Technology	4-5
Quick Power On Self Test	4-5
Summary Screen Show	4-5
Advanced Chipset Settings	4-5
VT-d	4-5
On-chip Frame Buffer Size	4-5
Total GFX Memory	4-5
Boot Display	4-6
Peripherals	4-6
Onboard Device	4-6
Onboard LAN Boot ROM	4-6
Super I/O Device	4-7
Debug Port	4-7
Power on After Power Fail	4-7
Power	4-7
HPET Support	4-8
HPET Mode	4-8
Soft-Off by PWR-BTTN	4-8
Wake Up Control	4-8
RTC Wake Up	4-8
Hardware Monitor	4-9
CPU Warning Temperature	4-9
Warning Beep	4-9
Load Defaults	4-9
Load System Default Settings	4-10
Load System Turbo Settings	4-10
Load CMOS from BIOS	4-10
Save CMOS to BIOS	4-10

Exiting the BIOS Setup .....	4-10
Save & Exit Setup .....	4-10
Exit Without Saving .....	4-10
Upgrading the BIOS .....	4-11
<b>A. Regulatory Approval Statement .....</b>	<b>A-1</b>

# 1

## Introduction

---

The following topics are covered in this chapter:

- **Overview**
- **Package Checklist**
- **Product Features**
- **Hardware Specifications**
- **Hardware Block Diagram**

# Overview

The V2616 Series EN 50155 certified embedded computers are based on the Intel Core 2 Duo SP9300 x86 processor and feature 2 RS-232/422/485 serial ports, dual LAN ports, and 3 USB 2.0 hosts. In addition, the V2616 computers provide VGA and DVI-D outputs and their EN 50155 certification makes them robust enough for railway and industrial applications.

In addition, the CompactFlash socket and the internal SATA II storage tray provide the V2616 computers with the reliability needed for industrial applications that require data buffering and storage expansion. Most importantly, the V2616 computers come with 2 removable slots for inserting additional storage media, such as hard disks or SSD drives.

The V2616 series come pre-installed with Linux or Windows Embedded Standard 2009 to provide programmers with a familiar environment in which to develop sophisticated, bug-free application software at a low cost.

## Package Checklist

Each model is shipped with the following items:

- V2616 embedded computer
- PS2 to KB/MS Y-type cable
- Documentation and software CD
- Quick installation guide (printed)
- Warranty card

**NOTE: Please notify your sales representative if any of the above items are missing or damaged.**

## Product Features

V2616 embedded computers have the following features:

- High performance network video recorder for rolling stock applications
- EN 50155 certified for temperature ranges up to Class T1
- EN 50121-3-2 certified for railway applications
- IEC 61373 certified for shock and vibration resistance
- One internal SATA II storage tray for 2.5"SSD or HDD
- Two removable storage trays for 2.5"SSDs or HDDs

## Hardware Specifications

### Computer

**CPU:** Intel Core 2 Duo SP9300 2.26 GHz, 6 MB for L2 cache

**OS (pre-installed):** Linux or Windows Embedded Standard 2009

**System Chipset:** Intel GS45 + ICH9-M

**System Memory:** 2 200-pin DDR3 SODIMM sockets supporting DDR3 up to 4 GB, with 2 GB built in

**USB:** 3 USB 2.0 compliant hosts; 2 with type A connectors supporting system bootup, 1 with M12 connector

### Storage

**Built-in:** 2 GB onboard industrial CompactFlash card to store OS

#### HDD Support:

HDD: 1 internal SATA II storage tray for 2.5" SSD or HDD

Removable Trays: Support for 2 storage trays for 2.5" SSD or HDD

### Other Peripherals

**KB/MS:** 1 PS/2 interface supporting standard PS/2 keyboard and mouse through Y-type cable

**Audio:** Line-in, line-out interface

## Display

**Graphics Controller:** Intel GS45 Integrated Graphics Engine

**VGA Interface:** DB15 female connector, up to 2048 x 1536 resolution

**DVI Interface:** DVI-D connector (chrontel CH7307 SDVO to DVI transmitter), up to 1600 x 1200 resolution

## Ethernet Interface

**LAN:** 2 auto-sensing 10/100/1000 Mbps ports (M12)

## Serial Interface

**Serial Standards:** 2 software-selectable RS-232/422/485 ports\* (DB9 male)

**Optical Isolation Protection:** 2 KV

**ESD Protection:** 4 KV for all signals

**Magnetic Isolation Protection:** 1.5 KV built-in

## Serial Communication Parameters

**Data Bits:** 5, 6, 7, 8

**Stop Bits:** 1, 1.5, 2

**Parity:** None, Even, Odd, Space, Mark

**Flow Control:** RTS/CTS, XON/XOFF, ADDC® (automatic data direction control) for RS-485

**Baudrate:** 50 bps to 921.6 Kbps (non-standard baudrates supported; see user's manual for details)

## Serial Signals

**RS-232:** TxD, RxD, DTR, DSR, RTS, CTS, DCD, GND

**RS-422:** TxDA(-), TxDB(+), RxDB(+), RxDA(-), GND

**RS-485-4w:** TxDA(-), TxDB(+), RxDB(+), RxDA(-), GND

**RS-485-2w:** DataA(-), DataB(+), GND

## Digital Input

**Input Channels:** 6, source type

**Input Voltage:** 0 to 30 VDC at 25 Hz

**Digital Input Levels for Dry Contacts:**

- Logic level 0: Close to GND
- Logic level 1: Open

**Digital Input Levels for Wet Contacts:**

- Logic level 0: +3 V max.
- Logic level 1: +10 V to +30 V (Source to DI)

**Isolation:** 3 KV optical isolation

## Digital Output

**Output Channels:** 2, sink type

**Output Current:** Max. 200 mA per channel

**On-state Voltage:** 24 VDC nominal, open collector to 30 VDC

**Connector Type:** 10-pin screw terminal block (6 DI points, 2 DO points, DI Source, GND)

**Isolation:** 3 KV optical isolation

## LEDs

**System:** Power x 1, Storage x 1

**LAN:** 100M/Link x 2, 1000M/Link x 2

**Serial:** TX x 2, RX x 2

## Switches and Buttons

**Power Switch:** on/off (front panel)

**Reset Button:** For warm reboot (front panel)

## Physical Characteristics

**Housing:** Aluminum

**Weight:** 5 kg

**Dimensions:**

Without ears: 287 x 250 x 101 mm (11.29 x 9.84 x 3.97 in)

With ears: 287 x 290 x 101 mm (11.29 x 11.41 x 3.97 in)

**Mounting:** wall

**Environmental Limits**

**Operating Temperature:** (with SSD installed) -25 to 55°C (-13 to 140°F)

**Storage Temperature:** (with SSD installed) -30 to 60°C (-40 to 185°F)

**Ambient Relative Humidity:** 5 to 95% (non-condensing)

**Anti-vibration:** EN 50155 standard

**Anti-shock:** EN 50155 standard

**Power Requirements**

**Input Voltage:** 24 VDC (9 to 36 V), M12 connector

**Power Consumption:** 50 W

- 2 A @ 24 VDC

**Standards and Certifications**

**Safety:** UL 60950-1, CSA C22.2 No. 60950-1-07, EN 60950-1

**EMC:** EN 55022 Class A, EN 61000-3-2 Class D, EN 61000-3-3, EN 55024, FCC Part 15 Subpart B Class A

**Rail Traffic:** EN 50155, EN 50121-2-3, EN 50121-4, IEC 61373

**Green Product:** RoHS, CRoHS, WEEE

**Reliability**

**Automatic Reboot Trigger:** Built-in WDT (watchdog timer) supporting 1-255 level time interval system reset, software programmable

**Warranty**

**Warranty Period:** 3 years

**Details:** See [www.moxa.com/warranty](http://www.moxa.com/warranty)

**Note:** The Hardware Specifications apply to the embedded computer unit itself, but not to accessories. In particular, the wide temperature specification does not apply to accessories such as the power adaptor and cables.



# Hardware Block Diagram

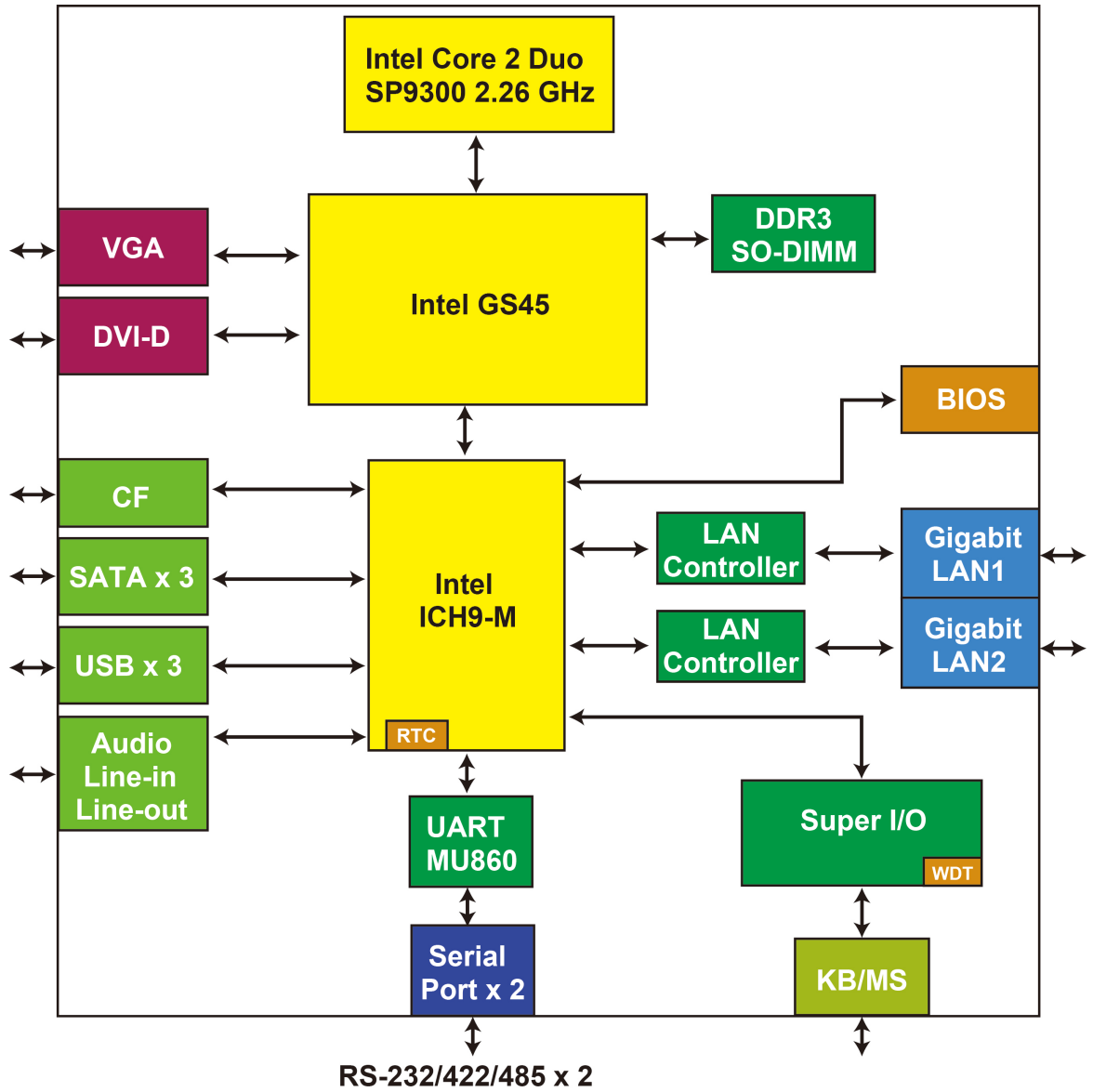

## Hardware Introduction

---

The V2616 series embedded computers are compact, well-designed, and built rugged enough for industrial applications. LED indicators help you monitor performance and identify trouble spots, multiple serial ports allow you to connect different devices for wireless operation, and the reliable and stable hardware platform lets you devote your attention to developing your applications.

The following topics are covered in this chapter:

- **Appearance**
- **Dimensions**
- **LED Indicators**
- **Real Time Clock**

# Appearance

## Front View

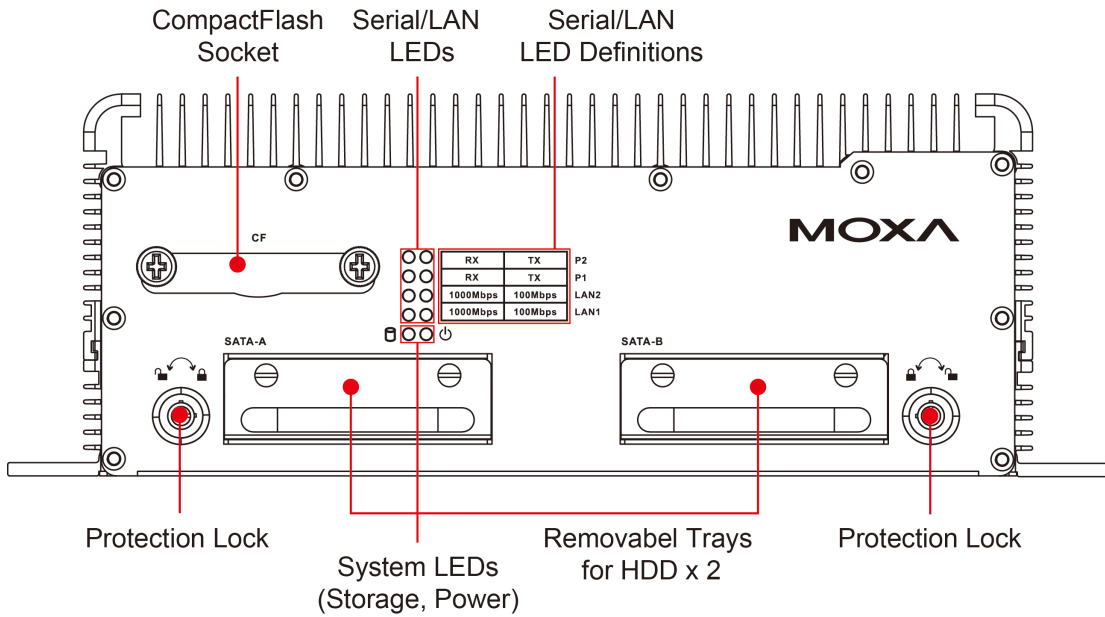

## Rear View

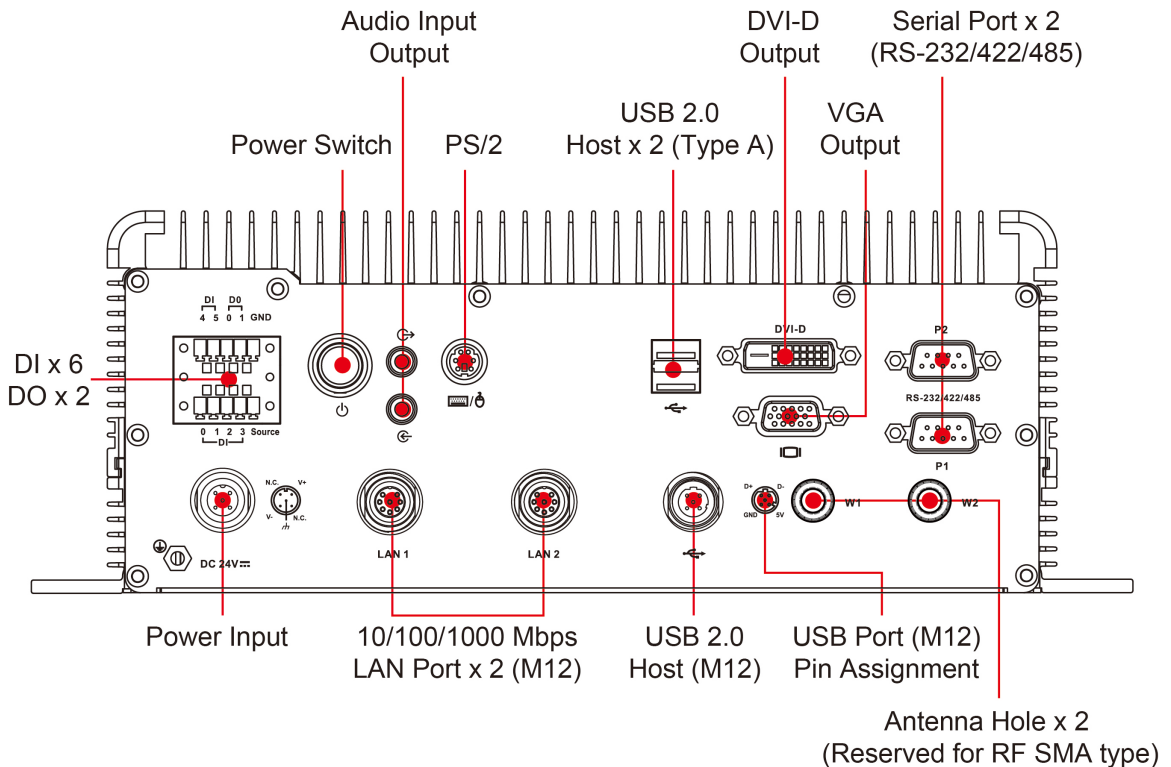

# Dimensions

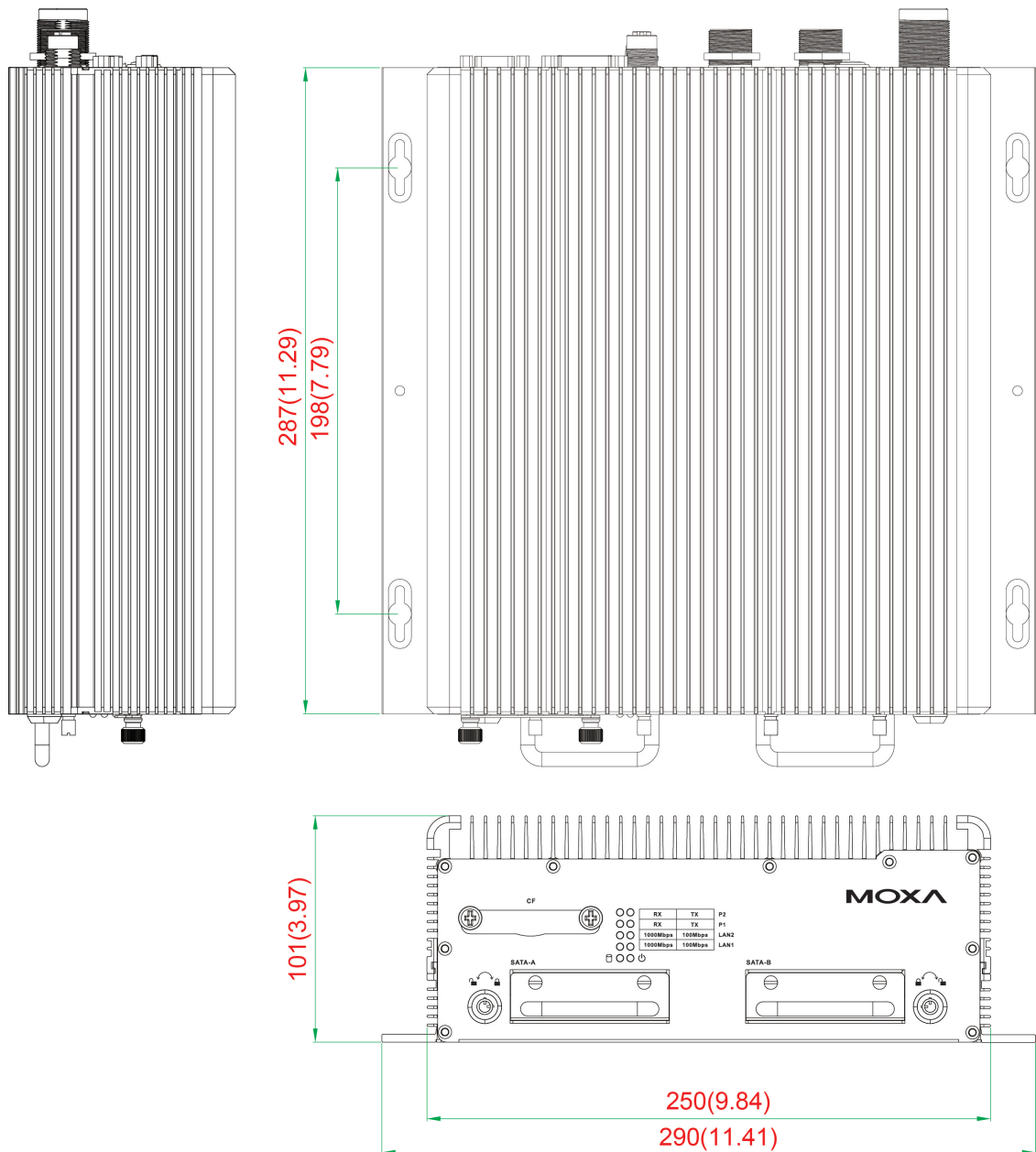

# LED Indicators

LED Name	LED Color	LED Function
Power	Green	Power is on and functioning normally
	Off	Power is off or power error exists
Storage	Yellow	CF/HDD card is detected
	Off	CF/HDD card is not detected
LAN (1, 2)	Green	100 Mbps Ethernet mode
	Yellow	1000 Mbps Ethernet mode
	Off	10 Mbps or no activity
Tx (P1-P2)	Green	Serial ports P1-P2 transmitting data
	Off	Serial ports P1-P2 not transmitting data
Rx (P1-P2)	Yellow	Serial ports P1-P2 receiving data
	Off	Serial ports P1-P2 not receiving data

# Real Time Clock

The embedded computer's real-time clock is powered by a lithium battery. We strongly recommend that you **NOT** replace the lithium battery on your own. If the battery needs to be changed, please contact the Moxa RMA service team.



## **ATTENTION**

There is a risk of explosion if the wrong type of battery is used. To avoid this potential danger, always be sure to use the correct type of battery. Contact the Moxa RMA service team if you need to replace your battery.

## **Caution**

There is a risk of explosion if the battery is replaced by an incorrect type. Dispose of used batteries according to the instructions on the battery.

# Hardware Connection Description

---

In this chapter, we show how to connect the embedded computers to the network and to various devices.

The following topics are covered in this chapter:

- ❑ **Installing the V2616**
- ❑ **Wiring Requirements**
  - Connecting the Power
  - Grounding the Unit
- ❑ **Connecting Data Transmission Cables**
  - Connecting to the Network
  - Connecting to a Serial Device
- ❑ **Installing a CompactFlash Card**
- ❑ **Connecting a PS/2 Keyboard and Mouse**
- ❑ **Connecting to a USB Device**
- ❑ **DI/DO**
- ❑ **Connecting to a VGA Monitor**
- ❑ **Connecting to a DVI-D Monitor**
- ❑ **Connecting to a Speaker or a Headphone**
- ❑ **Installing an Internal Storage Device**
- ❑ **Installing a SATA Storage Device in the Removable Trays**
- ❑ **Upgrading the Memory Module**

# Installing the V2616

## Wall or Cabinet Mounting

The V2616 comes with two wall-mounting brackets. Use two screws per side to attach the V2616 to a wall or cabinet.

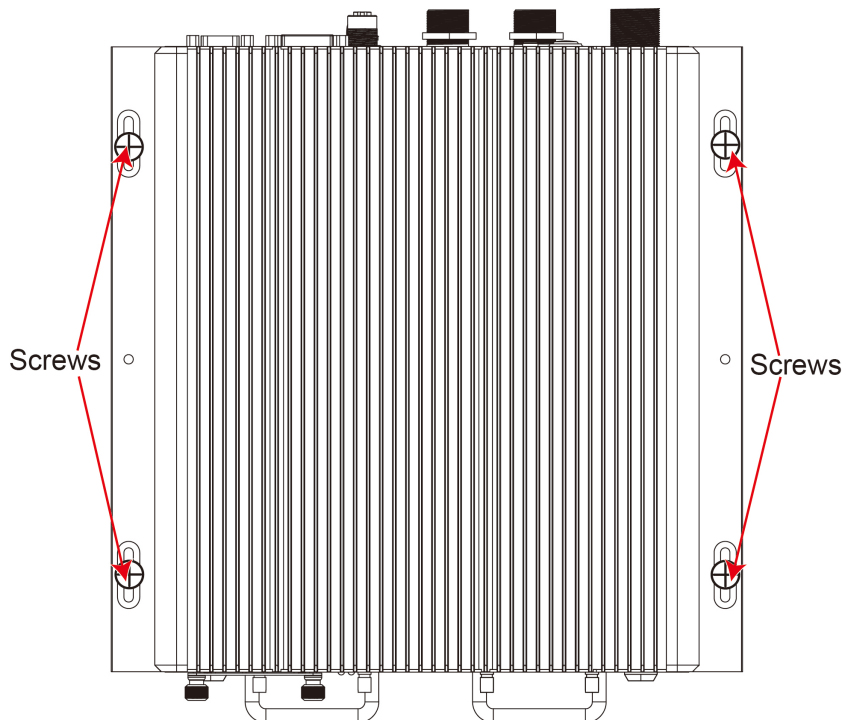

## Wiring Requirements

This section describes how to connect serial devices to the embedded computer.

You should read and follow these common safety precautions before proceeding with the installation of any electronic device:

- Use separate paths to route wiring for power and devices. If power wiring and device wiring paths must cross, make sure the wires are perpendicular at the intersection point.

NOTE: Do not run signal or communication wiring together with power wiring in the same wire conduit. To avoid interference, wires with different signal characteristics should be routed separately.

- Use the type of signal transmitted through a wire to determine which wires should be kept separate. The rule of thumb is that wiring that shares similar electrical characteristics can be bundled together.
- Keep input wiring and output wiring separate.
- It is advisable to label the wiring to all devices in the system.



**ATTENTION**

**Safety First!**

Be sure to disconnect the power cord before installing and/or wiring your V2616.

**Wiring Caution!**

Calculate the maximum possible current in each power wire and common wire. Observe all electrical codes dictating the maximum current allowable for each wire size.

If the current goes above the maximum ratings, the wiring could overheat, causing serious damage to your equipment.

**Temperature Caution!**

Be careful when handling the unit. When the unit is plugged in, the internal components generate heat, and consequently the outer casing may feel hot to the touch.

## Connecting the Power

Connect the 12 to 48 VDC power line with M12 connector to the V2616 computer. If the power is supplied properly, the "Ready" LED will glow a solid green after a 25 to 30 second delay.

## Grounding the Unit

**SG**      **SG:** The Shielded Ground (sometimes called Protected Ground) contact is the central pin of the power input connector. Connect the SG wire to an appropriate grounded metal surface.

**N.C.**      **V+**

**V-**      **N.C.**

## Connecting Data Transmission Cables

This section describes how to connect the V2616 embedded computers to the network and serial devices.

### Connecting to the Network

Plug your network cable into the embedded computer's Ethernet port. The other end of the cable should be plugged into your Ethernet network. When the cable is properly connected, the LEDs on the embedded computer's Ethernet port will glow to indicate a valid connection.

Two 10/100/1000 Mbps Ethernet ports using M12 connectors are located on the front panel. See the figure at the right for pin assignments.

Pin No.	10/100 Mbps	1000 Mbps
1	-	TRD3+
2	-	TRD4+
3	-	TRD4-
4	ERx-	TRD1-
5	ETx+	TRD2+
6	ERx+	TRD1+
7	-	TRD3-
8	ETx-	TRD2-



## Connecting to a Serial Device

Use a serial cable to plug your serial device into the embedded computer's serial port. Serial ports P1 to P2 have male DB9 connectors and can be configured for RS-232, RS-422, or RS-485 communication by software. The pin assignments are shown in the following table:

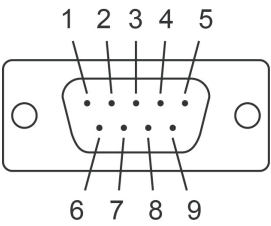
DB9 Male Port		RS-232/422/485 Pinouts				
		<b>Pin</b>	<b>RS-232</b>	<b>RS-422</b>	<b>RS-485-4W</b>	<b>RS-485-2W</b>
1		1	DCD	TxDA(-)	TxDA(-)	-
2		2	RxD	TxDB(+)	TxDB(+)	-
3		3	TxD	RxDB(+)	RxDB(+)	DataB(+)
4		4	DTR	RxDA(-)	RxDA(-)	DataA(-)
5		5	GND	GND	GND	GND
6		6	DSR	-	-	-
7		7	RTS	-	-	-
8		8	CTS	-	-	-

## Installing a CompactFlash Card

The V2616 embedded computers come with a CompactFlash socket. To insert a CompactFlash card, follow these instructions:

1. Disconnect the V2616 from its power source.
2. The CompactFlash socket is located on the left side of the front panel. Unscrew the CompactFlash socket cover.

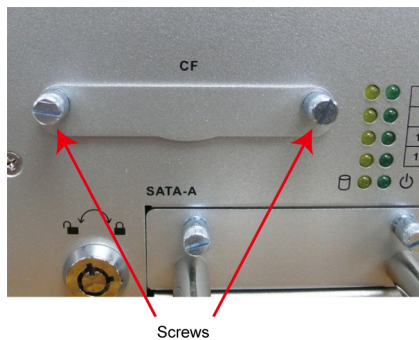

3. There is a tenon/hook on the cover of the CF socket. Turn the CompactFlash card over and then insert the CompactFlash card into the tenon/hook of the CF socket cover.



### ATTENTION

Be careful of how you orient the CompactFlash card. You should turn the CF card bottom side up, in order to hook CF card into the CF socket cover.

- Gently insert the CompactFlash card into the CF socket, making sure that the card is oriented correctly.

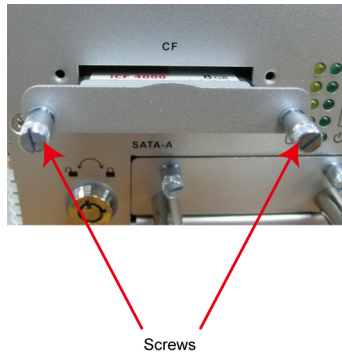

**ATTENTION**

The V2616 embedded computer does not support the CompactFlash hot swap and PnP (Plug and Play) functions. You must remove the power source first before inserting or removing the CompactFlash card.

In addition, note that since the operating system (Linux or Windows XP Embedded) has already been stored on the CompactFlash card, if you change the CompactFlash card you will need to re-install the V2616's operating system. Refer to the System Recovery Section in the Software User's Manual for details.

## Connecting a PS/2 Keyboard and Mouse

Your V2616 embedded computers come with a PS/2 mini-DIN connector to connect to a PS/2 keyboard and PS/2 mouse. This 6-pin mini-DIN connector has the pin assignments shown below.

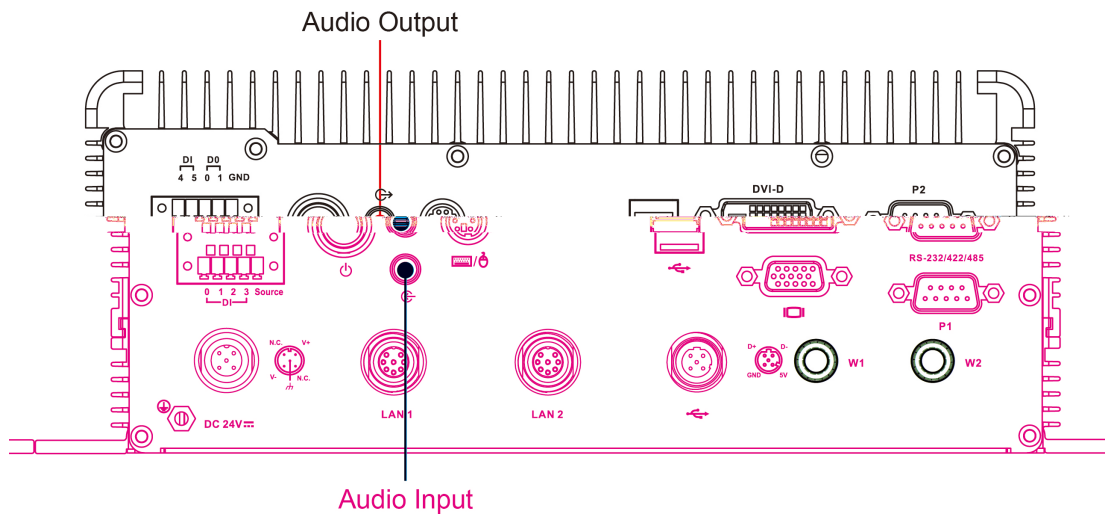

**PS/2 Connector**

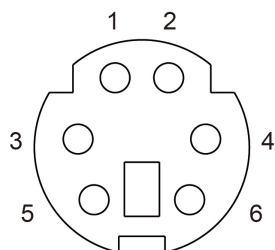

Pin No.	Signal Definition
1	PS/2 Keyboard Data
2	PS/2 Mouse Data
3	GND
4	VCC
5	PS/2 Keyboard Clock
6	PS/2 Mouse Clock

Use the Y-type cable to convert the mini-DIN connector into two 6-pin mini-DIN connectors to connect both a PS/2 keyboard and PS/2 mouse at the same time. You may also use the USB ports to connect your USB-based keyboard and mouse.



**ATTENTION**

Without a Y-type cable, the PS/2 connector on the V2616 can only work with a PS/2 keyboard. A PS/2 mouse will not function when directly connected to the PS/2 connector on the V2616 embedded computers.

## Connecting to a USB Device

The V2616 comes with 1 USB 2.0 host with M12 connectors on the front panel, and 2 USB 2.0 host with type A connector on the rear panel. The hosts can be used for an external flash disk or hard drive for storing large amounts of data. You can also use these USB hosts to connect to a keyboard or a mouse. See the following figures for the locations of the USB ports and the M12 connector pin assignment.

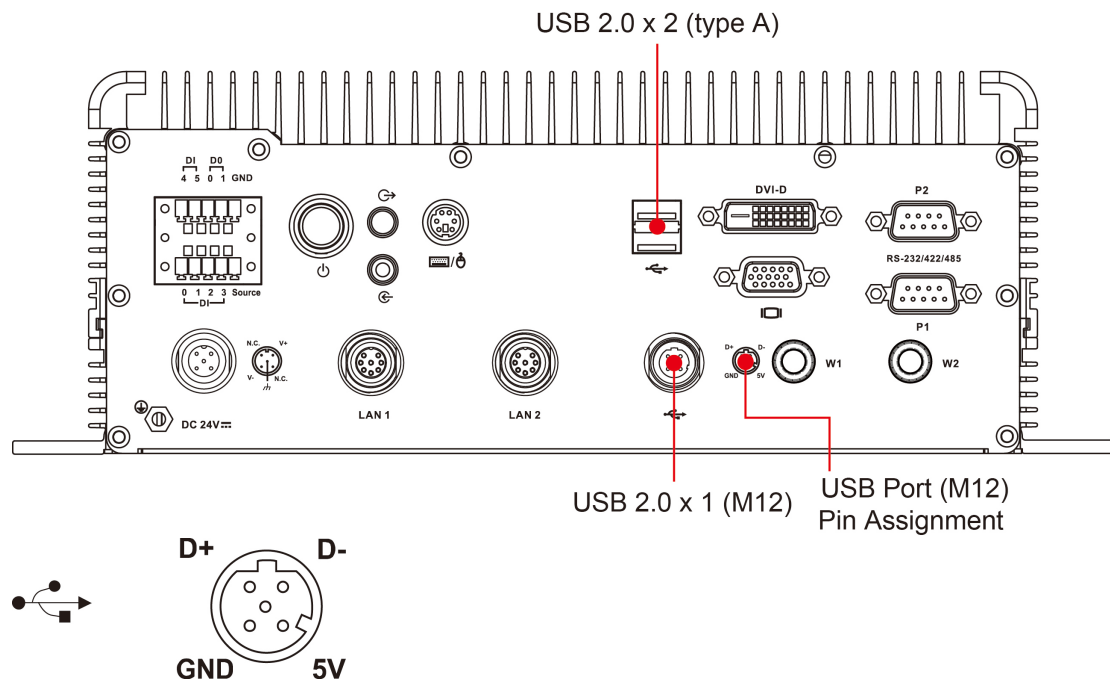

# DI/DO

The V2616 comes with a 6-ch digital input and a 2-ch digital output through a terminal block connector. The pin assignments and the wiring methods are shown below..

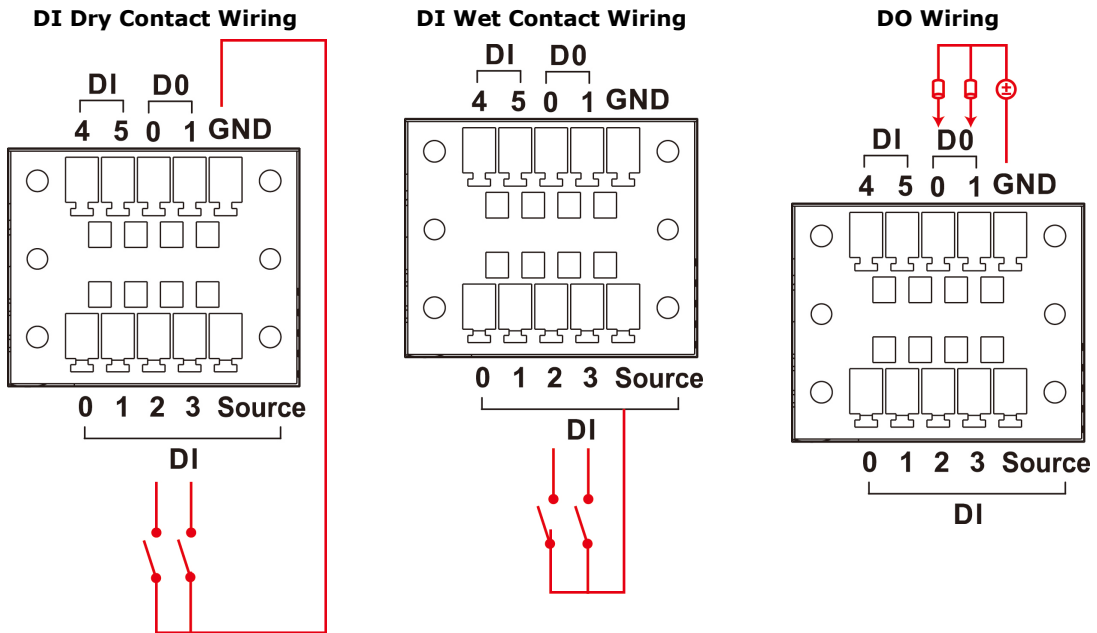

# Connecting to a VGA Monitor

The V2616 comes with a D-Sub 15-pin female connector on the front panel to connect a VGA CRT monitor. To ensure that the monitor image remains clear, be sure to tighten the monitor cable after connecting it to the V2616. The location and the pin assignments of the VGA connector are shown below.

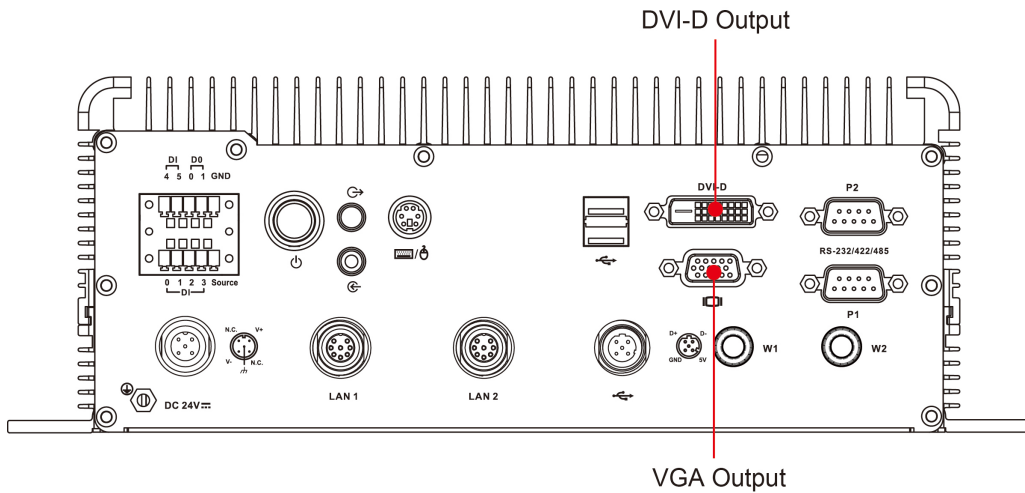

## DB15 Female Connector

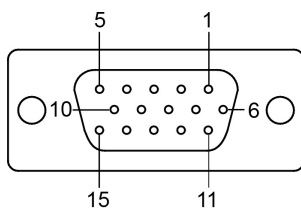

Pin No.	Signal Definition	Pin No.	Signal Definition
1	Red	9	VCC
2	Green	10	GND
3	Blue	11	NC
4	NC	12	DDC2B Data
5	GND	13	HSYNC
6	GND	14	VSYSN
7	GND	15	DDC2B Clock
8	GND		

# Connecting to a DVI-D Monitor

The V2616 computers also come with a DVI-D connector that can connect to a DVI monitor. Use the cable to connect one end to the DVI-D connector and the other end to the monitor. See the following table for DVI-I connector pin assignments.

## DVI-D Connector

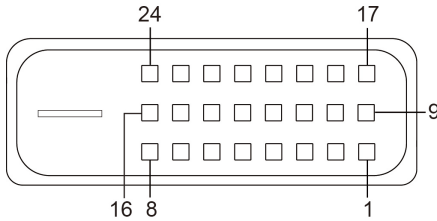

Pin	Signal Definition	Pin	Signal Definition
1	T.M.D.S. Data2-	13	N/C
2	T.M.D.S. Data2+	14	+5V Power
3	T.M.D.S. Data2 Shield	15	Ground (return for +5V, HSync, and VSync)
4	N/C	16	Hot Plug Detect
5	N/C	17	T.M.D.S. Data0-
6	DDC Clock	18	T.M.D.S. Data0+
7	DDC Data	19	T.M.D.S. Data0 Shield
8	N/C	20	N/C
9	T.M.D.S. Data1-	21	N/C
10	T.M.D.S. Data1+	22	T.M.D.S. Clock Shield
11	T.M.D.S. Data1 Shield	23	T.M.D.S. Clock+
12	N/C	24	T.M.D.S. Clock-

# Connecting to a Speaker or a Headphone

The V2616 comes with audio input and output interfaces for connecting a microphone and speaker or headphones. See the following figure for details.

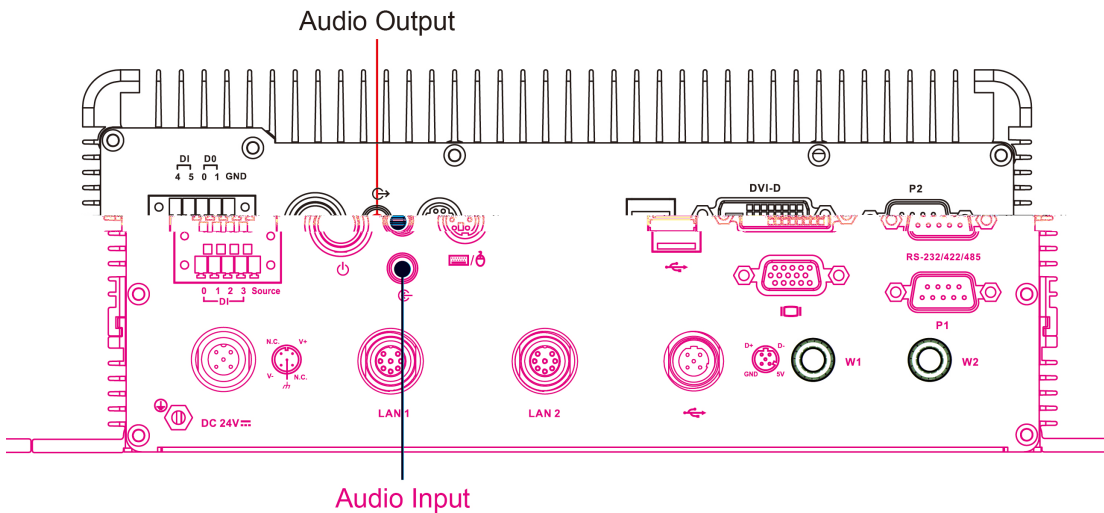

# Installing an Internal Storage Device

The V2616 computer comes with an internal storage tray that allows users to install a 2.5-inch SATA storage device, such as a hard disk or a SSD drive. Take the following steps to install your storage device.

1. Remove the 8 screws from the V2616's rear panel.

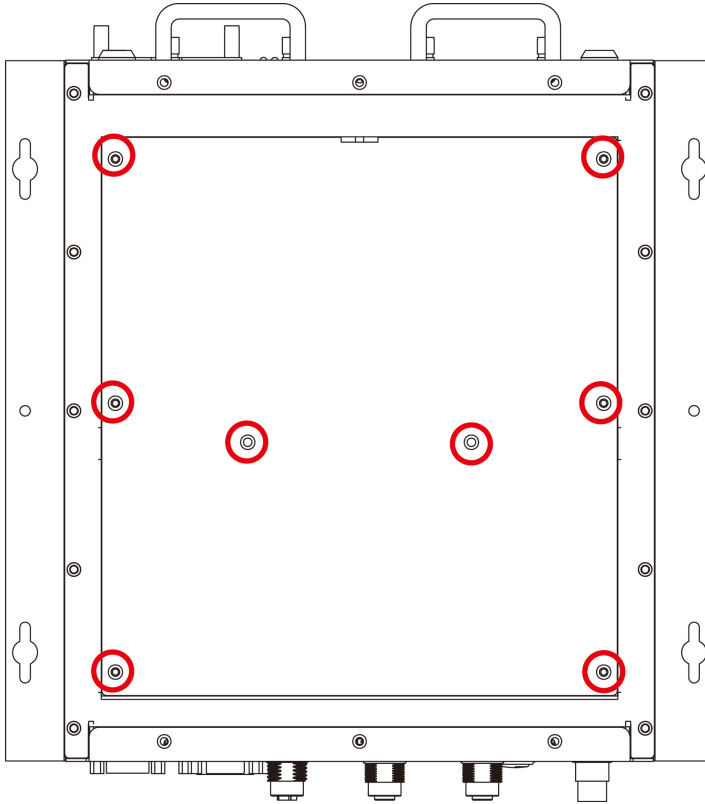

2. Remove the back cover to expose the storage tray. Remove the 4 screws on the storage tray, and pull up the cover on the left to remove the storage cable.

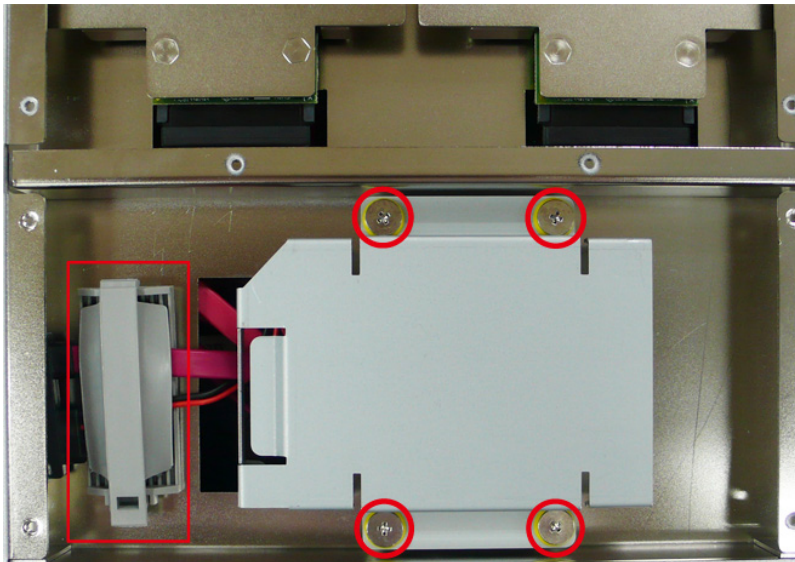

3. First connect the cable and then place the storage device into the tray. Be sure to orient the device in the correct direction.



4. Fasten the screws on the sides of the storage tray.

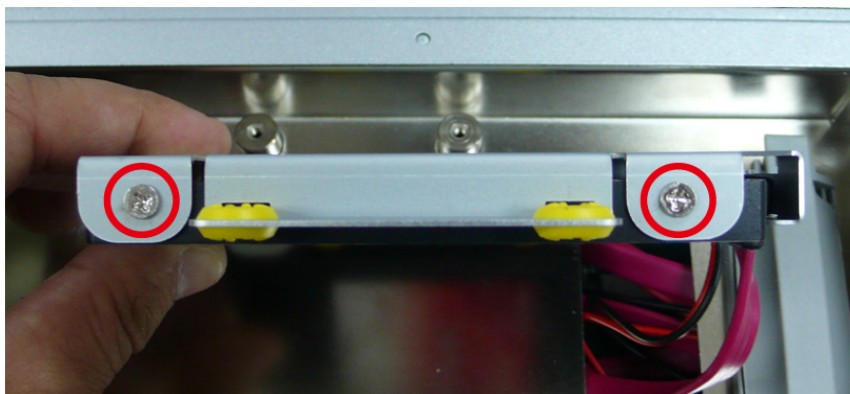

5. Fasten the screws on the storage tray and then place the cover on the back of the computer.

## Installing a SATA Storage Device in the Removable Trays

The V2616 computers come with 2 removable slots for inserting additional storage media, such as hard disks or SSD drives. See the following section for instructions on inserting the storage devices in the removable trays.

1. There are two removable trays on the front panel of the V2616. A protection lock is also provided for storage security.

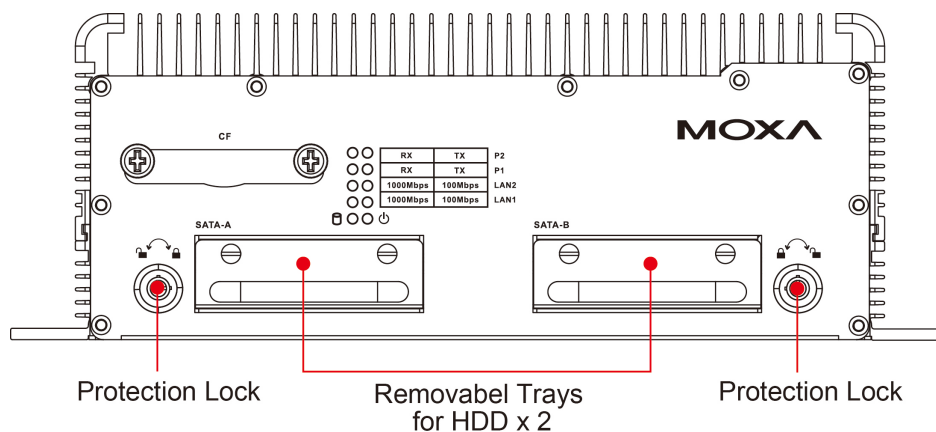

2. Rotate the key counterclockwise to unlock the protection lock, and then pull out the tray by grasping the screws on each side. Place the hard disk into the tray, and then turn the tray clockwise. Fasten the hard disk with two screws on the back of the tray.



### ATTENTION

To successfully fit the disk into the slot, use the plain-cup screws to fasten the hard disk to the tray. **Do not** use the round-cup screws, since they may prevent you from being able to insert the tray into the slot.



round-cup

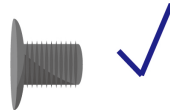

plain-cup

3. Gently insert the tray into the slot on the front panel of the V2616 computer.
4. When finished, turn the key clockwise to activate the lock. Use the same method to install a hard disk in second storage tray.

## Upgrading the Memory Module

The V2616 embedded computers support one 200-pin DDR3 533 SODIMM module with up to 4 GB of memory. Two DDR2 SDRAM memory modules are installed at the factory. To upgrade the DDR2 SDRAM memory module, follow these instructions:

1. Disconnect the V2616 from the power source.
2. We suggest placing the V2616 upside down. Remove all the screws on the back and front panels. See the following figures for details.

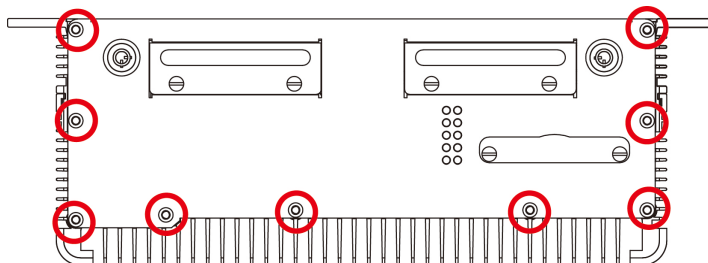



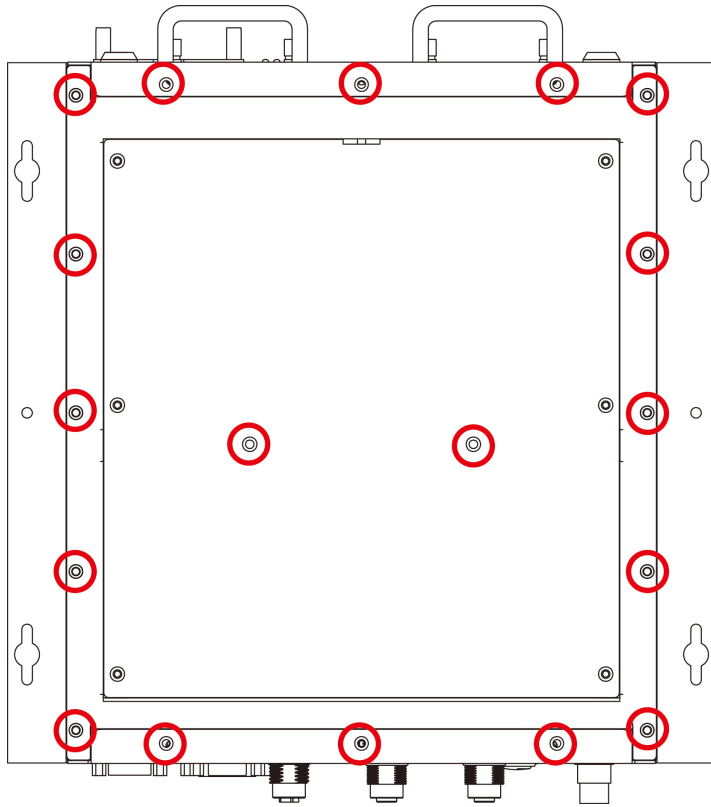

3. Pull up the back cover of the computer; you will be able to see the memory module socket on the main board.

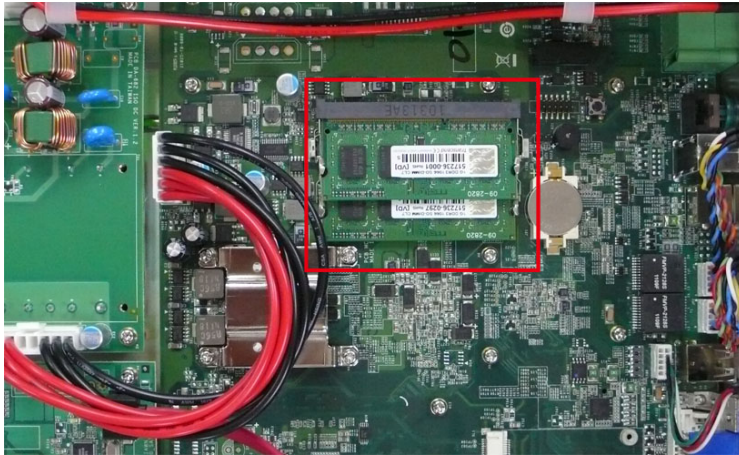

- Carefully remove the module by pushing the latches on both sides of the module, and then replace the new module. Be sure to orient the module correctly.

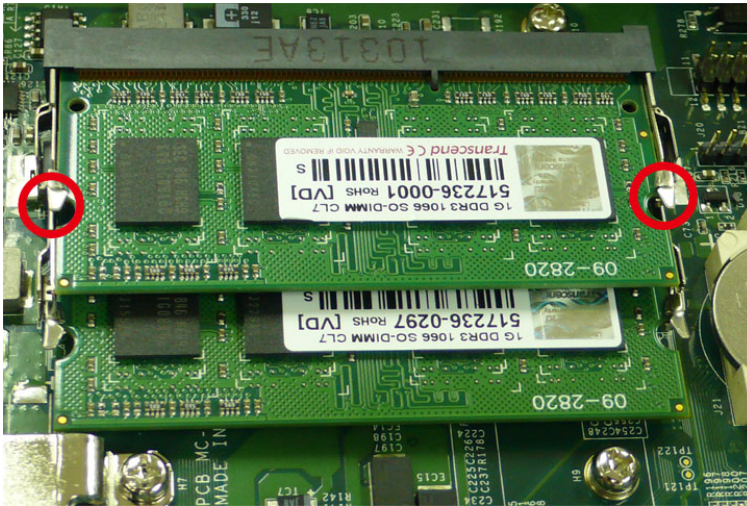

- Push down the module and make sure the latches are firmly in place.

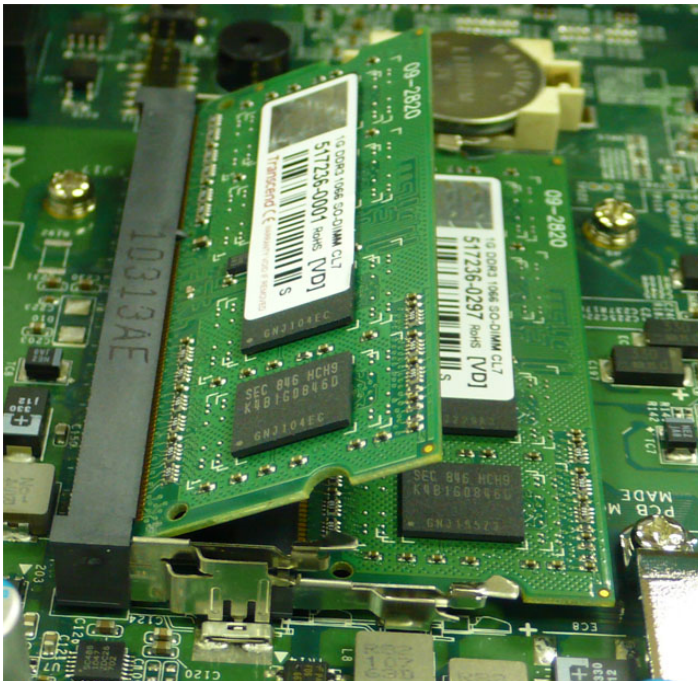

- When finished, replace the back cover of the V2616 computer.

# BIOS Setup

---

This chapter describes the BIOS settings of the V2616 computer. The BIOS is a set of input/output control routines for peripherals. The BIOS is used to initialize basic peripherals and helps boot the operating system before the operating system is loaded. The BIOS setup allows the user to modify the system configurations of these basic input/output peripherals. All of the configurations will be stored in the battery backed up CMOS RAM, which retains the system information after system reboots or the power is removed.

The following topics are covered in this chapter:

❑ **Entering the BIOS Setup Utility**

❑ **Modifying the BIOS Main Settings**

- Basic Configuration
- System Security

❑ **Advanced Settings**

- Hard Disk Boot Priority
- Advanced BIOS Features
- CPU Features
- Advanced Chipset Settings

❑ **Peripherals**

- Onboard Device
- Super I/O Device

❑ **Power**

- HPET Support
- HPET Mode
- Soft-Off by PWR-BTTN

❑ **Wake Up Control**

- RTC Wake Up

❑ **Hardware Monitor**

- CPU Warning Temperature
- Warning Beep

❑ **Load Defaults**

- Load System Default Settings
- Load System Turbo Settings
- Load CMOS from BIOS
- Save CMOS to BIOS

❑ **Exiting the BIOS Setup**

- Save & Exit Setup
- Exit Without Saving

❑ **Upgrading the BIOS**

# Entering the BIOS Setup Utility

To enter the BIOS setup utility, press the "Del" key while the system is booting up. The main BIOS Setup screen will appear.

A basic description of each function key is listed at the bottom of the screen. Refer to these descriptions to learn how to scroll about the screen, how to select by pressing "Enter," and how to use the other hot keys listed below.

**F1: General Help**

**F5: Previous Value**

**F6: Default Settings**

**F7: Turbo Settings**

**F10: Save**

**ESC: Exit**

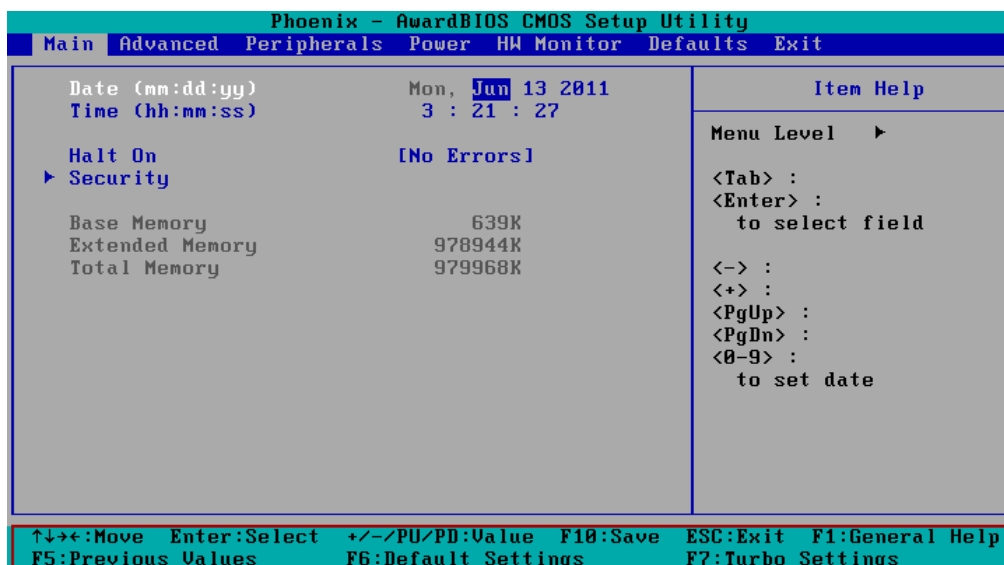

## Modifying the BIOS Main Settings

### Basic Configuration

After entering the BIOS Setup, or choosing the "Main" option, the BIOS main menu will be displayed. Use this menu to check the basic system information such as memory and IDE hard drive. You can also use the menu for configuring basic system parameters, such as date, time, hard drive, display, and system security.

## System Security

To set up system security, select the "Security" option under "Main" to bring up the following screen.

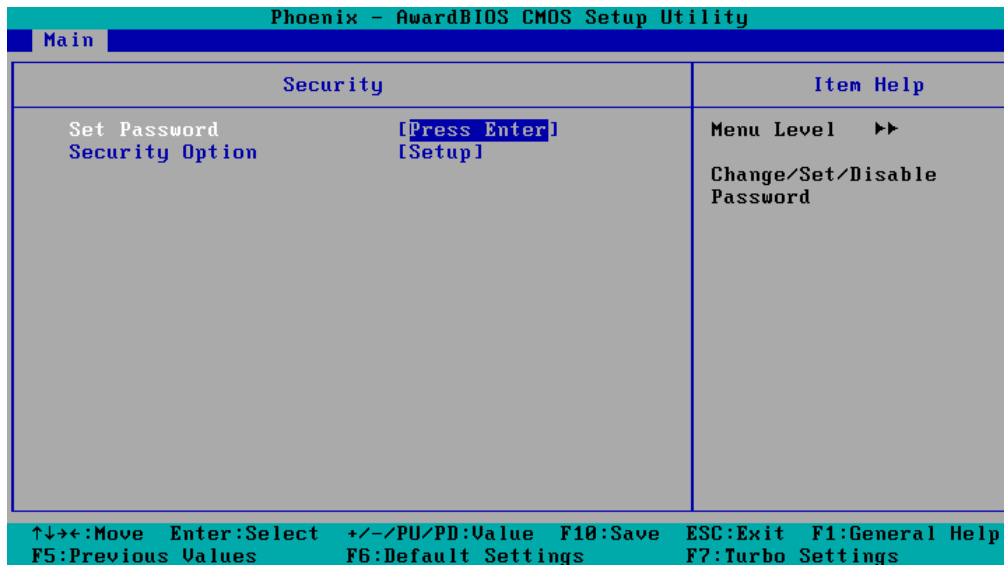

This menu includes two options: "Set Password" and "Security Option."

When you select the Set Password option, a pop-up "Enter Password:" window will appear on the screen. The password that you type will replace the password stored in the CMOS memory. You will be required to confirm the new password. Just re-type the password and then press **<Enter>**. You may also press **<Enter>** to abort the selection and not enter a password.

To clear an existing password, just press **<Enter>** when you are prompted to enter the password. A message will show up confirming that the password will be disabled. Once the password is disabled, the system will boot and you can enter the "BIOS Setup Menu" without entering a password.

Once a password has been set, you will be prompted to enter the password each time you enter Setup. This prevents unauthorized persons from changing any part of your system configuration. In addition, when a password setting is enabled, you can set up the BIOS to request a password each time the system is booted up. The "Security Option" setting determines when a password prompt is required. If the "Security Option" is set to "System," the password must be entered both at boot up and when entering the BIOS Setup Menu. If the password is set for "Setup," the password prompt only occurs when you enter the "BIOS Setup Menu."

## Advanced Settings

The "Advanced Features" screen will appear when choosing the "Advanced" item from the main menu.

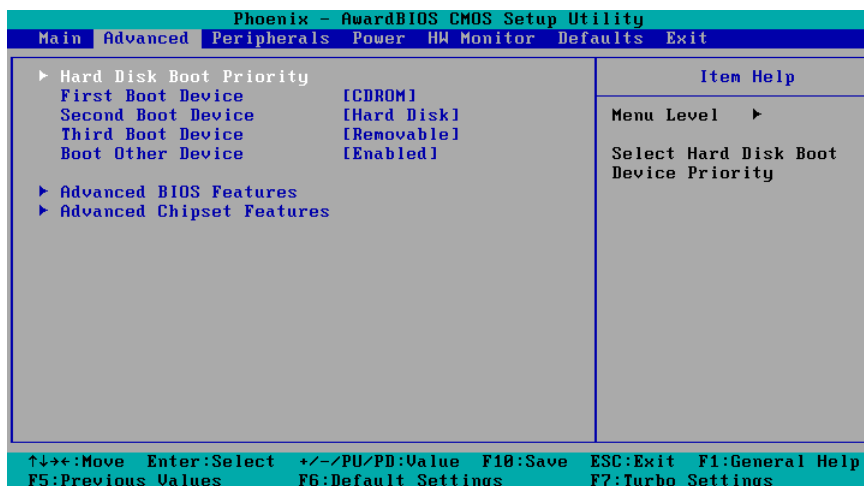

## Hard Disk Boot Priority

### First/Second/Third Boot Device

This option allows users to select or change the device boot priority. You may set 3 levels of priority to determine the boot up sequence for different bootable devices, such as a hard drive, CD-ROM, and removable devices. Select the order in which devices will be searched in order to find a boot device. The available options are "CDROM (default for first boot device)," "Removable" (default for third boot device), "Hard Disk" (default for second boot device) and "Disabled."

## Advanced BIOS Features

When you select the "Advanced BIOS Features" option under the "Advanced" menu, the following configuration menu will appear.

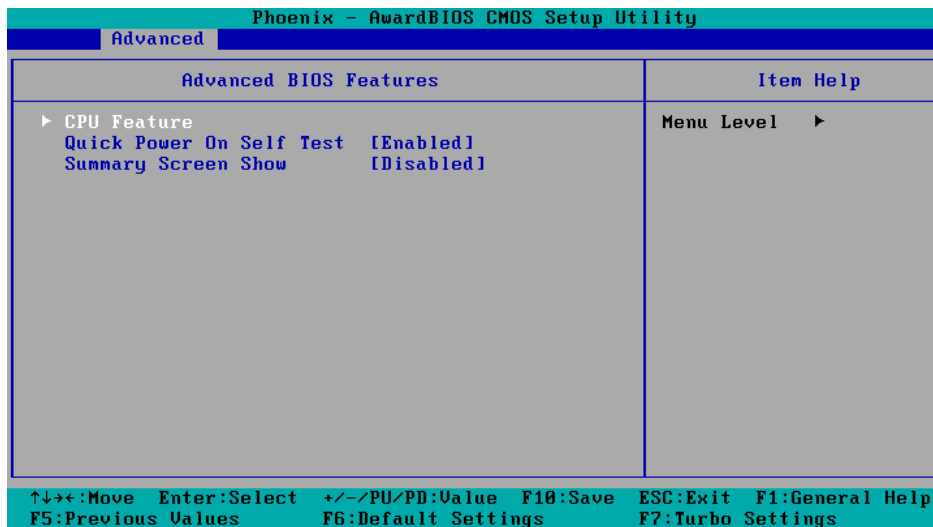

## CPU Features

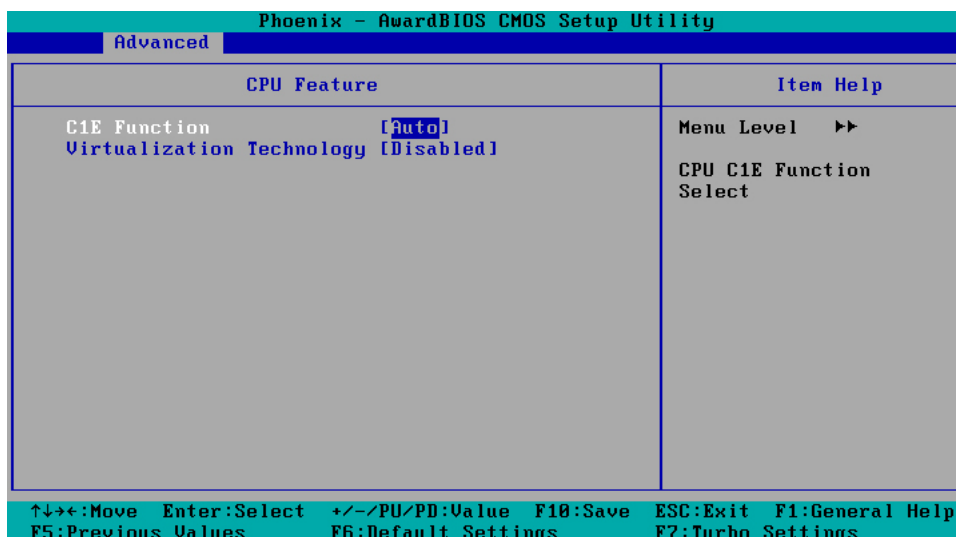

### C1E Function

This item allows you to configure the power-saving mode when the CPU is in C1 status.

Options: Auto (default), Disabled

## Virtualization Technology

This item allows you to enable or disable the Virtualization Technology

Options: Enabled, Disabled (default)

## Quick Power On Self Test

This setting allows the system to skip certain tests while the system boots up. Enable this feature to speed up the boot up process.

Options: Enabled (default), Disabled

## Summary Screen Show

The summary screen displays system information, including CPU, memory, disk drive, and PCI devices. The default value is disabled. You may choose "Enabled" to display this screen when the system is booting up.

Options: Disabled (default), Enabled

## Advanced Chipset Settings

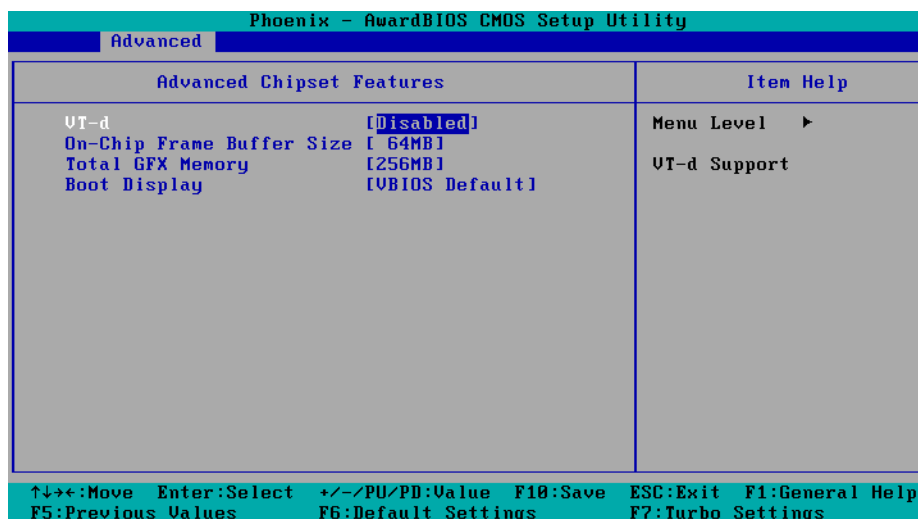

### VT-d

This item allows you to enable or disable the VT-d function.

Options: Enabled, Disabled (default)

### On-chip Frame Buffer Size

This item determines the frame buffer size for the VGA function, and will share the system memory.

Options: 32MB, 64MB (default), 128MB

### Total GFX Memory

Sets the maximum amount of system memory that can be allocated as graphics memory.

Options: 128 MB, 256 MB (default), MAX.

## Boot Display

This item allows you to choose which display interface will be shown when system is booting up. Due to the display limitation, two displays at most can be shown when booting up. If you select the default option, "VBIOS Default", the displays that have been connected will be used as the default displays.

Options: VBIOS Default (default), CRT, DVI, CRT+DVI

## Peripherals

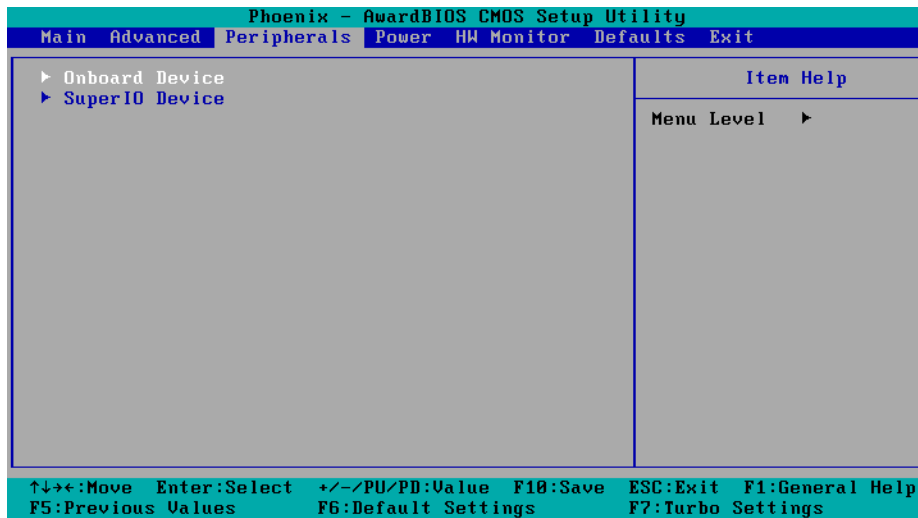

## Onboard Device

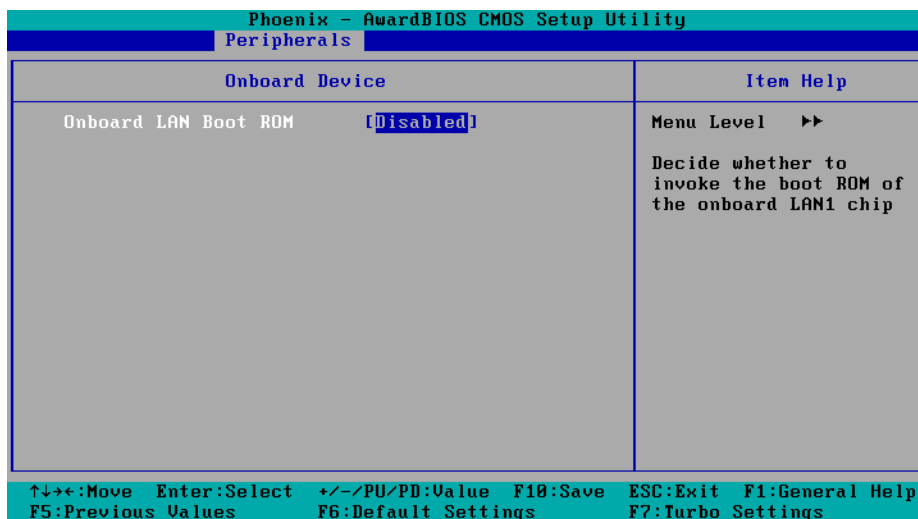

## Onboard LAN Boot ROM

Decide whether to invoke the boot ROM of the onboard LAN chip.

Options: Enabled, Disabled (default)



# Super I/O Device

## Debug Port

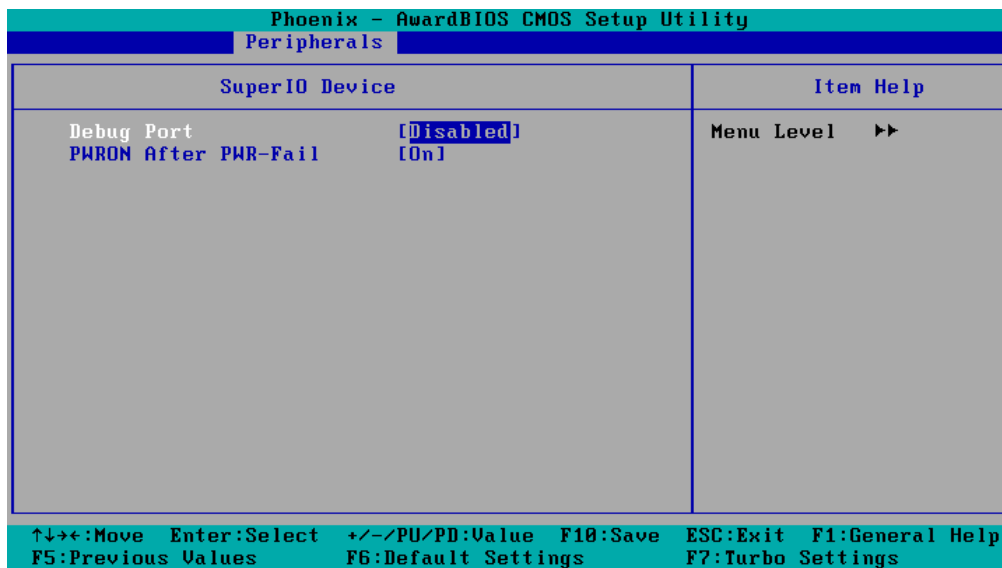

This function allows you to enable/disable the debug port communication. This port is only for engineers who are debugging program.

Options: Disabled (default), Enabled

## Power on After Power Fail

This item allows you to configure the power on after power fail function.

Options: Off, On (default), Former-Sts

# Power

The Power Setup Menu allows you to configure your system power-up/ power-down options.

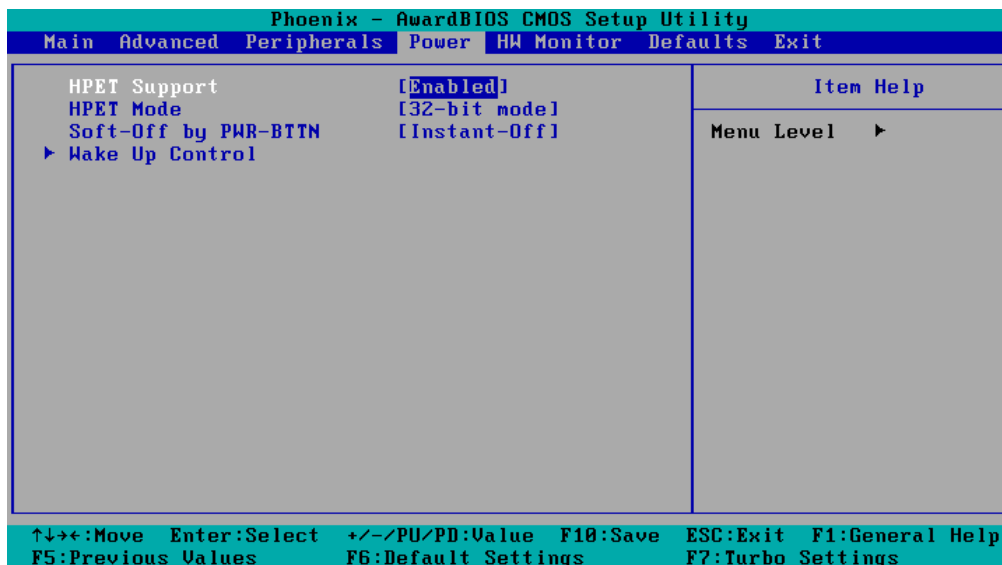

## HPET Support

This item allows you to enable/disable the HPET (High Precision Event Timer) function.

Option: Enabled (default), Disabled

## HPET Mode

This item allows you to select the HPET mode.

Option: 32-bit mode (default), 64-bit mode

## Soft-Off by PWR-BTTN

This item determines the delay to stop the software when pushing the power button.

Options: Instant-Off (default), Delay 4 Sec.

## Wake Up Control

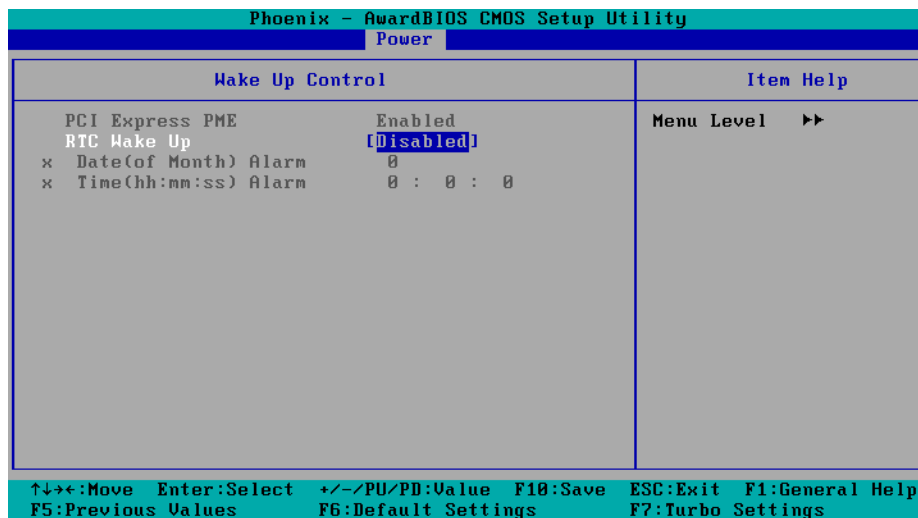

## RTC Wake Up

This item allows you to enable/disable the RTC wake up function.

Options: Disabled (default), Enabled

# Hardware Monitor

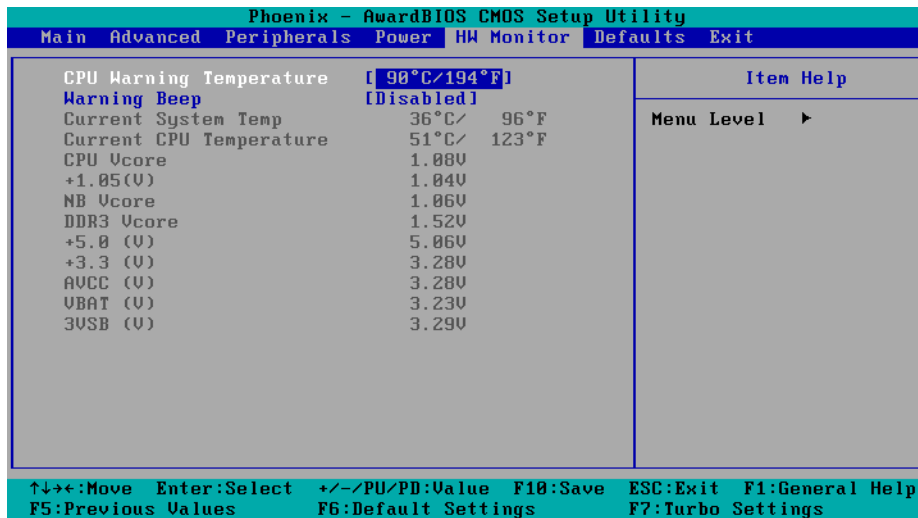

This item helps monitor the status of the system, including CPU temperature and the voltage of the CPU, SDRAM and battery.

## CPU Warning Temperature

This item allows you to configure what temperature will trigger a high temperature warning.

Options: 80°C/176°F, 90°C/194°F (default), 100°C/212°F, Disabled

## Warning Beep

This item allows you to enable/disable the warning beep.

Options: Disabled (default), Enabled

## Load Defaults

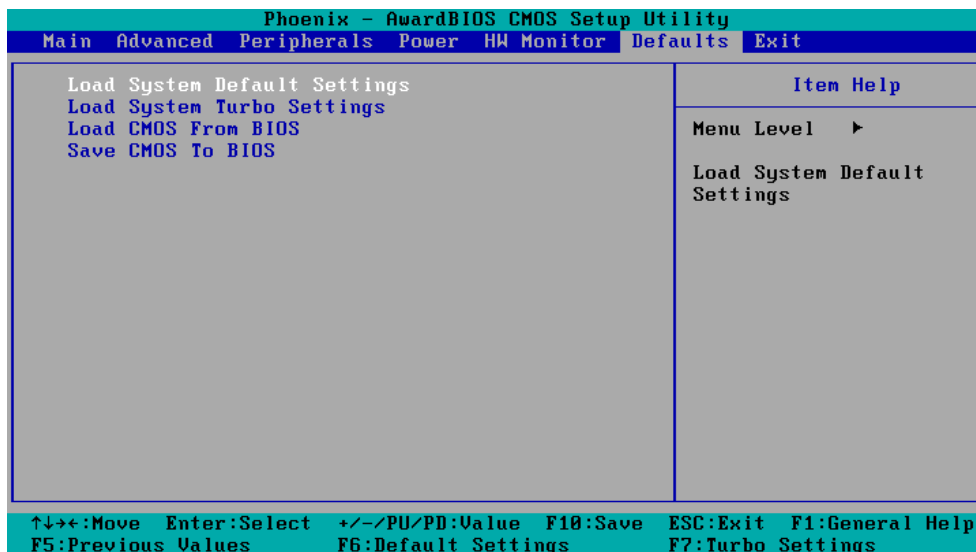

## Load System Default Settings

Use this option to load system factory default settings instead of the current BIOS settings. This option is useful for when the system is unstable. Users do not need to remember what settings were active before the system fails.

## Load System Turbo Settings

Use this option to load system optimized settings. If the system is not stable, please load the system default settings.

## Load CMOS from BIOS

Use this option to load BIOS settings from flash ROM to CMOS.

## Save CMOS to BIOS

Use this option to save the BIOS settings from the CMOS to flash ROM.

## Exiting the BIOS Setup

To exit the BIOS setup utility, choose "Exit." Pressing **<ESC>** will achieve the same result.

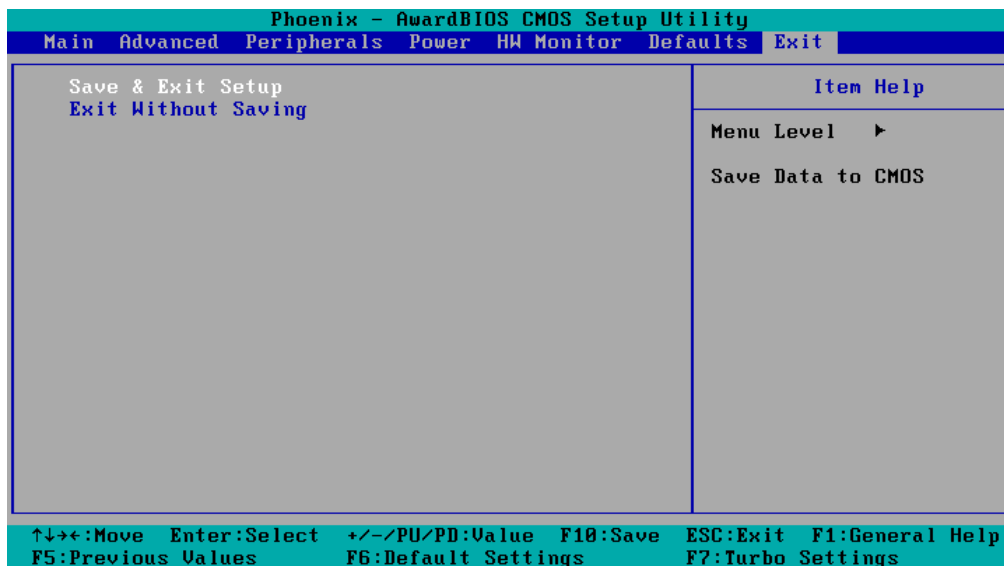

## Save & Exit Setup

Save all configuration changes to CMOS (memory) and exit setup. A confirmation message will be displayed before proceeding.

## Exit Without Saving

Abandon all changes made during the current session and exit setup. A confirmation message will be displayed before proceeding.

# Upgrading the BIOS

This section describes how to upgrade the BIOS. However, please note that upgrading the BIOS involves high risk of damage to your computer. We strongly recommend that you contact Moxa's TS staff for assistance and obtain all necessary tools and files before attempting to upgrade.

## Step 1: Create a Bootable USB Disk.

We suggest you use the HP USB Disk Format Tool to create a bootable USB disk. You may download this tool from the Internet. Search the Internet using the phrase "HP USB Disk Storage Format Tool", and then download the tool from one of the listed websites.

You will also need to download the FreeDos system files **kernel.sys** and **command.com** from <http://www.freedos.org/kernel/>.

1. Copy DOS system files **kernel.sys** and **command.com** to a specified directory (**C:\FreeDOS** in this example).
2. Start the HP USB Disk Storage Format Tool and select the USB device that you want to use as a bootable disk in the **Device** drop down box.
3. Select **FAT** in the **File system** drop down box.
4. Type the disk name in the **Volume label field**.
5. Check the option **Create a DOS startup disk** under format options.
6. Specify the directory of the system files (for example, **C:\FreeDOS**).
7. Click **Start** to format and create the USB disk.

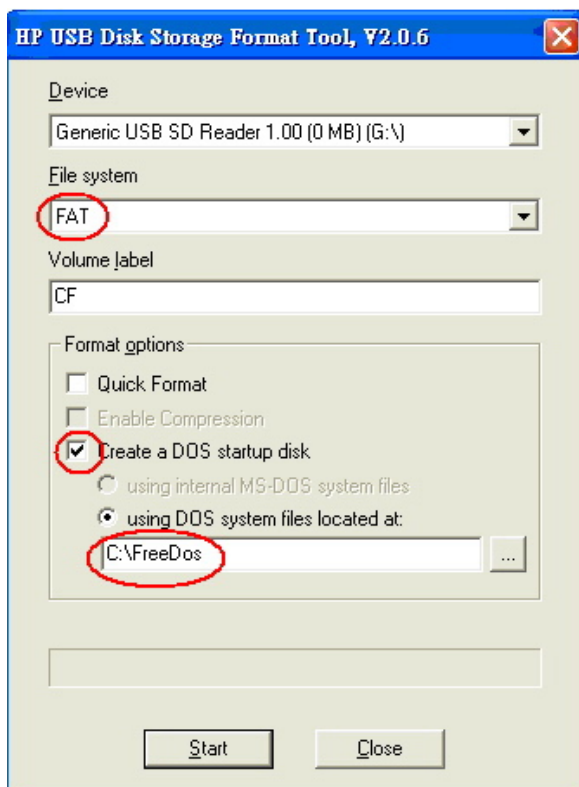

### ATTENTION

We suggest you use a USB drive with under 2 GB in disk space, as larger USB drives may not support FAT file format and consequently fail to boot.

## Step 2: Prepare the Upgrade Tool and BIOS Binary File.

You must use the BIOS upgrade installation file to upgrade the BIOS. Contact Moxa TS for details at [support@moxa.com](mailto:support@moxa.com).

1. Get the BIOS upgrade installation file. The file name should have following format: **261010.s02**.

2. Copy the file to the Bootable USB Disk.
3. Double click to extract the BIOS update installation file. The file includes a binary file in the form **s261610.SXX** and the upgrade utility named **awdflash.exe**.

**Step 3: Set up the BIOS to Boot from the USB Disk.**

1. Insert the USB disk.
2. Power on and press **DEL** to enter the BIOS Setup menu.
3. Select **Advanced** → **Hard Disk Boot Priority** and then press **Enter**.
4. From the Setup menu, use “↑” or “↓” to select the USB device.

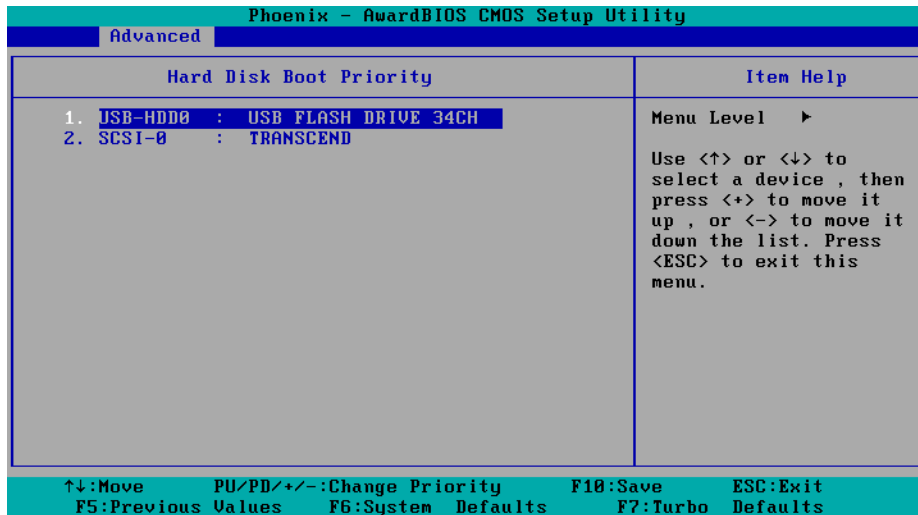

5. Press “+” to move it up to the first priority, and press “Esc” to exit the setup menu.
6. Make sure the first boot device is **Hard Disk**. If isn’t, press **Enter** to change it.

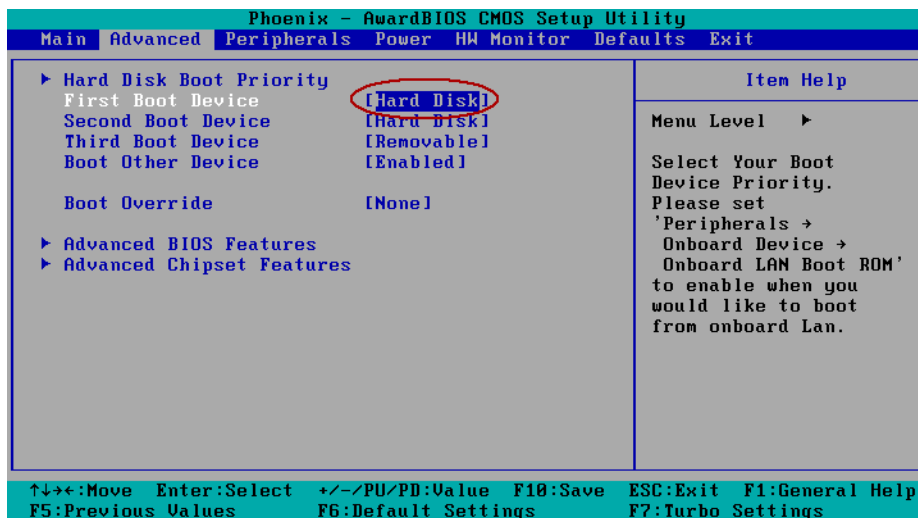

7. Select **Exit** → **Save & Exit Setup** and then press **Enter**.
8. Choose **Y** to save to the CMOS and then exit.

**Step 4: Run awdflash.exe to upgrade the BIOS.**

1. While in the BIOS Setup menu and before upgrading the BIOS, you may choose to save the old BIOS files to a specific location. Type **Y** to do so, or **N** to begin the upgrade.
2. If the BIOS Setup is correct, it will restart and boot from the USB disk.
3. Run **awdflash 261610.SXX** from the command line to upgrade the BIOS. Replace xxxxxxx.Sxx with the BIOS binary file name discussed in Step 2.

4. Press **F1** to reset the system after the bios update is complete. The system should reboot at this time.

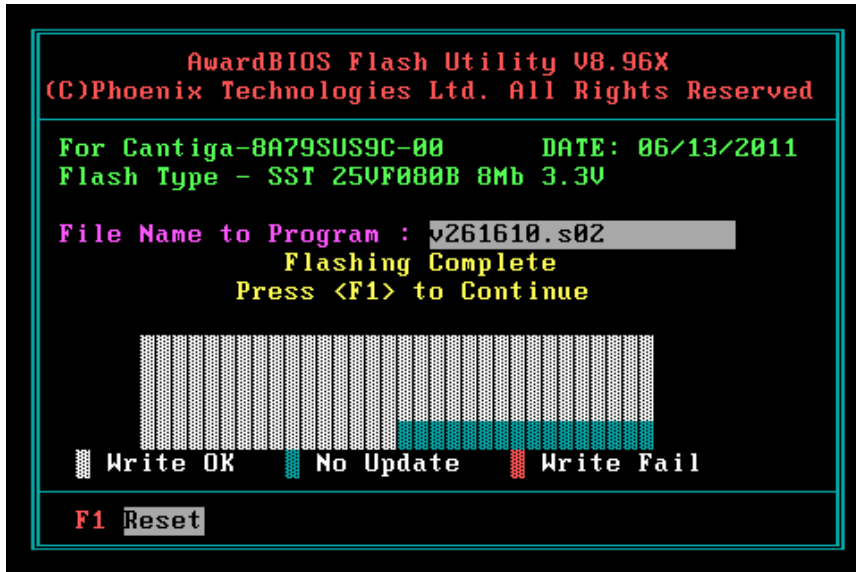

5. Please note that once the BIOS is successfully upgraded, the default BIOS values will be automatically loaded. However, if you wish to re-configure the BIOS settings, press **DEL** while booting.

**ATTENTION**

Do NOT switch off the power supply during the BIOS upgrade, since doing so may cause the system to crash.

# A

## Regulatory Approval Statement

---



This device complies with part 15 of the FCC Rules. Operation is subject to the following two conditions: (1) This device may not cause harmful interference, and (2) this device must accept any interference received, including interference that may cause undesired operation.

**Class A:** FCC Warning! This equipment has been tested and found to comply with the limits for a Class A digital device, pursuant to part 15 of the FCC Rules. These limits are designed to provide reasonable protection against harmful interference when the equipment is operated in a commercial environment. This equipment generates, uses, and can radiate radio frequency energy and, if not installed and used in accordance with the instruction manual, may cause harmful interference to radio communications. Operation of this equipment in a residential area is likely to cause harmful interference in which case the user will be required to correct the interference at his own expense.



**European Community**

**Warning:**

This is a class A product. In a domestic environment this product may cause radio interference in which case the user may be required to take adequate measures.