

Moxa Managed Ethernet Switches User's Manual

Second Edition, September 2011

www.moxa.com/product

MOXA®

© 2011 Moxa Inc. All rights reserved.

Moxa Managed Ethernet Switches User's Manual

The software described in this manual is furnished under a license agreement and may be used only in accordance with the terms of that agreement.

Copyright Notice

© 2011 Moxa Inc., All rights reserved.

Trademarks

The MOXA logo is a registered trademark of Moxa Inc.
All other trademarks or registered marks in this manual belong to their respective manufacturers.

Disclaimer

Information in this document is subject to change without notice and does not represent a commitment on the part of Moxa.

Moxa provides this document as is, without warranty of any kind, either expressed or implied, including, but not limited to, its particular purpose. Moxa reserves the right to make improvements and/or changes to this manual, or to the products and/or the programs described in this manual, at any time.

Information provided in this manual is intended to be accurate and reliable. However, Moxa assumes no responsibility for its use, or for any infringements on the rights of third parties that may result from its use.

This product might include unintentional technical or typographical errors. Changes are periodically made to the information herein to correct such errors, and these changes are incorporated into new editions of the publication.

Technical Support Contact Information

www.moxa.com/support

Moxa Americas

Toll-free: 1-888-669-2872

Tel: +1-714-528-6777

Fax: +1-714-528-6778

Moxa Europe

Tel: +49-89-3 70 03 99-0

Fax: +49-89-3 70 03 99-99

Moxa China (Shanghai office)

Toll-free: 800-820-5036

Tel: +86-21-5258-9955

Fax: +86-10-6872-3958

Moxa Asia-Pacific

Tel: +886-2-8919-1230

Fax: +886-2-8919-1231

Table of Contents

1. About this Manual	1
2. Getting Started	1
Serial Console Configuration (115200, None, 8, 1, VT100)	2
Configuration by Telnet Console	4
Configuration by Web Browser	6
Disabling Telnet and Browser Access	8
3. Featured Functions	1
Configuring Basic Settings	2
System Identification	2
Password	3
Accessible IP List	4
Port Settings	5
Network Parameters	6
IP4	6
IP6	7
System Time Settings	8
IEEE 1588 PTP	9
How does an Ethernet Switch Affect 1588 Synchronization?	9
Can Ethernet switches be designed to avoid the effects of these fluctuations?	10
Configuring PTP	11
System File Update	14
Update System Files by Remote TFTP	14
Update System Files from Local PC	15
ABC (Auto-Backup Configurator) Configuration	15
Restart	16
Reset to Factory Default	16
Using Port Trunking	16
The Port Trunking Concept	16
Port Trunking Settings	17
Configuring SNMP	18
SNMP Read/Write Settings	20
Trap Settings	21
SNMP Trap Mode—Trap	21
SNMP Trap Mode—Inform	21
Private MIB Information	21
Using PoE (PoE Models Only)	22
PoE Setting	22
PoE Power Budget	22
Port Setting	23
PoE Timetabling	23
Weekly Timetabling	24
PoE Status	24
PoE Email Warning Events Settings	24
PoE Relay Warning Events Settings	25
Using Traffic Prioritization	25
The Traffic Prioritization Concept	25
Configuring Traffic Prioritization	27
QoS Classification	27
CoS Mapping	28
TOS/DiffServ Mapping	29
Using Virtual LAN	29
The Virtual LAN (VLAN) Concept	29
Sample Applications of VLANs Using Moxa Switches	31
Configuring Virtual LAN	32
VLAN Settings	32
VLAN Table	34
Using Multicast Filtering	35
The Concept of Multicast Filtering	35
Configuring IGMP Snooping	37
Static Multicast MAC Addresses	39
Configuring GMRP	40
GMRP Table	40
Multicast Filtering Behavior	41
Using Bandwidth Management	41
Configuring Bandwidth Management	41
Type 1	42
Type 2	43
Security	45

User Login Authentication – User Login Settings	45
User Login Authentication – Auth Server Setting	45
Using Port Access Control	46
Static Port Lock	46
IEEE 802.1X	46
Configuring Static Port Lock	47
Configuring IEEE 802.1X	47
802.1X Re-Authentication	48
Local User Database Setup	49
Port Access Control Table	49
Using Auto Warning	50
Configuring Email Warning	50
Configuring Event Types	50
Configuring Email Settings	51
Configuring Relay Warning	52
Configuring Event Types	53
Warning List	53
Using Line-Swap-Fast-Recovery	54
Configuring Line-Swap Fast Recovery	54
Using Set Device IP	54
Configuring Set Device IP	55
Automatic "Set Device IP" by DHCP/BootP/RARP	55
Configuring DHCP Relay Agent	56
Using Diagnosis	58
Mirror Port	58
Ping	59
LLDP Function	59
Overview	59
Configuring LLDP Settings	59
Using Monitor	60
Monitor by Switch	60
Monitor by Port	61
Monitor by SFP	61
Using the MAC Address Table	62
Using Event Log	63
Using Syslog	64
Using HTTPS/SSL	64
4. EDS Configurator GUI	1
Starting EDS Configurator	2
Broadcast Search	2
Search by IP Address	3
Upgrade Firmware	3
Modify IP Address	4
Export Configuration	4
Import Configuration	5
Unlock Server	6
A. MIB Groups	1

About this Manual

Thank you for purchasing a Moxa managed Ethernet switch. Read this user's manual to learn how to connect your Moxa switch to Ethernet-enabled devices used for industrial applications.

The following two chapters are covered in this user manual:

□ **Getting Started**

This chapter explains how the initial installation process for Moxa switch. There are three ways to access Moxa switch's configuration settings: the serial console, Telnet console, and web console.

□ **Featured Functions**

This chapter explains how to access Moxa switch's various configuration, monitoring, and administration functions. These functions can be accessed by serial, Telnet, or web console. The web console is the most user-friendly way to configure Moxa switch. In this chapter, we use the web console interface to introduce the functions.

2

Getting Started

In this chapter we explain how to install a Moxa switch for the first time. There are three ways to access the Moxa switch's configuration settings: serial console, Telnet console, or web console. If you do not know the Moxa switch's IP address, you can open the serial console by connecting the Moxa switch to a PC's COM port with a short serial cable. You can open the Telnet or web console over an Ethernet LAN or over the Internet.

The following topics are covered in this chapter:

- ❑ **Serial Console Configuration (115200, None, 8, 1, VT100)**
- ❑ **Configuration by Telnet Console**
- ❑ **Configuration by Web Browser**
- ❑ **Disabling Telnet and Browser Access**

Serial Console Configuration (115200, None, 8, 1, VT100)

NOTE

- You cannot connect to the serial and Telnet console at the same time.
- You can connect to the web console and another console (serial or Telnet) at the same time. However, we strongly recommend that you do NOT do so. Following this advice will allow you to maintain better control over the Moxa switch’s configuration.

NOTE We recommend **using PComm Terminal Emulator** when opening the serial console. This software can be downloaded free of charge from the Moxa website.

Before running PComm Terminal Emulator, use an RJ45 to DB9-F (or RJ45 to DB25-F) cable to connect the Moxa switch’s console port to your PC’s COM port (generally COM1 or COM2, depending on how your system is set up).

After installing PComm Terminal Emulator, open the Moxa switch’s serial console as follows:

1. From the Windows desktop, click **Start → Programs → PComm Lite 1.3 → Terminal Emulator**.

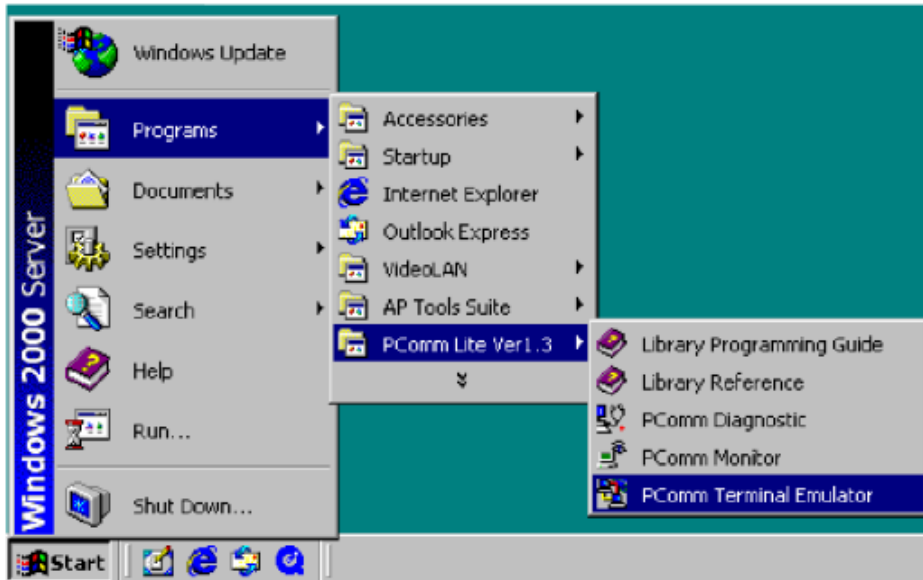

2. Select **Open** under the **Port Manager** menu to open a new connection.

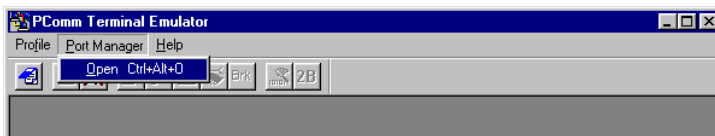

3. The **Property** window should open. On the **Communication Parameter** tab for **Ports**, select the COM port that is being used for the console connection. Set the other fields as follows: **115200** for **Baud Rate**, **8** for **Data Bits**, **None** for **Parity**, and **1** for **Stop Bits**.

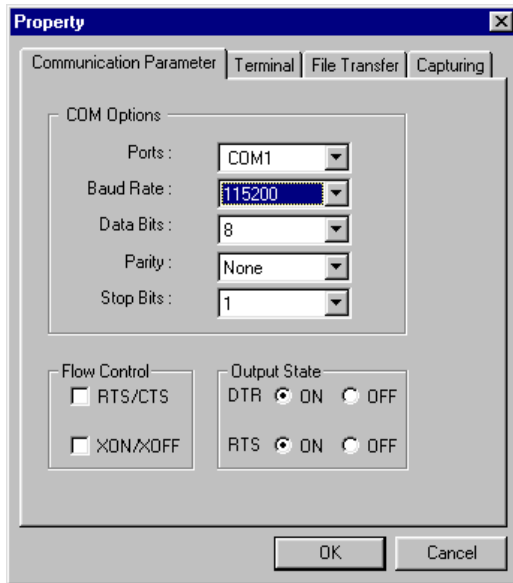

4. On the **Terminal** tab, select **VT100** for **Terminal Type**, and then click **OK** to continue.

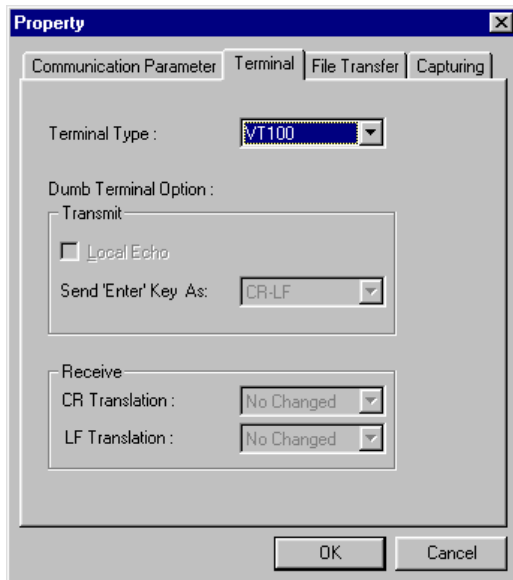

5. In the terminal window, the Moxa switch will prompt you to select a terminal type. Enter **1** to select **ansi/vt100** and then press **Enter**.

```
MOXA EtherDevice Switch IKS-6726
Console terminal type (1: ansi/vt100, 2: vt52) : 1
```

- The serial console will prompt you to log in. Press **Enter** and select **admin** or **user**. Use the down arrow key on your keyboard to select the **Password** field and enter a password if desired. This password will be required to access any of the consoles (web, serial, Telnet). If you do not wish to create a password, leave the **Password** field blank and press **Enter**.

```

Model :          IKS-6726-T
Name :          Managed Redundant Switch 02678
Location :      Switch Location

Firmware Version : V2.6
Serial No :     02678
IP :           192.168.127.253
MAC Address :   00-90-E8-1B-55-24

+-----+
|-----| admin |---+
| Account : [admin]| user | |
| Password : +-----+ |
+-----+
    
```

- The **Main Menu** of the Moxa switch’s serial console should appear. (In PComm Terminal Emulator, you can adjust the font by selecting **Font...** from the **Edit** menu.)

```

-----
                                IKS-6726 series V1.0
-----

1.Basic Settings      - Basic settings for network and system parameter.
2.Port Trunking       - Allows multiple ports to be aggregated as a link.
3.SNMP Settings      - The settings for SNMP.
4.Comm. Redundancy    - Establish Ethernet communication redundant path.
5.Traffic Prioritization- Prioritize Ethernet traffic to help determinism.
6.Virtual LAN         - Set up a VLAN by IEEE802.1Q VLAN or Port-based VLAN.
7.Multicast Filtering - Enable the multicast filtering capability.
8.Bandwidth Management - Restrict unpredictable network traffic.
9.Port Access Control - Port access control by IEEE802.1X or Static Port Lock.
a.Auto Warning        - Warning email and/or relay output by events.
b.Line Swap           - Fast recovery after moving devices to different ports.
c.Set Device IP       - Assign IP addresses to connected devices.
d.Diagnosis           - Test network integrity and mirroring port.
e.Monitor             - Monitor a port and network status.
f.MAC Address Table   - The complete table of Ethernet MAC Address List.
g.System log          - The setting for System log, and Event log.
h.Exit                - Exit
                    - Use the up/down arrow keys to select a category,
                    and then press Enter to select. -
    
```

- Use the following keys on your keyboard to navigate the Moxa switch’s serial console:

Key	Function
Up, down, right, left arrow keys, Tab	Move the onscreen cursor
Enter	Display and select options
Space	Toggle options
Esc	Previous menu

Configuration by Telnet Console

Opening the Moxa switch’s Telnet or web console over a network requires that the PC host and Moxa switch are on the same logical subnet. You may need to adjust your PC host’s IP address and subnet mask. By default, the Moxa switch’s IP address is 192.168.127.253 and the Moxa switch’s subnet mask is 255.255.255.0 (referred to as a Class B network). Your PC’s IP address must be set to 192.168.xxx.xxx if the subnet mask is 255.255.0.0, or to 192.168.127.xxx if the subnet mask is 255.255.255.0.

NOTE To connect to the Moxa switch's Telnet or web console, your PC host and the Moxa switch must be on the same logical subnet.

NOTE When connecting to the Moxa switch's Telnet or web console, first connect one of the Moxa switch's Ethernet ports to your Ethernet LAN, or directly to your PC's Ethernet port. You may use either a straight-through or cross-over Ethernet cable.

NOTE The Moxa switch's default IP address is 192.168.127.253.

After making sure that the Moxa switch is connected to the same LAN and logical subnet as your PC, open the Moxa switch's Telnet console as follows:

1. Click **Start → Run** from the Windows Start menu and then Telnet to the Moxa switch's IP address from the Windows **Run** window. You may also issue the Telnet command from a DOS prompt.

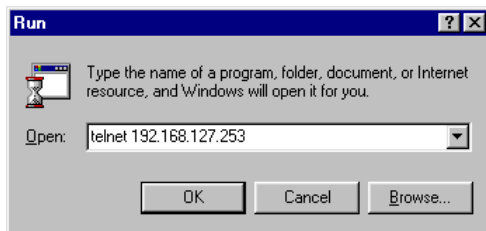

2. In the terminal window, the Telnet console will prompt you to select a terminal type. Type **1** to choose **ansi/vt100**, and then press **Enter**.

```
MOXA EtherDevice Switch IKS-6726
Console terminal type (1: ansi/vt100, 2: vt52) : 1
```

3. The Telnet console will prompt you to log in. Press **Enter** and then select **admin** or **user**. Use the down arrow key on your keyboard to select the **Password** field and enter a password if desired. This password will be required to access any of the consoles (web, serial, Telnet). If you do not wish to create a password, leave the **Password** field blank and press **Enter**.

```
Model :          IKS-6726
Name :          Managed Redundant Switch 00000
Location :      Switch Location

Firmware Version : V1.0
Serial No :     00000
IP :           192.168.127.253
MAC Address :   00-90-E8-00-67-26

+-----+
+-----+ | admin | +-----+
| Account : [admin] | user | |
| Password :      +-----+ |
+-----+ +-----+ +-----+
```

- The **Main Menu** of the Moxa switch's Telnet console should appear.

```

IKS-6726 series V1.0
-----
1.Basic Settings      - Basic settings for network and system parameter.
2.Port Trunking       - Allows multiple ports to be aggregated as a link.
3.SNMP Settings      - The settings for SNMP.
4.Comm. Redundancy    - Establish Ethernet communication redundant path.
5.Traffic Prioritization- Prioritize Ethernet traffic to help determinism.
6.Virtual LAN         - Set up a VLAN by IEEE802.1Q VLAN or Port-based VLAN.
7.Multicast Filtering - Enable the multicast filtering capability.
8.Bandwidth Management - Restrict unpredictable network traffic.
9.Port Access Control - Port access control by IEEE802.1X or Static Port Lock.
a.Auto Warning        - Warning email and/or relay output by events.
b.Line Swap           - Fast recovery after moving devices to different ports.
c.Set Device IP       - Assign IP addresses to connected devices.
d.Diagnosis           - Test network integrity and mirroring port.
e.Monitor             - Monitor a port and network status.
f.MAC Address Table   - The complete table of Ethernet MAC Address List.
g.System log          - The setting for System log, and Event log.
h.Exit               - Exit
                    - Use the up/down arrow keys to select a category,
                    and then press Enter to select. -
    
```

- In the terminal window, select **Preferences...** from the **Terminal** menu on the menu bar.
- The **Terminal Preferences** window should appear. Make sure that **VT100 Arrows** is checked.

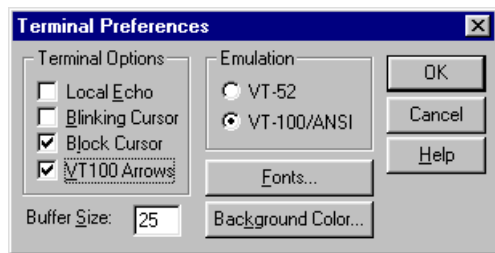

- Use the following keys on your keyboard to navigate inside the Moxa switch's Telnet console:

Key	Function
Up, down, right, left arrow keys,	Move the onscreen cursor
Tab	
Enter	Display and select options
Space	Toggle options
Esc	Previous menu

NOTE The Telnet console looks and operates in precisely the same manner as the serial console.

Configuration by Web Browser

The Moxa switch's web console is a convenient platform for modifying the configuration and accessing the built-in monitoring and network administration functions. You can open the Moxa switch's web console using a standard web browser, such as Internet Explorer.

NOTE To connect to the Moxa switch's Telnet or web console, your PC host and the Moxa switch must be on the same logical subnet.

NOTE If the Moxa switch is configured for other VLAN settings, you must make sure your PC host is on the management VLAN.

NOTE When connecting to the Moxa switch's Telnet or web console, first connect one of the Moxa switch's Ethernet ports to your Ethernet LAN, or directly to your PC's Ethernet port. You may use either a straight-through or cross-over Ethernet cable.

NOTE The Moxa switch's default IP address is 192.168.127.253.

After making sure that the Moxa switch is connected to the same LAN and logical subnet as your PC, open the Moxa switch's web console as follows:

1. Connect your web browser to the Moxa switch's IP address by entering it in the **Address** or **URL** field.

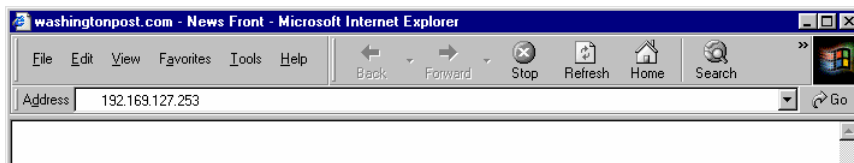

2. The Moxa switch's web console will open, and you will be prompted to log in. Select the login account (admin or user) and enter the **Password**. This password will be required to access any of the consoles (web, serial, Telnet). If you do not wish to create a password, leave the **Password** field blank and press **Enter**.

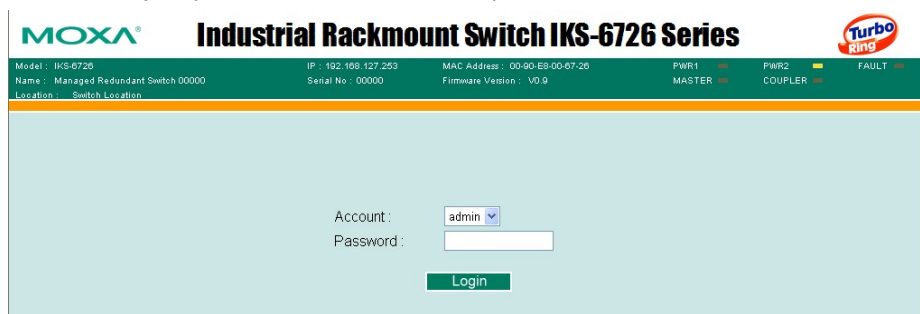

NOTE By default, no password is assigned to the Moxa switch's web, serial, and Telnet consoles.

3. After logging in, you may need to wait a few moments for the web console to appear. Use the folders in the left navigation panel to navigate between different pages of configuration options.

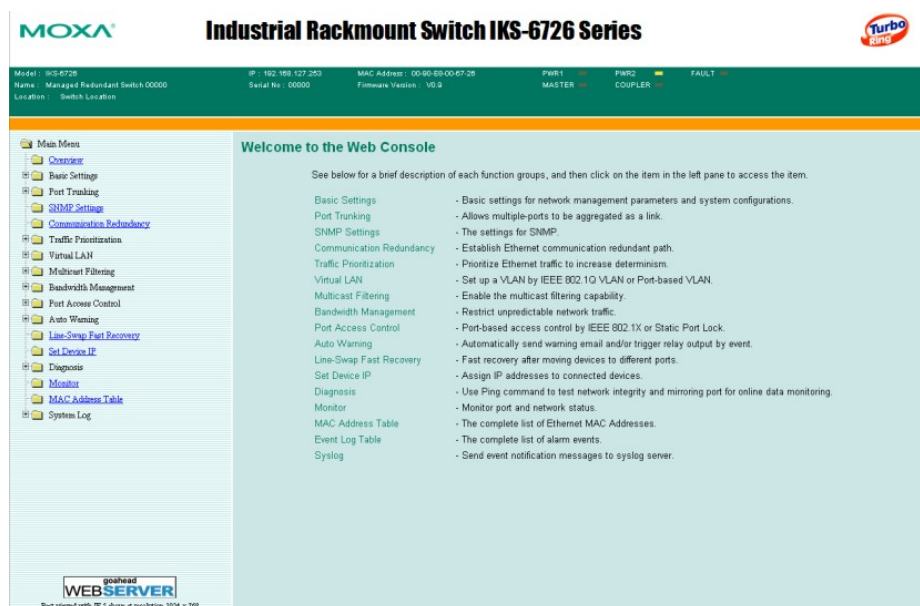

Disabling Telnet and Browser Access

If you are connecting the Moxa switch to a public network but do not intend to manage it over the network, we suggest disabling both the Telnet and web consoles. This is done from the serial console by navigating to **System Identification** under **Basic Settings**. Disable or enable the **Telnet Console** and **Web Configuration** as shown below:

```

MOXA EtherDevice Switch IKS-6726-T
Basic Settings
[System] [Password] [Accessible IP] [Port] [Network] [Time] [Backup Media]
[Restart] [Factory default] [Upgrade] [Activate] [Main menu]
System Identification
ESC: Previous menu  Enter: Select  Space bar: Toggle

Switch Name           [6726-252           ]
Switch Location        [Switch Location    ]
                       ]
Switch Description     [MOXA IKS-6726-T   ]
Maintainer Contact Info [                    ]

Serial NO.             02678
Firmware Version       V2.6
MAC Address             00-90-E8-1B-55-24

Telnet Console         [Enable ]
Web Configuration     [http or https]
Web Auto-logout (s)   [0       ]

```

Featured Functions

In this chapter, we explain how to access the Moxa switch's various configuration, monitoring, and administration functions. These functions can be accessed by serial, Telnet, or web console. The serial console can be used if you do not know the Moxa switch's IP address and requires that you connect the Moxa switch to a PC COM port. The Telnet and web consoles can be opened over an Ethernet LAN or the Internet.

The web console is the most user-friendly interface for configuring a Moxa switch. In this chapter, we use the web console interface to introduce the functions. There are only a few differences between the web console, serial console, and Telnet console.

The following topics are covered in this chapter:

- Configuring Basic Settings**
- Using Port Trunking**
- Configuring SNMP**
- Using PoE (PoE Models Only)**
- Using Traffic Prioritization**
- Using Virtual LAN**
- Using Multicast Filtering**
- Using Bandwidth Management**
-
- Using Port Access Control**
- Using Auto Warning**
- Using Line-Swap-Fast-Recovery**
- Using Set Device IP**
- Using Diagnosis**
- Using Monitor**
- Using the MAC Address Table**
- Using Event Log**
- Using Syslog**
- Using HTTPS/SSL**

Configuring Basic Settings

The **Basic Settings** section includes the most common settings required by administrators to maintain and control a Moxa switch.

System Identification

System Identification items are displayed at the top of the web console and will be included in alarm emails. You can configure the System Identification items to make it easier to identify different switches that are connected to your network.

Switch Name

Setting	Description	Factory Default
Max. 30 characters	This option is useful for differentiating between the roles or applications of different units. Example: Factory Switch 1.	Managed Redundant Switch [Serial no. of this switch]

Switch Location

Setting	Description	Factory Default
Max. 80 characters	This option is useful for differentiating between the locations of different units. Example: production line 1.	Switch Location

Switch Description

Setting	Description	Factory Default
Max. 30 characters	This option is useful for recording a more detailed description of the unit.	None

Maintainer Contact Info

Setting	Description	Factory Default
Max. 30 characters	This option is useful for providing information about who is responsible for maintaining this unit and how to contact this person.	None

Web Auto-logout (S)

Setting	Description	Factory Default
60 to 86400 (seconds)	Disable or extend the auto-logout time for the web management console.	0 (disable)

Age Time (S)

Setting	Description	Factory Default
15 to 3825 (seconds)	The length of time that a MAC address entry can remain in the Moxa switch. When an entry reaches its aging time, it "ages out" and is purged from the switch, effectively cancelling frame forwarding to that specific port.	300

Jumbo Frame

Setting	Description	Factory Default
Enable	Enables the Moxa switch to support the Jumbo Frame function	Disable
Disable	Disables the Jumbo Frame function	

Jumbo Frame MAX (bytes)

Setting	Description	Factory Default
1522 to 9000	The maximum length supported by the Jumbo Frame function	9000

Note: "Jumbo Frame" is supported by the IKS-G6000 series and the ICS-G7000 Series.

Password

The Moxa switch provides two levels of configuration access. The **admin** account has read/write access of all configuration parameters, and the **user** account has read access only. A **user** account can view the configuration, but will not be able to make modifications.

**ATTENTION**

By default, a password is not assigned to the Moxa switch's web, Telnet, and serial consoles. If a password is assigned, you will be required to enter the password when you open the serial console, Telnet console, or Web console.

Account

Setting	Description	Factory Default
Admin	This account can modify the Moxa switch's configuration.	admin
User	This account can only view the Moxa switch's configurations.	

Password

Setting	Description	Factory Default
Old password (max. 16 characters)	Enter the current password	None
New password (Max. 16 characters)	Enter the desired new password. Leave it blank if you want to remove the password.	None
Retype password (Max. 16 characters)	Enter the desired new password again. Leave it blank if you want to remove the password.	None

Accessible IP List

The Moxa switch uses an IP address-based filtering method to control access.

Accessible IP List

Enable the accessible IP list ("Disable" will allow all IP's connection)

Index	IP	NetMask
1		
2		
3		
4		
5		
6		
7		
8		
9		
10		

Activate

You may add or remove IP addresses to limit access to the Moxa switch. When the accessible IP list is enabled, only addresses on the list will be allowed access to the Moxa switch. Each IP address and netmask entry can be tailored for different situations:

- Grant access to one host with a specific IP address**

For example, enter IP address 192.168.1.1 with netmask 255.255.255.255 to allow access to 192.168.1.1 only.
- Grant access to any host on a specific subnetwork**

For example, enter IP address 192.168.1.0 with netmask 255.255.255.0 to allow access to all IPs on the subnet defined by this IP address/subnet mask combination.
- Grant access to all hosts**

Make sure the accessible IP list is not enabled. Remove the checkmark from **Enable the accessible IP list**.

The following table shows additional configuration examples:

Hosts That Need Access	Input Format
Any host	Disable
192.168.1.120	192.168.1.120 / 255.255.255.255
192.168.1.1 to 192.168.1.254	192.168.1.0 / 255.255.255.0
192.168.0.1 to 192.168.255.254	192.168.0.0 / 255.255.0.0
192.168.1.1 to 192.168.1.126	192.168.1.0 / 255.255.255.128
192.168.1.129 to 192.168.1.254	192.168.1.128 / 255.255.255.128

Port Settings

Port settings are included to give the user control over port access, port transmission speed, flow control, and port type (MDI or MDIX).

Enable

Setting	Description	Factory Default
Checked	Allows data transmission through the port.	Enabled
Unchecked	Immediately shuts off port access.	



ATTENTION

If a connected device or sub-network is wreaking havoc on the rest of the network, the **Disable** option under **Advanced Settings/Port** gives the administrator a quick way to shut off access through this port immediately.

Description

Setting	Description	Factory Default
Media type	Displays the media type for each module's port	N/A

Name

Setting	Description	Factory Default
Max. 63 characters	Specifies an alias for the port to help administrators differentiate between different ports. Example: PLC 1	None

Speed

Setting	Description	Factory Default
Auto	Allows the port to use the IEEE 802.3u protocol to negotiate with connected devices. The port and connected devices will determine the best speed for that connection.	Auto
1G-Full	Choose one of these fixed speed options if the connected Ethernet device has trouble auto-negotiating for line speed.	
100M-Full		
100M-Half		
10M-Full		
10M-Half		

FDX Flow Ctrl

This setting enables or disables flow control for the port when the port’s Speed is set to Auto. The final result will be determined by the Auto process between the Moxa switch and connected devices.

Setting	Description	Factory Default
Enable	Enables flow control for this port when the port’s Speed is set to Auto.	Disable
Disable	Disables flow control for this port when the port’s Speed is set to Auto.	

MDI/MDIX

Setting	Description	Factory Default
Auto	Allows the port to auto-detect the port type of the connected Ethernet device and change the port type accordingly.	Auto
MDI	Choose MDI or MDIX if the connected Ethernet device has	
MDIX	trouble auto-negotiating for port type.	

Network Parameters

Network configuration allows users to configure both IPv4 and IPv6 parameters for management access over the network. The Moxa switch supports both IPv4 and IPv6, and can be managed through either of these address types.

A brief explanation of each configuration item is given below.

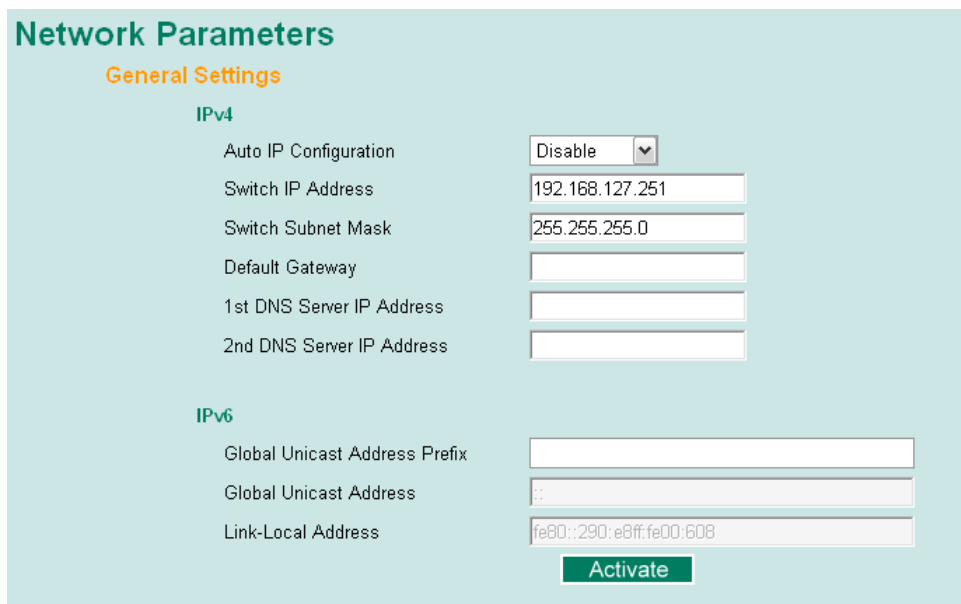

IP4

The IPv4 settings include the switch’s IP address and subnet mask, as well as the IP address of the default gateway. In addition, input cells are provided for the IP addresses of a 1st and 2nd DNS server.

Auto IP Configuration

Setting	Description	Factory Default
Disable	The Moxa switch’s IP address must be set manually.	Disable
By DHCP	The Moxa switch’s IP address will be assigned automatically by the network’s DHCP server.	
By BootP	The Moxa switch’s IP address will be assigned automatically by the network’s BootP server.	

Switch IP Address

Setting	Description	Factory Default
IP address for the Moxa switch	Assigns the Moxa switch's IP address on a TCP/IP network.	192.168.127.253

Switch Subnet Mask

Setting	Description	Factory Default
Subnet mask for the Moxa switch	Identifies the type of network the Moxa switch is connected to (e.g., 255.255.0.0 for a Class B network, or 255.255.255.0 for a Class C network).	255.255.255.0

Default Gateway

Setting	Description	Factory Default
IP address for gateway	Specifies the IP address of the router that connects the LAN to an outside network.	None

DNS IP Address

Setting	Description	Factory Default
IP address for DNS server	Specifies the IP address of the DNS server used by your network. After specifying the DNS server's IP address, you can use the Moxa switch's URL (e.g., www.PT.company.com) to open the web console instead of entering the IP address.	None
IP address for 2nd DNS server	Specifies the IP address of the secondary DNS server used by your network. The Moxa switch will use the secondary DNS server if the first DNS server fails to connect.	None

IP6

The IPv6 settings include two distinct address types—Link-Local Unicast addresses and Global Unicast addresses. A Link-Local address makes the switch accessible over IPv6 for all devices attached to the same local subnet. To connect to a larger network with multiple segments, the switch must be configured with a Global Unicast address.

Global Unicast Address Prefix (Prefix Length: 64 bits) Default Gateway

Setting	Description	Factory Default
Global Unicast Address Prefix	The prefix value must be formatted according to the RFC 2373 "IPv6 Addressing Architecture," using 8 colon-separated 16-bit hexadecimal values. One double colon may be used in the address to indicate the appropriate number of zeros required to fill the undefined fields.	None

Global Unicast Address

Setting	Description	Factory Default
None	Displays the IPv6 Global Unicast address. The network portion of the Global Unicast address can be configured by specifying the Global Unicast Prefix and using an EUI-64 interface ID in the low order 64 bits. The host portion of the Global Unicast address is automatically generated using the modified EUI-64 form of the interface identifier (Switch's MAC address).	None

Link-Local Address

Setting	Description	Factory Default
None	The network portion of the Link-Local address is FE80 and the host portion of the Link-Local address is automatically generated using the modified EUI-64 form of the interface identifier (Switch's MAC address)	None

Neighbor Cache

IPv6 Address	Link Layer (MAC) Address	State
fe80::290:e8ff:fe0e:e02	00-90-e8-0e-0e-02	Reachable

Neighbor Cache

Setting	Description	Factory Default
None	The information in the neighbor cache that includes the neighboring node’s IPv6 address, the corresponding Link-Layer address, and the current state of the entry.	None

System Time Settings

System Time Settings

Current Time: -- : -- : -- (ex: 04:00:04)

Current Date: --- / -- / -- (ex: 2002/11/13)

Daylight Saving Time: Month Week Day Hour

Start Date: -- / -- / --

End Date: -- / -- / --

Offset: 0 hour(s)

Activate

System Up Time: 5d17h22m23s

Time Zone: (GMT)Greenwich Mean Time: Dublin, Edinburgh, Lisbon, London

1st Time Server IP/Name: time.nist.gov

2nd Time Server IP/Name:

Enable NTP/SNTP Server

Activate

The Moxa switch has a time calibration function based on information from an NTP server or user specified time and date. Functions such as automatic warning emails can therefore include time and date stamp.

NOTE The Moxa switch does not have a real time clock. The user must update the Current Time and Current Date to set the initial time for the Moxa switch after each reboot, especially when there is no NTP server on the LAN or Internet connection.

Current Time

Setting	Description	Factory Default
User-specified time	Allows configuration of the local time in local 24-hour format.	None

Current Date

Setting	Description	Factory Default
User-specified date	Allows configuration of the local date in yyyy-mm-dd format.	None

Daylight Saving Time

The Daylight Saving Time settings are used to automatically set the Moxa switch’s time forward according to national standards.

Start Date

Setting	Description	Factory Default
User-specified date	Specifies the date that Daylight Saving Time begins.	None

End Date

Setting	Description	Factory Default
User-specified date	Specifies the date that Daylight Saving Time ends.	None

Offset

Setting	Description	Factory Default
User-specified hour	Specifies the number of hours that the time should be set forward during Daylight Saving Time.	None

System Up Time

Indicates how long the Moxa switch remained up since the last cold start. The up time is indicated in seconds.

Time Zone

Setting	Description	Factory Default
Time zone	Specifies the time zone, which is used to determine the local time offset from GMT (Greenwich Mean Time).	GMT (Greenwich Mean Time)

NOTE Changing the time zone will automatically correct the current time. Be sure to set the time zone before setting the time.

Time Server IP/Name

Setting	Description	Factory Default
IP address or name of time server	The IP or domain address (e.g., 192.168.1.1, time.stdtime.gov.tw, or time.nist.gov).	None
IP address or name of secondary time server	The Moxa switch will try to locate the secondary NTP server if the first NTP server fails to connect.	

Time Server Query Period

Setting	Description	Factory Default
Query period	This parameter determines how frequently the time is updated from the NTP server.	600 seconds

Enable NTP/SNTP Server

Setting	Description	Factory Default
Enable/Disable	Enables SNTP/NTP server functionality for clients	Disabled

IEEE 1588 PTP

The following information is taken from the NIST website at <http://ieee1588.nist.gov/intro.htm>:

"Time measurement can be accomplished using the IEEE Standard for a Precision Clock Synchronization Protocol for Networked Measurement and Control Systems (IEEE 1588-2008) to synchronize real-time clocks incorporated within each component of the electrical power system for power automation applications.

IEEE 1588, which was published in November 2002, expands the performance capabilities of Ethernet networks to control systems that operate over a communication network. In recent years an increasing number of electrical power systems have been using a more distributed architecture with network technologies that have less stringent timing specifications. IEEE 1588 generates a master-slave relationship between the clocks, and enforces the specific timing requirements in such power systems. All devices ultimately get their time from a clock known as the grandmaster clock. In its basic form, the protocol is intended to be administration free."

How does an Ethernet Switch Affect 1588 Synchronization?

The following content is taken from the NIST website at <http://ieee1588.nist.gov/switch.htm>:

"An Ethernet switch potentially introduces multi-microsecond fluctuations in the latency between the 1588 grandmaster clock and a 1588 slave clock. Uncorrected these fluctuations will cause synchronization errors. The magnitude of these fluctuations depend on the design of the Ethernet switch and the details of the communication traffic. Experiments with prototype implementations of IEEE 1588 indicate that with suitable care the effect of these fluctuations can be successfully managed. For example, use of appropriate statistics in

the 1588 devices to recognize significant fluctuations and use suitable averaging techniques in the algorithms controlling the correction of the local 1588 clock will be the good design means to achieve the highest time accuracy.”

Can Ethernet switches be designed to avoid the effects of these fluctuations?

A switch can be designed to support IEEE 1588 while avoiding the effects of queuing. In this case two modifications to the usual design of an Ethernet switch are necessary:

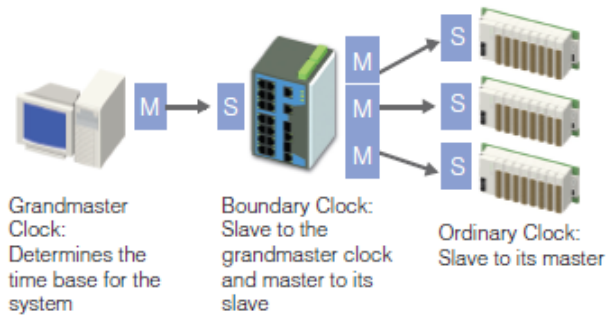

1. The **Boundary Clock and Transparent Clock** functionalities defined by IEEE 1588 must be implemented in the switch.
2. The switch must be configured such that it does not pass IEEE 1588 message traffic using the normal communication mechanisms of the switch.

Such an Ethernet switch will synchronize clocks directly connected to one of its ports to the highest possible accuracy.

NOTE If the CM-600-4TX-PTP module is not installed, then the EDS-600 only supports software-based IEEE 1588.

Configuring PTP

PTP Setting

IEEE 1588/PTP Operation
 Operation Enable PTP

IEEE 1588/PTP Configuration

Clock Mode: v2 E2E BC

logSyncInterval: 0 (1 sec)

logAnnounceInterval: 1 (2 sec)

announceReceiptTimeout: 3

logMinDelayReqInterval: 0 (1 sec)

Domain Number: 0 (_DFLT)

Transport of PTP: IPv4

priority1: 128

priority2: 128

clockClass: 248

clockAccuracy: 0x21

Timescale: PTP

ARB Time: 0

Leap59: False

Leap61: False

UTC Offset Valid: False

UTC Offset: 0

Status

Current Data Set
 Offset To Master(nsec)
 Mean Path Delay(nsec)
 Step Removed

Parent Data Set
 Parent Identity
 Grandmaster Identity
 Grandmaster clockClass
 Grandmaster clockAccuracy
 Grandmaster priority1
 Grandmaster priority2

Parent Time Data Set
 Current UTC Offset Valid
 Current UTC Offset
 Leap59
 Leap61
 Timescale
 Time Source

PTP Port Settings

Port	Port Enable	Port Status
1-1	<input type="checkbox"/> Enable	PTP_DISABLED
1-2	<input type="checkbox"/> Enable	PTP_DISABLED
1-3	<input type="checkbox"/> Enable	PTP_DISABLED
1-4	<input type="checkbox"/> Enable	PTP_DISABLED
2-1	<input type="checkbox"/> Enable	PTP_DISABLED

Activate

IEEE 1588/PTP Operation**Operation**

Setting	Description	Factory Default
Enable PTP	Globally disables or enables IEEE 1588 operation.	Disabled

IEEE 1588/PTP Configuration**Clock Mode (sets the switch's clock mode)**

Setting	Description	Factory Default
v1 BC	Operates as an IEEE 1588 v1 boundary clock.	v1 BC
v2 E2E 2-step TC	Operates as an edge-to-edge IEEE 1588 v2 transparent clock with 2-step method.	
v2 E2E 1-step TC	Operates as an edge-to-edge IEEE 1588 v2 transparent clock with 1-step method.	
v2 P2P 2-step TC	Operates as a peer-to-peer IEEE 1588 v2 transparent clock with 1-step method.	
v2 E2E BC	Operates as an edge-to-edge IEEE 1588 v2 boundary clock	
v2 P2P BC	Operates as a peer-to-peer IEEE 1588 v2 boundary clock	

logSyncInterval (sets the synchronization message time interval)

Setting	Description	Factory Default
0, 1, 2, 3, or 4	0 (1 s), 1 (2 s), 2 (4 s), 3 (8 s), or 4 (16 s). Supported in IEEE 1588 V1.	0
-3, -2, -1, 0, or 1	-3 (128 ms), -2 (256 ms), -1 (512 ms), 0 (1 s), or 1 (2 s). Supported in IEEE 1588 V2.	

logAnnounceInterval (sets the announce message interval)

Setting	Description	Factory Default
0, 1, 2, 3, or 4	0 (1 s), 1 (2 s), 2 (4 s), 3 (8 s), or 4 (16 s)	1 (2 s)

announceReceiptTimeout

Setting	Description	Factory Default
2, 3, 4, 5, 6, 7, 8, 9, or 10	The multiple of announce message receipt timeout by the announce message interval.	3

logMinDelayReqInterval

Setting	Description	Factory Default
0, 1, 2, 3, 4, or 5	Minimum delay request message interval	0 (1 sec.)

logMinPdelayReqInterval

Setting	Description	Factory Default
1, 0, 1, 2, 3, or 4	Minimal delay request message interval: -1 (512 ms), 0 (1 s), 1 (2 s), 2 (4 s), 3 (8 s), or 4 (32 s) (Available in Clock Mode: v2 P2P 2-step TC, and v2 P2P BC)	0 (1 sec)

Domain Number

Setting	Description	Factory Default
_DFLT (0), _ALT(1), _ALT(2), or _ALT(3)	Subdomain name (IEEE 1588-2002) or the domain Number (IEEE 1588-2008) fields in PTP messages	_DFLT (0)

Transport of PTP (transport protocol of an IEEE 1588 PTP message)

Setting	Description	Factory Default
IPv4 or 802.3/Ethernet	<ul style="list-style-type: none"> IEEE 1588 PTP V1 supports IPv4 only IEEE 1588 PTP V2 supports both IPv4 and IPv6. 	IPv4

Preferred Master

Setting	Description	Factory Default
True or False	Set this switch to be the Grand Master.	False

priority1

Setting	Description	Factory Default
0 to 255	Set first priority value; 0 = highest priority, 255 = lowest priority.	128

priority2

Setting	Description	Factory Default
0 to 255	Set second priority value; 0 = highest priority, 255 = lowest priority.	128

clockClass

Setting	Description	Factory Default
0 to 255	The clockClass attribute denotes the traceability of the time or frequency distributed by the grandmaster clock.	248

clockAccuracy

Setting	Description	Factory Default
0x21	The clockAccuracy characterizes a clock for the purpose of the best master clock (BMC) algorithm. This value is fixed at 0x21, which means the time of the EDS switch is accurate to within 100 ns.	0x21

Timescale

Setting	Description	Factory Default
PTP or ARB	<ul style="list-style-type: none"> PTP timescale: In normal operation, the epoch is the PTP epoch and the timescale is continuous. The time unit is SI seconds, as realized on the rotating geoid (SI: International System). ARB timescale: In normal operation, the epoch is set by an administrative procedure. The epoch can be reset during normal operation. Between invocations of the administrative procedure, the timescale is continuous. Additional invocations of the administrative procedure may introduce discontinuities in the overall timescale. 	PTP

ARB Time

Setting	Description	Factory Default
0 to 255	The geoid of the PTP clock reference time (seconds).	0

Leap59

Setting	Description	Factory Default
True or False	The last minute of the current UTC day contains 59 seconds. If the epoch is not PTP, the value will be set to FALSE.	False

Leap61

Setting	Description	Factory Default
True or False	The last minute of the current UTC day contains 61 seconds. If the epoch is not PTP, the value will be set to FALSE.	False

UTC Offset Valid

Setting	Description	Factory Default
True or False	The initialization value will be TRUE if the value of the current UTC offset is known to be correct; otherwise, it will be FALSE.	False

UTC Offset

Setting	Description	Factory Default
0 to 255	The known UTC offset (seconds).	0

Status

Setting	Description	Factory Default
N/A	Shows the current IEEE 1588 PTP status.	N/A

PTP Port Settings

Shows the switch's current PTP port settings.

System File Update

Update System Files by Remote TFTP

The Moxa switch supports saving your configuration or log file to a remote TFTP server or local host. Other Moxa switch switches can also load the configuration at a later time. The Moxa switch also supports loading firmware or configuration files from the TFTP server or a local host.

Update System Files by TFTP

TFTP Server IP/Name

Configuration Files Path and Name [Download](#) [Upload](#)

Firmware Files Path and Name [Download](#)

Log Files Path and Name [Upload](#)

TFTP Server IP/Name

Setting	Description	Factory Default
IP address of TFTP server	Specifies the IP address or name of the remote TFTP server. Must be specified before downloading or uploading files.	None

Configuration Files Path and Name

Setting	Description	Factory Default
Max. 40 characters	Specifies the path and file name of the Moxa switch's configuration file on the TFTP server.	None

Firmware Files Path and Name

Setting	Description	Factory Default
Max. 40 characters	Specifies the path and file name of the Moxa switch's firmware file.	None

Log Files Path and Name

Setting	Description	Factory Default
Max. 40 characters	Specifies the path and file name of the Moxa switch's log file.	None

After setting the desired paths and file names, click **Download** to download the prepared file from the remote TFTP server, or click **Upload** to upload the desired file to the remote TFTP server.

Update System Files from Local PC

Configuration File

Click **Export** to save the Moxa switch's configuration file to the local host.

Log File

Click **Export** to save the Moxa switch's log file to the local host.

NOTE Some operating systems will open the configuration file and log file directly in the web page. In such cases, right click the Export button to save the file.

Upgrade Firmware

To import a new firmware file into the Moxa switch, click **Browse** to select the firmware file that is saved on your computer. The upgrade procedure will proceed automatically after clicking **Import**.

Upload Configure Data

To import a configuration file into the Moxa switch, click **Browse** to select the configuration file already saved on your computer. The upgrade procedure will proceed automatically after clicking **Import**.

ABC (Auto-Backup Configurator) Configuration

You can use Moxa's Automatic Backup Configurator to save and load the Moxa switch's configurations through the switch's RS-232 console port.

Restart

This function provides users with a quick way to restart the system.

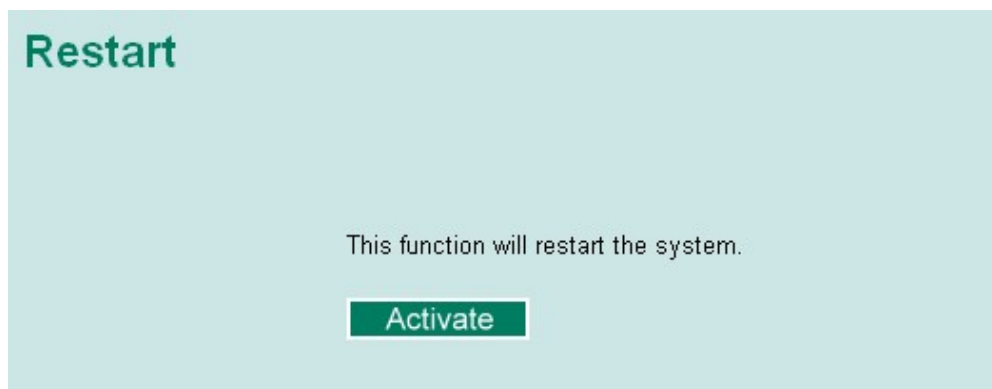

Reset to Factory Default

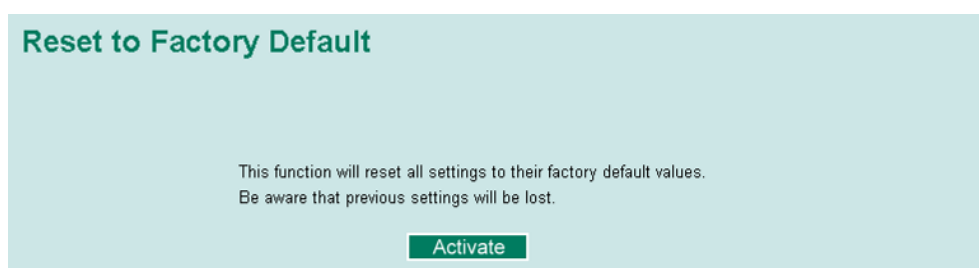

This function provides users with a quick way of restoring the Moxa switch's configuration to factory defaults. The function is available in the serial, Telnet, and web consoles.

NOTE After restoring the factory default configuration, you will need to use the default network settings to re-establish the web or Telnet console connection with the Moxa switch.

Using Port Trunking

Link aggregation involves grouping links into a link aggregation group. A MAC client can treat link aggregation groups as if they were a single link.

The Moxa switch's port trunking feature allows devices to communicate by aggregating up to 4 trunk groups, with a maximum of 8 ports for each group. If one of the 8 ports fails, the other seven ports will automatically provide backup and share the traffic.

Port trunking can be used to combine up to 8 ports between two Moxa switches. If all ports on both switches are configured as 100BaseTX and they are operating in full duplex, the potential bandwidth of the connection will be 1600 Mbps.

The Port Trunking Concept

Moxa has developed a port trunking protocol that provides the following benefits:

- Greater flexibility in setting up your network connections, since the bandwidth of a link can be doubled, tripled, or quadrupled.
- Redundancy—if one link is broken, the remaining trunked ports share the traffic within this trunk group.
- Load sharing—MAC client traffic can be distributed across multiple links.

To avoid broadcast storms or loops in your network while configuring a trunk, first disable or disconnect all ports that you want to add to the trunk or remove from the trunk. After you finish configuring the trunk, enable or re-connect the ports.

If all ports on both switch units are configured as 100BaseTX and they are operating in full duplex mode, the potential bandwidth of the connection will be up to 1.6 Gbps. This means that users can double, triple, or quadruple the bandwidth of the connection by port trunking between two Moxa switches.

Each Moxa switch can set a maximum of 3 port trunking groups. When you activate port trunking, certain settings on each port will be reset to factory default values or disabled:

- Communication redundancy will be reset
- 802.1Q VLAN will be reset
- Multicast Filtering will be reset
- Port Lock will be reset and disabled.
- Set Device IP will be reset
- Mirror will be reset

After port trunking has been activated, you can configure these items again for each trunking port.

Port Trunking Settings

The **Port Trunking Settings** page is where ports are assigned to a trunk group.

Step 1: Select the desired **Trunk Group**

Step 2: Select the **Trunk Type** (Static or LACP).

Step 3: Select the desired ports under **Available Ports** and click **Up** to add to the Trunk Group.

Step 4: Select the desired ports under **Member Ports** and click **Down** to remove from the group.

Trunk Group (maximum of 4 trunk groups)

Setting	Description	Factory Default
Trk1, Trk2, Trk3, Trk4 (depends on switching chip capability; some Moxa switches only support 3 trunk groups)	Specifies the current trunk group.	Trk1

Trunk Type

Setting	Description	Factory Default
Static	Selects Moxa's proprietary trunking protocol.	Static
LACP	Selects LACP (IEEE 802.3ad, Link Aggregation Control Protocol).	Static

Available Ports/Member Ports

Setting	Description	Factory Default
Member/available ports	Lists the ports in the current trunk group and the ports that are available to be added.	N/A
Check box	Selects the port to be added or removed from the group.	Unchecked
Port	How each port is identified.	N/A
Port description	Displays the media type for each port.	N/A
Name	Displays the specified name for each port.	N/A
Speed	Indicates the transmission speed for each port (100M-Full, 100M-Half, 10M-Full, or 10M-Half).	N/A
FDX flow control	Indicates if the FDX flow control of this port is enabled or disabled.	N/A
Up	Add selected ports into the trunk group from available ports.	N/A
Down	Remove selected ports from the trunk group.	N/A

Trunk Table

Trunk Group	Member Port	Status
Trk1 (Static)	1-1	Success
	1-2	Success
	1-3	Success

Trunk Table

Setting	Description
Trunk group	Displays the trunk type and trunk group.
Member port	Displays the member ports that belong to the trunk group.
Status	<ul style="list-style-type: none"> Success means port trunking is working properly. Fail means port trunking is not working properly. Standby means port trunking is working as a standby port. When there are more than eight ports trunked as a trunking group, the 9th port will be the standby port.

Configuring SNMP

The Moxa switch supports SNMP V1, V2c, and V3. SNMP V1 and SNMP V2c use a community string match for authentication, which means that SNMP servers access all objects with read-only or read/write permissions using the community strings *public* and *private* by default. SNMP V3 requires that you select an authentication level of MD5 or SHA, and is the most secure protocol. You can also enable data encryption to enhance data security.

Supported SNMP security modes and levels are shown in the following table. Select the security mode and level that will be used to communicate between the SNMP agent and manager.

Protocol Version	UI Setting	Authentication	Encryption	Method
SNMP V1, V2c	V1, V2c Read Community	Community string	No	Uses a community string match for authentication.
	V1, V2c Write/Read Community	Community string	No	Uses a community string match for authentication.
SNMP V3	No-Auth	No	No	Uses an account with admin or user to access objects
	MD5 or SHA	Authentication based on MD5 or SHA	No	Provides authentication based on HMAC-MD5, or HMAC-SHA algorithms. 8-character passwords are the minimum requirement for authentication.
	MD5 or SHA	Authentication based on MD5 or SHA	Data encryption key	Provides authentication based on HMAC-MD5 or HMAC-SHA algorithms, and data encryption key. 8-character passwords and a data encryption key are the minimum requirements for authentication .and encryption.

These parameters are configured on the SNMP page. A more detailed explanation of each parameter is given below the figure.

SNMP

SNMP Read/Write Settings

SNMP Versions	V1, V2c ▾
V1,V2c Read Community	public
V1,V2c Write/Read Community	private
Admin Auth. Type	No-Auth ▾
Admin Data Encryption Key	<input type="checkbox"/> <input style="width: 150px;" type="text"/>
User Auth. Type	No-Auth ▾
User Data Encryption Key	<input type="checkbox"/> <input style="width: 150px;" type="text"/>

Trap Settings

1st Trap Server IP/Name	<input style="width: 100%;" type="text"/>
1st Trap Community	public
2nd Trap Server IP/Name	<input style="width: 100%;" type="text"/>
2nd Trap Community	public

Trap Mode

Trap ▾	
Retries (1~99)	<input style="width: 50px;" type="text" value="1"/>
Timeout (1~300s)	<input style="width: 50px;" type="text" value="1"/>

Private MIB information

Switch Object ID	enterprise.8691.7.17
	<input type="button" value="Activate"/>

SNMP Read/Write Settings

SNMP Versions

Setting	Description	Factory Default
V1, V2c, V3, or V1, V2c, or V3 only	Specifies the SNMP protocol version used to manage the switch.	V1, V2c

V1, V2c Read Community

Setting	Description	Factory Default
Max. 30 characters	Specifies the community string to authenticate the SNMP agent for read-only access. The SNMP agent will access all objects with read-only permissions using this community string.	Public

V1, V2c Write/Read Community

Setting	Description	Factory Default
Max. 30 characters	Specifies the community string to authenticate the SNMP agent for read/write access. The SNMP server will access all objects with read/write permissions using this community string.	Private

For SNMP V3, two levels of privilege are available accessing the Moxa switch. **Admin** privilege provides access and authorization to read and write the MIB file. **User** privilege allows reading of the MIB file only.

Admin Auth. Type (for SNMP V1, V2c, V3, and V3 only)

Setting	Description	Factory Default
No-Auth	Allows the admin account to access objects without authentication.	No
MD5-Auth	Authentication will be based on the HMAC-MD5 algorithms. 8-character passwords are the minimum requirement for authentication.	No
SHA-Auth	Authentication will be based on the HMAC-SHA algorithms. 8-character passwords are the minimum requirement for authentication.	No

Admin Data Encryption Key (for SNMP V1, V2c, V3, and V3 only)

Setting	Description	Factory Default
Enable	Enables data encryption using the specified data encryption key (between 8 and 30 characters).	No
Disable	Specifies that data will not be encrypted.	No

User Auth. Type (for SNMP V1, V2c, V3 and V3 only)

Setting	Description	Factory Default
No-Auth	Allows the admin account and user account to access objects without authentication.	No
MD5-Auth	Authentication will be based on the HMAC-MD5 algorithms. 8-character passwords are the minimum requirement for authentication.	No
SHA-Auth	Authentication will be based on the HMAC-SHA algorithms. 8-character passwords are the minimum requirement for authentication.	No

User Data Encryption Key (for SNMP V1, V2c, V3 and V3 only)

Setting	Description	Factory Default
Enable	Enables data encryption using the specified data encryption key (between 8 and 30 characters).	No
Disable	No data encryption	No

Trap Settings

SNMP traps allow an SNMP agent to notify the NMS of a significant event. The switch supports two SNMP modes, **Trap** mode and **Inform** mode.

SNMP Trap Mode—Trap

In Trap mode, the SNMP agent sends an SNMPv1 trap PDU to the NMS. No acknowledgment is sent back from the NMS so the agent has no way of knowing if the trap reached the NMS.

SNMP Trap Mode—Inform

SNMPv2 provides an inform mechanism. When an inform message is sent from the SNMP agent to the NMS, the receiver sends a response to the sender acknowledging receipt of the event. This behavior is similar to that of the get and set requests. If the SNMP agent does not receive a response from the NMS for a period of time, the agent will resend the trap to the NMS agent. The maximum timeout time is 300 sec (default is 1 sec), and the maximum number of retries is 99 times (default is 1 time). When the SNMP agent receives acknowledgement from the NMS, it will stop resending the inform messages.

1st Trap Server IP/Name

Setting	Description	Factory Default
IP or name	Specifies the IP address or name of the primary trap server used by your network.	None

1st Trap Community

Setting	Description	Factory Default
Max. 30 characters	Specifies the community string to use for authentication.	Public

2nd Trap Server IP/Name

Setting	Description	Factory Default
IP or name	Specifies the IP address or name of the secondary trap server used by your network.	None

2nd Trap Community

Setting	Description	Factory Default
Max. 30 characters	Specifies the community string to use for authentication.	Public

Private MIB Information

Switch Object ID

Setting	Description	Factory Default
Specific Moxa Switch ID	Indicates the Moxa switch's enterprise value.	.8691.7.47

NOTE: The Switch Object ID cannot be changed.

Using PoE (PoE Models Only)

Power over Ethernet has become increasingly popular due in large part to the reliability provided by PoE Ethernet switches that supply the necessary power to Powered Devices (PD) when AC power is not readily available or cost-prohibitive to provide locally.

Power over Ethernet can be used with:

- Surveillance cameras
- Security I/O sensors
- Industrial wireless access points
- Emergency IP phones

In fact, it's not uncommon for video, voice, and high-rate industrial application data transfers to be integrated into one network. Moxa's PoE switches are equipped with many advanced PoE management functions, providing vital security systems with a convenient and reliable Ethernet network. Moreover, Moxa's advanced PoE switches support the high power PoE+ standard, 24 VDC direct power input, and 20 ms fast recovery redundancy, Turbo Ring and Turbo Chain.

PoE Setting

The settings are included to give the user control over the system's PoE power budget, PoE port access, PoE port power limit and PD failure check.

An explanation of each configuration item follows:

PoE Setting

PoE System Setting

PoE Power Budget: Auto | 120 W

Port Setting

Port Number	Enable	Power Limit	PD Failure Check
1	<input checked="" type="checkbox"/> Enable	Auto 30 Watt	<input type="checkbox"/> Enable IP Periods 10 Sec
2	<input checked="" type="checkbox"/> Enable	Auto 30 Watt	<input type="checkbox"/> Enable IP Periods 10 Sec
3	<input checked="" type="checkbox"/> Enable	Auto 30 Watt	<input type="checkbox"/> Enable IP Periods 10 Sec
4	<input checked="" type="checkbox"/> Enable	Auto 30 Watt	<input type="checkbox"/> Enable IP Periods 10 Sec

Activate

PoE Power Budget

Indicates the PoE power that can be supplied by the system.

Setting	Description	Factory Default
Auto	Allows users to set the actual Power Limit value by each individual PoE port.	Auto
Manual	The user can set the power limit value that indicates the power supplied by the system.	

Port Setting

Enable

Setting	Description	Factory Default
Checked	Allows data and power transmission through the port	Enable
Unchecked	Immediately shuts off port access	Enable

Power Limit

Setting	Description	Factory Default
Auto	The amount of power assigned is determined according to the class that is read from the powered device.	Auto
Manual	The user can set the power limit value that indicates the maximum amount of power available to the port.	Auto

The EDS-P506A-4PoE can monitor PD working status via its IP conditions. If the PD fails, the switch will not receive a PD response after the defined period, and the authentication process is restarted. This is an excellent function to ensure your network reliability and reduce management burden.

PD Failure Check

Setting	Description	Factory Default
Checked	Enables the PD Failure Check function.	Auto
Unchecked	Disables the PD Failure Check function.	Auto

IP

Setting	Description	Factory Default
Max. 15 Characters	Enter the IP for the PD	None

Period

Setting	Description	Factory Default
Max. 5 Characters	Enter the time span for IP checking period	None

PoE Timetabling

Powered devices usually do not need to be running 24 hours a day, 7days a week. The EDS-P506A-4PoE provides a PoE timetabling mechanism to let users set a flexible working schedule for each PoE port to economize the system’s power burden.

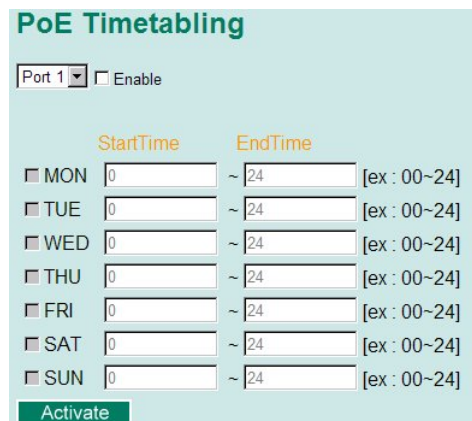

Port

Setting	Description	Factory Default
Port	Enable a dedicated port	Port 1

Enable

Setting	Description	Factory Default
Checked	Enables the port for a defined time period	Disable
Unchecked	Disables the port for a defined time period	

Weekly Timetabling

Day

Setting	Description	Factory Default
Checked	Enables the port for a defined number of days	Disable
Unchecked	Disables the port for a defined number of days	

Start/End Time

Setting	Description	Factory Default
Time for working period	Allows users to enter the start and end time for the PD's working period	0-24

PoE Status

PoE Status

Port	Status	Consumption(W)	Voltage(V)	Current(mA)
1	Enable	0	0	0
2	Enable	0	0	0
3	Enable	0	0	0
4	Enable	0	0	0

Item	Description
Enable/Disable	Indicates the PoE port status
Consumption (W)	Indicates the actual Power consumed value for PoE port
Voltage (V)	Indicates the actual Voltage consumed value for PoE port
Current (mA)	Indicates the actual Current consumed value for PoE port

PoE Email Warning Events Settings

Since industrial Ethernet devices are often located at the endpoints of a system, these devices do not always know what is happening elsewhere on the network. This means that a PoE port connected to a PD must provide system administrators with real-time alarm messages. Even when control engineers are out of the control room for an extended period of time, they can still be informed of the status of the PD almost instantaneously when exceptions occur. The EDS-P506A-4PoE supports different methods for warning engineers automatically, such as email and relay output. It also supports two digital inputs to integrate sensors into your system to automate alarms using email and relay output.

Email Warning Event Types can be divided into two basic groups: Power-Fail and PD-Failure.

PoE Email Warning Events Settings

Port Events

Port	Power-Fail	PD-Failure
1	<input type="checkbox"/>	<input type="checkbox"/>
2	<input type="checkbox"/>	<input type="checkbox"/>
3	<input type="checkbox"/>	<input type="checkbox"/>
4	<input type="checkbox"/>	<input type="checkbox"/>

Port Events	Warning e-mail is sent when...
Power-Fail	When actual PD power consumption exceeds related PD power limit setting.
PD-Failure	When the switch cannot receive a PD response after the defined period.

PoE Relay Warning Events Settings

Relay Warning Event Types can be divided into two basic groups: Power-Fail and PD-Failure.

PoE Relay Warning Events Settings

Port Events

Port	Power-Fail	PD-Failure
1	Disable	Disable
2	Disable	Disable
3	Disable	Disable
4	Disable	Disable

Activate

Port Events	Warning e-mail is sent when...
Power-Fail	When actual PD power consumption exceeds related PD power limit settings.
PD-Failure	When the switch cannot receive a PD response after the defined period.

Using Traffic Prioritization

The Moxa switch's traffic prioritization capability provides Quality of Service (QoS) to your network by making data delivery more reliable. You can prioritize traffic on your network to ensure that high priority data is transmitted with minimum delay. Traffic can be controlled by a set of rules to obtain the required Quality of Service for your network. The rules define different types of traffic and specify how each type should be treated as it passes through the switch. The Moxa switch can inspect both IEEE 802.1p/1Q layer 2 CoS tags, and even layer 3 TOS information to provide consistent classification of the entire network. The Moxa switch's QoS capability improves the performance and determinism of industrial networks for mission critical applications.

The Traffic Prioritization Concept

Traffic prioritization allows you to prioritize data so that time-sensitive and system-critical data can be transferred smoothly and with minimal delay over a network. The benefits of using traffic prioritization are:

- Improve network performance by controlling a wide variety of traffic and managing congestion.
- Assign priorities to different categories of traffic. For example, set higher priorities for time-critical or business-critical applications.
- Provide predictable throughput for multimedia applications, such as video conferencing or voice over IP, and minimize traffic delay and jitter.
- Improve network performance as the amount of traffic grows. Doing so will reduce costs since it will not be necessary to keep adding bandwidth to the network.

Traffic prioritization uses the four traffic queues that are present in your Moxa switch to ensure that high priority traffic is forwarded on a different queue from lower priority traffic. Traffic prioritization provides Quality of Service (QoS) to your network.

Moxa switch traffic prioritization depends on two industry-standard methods:

- **IEEE 802.1D**—a layer 2 marking scheme.
- **Differentiated Services (DiffServ)**—a layer 3 marking scheme.

IEEE 802.1D Traffic Marking

The IEEE Std 802.1D, 1998 Edition marking scheme, which is an enhancement to IEEE Std 802.1D, enables Quality of Service on the LAN. Traffic service levels are defined in the IEEE 802.1Q 4-byte tag, which is used to carry VLAN identification as well as IEEE 802.1p priority information. The 4-byte tag immediately follows the destination MAC address and Source MAC address.

The IEEE Std 802.1D, 1998 Edition priority marking scheme assigns an IEEE 802.1p priority level between 0 and 7 to each frame. The priority marking scheme determines the level of service that this type of traffic should receive. Refer to the table below for an example of how different traffic types can be mapped to the eight IEEE 802.1p priority levels.

IEEE 802.1p Priority Level	IEEE 802.1D Traffic Type
0	Best Effort (default)
1	Background
2	Standard (spare)
3	Excellent Effort (business critical)
4	Controlled Load (streaming multimedia)
5	Video (interactive media); less than 100 milliseconds of latency and jitter
6	Voice (interactive voice); less than 10 milliseconds of latency and jitter
7	Network Control Reserved traffic

Even though the IEEE 802.1D standard is the most widely used prioritization scheme in the LAN environment, it still has some restrictions:

- It requires an additional 4-byte tag in the frame, which is normally optional for Ethernet networks. Without this tag, the scheme cannot work.
- The tag is part of the IEEE 802.1Q header, so to implement QoS at layer 2, the entire network must implement IEEE 802.1Q VLAN tagging.
- It is only supported on a LAN and not across routed WAN links, since the IEEE 802.1Q tags are removed when the packets pass through a router.

Differentiated Services (DiffServ) Traffic Marking

DiffServ is a Layer 3 marking scheme that uses the DiffServ Code Point (DSCP) field in the IP header to store the packet priority information. DSCP is an advanced intelligent method of traffic marking that allows you to choose how your network prioritizes different types of traffic. DSCP uses 64 values that map to user-defined service levels, allowing you to establish more control over network traffic.

The advantages of DiffServ over IEEE 802.1D are:

- You can configure how you want your switch to treat selected applications and types of traffic by assigning various grades of network service to them.
- No extra tags are required in the packet.
- DSCP uses the IP header of a packet to preserve priority across the Internet.
- DSCP is backwards compatible with IPV4 TOS, which allows operation with existing devices that use a layer 3 TOS enabled prioritization scheme.

Traffic Prioritization

Moxa switches classify traffic based on layer 2 of the OSI 7 layer model, and the switch prioritizes received traffic according to the priority information defined in the received packet. Incoming traffic is classified based upon the IEEE 802.1D frame and is assigned to the appropriate priority queue based on the IEEE 802.1p service level value defined in that packet. Service level markings (values) are defined in the IEEE 802.1Q 4-byte tag, and consequently traffic will only contain 802.1p priority markings if the network is configured with VLANs and VLAN tagging. The traffic flow through the switch is as follows:

- A packet received by the Moxa switch may or may not have an 802.1p tag associated with it. If it does not, then it is given a default 802.1p tag (which is usually 0). Alternatively, the packet may be marked with a new 802.1p value, which will result in all knowledge of the old 802.1p tag being lost.
- Because the 802.1p priority levels are fixed to the traffic queues, the packet will be placed in the appropriate priority queue, ready for transmission through the appropriate egress port. When the packet

reaches the head of its queue and is about to be transmitted, the device determines whether or not the egress port is tagged for that VLAN. If it is, then the new 802.1p tag is used in the extended 802.1D header.

- The Moxa switch will check a packet received at the ingress port for IEEE 802.1D traffic classification, and then prioritize it based on the IEEE 802.1p value (service levels) in that tag. It is this 802.1p value that determines which traffic queue the packet is mapped to.

Traffic Queues

The hardware of Moxa switches has multiple traffic queues that allow packet prioritization to occur. Higher priority traffic can pass through the Moxa switch without being delayed by lower priority traffic. As each packet arrives in the Moxa switch, it passes through any ingress processing (which includes classification, marking/re-marking), and is then sorted into the appropriate queue. The switch then forwards packets from each queue.

Moxa switches support two different queuing mechanisms:

- **Weight Fair:** This method services all the traffic queues, giving priority to the higher priority queues. Under most circumstances, the Weight Fair method gives high priority precedence over low priority, but in the event that high priority traffic does not reach the link capacity, lower priority traffic is not blocked.
- **Strict:** This method services high traffic queues first; low priority queues are delayed until no more high priority data needs to be sent. The Strict method always gives precedence to high priority over low priority.

Configuring Traffic Prioritization

Quality of Service (QoS) provides a traffic prioritization capability to ensure that important data is delivered consistently and predictably. The Moxa switch can inspect IEEE 802.1p/1Q layer 2 CoS tags, and even layer 3 TOS information, to provide a consistent classification of the entire network. The Moxa switch's QoS capability improves your industrial network's performance and determinism for mission critical applications.

QoS Classification

QoS Classification

Queuing Mechanism: Weight Fair(16:14:12:10:8:4:2:1)

Port	Inspect ToS	Inspect CoS	Port Priority
1	<input checked="" type="checkbox"/>	<input checked="" type="checkbox"/>	3(Normal)
2	<input checked="" type="checkbox"/>	<input checked="" type="checkbox"/>	3(Normal)
3	<input checked="" type="checkbox"/>	<input checked="" type="checkbox"/>	3(Normal)
4	<input checked="" type="checkbox"/>	<input checked="" type="checkbox"/>	3(Normal)
5	<input checked="" type="checkbox"/>	<input checked="" type="checkbox"/>	3(Normal)
6	<input checked="" type="checkbox"/>	<input checked="" type="checkbox"/>	3(Normal)
7	<input checked="" type="checkbox"/>	<input checked="" type="checkbox"/>	3(Normal)
8	<input checked="" type="checkbox"/>	<input checked="" type="checkbox"/>	3(Normal)
9	<input checked="" type="checkbox"/>	<input checked="" type="checkbox"/>	3(Normal)
10	<input checked="" type="checkbox"/>	<input checked="" type="checkbox"/>	3(Normal)
11	<input checked="" type="checkbox"/>	<input checked="" type="checkbox"/>	3(Normal)
12	<input checked="" type="checkbox"/>	<input checked="" type="checkbox"/>	3(Normal)

Activate

The Moxa switch supports inspection of layer 3 TOS and/or layer 2 CoS tag information to determine how to classify traffic packets.

Queuing Mechanism

Setting	Description	Factory Default
Weight Fair	The Moxa switch has 4 priority queues. In the weight fair scheme, an 8, 4, 2, 1 weighting is applied to the four priorities. This approach prevents the lower priority frames from being starved of opportunity for transmission with only a slight delay to the higher priority frames.	Weight Fair
Strict	In the Strict-priority scheme, all top-priority frames egress a port until that priority’s queue is empty, and then the next lower priority queue’s frames egress. This approach can cause the lower priorities to be starved of opportunity for transmitting any frames but ensures that all high priority frames will egress the switch as soon as possible.	

Inspect TOS

Setting	Description	Factory Default
Enable/Disable	Enables or disables the Moxa switch for inspecting Type of Service (TOS) bits in the IPV4 frame to determine the priority of each frame.	Enable

Inspect CoS

Setting	Description	Factory Default
Enable/Disable	Enables or disables the Moxa switch for inspecting 802.1p CoS tags in the MAC frame to determine the priority of each frame.	Enable

NOTE The priority of an ingress frame is determined in the following order:

1. Inspect TOS
2. Inspect CoS
3. Port Highest Priority

NOTE The designer can enable these classifications individually or in combination. For instance, if a “hot” higher priority port is required for a network design, **Inspect TOS** and **Inspect CoS** can be disabled. This setting leaves only port default priority active, which results in all ingress frames being assigned the same priority on that port.

CoS Mapping

Mapping Table of CoS Value and Priority Queues

CoS	Priority Queue
0	Low
1	Low
2	Normal
3	Normal
4	Medium
5	Medium
6	High
7	High

Activate

CoS Value and Priority Queues

Setting	Description	Factory Default
Low/Normal/ Medium/High	Maps different CoS values to 4 different egress queues.	0: Low 1: Low 2: Normal 3: Normal 4: Medium 5: Medium 6: High 7: High

TOS/DiffServ Mapping

Mapping Table of ToS (DSCP) Value and Priority Queues

ToS	Level	ToS	Level	ToS	Level	ToS	Level
0x00(1)	0(Low)	0x04(2)	0(Low)	0x08(3)	0(Low)	0x0C(4)	0(Low)
0x10(5)	0(Low)	0x14(6)	0(Low)	0x18(7)	0(Low)	0x1C(8)	0(Low)
0x20(9)	1(Low)	0x24(10)	1(Low)	0x28(11)	1(Low)	0x2C(12)	1(Low)
0x30(13)	1(Low)	0x34(14)	1(Low)	0x38(15)	1(Low)	0x3C(16)	1(Low)
0x40(17)	2(Normal)	0x44(18)	2(Normal)	0x48(19)	2(Normal)	0x4C(20)	2(Normal)
0x50(21)	2(Normal)	0x54(22)	2(Normal)	0x58(23)	2(Normal)	0x5C(24)	2(Normal)
0x60(25)	3(Normal)	0x64(26)	3(Normal)	0x68(27)	3(Normal)	0x6C(28)	3(Normal)
0x70(29)	3(Normal)	0x74(30)	3(Normal)	0x78(31)	3(Normal)	0x7C(32)	3(Normal)
0x80(33)	4(Medium)	0x84(34)	4(Medium)	0x88(35)	4(Medium)	0x8C(36)	4(Medium)
0x90(37)	4(Medium)	0x94(38)	4(Medium)	0x98(39)	4(Medium)	0x9C(40)	4(Medium)
0xA0(41)	5(Medium)	0xA4(42)	5(Medium)	0xA8(43)	5(Medium)	0xAC(44)	5(Medium)
0xB0(45)	5(Medium)	0xB4(46)	5(Medium)	0xB8(47)	5(Medium)	0xBC(48)	5(Medium)

Activate

ToS (DSCP) Value and Priority Queues

Setting	Description	Factory Default
Low/Normal/ Medium/High	Maps different TOS values to 4 different egress queues.	1 to 16: Low 17 to 32: Normal 33 to 48: Medium 49 to 64: High

Using Virtual LAN

Setting up Virtual LANs (VLANs) on your Moxa switch increases the efficiency of your network by dividing the LAN into logical segments, as opposed to physical segments. In general, VLANs are easier to manage.

The Virtual LAN (VLAN) Concept

What is a VLAN?

A VLAN is a group of devices that can be located anywhere on a network, but which communicate as if they are on the same physical segment. With VLANs, you can segment your network without being restricted by physical connections—a limitation of traditional network design. With VLANs you can segment your network according into:

- **Departmental groups**—You could have one VLAN for the marketing department, another for the finance department, and another for the product development department.

- **Hierarchical groups**—You could have one VLAN for directors, another for managers, and another for general staff.
- **Usage groups**—You could have one VLAN for email users and another for multimedia users.

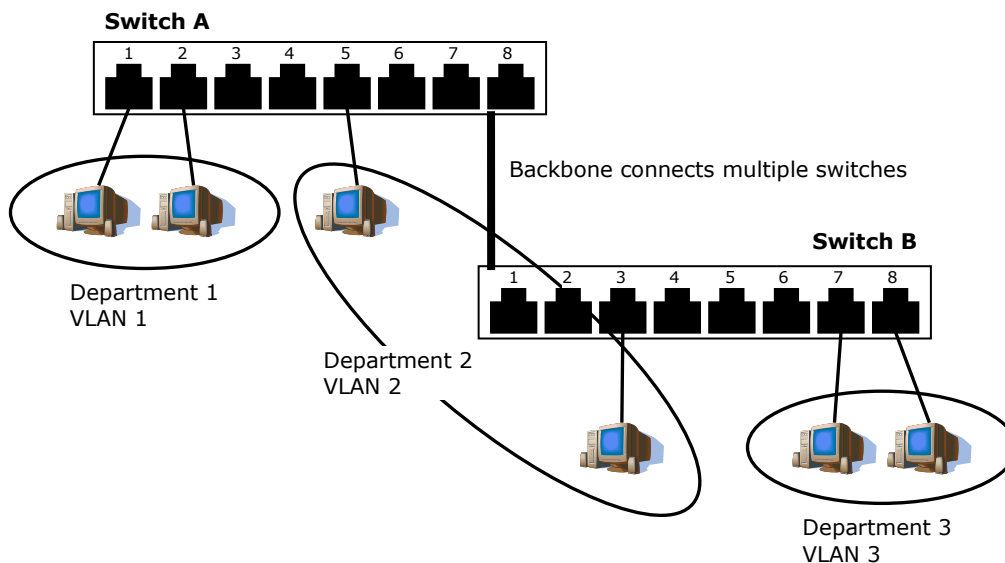

Benefits of VLANs

The main benefit of VLANs is that they provide a network segmentation system that is far more flexible than traditional networks. Using VLANs also provides you with three other benefits:

- **VLANs ease the relocation of devices on networks:** With traditional networks, network administrators spend much of their time dealing with moves and changes. If users move to a different subnetwork, the addresses of each host must be updated manually. With a VLAN setup, if a host originally on VLAN Marketing, for example, is moved to a port on another part of the network, and retains its original subnet membership, you only need to specify that the new port is on VLAN Marketing. You do not need to do any re-cabling.
- **VLANs provide extra security:** Devices within each VLAN can only communicate with other devices on the same VLAN. If a device on VLAN Marketing needs to communicate with devices on VLAN Finance, the traffic must pass through a routing device or Layer 3 switch.
- **VLANs help control traffic:** With traditional networks, congestion can be caused by broadcast traffic that is directed to all network devices, regardless of whether or not they need it. VLANs increase the efficiency of your network because each VLAN can be set up to contain only those devices that need to communicate with each other.

VLANs and the Rackmount switch

Your Moxa switch provides support for VLANs using IEEE Std 802.1Q-1998. This standard allows traffic from multiple VLANs to be carried across one physical link. The IEEE Std 802.1Q-1998 standard allows each port on your Moxa switch to be placed as follows:

- On a single VLAN defined in the Moxa switch
- On several VLANs simultaneously using 802.1Q tagging

The standard requires that you define the *802.1Q VLAN ID* for each VLAN on your Moxa switch before the switch can use it to forward traffic:

Managing a VLAN

A new or initialized Moxa switch contains a single VLAN—the Default VLAN. This VLAN has the following definition:

- *VLAN Name*—Management VLAN
- *802.1Q VLAN ID*—1 (if tagging is required)

All the ports are initially placed on this VLAN, and it is the only VLAN that allows you to access the management software of the Moxa switch over the network.

Communication Between VLANs

If devices connected to a VLAN need to communicate to devices on a different VLAN, a router or Layer 3 switching device with connections to both VLANs needs to be installed. Communication between VLANs can only take place if they are all connected to a routing or Layer 3 switching device.

VLANs: Tagged and Untagged Membership

The Moxa switch supports 802.1Q VLAN tagging, a system that allows traffic for multiple VLANs to be carried on a single physical link (backbone, trunk). When setting up VLANs you need to understand when to use untagged and tagged membership of VLANs. Simply put, if a port is on a single VLAN it can be an untagged member, but if the port needs to be a member of multiple VLANs, tagged membership must be defined.

A typical host (e.g., clients) will be untagged members of one VLAN, defined as an **Access Port** in a Moxa switch, while inter-switch connections will be tagged members of all VLANs, defined as a **Trunk Port** in a Moxa switch.

The IEEE Std 802.1Q-1998 defines how VLANs operate within an open packet-switched network. An 802.1Q compliant packet carries additional information that allows a switch to determine which VLAN the port belongs to. If a frame is carrying the additional information, it is known as a *tagged* frame.

To carry multiple VLANs across a single physical link (backbone, trunk), each packet must be tagged with a VLAN identifier so that the switches can identify which packets belong in which VLAN. To communicate between VLANs, a router must be used.

The Moxa switch supports three types of VLAN port settings:

- **Access Port:** The port connects to a single device that is not tagged. The user must define the default port PVID that assigns which VLAN the device belongs to. Once the ingress packet of this Access Port egresses to another Trunk Port (the port needs all packets to carry tag information), the Moxa switch will insert this PVID into this packet so the next 802.1Q VLAN switch can recognize it.
- **Trunk Port:** The port connects to a LAN that consists of untagged devices, tagged devices and/or switches and hubs. In general, the traffic of the Trunk Port must have a Tag. Users can also assign a PVID to a Trunk Port. The untagged packet on the Trunk Port will be assigned the port default PVID as its VID.
- **Hybrid Port:** The port is similar to a Trunk port, except users can explicitly assign tags to be removed from egress packets.

The following section illustrates how to use these ports to set up different applications.

Sample Applications of VLANs Using Moxa Switches

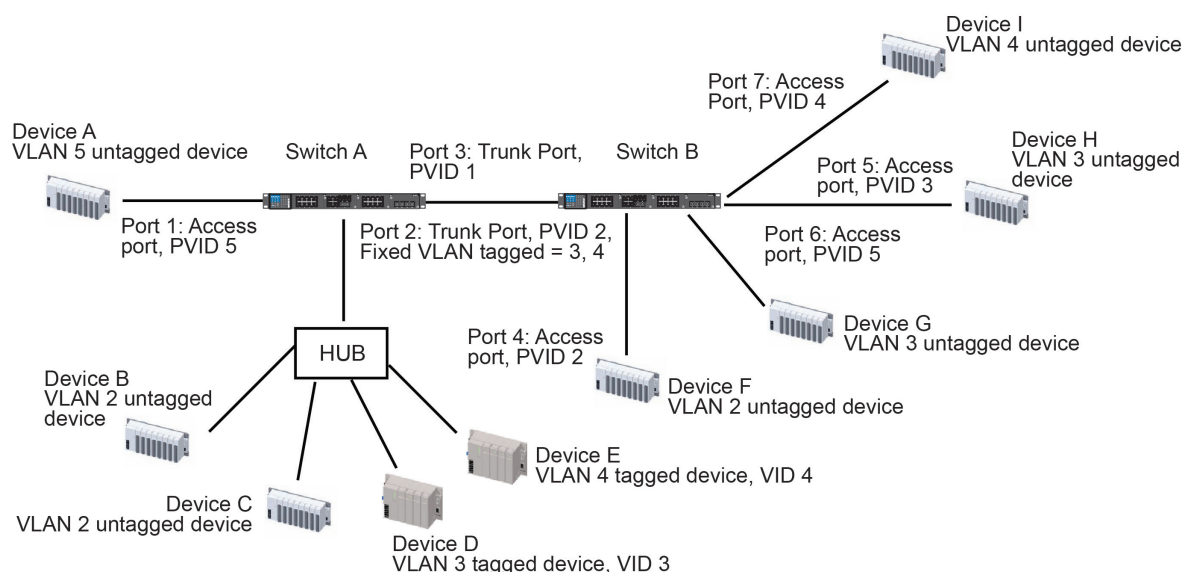

In this application,

- Port 1 connects a single untagged device and assigns it to VLAN 5; it should be configured as **Access Port** with PVID 5.
- Port 2 connects a LAN with two untagged devices belonging to VLAN 2. One tagged device with VID 3 and one tagged device with VID 4. It should be configured as **Trunk Port** with PVID 2 for untagged device and Fixed VLAN (Tagged) with 3 and 4 for tagged device. Since each port can only have one unique PVID, all untagged devices on the same port must belong to the same VLAN.
- Port 3 connects with another switch. It should be configured as **Trunk Port** GVRP protocol will be used through the Trunk Port.
- Port 4 connects a single untagged device and assigns it to VLAN 2; it should be configured as **Access Port** with PVID 2.
- Port 5 connects a single untagged device and assigns it to VLAN 3; it should be configured as **Access Port** with PVID 3.
- Port 6 connect a single untagged device and assigns it to VLAN 5; it should be configured as **Access Port** with PVID 5.
- Port 7 connects a single untagged device and assigns it to VLAN 4; it should be configured as **Access Port** with PVID 4.

After the application is properly configured:

- Packets from Device A will travel through **Trunk Port 3** with tagged VID 5. Switch B will recognize its VLAN, pass it to port 6, and then remove tags received successfully by Device G, and vice versa.
- Packets from Devices B and C will travel through **Trunk Port 3** with tagged VID 2. Switch B recognizes its VLAN, passes it to port 4, and then removes tags received successfully by Device F, and vice versa.
- Packets from Device D will travel through **Trunk Port 3** with tagged VID 3. Switch B will recognize its VLAN, pass to port 5, and then remove tags received successfully by Device H. Packets from Device H will travel through **Trunk Port 3** with PVID 3. Switch A will recognize its VLAN and pass it to port 2, but will not remove tags received successfully by Device D.
- Packets from Device E will travel through **Trunk Port 3** with tagged VID 4. Switch B will recognize its VLAN, pass it to port 7, and then remove tags received successfully by Device I. Packets from Device I will travel through **Trunk Port 3** with tagged VID 4. Switch A will recognize its VLAN and pass it to port 2, but will not remove tags received successfully by Device E.

Configuring Virtual LAN

VLAN Settings

To configure **802.1Q VLAN** on the Moxa switch, use the **VLAN Settings** page to configure the ports.

802.1Q VLAN Settings

VLAN Mode 802.1Q VLAN ▼

Management VLAN ID 1

Enable GVRP

Port	Type	PVID	Fixed VLAN (Tagged)	Fixed VLAN (Untagged)	Forbidden VLAN
1	Access ▼	1			
2	Trunk ▼	1			
3	Hybrid ▼	1			
4	Access ▼	1			
5	Access ▼	1			
6	Access ▼	1			
7	Access ▼	1			
8	Access ▼	1			

VLAN Mode

Setting	Description	Factory Default
802.1Q VLAN	Set VLAN mode to 802.1Q VLAN	802.1Q VLAN
Port-based VLAN	Set VLAN mode to Port-based VLAN	

Management VLAN ID

Setting	Description	Factory Default
VLAN ID from 1 to 4094	Assigns the VLAN ID of this Moxa switch.	1

Port Type

Setting	Description	Factory Default
Access	Port type is used to connect single devices without tags.	Access
Trunk	Select Trunk port type to connect another 802.1Q VLAN aware switch	
Hybrid	Select Hybrid port to connect another Access 802.1Q VLAN aware switch or another LAN that combines tagged and/or untagged devices and/or other switches/hubs.	

**ATTENTION**

For communication redundancy in the VLAN environment, set **Redundant Port Coupling Port** and **Coupling Control Port** as **Trunk Port** since these ports act as the **backbone** to transmit all packets of different VLANs to different Moxa switch units.

Port PVID

Setting	Description	Factory Default
VID ranges from 1 to 4094	Sets the default VLAN ID for untagged devices that connect to the port.	1

Fixed VLAN List (Tagged)

Setting	Description	Factory Default
VID ranges from 1 to 4094	This field will be active only when selecting the Trunk or Hybrid port type. Set the other VLAN ID for tagged devices that connect to the port. Use commas to separate different VIDs.	None

Fixed VLAN List (Untagged)

Setting	Description	Factory Default
VID range from 1 to 4094	This field will be active only when selecting the Trunk or Hybrid port type. Set the other VLAN ID for tagged devices that connect to the port and tags that need to be removed in egress packets. Use commas to separate different VIDs.	Default

Forbidden VLAN List

Setting	Description	Factory Default
VID ranges from 1 to 4094	This field will be active only when selecting the Trunk or Hybrid port type. Set the VLAN IDs that will not be supported by this port. Use commas to separate different VIDs.	None

VLAN Table

VLAN Table				
VLAN Mode				
VLAN Mode		802.1Q VLAN		
Management VLAN				
Management VLAN		1		
Current 802.1Q VLAN List				
Index	VID	Joined Access Port	Joined Trunk Port	Joined Hybrid Port
1	1	1, 4, 5, 6, 7, 8,	2,	3,

Use the **802.1Q VLAN table** to review the VLAN groups that were created, **Joined Access Ports**, **Trunk Ports**, and **Hybrid Ports**, and use the **Port-based VLAN table** to review the VLAN group and **Joined Ports**.

NOTE Most Moxa managed switches have a maximum of 64 VLAN settings. However, the IKS-G6524/G6824 and ICS-G7000 series support up to 256 VLAN settings.

Using Multicast Filtering

Multicast filtering improves the performance of networks that carry multicast traffic. This section explains multicasts, multicast filtering, and how multicast filtering can be implemented on your Moxa switch.

The Concept of Multicast Filtering

What is an IP Multicast?

A *multicast* is a packet sent by one host to multiple hosts. Only those hosts that belong to a specific multicast group will receive the multicast. If the network is set up correctly, a multicast can only be sent to an end-station or a subset of end-stations on a LAN or VLAN that belong to the multicast group. Multicast group members can be distributed across multiple subnets, so that multicast transmissions can occur within a campus LAN or over a WAN. In addition, networks that support IP multicast send only *one* copy of the desired information across the network until the delivery path that reaches group members diverges. To make more efficient use of network bandwidth, it is only at these points that multicast packets are duplicated and forwarded. A multicast packet has a multicast group address in the destination address field of the packet's IP header.

Benefits of Multicast

The benefits of using IP multicast are:

- It uses the most efficient, sensible method to deliver the same information to many receivers with only one transmission.
- It reduces the load on the source (for example, a server) since it will not need to produce several copies of the same data.
- It makes efficient use of network bandwidth and scales well as the number of multicast group members increases.
- Works with other IP protocols and services, such as Quality of Service (QoS).

Multicast transmission makes more sense and is more efficient than unicast transmission for some applications. For example, multicasts are often used for video-conferencing, since high volumes of traffic must be sent to several end-stations at the same time, but where broadcasting the traffic to all end-stations would cause a substantial reduction in network performance. Furthermore, several industrial automation protocols, such as Allen-Bradley, EtherNet/IP, Siemens Profibus, and Foundation Fieldbus HSE (High Speed Ethernet), use multicast. These industrial Ethernet protocols use publisher/subscriber communications models by multicasting packets that could flood a network with heavy traffic. IGMP Snooping is used to prune multicast traffic so that it travels only to those end destinations that require the traffic, reducing the amount of traffic on the Ethernet LAN.

Multicast Filtering

Multicast filtering ensures that only end-stations that have joined certain groups receive multicast traffic. With multicast filtering, network devices only forward multicast traffic to the ports that are connected to registered end-stations. The following two figures illustrate how a network behaves without multicast filtering, and with multicast filtering.

Network without multicast filtering

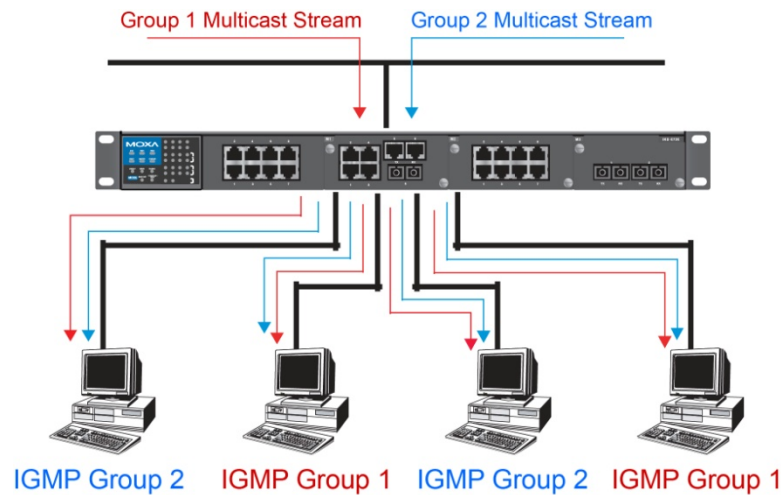

All hosts receive the multicast traffic, even if they don't need it.

Network with multicast filtering

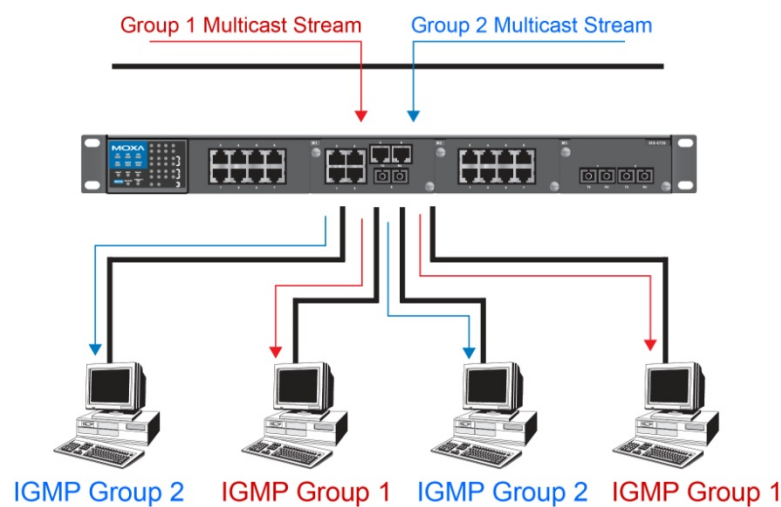

Hosts only receive dedicated traffic from other hosts belonging to the same group.

Multicast Filtering and Moxa's Industrial Rackmount Switches

The Moxa switch has three ways to achieve multicast filtering: IGMP (Internet Group Management Protocol) Snooping, GMRP (GARP Multicast Registration Protocol), and adding a static multicast MAC manually to filter multicast traffic automatically.

Snooping Mode

Snooping Mode allows your switch to forward multicast packets only to the appropriate ports. The switch **snoops** on exchanges between hosts and an IGMP device, such as a router, to find those ports that want to join a multicast group, and then configures its filters accordingly.

IGMP Snooping Enhanced Mode

Snooping Enhanced Mode allows your switch to forward multicast packets to the Moxa switch's member port only. If you disable Enhanced Mode, data streams will run to the querier port as well as the member port.

Query Mode

Query mode allows the Moxa switch to work as the Querier if it has the lowest IP address on the subnetwork to which it belongs. IGMP querying is enabled by default on the Moxa switch to help prevent interoperability issues with some multicast routers that may not follow the lowest IP address election method. Enable query mode to run multicast sessions on a network that does not contain IGMP routers (or queriers).

NOTE

Moxa switches are compatible with any device that conforms to the IGMP v2 and IGMP v3 device protocol.

IGMP Multicast Filtering

IGMP is used by IP-supporting network devices to register hosts with multicast groups. It can be used on all LANs and VLANs that contain a multicast capable IP router, and on other network devices that support multicast filtering. IGMP works as follows:

- The IP router (or querier) periodically sends query packets to all end-stations on the LANs or VLANs that are connected to it. For networks with more than one IP router, the router with the lowest IP address is the querier. A switch with IP address lower than the IP address of any other IGMP queriers connected to the LAN or VLAN can become the IGMP querier.
- When an IP host receives a query packet, it sends a report packet back that identifies the multicast group that the end-station would like to join.
- When the report packet arrives at a port on a switch with IGMP Snooping enabled, the switch knows that the port should forward traffic for the multicast group, and then proceeds to forward the packet to the router.
- When the router receives the report packet, it registers that the LAN or VLAN requires traffic for the multicast groups.
- When the router forwards traffic for the multicast group to the LAN or VLAN, the switches only forward the traffic to ports that received a report packet.

GMRP (GARP Multicast Registration Protocol)

Moxa switches support IEEE 802.1D-1998 GMRP (GARP Multicast Registration Protocol), which is different from IGMP (Internet Group Management Protocol). GMRP is a MAC-based multicast management protocol, whereas IGMP is IP-based. GMRP provides a mechanism that allows bridges and end stations to register or de-register Group membership information dynamically. GMRP functions similarly to GVRP, except that GMRP registers multicast addresses on ports. When a port receives a **GMRP-join** message, it will register the multicast address to its database if the multicast address is not registered, and all the multicast packets with that multicast address are able to be forwarded from this port. When a port receives a **GMRP-leave** message, it will de-register the multicast address from its database, and all the multicast packets with this multicast address will not be able to be forwarded from this port.

Static Multicast MAC

Some devices may only support multicast packets, but not support either IGMP Snooping or GMRP. The Moxa switch supports adding multicast groups manually to enable multicast filtering.

Enabling Multicast Filtering

Use the serial console or web interface to enable or disable IGMP Snooping and IGMP querying. If IGMP Snooping is not enabled, then IP multicast traffic is always forwarded, flooding the network.

Configuring IGMP Snooping

IGMP Snooping provides the ability to prune multicast traffic so that it travels only to those end destinations that require that traffic, thereby reducing the amount of traffic on the Ethernet LAN.

IGMP Snooping Setting

Current VLAN List

IGMP Snooping Enable Query Interval (s)

IGMP Snooping Enhanced Mode

Index	VLAN	IGMP Snooping	Querier	Static Multicast Querier Port
1	1	<input checked="" type="checkbox"/> Enable	<input checked="" type="checkbox"/> Enable	<input type="checkbox"/> 1-1 <input type="checkbox"/> 1-2 <input type="checkbox"/> 1-3 <input type="checkbox"/> 1-4 <input type="checkbox"/> 1-5 <input type="checkbox"/> 1-6 <input type="checkbox"/> 1-7 <input type="checkbox"/> 1-8 <input type="checkbox"/> 2-1 <input type="checkbox"/> 2-2 <input type="checkbox"/> 2-3 <input type="checkbox"/> 2-4 <input type="checkbox"/> 2-5 <input type="checkbox"/> 2-6 <input type="checkbox"/> 2-7 <input type="checkbox"/> 2-8 <input type="checkbox"/> 3-1 <input type="checkbox"/> 3-2 <input type="checkbox"/> 3-3 <input type="checkbox"/> 3-4 <input type="checkbox"/> 3-5 <input type="checkbox"/> 3-6 <input type="checkbox"/> 3-7 <input type="checkbox"/> 3-8 <input type="checkbox"/> 4-1 <input type="checkbox"/> 4-2

IGMP Snooping Enable

Setting	Description	Factory Default
Enable/Disable	Checkmark the IGMP Snooping Enable checkbox near the top of the window to enable the IGMP Snooping function globally.	Disabled

Note: You should enable IGMP Snooping if the network also uses non-Moxa 3rd party switches.

Query Interval

Setting	Description	Factory Default
Numerical value, input by the user	Sets the query interval of the Querier function globally. Valid settings are from 20 to 600 seconds.	125 seconds

IGMP Snooping Enhanced Mode

Setting	Description	Factory Default
Enable	IGMP Multicast packets will be forwarded to: <ul style="list-style-type: none"> • Auto-Learned Multicast Querier Ports • Member Ports 	Enable
Disable	IGMP Multicast packets will be forwarded to: <ul style="list-style-type: none"> • Auto-Learned Multicast Querier Ports • Static Multicast Querier Ports • Querier Connected Ports • Member Ports 	

Note: You should enable IGMP Snooping Enhanced Mode when all switches on the network are Moxa switches.

IGMP Snooping

Setting	Description	Factory Default
Enable/Disable	Enables or disables the IGMP Snooping function on that particular VLAN.	Enabled if IGMP Snooping is enabled globally

Querier

Setting	Description	Factory Default
Enable/Disable	Enables or disables the Moxa switch's querier function.	Enabled if IGMP Snooping is enabled globally

Static Multicast Querier Port

Setting	Description	Factory Default
Select/Deselect	Selects the ports that will connect to the multicast routers. This option is only active when IGMP Snooping is enabled.	Disabled

NOTE If a router or layer 3 switch is connected to the network, it will act as the Querier, and consequently this Querier option will be disabled on all Moxa layer 2 switches.

If all switches on the network are Moxa layer 2 switches, then only one layer 2 switch will act as Querier.

IGMP Table

The Moxa switch displays the current active IGMP groups that were detected.

Current Active IGMP Groups							
VID	Auto Learned Multicast Querier Port	Static Multicast Querier Port	Querier Connected Port	Act as Querier	Active IGMP Groups		
					IP	MAC	Members Port
1		1-4		Yes	239.255.255.250	01-00-5E-7F-FF-FA	4-4

The information shown in the table includes **VID**, **Auto-learned Multicast Router Port**, **Static Multicast Router Port**, **Querier Connected Port**, and the **IP** and **MAC** addresses of active IGMP groups.

Static Multicast MAC Addresses

If required, the Moxa switch also supports adding multicast groups manually.

Static Multicast MAC Address

Current Static Multicast MAC Address List

<input type="checkbox"/> All	<input type="checkbox"/> Index	<input type="checkbox"/> MAC Address	<input type="checkbox"/> Join Port
<div style="text-align: center; margin-top: 50px;"> <input type="button" value="Remove Select"/> </div>			

Add New Static Multicast MAC Address to the List

MAC Address - - - - -

Join Port

1-1 1-2 1-3 1-4 1-5 1-6 1-7 1-8 2-1 2-2 2-3 2-4 2-5
 2-6 2-7 2-8 3-1 3-2 3-3 3-4 3-5 3-6 3-7 3-8 4-1 4-2

Add New Static Multicast Address to the List

Setting	Description	Factory Default
MAC Address	Input the multicast MAC address of this host.	None

MAC Address

Setting	Description	Factory Default
Integer	Input the number of the VLAN that the host with this MAC address belongs to.	None

Join Port

Setting	Description	Factory Default
Select/Deselect	Checkmark the appropriate check boxes to select the join ports for this multicast group.	None

Configuring GMRP

GMRP is a MAC-based multicast management protocol, whereas IGMP is IP-based. GMRP provides a mechanism that allows bridges and end stations to register or un-register Group membership information dynamically.

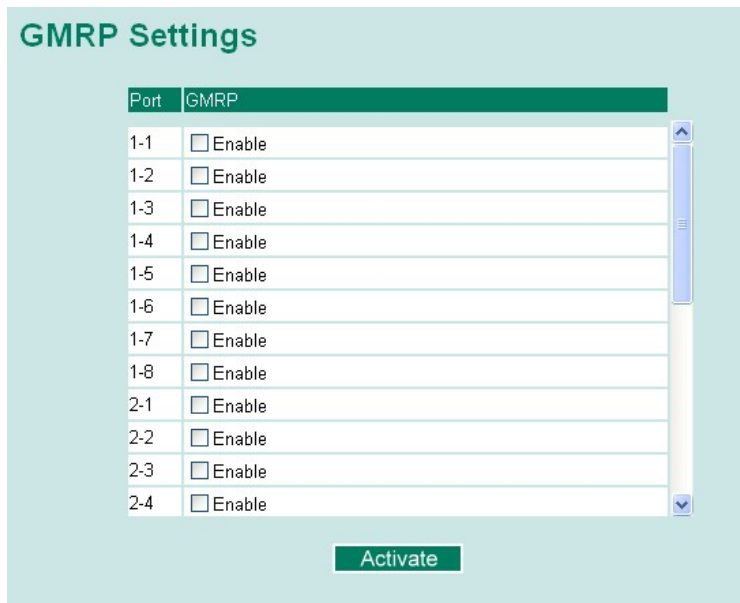

GMRP enable

Setting	Description	Factory Default
Enable/Disable	Enables or disables the GMRP function for the port listed in the Port column	Disable

GMRP Table

The Moxa switch displays the current active GMRP groups that were detected

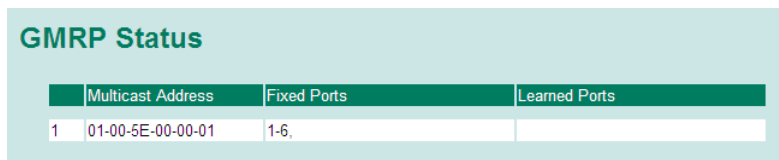

Setting	Description
Fixed Ports	This multicast address is defined by static multicast.
Learned Ports	This multicast address is learned by GMRP.

Multicast Filtering Behavior

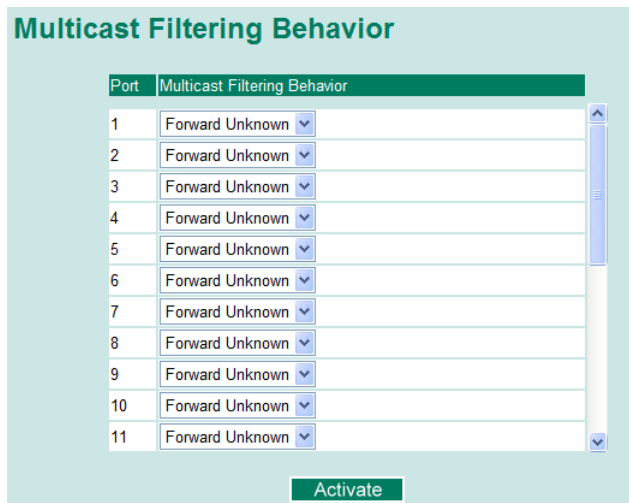

Setting	Description	Factory Default
Multicast Filtering Behavior	Define the multicast filtering behavior by three options: Forward All: flood all multicast packets to the VLAN of the network. Forward Unknown: flood unknown multicast packets to the VLAN while known multicast packets are sent to the indicated groups. Filter Unknown: drop unknown multicast packets and only send known multicast packets to indicated groups.	Forward Unknown

Using Bandwidth Management

In general, one host should not be allowed to occupy unlimited bandwidth, particularly when the device malfunctions. For example, so-called "broadcast storms" could be caused by an incorrectly configured topology, or a malfunctioning device. Moxa industrial Ethernet switches not only prevents broadcast storms, but can also be configured to a different ingress rate for all packets, giving administrators full control of their limited bandwidth to prevent undesirable effects caused by unpredictable faults.

Configuring Bandwidth Management

Please note that two types of bandwidth management settings are available, depending on the specific model of switch.

Type 1

Traffic Rate Limiting Settings

Traffic Rate Limiting Settings

Control Mode: Normal

Port	Policy	Ingress Priority Queue Rate			
		Low	Normal	Medium	High
1	Limit Broadcast	8M	8M	8M	8M
2	Limit Broadcast	8M	8M	8M	8M
3	Limit Broadcast	8M	8M	8M	8M
4	Limit Broadcast	8M	8M	8M	8M
5	Limit Broadcast	8M	8M	8M	8M
6	Limit Broadcast	8M	8M	8M	8M
7	Limit Broadcast	8M	8M	8M	8M
G1	Limit Broadcast	8M	8M	8M	8M
G2	Limit Broadcast	8M	8M	8M	8M

Control Mode	Description	Factory Default
Normal	Set the max. ingress rate limit for different packet types	Normal
Port Disable	When the ingress packets exceed the ingress rate limit, the port will be disabled for a certain period	

Ingress Rate Limit - Normal

Policy	Description	Factory Default
Limit All	Select the ingress rate limit for different packet types from the following options: Not Limited, 128K, 256K, 512K, 1M, 2M, 4M, 8M	Limit Broadcast 8M
Limit Broadcast, Multicast, Flooded Unicast		
Limit Broadcast, Multicast		
Limit Broadcast		

Traffic Rate Limiting Settings

Control Mode: Port Disable

Period (1~65535s): 30

Port	Ingress(fps)
1	Not Limited
2	Not Limited
3	Not Limited
4	Not Limited
5	Not Limited
6	Not Limited
7	Not Limited
G1	Not Limited
G2	Not Limited
G3	Not Limited

Activate

Ingress Rate Limit – Port Disable

Setting	Description	Factory Default
Period (1~65535 seconds)	When the ingress packets exceed the ingress rate limit, the port will be disabled for a certain period	30 second
Ingress (fps)	Select the ingress rate (fps) limit for all packets from the following options: Not Limited, 4464, 7441, 14881, 22322, 37203, 52084, 74405	Not Limited

Egress Rate Limit

Port	Egress
1	Not Limited
2	Not Limited
3	Not Limited
4	Not Limited
5	Not Limited
6	Not Limited
7	Not Limited
G1	Not Limited
G2	Not Limited
G3	Not Limited

Activate

Setting	Description	Factory Default
Egress rate	Select the ingress rate limit (% of max. throughput) for all packets from the following options: Not Limited, 3%, 5%, 10%, 15%, 25%, 35%, 50%, 65%, 85%	Not Limited

Type 2

Broadcast Storm Protection

Broadcast Storm Protection

Broadcast Storm Protection

Include Multicast Packet

Include Unknown Multicast and Unknown Unicast Packet

Activate

Setting	Description	Factory Default
Enable/Disable	This enables or disables Broadcast Storm Protection for unknown broadcast packet globally	Enable
	This enables or disables Broadcast Storm Protection for unknown multicast packets globally	Disable

Traffic Rate Limiting Settings

Traffic Rate Limiting Settings

Control Mode:

Port	Ingress	Egress
1	Not Limited	Not Limited
2	Not Limited	Not Limited
3	Not Limited	Not Limited
4	Not Limited	Not Limited
5	Not Limited	Not Limited
6	Not Limited	Not Limited
7	Not Limited	Not Limited
8	Not Limited	Not Limited
9	Not Limited	Not Limited
10	Not Limited	Not Limited
11	Not Limited	Not Limited
12	Not Limited	Not Limited
13	Not Limited	Not Limited
14	Not Limited	Not Limited
15	Not Limited	Not Limited
16	Not Limited	Not Limited

Ingress and Egress Rate Limit - Normal

Setting	Description	Factory Default
Ingress rate	Select the ingress/egress rate limit (% of max. throughput) for all packets from the following options: Not Limited, 3%, 5%, 10%, 15%, 25%, 35%, 50%, 65%, 85%	Not Limited
Egress rate		

Traffic Rate Limiting Settings

Control Mode:

Period (1~65535s):

Port	Ingress
1	Not Limited
2	Not Limited
3	Not Limited
4	Not Limited
5	Not Limited
6	Not Limited
7	Not Limited
8	Not Limited
9	Not Limited
10	Not Limited
11	Not Limited
12	Not Limited
15	Not Limited
16	Not Limited

Ingress Rate Limit – Port Disable

Setting	Description	Factory Default
Period (1~65535 seconds)	When the ingress packets exceed the ingress rate limit, the port will be disabled for a certain period.	30 seconds
Ingress (frame per second)	Select the ingress rate (fps) limit for all packets from the following options: Not Limited, 4464, 7441, 14881, 22322, 37203, 52084, 74405	Not Limited

Security

Security can be categorized in two levels: the user name/password level, and the port access level. For user name/password level security, Moxa switches provide two different user login options: Terminal Access Controller Access-Control System Plus (TACACS+) and Remote Authentication Dial In User Service (RADIUS). The TACACS+ and RADIUS mechanism is a centralized "AAA" (Authentication, Authorization and Accounting) system for connecting to network services. The fundamental purpose of both TACACS+ and RADIUS is to provide an efficient and secure mechanism for user account management.

User Login Authentication – User Login Settings

Both TACAS+ and RADIUS are options here.

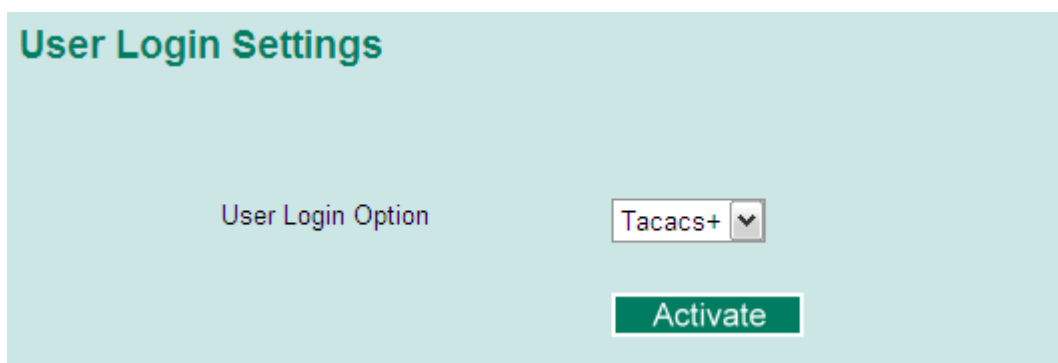

The screenshot shows the 'User Login Settings' configuration page. It features a title 'User Login Settings' in green. Below the title, there is a label 'User Login Option' followed by a dropdown menu currently set to 'Tacacs+'. Below the dropdown is a green 'Activate' button.

User Login Authentication – Auth Server Setting

The detailed configuration settings of TACACS+ and RADIUS are displayed in the table below:

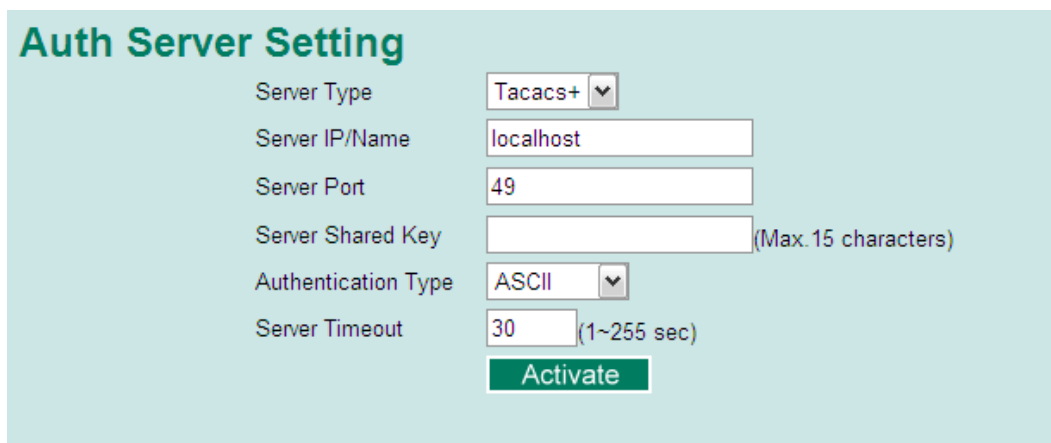

The screenshot shows the 'Auth Server Setting' configuration page. It features a title 'Auth Server Setting' in green. Below the title, there are several configuration fields:

Server Type	Tacacs+
Server IP/Name	localhost
Server Port	49
Server Shared Key	<input type="text"/> (Max. 15 characters)
Authentication Type	ASCII
Server Timeout	30 (1~255 sec)

At the bottom of the form is a green 'Activate' button.

Auth Server Setting

Server Type:

Server IP/Name:

Server Port:

Server Shared Key: (Max. 15 characters)

Authentication Type:

Server Timeout: (1~255 sec)

Setting	Description	Factory Default
Server Type	Authentication server types selection	TACACS+
Server IP/Name	Set IP address of an external TACACS+/RADIUS server as the authentication database	Localhost
Server Port	Set communication port of an external TACACS+/RADIUS server as the authentication database	TACACS+ : 49 RADIUS : 1812
Server Shared Key	Set specific characters for server authentication verification	None
Authentication Type	The authentication mechanism is EAP-MD5 for RADIUS	ASCII for TACACS+
Server Timeout	The timeout period to wait for a server response	TACACS+ : 30 RADIUS : 5

Using Port Access Control

The Moxa switch provides two kinds of Port-Based Access Control: Static Port Lock and IEEE 802.1X.

Static Port Lock

In this case, the Moxa switch can also be configured to protect static MAC addresses for a specific port. With the Port Lock function, these locked ports will not learn any additional addresses, but only allow traffic from preset static MAC addresses, helping to block hackers and careless usage.

IEEE 802.1X

The IEEE 802.1X standard defines a protocol for client/server-based access control and authentication. The protocol restricts unauthorized clients from connecting to a LAN through ports that are open to the Internet, and which otherwise would be readily accessible. The purpose of the authentication server is to check each client that requests access to the port. The client is only allowed access to the port if the client's permission is authenticated.

Three components are used to create an authentication mechanism based on 802.1X standards: Client/Supplicant, Authentication Server, and Authenticator.

Client/Supplicant: The end station that requests access to the LAN and switch services and responds to the requests from the switch.

Authentication Server: The server that performs the actual authentication of the supplicant.

Authenticator: Edge switch or wireless access point that acts as a proxy between the supplicant and the authentication server, requesting identity information from the supplicant, verifying the information with the authentication server, and relaying a response to the supplicant.

The Moxa switch acts as an authenticator in the 802.1X environment. A supplicant and an authenticator exchange EAPOL (Extensible Authentication Protocol over LAN) frames with each other. We can either use an external RADIUS server as the authentication server, or implement the authentication server in the Moxa switch by using a Local User Database as the authentication look-up table. When we use an external RADIUS server as the authentication server, the authenticator and the authentication server exchange EAP frames between each other.

Authentication can be initiated either by the supplicant or the authenticator. When the supplicant initiates the authentication process, it sends an **EAPOL-Start** frame to the authenticator. When the authenticator initiates the authentication process or when it receives an **EAPOL Start** frame, it sends an **EAP Request/Identity** frame to ask for the username of the supplicant.

Configuring Static Port Lock

The Moxa switch supports adding unicast groups manually if required.

Static Unicast MAC Address

Setting	Description	Factory Default
MAC Address	Adds the static unicast MAC address into the address table.	None
Port	Associates the static address to a dedicated port.	1-1

Configuring IEEE 802.1X

Database Option

Setting	Description	Factory Default
Local (Max. of 32 users)	Select this option when setting the Local User Database as the authentication database.	Local
Radius	Select this option to set an external RADIUS server as the authentication database. The authentication mechanism is EAP-MD5.	Local

Radius, Local	Select this option to make using an external RADIUS server as the authentication database the first priority. The authentication mechanism is EAP-MD5 The first priority is to set the Local User Database as the authentication database.	Local
---------------	--------------------------------------------------------------------------------------------------------------------------------------------------------------------------------------------------------------------------------------------	-------

Radius Server

Setting	Description	Factory Default
IP address or domain name	The IP address or domain name of the RADIUS server	local host

Server Port

Setting	Description	Factory Default
Numerical	The UDP port of the RADIUS server	1812

Shared Key

Setting	Description	Factory Default
alphanumeric (Max. of 40 characters)	A key to be shared between the external RADIUS server and Moxa switch. Both ends must be configured to use the same key.	None

Re-Auth

Setting	Description	Factory Default
Enable/Disable	Select enable to require re-authentication of the client after a preset time period of no activity has elapsed.	Disable

Re-Auth Period

Setting	Description	Factory Default
Numerical (60 to 65535 sec.)	Specify how frequently the end stations need to reenter usernames and passwords in order to stay connected.	3600

802.1X

Setting	Description	Factory Default
Enable/Disable	Checkmark the checkbox under the 802.1X column to enable IEEE 802.1X for one or more ports. All end stations must enter usernames and passwords before access to these ports is allowed.	Disable

802.1X Re-Authentication

The Moxa switch can force connected devices to be re-authorized manually.

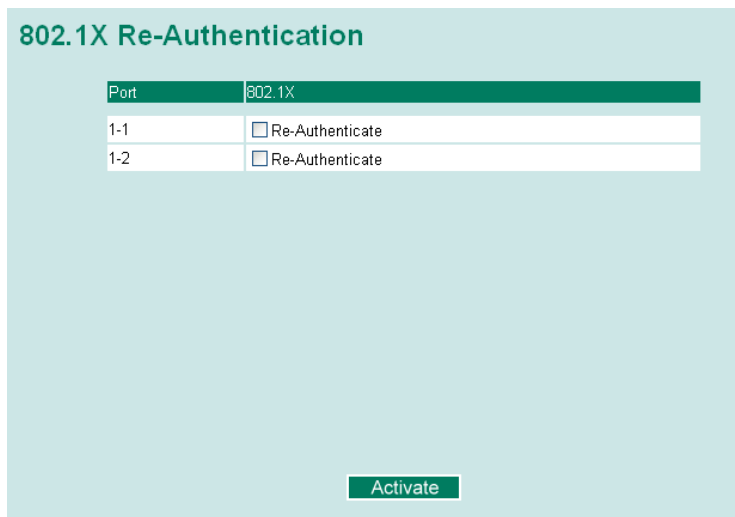

802.1X Re-Authentication

Setting	Description	Factory Default
Enable/Disable	Enables or disables 802.1X Re-Authentication	Disable

Local User Database Setup

When setting the Local User Database as the authentication database, set the database first.

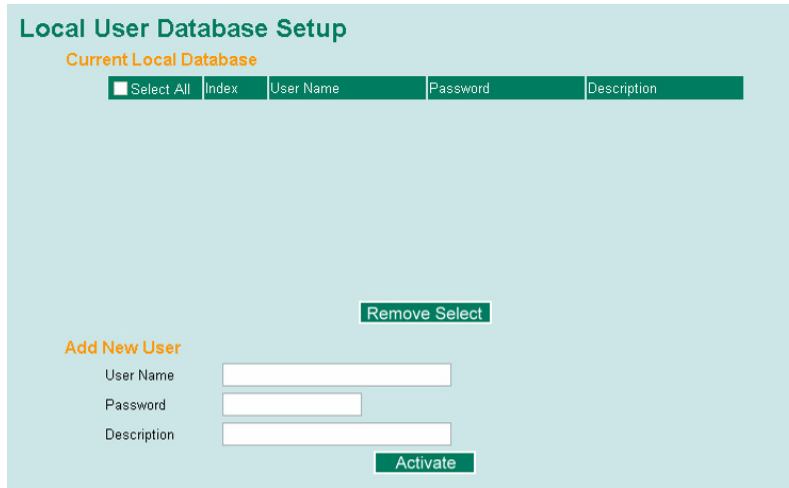

Local User Database Setup

Setting	Description	Factory Default
User Name (Max. of 30 characters)	User Name for the Local User Database	None
Password (Max. of 16 characters)	Password for the Local User Database	None
Description (Max. of 30 characters)	Description for the Local User Database	None

NOTE The user name for the Local User Database is case-insensitive.

Port Access Control Table



The port status will show authorized or unauthorized.

Using Auto Warning

Since industrial Ethernet devices are often located at the endpoints of a system, these devices will not always know what is happening elsewhere on the network. This means that an industrial Ethernet switch that connects to these devices must provide system maintainers with real-time alarm messages. Even when control engineers are out of the control room for an extended period of time, they can still be informed of the status of devices almost instantaneously when exceptions occur. The Moxa switch supports different approaches to warn engineers automatically, such as email and relay output. It also supports two digital inputs to integrate sensors into your system to automate alarms by email and relay output.

Configuring Email Warning

The Auto Email Warning function uses e-mail to alert the user when certain user-configured events take place. Three basic steps are required to set up the Auto Warning function:

Configure Email Event Types

Select the desired **Event types** from the Console or Web Browser Event type page (a description of each event type is given later in the *Email Alarm Events setting* subsection).

Configure Email Settings

To configure a Moxa switch’s email setup from the serial, Telnet, or web console, enter your Mail Server IP/Name (IP address or name), Account Name, Account Password, Retype New Password, and the email address to which warning messages will be sent.

Activate your settings and if necessary, test the email

After configuring and activating your Moxa switch’s Event Types and Email Setup, you can use the **Test Email** function to see if your e-mail addresses and mail server address have been properly configured.

Configuring Event Types

Email Warning Events Settings

System Events

Switch Cold Start
 Switch Warm Start
 Power Transition(On->Off)
 Power Transition(Off->On)
 DI 1(Off)
 DI 1(On)
 Config. Change
 Auth. Failure
 Comm. Redundancy Topology Changed

Port Events

Port	Link-ON	Link-OFF	Traffic-Overload	Rx-Threshold(%)	Traffic-Duration(s)
1	<input type="checkbox"/>	<input type="checkbox"/>	<input type="checkbox"/>	0	1
2	<input type="checkbox"/>	<input type="checkbox"/>	<input type="checkbox"/>	0	1
3	<input type="checkbox"/>	<input type="checkbox"/>	<input type="checkbox"/>	0	1
4	<input type="checkbox"/>	<input type="checkbox"/>	<input type="checkbox"/>	0	1
5	<input type="checkbox"/>	<input type="checkbox"/>	<input type="checkbox"/>	0	1
6	<input type="checkbox"/>	<input type="checkbox"/>	<input type="checkbox"/>	0	1
7	<input type="checkbox"/>	<input type="checkbox"/>	<input type="checkbox"/>	0	1
8	<input type="checkbox"/>	<input type="checkbox"/>	<input type="checkbox"/>	0	1

Activate

Event Types can be divided into two basic groups: **System Events** and **Port Events**. System Events are related to the overall function of the switch, whereas Port Events are related to the activity of a specific port.

System Events	Warning e-mail is sent when...
Switch Cold Start	Power is cut off and then reconnected.
Switch Warm Start	Moxa switch is rebooted, such as when network parameters are changed (IP address, subnet mask, etc.).
Power Transition (On→Off)	Moxa switch is powered down.
Power Transition (Off→On)	Moxa switch is powered up.

DI1 (On→Off)	Digital Input 1 is triggered by on to off transition
DI1 (Off→On)	Digital Input 1 is triggered by off to on transition
Configuration Change Activated	Any configuration item has been changed.
Authentication Failure	An incorrect password was entered.
Comm. Redundancy Topology Changed	If any Spanning Tree Protocol switches have changed their position (applies only to the root of the tree). If the Master of the Turbo Ring has changed or the backup path is activated.

Port Events	Warning e-mail is sent when...
Link-ON	The port is connected to another device.
Link-OFF	The port is disconnected (e.g., the cable is pulled out, or the opposing device shuts down).
Traffic-Overload	The port's traffic surpasses the Traffic-Threshold for that port (provided this item is Enabled).
Traffic-Threshold (%)	Enter a nonzero number if the port's Traffic-Overload item is Enabled.
Traffic-Duration (sec.)	A Traffic-Overload warning is sent every Traffic-Duration seconds if the average Traffic-Threshold is surpassed during that time period.

NOTE The Traffic-Overload, Traffic-Threshold (%), and Traffic-Duration (sec.) Port Event items are related. If you Enable the Traffic-Overload event, then be sure to enter a nonzero Traffic-Threshold percentage, as well as a Traffic-Duration between 1 and 300 seconds.

NOTE The sender of warning e-mail messages will have the following form:
 Managed-Redundant-Switch-00000@Switch_Location
 where Managed-Redundant-Switch-00000 is the default Switch Name, 00000 is the Moxa switch's serial number, and Switch_Location is the default Server Location. Refer to the Basic Settings section to see how to modify Switch Name and Switch Location.

Configuring Email Settings

Email Warning Events Settings

Mail Server IP/Name:

Account Name :

Account Password :

Change Account Password

Old Password :

New Password :

Retype Password :

1st email address :

2nd email address :

3rd email address :

4th email address :

Mail Server IP/Name

Setting	Description	Factory Default
IP address	The IP Address of your email server.	None

Account Name

Setting	Description	Factory Default
Max. 45 of characters	Your email account.	None

Password Setting

Setting	Description	Factory Default
Disable/Enable to change password	To reset the password from the Web Browser interface, click the Change password check-box, type the Old password, type the New password, retype the New password, and then click Activate (Max. of 45 characters).	Disable
Old password	Type the current password when changing the password	None
New password	Type new password when enabled to change password; Max. 45 characters.	None
Retype password	If you type a new password in the Password field, you will be required to retype the password in the Retype new password field before updating the new password.	None

Email Address

Setting	Description	Factory Default
Max. of 30 characters	You can set up to 4 email addresses to receive alarm emails from the Moxa switch.	None

Send Test Email

After you complete the email settings, you should first click **Activate** to activate those settings, and then press the **Send Test Email** button to verify that the settings are correct.

NOTE Auto warning e-mail messages will be sent through an authentication protected SMTP server that supports the CRAM-MD5, LOGIN, and PAIN methods of SASL (Simple Authentication and Security Layer) authentication mechanism.

We strongly recommend not entering your Account Name and Account Password if auto warning e-mail messages can be delivered without using an authentication mechanism.

Configuring Relay Warning

The Auto Relay Warning function uses relay output to alert the user when certain user-configured events take place. There are two basic steps required to set up the Relay Warning function:

Configure Relay Event Types

Select the desired **Event types** from the Console or Web Browser Event type page (a description of each event type is given later in the *Relay Alarm Events setting* subsection).

Activate your settings

After completing the configuration procedure, you will need to activate your Moxa switch's Relay Event Types.

Configuring Event Types

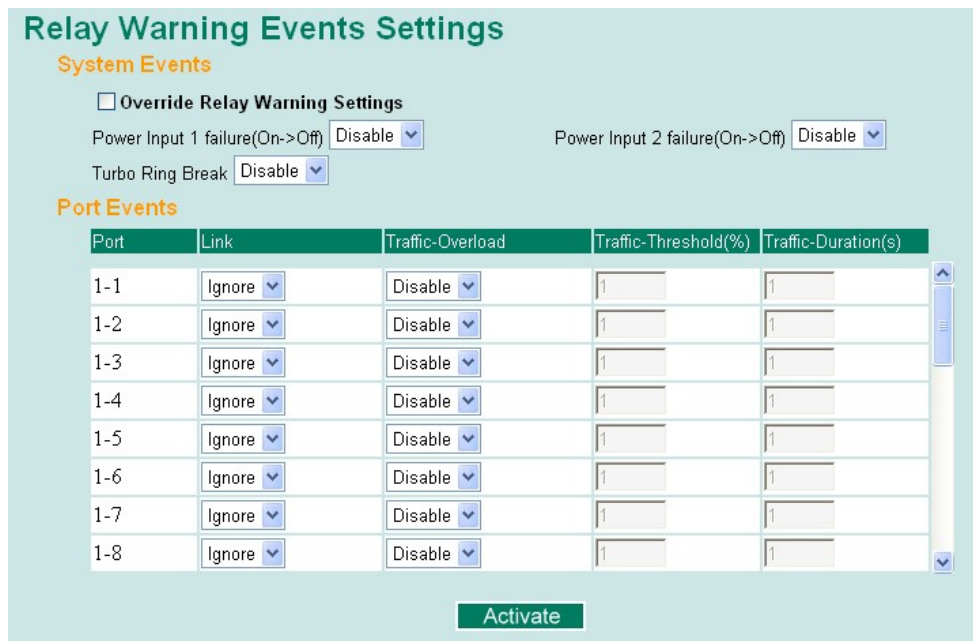

Event Types can be divided into two basic groups: **System Events** and **Port Events**. System Events are related to the overall function of the switch, whereas Port Events are related to the activity of a specific port.

The Moxa switch supports two relay outputs. You can configure which relay output is related to which events, which helps administrators identify the importance of the different events.

System Events	Warning Relay output is triggered when...
Power Transition (On→Off)	The Moxa switch is powered on.
Power Transition (Off→On)	The Moxa switch is powered down.

Port Events	Warning e-mail is sent when...
Link-ON	The port is connected to another device.
Link-OFF	The port is disconnected (e.g., the cable is pulled out, or the opposing device shuts down).
Traffic-Overload	The port’s traffic surpasses the Traffic-Threshold for that port (provided this item is Enabled).
Traffic-Threshold (%)	Enter a nonzero number if the port’s Traffic-Overload item is Enabled.
Traffic-Duration (sec.)	A Traffic-Overload warning is sent every Traffic-Duration seconds if the average Traffic-Threshold is surpassed during that time period.

NOTE The Traffic-Overload, Traffic-Threshold (%), and Traffic-Duration (sec) Port Event items are related. If you Enable the Traffic-Overload event, then be sure to enter a nonzero Traffic-Threshold percentage, as well as a Traffic-Duration between 1 and 300 seconds.

Override relay alarm settings

Checkmark the checkbox to override the relay warning setting temporarily. Releasing the relay output will allow administrators to fix any problems with the warning condition.

Warning List

Use this table to see if any relay alarms have been issued.



Using Line-Swap-Fast-Recovery

The Line-Swap Fast Recovery function, which is enabled by default, allows the Moxa switch to return to normal operation extremely quickly after devices are unplugged and then re-plugged into different ports. The recovery time is on the order of a few milliseconds (compare this with standard commercial switches for which the recovery time could be on the order of several minutes). To disable the Line-Swap Fast Recovery function, or to re-enable the function after it has already been disabled, access either the Console utility's **Line-Swap recovery** page, or the Web Browser interface's **Line-Swap fast recovery** page, as shown below.

Configuring Line-Swap Fast Recovery

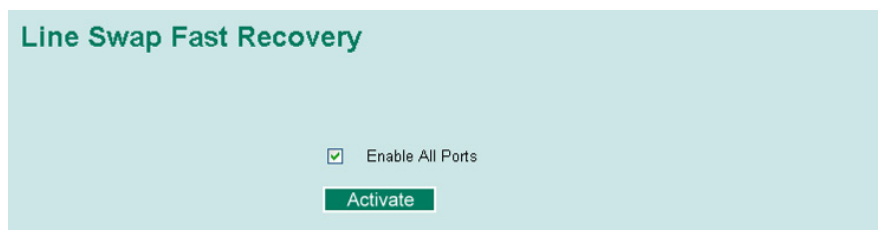

Enable Line-Swap-Fast-Recovery

Setting	Description	Factory Default
Enable/Disable	Checkmark the checkbox to enable the Line-Swap-Fast-Recovery function	Enable

Using Set Device IP

To reduce the effort required to set up IP addresses, the Moxa switch comes equipped with DHCP/BootP server and RARP protocol to set up IP addresses of Ethernet-enabled devices automatically.

When enabled, the **Set device IP** function allows the Moxa switch to assign specific IP addresses automatically to connected devices that are equipped with *DHCP Client* or *RARP* protocol. In effect, the Moxa switch acts as a DHCP server by assigning a connected device with a specific IP address stored in its internal memory. Each time the connected device is switched on or rebooted, the Moxa switch sends the device the desired IP address.

Take the following steps to use the **Set device IP** function:

STEP 1—Set up the connected devices

Set up those Ethernet-enabled devices connected to the Moxa switch for which you would like IP addresses to be assigned automatically. The devices must be configured to obtain their IP address automatically.

The devices' configuration utility should include a setup page that allows you to choose an option similar to the *Obtain an IP address automatically* option.

For example, Windows' TCP/IP Properties window is shown at the right. Although your device's configuration utility may look quite a bit different, this figure should give you some idea of what to look for.

You also need to decide which of the Moxa switch's ports your Ethernet-enabled devices will be connected to. You will need to set up each of these ports separately, as described in the following step.

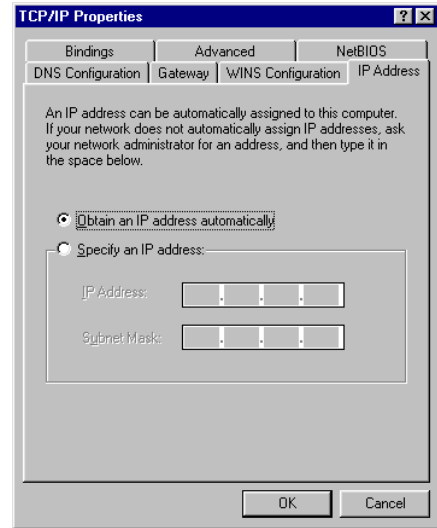

STEP 2

Configure the Moxa switch's **Set device IP** function, either from the Console utility or from the Web Browser interface. In either case, you simply need to enter the **Desired IP** for each port that needs to be configured.

STEP 3

Be sure to activate your settings before exiting.

- When using the Web Browser interface, activate by clicking on the Activate button.
- When using the Console utility, activate by first highlighting the **Activate** menu option, and then press **Enter**. You should receive the **Set device IP settings are now active! (Press any key to continue)** message.

Configuring Set Device IP

Automatic "Set Device IP" by DHCP/BootP/RARP

Automatic Set Device IP by DHCP/BootP/RARP

Port	Device's current IP	Active function	Desired IP address
1-1	NA	--	<input type="text"/>
1-2	NA	--	<input type="text"/>
1-3	NA	--	<input type="text"/>
1-4	NA	--	<input type="text"/>
1-5	NA	--	<input type="text"/>
1-6	NA	--	<input type="text"/>
1-7	NA	--	<input type="text"/>
1-8	NA	--	<input type="text"/>
2-1	NA	--	<input type="text"/>
2-2	NA	--	<input type="text"/>
2-3	NA	--	<input type="text"/>
2-4	NA	--	<input type="text"/>

Activate

Desired IP Address

Setting	Description	Factory Default
IP Address	Set the desired IP of connected devices.	None

Option 82 is used by the relay agent to insert additional information into the client’s DHCP request. The Relay Agent Information option is inserted by the DHCP relay agent when forwarding client-originated DHCP packets to a DHCP server. Servers can recognize the Relay Agent Information option and use the information to implement IP addresses to Clients.

When Option 82 is enabled on the switch, a subscriber device is identified by the switch port through which it connects to the network (in addition to its MAC address). Multiple hosts on the subscriber LAN can be connected to the same port on the access switch and are uniquely identified.

The Option 82 information contains 2 sub-options, Circuit ID and Remote ID, which define the relationship between the end device IP and the DHCP Option 82 server. The **Circuit ID** is a 4-byte number generated by the Ethernet switch—a combination of physical port number and VLAN ID. The format of the **Circuit ID** is shown below:

FF-VV-VV-PP

This is where the first byte “FF” is fixed to “01”, the second and the third byte “VV-VV” is formed by the port VLAN ID in hex, and the last byte “PP” is formed by the port number in hex. For example:

01-00-0F-03 is the “Circuit ID” of port number 3 with port VLAN ID 15.

The “Remote ID” identifies the relay agent itself and can be one of the following:

1. The IP address of the relay agent.
2. The MAC address of the relay agent.
3. A combination of IP address and MAC address of the relay agent.
4. A user-defined string.

Configuring DHCP Relay Agent

DHCP Relay Agent

Server IP Address

1st Server

2nd Server

3rd Server

4th Server

DHCP Option 82

Enable Option 82

Type

Value

Display

DHCP Function Table

Port	Circuit-ID	Option 82
1-1	01000101	<input type="checkbox"/> Enable
1-2	01000102	<input type="checkbox"/> Enable
1-3	01000103	<input type="checkbox"/> Enable
1-4	01000104	<input type="checkbox"/> Enable
1-5	01000105	<input type="checkbox"/> Enable
1-6	01000106	<input type="checkbox"/> Enable
1-7	01000107	<input type="checkbox"/> Enable

Activate

Server IP Address

1st Server

Setting	Description	Factory Default
IP address for the 1st DHCP server	Assigns the IP address of the 1st DHCP server that the switch tries to access.	None

2nd Server

Setting	Description	Factory Default
IP address for the 2nd DHCP server	Assigns the IP address of the 2nd DHCP server that the switch tries to access.	None

3rd Server

Setting	Description	Factory Default
IP address for the 3rd DHCP server	Assigns the IP address of the 3rd DHCP server that the switch tries to access.	None

4th Server

Setting	Description	Factory Default
IP address for the 4th DHCP server	Assigns the IP address of the 4th DHCP server that the switch tries to access.	None

DHCP Option 82

Enable Option 82

Setting	Description	Factory Default
Enable or Disable	Enable or disable the DHCP Option 82 function.	Disable

Type

Setting	Description	Factory Default
IP	Uses the switch's IP address as the remote ID sub.	IP
MAC	Uses the switch's MAC address as the remote ID sub.	IP
Client-ID	Uses a combination of the switch's MAC address and IP address as the remote ID sub.	IP
Other	Uses the user-designated ID sub.	IP

Value

Setting	Description	Factory Default
Max. 12 characters	Displays the value that was set. Complete this field if type is set to Other.	Switch IP address

Display

Setting	Description	Factory Default
<i>read-only</i>	The actual hexadecimal value configured in the DHCP server for the Remote-ID. This value is automatically generated according to the Value field. Users cannot modify it.	COA87FFD

DHCP Function Table

Enable

Setting	Description	Factory Default
Enable or Disable	Enable or disable the DHCP Option 82 function for this port.	Disable

Using Diagnosis

The Moxa switch provides three important tools for administrators to diagnose network systems.

Mirror Port

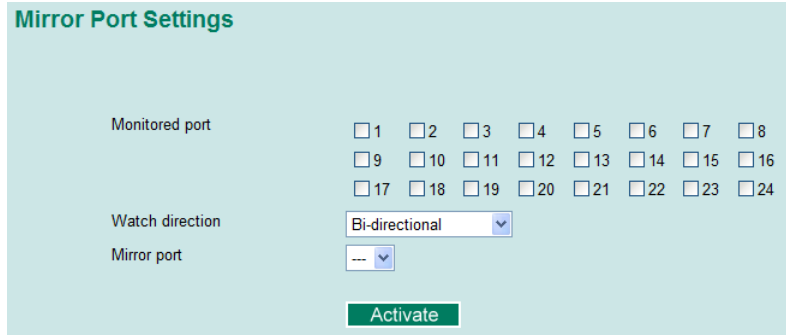

The **Mirror port** function can be used to monitor data being transmitted through a specific port. This is done by setting up another port (the *mirror port*) to receive the same data being transmitted from, or both to and from, the port under observation. Using a mirror port allows the network administrator to **sniff** the observed port to keep tabs on network activity.

Take the following steps to set up the **Mirror Port** function:

STEP 1

Configure the Moxa switch’s **Mirror Port** function from either the Console utility or Web Browser interface. You will need to configure three settings:

Monitored Port	Select the port number of the port whose network activity will be monitored.
Mirror Port	Select the port number of the port that will be used to monitor the activity of the monitored port.
Watch Direction	Select one of the following two watch direction options: <ul style="list-style-type: none"> • Input data stream: Select this option to monitor only those data packets coming into the Moxa switch’s port. • Output data stream: Select this option to monitor only those data packets being sent out through the Moxa switch’s port. • Bi-directional: Select this option to monitor data packets both coming into, and being sent out through, the Moxa switch’s port.

STEP 2

Be sure to activate your settings before exiting:

- When using the Web Browser interface, activate by clicking on the **Activate** button.
- When using the Console utility, activate by first highlighting the Activate menu option, and then press **Enter**. You should receive the **Mirror port settings are now active! (Press any key to continue)** message.

Ping

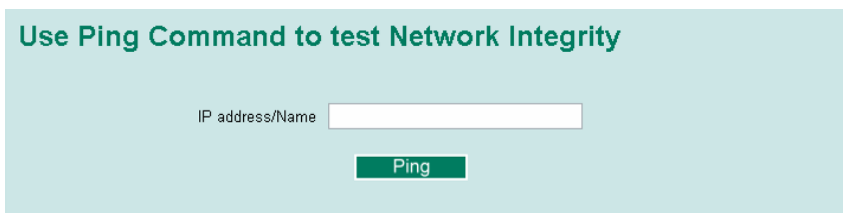

The **Ping** function uses the *ping* command to give users a simple but powerful tool for troubleshooting network problems. The function’s most unique feature is that even though the ping command is entered from the user’s PC keyboard, the actual ping command originates from the Moxa switch itself. In this way, the user can essentially sit on top of the Moxa switch and send ping commands out through its ports.

To use the Ping function, type in the desired IP address, and then press **Enter** from the Console utility, or click **Ping** when using the Web Browser interface.

LLDP Function

Overview

LLDP is an OSI Layer 2 protocol defined by IEEE 802.11AB. LLDP standardizes the self-identification advertisement method, and allows each networking device, such as a Moxa managed switch, to periodically send its system and configuration information to its neighbors. Because of this, all LLDP devices are kept informed of each other’s status and configuration, and with SNMP, this information can be transferred to Moxa’s MXview for auto-topology and network visualization.

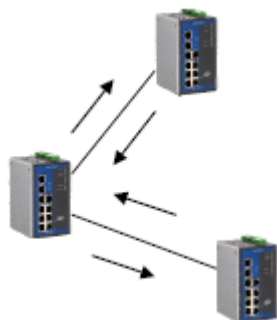

From the switch’s web interface, you can enable or disable LLDP, and set the LLDP transmit interval. In addition, you can view each switch’s neighbor-list, which is reported by its network neighbors. Most importantly, enabling the LLDP function allows Moxa’s MXview to automatically display the network’s topology and system setup details, such as VLAN and Trunking, for the entire network.

Configuring LLDP Settings

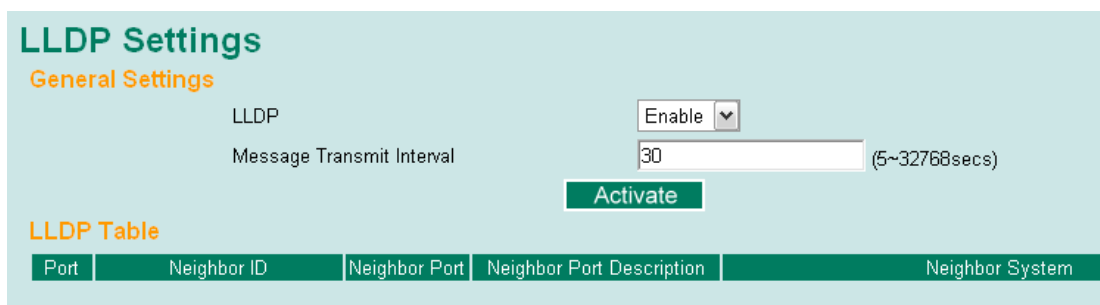

General Settings

LLDP

Setting	Description	Factory Default
Enable or Disable	Enables or disables the LLDP function.	Enable

Message Transmit Interval

Setting	Description	Factory Default
5 to 32768 sec.	Sets the transmit interval of LLDP messages, in seconds.	30 (seconds)

LLDP Table

The LLDP Table displays the following information:

Port	The port number that connects to the neighbor device.
Neighbor ID	A unique entity (typically the MAC address) that identifies a neighbor device.
Neighbor Port	The port number of the neighbor device.
Neighbor Port Description	A textual description of the neighbor device’s interface.
Neighbor System	Hostname of the neighbor device.

Using Monitor

You can monitor statistics in real time from the Moxa switch’s web console and serial console.

Monitor by Switch

Access the Monitor by selecting **System** from the left selection bar. Monitor by System allows the user to view a graph that shows the combined data transmission activity of all of the Moxa switch’s 18 ports. Click one of the four options—**Total Packets**, **TX Packets**, **RX Packets**, or **Error Packets**—to view transmission activity of specific types of packets. Recall that TX Packets are packets sent out from the Moxa switch, RX Packets are packets received from connected devices, and Error Packets are packets that did not pass TCP/IP’s error checking algorithm. The Total Packets option displays a graph that combines TX, RX, and TX Error, RX Error Packets activity. The graph displays data transmission activity by showing **Packets/s** (i.e., packets per second, or pps) versus **sec.** (seconds). In fact, three curves are displayed on the same graph: **Uni-cast** packets (in red color), **Multi-cast** packets (in green color), and **Broad-cast** packets (in blue color). The graph is updated every few seconds, allowing the user to analyze data transmission activity in real-time.

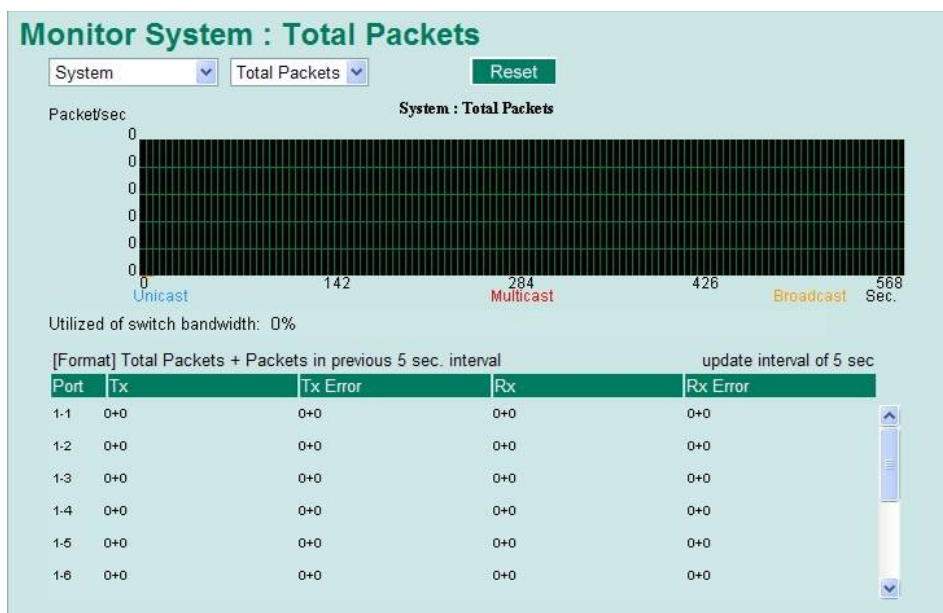

Monitor by Port

Access the Monitor by Port function by selecting **ALL 10/100M or 1G Ports** or **Port *i***, in which *i* = **1, 2, ..., G2**, from the left pull-down list. The **Port *i*** options are identical to the Monitor by System function discussed above, in that users can view graphs that show All Packets, TX Packets, RX Packets, or Error Packets activity, but in this case, only for an individual port. The **All Ports** option is essentially a graphical display of the individual port activity that can be viewed with the Console Monitor function discussed above. The All Ports option shows three vertical bars for each port. The height of the bar represents **Packets/s** for the type of packet, at the instant the bar is being viewed. That is, as time progresses, the height of the bar moves up or down so that the user can view the change in the rate of packet transmission. The blue colored bar shows **Uni-cast** packets, the red colored bar shows **Multi-cast** packets, and the orange colored bar shows **Broad-cast** packets. The graph is updated every few seconds, allowing the user to analyze data transmission activity in real-time.

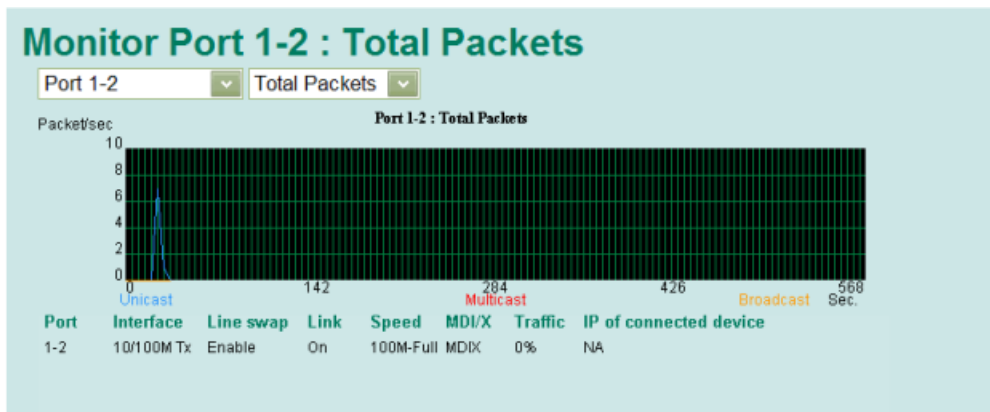

Monitor by SFP

Optical fiber is commonly used for long distance data transmission. However, when link issues occur, it is very costly to trouble shoot the fiber cable and fiber transceiver at remote sites. To solve this problem, Moxa industrial Ethernet switches provide digital diagnostic and monitoring functions on Moxa SFP optical fiber links and allow users to measure optical parameters and its performance from center site. This function can greatly facilitate the trouble shooting process for optical fiber links and reduce costs for onsite debug.

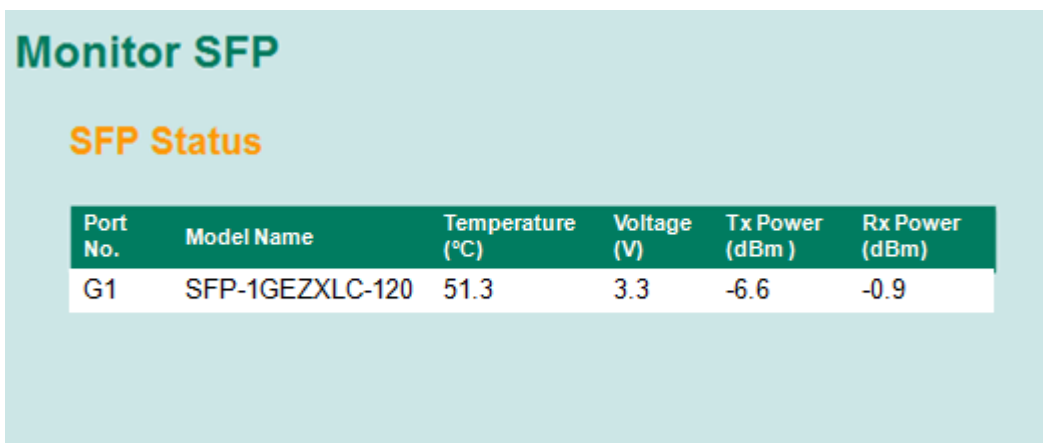

Parameter	Description
Port No.	Switch port number with SFP plugged in
Model Name	Moxa SFP model name
Temperature (°C)	SFP casing temperature
Voltage (V)	Voltage supply to the SFP
Tx power (dBm)	The amount of light being transmitted into the fiber optic cable
Rx power (dBm)	The amount of light being received from the fiber optic cable

NOTE Certain tolerances exist between real data and measured data

Parameters	Tolerance
Temperature (°C)	± 3°C
Voltage (V)	± 0.1V
Tx power (dBm)	± 3dB
Rx power (dBm)	± 3dB

Using the MAC Address Table

This section explains the information provided by the Moxa switch's MAC address table.

All MAC Address List

All Page 1/1

Index	MAC	Type	Port
1	00-16-d3-c8-f4-88	ucast()	1-2

The MAC Address table can be configured to display the following Moxa switch MAC address groups, which are selected from the drop-down list:

ALL	Select this item to show all of the Moxa switch's MAC addresses.
ALL Learned	Select this item to show all of the Moxa switch's Learned MAC addresses.
ALL Static Lock	Select this item to show all of the Moxa switch's Static Lock MAC addresses.
ALL Static	Select this item to show all of the Moxa switch's Static, Static Lock, and Static Multicast MAC addresses.
ALL Static Multicast	Select this item to show all of the Moxa switch's Static Multicast MAC addresses.
Port x	Select this item to show all of the MAC addresses dedicated ports.

The table displays the following information:

MAC	This field shows the MAC address.
Type	This field shows the type of this MAC address.
Port	This field shows the port that this MAC address belongs to.

Using Event Log

Event Log Table

Page 67/67

Index	Bootup	Date	Time	System Startup Time	Event
991	419	--	--	0d0h42m37s	Port 1-2 link off
992	420	--	--	0d0h0m1s	Cold start
993	420	--	--	0d0h0m3s	Port 3-8 link on
994	420	--	--	0d0h1m14s	192.168.127.1 admin Auth. ok
995	420	--	--	0d0h1m54s	Port 3-8 link off
996	421	--	--	0d0h0m1s	Cold start
997	421	--	--	0d0h0m4s	Port 1-2 link on
998	421	--	--	0d0h0m12s	192.168.127.1 admin Auth. ok
999	421	--	--	0d0h53m26s	Configuration change activated
1000	421	--	--	0d0h53m33s	192.168.127.1 admin Auth. ok

Clear

The Event Log Table displays the following information:

Bootup	This field shows how many times the Moxa switch has been rebooted or cold started.
Date	The date is updated based on how the current date is set in the Basic Setting page.
Time	The time is updated based on how the current time is set in the Basic Setting page.
System Startup Time	The system startup time related to this event.
Events	Events that have occurred.

NOTE The following events will be recorded into the Moxa switch's Event Log Table:

- Cold start
- Warm start
- Configuration change activated
- Power 1/2 transition (Off (On), Power 1/2 transition (On (Off))
- Authentication fail
- Topology changed
- Master setting is mismatched
- Port traffic overload
- dot1x Auth Fail
- Port link off/on

Using Syslog

The Syslog function provides the event logs for the syslog server. The function supports 3 configurable syslog servers and syslog server UDP port numbers. When an event occurs, the event will be sent as a syslog UDP packet to the specified syslog servers.

Syslog Settings

Syslog Server 1

Port Destination (1~65535)

Syslog Server 2

Port Destination (1~65535)

Syslog Server 3

Port Destination (1~65535)

Activate

Syslog Server 1/2/3

Setting	Description	Factory Default
IP Address	Enter the IP address of Syslog server 1/2/3, used by your network.	None
Port Destination (1 to 65535)	Enter the UDP port of Syslog server 1/2/3.	514

NOTE The following events will be recorded into the Moxa switch's Event Log table, and will then be sent to the specified Syslog Server:

- Cold start
- Warm start
- Configuration change activated
- Power 1/2 transition (Off (On), Power 1/2 transition (On (Off))
- Authentication fail
- Topology changed
- Master setting is mismatched
- Port traffic overload
- dot1x Auth Fail
- Port link off/on

Using HTTPS/SSL

To secure your HTTP access, the Moxa switch supports HTTPS/SSL to encrypt all HTTP traffic. Perform the following steps to access the Moxa switch's web browser interface via HTTPS/SSL.

1. Open Internet Explorer and type **https://{Moxa switch's IP address}** in the address field. Press Enter to establish the connection.

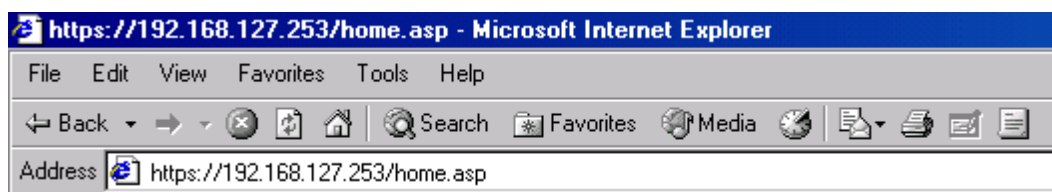

- Warning messages will pop up to warn the user that the security certificate was issued by a company they have not chosen to trust.



- Select **Yes** to enter the Moxa switch's web browser interface and access the web browser interface secured via HTTPS/SSL.

NOTE Moxa provides a Root CA certificate. After installing this certificate on your PC or notebook, you can access the web browser interface directly and you will no longer see any warning messages. You may download the certificate from the Moxa switch's CD-ROM.

EDS Configurator GUI

EDS Configurator is a comprehensive Windows-based GUI that is used to configure and maintain multiple Moxa switches. A suite of useful utilities is available to help you locate Moxa switches attached to the same LAN as the PC host (regardless of whether or not you know the IP addresses of the switches), connect to a Moxa switch whose IP address is known, modify the network configurations of one or multiple Moxa switches, and update the firmware of one or more Moxa switch. EDS Configurator is designed to provide you with instantaneous control of *all* of your Moxa switches, regardless of location. You may download the EDS Configurator software from Moxa's website free of charge.

The following topics are covered in this chapter:

- **Starting EDS Configurator**
- **Broadcast Search**
- **Search by IP Address**
- **Upgrade Firmware**
- **Modify IP Address**
- **Export Configuration**
- **Import Configuration**
- **Unlock Server**

Starting EDS Configurator

To start EDS Configurator, locate and run the executable file **edscfgui.exe**. There are two ways to do this:

- If the file was placed on the Windows desktop, it should appear as shown below. Simply double click the icon to run the program.

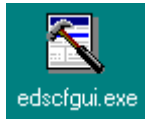

- The Moxa EtherDevice Server Configurator window will open, as shown below.

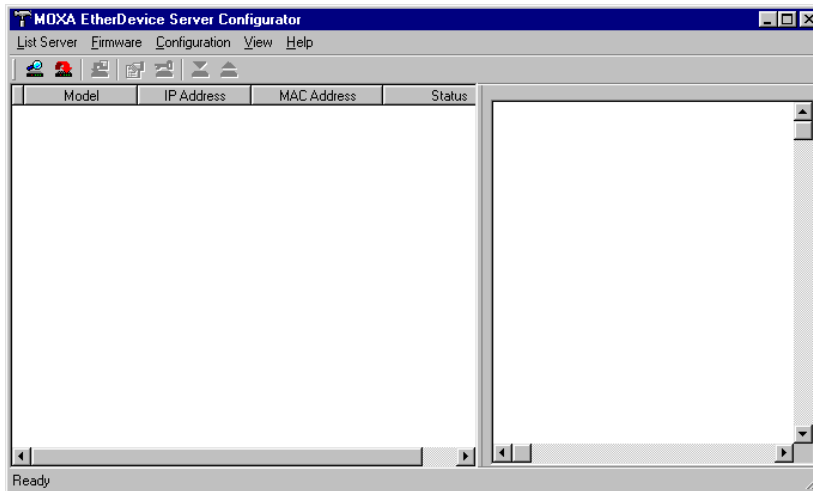

NOTE You may download the EDS Configurator software free of charge from Moxa's website at www.moxa.com.

Broadcast Search

Use the **Broadcast Search** utility to search the LAN for all Moxa switches that are connected to the LAN. Note that since the search is done by MAC address, **Broadcast Search** will not be able to locate Moxa EtherDevice switches connected outside the PC host's LAN.

1. Start by clicking the Broadcast Search icon , or select **Broadcast Search** under the **List Server** menu. The Broadcast Search window will open and display a list of all switches located on the network. Look in the **Progress** column to see the progress of the search.

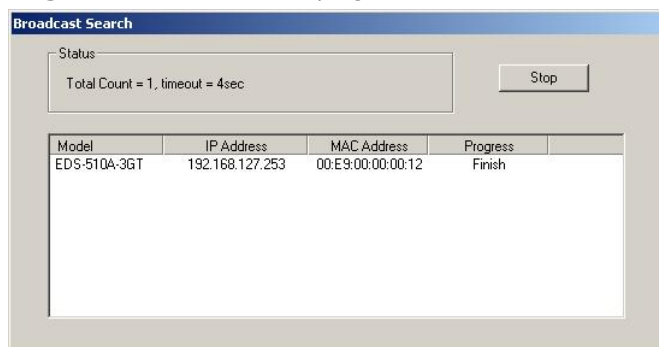

- Once the search is complete, the Configurator window will display a list of all switches that were located.

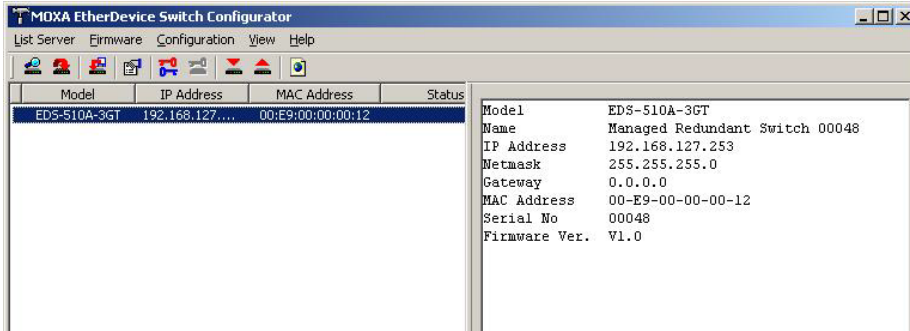

Search by IP Address

Use the **Search by IP Address** utility to search for Moxa switches one at a time. Note that the search is conducted by IP address, so you should be able to locate any Moxa switch that is properly connected to your LAN, WAN, or the Internet.

- Start by clicking the **Specify by IP address** icon , or by selecting **Specify IP address** under the **List Server** menu. The **Search Server with IP Address** window will open. Enter the IP address of the switch you wish to search for, and then click **OK**.

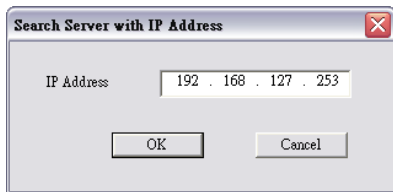

- Once the search is complete, the Configurator window will add the switch to the list of switches.

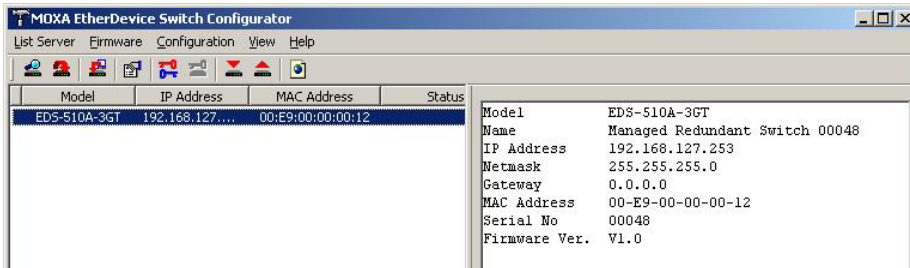

Upgrade Firmware

Keep your Moxa switch up to date with the latest firmware from Moxa. Perform the following steps to upgrade the firmware:

- Download the updated firmware (*.rom) file from Moxa's website (www.moxa.com).
- Click the switch (from the **Moxa EtherDevice Server Configurator** window) whose firmware you wish to upgrade to highlight it.

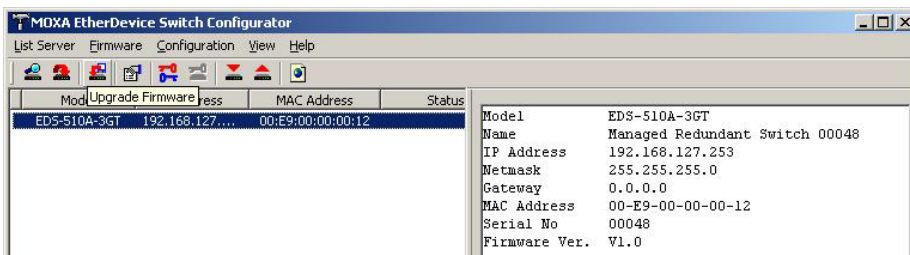

3. Click the **Upgrade Firmware** toolbar icon , or select **Upgrade** under the **Firmware** menu. If the switch is Locked, you will be prompted to input the switch's User Name and Password.
4. Use the **Open** window to navigate to the folder that contains the firmware upgrade file, and then click the correct "*.rom" file (**eds.rom** in the example shown below) to select the file. Click **Open** to activate the upgrade process.

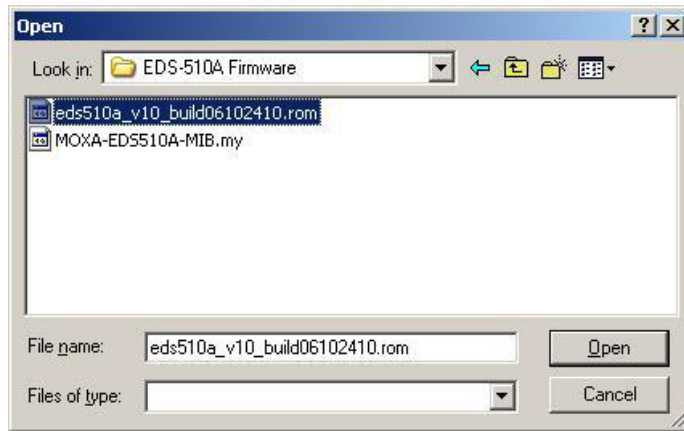

Modify IP Address

You may use the **Modify IP Address** function to reconfigure the Moxa switch's network settings.

1. Start by clicking the Modify IP address icon , or by selecting **Modify IP address** under the **Configuration** menu.
2. The **Setup Configuration** window will open. Checkmark the box to the left of those items that you wish to modify, and then Disable or Enable DHCP, and enter the IP Address, Subnet mask, Gateway, and DNS IP. Click **OK** to accept the changes to the configuration.

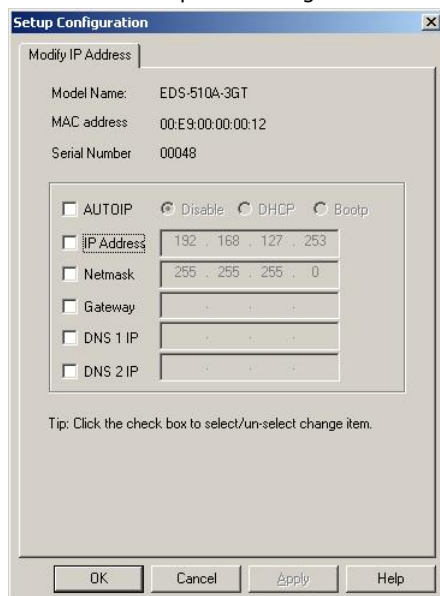

Export Configuration

The **Export Configuration** utility is used to save the entire configuration of a particular Moxa switch to a text file. Take the following steps to export a configuration:

1. Highlight the switch (from the Server list in the Configurator window's left pane), and then click the **Export** toolbar icon , or select **Export Configuration** from the **Configuration** menu. Use the **Open** window to

navigate to the folder in which you would like to store the configuration, and then type the name of the file in the **File name** input box. Click **Open** to continue.

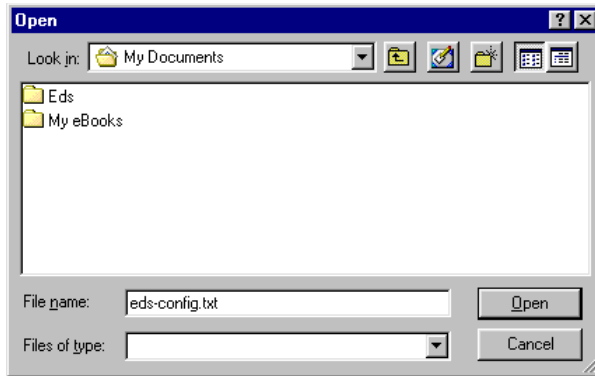

2. Click **OK** when the **Export configuration to file OK** message appears.



3. You may use a standard text editor, such as Notepad under Windows, to view and modify the newly created configuration file.



Import Configuration

The **Import Configuration** function is used to import an entire configuration from a text file to the Moxa switch. The utility can be used to transfer the configuration from one Moxa switch to another, by first using the Export Configuration function (described in the previous section) to save a switch configuration to a file, and then using the Import Configuration function. Perform the following steps to import a configuration:

1. Highlight the server (from the Moxa EtherDevice Switch list in the Configurator window's left pane), and then click the **Import** toolbar icon , or select **Import Configuration** from the **Configuration** menu.

- Use the **Open** window to navigate to the text file that contains the desired configuration. Once the file is selected, click **Open** to initiate the import procedure.

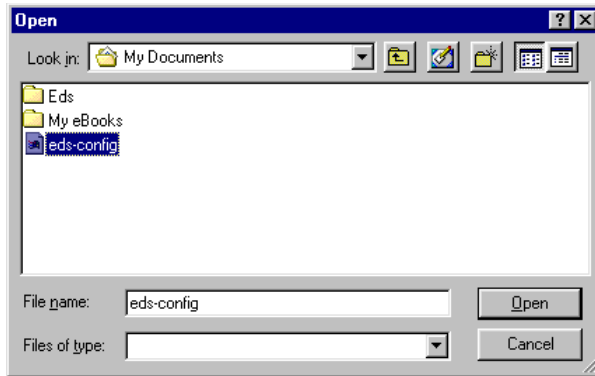

- The **Setup Configuration** window will be displayed, with a special note attached at the bottom. Parameters that have been changed will be indicated with a checkmark. You may make more changes if necessary, and then click **OK** to accept the changes.

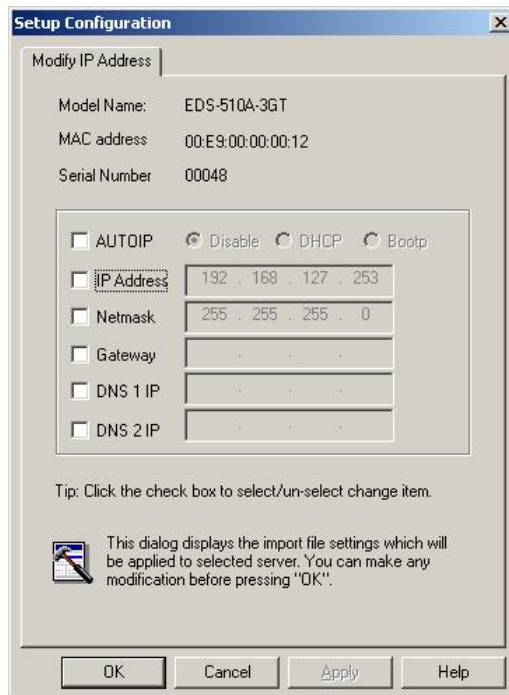

- Click **Yes** in response to the following warning message to accept the new settings.

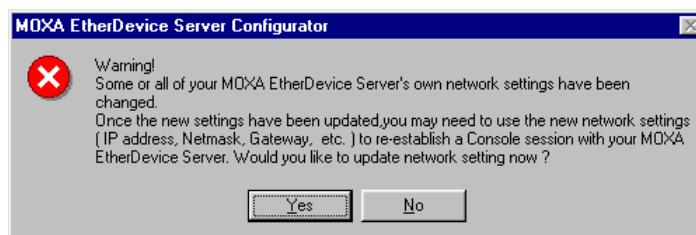

Unlock Server

The **Unlock Server** function is used to open a password protected switch so that the user can modify its configuration, import/export a configuration, and perform other procedures. There are six possible responses under the **Status** column. The **Status** of a Moxa switch indicates how Moxa EtherDevice Switch Configurator located the switch, and what type of password protection it has.

The six options are as follows (note that the term **Fixed** is borrowed from the standard *fixed IP address* networking terminology):

- **Locked**
The switch is password protected, **Broadcast Search** was used to locate it, and the password has not yet been entered from within the current Configurator session.
- **Unlocked**
The switch is password protected, **Broadcast Search** was used to locate it, and the password was entered from within the current Configurator session. Henceforth during this Configurator session, activating various utilities for this switch will not require re-entering the server password.
- **Blank**
The Moxa switch is not password protected, and **Broadcast Search** was used to locate it.

Follow the steps given below to unlock a locked Moxa switch (i.e., Moxa switch with Status "Locked" or "Locked Fixed"). Highlight the server (from the Moxa EtherDevice Switch list in the Configurator window's left pane), and then click the **Unlock** toolbar icon , or select **Unlock** from the **Configuration** menu.

1. Enter the switch's **User Name** and **Password** when prompted, and then click **OK**.

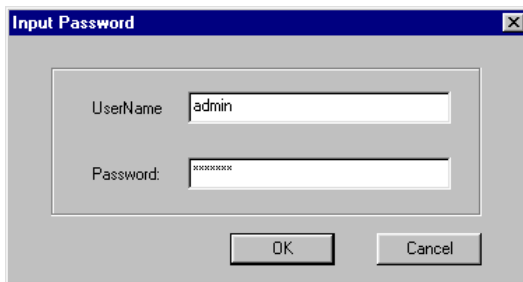

2. When the **Unlock status** window indicates the Progress as **OK**, click the **Close** button in the upper right corner of the window.

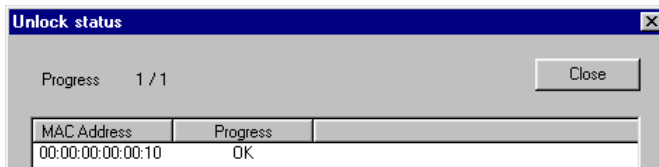

3. The status of the switch will now be shown as **Unlocked**.

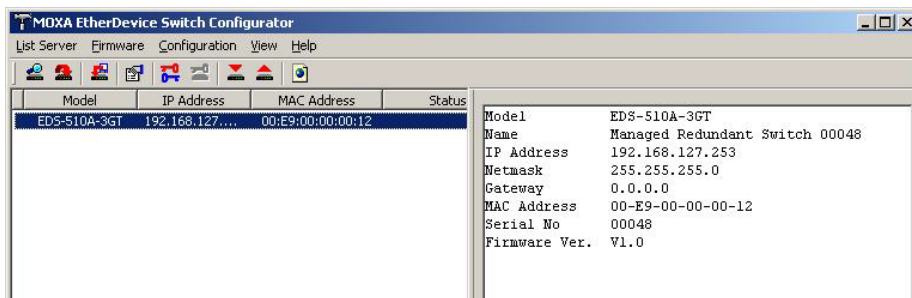

MIB Groups

The Moxa switch comes with built-in SNMP (Simple Network Management Protocol) agent software that supports cold/warm start trap, line up/down trap, and RFC 1213 MIB-II.

The standard MIB groups that the Moxa switch supports are as follows:

MIB II.1—System Group

- sysORTable

MIB II.2—Interfaces Group

- ifTable

MIB II.4 – IP Group

- ipAddrTable
- ipNetToMediaTable
- IpGroup
- IpBasicStatsGroup
- IpStatsGroup

MIB II.5—ICMP Group

- IcmpGroup
- IcmpInputStatus
- IcmpOutputStats

MIB II.6—TCP Group

- tcpConnTable
- TcpGroup
- TcpStats

MIB II.7—UDP Group

- udpTable
- UdpStats

MIB II.10—Transmission Group

- dot3
- dot3StatsTable

MIB II.11—SNMP Group

- SnmpBasicGroup
- SnmpInputStats
- SnmpOutputStats

MIB II.17—dot1dBridge Group

- dot1dBase
 - dot1dBasePortTable
- dot1dStp
 - dot1dStpPortTable
- dot1dTp
 - dot1dTpFdbTable

```
dot1dTpPortTable
dot1dTpHCPortTable
dot1dTpPortOverflowTable
pBridgeMIB
  dot1dExtBase
  dot1dPriority
  dot1dGarp
qBridgeMIB
  dot1qBase
  dot1qTp
    dot1qFdbTable
    dot1qTpPortTable
    dot1qTpGroupTable
    dot1qForwardUnregisteredTable
  dot1qStatic
    dot1qStaticUnicastTable
    dot1qStaticMulticastTable
  dot1qVlan
    dot1qVlanCurrentTable
    dot1qVlanStaticTable
    dot1qPortVlanTable
```

The Moxa switch also provides a private MIB file, located in the file **Moxa-[switch's model name]-MIB.my** on the Moxa switch utility CD-ROM.

Public Traps

- Cold Start
- Link Up
- Link Down
- Authentication Failure
- dot1dBridge New Root
- dot1dBridge Topology Changed

Private Traps

- Configuration Changed
- Power On
- Power Off
- Traffic Overloaded
- Turbo Ring Topology Changed
- Turbo Ring Coupling Port Changed
- Turbo Ring Master Mismatch