

Moxa VPort 251 Video Encoder

User's Manual

Second Edition, June 2008



© 2008 Moxa Inc., all rights reserved.
Reproduction without permission is prohibited.

Moxa VPort 251 Video Encoder User's Manual

The software described in this manual is furnished under a license agreement and may be used only in accordance with the terms of that agreement.

Copyright Notice

Copyright © 2008 Moxa Inc.
All rights reserved.
Reproduction without permission is prohibited.

Trademarks

MOXA is a registered trademark of Moxa Inc.
All other trademarks or registered marks in this manual belong to their respective manufacturers.

Disclaimer

Information in this document is subject to change without notice and does not represent a commitment on the part of Moxa.

Moxa provides this document “as is,” without warranty of any kind, either expressed or implied, including, but not limited to, its particular purpose. Moxa reserves the right to make improvements and/or changes to this manual, or to the products and/or the programs described in this manual, at any time.

Information provided in this manual is intended to be accurate and reliable. However, Moxa Networking assumes no responsibility for its use, or for any infringements on the rights of third parties that may result from its use.

This product might include unintentional technical or typographical errors. Changes are periodically made to the information herein to correct such errors, and these changes are incorporated into new editions of the publication.

Technical Support Contact Information

www.moxa.com/support

Moxa Americas:

Toll-free: 1-888-669-2872
Tel: +1-714-528-6777
Fax: +1-714-528-6778

Moxa China (Shanghai office):

Toll-free: 800-820-5036
Tel: +86-21-5258-9955
Fax: +86-10-6872-3958

Moxa Europe:

Tel: +49-89-3 70 03 99-0
Fax: +49-89-3 70 03 99-99

Moxa Asia-Pacific:

Tel: +886-2-8919-1230
Fax: +886-2-8919-1231

Before getting started

Before using your VPort 251, please pay close attention to the following items:

- ❑ After opening the VPort 251 box, compare the contents of the box with the **Package Checklist in Chapter 1**. Notify your sales representative if any of the items is missing or damaged.
- ❑ To prevent damage or problems caused by improper usage, before assembling and operating the device and peripherals, read the **Quick Installation Guide** (the printed handbook included in the package). You may also refer to **Chapter 1**, under **Product Description**, and all of **Chapter 2**, of this manual.
- ❑ If you experience a system error, and the system does not recover easily, refer to the **Troubleshooting** section in **Chapter 7** to learn how to restore factory default settings and reinstall the system.
- ❑ The VPort 251 Video Encoder has been designed for various environments and can be used to build various applications for general security or demonstration purposes. For standard applications, refer **Chapter 2, Getting Started**, and **Chapter 3, Accessing VPort 251 Video Encoder for the First Time**.

Important Note

- ❑ Surveillance devices may be prohibited by law in your country. Since VPort is both a high performance surveillance system and networked video server, ensure that the operations of such devices are legal in your locality before installing this unit for surveillance purposes.

Table of Contents

Chapter 1	Introduction	1-1
	Overview.....	1-2
	Package Checklist.....	1-4
	Product Features	1-4
	Typical Application.....	1-5
	Panel Layout of the VPort 251.....	1-6
	Product Description	1-7
Chapter 2	Getting Started	2-1
	Before Getting Started	2-2
	Initial Installation and Configuration.....	2-2
	RS-232 Console Configuration (115200, None, 8, 1, VT1 00)	2-8
	Mounting the VPort 251	2-12
	Mounting Dimension (Unit=mm).....	2-12
	DIN-Rail Mounting (Optional).....	2-13
	Wall Mounting.....	2-13
	Wiring Requirements	2-14
	Grounding the VPort 251.....	2-14
	Wiring the Relay Output.....	2-14
	Wiring the Digital Inputs.....	2-15
	RS-232 Connection.....	2-15
	10/100BaseT(X) Ethernet Port Connection.....	2-16
	PTZ Port	2-17
Chapter 3	Accessing VPort 251's Web-based Manager.....	3-1
	Functions Featured on the VPort's Web Homepage.....	3-2
	VPort's Information.....	3-2
	Server Name	3-3
	Camera Image View	3-3
	Audio Control.....	3-3
	Client Setting.....	3-3
	System Configuration.....	3-4
	Video Information	3-4
	PTZ Control Panel.....	3-4
	PTZ (Motorized) Camera Control	3-5
	Custom PTZ Camera Commands	3-6
	Video Image Snapshots	3-6
	Relay Control.....	3-6
Chapter 4	System Configuration	4-1
	System Configuration by Web Console	4-2
	System	4-3
	Network.....	4-9
	Video	4-24
	Audio.....	4-32
	Alarm.....	4-32
Appendix A	Frequently Asked Questions	A-1
Appendix B	Settings of Supported PTZ Cameras.....	B-1

Appendix C Time Zone Table..... C-1
Appendix D Technical Specifications D-1

1

Introduction

The VPort 251 is a high-performance networking video encoder. In addition to being able to handle basic video feeds, many advanced features are also included to set up surveillance or web attraction applications. The VPort 251 is designed to be stable, compact, easy to use, and versatile.

The following topics are covered in this chapter:

- Overview**
- Package Checklist**
- Product Features**
- Typical Application**
- Panel Layout of the VPort 251**
- Product Description**

Overview

The VPort 251 is a high performance, 1-channel video encoder with compact form factor that is suitable for installation in a variety of locations, including outdoor camera cabinets. To make installation easier, the VPort 251 supports both panel mounting and DIN-Rail mounting (with DK-35A accessory), and 1 loop-through power output for powering an analog camera. In addition, the VPort 251 provides up to full D1, full frame rate video performance (NTSC: 720 x 480 up to 30 FPS; PAL: 720 x 576 up to 25 FPS) and supports both MPEG4 or MJPEG, making it especially well suited for use with distributed video surveillance systems. A 2-way audio function is also provided for the convenience of real-time communication between system administrators located at the central site, and engineers in the field.

High Performance MJPEG/MPEG4 compression

Video input can be efficiently compressed into MJPEG/MPEG4 video stream packets without delay. This is all done without sacrificing remote monitoring capability or storage. Five levels of compression quality and five different image resolutions are provided to provide greater versatility.

2-way audio supported for a complete surveillance solution

The VPort 251 supports both audio input and audio output for voice over IP communication between a field site and central site. The 2-way audio function not only saves time, but also saves the cost of needing to add additional communication devices (such as a phone).

Compact design and loop-through power output for camera housing installation

The VPort 251 is compact enough to meet a variety of installation requirements, especially as far as the camera housing is concerned. In general, video cameras used in outdoor environments will rely on the camera housing to protect the camera from rain, dust, temperature, and other environmental factors. In addition, the VPort 251 provides a loop-through power output to power an analog camera. This means that the VPort 251 can be installed with analog cameras in an outdoor camera housing.

RTSP streaming for easy integration

RTSP (Real-time Streaming Protocol) is a client-server multimedia presentation control protocol, which enables the interoperability of video devices and software. Hardware or software that supports RTSP streaming can easily identify and decode the video stream without the hassle of codec installation. For example, users can view video images from the VPort 251 directly with Quick Time and VLC, both of which support RTSP streaming.

Multicast (IGMP) transmission for network efficiency

Transmitting digital video images via an IP network requires a dozen times the bandwidth required for transmitting general data. For this reason, the efficiency of network bandwidth management is one of the most important issues that determines the performance of a video over IP surveillance system. The VPort 251 supports multicast transmission with IGMP protocol, which can reduce the bandwidth requirements when multiple clients access the same video stream, and greatly increases the efficiency of network bandwidth management.

Easy web access using standard browsers

There is no need to install new software to access the video encoder, since the embedded web server allows users to use any popular web browser to access the video encoder from anywhere over the Internet. As long as you are connected to the network, you will be able to view the same images seen by your cameras.

Support for SNMP V1, V2c, and V3 for easy network management

More and more IP devices are networked for use on one TCP/IP network. To make management and maintenance easier, SNMP (Simple Network Management Protocol) can be used to monitor all of these IP devices.

Built-in 3 area-selectable Video Motion Detection (VMD)

External sensors are not required, since the video channel can be configured to detect motion in 3 areas, making it easy to set up a security system in either your office or the field. And the customizable settings allow you to tune the system for both object size and sensitivity, making the video encoder adaptable to different environments.

Weekly schedule for automated surveillance

The user-defined time period will check security settings on a weekly basis, and send notifications or drive external devices, making the VPort 251 suitable for more versatile applications.

Flexible I/O control for external devices

1 opto-isolated sensor inputs and 1 relay outputs are provided to control external devices, giving system integrators the option of turning an analog system into an advanced security system.

Moxa SoftDVR Lite IP Surveillance Software

To extend the video encoder's capabilities, Moxa SoftDVR™ Lite IP Surveillance Software, which supports a maximum of 4 cameras in quad, is included free of charge, allowing users to turn their PC into a digital video recorder. Scheduling or one-click recording saves important images on your local hard disk, and the reliable motion detection and instant warning features make you ready for any situation. A quick and easy to use search and playback function lets you easily find the image you're looking for, so that you can inspect the images more carefully, and also save the output to an AVI file.

SDK support for developers

The high-performance video encoder can be integrated into many applications—without busting your budget—and the complete programming interface of Moxa VPort SDK PLUS makes the developer's job easy and straightforward. To ask about SDK requirements, please contact a Moxa sales representative for details and an application form.

Package Checklist

The Moxa VPort 251 is shipped with the following items. If any of these items are missing or damaged, please contact your customer service representative for assistance.

- 1 x VPort 251
- 1 x 5-pin terminal block for 1 DI and 1 relay output
- 1 x 2-pin terminal block for loop-through power output
- 1 x 5-pin terminal block for RS-232/422/485 PTZ control port
- Quick Installation Guide
- Power adaptor (Need to order separately)
- Document & Software CD (includes User's Manual, Quick Installation Guide, Moxa IVN Solution Datasheet, and VPort Utility)
- 4 pcs pad
- Warranty statement

NOTE: *Notify your sales representative if any of the above items is missing or damaged.*

Product Features

High Performance Video/Audio Networking Solution

- Supports NTSC/PAL analog video cameras
- Supports MPEG4/MJPEG video compression technology
- 1 BNC video input
- 1 audio input and 1 audio output for 2-way voice communication
- Standard RTSP (real-time streaming protocol) for easy integration
- Multicast (IGMP) protocols for efficient network transmission
- QoS (TOS) for priority transmission
- Full D1, 4CIF, VGA, CIF, and QVGA video resolution supported
- 1 auto-sensing 10/100BaseT(X) Ethernet port
- RS-232/RS-422/RS-485 COM port for controlling PTZ (PAN/TILT/ZOOM) motorized camera
- Transparent PTZ Control for camera control by legacy PTZ control panel or keyboard
- Built-in web server and RS-232 console for remote and local access & configuration
- TCP, UDP, and HTTP network transmission modes
- Allows simultaneous access of up to 10 clients
- Set video quality to CBR (constant bit rate) or VBR (variable bit rate)
- Timestamp and text overlay supported
- DDNS, UPnP and IP filtering supported

Intelligent Alarm Trigger

- Built-in Video Motion Detection (VMD)
- 1 digital input channel and 1 relay (digital) output channel for external sensor and alarm
- Alarm-triggered snapshots with pre-alarm and post-alarm snapshots
- Sequential snapshot images supported
- Messages with snapshot images can be sent via FTP or Email
- HTTP Action setting for alarm messages sent by HTTP event server
- Configure alarm activation schedule

Convenient Hardware Installation

- Compact form factor for installation at almost any location
- Panel mounting and DIN-rail mounting (with DK-35A accessory)
- Loop-through power output with identical range as power input, for powering analog cameras.

Video Management and Control

- Moxa SoftDVR™ Lite IP Surveillance Software for viewing and recording bundled free
- Free Moxa VPORT SDK PLUS supported with flexible interface and sample codes for customized applications or system integration

NOTE If you are interested in Moxa's VPORT SDK PLUS, please go to Moxa's website to download the package, or contact a Moxa sales representative for more information about this SDK

Typical Application

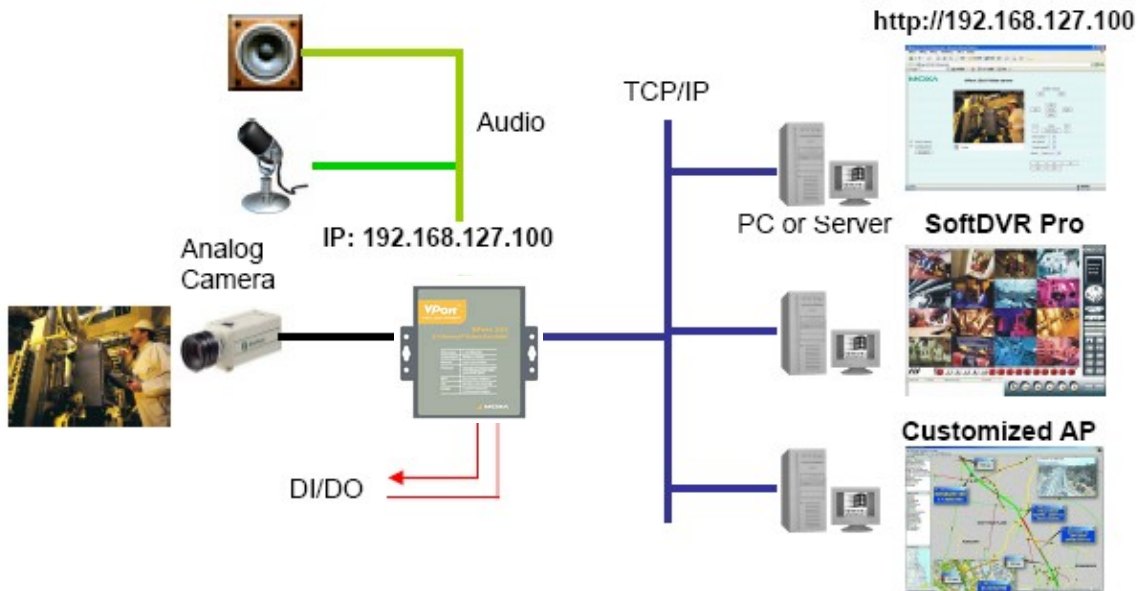

Panel Layout of the VPort 251

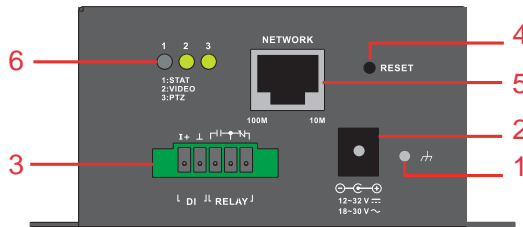

1. Grounding screw
2. Power input jack (12 to 32 VDC or 18 to 30 VAC)
3. 5-pin terminal block for digital input and relay output
4. Hardware reset button
5. 10/100BaseTX Ethernet port with RJ45 connector, LEDs
6. Status LEDs
7. Audio input jack (mic in or line in)
8. Audio output jack (for speakers)
9. vpp BNC connector for video input
10. 2-pin terminal block for loop-through power output
11. RS-232 console port
12. 5-pin terminal block for RS-232/422/485
13. Model name
14. Mounting point for wall mounting
15. Mounting point for DK-35A DIN-Rail kit

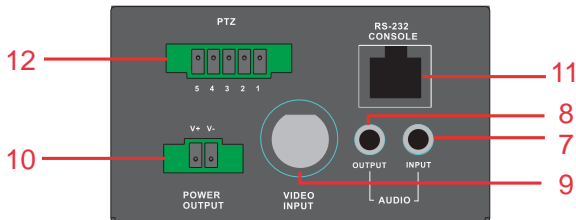
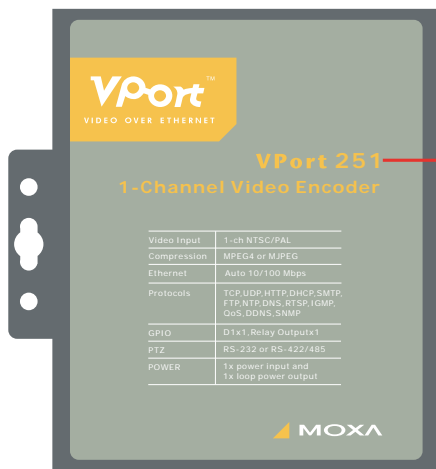

Product Description

BNC video input

The BNC video input is a 75 Ohm video port for connecting an external camera. To ensure that the correct video modulation type is detected, cameras should be connected and powered on before the VPort is powered on.

NOTE	Please use the standard CCTV cable (RG59U or above) to connect the video camera and VPort's BNC connector.
------	--

Mini stereo jacks for audio input/output

The VPort 251 has 2 mini stereo jacks for audio input and output on the front panel. One jack is for a MIC-in/Line-in audio input connection, which can be directly connected with a microphone or an audio source from an amplifier. The other jack is a Line-out audio output connection, which can be used to connect earphones or an amplifier.

LED indicators

The front panel of the VPort 251 contains several LED indicators. The function of each LED is described in the table below.

LED	Color	State	Description
STAT	RED	ON	Hardware initialization
		FLASHING	Software initialization
	GREEN	ON	System boot-up
		FLASHING	Firmware upgrade proceeding
VIDEO	GREEN	On	Video signal is detected
		Off	Video signal is not detected
PTZ	GREEN	On	RS-232 or RS-485 signals are being transmitted
		Off	RS-232 or RS-485 signals are not being transmitted or have not been detected

10/100 Mbps Ethernet port

VPort 251 is equipped with one RJ45 10/100Mbps Ethernet port (LEDs on the left corners of the port indicate 10M or 100M). This Ethernet port is auto-negotiation with 10Mbps or 100Mbps, and also auto-detecting MDI or MDI-X ports.

RS-232/RS-422/RS-485 COM port

The VPort 251 has 1 COM port for PTZ control. This COM port is an RS-232/RS-422/485 serial port with 5 pin terminal block connector. The pin assignments are as follows:

PIN	RS-422/485		RS-232	
	1	GND	Ground	GND
2	R-	Rx-	---	N/A
3	R+	Rx+	RxD	RxD
4	T-/D-	Tx-/ Data-	---	N/A
5	T+/D+	Tx+/ Data+	TxD	TxD

To enable PTZ control, users should configure the PTZ control protocol in the web console.

NOTE The PTZ control protocol is not standardized. To use a particular PTZ control protocol, the video encoder must support the driver for that protocol. Currently, the VPort 251 supports PTZ control protocol drivers for:

1. Pelco D
2. Pelco P
3. Dynacolor DynaDome

In addition, there is an item named "Transparent PTZ Control" in the camera driver list, which is to transmit the PTZ control signal via TCP/IP network to the VPort D251 video decoder or PC (additional Real COM driver required), and the PTZ control panel or keyboard can directly control the PTZ camera or device. In this way, there is no need for PTZ camera driver and better than that, you don't have the protocol limitation for using PTZ camera with VPort encoders.

In addition, to use a protocol that is not on the list, you will need to contact the manufacturer of the camera to get the PTZ control commands, and then use the VPort 251's custom camera function to program the PTZ control.

NOTE The VPort 251 comes with a PTZ driver upload function for implementing new PTZ drivers. Please contact a Moxa sales representative if you need assistance from Moxa's R&D department to create a new PTZ driver.



12/24 VDC and 24 VAC power input and loop-through power output

VPort 251 is powered by 12/24VDC or 24VAC power adaptor with power jack connector. In addition, a loop-through power output in 2-pin terminal block connector type is also provided for powering the external device, such as camera. Since the power input and output is loop-throughed, the 2-pin power output can also be used as an alternative power input connector.

NOTE The supported power input specifications for the VPort 251 series are 12-32 VDC for a 12/24 VDC power input, or 18-30 VAC for a 24 VAC power input.

General I/O Terminal Blocks

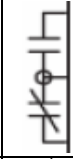
A 5-pin terminal block is located on the VPort 251's top panel. The terminal blocks provide 1 digital inputs (DI), 1 relay outputs (Relay). The digital inputs and relay outputs are for linking to peripheral devices, such as sensors and alarms. These I/O connections can be employed when using the VPort 251 to create an intelligent alarm system for system operation (power failure, video loss, disconnected network) or triggered event (VMD).

Relay Output		Normal Open	Max. 1A, 24 VDC Initial status is Normal Open
		Common	
		Normal Close	
Digital Input		DI-	"High": +13V to +30V "Low": -30V to +3V
	I+	DI+	

NOTE Please refer to the VPort 251's Quick Installation Guide to learn how to wire the digital inputs and relay outputs.

RS-232 Console Port

The VPort 251 has one RS-232 (10-pin RJ45) console port located on the top panel. Use either an RJ45-to-DB9 cable or RJ45-to-DB25 cable to connect the VPort 251's console port to your PC's COM port. You may then use a console terminal program, such as Moxa PComm Terminal Emulator, to access the VPort 251's console configuration utility.

Reset Button

A recessed RESET button is provided for rebooting and restoring the system to the factory default settings. Use a pointed object, such as a straightened paper clip or toothpick, to press the reset button.

1. Reboot:

To reboot the VPort 251, power it off and then power it back on again, or push the RESET button one time. The STAT LED will light in red as the POST (Power On Self Test) process runs. When the rebooting process is finished, the STAT LED will change to a green color.

2. Restore to Factory Settings:

To restore the VPort 251 to the factory default settings, press the reset button continuously until the STAT LED blinks in red. At this point, wait until the STAT LED stop flashing, and then release the reset button. The POST process will run, and the VPort will reboot. The STAT LED will light in green when the VPort has finished rebooting.

2

Getting Started

This chapter includes information about how to install a VPort 251 video encoder.

The following topics are covered:

- ❑ **Before Getting Started**
- ❑ **Initial Installation and Configuration**
 - RS-232 Console Configuration (115200, None, 8, 1, VT1 00)
- ❑ **Mounting the VPort 251**
 - Mounting Dimension
 - DIN-Rail Mounting
 - Wall Mounting
- ❑ **Wiring Requirements**
 - Grounding the VPort 251
 - Error! Reference source not found.
 - Wiring the Relay Output
 - Wiring the Digital Inputs
 - RS-232 Connection
 - 10/100BaseT(X) Ethernet Port Connection
 - Error! Reference source not found.
 - PTZ Port

Before Getting Started

In what follows, “user” refers to those who can access the video encoder, and “administrator” refers to the person who knows the root password that allows changes to the Video Encoder’s configuration, in addition to providing general access. Administrators should read this part of the manual carefully, especially during installation.

Initial Installation and Configuration

Before installing the VPort 251 video encoder, verify that all the items in the Package Checklist are present. You will also need a PC or laptop with an Ethernet port.

Step 1: Connect the power source, and connect loop-through power output if required

The VPort 251 can be powered by a 12 to 32 VDC power source, or an 18 to 30 VAC power source. The power input jack accepts a concentric barrel-type connector. The loop-through power output accepts a 2-pin terminal block connector. Check the STAT LED on the top panel to verify that power is connected correctly.

NOTE	The VPort 251’s power output is looped through the power input and will match the voltage of the power input source. For example, if the power input is 12 VDC, the loop-through power output will also be 12 VDC.
------	--

Step 2: Connect the VPort 251 to the network

The VPort 251 has an auto-sensing 10/100 Mbps Ethernet port, with built-in LEDs to show 10 Mbps (amber) or 100 Mbps (green) connection activity.

Step 3: Connect the VPort 251 to a camera and an audio source

Use coaxial cables with BNC connectors to connect your camera to the VIDEO INPUT port.

You may plug a microphone or amplifier directly into the AUDIO INPUT port and a speaker into the AUDIO OUTPUT port.

NOTE	The VIDEO LED on the front panel lights up when an active signal is detected on the video input port. Use this LED to verify that video is working properly.
------	--

Step 4: Connect the VPort 251 to a PTZ camera

The VPort 251 allows remote control of a PTZ camera’s pan, tilt, and zoom from the network. You will need to connect the camera’s PTZ control cable to the VPort 251’s PTZ port for PTZ control. The port is a 5-pin terminal block that supports the RS-232, RS-422, and RS-485 interfaces. Please refer to Chapter 1 for the RS-232/RS-422/RS-485 COM port’s pin assignments.

Use the VPort 251’s web console to configure and enable PTZ control. Note that there are different PTZ protocols. The VPort 251 supports PTZ drivers for Pelco D, Pelco P and DynaColor DynaDome, and can be customized to work with other PTZ protocols. Please contact a Moxa sales representative if you need assistance from Moxa’s R&D department to create a new PTZ driver.

A Transparent PTZ Control for controlling cameras with a legacy PTZ control panel or keyboard is also available. This means that you will be able to control a variety of different PTZ cameras without needing to worry about meeting PTZ driver requirements. Users can connect legacy PTZ control panels or keyboards to the VPort D251’s PTZ port, or the COM port of a PC (provided the Moxa Real COM port driver is installed) to control the PTZ camera connected to the VPort 251.

Legacy PTZ Camera Control

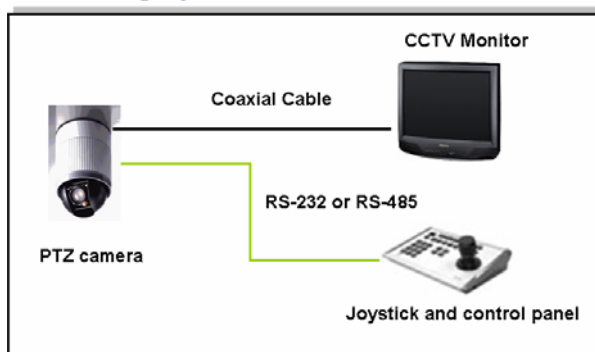

Transparent PTZ Camera Control via Ethernet

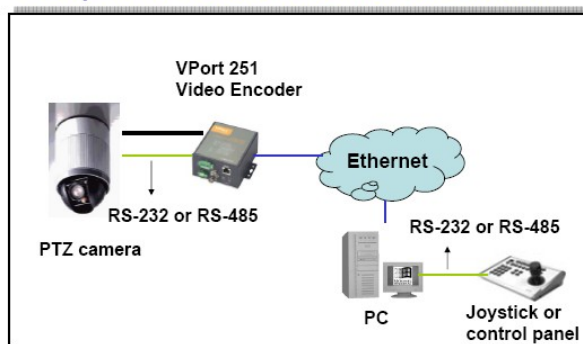

NOTE The PTZ control panel or keyboard must support the control of PTZ camera being used.

Step 5: Configure the VPort 251's IP address

When the VPort 251 is first powered on, the POST (Power On Self Test) will run for a few moments. The STAT LED will turn green when the POST is complete. The NETWORK LED will then flash as the IP address is assigned. The network environment determines how the IP address is assigned.

Network Environment with DHCP Server:

For this network environment, the unit's IP address will be assigned by the network's DHCP server. Refer to the DHCP server's IP address table to determine the unit's assigned IP address. You may also use the **Moxa VPort and Ether Device Configurator Utility (edscfgui.exe)** as follows:

1. Run the **edscfgui.exe** program to search for the VPort and EDS switch. After the Utility window opens, you may also select or click on the Broadcast Search (under the List Server menu or click on Broadcast Search icon ) to initiate a search.

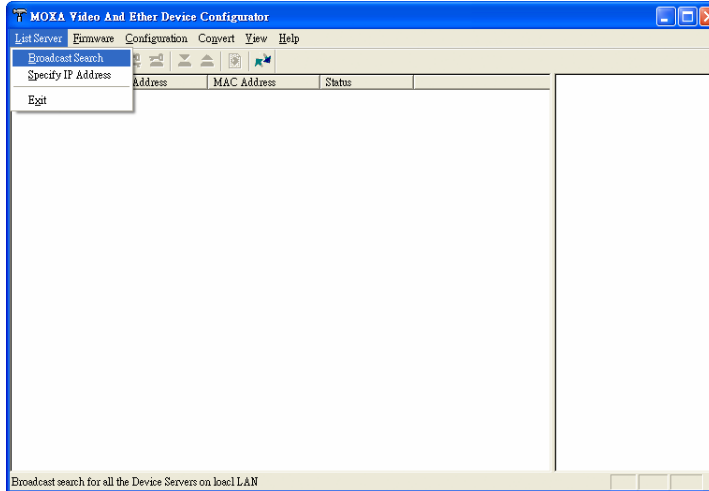

NOTE You may download the **Moxa VPort and Ether Device Configurator Utility (edscfgui.exe)** software from Moxa's website at www.moxa.com.

2. The **Broadcast Search** window will open, displaying a list of all switches and VPorts located on the network, as well as the progress of the search.

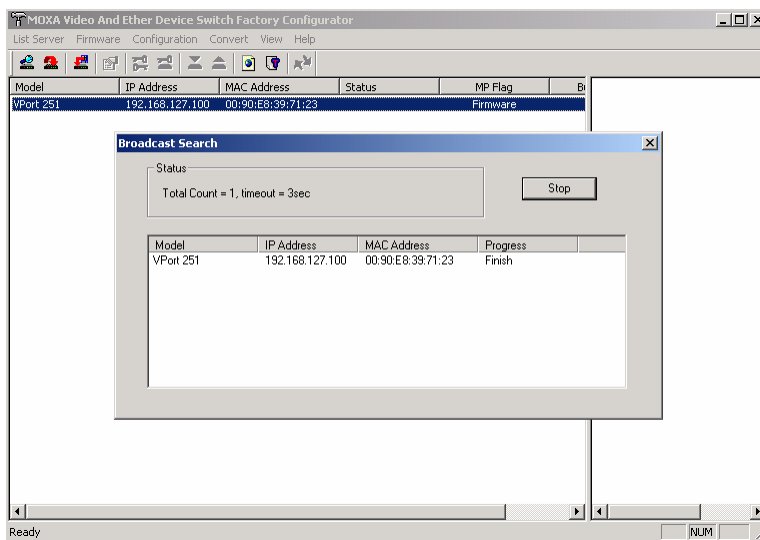

- When the search has concluded, the Model Name, MAC address, IP address of the EDS Switch and VPort will be listed in the Utility window.

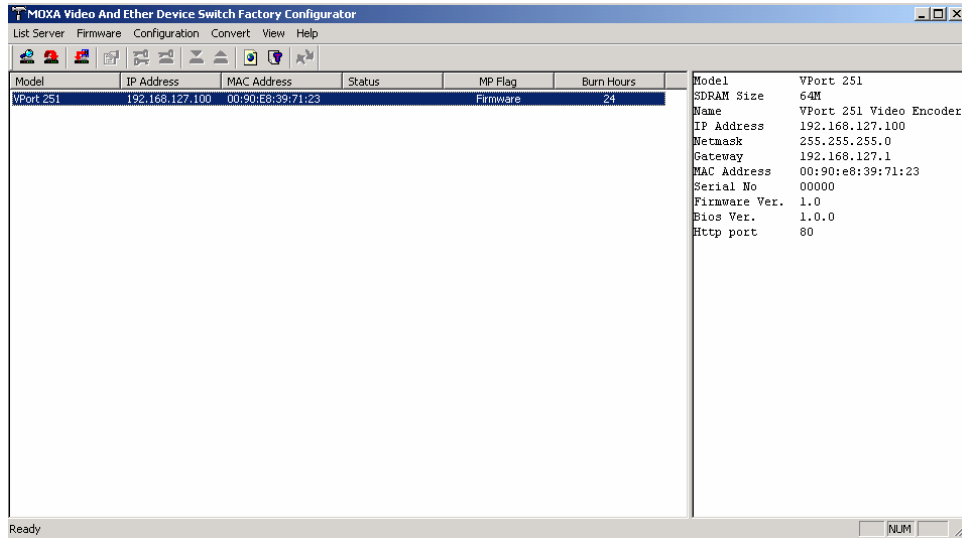

NOTE The **Broadcast Search** only can search the devices on the same domain LAN. If your devices are located on different domain LAN, you can use the **Specify IP Address** to search the device by key in the IP address.

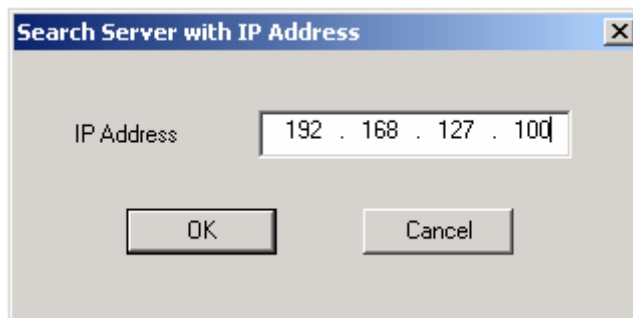

- Double click the selected VPort, or use the IE web browser to access VPort's web-based manager (web console).

Network Environment without a DHCP Server:

If the unit is connected to a network that does not have a DHCP server, then you will need to configure the IP address manually. The VPort 251 has a default IP address of **192.168.127.100** with a default subnet mask of 255.255.255.0. You may need to change your computer's IP address and subnet mask so that the computer and the VPort 251 are on the same subnet.

To change the unit's IP address manually, open the unit's web console and navigate to **System Configuration → Network → General**. Make sure that Use fixed IP address is checked so that the IP address is not reset every time the unit is restarted.

Step 6: Log into the VPort 251's web console

In your web browser, navigate to the VPort 251's IP address to open the web console.

Step 7: Install the ActiveX Control plug-in

A security message will appear the first time you access the VPort's web console. The message asks if you wish to install the VPort ActiveX Control component, which is required to allow video images to be viewed in Internet Explorer. Click **Yes** to install this plug-in.

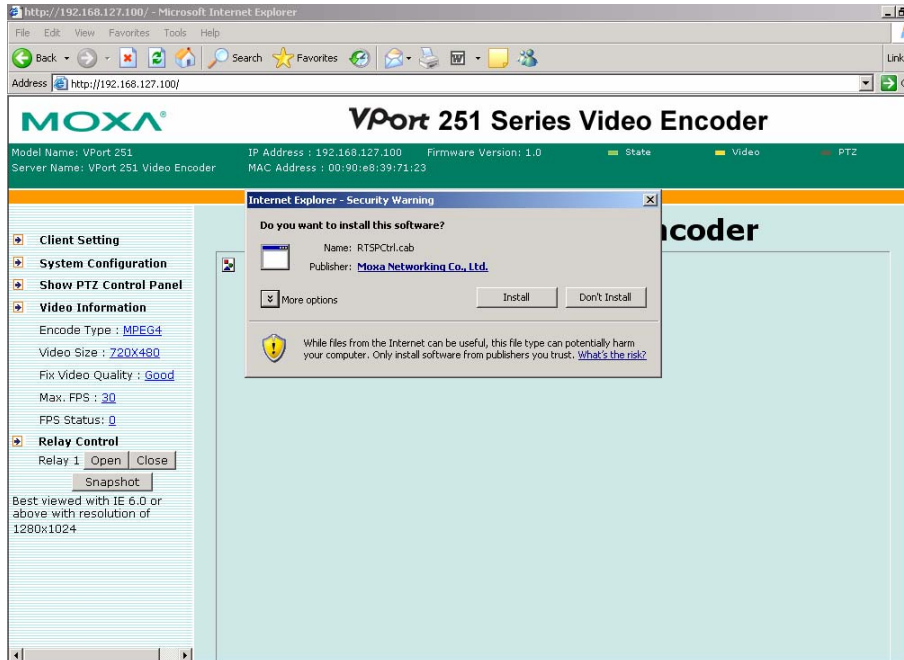

NOTE For Windows XP SP2 or above, the ActiveX Control component will be blocked for security reasons. In this case, the warning message may not appear. You will need to unblock the ActiveX control function or disable security in order to install the ActiveX Control component.

Step 8: Verify operation in the web console

After the ActiveX Control component is installed, the VPort 251's web console will appear. Check for the following items to confirm proper installation:

1. Video images
2. Audio (make sure PC sound is turned on)
3. Video information

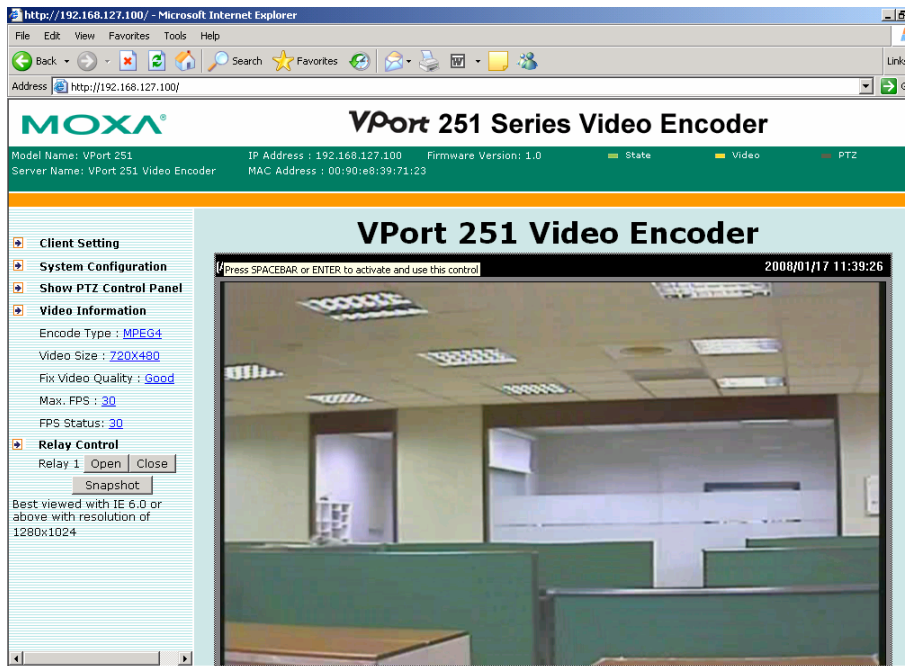

Step 9: Review or modify VPort 251 configuration

In the web console, navigate to **System Configuration** to review or modify the unit's configuration. For detailed information on settings, please refer to Chapter 4.

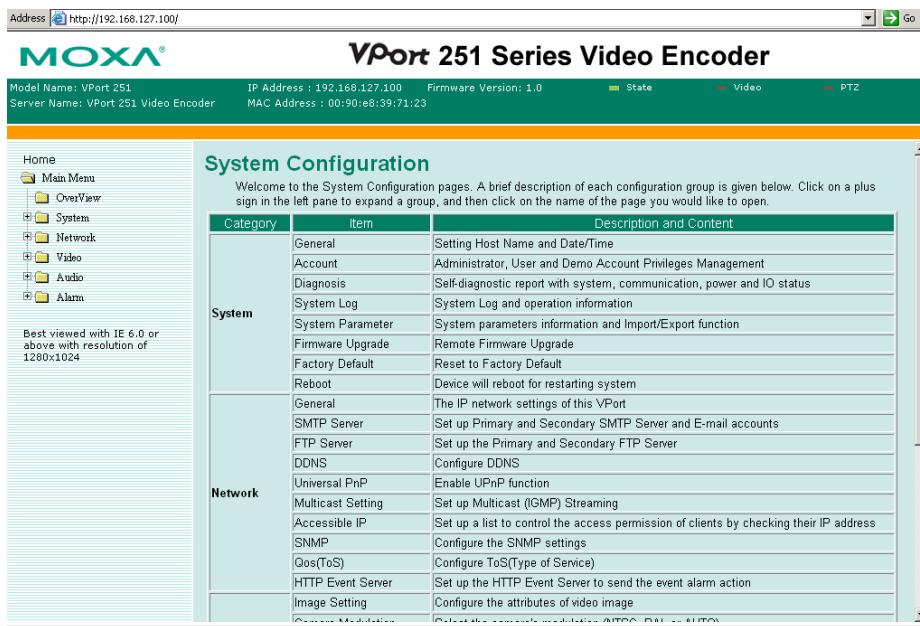

NOTE In the web console, administrators may navigate to **System Configuration** → **System** → **Account** to set up an administrator's password for authentication purposes. The administrator account name is admin. When a password has been set up, an authentication window will appear whenever someone attempts to open the unit's web console.

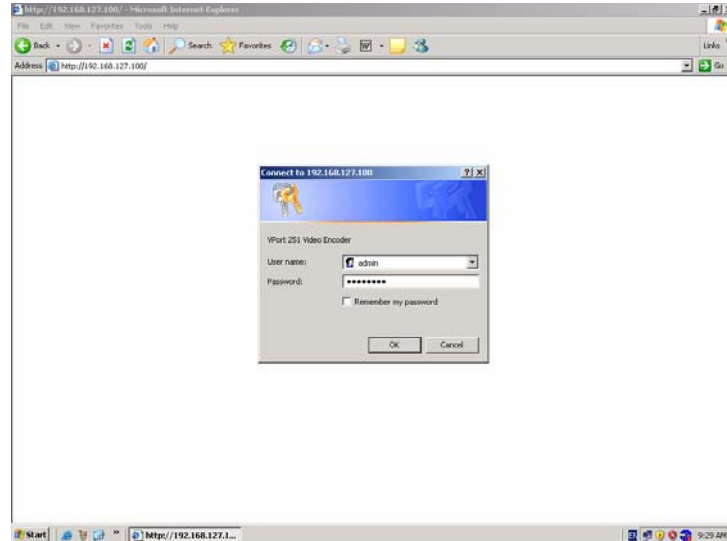

RS-232 Console Configuration (115200, None, 8, 1, VT1 00)

NOTE

1. You **cannot** connect to the VPort 251 simultaneously by serial console and Telnet.
2. You **may** connect to the VPort 251 simultaneously by web browser and serial console, or by web browser and Telnet. However, we strongly recommend that you use only one connection method at a time. This allows you to maintain better control over your VPort 251's configuration.

You can access the RS-232 console by using a terminal emulator on your PC. We recommend that you use PComm Terminal Emulator, which is free and can be downloaded from Moxa's website. The following instructions explain how to use PComm to access the RS-232 console.

1. Use an RJ45 to DB9-F (or RJ45 to DB25-F) cable to connect the VPort 251's RS-232 console port to a COM port on your PC.

- From the Windows desktop, click **Start → Programs → PCommLite1.3 → Terminal Emulator**.

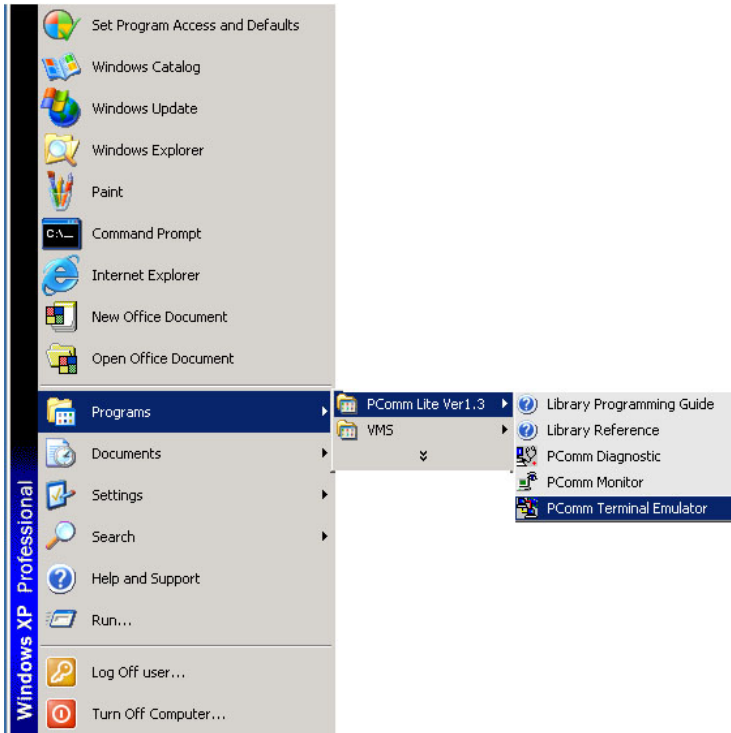

- Select **Open** under **Port Manager** to open a new connection.

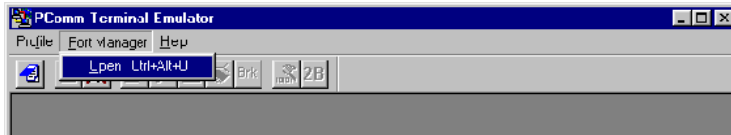

- The **Communication Parameter** page of the **Property** window opens. Select the appropriate COM port for **Console Connection**, **115200** for **Baud Rate**, **8** for **Data Bits**, **None** for **Parity**, and **1** for **Stop Bits**.

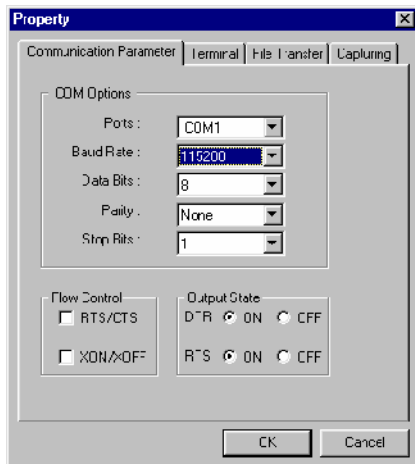

- Click the **Terminal** tab, and select **VT100** for **Terminal Type**. Click **OK** to continue.

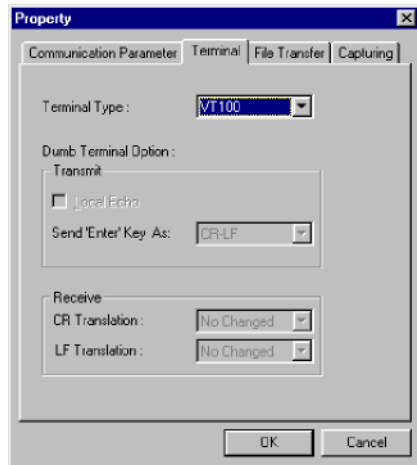

- A blank screen will appear. Press **Enter**, after which a login message will appear. Only the administrator is allowed to use this console configuration. Use **admin** as the username and the associated admin password as the password. Press **Enter** to continue.

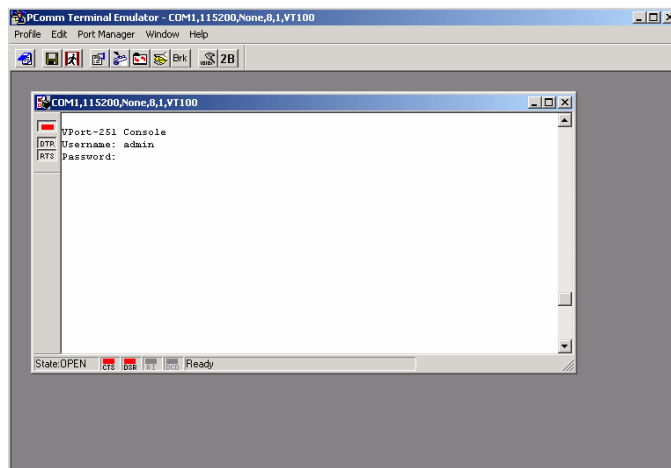

- The RS-232 console's **Main Menu** will be displayed. (NOTE: To modify the appearance of the PComm Terminal Emulator window, select **Font...** under the **Edit** menu, and then choose the desired formatting options.)

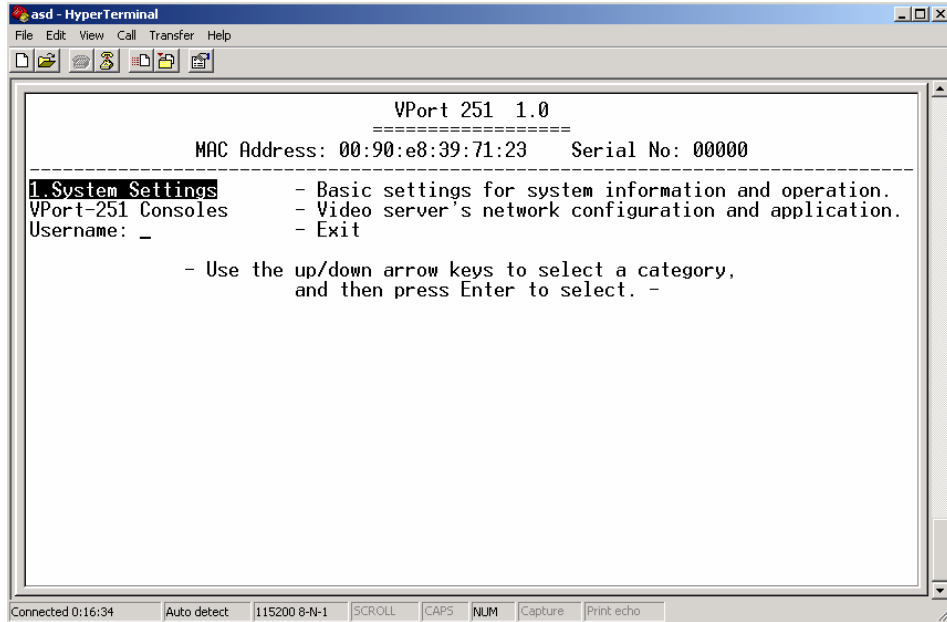

- After entering the **Main Menu**, use the following keys to move the cursor, and to select options.

Key	Function
Up/Down/Left/Right arrows, or Tab	Move the onscreen cursor
Enter	Display & select options
Space	Toggle options
Esc	Previous Menu

NOTE Many settings are related to video images, which cannot be shown on the RS-232 console. The VPort 251's RS-232 console provides only Basic System Setting and Network Setting. For more advanced configuration, please use the web console.

Mounting the VPort 251

Mounting Dimension (Unit=mm)

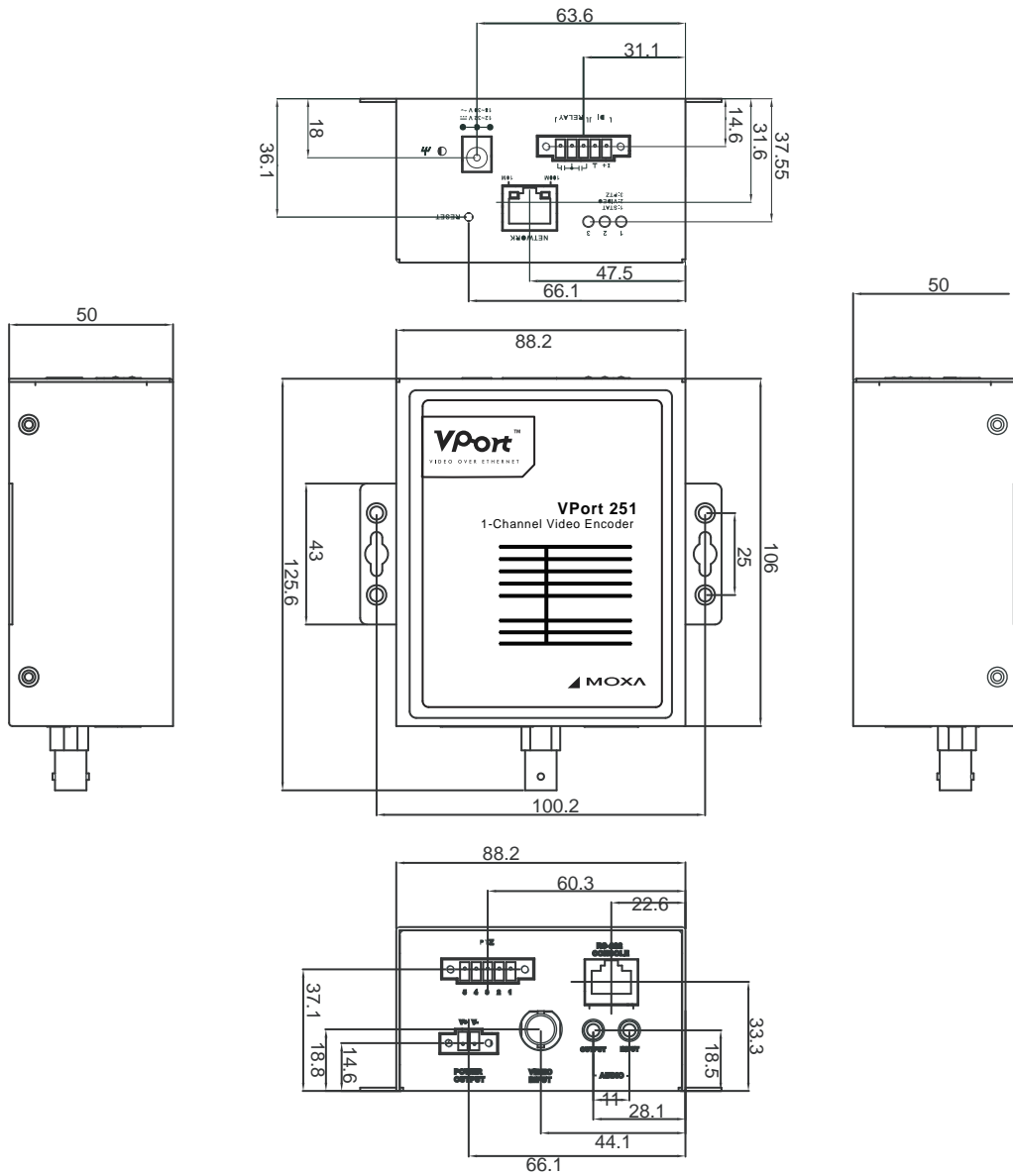

DIN-Rail Mounting (Optional)

The VPort 251 can be mounted on a 35-mm DIN-Rail using the DK-35A accessory (ordered separately).



Wall Mounting

The VPort 251 can be mounted on the wall with 2 screws. Make sure that screws are less than 3.5 mm in diameter, with heads between 3.5 and 6.0 mm in diameter, as shown on the right.

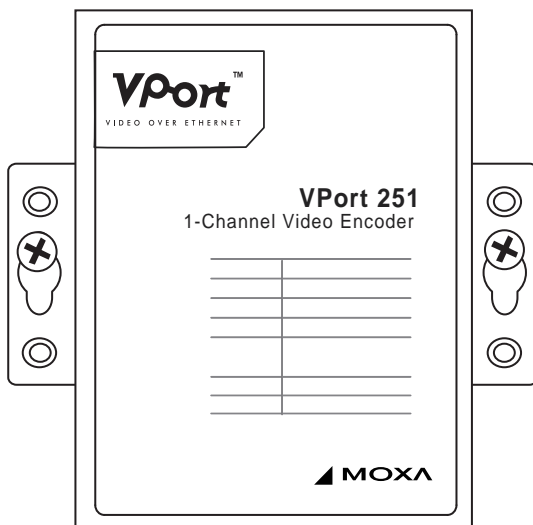
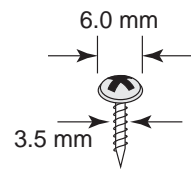

Wiring Requirements



ATTENTION

Be sure to disconnect the power cord before installing and/or wiring your Moxa VPort 251. Calculate the maximum possible current in each power wire and common wire. Observe all electrical codes dictating the maximum current allowable for each wire size. If the current goes above the maximum ratings, the wiring could overheat, causing serious damage to your equipment.

You should also pay attention to the following:

- Use separate paths to route wiring for power and devices. If power wiring and device wiring paths must cross, make sure the wires are perpendicular at the intersection point. NOTE: Do not run signal or communications wiring and power wiring in the same wire conduit. To avoid interference, wires with different signal characteristics should be routed separately.
- You can use the type of signal transmitted through a wire to determine which wires should be kept separate. The rule of thumb is that wiring that shares similar electrical characteristics can be bundled together.
- Keep input wiring and output wiring separated.
- It is strongly advised that you label wiring to all devices in the system when necessary.

Grounding the VPort 251

Grounding and wire routing help limit the effects of noise due to electromagnetic interference (EMI). Run the ground connection from the ground screw to the grounding surface prior to connecting devices.



ATTENTION

This product is intended to be mounted to a well-grounded mounting surface such as a metal panel.

Wiring the Relay Output

In this section, we will explain the meaning of the two contacts used to connect the Relay Contact.

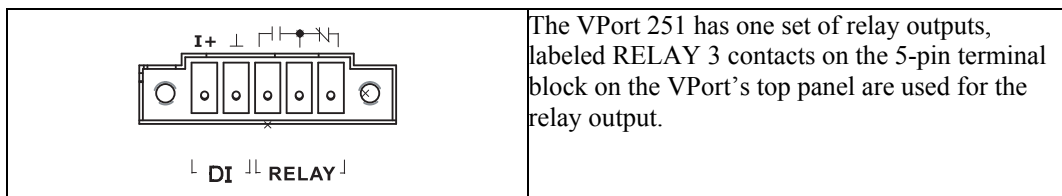

The relay output can be configured for:

1. **System alarm:** such as for network disconnected.
2. **Event alarm:** such as for VMD (Video Motion Detection), video loss, and Digital Inputs.



ATTENTION

The maximum current and power capacity of the relay output is 24 VDC @ 1A. Please be careful not to exceed this power specification.



ATTENTION

Before connecting the VPort to the DC/AC power inputs, make sure the DC power source voltage is stable.

Wiring the Digital Inputs

The VPort 251 has one digital input channel, labeled DI. Two contacts on the 5-pin terminal block on the VPort's top panel are used to connect to this DI.

	<p>STEP 1: Insert the negative (ground)/positive DI wires into the \pm/I1 terminals.</p> <p>STEP 2: To keep the DI wires from pulling loose, use a small flat-blade screwdriver to tighten the connector.</p> <p>STEP 3: Insert the plastic terminal block connector prongs into the terminal block receptor, which is located on VPort 251's top panel.</p>
--	--

RS-232 Connection

The VPort 251 has one RS-232 (10-pin RJ45) console port, located on the top panel. Use either an RJ45-to-DB9 or RJ45-to-DB25 cable (see the cable following wiring diagrams) to connect the VPort 251's console port to your PC's COM port. You may then use a console terminal program, such as Moxa PComm Terminal Emulator, to access the VPort 251's console configuration utility.

RJ45 (10-pin) Console Port Pinouts

Pin	Description
1	---
2	DSR
3	---
4	GND
5	TxD
6	RxD
7	GND
8	---
9	DTR
10	---

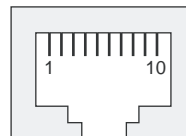

RJ45 (10-pin) to DB9 (F) Cable Wiring

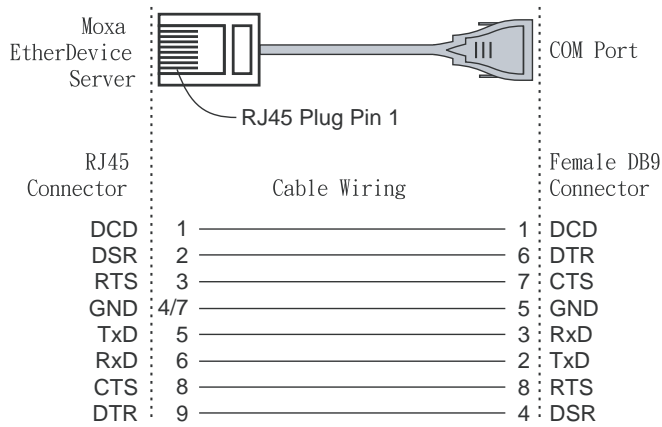

RJ45 (10-pin) to DB25 (F) Cable Wiring

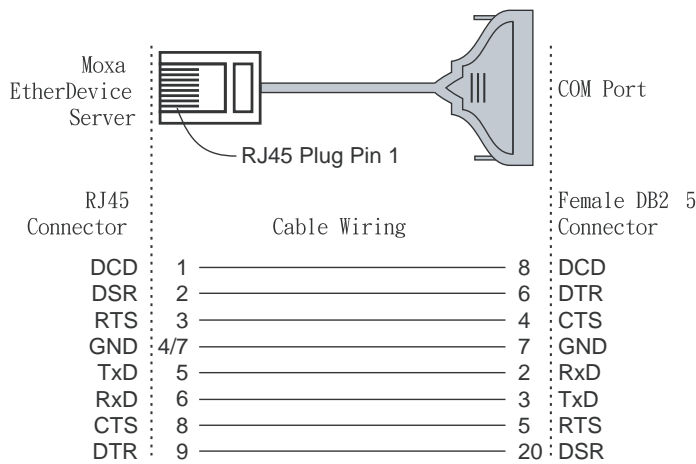

10/100BaseT(X) Ethernet Port Connection

The 10/100BaseT(X) port located on the VPort 251's front panel is used to connect to Ethernet-enabled devices.

The following table shows pinouts for both MDI (NIC-type) ports and MDI-X (HUB/Switch-type) ports. We also show cable wiring diagrams for straight-through and cross-over Ethernet cables.

(MDI) Port Pinouts

Pin	Signal
1	Tx+
2	Tx-
3	Rx+
6	Rx-

(MDI-X) Port Pinouts

Pin	Signal
1	Rx+
2	Rx-
3	Tx+
6	Tx-

8-pin RJ45

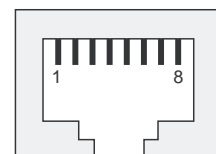

RJ45 (8-pin) to RJ45 (8-pin) Straight-Through Cable Wiring

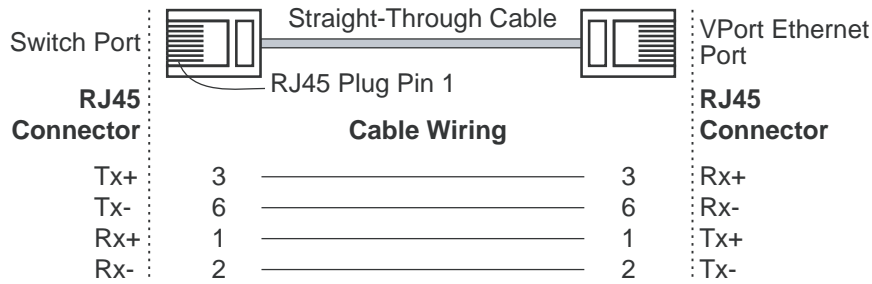

RJ45 (8-pin) to RJ45 (8-pin) Cross-Over Cable Wiring

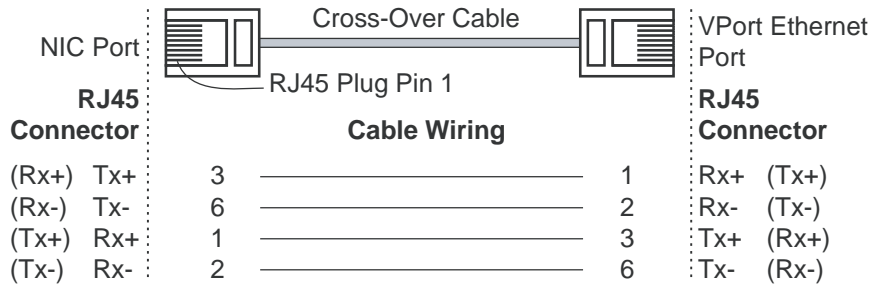

PTZ Port

A PTZ port is located on the VPort 251's front panel. The port is used to connect to a PTZ motorized camera or device, so that the camera or device can be controlled from the VPort over the IP network. The PTZ port supports RS-232 or RS-422/485 signals through the terminal block. The PTZ port pin assignments are shown in the following table.

PTZ

Pin Assignment		
PIN	RS-422/485	RS-232
1	GND	GND
2	R-	---
3	R+	RxD
4	T\D-	---
5	T+\D+	TxD

3

Accessing VPort 251's Web-based Manager

This chapter includes information about how to access VPort 251 video encoder for the first time.

The following topics are covered:

- ❑ **Functions Featured on the VPort's Web Homepage**
 - VPort's Information
 - Server Name
 - Camera Image View
 - Audio Control
 - Client Setting
 - System Configuration
 - Video Information
 - PTZ Control PanelPTZ (Motorized) Camera Control
 - Custom PTZ Camera Commands
 - Video Image Snapshots
 - Relay Control

Functions Featured on the VPort's Web Homepage

The homepage of the VPort's web console shows information specific to that VPort, the camera image, and configurations for client and server.

NOTE The VPort's web homepage is best viewed using a 1280 x 1024 screen size. This is because the camera image can be viewed at a resolution up to Full D1 (NTSC: 720 x 480; 720 x 576). We strongly recommend using IE 6.0 (Microsoft Internet Explorer) or above to avoid incompatibility with the ActiveX Plug-in.



VPort's Information

This section shows the VPort's model name, server name, IP address, MAC address, firmware version, and the display status of the LEDs located on the VPort's front panel.

NOTE The VPort LEDs shown on the VPort's web homepage are updated every 10 seconds.

Server Name

A server name can be assigned to each server. Administrators can change the name in **System Configuration/System/General**. The maximum length of the sever name is 40 bytes.

Camera Image View

The assigned image description and system date/time will be displayed in the caption above the image window. You may disable the caption or change the location of the image information from the **System Configuration/Video/Image Setting**. Note that if the VPort's motion detection function is active, some windows in the video picture might be framed in red.

Audio Control

The VPort 251 provides both audio input and audio output for voice over IP communication. Client users can directly enable and disable the audio input (a microphone, for example) by clicking the microphone button, and audio output (a speaker, for example) by clicking the speaker button from the VPort's web homepage. You may also use the **Client Setting** to disable the audio transmission.

Client Setting

Users can configure the following functions in **Client Settings**.

1. **Media Options:** Enable or disable the video or audio transmission.
2. **Protocol Options:** Choose one of four protocols to optimize your usage—UDP, TCP, HTTP, or Multicast.
 - **UDP** protocol can be used to produce audio and video streams that are more real-time. However, some packets may be lost due to network burst traffic, and images may become blurred.
 - **TCP** protocol can be used to prevent packet loss, which results in a more accurate video display. The downside of using TCP is that the real-time effect is worse than with UDP protocol.
 - **HTTP** protocol can be used to prevent being blocked by a router's firewall. The downside of using HTTP is that the real-time effect is worse than with UDP protocol.
 - **Multicast** protocol can be used to send a single video stream to multiple clients. In this case, a lot of bandwidth can be saved since only one video stream is transmitted over the network. However, the network gateway (e.g., a switch) must support multicast protocol (e.g., IGMP snooping). Otherwise, the multicast video transmission will not be successful.

Once the video encoder is connected successfully, Protocol Options will indicate the selected protocol. The selected protocol will be recorded on the user's PC, and will be used for the next connection.

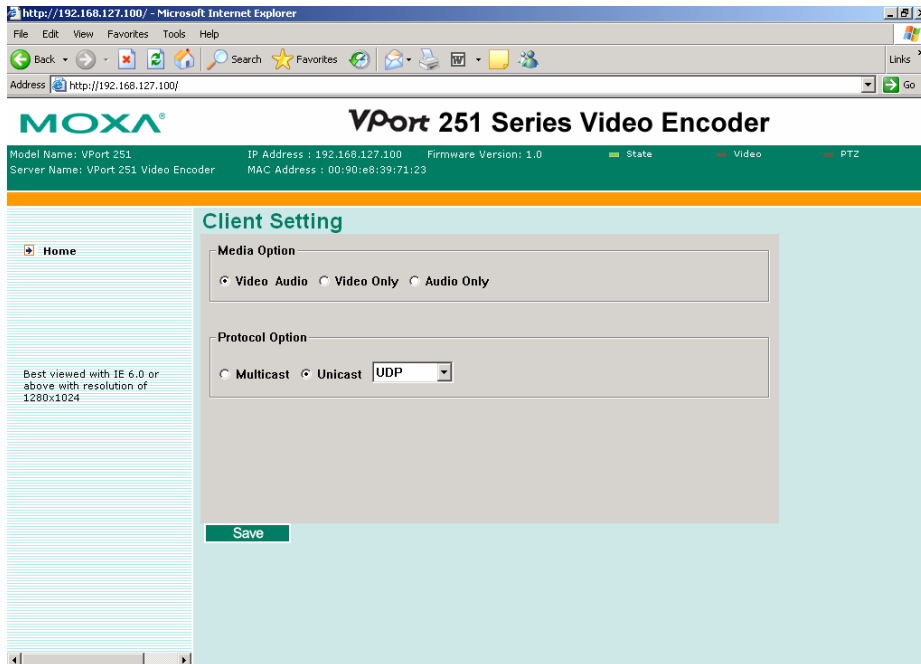

System Configuration

A button or text link on the left side of the system configuration window only appears on the administrator's main page. For detailed system configuration instructions, refer to Chapter 4, **System Configuration**.

Video Information

Users can easily monitor the current video performance by looking at the **Video Information** shown on the left side of the homepage. The following properties are shown: Video Size, Video Quality (Fixed bit rate or Fixed video quality), Max. FPS (frames per second), and (current) FPS Status.

PTZ Control Panel

Users can click this link to pop up a new window for PTZ Control.

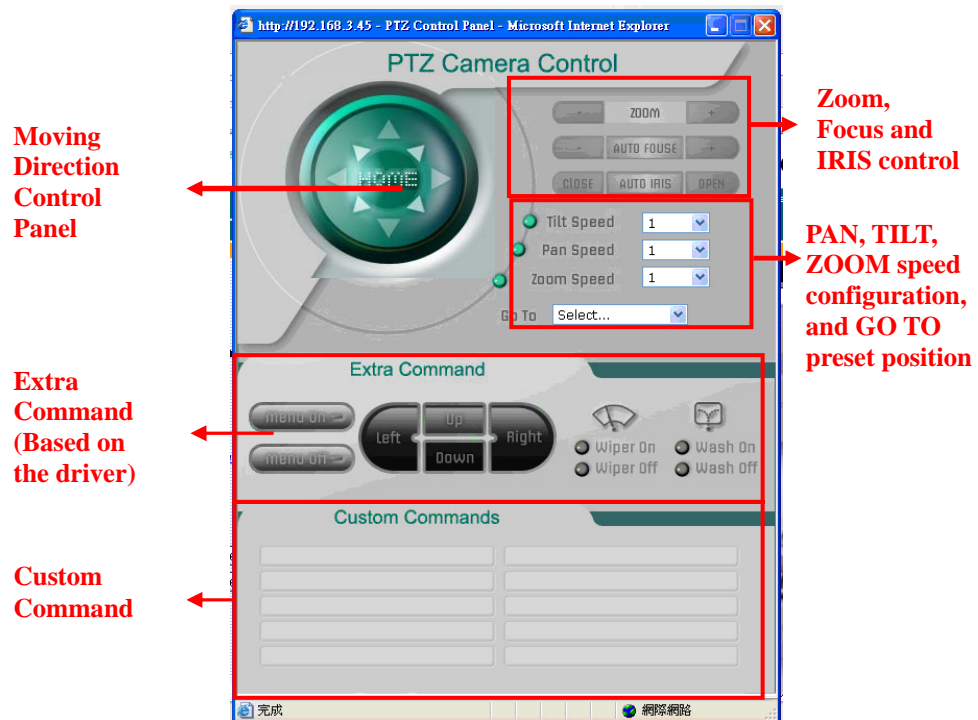

PTZ (Motorized) Camera Control

If a serial device, such as a motorized camera, is attached to the COM port, the control panel will appear on the main page for user's who have permission to operate the camera. Buttons that are active will change color when the cursor is passed over the button. Users can control the pan, tilt, zoom, and focus functions of motorized cameras. The home button is used to return the camera to the center position if the camera supports this command. In addition to near and far control for focus, an AUTO button is provided for setting auto focus mode. To move the motorized camera more precisely, the speed control for pan and tilt allows users to fine tune the aiming of the camera. Users can also click directly on any point in the image to force the motorized camera to focus on that point, or select a preset location from the drop-down menu. Administrators are able to add or modify the list of preset locations. Details are described in the relevant section in Chapter 4, **System Configuration**.

NOTE	For some PTZ cameras, users can click on any position in the image to point the camera to that position. We currently support this functionality for Pelco-D, Pelco P and Dynacolor DynaDome PTZ drivers.
-------------	---

Custom PTZ Camera Commands

In addition to the default pan, tilt, zoom, and focus controls, an additional 10 buttons are available for custom commands to control the attached motorized (PTZ) cameras. Custom commands are set up by administrators, and are used for functions such as activating or deactivating the dome wiper. Refer to the attached motorized device's User's Manual to see which functions can be controlled with these additional buttons.

Video Image Snapshots

Users can take snapshot images for storing, printing, or editing by clicking the **Snapshot** button. To save the image, click the right mouse button and select the **Save** option.

Relay Control

The VPort 251 has 1 relay outputs for external devices, such as alarms. Administrators and permitted users can click on **Open** to short the **Common** and **Normal Open** digital output pins, or click on **Close** to short the **Common** and **Normal Close** digital output pins.

System Configuration

After installing the hardware, the next step is to configure the VPort 251's settings. Users can configure by web console.

This chapter includes the following sections:

- ❑ **System Configuration by Web Console**
 - System
 - Network
 - Video
 - Audio
 - Alarm

System Configuration by Web Console

System configuration can be done remotely with Internet Explorer. To access the server, type the system configuration URL, **http://<IP address of Video Server>/setup/config.html**, to open the configuration main page.

There are five configuration categories: **System, Network, Video, Audio**, and **Alarm**. A description of each configuration item is shown in the table below:

Category	Item	Description and Contents	
System	General	Set Host Name and Date/Time	
	Accounts	Administrator, User, and Demo Account Privileges Management	
	Diagnosis	Self-diagnostic report with system, communication, power, and LED status	
	System Log	System Log and operation information	
	System Parameter	System parameter information and Import/Export functions	
	Firmware Upgrade	Remote Firmware Upgrade	
	Factory Default	Reset to Factory Default	
	Reboot	Device will reboot for restarting system	
Network	General	The IP network settings of this VPort	
	SMTP Server	Set up Primary and Secondary SMTP Server and e-mail accounts	
	FTP Server	Set up the Primary and Secondary FTP Server	
	DDNS	Configure Dynamic DNS service	
	Universal PnP	Enable UPnP function	
	Multicast Setting	Set up Multicast (IGMP) Streaming	
	Accessible IP	Set up a list to control the access permission of clients by checking their IP address	
	SNMP	Configure the SNMP settings	
	QoS (ToS)	Configure ToS(Type of Service)	
HTTP Event Server	Set up the HTTP Event Server to send the event alarm action		
Video	Image Setting	Configure the attributes of the video image	
	Camera Modulation	Select the camera's modulation (NTSC, PAL or AUTO)	
	Video Performance	Set up the Size (Resolution), FPS, and Video Quality	
	Camera Control	Set up the Camera's PTZ Control	
Audio	Quality	Set up the audio source	
Alarm	System Alarm	Configure Network Connection Broken alarms	
	Event Alarm	Basic	General settings of event alarm
		Schedule	Set up the Alarm schedule
		Video Motion Detection	Configure the Video Motion Detection Alarm
		Digital Input	Configure the Digital Input Alarm
		Video Loss	Configure the Video Loss Alarm
		Sequential Snapshot	Set up the Sequential Snapshot operation

This table can also be found on the **System Configuration → Overview** webpage.

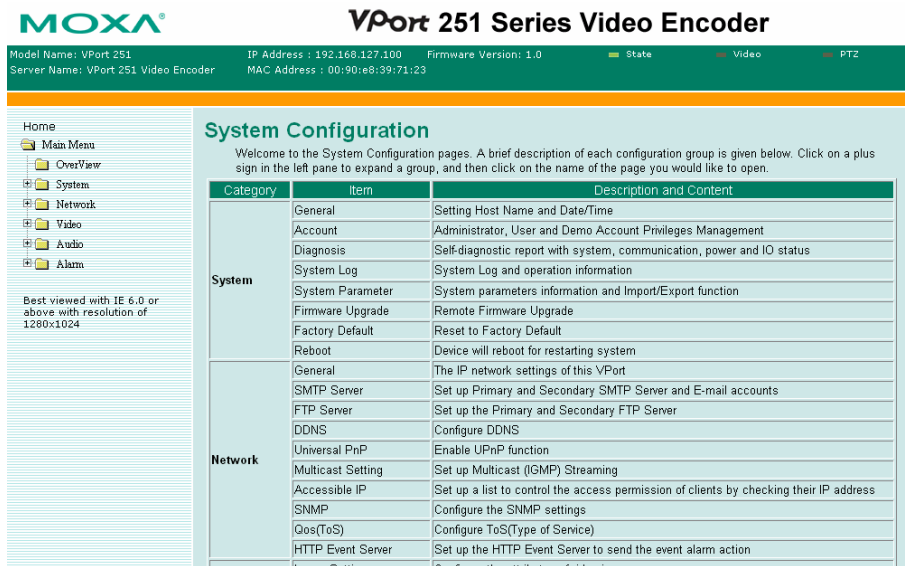

System

General Settings

On the **General Settings** page, administrators can set up the video **Server name** and the **Date and Time**, which appear in the image's caption.

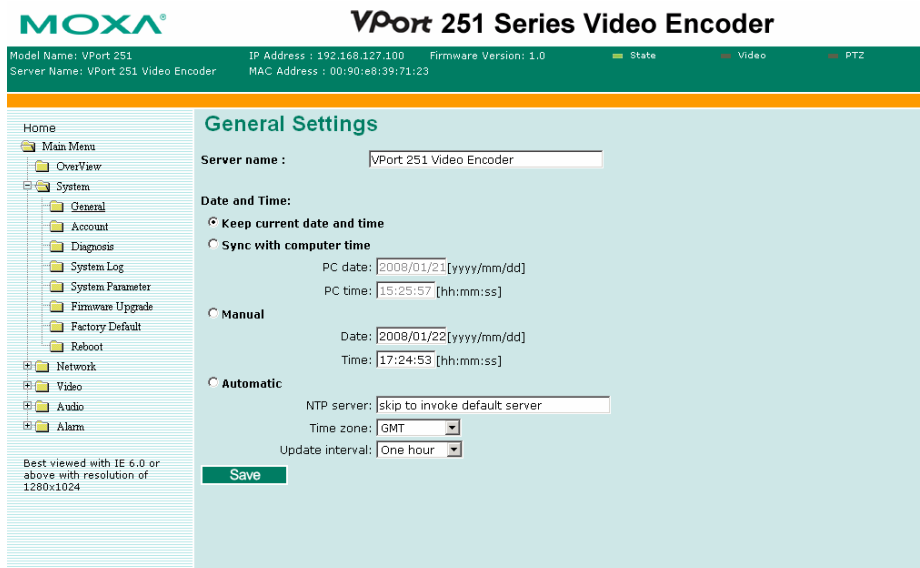

Server name

Setting	Description	Default
Max. 40 characters	Use a different server name for each server to help identify the different servers. The name appears on the web homepage.	VPort 251 Video Encoder

Date and Time

Setting	Description	Default
Keep current date and time	Use the current date and time as the VPort's time setting.	VPort 251 Video Encoder
Sync with computer time	Synchronize VPort's data and time setting with the local computer time.	
Manual	Manually change VPort's date and time setting.	
Automatic	Use the NTP server for changing VPort's date and time setting in a given period.	

NOTE Select the **Automatic** option to force the VPort to synchronize automatically with timeservers over the Internet. However, synchronization may fail if the assigned **NTP server** cannot be reached, or the VPort is connected to a local network. Leaving the **NTP server** blank will force the VPort to connect to default timeservers. Enter either the Domain name or IP address format of the timeserver if the DNS server is available.

Don't forget to set the **Time zone** for local settings. Refer to Appendix G for your region's time zone.

Account Privileges

Different account privileges are available for different purposes.

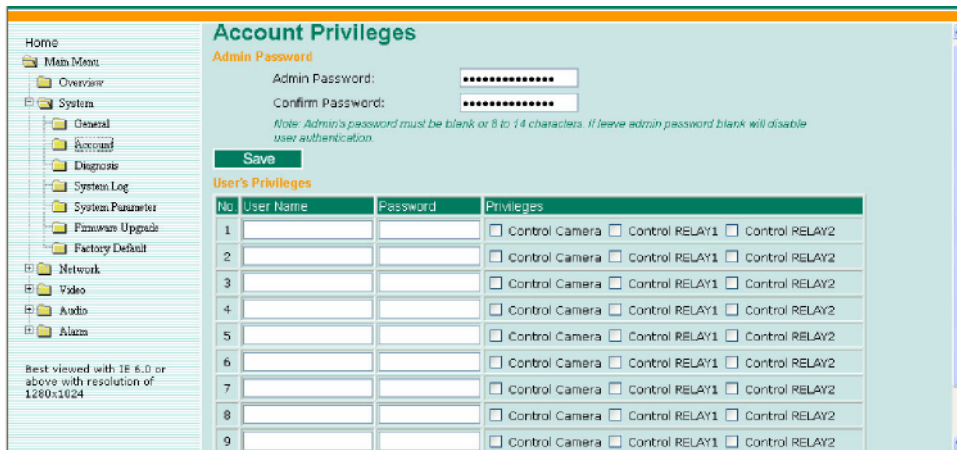

Admin password

Setting	Description	Default
Admin Password (max. 14 characters)	Administrator can type the new password in this box.	Default admin password is "admin"
Confirm Password (max. 14 characters)	If a new password is typed in the Admin Password box, you will need to retype the password in the Confirm Password box before updating the new password.	

NOTE The default account name for administrator is **admin**; the administrator account name cannot be changed.

User's Privileges

VPort products provide 10 user accounts for accessing VPort. Administrators can set up user's privileges in this section. Each user can be given independent access right to the external I/O and camera control.

Setting	Description	Default
User Name	Type a specific user name for user authentication.	None
Password	Type a specific password for user authentication.	
Privilege	Check the function boxes to assign privileges for users in Control Camera , Control Relay1 , and Control Relay2 .	

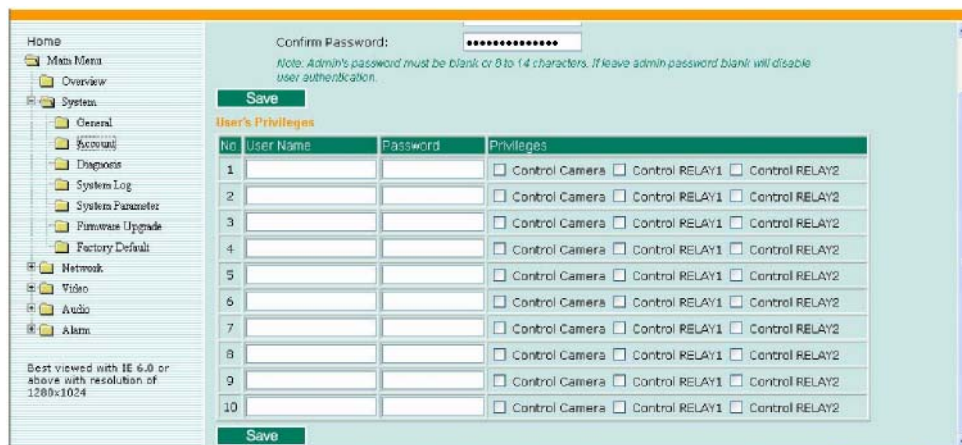

NOTE The FPS of the video stream will be reduced as more and more users access the same VPort. For this reason, only 10 users can access the VPort 251 at the same time. Enforcing this kind of restriction helps guarantee the performance of the video stream.

System Diagnosis

VPort products have a self-diagnosis function to let the administrator get a quick view of the system and connection status. Administrators can save this diagnosis information in a file (diagnosis.log) by clicking the **Export to a File** button, or send the file via email by clicking the **Send a Report via Email** button.

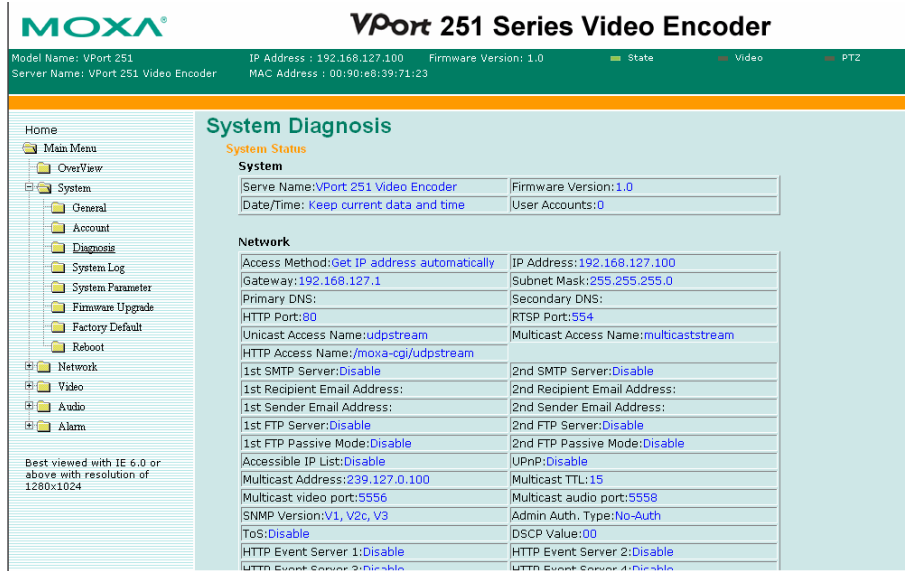

System Log History

The system log contains useful information, including current system configuration and activity history with timestamp for tracking. Administrators can save this information in a file (system.log) by clicking the **Export to a File** button, or send the file by email by clicking the **Send a Report via Email** button.

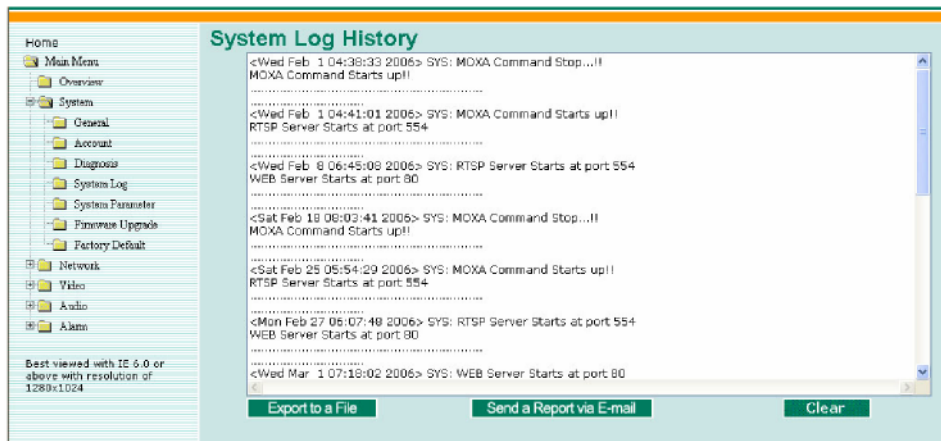

System Parameters

The **System Parameters** page allows you to view all system parameters, which are listed by category. The content is the same as the VPort's sys_config.ini file. Administrators can also save this information in a file (sys_config.ini) by clicking the **Export to a File** button, or import a file by clicking the **Browse** button to search a sys_config.ini file and the **Import a System Parameter File** button to update the system configuration quickly.

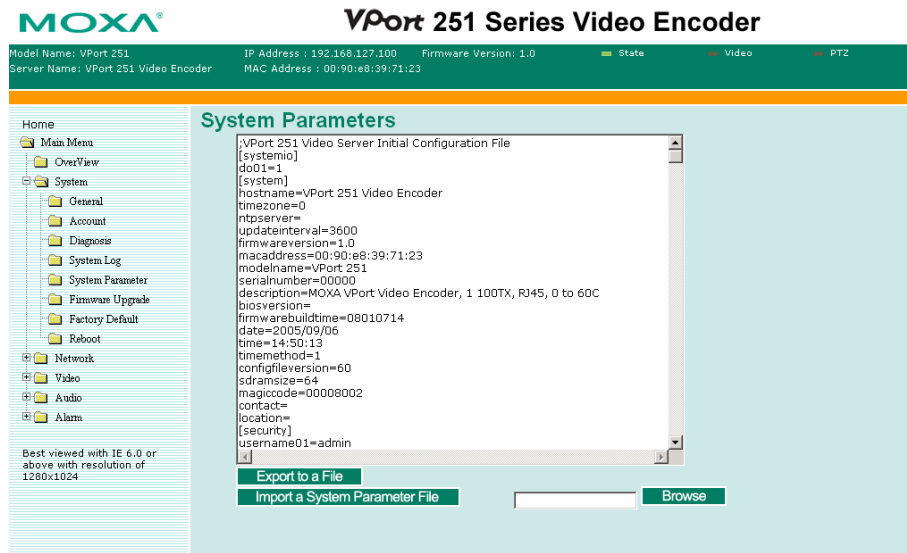

NOTE The system parameter import/export functions allow the administrator to backup and restore system configurations. The Administrator can export this sys_config.ini file (in a special binary format) for backup, and import the sys_config.ini file to restore the system configurations of VPort video encoders. System configurations will be changed immediately after the VPort is rebooted.

Firmware Upgrade

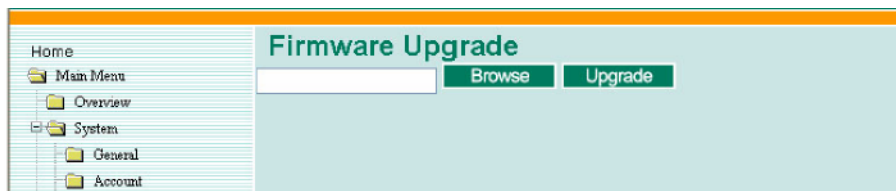

Take the following steps to upgrade the firmware:

Step 1: Press the **Browse** button to select the firmware file.

NOTE For the VPort 251, the firmware file extension should be **.rom**.

- Step 2:** Click on the **Upgrade** button to upload the firmware to the VPort.
- Step 3:** The system will start to run the firmware upgrade process.
- Step 4:** Once **Firmware Update Success.....Reboot....** is shown, please wait for few seconds for the VPort to reboot. The reboot process is finished once the **STAT LED** is lit continuously in green.

NOTE Upgrading the firmware upgrade will not change the original settings.

Reset to Factory Default

From the “Reset to Factory Default” page, click on **OK** (as shown in the following figure) to reset the VPort to its factory default settings.



NOTE All parameters will be reset to factory defaults when you use the **Factory Default** function. For this reason, if you want to keep a digital copy of the current configuration, remember to export the sys_config.ini file before using the Factory Default function.

Reboot

From the “Device Reboot” page, click on **OK** (as shown in the following figure) to restart the VPort.

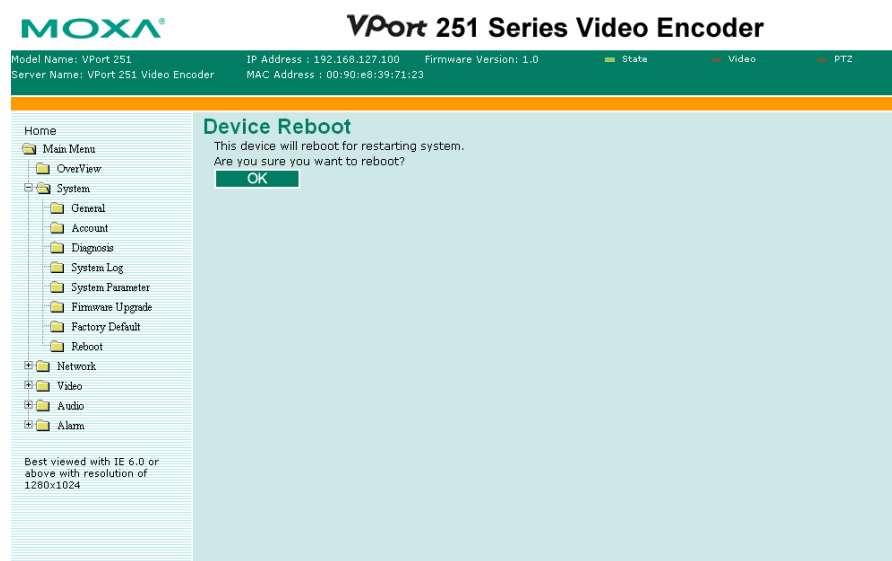

Network

General Network Settings

The **General Network Settings** page includes some basic but important network configurations that enable the VPort to be connected to a TCP/IP network.

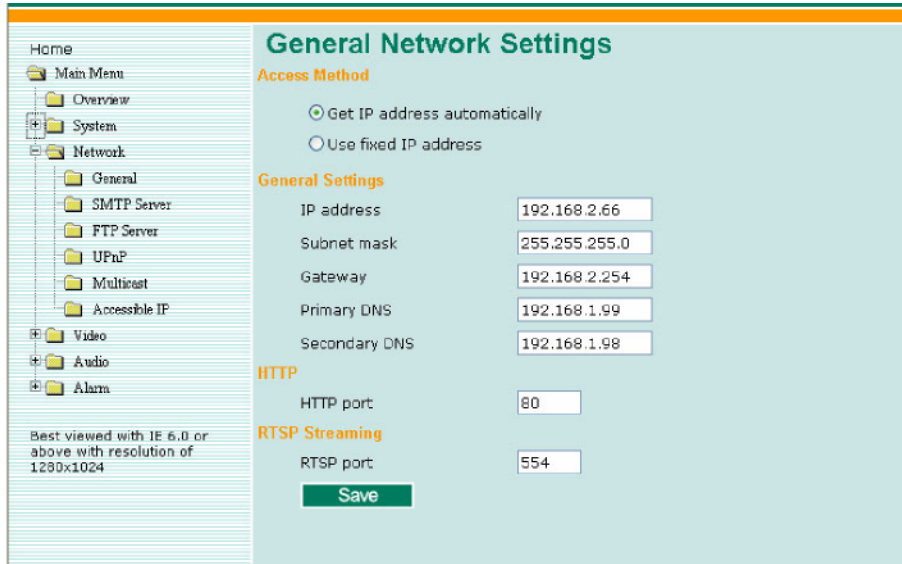

Access Method

VPort products support the DHCP protocol, which means that VPort can get its IP address from a DHCP server automatically when it is connected to a TCP/IP network. The Administrator should determine if it is more appropriate to use DHCP, or assign a fixed IP.

Setting	Description	Default
Get IP address automatically	VPort gets the IP address automatically from the DHCP server.	Get IP address automatically
Use fixed IP address	Use the IP address assigned by the administrator.	

NOTE We strongly recommend that the administrator assign a fixed IP address to the VPort, since all of the functions and applications provided by the VPort are active when the VPort is connected to the network. Use DHCP to determine if the VPort's IP address may change when then network environment changes, or the IP address is occupied by other clients.

General Settings

Setting	Description	Default
IP address	Variable IP assigned automatically by the DHCP server, or fixed IP assigned by the Administrator.	192.168.127.100
Subnet mask	Variable subnet mask assigned automatically by the DHCP server, or a fixed subnet mask assigned by the Administrator.	255.255.255.0
Gateway	Assigned automatically by the DHCP server, or assigned by the Administrator.	Blank
Primary DNS	Enter the IP address of the DNS Server used by your network. After entering the DNS Server's IP address, you can input the VPort's url (e.g., www.VPort.company.com) in your browser's address field, instead of entering the IP address.	Obtained automatically from the DHCP server, or left blank in non-DHCP environments.
Secondary DNS	Enter the IP address of the DNS Server used by your network. The VPort will try to locate the secondary DNS Server if the primary DNS Server fails to connect.	Obtained automatically from the DHCP server, or left blank in non-DHCP environments.

HTTP

Setting	Description	Default
HTTP Port (80, or 1024 to 65535)	HTTP port enables connecting the VPort to the web.	80

RTSP Streaming

The VPort 251 supports standard RTSP (Real Time Streaming Protocol) streaming, which means that all devices and software that support RTSP can directly acquire and view the video images sent from VPort 251 without any proprietary codec or SDK installations. This makes network system integration much more convenient. For different connection types, the **access name** is different. For UDP and TCP streams, the access name is **udpStream**. For HTTP streams, the access name is **moxa-cgi/udpStream**. For multicast streams, the access name is **multicastStream**. You can access the media through the following URL: **rtsp://<IP address>:<RTSP port>/<Access name> for software that supports RTSP.**

Setting	Description	Default
RTSP Port	An RTSP port is similar to an HTTP port, which can enable the connection of video/audio streams by RTSP.	554

We use Apple QuickTime media player to illustrate RTSP streaming applications:

Step 1: Open Apple QuickTime Player and select **File - Open URL in New Player**.



Step 2: When the following pop-up window appears, type the URL in the input box. E.g., type **rtsp://<VPort 251's IP address>[:<RTSP Port>]/unicaststream** or **rtsp://<VPort 251's IP address>[:<RTSP Port>]/multicaststream**, **RTSP Port: 554 Is default** and then click on **OK** to connect to the VPort 251.



Step 3: Wait a few seconds for QuickTime Player to establish the connection.



Step 4: After the connection has been established, the VPort 251's video will appear in the QuickTime Player display window.



NOTE The video performance of the VPort 251 in other media players may not always be the same. For example, you will notice a greater delay when viewing the VPort 251's video from QuickTime player compared to viewing it directly from the VPort 251's built-in web server. In addition, viewing the VPort 251's video from Quicktime player through a router or Internet gateway could result in a broken connection.

NOTE For the time being, the VPort 251's RTSP video/audio stream can be identified and viewed by Apple QuickTime Ver. 6.5 and above, and VLC media player. System integrators can use these 2 media players to view the VPort 251's video directly, without needing to use the VPort's SDK to create customized software.

SMTP Server and Email Account Settings

The VPort not only plays the role of server, but can also connect to outside servers to send alarm messages and snapshots. If the administrator has set up some applications in either system information or alarm, the VPort will send out messages or snapshots once these conditions occur.

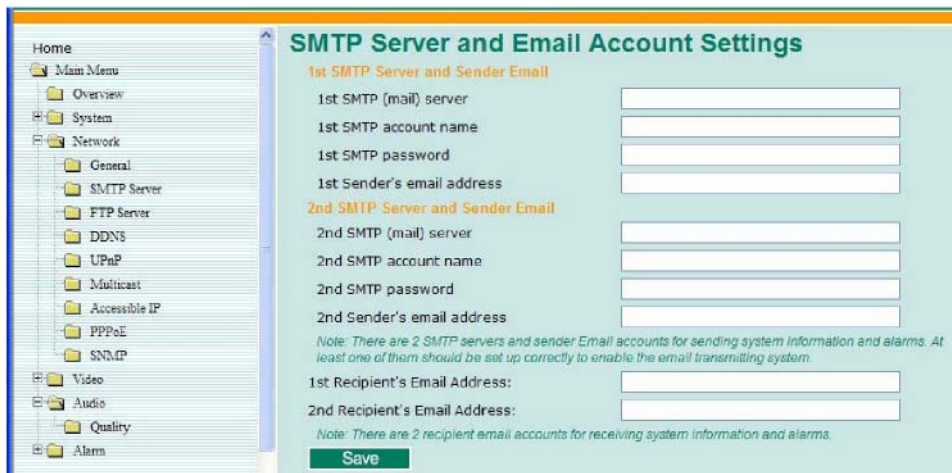

1st SMTP Server and Sender Email

Setting	Description	Default
1st SMTP (mail) server	SMTP Server's IP address or URL address.	None
1st SMTP account name	For security reasons, most SMTP servers require the account name and password to be authenticated.	None
1st SMTP password		None
1st Sender's email address	For security reasons, SMTP servers must see the exact sender email address.	None

NOTE Note that if the **Sender's email address** is not set, a warning message will pop up and the e-mail system will not be allowed to operate.

NOTE The **2nd SMTP Server** and Sender Email are backups that are used if the 1st SMTP Server and Sender Email fail when connecting or sending email.

Two recipient email accounts are available for receiving emails sent by the VPort. For redundancy, both addresses receive the sent messages and alarm snapshots simultaneously.

Setting	Description	Default
1st Recipient's Email Address	Email address of the 1 st recipient.	None
2nd Recipient's Email Address	Email address of the 2 nd recipient.	None

FTP Server Settings

FTP is the other method available for the VPort to send alarm messages and snapshots.

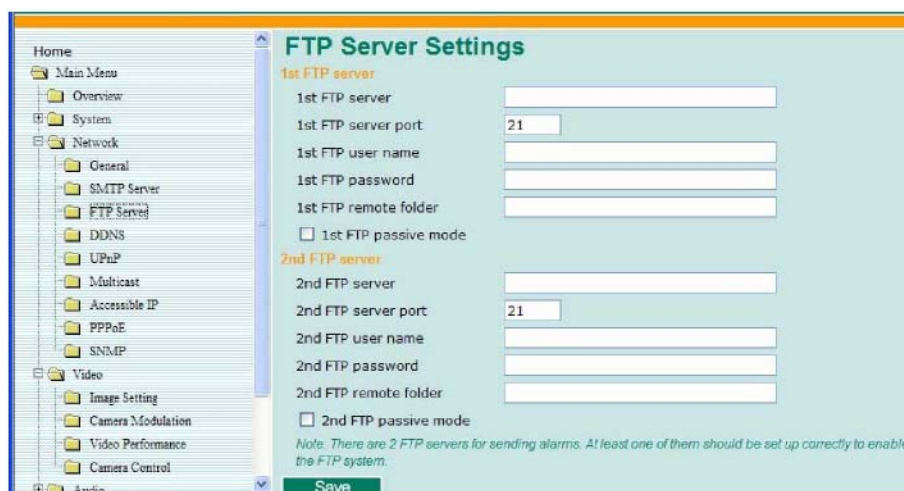

1st FTP Server

Setting	Description	Default
1st FTP server	FTP server's IP address or URL address.	None
1st FTP server port	FTP server's authentication.	None
1st FTP user name		None
1st FTP remote folder	FTP file storage folder on the remote FTP server.	None
1st FTP passive mode	Passive transfer solution for FTP transmission through a firewall.	Disabled

NOTE The **2nd FTP Server** is a backup in case the 1st FTP Server fails to connect or has trouble sending files.

NOTE Whenever the system reboots, a system log will be sent by email or FTP to show the login status of the VPort. The system log will be sent to the Sender email address if the SMTP server settings are correct. To send the system log via FTP, the SMTP server should be erased since the E-mail system is used by default to transmit the system log.

NOTE For either e-mail or FTP, the information of the 1st server should be entered first. If the 1st server is not set, the related FTP or email will be cancelled. Note that it may take time to connect to the 2nd server after the first server fails, and it may affect some applications when adverse conditions occur too often.

Dynamic DNS

DDNS (Dynamic Domain Name System) is a combination of DHCP, DNS, and client registration. DDNS allows administrators to alias VPort's dynamic IP address to a static hostname in any of the domains provided by the DDNS service providers listed on VPort's Network/DDNS configuration page. DDNS makes it easier to access VPort from various locations on the Internet.

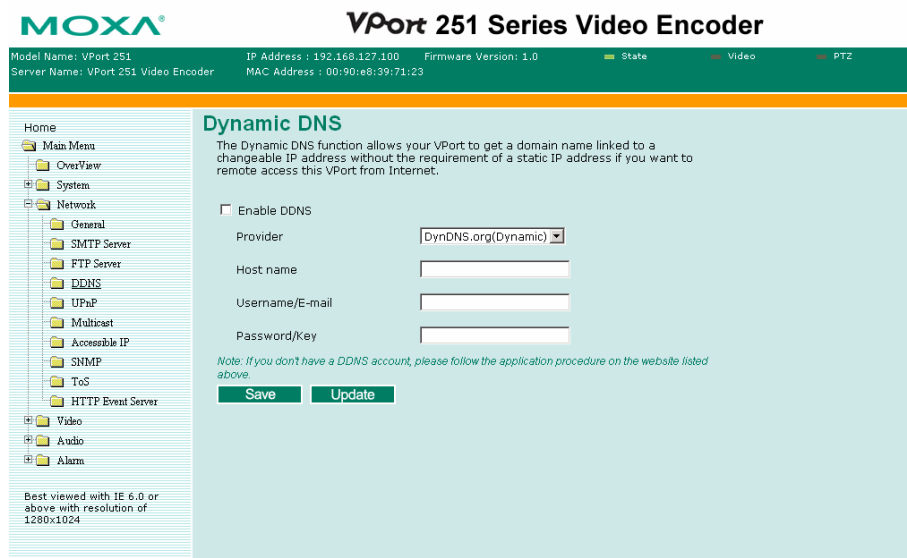

Setting	Description	Default
Enable DDNS	Enable or disable DDNS function	Disable
Provider	Select the DDNS service providers, including DynDNS.org (Dynamic), DynDNS.org (Custom), TZO.com, and dhs.org.	None
Host Name	The Host Name you use to link to VPort.	None
Username/ E-mail	The Username/E-mail and Password/Key are used to enable the service from the	None
Password/ Key	DDNS service provider (based on the rules of DDNS websites).	None

NOTE Dynamic DNS is a very useful tool for accessing VPort via the Internet, especially for xDSL connections with a non-fixed IP address (DHCP). Administrator and users can avoid the trouble of connecting with VPort when the IP address of VPort is not fixed by using the unique host name in the URL to establish a connection with VPort.

NOTE Different DDNS service providers have different application rules. Some applications are free of charge, but most require an application fee.

Universal PnP

UPnP (Universal Plug & Play) is a networking architecture that provides compatibility among networking equipment, software, and peripherals of the 400+ vendors that are part of the Universal Plug and Play Forum. This means that they are listed in the network devices table for the operating system (such as Windows XP) supported by this function. Users can link to VPort directly by clicking on the VPort listed in the network devices table.

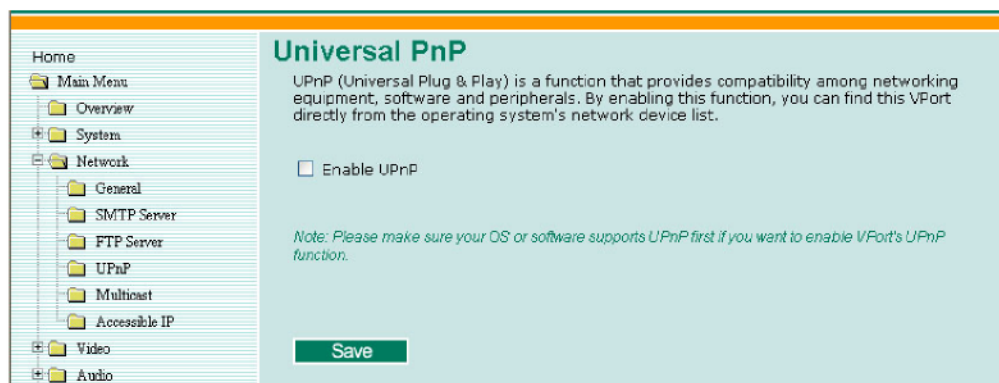

Setting	Description	Default
Enable UPnP	Enable or disable the UPnP function.	Enable

Multicast

The VPort 251 supports the advanced Multicast network protocol IGMP, which can greatly improve the efficiency of network traffic. In this section, we explain multicasts, multicast filtering, and how multicast can be implemented on your VPort.

What is Multicast?

A multicast is a packet that is intended for “one-to-many” and “many-to-many” communication. Users explicitly request to participate in the communication by joining an end-station to a specific multicast group. If the network is set up correctly, a multicast can only be sent to an end-station or a subset of end-stations on a LAN or VLAN that belong to the relevant multicast group. Multicast group members can be distributed across multiple subnetworks. Therefore, multicast transmissions can occur within a campus LAN or over a WAN. In addition, networks that support IP multicast send only one copy of the desired information across the network. The packets are only replicated if they reach a network node that links to two or more members of the multicast network. Transmitting packets in this way makes more efficient use of network bandwidth. A multicast packet is identified by the presence of a multicast group address in the destination address field of the packet's IP header.

Benefits of Multicast

The benefits of using IP multicast are that it:

- Enables the simultaneous delivery of information to many receivers in the most efficient, logical way.
- Reduces the load on the source (for example, a server) because it does not need to produce multiple copies of the same data.
- Makes efficient use of network bandwidth and scales well as the number of participants or collaborators expands.
- Works with other IP protocols and services, such as Quality of Service (QoS).
- There are situations where a multicast approach is more logical and efficient than a unicast approach. A typical use of multicasts is in video-conferencing, in which high volumes of traffic need to be sent to several end-stations simultaneously, but for which broadcasting that traffic to all end-stations would seriously reduce network performance. Besides, several industrial automation protocols, such as Allen-Bradley, EtherNet/IP, Siemens Profibus, and Foundation Fieldbus HSE (High Speed Ethernet), use the multicast approach. These industrial Ethernet protocols use publisher/subscriber communications models by multicasting packets that could flood a network with heavy traffic. IGMP provides the ability to prune multicast traffic so that it travels only to those end destinations that require the traffic, thus reducing the amount of traffic on the Ethernet LAN.

The network WITHOUT Multicast

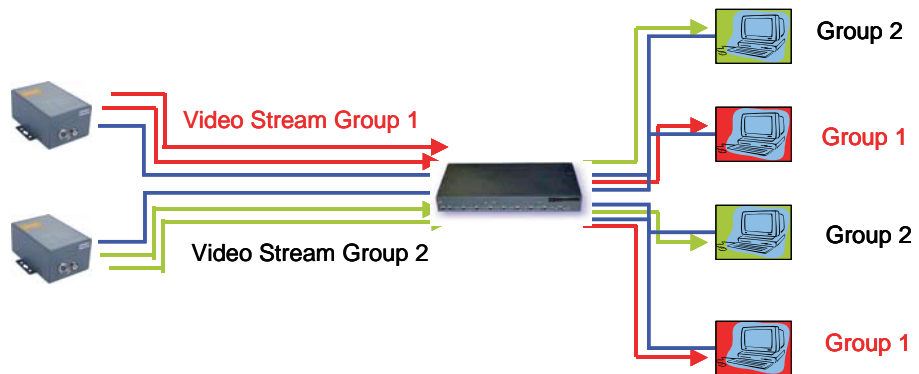

The network WITH Multicast

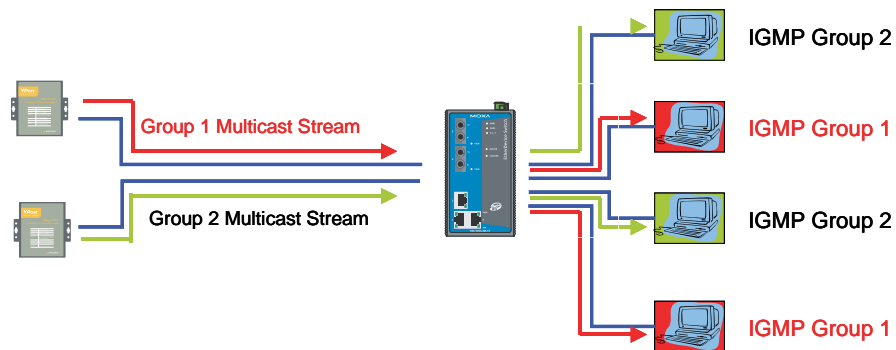

NOTE The VPort 251 is the source that delivers the multicast video stream. To benefit from the Multicast protocol, the gateway or network switch should support the multicast filtering function (such as IGMP Snooping) so that the multicast stream is delivered correctly and precisely. To learn more about IGMP Snooping, refer to the Moxa EtherDevice™ series Industrial Ethernet Switch user's manual.

Configuring Multicast Settings

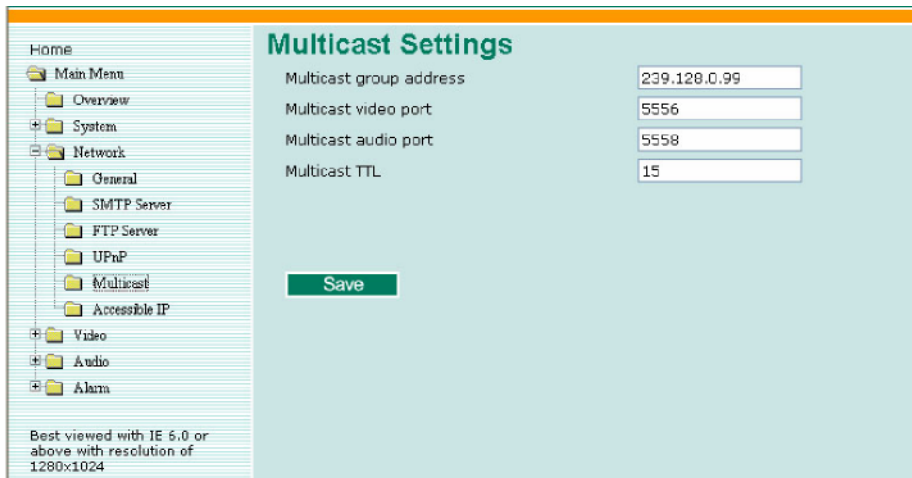

Setting	Description	Default
Multicast group address	Multicast Group address for sending video stream.	239.128.0.99
Multicast video port	Video port number.	5556
Multicast audio port	Audio port number.	5558
Multicast TTL	Multicast-TTL (Time-to-live) threshold. There is a certain TTL threshold defined for each network interface or tunnel. A multicast packet's TTL must be larger than the defined TTL for that packet to be forwarded across that link.	15

NOTE Whenever you enable the VPort's IGMP Multicast stream, note the video/audio port number.

Accessible IP List

The VPort 251 uses an IP address-based filtering method to control access to the VPort.

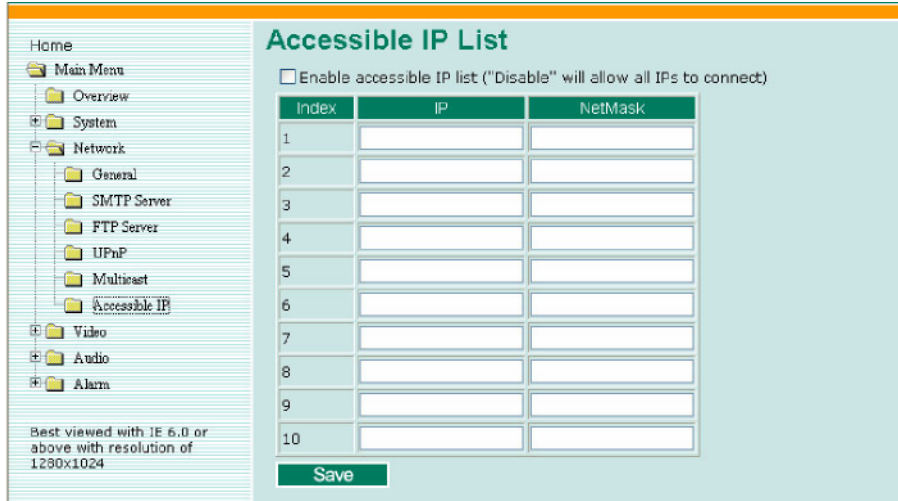

Accessible IP Settings allow you to add or remove “Legal” remote host IP addresses to prevent unauthorized access. Access to the VPort is controlled by IP address. That is, if a host’s IP address is in the accessible IP table, then the host will be allowed access to the VPort. Administrators can allow one of the following cases by setting this parameter:

- Only one host with a specific IP address can access the VPort. Enter “IP address/255.255.255.255” (e.g., 192.168.1.1/255.255.255.255)
- Hosts on a specific subnet can access the VPort.
- Enter “IP address/255.255.255.0” (e.g., “192.168.1.0/255.255.255.0”)
- Any host can access the VPort. Disable this function.

Refer to the following table for more configuration examples.

Allowable Hosts	Input Formats
Any host	Disable
192.168.1.120	192.168.1.120/255.255.255.255
192.168.1.1 to 192.168.1.254	192.168.1.0/255.255.255.0
192.168.0.1 to 192.168.255.254	192.168.0.0/255.255.0.0
192.168.1.1 to 192.168.1.126	192.168.1.0/255.255.255.128
192.168.1.129 to 192.168.1.254	192.168.1.128/255.255.255.128

SNMP

VPort supports three SNMP protocols. The available protocols are SNMP V1, SNMP V2c, and SNMP V3. SNMP V1 and SNMP V2c use a community string match for authentication, which means that SNMP servers access all objects with read-only or read/write permissions using the community string public/private (default value). SNMP V3, which requires you to select an authentication level of MD5 or SHA, is the most secure protocol. You can also enable data encryption to enhance data security. SNMP security modes and security levels supported by VPort are shown in the following table. Select one of these options to communicate between the SNMP agent and manager.

Protocol Version	Security Mode	Authentication Type	Data Encryption	Method
SNMP V1, V2c	V1, V2c Read Community	Community string	No	Use a community string match for authentication
	V1, V2c Write/Read Community	Community string	No	Use a community string match for authentication
SNMP V3	No-Auth	No	No	Use account with admin or user to access objects
	MD5 or SHA	MD5 or SHA	No	Provides authentication based on HMAC-MD5, or HMAC-SHA algorithms. 8-character passwords are the minimum requirement for authentication.
	MD5 or SHA	MD5 or SHA	Data encryption key	Provides authentication based on HMAC-MD5 or HMAC-SHA algorithms, and data encryption key. 8-character passwords and a data encryption key are the minimum requirements for authentication and encryption.

Configuring SNMP Settings

The following figures indicate which SNMP parameters can be configured. A more detailed explanation of each parameter is given below the figure.

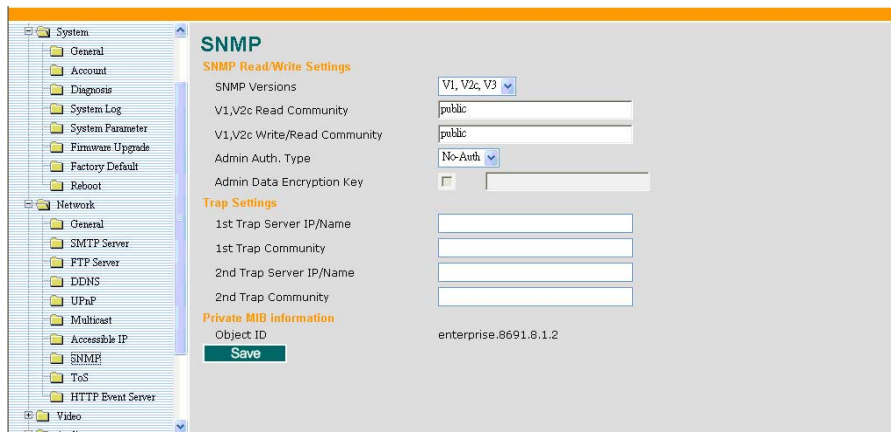

SNMP Read/ Write Settings

SNMP Versions

Setting	Description	Default
V1, V2c, V3	Select SNMP Versions V1, V2c, V3 protocol to manage the switch	V1, V2c
V1, V2c	Select SNMP Versions V1, V2c protocol to manage the switch	
V3 only	Select SNMP Versions V3 protocol only to manage the switch	

V1, V2c Read Community

Setting	Description	Default
V1, V2c Read Community	Use a community string match for authentication, which means that the SNMP agent accesses all objects with read-only permissions using the community string public .	public (max. 30 characters)

V1, V2c Read/Write Community

Setting	Description	Default
V1, V2c Read/Write Community	Use a community string match for authentication, which means that the SNMP agent accesses all objects with read-only permissions using the community string public .	public (max. 30 characters)

For SNMP V3, there are two levels of privilege for different accounts to access the VPort. Admin privilege allows access and authorized to read and write MIB file. User privilege only allows reading MIB file, but not authorized to write.

Root Auth. Type (For SNMP V1, V2c, V3 and V3 only)

Setting	Description	Default
No-Auth	Use admin. account to access objects. No authentication	No
MD5-Auth	Provide authentication based on the HMAC-MD5 algorithms. 8-character passwords are the minimum requirement for authentication.	No
SHA- Auth	Provide authentication based on the MAC-SHA algorithms. 8-character passwords are the minimum requirement for authentication.	No

Root Data Encryption Key (For SNMP V1, V2c, V3 and V3 only)

Setting	Description	Default
Enable	8-character data encryption key is the minimum requirement for data encryption. Maximum 30-character encryption key	No
Disable	No data encryption	No

User Auth. Type (For SNMP V1, V2c, V3 and V3 only)

Setting	Description	Default
No-Auth	Use account of admin or user to access objects. No authentication	No
MD5-Auth	Provide authentication based on the HMAC-MD5 algorithms. 8-character passwords are the minimum requirement for authentication.	No
SHA- Auth	Provide authentication based on the HMAC-SHA algorithms. 8-character passwords are the minimum requirement for authentication.	No

User Data Encryption Key (For SNMP V1, V2c, V3 and V3 only)

Setting	Description	Default
Enable	8-character data encryption key is the minimum requirement for data encryption. Maximum 30-character encryption key	No
Disable	No data encryption	No

Trap Settings

Setting	Description	Default
Trap Server IP/Name	Enter the IP address or name of the Trap Server used by your network.	No
Trap Community	Use a community string match for authentication; Maximum of 30 characters.	No

Private MIB information

The private SNMP Object ID of the VPort is the enterprise value: 8691.8.1.2. This number is cannot be changed.

QoS (ToS)

Quality of Service (QoS) provides a traffic prioritization capability to ensure that important data is delivered consistently and predictably. VPort 251 Series can inspect layer 3 ToS (Type of Service) information, to provide a consistent classification of the entire network. VPort 251 Series' ToS capability improves your industrial network's performance and determinism for mission critical applications.

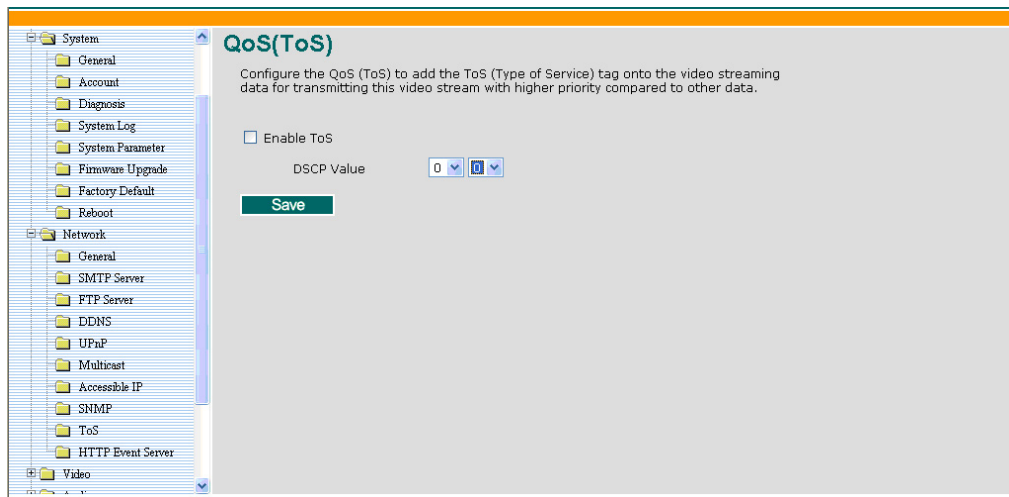

Setting	Description	Factory Default
Enable ToS	Enable the ToS for transmitting the video stream with the given priority	Disable
DSCP Value	Set the mapping table of different ToS values	0, 0

NOTE To configure the ToS values, please mapping to the network environment settings for the QoS priority service.

HTTP Event Servers

VPort 251 series can send the customized alarm actions and messages to the HTTP Event Servers, which enables the capability for the users designing the customized alarm system.

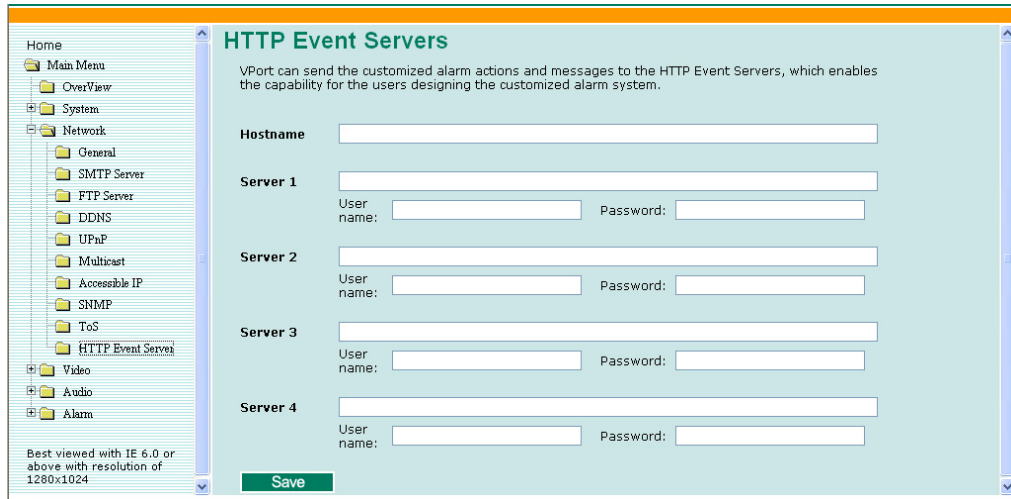

Video

Image Settings

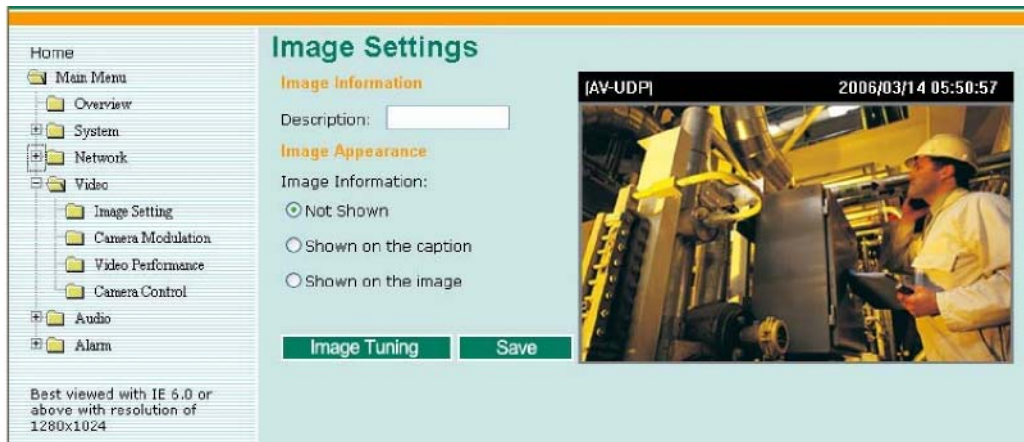

Image Information Setting

	Description	Default
Description (max. of 14 characters)	The customized description shown on the caption or image to identify this video camera.	None

Image Appearance Setting

	Description	Default
Image Information	To determine what style of image information is being shown. Includes Not Shown, Shown on the Caption, and Shown on the Image.	Not Shown

Image Tuning

An Image Tuning button is available for the administrator to fine tune image attributes. After clicking this button, a configuration window will pop up. You may configure **Brightness, Contrast, Saturation, and Hue.**

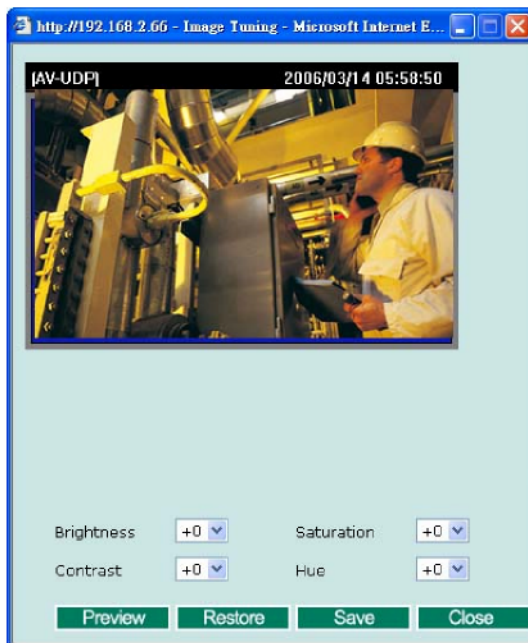

Camera Modulation

The VPort 251 supports both NTSC and PAL camera modulations. The Administrator can use automatic sensing by selecting **Auto**, or manually select **NTSC** or **PAL**.

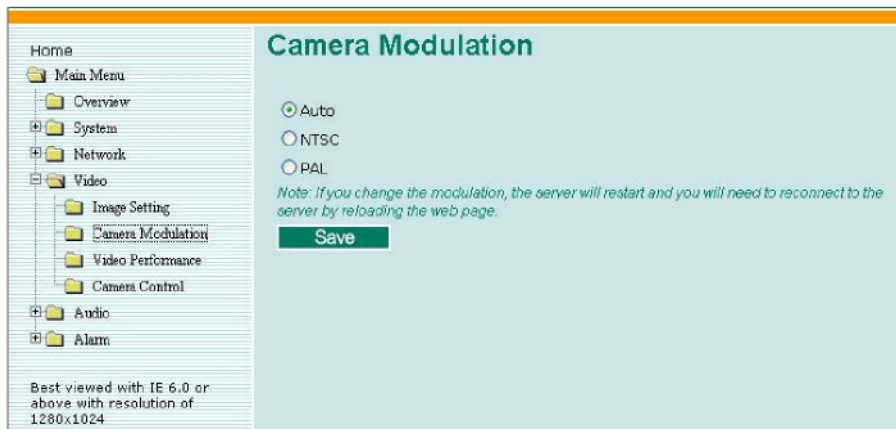

NOTE Changing the modulation requires resetting the server to detect the camera. Please ensure that your configurations are saved before resetting the server.

Video Performance

VPort 251 support MPEG4 or MJPEG compression standard. Users should select the video compression in first to identify the video stream format.

For MJPEG, users can setup the **Resolution, Frame Rate** and Video Quality in **Fixed Quality**.

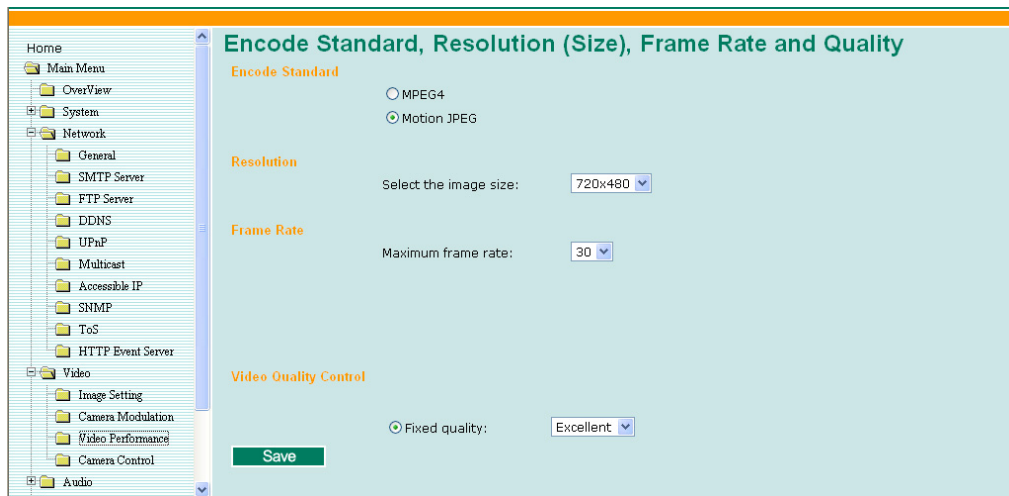

For MPEG4, users can setup **Resolution, Frame Rate** and Video Quality in **Fixed Bit Rate** or **Fixed Quality**.

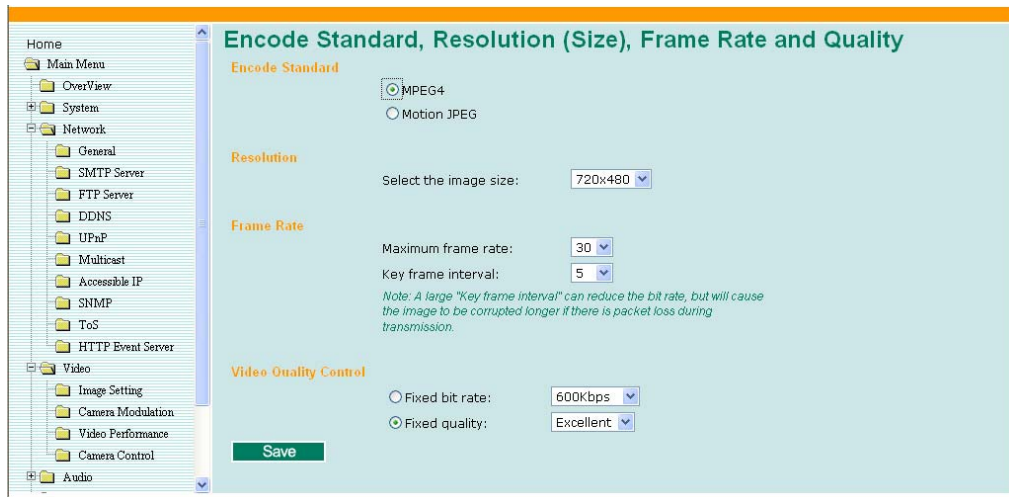

Resolution

The VPort 251 supports 5 different resolutions: Full D1, 4CIF, VGA, CIF, and QVGA.

Setting	Description	Default
Select the image size	5 image resolutions (size) are provided. The administrator can choose each option with NTSC or PAL modulation.	720 x 480 in NTSC or 720 x 576 in PAL

Resolution	NTSC	PAL
Full D1	720 x 480	720 x 576
4CIF	704 x 480	704 x 576
VGA	640 x 480	640 x 576
CIF	352 x 240	352 x 288
QVGA	320 x 240	320 x 288

Frame Rate (Frame per second)

Setting	Description	Default
Maximum frame rate	The maximum frame rate is different to accommodate different modulations of video input. Administrators can also set up the maximum frame rate to optimize the bandwidth's occupation.	30 for NTSC 25 for PAL
Key frame interval (Only for MPEG4)	Administrators can set up the key frame interval to determine the video quality.	15

NOTE Frame rate (frames per second) is determined by the resolution, image data size (bit rate), and transmission traffic status. The Administrator and users can check the frame rate status in the **FPS Status** on VPort's web homepage.

NOTE A large "Key frame interval" can reduce the bit rate, but will cause the image to be corrupted longer if there is packet loss during transmission.

Video Quality Control

Video Quality Control is used to optimize the bandwidth of the MPEG4 video stream. There are 2 modes for video quality control.

Setting	Description	Default
Fixed bit rate (Only for MPEG4)	The administrator can fix the bandwidth to tune the video quality and FPS (frames per second) to the optimum combination. You may choose from the following bandwidths: 600 Kbps, 1200 Kbps, 1800 Kbps, 2400 Kbps, 3000 Kbps, 3600 Kbps, 4200 Kbps, 4800 Kbps, and 5400 Kbps to let the VPort determine the quality and frame rate by itself. The combination of image quality and FPS is determined by the bandwidth.	Fixed bit rate of 600 Kbps
Fixed Quality	The administrator can set the image quality to one of 5 standards: Medium, Standard, Good, Detailed, or Excellent . The VPort will tune the bandwidth and FPS automatically to the optimum combination.	Excellent

NOTE The image quality, FPS, and bandwidth are influenced significantly by network throughput, system network bandwidth management, applications the VPort runs (such as VMD), how complicated the image is, and the performance of your PC or notebook when displaying images. The administrator should take into consideration all of these variations when designing the video over IP system, and when specifying the requirements for the video system.

Camera Control

The VPort supports PTZ (PAN/TILT/ZOOM) motorized camera control via an RS-232, RS-422, or RS-485 COM port. Before setting up camera control, the administrator should first connect the PTZ camera to the VPort. (Please refer to Chapter 2 for the PTZ port's wiring specifications.)

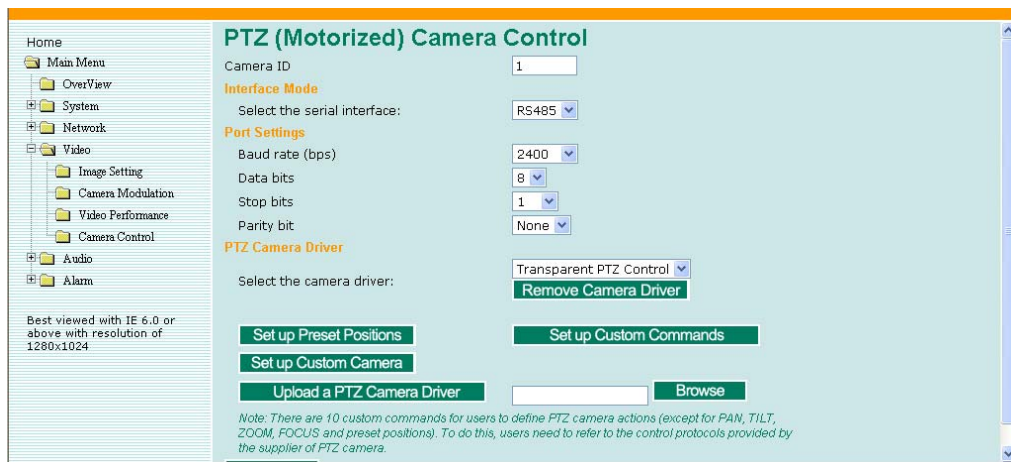

Setting	Description	Default
Camera ID	Each PTZ camera has an ID to identify which PTZ camera is in the multi-drop connection. To connect to the PTZ camera, the VPort should first identify its ID.	1

Interface mode

Setting	Description	Default
Select the serial interface	The PTZ COM port supports 2 serial interfaces, although only one interface can be used at a time. Depending on the interface used by the attached device, administrators must set the Interface mode to either RS-232 or RS485/ RS-422.	RS485

Port Settings

Setting	Description	Default
Baud rate (bps)	The baud rate specified by the PTZ camera's serial communication specs.	2400
Data bits	The parameters used to define the serial communication.	8
Stop bits		1
Parity bits		None

PTZ Camera Drivers

VPort products come with PTZ camera drivers for some of the popular PTZ cameras. Administrators can select the correct PTZ driver in Select the camera driver menu. If the attached PTZ camera is not supported by the VPort, administrators can use the Custom Camera function to enter the proprietary commands for pan, tilt, zoom, and focus control.

Setting	Description	Default
Select the camera driver	Use the built-in PTZ drivers, including <ol style="list-style-type: none"> 1. Transparent PTZ control 2. Custom Camera 3. Pelco D 4. Pelco P 5. Dynacolor DynaDome 	None

NOTE For Transparent PTZ control, please refer to Chapter 2.

NOTE If users want to connect the PTZ control or keyboard with a PC to control the PTZ camera connected with VPort, please refer to the VPort SDK PLUS- ActiveX SDK to get the Moxa RealCOM driver and implementation information.

Setting Up a Preset Position

Administrators can use the **Preset Position** function to set up the behavior of the PTZ camera in advance, and then users with camera control privilege can move the camera's lens to a preset position without the need to control the pan, tilt, and zoom buttons on the VPort 251's homepage.

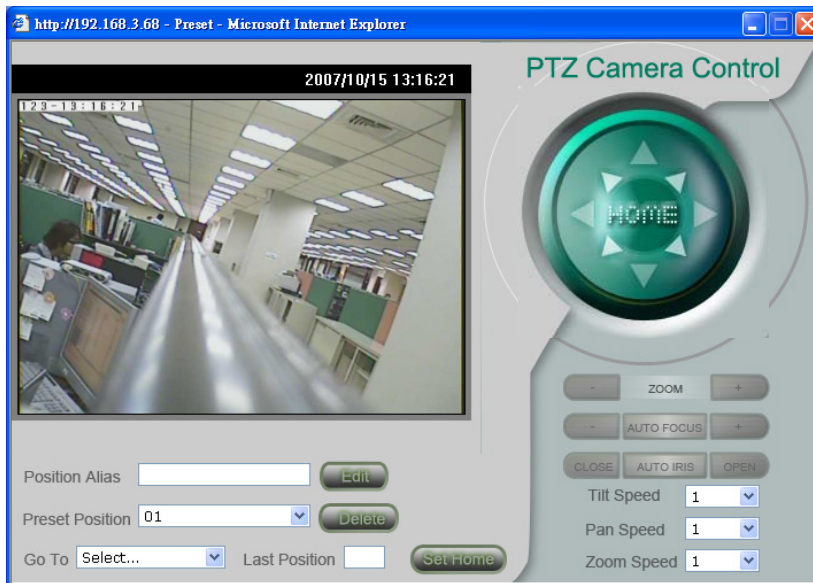

Set Up Custom Commands

VPort products provide 10 custom commands in addition to the general pan, tilt, zoom, and preset functions, which are also shown on the PTZ Control Panel . Administrators can click on **Setup Custom Commands** to configure the commands, and refer to the manual enclosed with the attached PTZ camera to set up frequently-used functions. The **Command** should be entered in ASCII format. The VPort will translate the commands into binary code and then send the data out through the serial port. For instance, the text string 81 01ABCDEF will be translated into five bytes of hexadecimal: 81, 01, AB, CD, and EF. The maximum length of a command string is 60, which is equivalent to 30 hexadecimal bytes. The **Display string** is for the text on the command buttons and should be less than 8 characters. If **Custom Camera** is selected, there will be more commands for PTZF that relate to custom camera.

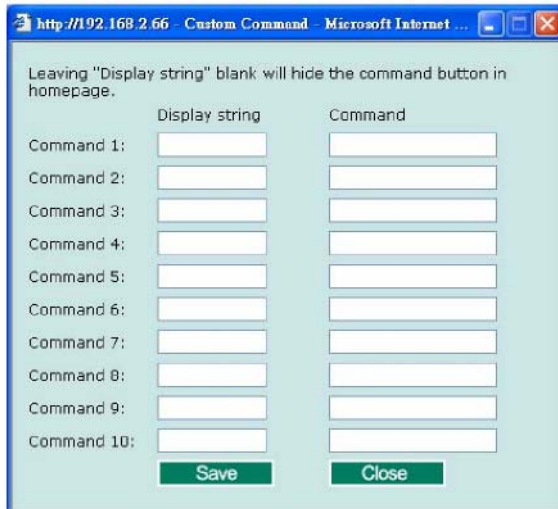

Setting Up Custom Camera

If the PTZ camera's driver is not in the list, the administrator can select the custom camera from the **Select Camera driver** menu to program the PTZ camera with ASCII code. A custom camera window will pop up when the **Setup Custom Camera** button is clicked. Input the ASCII code into this window. **Port Settings (Data bits, Stop bits, and Parity bits)** are for the serial communication parameters and **Control Settings** are for programming the **TILT (Move Up, Move Down)**, **PAN (Move Left, Move right)**, **HOME**, **ZOOM (Zoom in, Zoom out)** and **FOCUS (Focus near, Focus Far)** actions.



NOTE The control protocols are available from the PTZ camera's supplier. You will need to get the protocols from the supplier before programming the PTZ camera.

Uploading a PTZ Camera Driver

In addition to the PTZ camera drivers and custom camera functions supported by the VPort 251, an alternative user-friendly **Upload a PTZ Camera Driver** function is available for implementing the PTZ camera control. Moxa will release new PTZ camera drivers to Moxa's website as they become available. Administrators can click on **Browse** to upload the new PTZ camera drivers to the VPort 251.

Audio

Audio Source

The VPort 251 supports real-time and synchronous video/audio transmission. Administrators need to select the correct input type of audio source to avoid audio input distortion.

Setting	Description	Default
Audio Source	For the audio connection, MIC-in (microphone) and Line-in (voice amplifier) are included for convenience.	Microphone



Alarm

System Alarm

In addition to the LED indicators, three kinds of system alarm are provided by the VPort 251 for notifying the system operation administrator.

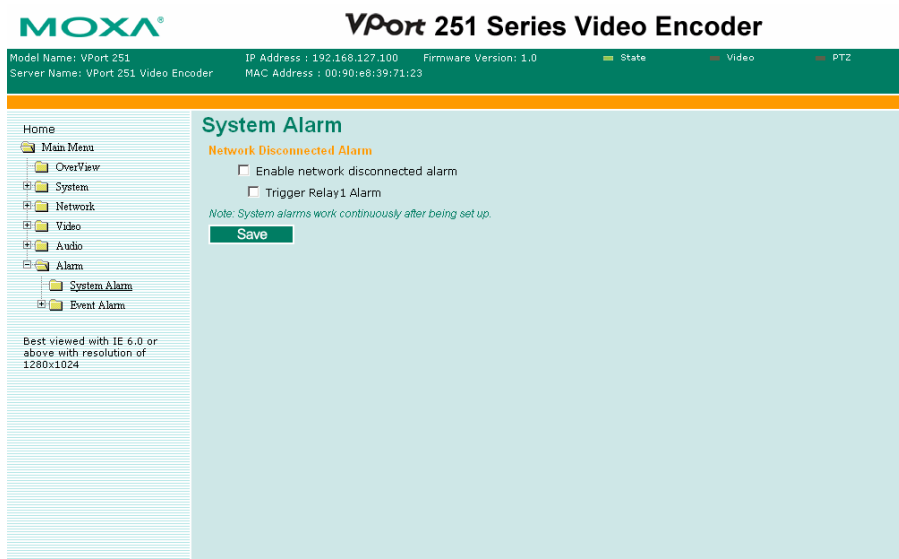

Alarm Type	Triggered Condition	Triggered Action
Network Disconnected	Network disconnected	Relay

Network Disconnected Alarm

Setting	Description	Default
Enable network disconnected alarm	Enable or disable network disconnected alarm.	Disable
Trigger Relay alarm	Enable or disable the action of triggering Relay 1 or Relay 2 alarms.	Disable

NOTE

Since several alarms can be set up to trigger the VPort's relays, the administrator should configure these alarms carefully in case a relay message is read incorrectly.

Event Alarm

Four kinds of event alarm are provided by the VPort 251 for building an intelligent video surveillance system.

Alarm Type	Triggered Condition	Triggered Action
Video Motion Detection (VMD)	1. VMD 1 2. VMD 2 3. VMD 3	1. Relay 2. Email 3. FTP 4. HTTP Event Server
Digital Inputs	DI	1. Relay 2. Email 3. FTP 4. HTTP Event Server
Video Loss	Video signal is lost	1. Relay 2. Email 3. HTTP Event Server
Sequential Snapshot	Enable sequential snapshot	1. Email 2. FTP

Basic

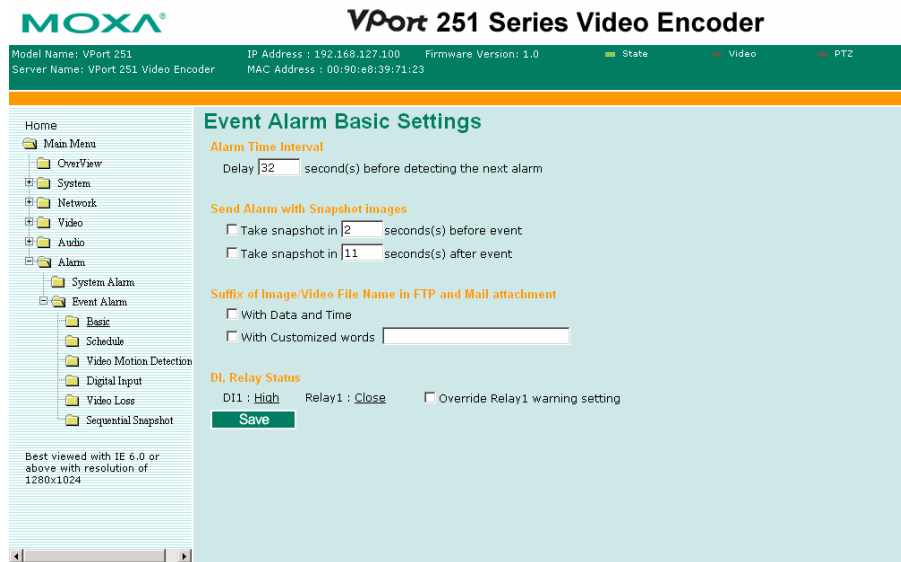

Alarm Time Interval

Setting	Description	Default
Delay second(s) before detecting the next alarm	Set up the time interval for each event alarm triggered.	32 seconds (10 to 999 seconds)

NOTE The delay before detecting the next alarm cannot be less than the time needed to take a snapshot after an event (post-event image).

Send alarm with snapshot image

Setting	Description	Default
Take snapshot seconds(s) before the event	A snapshot image is taken this number of seconds before the event alarm is triggered.	2 seconds (from 1 to 6 seconds)
Take snapshot seconds(s) after the event	A snapshot image is taken this number of seconds after the event alarm is triggered.	11 seconds (from 1 to 999 seconds)

NOTE VPort products will take 3 JPEG snapshot images: VPRE.JPG (pre-event), VTRG.JPG (the moment of event) and VPOS.JPG (post-event) for the video channel when the trigger condition is met. The three snapshots can also be downloaded by Email and FTP.

Suffix of Snapshot Image File Name in FTP

The snapshot images can be sent either by email or FTP. Administrators can add a suffix to the filename of each JPEG snapshot image to make it easier to identify the files when using FTP to download the snapshots.

Setting	Description	Default
With Date and Time	Enable or disable the function of adding the date and time to the filename.	Enable
With Customized words	Enable or disable the function of adding some additional text to the filename to identify the snapshot image.	Enable

DI, Relay Status

Administrators can check the current DI and Relay status of this VPort in the "DI, Relay Status" section on the "Event Alarm Basic Settings" page. Two options are available to return the relay's status back to the system defaults. To make the function work, check the **Override Relay warning setting** box, and then click on **Save**.

NOTE The relays will not be triggered when the **Override Relay warning setting** box is checked. Un-check this box to ensure that the relays will trigger.

Schedule

A schedule is provided to set event alarms for daily security applications.

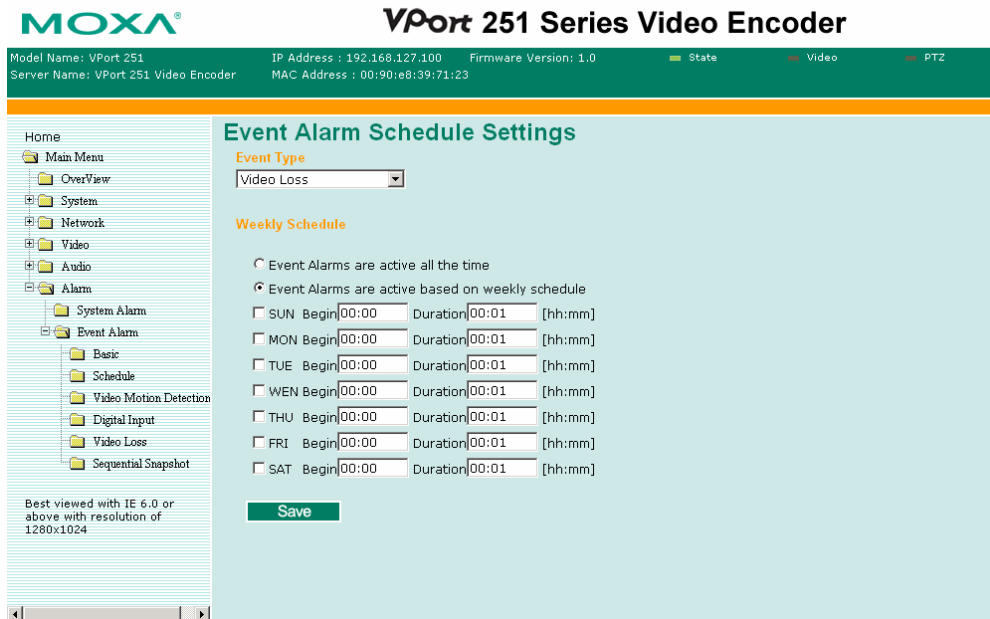

Event Type

Setting	Description	Default
Video Loss, Digital Input, Video Motion Detection, Network Failure, and Sequential Snapshot	Set up the schedule of each kind of event type.	Video Loss

Weekly Schedule

Setting	Description	Default
Event Alarms are active all the time	Select the option “Event Alarms are active all the time”	Event Alarms are active all the time
Event Alarms are on a weekly schedule	Select to operate event alarms on a weekly schedule.	

NOTE The applications described in the following sections will only work properly if either **Event Alarms are active all the time** or **Event Alarms are active based on weekly schedule** is selected.

Setting	Description	Default
[I]Sun [I]Mon [I]Tue [I]Wed [I]Thu [I]Fri [I]Sat	Select the weekday for scheduling event alarms.	None
Begin 00:00	Set the beginning time of the event alarm.	00:00
Duration 00:00	Set the time period of the event alarm to be activated.	00:00

- NOTE** Administrators can use the following few steps to set up an event schedule:
1. Select Event Type
 2. Enable Event Alarms are active based on weekly schedule
 3. Select the weekday
 4. Set up the begin time
 5. Set up the duration this event will be active.
 6. Save

Video Motion Detection

Video Motion Detection (VMD) is an intelligent event alarm for video surveillance network systems. With the 3 area-selectable VMDs and sensitivity/percentage tuning, administrators can easily set up the VMD alarm to be active 24 hours a day, 7 days a week.

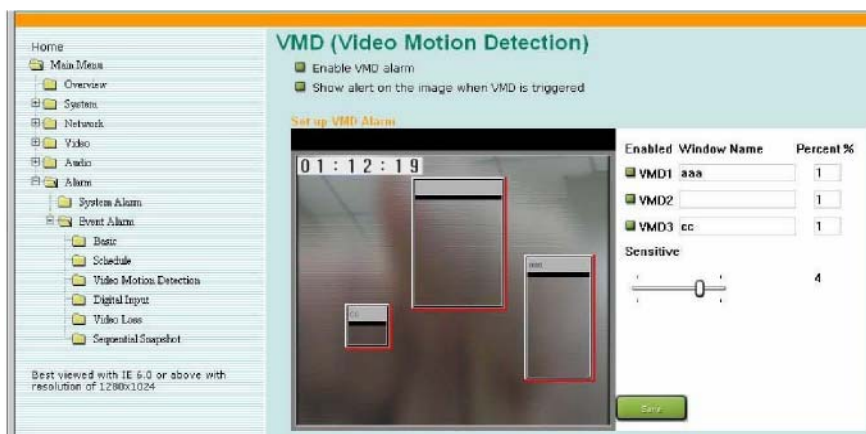

Setting	Description	Default
Enable VMD alarm	Enable or disable the VMD alarm.	Disable
Show alert on the image when VMD is triggered	Enable or disable alert for sections of the homepage image on the homepage.	Disable

NOTE Once the Show alert on the image when VMD is triggered is enabled, the red frames that appear on the homepage image indicate the size of the VMD window set up by the administrator.



Set up a VMD alarm

Setting	Description	Default
Window Name	The name of each VMD window.	None
Sensitivity	The measurable difference between two sequential images to trigger VMD. Set a larger sensitivity to make it easier for the VMD to be triggered.	1
Percentage	The minimum size of the image change to trigger the VMD. Set a smaller percentage to make it easier to trigger the VMD.	0%

Trigger Conditions and Actions

Administrators can set up triggers for each VMD, including **Trigger Relay alarm**, **Send snapshot image via E-mail**, **Send snapshot image via FTP**, and **HTTP Action Settings**.

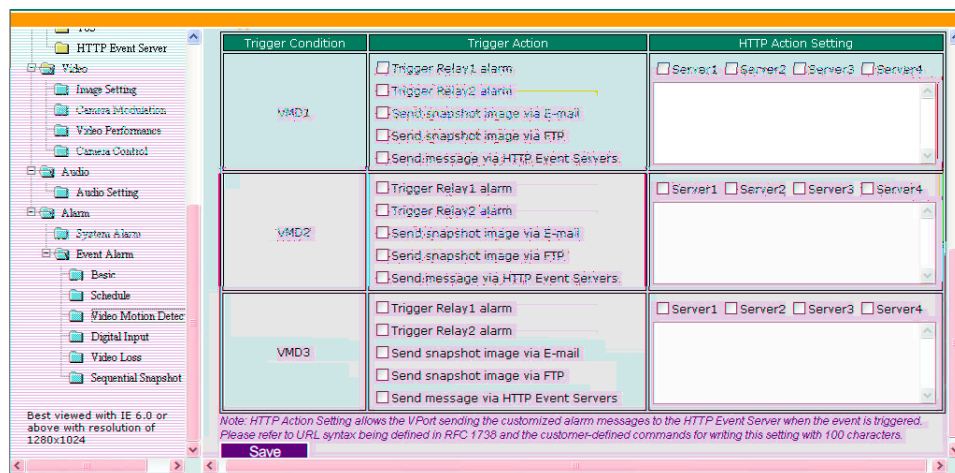

How to Set up a VMD alarm

- Step 1:** Check the **Enable VMD alarm** box. If the Administrator wants to show the red frame alert on the image on the VPort 251's web homepage, check the **Show alert on the image when VMD is triggered** box. Click on the **Save** button to save these 2 configurations.
- Step 2:** Check on VMD1~3 to enable the VMD window. Left click the title bar of this window to move the location of the VMD window, or drag the border to change the window size so that it fits the desired VMD area.
- Step 3:** Assign a name to the VMD window in the **Window Name** column.
- Step 4:** Set up the **Percentage** parameters for individual VMD windows and the **Sensitivity** for all VMD windows.
- Step 5:** Click on the **Save** button to save the settings.
- Step 6:** To test the VMD condition, check the action of the graphics bar on the left side of the save button. Wave your hand in front of the camera, in the VMD area, and then note which color shows up in the graphics bar. Green means VMD is not triggered. Red means VMD is triggered.
- Step 7:** Set up the Trigger Conditions and Actions of each VMD, and then click on the **Save** button to save these configurations.

NOTE Video Motion detection is provided as a reference because it is environment-dependent. When the settings are configured to be very sensitive to motion, some triggered events might actually be false alarms, since in fact there is only a tiny difference between sequential images. False alarms can be triggered by the flashing of florescent lights, shifting of shadows, etc.

Digital Input

One digital input is provided by the VPort 251 for linking with alarm detection devices, such as sensor.

Setting	Description	Default
Enable digital input alarm	Enable or disable the digital input alarm.	Disable

Trigger Conditions

Setting	Description	Default
High	The DI is always in the "High" state after an alarm is detected.	Disable
Low	The DI is always in the "Low" state after an alarm is detected.	Enable
Rising	The DI works from state "Low" to state "High" and then back to state "Low" when an alarm is detected.	Disable
Falling	The DI works from state "High" to state "Low" and then back to state "High" when an alarm is detected.	Disable

NOTE Please refer to Chapter 1 to see the DI specifications.

Trigger Actions

Administrators can set up trigger actions for each DI, including Trigger Relay alarm, Send snapshot image via E-mail, Send snapshot image via FTP, and HTTP Action Settings.

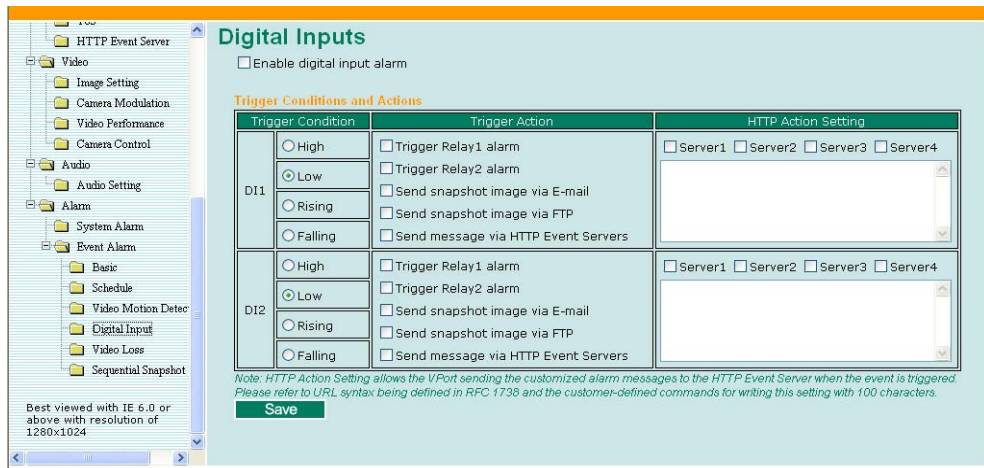

Video Loss

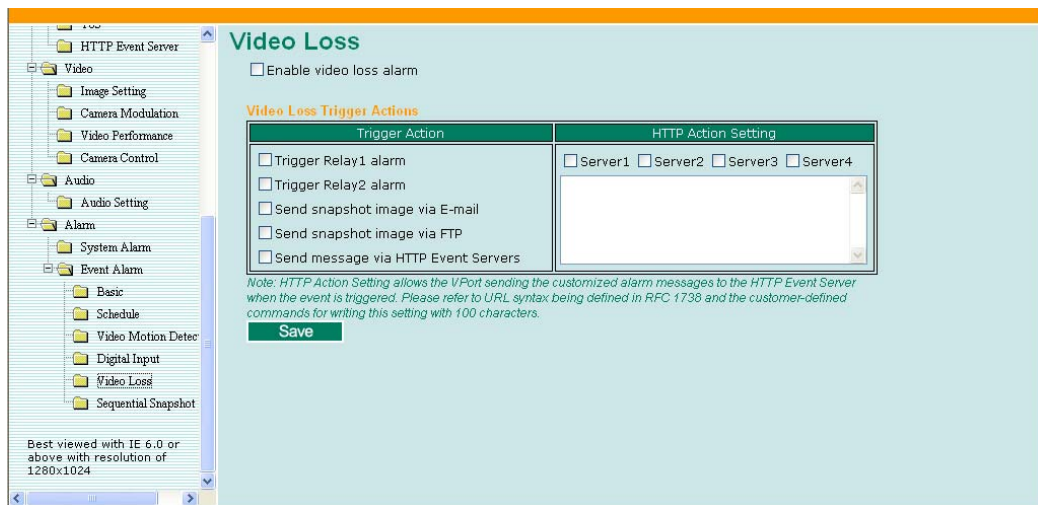

Setting	Description	Default
Enable video loss alarm	Enable or disable video loss alarm.	Disable
Trigger Relay alarm	Enable the trigger action in triggering Relay alarms.	Disable
Send Snapshot Image	Enable the trigger action to send a warning message via email and FTP	Disable

Alarm/Event Alarm/Sequential Snapshot

With this feature, the VPort can upload snapshots periodically to an external E-mail or FTP server as a live video source. Use the **Send sequential snapshot image every seconds** option to set the time interval. The interval can be set to any number from 1 second to 9999 seconds.

Setting	Description	Default
Enable Sequential Snapshots	Enable or disable the Sequential Snapshots.	Disable
Send sequential snapshot image every seconds	Set the time interval of each snapshot image.	30 seconds (from 1 second to 30 seconds)
Send Snapshot image via E-mail	Choose how to send the snapshot images.	Send Snapshot image via Email
Send Snapshot image via FTP		





Frequently Asked Questions

Q: What if I forget my password?

A: Every access to the video encoder needs authentication, unless the admin password is set up as blank. If you are one of the managed users, you will need to ask the administrator for the password. If you are the administrator, there is no way to recover the admin password. The only way to regain access to video encoder is to utilize the **RESET** button on the top panel to restore the factory settings (see Chapter 1 for details).

Q: Why can't I see video from the video encoder after it has been authenticated?

A: There are many possible scenarios:

1. If you have just installed the video encoder and are unable to see the video, check the video modulation on the **System Configuration\Video\Camera Modulation** page.
2. If the video encoder is installed correctly and you are accessing the video encoder for the first time using Internet Explorer, adjust the security level of Internet Explorer to allow installation of plug-ins.
3. If the problem still exists, the number of users accessing the video encoder at the same time may exceed the maximum that the system allows.

Q: What is the plug-in for?

A: The plug-in provided by video encoder is used to display motion pictures. The plug-in is needed because Internet Explorer does not support streaming technology. If your system does not allow installation of plug-in software, the security level of the web browser may need to be lowered. It is recommended that you consult the network supervisor in your office before adjusting the security level.

Q: Why is the timestamp different from the system time of my PC or notebook?

A: The timestamp is based on the system time of the video encoder. It is maintained by an internal real-time clock, and automatically synchronizes with the time server if the video encoder is connected to the Internet and the function is enabled. Differences of several hours may result from the time zone setting.

Q: Why doesn't the image refresh regularly?

A: This may be due to the time it takes to store recorded video and snapshots into memory, or the time it takes to send the images to the SMTP and FTP server when events occur.

Q: How many users are allowed to access the video encoder at the same time?

A: Basically, there is no limitation. However the video quality also depends on the network bandwidth. To achieve the best effect, the video encoder will allow 10 users for udp/tcp/http connections and 10 users for multicast to be connected. We recommend using an additional web server that retrieves images from the video encoder periodically if you need to host a large number of users.

Q: What is the video encoder's video rate?

A: The codecs can process 30 frames per second internally. However the total performance is subject to many coefficients, as listed below:

1. Network throughput.
2. Bandwidth share.
3. Number of users.
4. More complicated objects result in larger image files.
5. The level of your PC or notebook that is responsible for displaying images.

In general, the transfer rate for a general local network environment can achieve over 800 kilobytes per second and approximately 10 to 20 pictures of a normal environment per second.

Q: How can I keep the video encoder as private as possible?

A: The video encoder is designed for surveillance purposes and has many flexible interfaces. The user authentication and special confirmation when installing can keep the video encoder from unauthorized access. You may also change the HTTP port to a non-public number. Check the system log to examine any abnormal activities and trace the origins.

Q: I have a PTZ camera that is not on the support list. How can I control it?

A: The video encoder provides a custom camera command interface to control cameras that are not supported. The details are described in this manual. Be sure that the PTZ port settings are applied to the camera specifications. The general PTZ command is composed of one start command and one stop command. When editing both commands in the edit box of the configuration page, use comma(s) to separate commands. Each comma represents 200 milliseconds. In addition, the VPort has a PTZ driver upload function. Users can also seek help from Moxa to create a new PTZ driver.

Q: How fast will the video encoder check the status of digital inputs?

A: The video encoder will check the input status in less than half a second.

Q: Why can't I access the video encoder when I set up some options in the application?

A: When the video encoder is triggered by events, video and snapshots will take more time to write to memory. If the events occur too often, the system will always be busy storing video and images. We recommend using sequential mode or an external recorder program to record motion pictures if the event is frequent. If you prefer to retrieve images by FTP, the value could be smaller since an FTP server responds more quickly than a web server. Once the system is too busy to configure, use the restore factory default and reset button to save the system.

Q: The image is not clear enough. Is anything broken?

A: The lens can be focused by rotating the outer ring. Rotate it clockwise or counter-clockwise to focus near or far.

B

Settings of Supported PTZ Cameras

Since the COM port settings can be adjusted to other than the default settings, check the correct default settings for the attached camera.

Camera model	Baud rate	Data bits	Stop bit	Parity bit
Pelco D, P Protocol	2400	8	1	None
DynaDome	9600	8	1	None

C

Time Zone Table

The hour offsets for different time zones are shown below. You will need this information when setting the time zone in automatic date/time synchronization. GMT stands for Greenwich Mean Time, which is the global time that all time zones are measured from.

(GMT-12:00)	International Date Line West
(GMT-11:00)	Midway Island, Samoa
(GMT-10:00)	Hawaii
(GMT-09:00)	Alaska
(GMT-08:00)	Pacific Time (US & Canada), Tijuana
(GMT-07:00)	Arizona
(GMT-07:00)	Chihuahua, La Paz, Mazatlan
(GMT-07:00)	Mountain Time (US & Canada)
(GMT-06:00)	Central America
(GMT-06:00)	Central Time (US & Canada)
(GMT-06:00)	Guadalajara, Mexico City, Monterrey
(GMT-06:00)	Saskatchewan
(GMT-05:00)	Bogota, Lima, Quito
(GMT-05:00)	Eastern Time (US & Canada)
(GMT-05:00)	Indiana (East)
(GMT-04:00)	Atlantic Time (Canada)
(GMT-04:00)	Caracas, La Paz
(GMT-04:00)	Santiago
(GMT-03:30)	Newfoundland
(GMT-03:00)	Brasilia
(GMT-03:00)	Buenos Aires, Georgetown
(GMT-03:00)	Greenland
(GMT-02:00)	Mid-Atlantic
(GMT-01:00)	Azores
(GMT-01:00)	Cape Verde Is.
(GMT)	Casablanca, Monrovia
(GMT)	Greenwich Mean Time: Dublin, Edinburgh, Lisbon, London
(GMT+01:00)	Amsterdam, Berlin, Bern, Stockholm, Vienna
(GMT+01:00)	Belgrade, Bratislava, Budapest, Ljubljana, Prague (GMT+01 :00) Brussels, Copenhagen, Madrid, Paris
(GMT+01 :00)	Sarajevo, Skopje, Warsaw, Zagreb
(GMT+01:00)	West Central Africa
(GMT+02:00)	Athens, Istanbul, Minsk
(GMT+02:00)	Bucharest
(GMT+02:00)	Cairo

(GMT+02:00) Harare, Pretoria
(GMT+02:00) Helsinki, Kyiv, Riga, Sofia, Tallinn, Vilnius
(GMT+02:00) Jerusalem
(GMT+03:00) Baghdad
(GMT+03:00) Kuwait, Riyadh
(GMT+03:00) Moscow, St. Petersburg, Volgograd
(GMT+03:00) Nairobi
(GMT+03:30) Tehran
(GMT+04:00) Abu Dhabi, Muscat (GMT+04:00) Baku, Tbilisi, Yerevan (GMT+04:30) Kabul
(GMT+05:00) Ekaterinburg
(GMT+05:00) Islamabad, Karachi, Tashkent (GMT+05:30) Chennai, Kolkata, Mumbai, New Delhi
(GMT+05:45) Kathmandu
(GMT+06:00) Almaty, Novosibirsk (GMT+06:00) Astana, Dhaka
(GMT+06:00) Sri Jayawardenepura (GMT+06:30) Rangoon
(GMT+07:00) Bangkok, Hanoi, Jakarta (GMT+07:00) Krasnoyarsk
(GMT+08:00) Beijing, Chongqing, Hongkong, Urumqi
(GMT+08:00) Taipei
(GMT+08:00) Irkutsk, Ulaan Bataar (GMT+08:00) Kuala Lumpur, Singapore (GMT+08:00) Perth
(GMT+09:00) Osaka, Sapporo, Tokyo (GMT+09:00) Seoul
(GMT+09:00) Yakutsk
(GMT+09:30) Adelaide
(GMT+09:30) Darwin
(GMT+10:00) Brisbane
(GMT+10:00) Canberra, Melbourne, Sydney
(GMT+10:00) Guam, Port Moresby (GMT+10:00) Hobart
(GMT+10:00) Vladivostok
(GMT+11:00) Magadan, Solomon Is., New Caledonia
(GMT+12:00) Auckland, Wellington (GMT+ 12:00) Fiji, Kamchatka, Marshall Is.
(GMT+13:00) Nuku'alofa

D

Technical Specifications

Video

Video Compression	MPEG4, MJPEG
Video Input	1, BNC Connector
NTSC/PAL	Auto-sensing or Manual

Video Resolution and FPS (frames per second):

	NTSC		PAL	
	Size	Max. FPS	Size	Max. FPS
QVGA	320 x 240	30	320 x 288	25
CIF	352 x 240	30	352 x 288	25
VGA	640 x 480	30	640 x 480	25
4CIF*	704 x 480	30	704 x 576	25
Full D1	720 x 480	30	720 x 576	25

Video Viewing

Adjustable image size and quality
Timestamp and text overlay

Audio

Audio Input	1 Line-in or MIC-in, 3.5 mm phone jack
Audio Output	1 Line-out, 3.5 mm phone jack

Network

Protocols:	TCP, UDP, HTTP, SMTP, FTP, Telnet, NTP, DNS, DHCP, UPnP, RTP, RTSP, ICMP, IGMPv3, QoS (ToS), SNMP (V1/V2c/V3), DDNS
Ethernet	1 auto-negotiating 10/100BaseT(X) port with RJ45 connector

Serial Port

PTZ Port	1 RS-232 or RS-422/485 port with terminal block connector; max. speed of 115.2 Kbps
Console port	1 RS-232 port with RJ45 connector

GPIO

Digital Input	1 channel, max. 8 mA “Low”: +13V to +30V “High”: -30V to +3V
---------------	--

Relay Output	1 channel, max. 24 VDC @ 1A
LED Indicators	
STAT	Indicates if the system booted properly
VIDEO	Video input signal active
PTZ	PTZ control signal active
Power	
Inputs	Two 12/ 24 VDC or 24 VAC for redundancy
Output	2-pin terminal block for power output (looped through power input)
Consumption	Max 7.5W
Mechanical	
Housing	Metal case
Dimensions (W x D x H)	88 x 107 x 50 mm (4.33 x 4.21 x 1.96 in.)
Weight	850 g
Installation	DIN-Rail or Wall mounting (with optional DK-35A Kit)
Environmental	
Operating Temperature	0 to 60°C (32 to 140°F)
Storage Temperature	-40 to 85°C (-40 to 185°F)
Ambient Relative Humidity	5 to 95% (non-condensing)
Regulatory Approvals	
EMI	FCC Part 15, CISPR (EN55022) class A
EMS	EN61000-4-2 (ESD), Level 2 EN61000-4-3 (RS), Level 3 EN61000-4-4 (EFT), Level 3 EN61000-4-5 (Surge), Level 3 EN61000-4-6 (CS), Level 3 EN61000-4-12 (Oscillatory wave immunity), Level 3
Shock	IEC60068-2-27
Freefall	IEC60068-2-32
Vibration	IEC60068-2-6
MTBF	160,000 hours
WARRANTY	5 years
Alarm Features	
<ul style="list-style-type: none"> • Video motion detection with sensitivity tuning. • Video loss alarm • Daily repeat timing schedule. • Alarm-triggered JPEG snapshots with pre and post-alarm images 	

- Automatic transfer of stored images via email or FTP with event-triggered actions.
- HTTP action setting for custom alarm messages by HTTP event server.

PTZ (PAN/TILT/ZOOM)

- PTZ camera control through RS-232/422/485
- Supported devices and protocols:
Pelco D, Pelco P, Dynacolor DynaDome, , Custom Camera
- Support PTZ driver upload
- Support Transparent PTZ Control for controlling the PTZ camera via legacy PTZ control panel or keyboard

Security

- User level password protection
- IP address filtering

Recommended System Requirements

- Pentium 4, 2.4 GHz or above
- 512 MB memory or above
- Windows XP/2000 with SP4 or above
- Internet Explorer 6.x or above
- DirectX 9.0c or above

Software Bundled Free

Moxa SoftDVR Lite

1- to 4-ch IP Surveillance Software for viewing & recording
(please check the release information on Moxa's website)