

AWK-1127

Quick Installation Guide

Moxa AirWorks

Edition 2.0, July 2016

Technical Support Contact Information **www.moxa.com/support**

Moxa Americas:

Toll-free: 1-888-669-2872

Tel: 1-714-528-6777

Fax: 1-714-528-6778

Moxa China (Shanghai office):

Toll-free: 800-820-5036

Tel: +86-21-5258-9955

Fax: +86-21-5258-5505

Moxa Europe:

Tel: +49-89-3 70 03 99-0

Fax: +49-89-3 70 03 99-99

Moxa Asia-Pacific:

Tel: +886-2-8919-1230

Fax: +886-2-8919-1231

Moxa India:

Tel: +91-80-4172-9088

Fax: +91-80-4132-1045

MOXA®

© 2016 Moxa Inc. All rights reserved.

P/N: 1802011270012



Overview

Moxa's AWK-1127 WLAN client is ideal for applications that are hard to wire, too expensive to wire, or use mobile equipment that connects over a TCP/IP network. The AWK-1127 is rated to operate at temperatures ranging from 0 to 60°C for standard models and -40 to 75°C for extended temperature models, and is rugged enough for any harsh industrial environment. Installation is easy, with either DIN-rail mounting or distribution boxes. The DIN-rail mounting ability, wide operating temperature range, and IP30 housing with LED indicators make the AWK-1127 a convenient yet reliable solution for any industrial wireless application.

Package Checklist

Moxa's AWK-1127 is shipped with the following items. If any of these items is missing or damaged, please contact your customer service representative for assistance.

- 1 AWK-1127
- 2 dBi dual band antenna
- Console protective cap
- Resistive Terminator
- Document and software CD
- Quick Installation Guide (printed)
- Warranty card

Panel Layout of the AWK-1127

Top Panel View

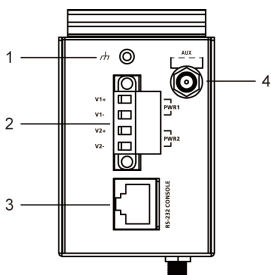

1. Grounding screw (M3)
2. Terminal block for PWR1 and PWR2
3. RS-232 console port
4. AUX antenna port
5. System LEDs: PWR, FAULT, and STATE LEDs
6. LEDs for signal strength
7. WLAN and LAN LEDs
8. 10/100BaseT(X) RJ45 Port
9. MAIN antenna port
10. RS-232/422/485 Serial port
11. Screw hole for wall-mounting kit
12. DIN-rail mounting kit
13. Reset button

Front Panel View

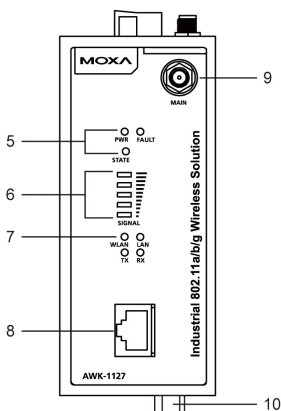

Rear Panel View

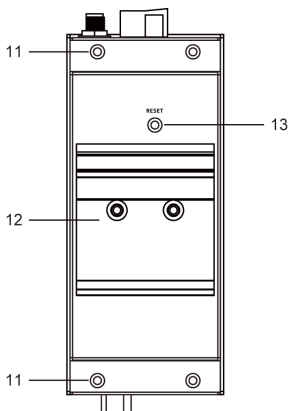

Mounting Dimensions (unit = mm)

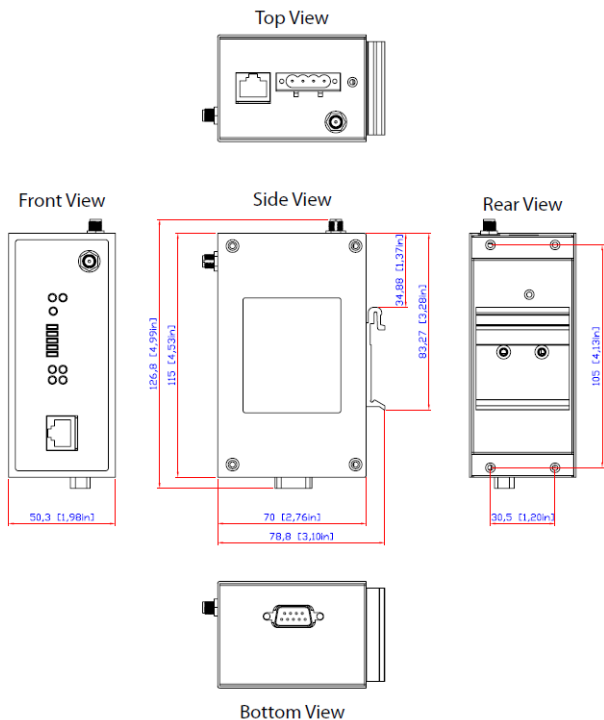

DIN-Rail Mounting

The aluminum DIN-rail attachment plate should be fixed to the back panel of the AWK-1127 when you take it out of the box. If you need to reattach the DIN-rail attachment plate to the AWK-1127, make sure the stiff metal spring is situated towards the top, as shown in the figures below.

STEP 1: Insert the top of the DIN rail into the slot just below the stiff metal spring.

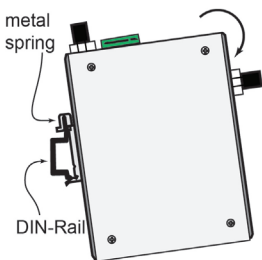

STEP 2: The DIN-rail attachment unit will snap into place as shown below.

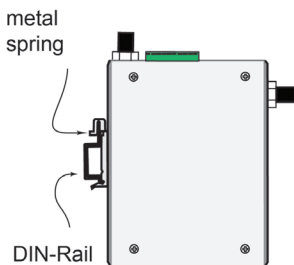

To remove the AWK-1127 from the DIN rail, simply reverse Steps 1 and 2.

Wall Mounting (optional)

For some applications, it may be more convenient to mount the AWK-1127 to a wall, as illustrated below:

STEP 1:

Remove the aluminum DIN-rail attachment plate from the AWK-1127, and then attach the wall mount plates with M3 screws, as shown in the adjacent diagrams.

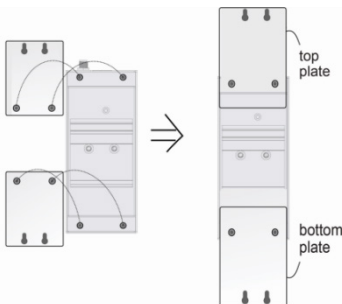

STEP 2:

Mounting the AWK-1127 to a wall requires 4 screws. Use the AWK-1127 device, with wall mount plates attached, as a guide to mark the correct locations of the 4 screws. The heads of the screws should be less than 6.0 mm in diameter, and the shafts should be less than 3.5 mm in diameter, as shown in the figure at the right.

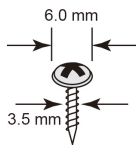

Do not drive the screws in all the way into the wall—leave a space of about 2 mm to allow room for sliding the wall-mount panel between the wall and the screws.

NOTE Test the screw head and shank size by inserting the screws into one of the keyhole shaped apertures of the wall-mounting plates before attaching the plate to the wall.

STEP 3:

Once the screws are fixed into the wall, insert the four screw heads through the large opening of the keyhole-shaped apertures, and then slide the AWK-1127 downwards, as indicated to the right. Tighten the four screws for added stability.

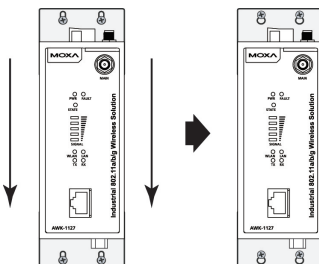

Wiring Requirements



WARNING

Safety First!

Be sure to disconnect the power cord before installing and/or wiring your Moxa AWK-1127.



WARNING

Safety First!

Calculate the maximum possible current in each power wire and common wire. Observe all electrical codes dictating the maximum current allowed for each wire size. If the current goes above the maximum ratings, the wiring could overheat, causing serious damage to your equipment.

You should also pay attention to the following items:

- Use separate paths to route wiring for power and devices. If power wiring and device wiring paths must cross, make sure the wires are perpendicular at the intersection point.

NOTE Do not run signal or communications wiring and power wiring in the same wire conduit. To avoid interference, wires with different signal characteristics should be routed separately. [note content here.](#)

- You can use the type of signal transmitted through a wire to determine which wires should be kept separate. The rule of thumb is that wiring with similar electrical characteristics can be bundled together.
- Keep input wiring and output wiring separate.
- It is strongly advised that you label wiring to all devices in the system when necessary.



ATTENTION

This product is intended to be supplied by a Listed Power Unit marked "Class 2" or "LPS" and rated O/P: 12 to 48 VDC, 0.16 to 0.55 A



ATTENTION

Make sure the external power adaptor (includes power cords and plug assemblies) provided with the unit is certified and suitable for use in your country.

Grounding the Moxa AWK-1127

Grounding and wire routing help limit the effects of noise due to electromagnetic interference (EMI). Run the ground connection from the ground screw to the grounding surface prior to connecting devices.



ATTENTION

This product is intended to be mounted to a well-grounded mounting surface, such as a metal panel.

Installations with Unstable Power Inputs

There are cases where the device has to be wired to the same power source as other equipment. In such cases if equipment such as motors that are connected in the circuit draw a large amount of current during operation, the transient voltage drop could potentially cause the AWK to become unstable. Installing a DC/DC power isolator in between the two equipment is recommended to isolate the transient effect and to ensure a stable power input for the AWK.

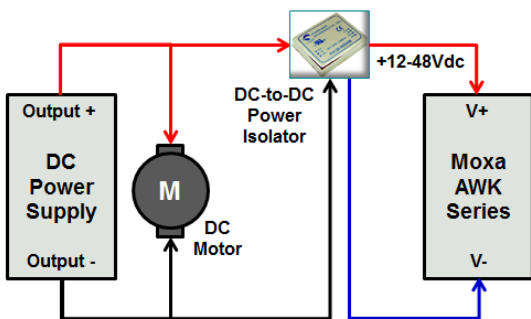

Installations with Cable Extended Antennas for Outdoor Applications

If the antenna or the AWK device is installed outdoors or in an open-air setting, proper lightning protection is required to prevent direct lightning strikes on the AWK device. In order to prevent coupling currents from nearby lightning strikes, a lightning arrester should be installed as part of your antenna system. Ground the device, antenna, as well as the arrester properly to provide maximum outdoor protection for the device.

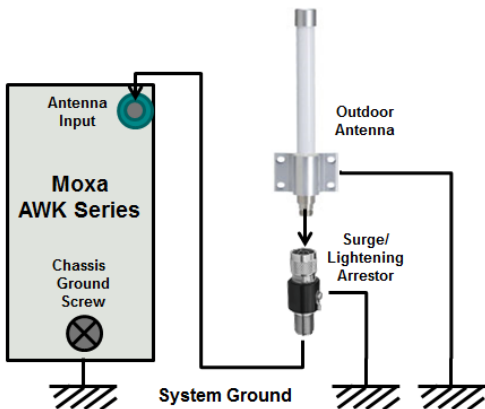

Arrester Accessories

- **SA-NMNF-01:** Surge arrester, N-type (male) to N-type (female)
- **SA-NFNF-01:** Surge arrester, N-type (female) to N-type (female)

Wiring the Redundant Power Inputs

The 4-contact terminal block connector on the AWK-1127's top panel is used for the AWK-1127's two DC inputs. The top and front views of the terminal block connector are shown here.

Top View



Front View

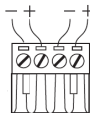

STEP 1: Insert the negative/positive DC wires into the V-/V+ terminals.

STEP 2: To keep the DC wires from pulling loose, use a small flat-blade screwdriver to tighten the wire-clamp screws on the front of the terminal block connector.

STEP 3: Insert the plastic terminal block connector prongs into the terminal block receptor, which is located on the AWK-1127's top panel.



ATTENTION

Before connecting the AWK-1127 to the DC power inputs, make sure the DC power source voltage is stable.

Communication Connections

10/100BaseT(X) Ethernet Port Connection

The 10/100BaseT(X) ports located on the AWK-1127's front panel are used to connect to Ethernet-enabled devices.

Below we show pinouts for both MDI (NIC-type) ports and MDI-X (HUB/Switch-type) ports.

MDI Port Pinouts**MDI-X Port Pinouts****8-pin RJ45**

Pin	Signal	Pin	Signal
1	Tx+	1	Rx+
2	Tx-	2	Rx-
3	Rx+	3	Tx+
6	Rx-	6	Tx-

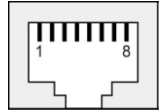
**RS-232/422/485 Serial Port**

The AWK-1127 has 1 RS-232/422/485 serial port with DB9 connector for serial to WLAN connectivity. Below are the pin assignments are the serial port.

Pin	RS-232	RS-422/485 (4W)	RS-485 (2W)
1	DCD	TxD-(A)	-
2	RxD	TxD+(B)	-
3	TxD	RxD+(B)	Data+(B)
4	DTR	RxD-(A)	Data-(A)
5	GND	GND	GND
6	DSR	-	-
7	RTS	-	-
8	CTS	-	-
9	-	-	-

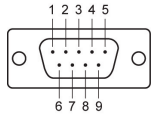
**RS-232 Console Connection**

The AWK-1127 has one RS-232 (8-pin RJ45) console port located on the top panel. Use either an RJ45-to-DB9 or RJ45-to-DB25 cable to connect the Moxa AWK-1127's console port to your PC's COM port. You may then use a console terminal program to access the AWK-1127 for console configuration.

Console Pinouts for 10-pin or 8-pin RJ45

10-Pin	Description	8-Pin
1	-	
2	DSR	1
3	RTS	2
4	GND	3
5	TxD	4
6	RxD	5
7	DCD	6
8	CTS	7
9	DTR	8
10	-	

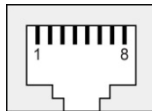

- NOTE**
1. The pin numbers for male DB9 and DB25 connectors, and hole numbers for female DB9 and DB25 connectors are labeled on the connector. However, the numbers are typically quite small, so you may need to use a magnifying glass to see the numbers clearly.
 2. The pin numbers for both 8-pin and 10-pin RJ45 connectors (and ports) are typically not labeled on the connector (or port). Refer to the pinout diagram above for details.

LED Indicators

The front panel of the Moxa AWK-1127 contains several LED indicators. The function of each LED is described in the table below.

LED	Color	State	Description
PWR	Green	On	Power is on.
		Off	Power is not being supplied
FAULT	Red	On	System is booting up
		Blinking (slow at 1-second intervals)	Cannot get an IP address from the DHCP server.
		Blinking (fast at 0.5-second interval)	IP address conflict.
		Off	Status is normal.
STATE	Green/ Red	Green	System startup is complete and the system is in operation.
		Green (Blinking at 1-second intervals)	The device has been located by the Wireless Search Utility.
		Red	System is booting up.
SIGNAL (5 LEDs)	Green	On	Signal level
		Off	Reserved
WLAN	Green	On	WLAN has been established.
		Blinking	WLAN is transmitting data.
		Off	WLAN is not working properly.
LAN	Green	On	100/10 Mbps LAN port is active.
		Blinking	Data is being transmitted.
		Off	100/10 Mbps LAN port is inactive.
TX/RX	Green	On	Serial port is transmitting data.
		Off	No data is being received through the serial port.
	Amber	On	Serial port is receiving data.
		Off	No data is being transmitted through the serial port.

Specifications

WLAN Interface	
Standards	IEEE 802.11a/b/g for Wireless LAN IEEE 802.11i for Wireless Security IEEE 802.3 for 10BaseT IEEE 802.3u for 100BaseT(X) IEEE 802.3af for Power-over-Ethernet (PoE models Only) IEEE 802.1D for Spanning Tree Protocol IEEE 802.1w for Rapid STP

Spread Spectrum and Modulation (typical)	DSSS with DBPSK, DQPSK, CCK OFDM with BPSK, QPSK, 16QAM, 64QAM 802.11b: CCK @ 11/5.5 Mbps, DQPSK @ 2 Mbps DBPSK @ 1 Mbps 802.11a/g: 64QAM @ 54/48 Mbps, 16QAM @ 36/24 Mbps QPSK @ 18/12 Mbps, BPSK @ 9/6 Mbps
Operating Channels (central frequency)	US: 2.412 to 2.462 GHz (11 channels) 5.18 to 5.24 GHz (4 channels) EU: 2.412 to 2.472 GHz (13 channels) 5.18 to 5.24 GHz (4 channels) JP: 2.412 to 2.472 GHz (13 channels, OFDM) 2.412 to 2.484 GHz (14 channels, DSSS) 5.18 to 5.24 GHz (4 channels for W52)
Security	Firewall for MAC/IP/Protocol/Port-based filtering 64-bit and 128-bit WEP encryption, WPA/WPA2-Personal and Enterprise (IEEE 802.1X/RADIUS, TKIP, and AES)
Transmission Rates	802.11b: 1, 2, 5.5, 11 Mbps 802.11a/g: 6, 9, 12, 18, 24, 36, 48, 54 Mbps
TX Transmit Power	802.11b: Typ. 18±1.5 dBm @ 1 to 11 Mbps 802.11g: Typ. 18±1.5 dBm @ 6 to 24 Mbps Typ. 17±1.5 dBm @ 36 Mbps Typ. 16±1.5 dBm @ 48 Mbps Typ. 16±1.5 dBm @ 54 Mbps 802.11a: Typ. 18±1.5 dBm @ 6 to 24 Mbps Typ. 16±1.5 dBm @ 36 Mbps Typ. 15±1.5 dBm @ 48 Mbps Typ. 14±1.5 dBm @ 54 Mbps
RX Sensitivity	802.11b: -97 dBm @ 1 Mbps, -94 dBm @ 2 Mbps -92 dBm @ 5.5 Mbps, -90 dBm @ 11 Mbps 802.11g: -88 dBm @ 6 to 24 Mbps, -85 dBm @ 36 Mbps -75 dBm @ 48 Mbps, -70 dBm @ 54 Mbps 802.11a: -88 dBm @ 6 to 24 Mbps, -85 dBm @ 36 Mbps -75 dBm @ 48 Mbps, -70 dBm @ 54 Mbps
Protocol Support	
General Protocols	Proxy ARP, DNS, HTTP, HTTPS, IP, ICMP, SNMP, TCP, UDP, RADIUS, SNMP, PPPoE, DHCP
Interface	
Default Antennas	1 dual-band omni-directional antennas, 2 dBi, RP-SMA (male)
Connector for External Antennas	RP-SMA (female)
Serial Port	1, RS232/422/485, DB9 male connector

RJ45 Ports	1, 10/100BaseT(X) auto negotiation speed, F/H duplex mode, and auto MDI/MDI-X connection
Console Port	RS-232 (RJ45-type)
Reset	Present
LED Indicators	PWR, FAULT, STATE, SIGNAL, WLAN, LAN, TX, RX
Serial Communication Parameters	
Data Bits	5, 6, 7, 8
Stop Bits	1, 1.5, 2
Parity	None, Even, Odd, Space, Mark
Flow Control	RTS/CTS, XON/XOFF
Baudrate	50 bps to 921.6 kbps
Serial Data Log	256 KB
Serial Signals	
RS-232	DSR, RTS, GND, TxD, RxD, DCD, CTS, DTR
RS-422	Tx+, Tx-, Rx+, Rx-, GND
RS-485 (2-wire)	Data+, Data-, and GND
RS-485 (4-wire)	Tx+, Rx+, Tx-, Rx-, and GND
Physical Characteristics	
Housing	Metal, providing IP30 protection
Weight	400 g (0.9 lb)
Dimensions	50 x 115 x 70 mm(1.98 x 4.53 x 2.76 in)
Installation	DIN-rail mounting, wall mounting (with optional kit)
Environmental Limits	
Operating Temperature	Standard Models: 0 to 60°C (32 to 140°F) Wide Temp. Models: -40 to 75°C (-40 to 167°F)
Storage Temperature	-40 to 85°C (-40 to 185°F)
Ambient Relative Humidity	5% to 95% (non-condensing)
Power Requirements	
Input Voltage	12 to 48 VDC, redundant dual DC power inputs or 48 VDC Power-over-Ethernet (IEEE 802.3af compliant)* *PoE is only available for the AWK-1127-PoE
Connector	4-pin removable terminal block
Power Consumption	12 to 48 VDC, 0.16 to 0.55 A
Reverse Polarity Protection	Present
Standards and Certifications	
Safety	UL 60950-1, EN 60950-1
EMC	EN 301 489-1/17; FCC Part 15, Subpart B; EN 55022/55024
Radio	EN 300 328, EN 301 893, TELEC, FCC ID SLE-WAPN003
Note: Please check Moxa's website for the most up-to-date certification status.	
Reliability	
MTBF	392,209 hrs.
Warranty	
Warranty Period	5 years
Details	See www.moxa.com/support/warranty.aspx



ATTENTION

The AWK-1127 is **NOT** a portable mobile device and should be located at least 20 cm away from the human body. The AWK-1127 is **NOT** designed for the general public. A well-trained technician is required to deploy the AWK-1127 units and safely establish a wireless network.



ATTENTION

This device complies with Part 15 of the FCC rules. Operation is subject to the following conditions:

1. This device may not cause harmful interference.
2. This device must accept any interference received, including interference that may cause undesired operation.



ATTENTION

Do not locate the antenna near overhead power lines or other electric light or power circuits, or where it can come into contact with such circuits. When installing the antenna, take extreme care not to come into contact with such circuits, because they may cause serious injury or death. For proper installation and grounding of the antenna, refer to national and local codes (for example, U.S.: NFPA 70; National Electrical Code, Article 810; Canada: Canadian Electrical Code, Section 54).

NOTE For installation flexibility, either the MAIN antenna (on the front panel) or the AUX antenna (on the top panel) may be selected for use. Make sure the antenna connection matches the antenna configured in the AWK-1127 web interface.

To protect the connectors and RF module, all radio ports should be terminated by either an antenna or a terminator. We strongly recommend using resistive terminators for terminating the unused antenna ports.

NOTE



201WW 11215498
201GZ 11215499
201XW 11215500
201YW 11215501

5GHz帯の使用は屋内に限る