

AWK-4121

Quick Installation Guide

Moxa AirWorks

Edition 7.0, February 2017

Technical Support Contact Information

www.moxa.com/support

Moxa Americas:

Toll-free: 1-888-669-2872

Tel: 1-714-528-6777

Fax: 1-714-528-6778

Moxa China (Shanghai office):

Toll-free: 800-820-5036

Tel: +86-21-5258-9955

Fax: +86-21-5258-5505

Moxa Europe:

Tel: +49-89-3 70 03 99-0

Fax: +49-89-3 70 03 99-99

Moxa Asia-Pacific:

Tel: +886-2-8919-1230

Fax: +886-2-8919-1231

Moxa India:

Tel: +91-80-4172-9088

Fax: +91-80-4132-1045

MOXA®

© 2017 Moxa Inc. All rights reserved.

P/N: 1802041210016



Overview

The AWK-4121 outdoor wireless Access Point is an ideal solution for industrial applications that are hard to wire, too expensive to wire, or use mobile equipment that connect to a TCP/IP network. The AWK-4121 is rated to operate at temperatures ranging from -40 to 75°C, and its dust-tight and weatherproof design is IP68-rated. An IP68 rating means the device is completely protected from dust and is protected against the effects of immersion in water between 15cm and 1m in depth. This means you can set up a WLAN or extend existing wired networks to outdoor locations and still maintain a reliable connection. The AWK-4121 has two redundant DC power inputs for increased reliability, can be powered via PoE (discontinued starting with HW Rev 2.0.0), and is easy to deploy.

Package Checklist

Moxa's AWK-4121 is shipped with the following items. If any of these items is missing or damaged, please contact your customer service representative for assistance.

- 1 AWK-4121 wireless AP/bridge/client
- 2 omni-directional antennas (5/2 dBi, N-type male, 2.4/5 GHz)
- Wall mounting kit (includes 2 supports)
- Field-installable power plug
- Field-installable RJ45 plug
- Metal cap to cover RJ45 connector
- Metal cap to cover M12-female connector
- Transparent plastic sticks for field-installable plugs
- Quick installation guide (printed)
- Warranty card

NOTE The above items come with the AWK-4121 standard version. The package contents for customized versions may be different.

Panel Layout of the AWK-4121

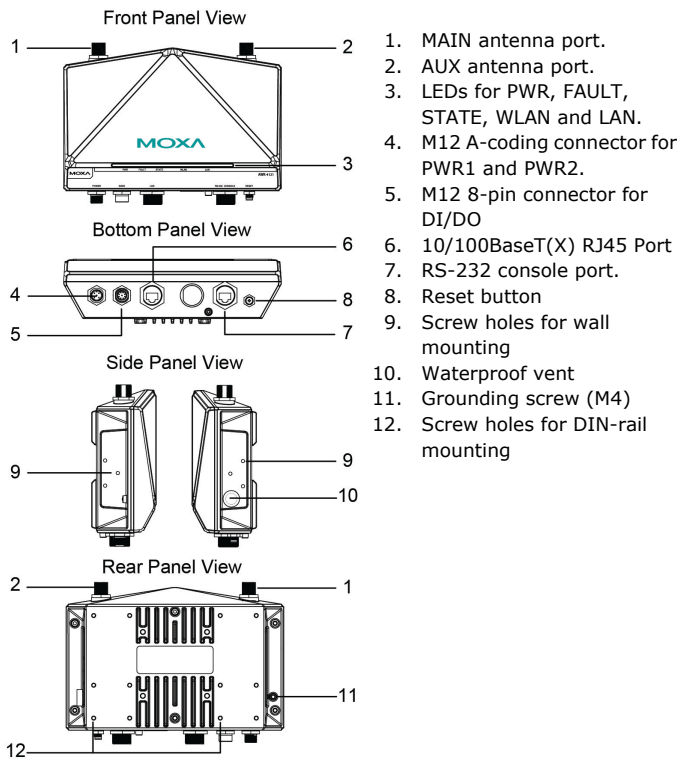

ATTENTION

Please DO NOT open or remove the vent **10**. The warranty will be invalid if the seal is removed.

All exposed connectors, including **1, 2, 4 - 8**, should be tightly covered by suitable caps when they are not in use.

Dimensions (unit = mm (inch))

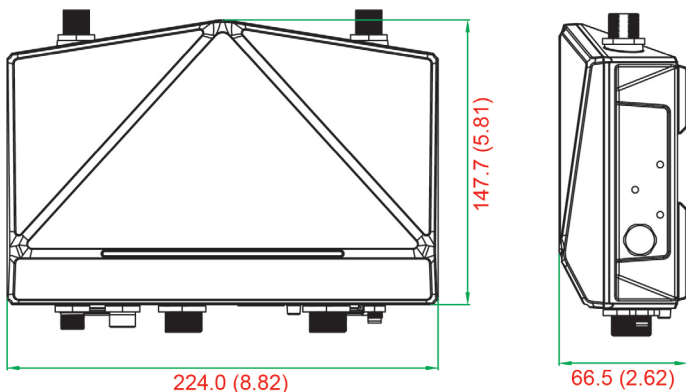

Attaching Antennas

The AWK-4121 includes two dual-band omni-directional antenna by default. Attach the antennas as illustrated below.

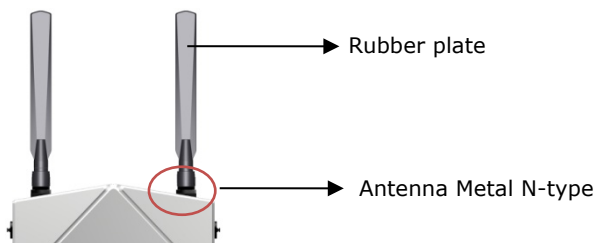

Step 1: Use your fingers and hold the antenna metal N-type connector.

Step 2: Screw the antenna N-type connector (male) onto the AWK-4121 device's N-type connector (female)



Caution

Do not hold the rubber plate to screw the antenna on to the AWK-4121 device.



ATTENTION

Use the antennas correctly: Use 2.4 GHz antennas if the AWK-4121 operates in IEEE 802.11b/g. Use the 5 GHz antennas for operations in IEEE802.11a. Make sure your antenna installation is within a safe area covered by a lightning protection or surge arrest system.

Wall Mounting

In most applications, wall mount provides an easier installation. You will find it quite easy to mount AWK-4121 on the wall, as illustrated below.

STEP 1:

Attach the wall-mounting kit with M4 screws, as shown in the diagram below.

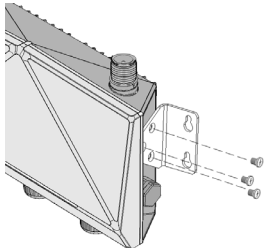

STEP 2:

Mounting the AWK-4121 on the wall requires 4 screws. Use the AWK-4121 device, with wall-mounting kit attached, as a guide to mark the correct locations of the 4 screws. The heads of the screws are recommended to be between 5.5mm and 8.5 mm in diameter, and the shafts should not be more than 5.0 mm in diameter, as shown in the figure.

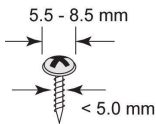

Do not screw the screws all the way in to the wall—leave a space of about 2 mm to allow room for sliding the wall-mounting kit between the wall and the screws.



ATTENTION

You can test the screw head and shank size by inserting the screw into one of the keyhole shaped apertures of the wall mounting plates before it is screwed into the wall.

STEP 3:

Once the screws are fixed into the wall, insert the four screw heads through the large opening of the keyhole-shaped apertures, and then slide the AWK-4121 downwards, as indicated to the right. Tighten the four screws for added stability.

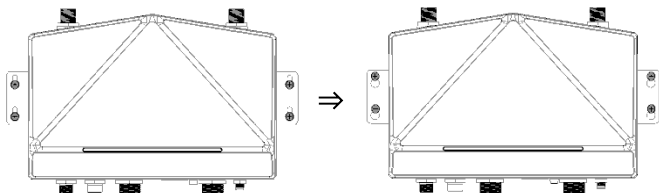

ATTENTION

To avoid environmental vibration or shock, you can consider a robust installation with four bigger screws, which the shafts are between 7.0 mm and 8.5 mm in diameter, and fix the AWK-4121 onto wall directly and tightly.

DIN-Rail Mounting (Optional)

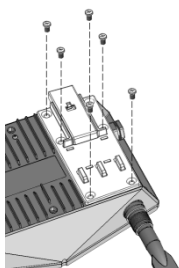

The DK-DC50131 die-cast metal kit can be bought separately, and enable easy and robust installation for the AWK-4121. A pair of DK-DC50131s is needed for DIN-rail mounting. To install the DIN-rail mounting kits, tightly attach the two DIN-rail mounting kits on the rear panel of AWK-4121 with 12 screws. (6 screws for each kit)

To Install

STEP 1:

Use the recessed button on the spring-loaded bracket to lock it into position.

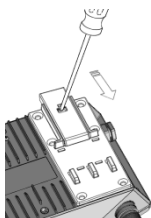

STEP 2:

Insert the top of the DIN rail into the slot just below the upper hook of the DIN-rail mounting kit. Push the AWK-4121 toward the DIN rail until the DIN-rail attachment bracket snaps into place.

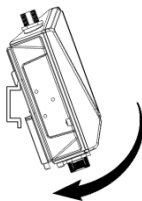

To Release

STEP 1:

Pull out the two spring-loaded brackets from the bottom until they are fixed in the "release" position.

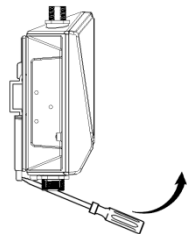

STEP 2:

Pull the AWK-4121 out and upward.

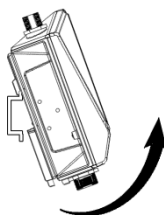

Wiring Requirements



WARNING

Safety First!

Be sure to disconnect the power cord before installing and/or wiring your Moxa AWK-4121.

Calculate the maximum possible current in each power wire and common wire. Observe all electrical codes dictating the maximum current allowable for each wire size. If the current goes above the maximum ratings, the wiring could overheat, causing serious damage to your equipment.

You should also pay attention to the following items:

- Use separate paths to route wiring for power and devices. If power wiring and device wiring paths must cross, make sure the wires are perpendicular at the intersection point.
NOTE: Do not run signal or communications wiring and power wiring in the same wire conduit. To avoid interference, wires with different signal characteristics should be routed separately.
- You can use the type of signal transmitted through a wire to determine which wires should be kept separate. The rule of thumb is that wiring with similar electrical characteristics can be bundled together.
- Keep input wiring and output wiring separate.
- It is strongly advised that you label wiring to all devices in the system when necessary.

Grounding Moxa AWK-4121

Grounding and wire routing help limit the effects of noise due to electromagnetic interference (EMI). Run the ground connection from the ground screw to the grounding surface prior to connecting devices.



ATTENTION

This product is intended to be mounted to a well-grounded mounting surface, such as a metal panel. There must be no potential difference between two ground potentials, otherwise there is a risk that the device could be destroyed.

Installations with Unstable Power Inputs

There are cases where the device has to be wired to the same power source as other equipment. In such cases if equipment such as motors that are connected in the circuit draw a large amount of current during operation, the transient voltage drop could potentially cause the AWK to become unstable. Installing a DC/DC power isolator in between the two equipment is recommended to isolate the transient effect and to ensure a stable power input for the AWK.

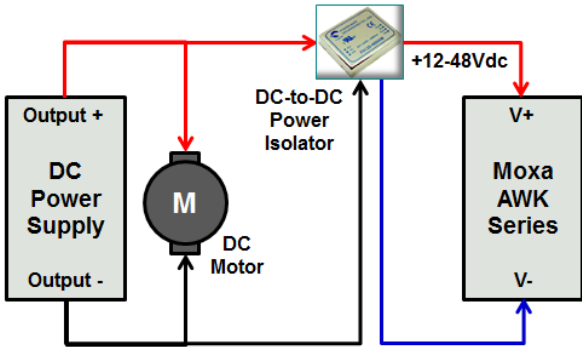

Installations with Cable Extended Antennas for Outdoor Applications

If the antenna or the AWK device is installed outdoors or in an open-air setting, proper lightning protection is required to prevent direct lightning strikes on the AWK device. In order to prevent coupling currents from nearby lightning strikes, a lightning arrester should be installed as part of your antenna system. Ground the device, antenna, as well as the arrester properly to provide maximum outdoor protection for the device.

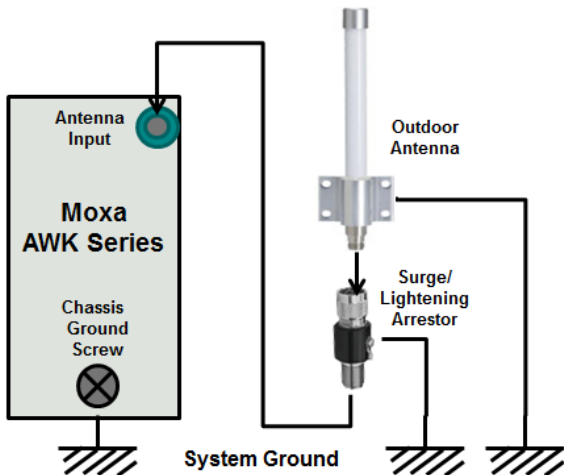

Arrester Accessories

- **SA-NMNF-01:** Surge arrester, N-type (male) to N-type (female)
- **SA-NFNF-01:** Surge arrester, N-type (female) to N-type (female)

Wiring the Redundant Power Inputs

The AWK-4121 must be connected to a power-over-Ethernet (PoE discontinued starting with HW Rev 2.0.0) IEEE 802.3af compliant power source or an IEC60950 compliant limited power source. When AWK-4121 is powered via DC power, the M12 A-coding connector on the bottom panel is used for the AWK-4121's two redundant inputs. The pin assignment is shown below:

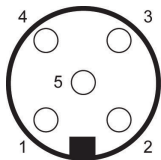

Pin	Power Input
1	V1+
2	V2+
3	V1-
4	V2-
5	GND



ATTENTION

This product is intended to be supplied by a Listed Power Unit marked "Class 2" or "LPS" and rated O/P: 12 to 48 VDC, minimum 6 W (12 V/0.494 A to 48 V/0.121 A, 25°C).

Make sure External Power Adapter (includes power cords and plug assemblies) provided with the unit is certified and suitable for use in your country.

Before connecting the AWK-4121 to the DC power inputs, make sure the DC power source voltage is stable.

Wiring the Digital Inputs and Relay Contact

(Digital Output)

The AWK-4121 has two sets of digital input—DI1 and DI2. Each DI comprises two contacts of the 8-pin M12 connector on the AWK-4121's bottom panel. These two digital inputs can be connected to digital-output-enabled sensors for on-site status monitoring.

The AWK-4121 also has one relay output, which consists of the two contacts. These relay contacts are used to detect user-configured events. The two wires attached to the Relay contacts form an open circuit when a user-configured event is triggered. If a user-configured event does not occur, the Relay circuit will be closed.

A field-installable plug, **M12A-8PMM-IP68**, is recommended for connecting the AWK-4121's DIs and relay.

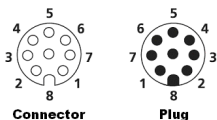
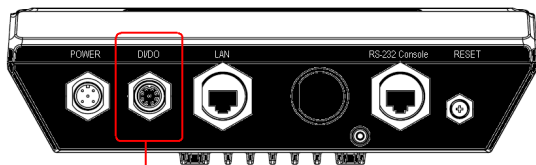

Pin	Signal
1	Relay
2	
3	DI1 I1
4	DI1 COM_1
5	DI2 I2
6	DI2 COM_2
7	Reserved
8	

Communication Connections

10/100BaseT(X) Ethernet Port Connection

The 10/100BaseT(X) ports located on the AWK-4121's bottom panel are used to connect to Ethernet-enabled devices.

Below we show pinouts for both MDI (NIC-type) ports and MDI-X (HUB/Switch-type) ports.

MDI Port Pinouts		MDI-X Port Pinouts		8-pin RJ45
Pin	Signal	Pin	Signal	
1	Tx+	1	Rx+	
2	Tx-	2	Rx-	
3	Rx+	3	Tx+	
6	Rx-	6	Tx-	

RS-232 Connection

The AWK-4121 has one RS-232 (8-pin RJ45) console port located on the bottom panel. Use either an RJ45-to-DB9 or RJ45-to-DB25 cable to connect the Moxa AWK-4121's console port to your PC's COM port. You may then use a console terminal program to access the AWK-4121 for console configuration.

Console Pinouts for 10-pin or 8-pin RJ45

10-Pin	Description	8-Pin
1	-	
2	DSR	1
3	RTS	2
4	GND	3
5	TxD	4
6	RxD	5
7	DCD	6
8	CTS	7
9	DTR	8
10	-	

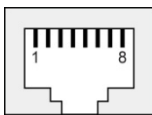

- NOTE**
1. The pin numbers for male DB9 and DB25 connectors, and hole numbers for female DB9 and DB25 connectors are labeled on the connector. However, the numbers are typically quite small, so you may need to use a magnifying glass to see the numbers clearly.
 2. The pin numbers for both 8-pin and 10-pin RJ45 connectors (and ports) are typically not labeled on the connector (or port). Refer to the Pinout diagram above to see how RJ45 pins are numbered.



ATTENTION

To ensure the IP68-rated connectivity, you must use a waterproof housing during any communication activities. An IP68-rated field installable plug, which is attached in AWK-4121's accessory pack, may be needed in this case. The installation guide is shown below:

Waterproof RJ45 Plug

Dimensions (unit: mm)

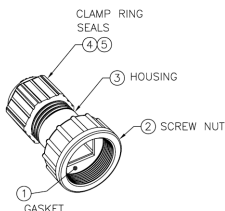
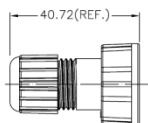
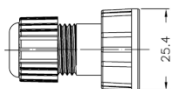

Installation

STEP 1:

Attach the gasket ① to the housing ③

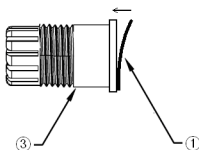

STEP 2:

Insert the cable (ex. CAT5e) through the clamp ring ④, screw nut ②, seal ⑤ and housing ③, as follows:

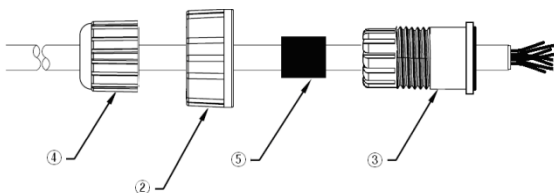

STEP 3:

Crimp the modular RJ plug to the cable; (**NOTE:** the snagless cover shield and strain-relief boot are not recommended.) Then, assemble the seals and the housing (③ and ⑤).

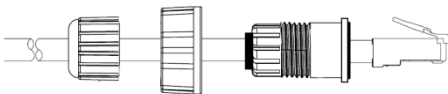

STEP 4:

Tightly screw the clamp ring ④ to the housing and check to make sure that the plug is securely fastened.

(**NOTE:** for a tighter connection, you can connect the RJ-45 plug to the AWK-4121 before STEP 4.)

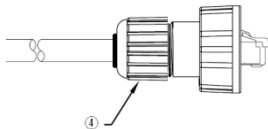

LED Indicators

The front panel of the Moxa AWK-4121 contains several LED indicators. The function of each LED is described in the table below.

LED	Color	State	Description
PWR	Green	On	Power is being supplied (from power input 1 or 2, or PoE*). *Discontinued starting with HW Rev 2.0.0
		Off	Power is not being supplied
FAULT	Red	Blinking (slow at 1-second intervals)	Cannot get an IP address from the DHCP server
		Blinking (fast at 0.5-second intervals)	IP address conflict
		Off	Error condition does not exist.
STATE	Green	On	System startup is complete and the system is in operation.
		Blinking (fast at 0.5-second intervals)	AeroLink Protection is enabled and is currently in "Backup" state.
		Blinking (slow at 1-second intervals)	Device has been located by Wireless Utility
	Red	On	System is booting up
WLAN	Green	On	WLAN function is in Client/Slave mode.
		Blinking	WLAN's data communication is run in Client/Slave mode
		Off	WLAN is not in use or not working properly
	Amber	On	WLAN function is in AP/Bridge mode.
		Blink	WLAN's data communication is run in AP/Master mode
	Off	WLAN is not in use or not working properly.	

LED	Color	State	Description
LAN	Green	On	LAN port's 100 Mbps link is active .
		Blinking	Data is being transmitted at 1000 Mbps
		Off	LAN port's 100 Mbps link is inactive .
	Amber	On	LAN port's 10 Mbps link is active .
		Blinking	Data is being transmitted at 10/100 Mbps
		Off	LAN port's 10 Mbps link is inactive .

Specifications

WLAN Interface	
Standards	IEEE 802.11a/b/g/n for Wireless LAN IEEE 802.11i for Wireless Security IEEE 802.3 for 10BaseT IEEE 802.3u for 100BaseTX IEEE 802.3ab for 1000BaseT IEEE 802.3af for Power-over-Ethernet* IEEE 802.1D for Spanning Tree Protocol IEEE 802.1w for Rapid STP IEEE 802.1Q VLAN *Support for PoE discontinued starting with HW Rev 2.0.0
Spread Spectrum and Modulation (typical)	DSSS with DBPSK, DQPSK, CCK OFDM with BPSK, QPSK, 16QAM, 64QAM 802.11b: <ul style="list-style-type: none"> • CCK @ 11/5.5 Mbps • DQPSK @ 2 Mbps • DBPSK @ 1 Mbps 802.11a/g: <ul style="list-style-type: none"> • 64QAM @ 54/48 Mbps • 16QAM @ 36/24 Mbps • QPSK @ 18/12 Mbps • BPSK @ 9/6 Mbps 802.11n: <ul style="list-style-type: none"> • 64QAM @ 300 bps to BPSK @ 6.5 Mbps (multiple rates supported)
Operating Channels (central frequency)	US: <ul style="list-style-type: none"> • 2.412 to 2.462 GHz (11 channels) • 5.18 to 5.24 GHz (4 channels) EU: <ul style="list-style-type: none"> • 2.412 to 2.472 GHz (13 channels) • 5.18 to 5.24 GHz (4 channels) JP: <ul style="list-style-type: none"> • 2.412 to 2.484 GHz (14 channels, channel 14 only supports DSSS) • 5.18 to 5.24 GHz (4 channels for W52)
Security	SSID broadcast enable/disable Firewall for MAC/IP/Protocol/Port-based filtering 64-bit and 128-bit WEP encryption, WPA/WPA2-Personal and Enterprise (IEEE 802.1X/RADIUS、TKIP and AES)
Transmission Rates	802.11b: 1, 2, 5.5, 11 Mbps 802.11a/g: 6, 9, 12, 18, 24, 36, 48, 54 Mbps

TX Transmit Power	<p>802.11b: Typ. 23±1.5 dBm @ 1 to 11 Mbps</p> <p>802.11g:</p> <ul style="list-style-type: none"> • Typ. 20±1.5 dBm @ 6 to 24 Mbps • Typ. 19±1.5 dBm @ 36 Mbps • Typ. 18±1.5 dBm @ 48 Mbps • Typ. 17±1.5 dBm @ 54 Mbps <p>802.11a:</p> <ul style="list-style-type: none"> • Typ. 18±1.5 dBm @ 6 to 24 Mbps • Typ. 16±1.5 dBm @ 36 to 48 Mbps • Typ. 15±1.5 dBm @ 54 Mbps
RX Sensitivity	<p>802.11b:</p> <ul style="list-style-type: none"> • -97 dBm @ 1 Mbps • -94 dBm @ 2 Mbps • -92 dBm @ 5.5 Mbps • -90 dBm @ 11 Mbps <p>802.11g:</p> <ul style="list-style-type: none"> • -93 dBm @ 6 Mbps • -91 dBm @ 9 Mbps • -90 dBm @ 12 Mbps • -88 dBm @ 18 Mbps • -84 dBm @ 24 Mbps • -80 dBm @ 36 Mbps • -76 dBm @ 48 Mbps • -74 dBm @ 54 Mbps <p>802.11a:</p> <ul style="list-style-type: none"> • -90 dBm @ 6 Mbps • -89 dBm @ 9 Mbps • -89 dBm @ 12 Mbps • -85 dBm @ 18 Mbps • -83 dBm @ 24 Mbps • -79 dBm @ 36 Mbps • -75 dBm @ 48 Mbps • -74 dBm @ 54 Mbps
Protocol Support	
General Protocols	Proxy ARP, DNS, HTTP, HTTPS, IP, ICMP, SNMP, TCP, UDP, RADIUS, SNMP, PPPoE, DHCP,LLDP
AP-only Protocols	ARP, BOOTP, DHCP, dynamic VLAN-Tags for 802.1X-Clients, STP/RSTP (IEEE 802.1D/w)
Interface	
Default Antennas	2 dual-band omni-directional antennas, 5 dBi at 2.4 GHz, 2 dBi at 5 GHz, N-type (male)
Connector for External Antennas	N-type (female)
RJ45 Ports	1, 10/100BaseT(X), auto negotiation speed
Console Port	RS-232 (waterproof RJ45-type)
Reset	Present
LED Indicators	PWR, FAULT, STATE, WLAN, LAN
Alarm Contact	1 relay output with current carrying capacity of 1 A @ 24 VDC, M12 male type
Digital Inputs	2 electrically isolated inputs , M12 male type +13 to +30 V for state "1" +3 to -30 V for state "0" Max. input current: 8 mA

Physical Characteristics	
Housing	Metal, providing IP68 protection
Weight	1.5 kg
Dimensions	224 x 147.7 x 66.5 mm (8.82 x 5.81 x 2.62 in)
Installation	Wall mounting (standard), DIN-rail mounting (optional), pole mounting (optional)
Environmental Limits	
Operating Temperature	-40 to 75°C (-40 to 167°F)
Storage Temperature	-40 to 85°C (-40 to 185°F)
Ambient Relative Humidity	5% to 100% (non-condensing)
Power Requirements	
Input Voltage	12 to 48 VDC, redundant dual DC power inputs or 48 VDC Power-over-Ethernet* (IEEE 802.3af compliant) *Discontinued starting with HW Rev 2.0.0
Connector	M12 connector with A-coding
Power Consumption	6 W (12 V/0.494 A to 48V/0.121 A, 25°C)
Reverse Polarity Protection	Present
Standards and Certifications	
Safety	UL 60950-1, EN 60950-1
EMC	EN 301 489-1/17; FCC Part 15, Subpart B; EN 55022/55024
Radio	EN 300 328, EN 301 893, TELEC
Note: Check Moxa's website for the most up-to-date certification status.	
Reliability	
MTBF	364,564 hrs
Warranty	
Warranty Period	5 years
Details	See www.moxa.com/support/warranty.aspx



ATTENTION

The AWK-4121 is NOT a portable mobile device and should be located 20cm away from the human body.
The AWK-4121 is NOT designed for the general public. To deploy AWK-4121s and establish a wireless network safely, a well-trained technician is required for installation.



ATTENTION

This device complies with part 15 of the FCC Rules. Operation is subject to the following two conditions:
1. This device may not cause harmful interference, and
2. This device must accept any interference received, including interference that may cause undesired operation.



ATTENTION

Do not locate the antenna near overhead power lines or other electric light or power circuits, or where it can come into contact with such circuits. When installing the antenna. Take extreme care not to come into contact with such circuits, because they may cause serious injury or death. For proper installation and grounding of the antenna, please refer to national and local codes (for example, US:NFPA 70, National Electrical Code, Article 810, Canada: Canadian Electrical Code, Section 54).

NOTE For installation flexibility, either the MAIN antenna or the AUX antenna may be selected for use. Make sure the antenna connection matches the antenna configured in the AWK-4121 interface.

To protect the connectors and RF module, all radio ports should be terminated by either an antenna or a terminator. The use of the resistive terminator for terminating the unused antenna port is strongly recommended.



ATTENTION

To ensure the IP68-rated connectivity, you must use a waterproof housing during any communication activities. An IP68-rated field installable plug, which is attached in AWK- 4000 and AWK-6000 series' accessory pack, may be needed in this case. Please reference product's installation guide.