

# ONCell™ G2100 Series User's Manual

---

Fourth Edition, November 2007

[www.moxa.com/product](http://www.moxa.com/product)



Moxa Technologies Co., Ltd.

Tel: +886-2-8919-1230

Fax: +886-2-8919-1231

Web: [www.moxa.com](http://www.moxa.com)

**Moxa Technical Support**

Worldwide: [support@moxa.com](mailto:support@moxa.com)

The Americas: [support@usa.moxa.com](mailto:support@usa.moxa.com)

# OnCell G2100 Series User's Manual

The software described in this manual is furnished under a license agreement and may be used only in accordance with the terms of that agreement.

## Copyright Notice

Copyright © 2007 Moxa Technologies Co., Ltd.  
All rights reserved.  
Reproduction without permission is prohibited.

## Trademarks

Moxa is a registered trademark of The Moxa Group.  
All other trademarks or registered marks in this manual belong to their respective manufacturers.

## Disclaimer

Information in this document is subject to change without notice and does not represent a commitment on the part of Moxa.

Moxa provides this document "as is," without warranty of any kind, either expressed or implied, including, but not limited to, its particular purpose. Moxa reserves the right to make improvements and/or changes to this manual, or to the products and/or the programs described in this manual, at any time.

Information provided in this manual is intended to be accurate and reliable. However, Moxa assumes no responsibility for its use, or for any infringements on the rights of third parties that may result from its use.

This product might include unintentional technical or typographical errors. Changes are periodically made to the information herein to correct such errors, and these changes are incorporated into new editions of the publication.

# Table of Contents

<b>Chapter 1</b>	<b>Introduction .....</b>	<b>1-1</b>
	Overview.....	1-2
	Package Checklist.....	1-2
	Features.....	1-2
	Specifications.....	1-3
	Pin Assignments.....	1-5
<b>Chapter 2</b>	<b>Getting Started .....</b>	<b>2-1</b>
	Product Characteristics .....	2-2
	Dimensions .....	2-2
	OnCell G2150I .....	2-2
	OnCell G2110, G2110-T .....	2-3
	Connecting the Hardware .....	2-4
	Wiring Requirements.....	2-4
	SIM Card Installation .....	2-5
	DIN-Rail Mounting .....	2-5
	Wall Mounting.....	2-8
	Connecting the Antenna .....	2-9
	Connecting Power.....	2-9
	Connecting a Serial Device .....	2-10
	LED Indicators .....	2-11
<b>Chapter 3</b>	<b>OnCell Configurator .....</b>	<b>3-1</b>
	Overview.....	3-2
	Installing OnCell Configurator .....	3-3
	Launching OnCell Configurator .....	3-8
	Configuring Serial Connection and Device Name .....	3-10
	Configuring the PIN Setting .....	3-13
	Configuring the Radio Band .....	3-15
	Initial Strings.....	3-17
	Saving the Configuration Profile .....	3-18
	Applying Modem Settings .....	3-20
	Retrieving the Modem Settings.....	3-23
	Loading a Profile .....	3-26
	Signal Strength Monitor.....	3-30
	Upgrading the Firmware.....	3-32
	Setting Modem Defaults .....	3-36
<b>Chapter 4</b>	<b>AT Command Set .....</b>	<b>4-1</b>
	AT Command Set Introduction .....	4-2
	Starting Moxa Terminal Emulator.....	4-3
	AT Command Examples .....	4-5
	Modem Acknowledgement.....	4-5
	Verify Signal Strength.....	4-5
	Radio Band Selection.....	4-6
	PIN Code Management.....	4-7
	Query the Current PIN Status .....	4-7
	Disable the Facility Lock.....	4-8
	Serial Line Settings.....	4-10
	Modifying Baudrate.....	4-10
	Modifying Data Bits and Parity .....	4-11

	Flow Control.....	4-13
	2-wire RS-485 Communication (OnCell G2150I Only).....	4-13
	Additional Information .....	4-14
<b>Chapter 5</b>	<b>GSM/CSD Connection.....</b>	<b>5-1</b>
	Overview.....	5-2
	Initiating a CSD Connection.....	5-2
	Answering a CSD Connection.....	5-4
<b>Chapter 6</b>	<b>Using Short Message Services.....</b>	<b>6-1</b>
	Sending Short Messages.....	6-2
	Reading Short Messages.....	6-2
	Deleting Short Messages.....	6-3
	SMS Tunnel Mode.....	6-4
<b>Chapter 7</b>	<b>GPRS Connection .....</b>	<b>7-1</b>
	GPRS Overview.....	7-2
	Windows GPRS Access .....	7-2
	Installing Modem Driver .....	7-3
	Modem Diagnostics.....	7-8
	Setting up the APN.....	7-10
	Adding Windows DUN Entry .....	7-12
<b>Appendix A</b>	<b>GPRS with UC-7110, UC-7112.....</b>	<b>A-1</b>
<b>Appendix B</b>	<b>Federal Communication Commission Interference Statement.....</b>	<b>B-1</b>

# 1

## Introduction

---

The OnCell G2100 Series of industrial GSM/GPRS modems provide an easy way to connect your remote RS-232, or RS-422/485 serial devices to GSM and GPRS mobile networks.

The following topics are covered in this chapter:

- Overview**
- Package Checklist**
- Features**
- Specifications**
- Pin Assignments**

## Overview

The OnCell G2100 Series modem is a quad-band GSM/GPRS modem that transmits data and short messages (SMS) over GSM/GPRS mobile networks. The modem can be used to improve the efficiency of your maintenance and communication, and does not require a high level of technical knowledge to operate. All models provide standard RS-232 communication and 15 KV ESD serial line protection, ideal for attaching devices such as stand-alone controllers, PC COM ports, and multi-drop electric meters. The enclosure is IP30-rated and can be mounted on a DIN-rail or on the wall. 12 to 48 VDC power input is supported to connect different types of field power sources. Status information is clearly provided through several LED indicators, including signal strength and mode of communication.

The OnCell G2100 Series includes the following models:

- OnCell G2110 industrial GSM/GPRS modem, RS-232
- OnCell G2110-T industrial GSM/GPRS modem, RS-232, wide operating temperature
- OnCell G2150I industrial GSM/GPRS modem, RS-232 and RS-422/485, 2.5 KV RMS isolation protection

## Package Checklist

### Product

- OnCell G2100 Series industrial GSM/GPRS modem

### Standard Accessories

- Document & Software CD
- 0 dBi magnetic mount SMA antenna
- Terminal block adaptor for power jack connector.
- Warranty statement
- Quick Installation Guide

NOTE: *Please notify your sales representative if any of the above items are missing or damaged.*

### Optional Accessories

- Power adaptor
- ANT-CQB-O-1: High-gain antenna, omni-directional, 1 dBi, SMA, rubber
- ANT-CQB-O-3-3m: High-gain antenna, 3 meters, 3 dBi/25 cm, magnetic mount, SMA
- ANT-CQB-O-5-3m: High-gain antenna, 3 meters, 5 dBi/37 cm, magnetic mount, SMA
- CBL-F9M9-150: Serial cable, 100 cm, DB9 (female) to DB9 (male), RS-232
- CBL-F9M9-20: Serial cable, 20 cm, DB9 (female) to DB9 (male), RS-232
- UPort 1110: USB-to-serial adaptor, RS-232

## Features

- Quad-band GSM/GPRS supporting 900/1800 MHz, 850/1900 MHz
- GPRS Class 10 supporting up to 14,400 bps in GSM CSD mode
- SMS (short message) support
- SMS Tunnel mode
- 15 KV ESD serial line protection
- LED indicators for signal status and level
- IP30 enclosure supporting DIN-rail and wall mounting

- Separate RS-422/485 interface (OnCell G2150I only)
- 2.5 KV RMS for 1 minute isolation for all serial signals (OnCell G2150I only)

## Specifications

### Cellular Communication

Standard Compliance	GSM (Global Service for Mobile) and GPRS (General Packet Radio Service)
Radio Band Selection	Quad-band 850 MHz, 900 MHz, 1800 MHz, and 1900 MHz
Tx Power	1-Watt GSM1800/1900, 2-Watt EGSM 900/ GSM 850
GPRS Multi-slot Class	Class 10, CS1 to CS4 coding schemes
GPRS Terminal Device Class	Class B (simultaneous GPRS/CSD connections not supported)
CSD Data Transmission Rate	Up to 14,400 bps
SMS	Point-to-point Text/PDU: Mobile Originated (MO) and Mobile Terminated (MT Cell Broadcast: in accordance with GSM 07.05)
SIM Control	3V/1.8V interface
Antenna Connector	SMA
Antenna	0 dBi/10 cm, magnetic mount, SMA, 3 meters

	GSM 850	EGSM 900
<b>Frequency RX</b>	869 to 894 MHz	925 to 960 MHz
<b>Frequency TX</b>	824 to 849 MHz	880 to 915 MHz
<b>RF Power Stand</b>	2W at 12.5% duty cycle	2W at 12.5% duty cycle
<b>Impedance</b>	50 $\Omega$	
<b>VSWR</b>	< 2	
<b>Typical Radiated Gain</b>	0 dBi on azimuth plane	

	GSM 1800	GSM 1900
<b>Frequency RX</b>	1805 to 1880 MHz	1930 to 1990 MHz
<b>Frequency TX</b>	1710 to 1785 MHz	1850 to 1910 MHz
<b>RF Power Stand</b>	1W at 12.5% duty cycle	1W at 12.5% duty cycle
<b>Impedance</b>	50 $\Omega$	
<b>VSWR</b>	< 2	
<b>Typical Radiated Gain</b>	0 dBi on azimuth plane	

### Serial Port

No. of Ports	1
Interface	OnCell G2110: RS-232 OnCell G2110-T: RS-232 OnCell G2150I: RS-232 and RS-422/485 (separate interfaces)
Connector	OnCell G2110: DB9 (female) OnCell G2110-T: DB9 (female) OnCell G2150I: DB9 (female) for RS-232, 5-pin terminal block for RS-422/485

**Serial Communication Parameters**

Parity	None, Even, Odd, Space, Mark
Data Bits	7, 8
Stop Bits	1, 2
Flow Control	RTS/CTS, None
Transmission Speed	300 bps to 115.2 Kbps
RS-422/485 Termination	120 $\Omega$ , DIP switch controlled (OnCell G2150I only)
RS-422/485 Pull High/Low	150 K $\Omega$ , 1 K $\Omega$ (OnCell G2150I only)
Isolation	2.5 KV RMS for 1 minute on all serial signals (OnCell G2150I only)
Serial Line Protection	15 KV ESD

**Power Requirements**

Power Input	12 to 48 VDC
Power Consumption	50 mA @ 12V when idle 300 to 900 mA (peak) @ 12V during data link

**Mechanical Specifications**

Material	PC+ABS, IP30 rating
Dimensions	27 × 123 × 79 mm
Weight:	150 ±5g

**Environment**

Operating Temperature	-20° to 55°C (32° to 131°F), 5 to 95%RH -30° to 75°C (32° to 167°F), 5 to 95%RH (OnCell G2110-T only)
Storage Temperature	-40° to 75°C (-4° to 167°F), 5 to 95%RH

**Regulatory Approvals**

CE, FCC	Class A
---------	---------

**Limited Warranty**

Period	5 years
--------	---------



## Pin Assignments

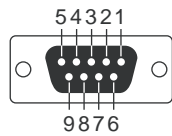

DB9 (Female) for RS-232

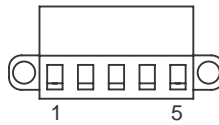

Terminal Block for RS-422/485

Pin	RS-232	RS-422*	RS-485* (4-wire)	RS-485* (2-wire)
1	DCD	TxD+	TxD+	---
2	TxD	TxD-	TxD-	---
3	RxD	RxD+	RxD+	Data + (B)
4	DSR	RxD-	RxD-	Data - (A)
5	GND	---	---	---
6	DTR	---	---	---
7	CTS	---	---	---
8	RTS	---	---	---

\*RS-422 and RS-485 are available on the OnCell G2150I only

# 2

## Getting Started

---

This chapter includes instructions on how to install the OnCell G2100 Series modem.

The following topics are covered in this chapter:

- ❑ **Product Characteristics**
- ❑ **Dimensions**
  - OnCell G2150I
  - OnCell G2110, G2110-T
- ❑ **Connecting the Hardware**
  - Wiring Requirements
  - SIM Card Installation
  - DIN-Rail Mounting
  - Connecting the Antenna
  - Connecting Power
  - Connecting a Serial Device
  - LED Indicators

## Product Characteristics

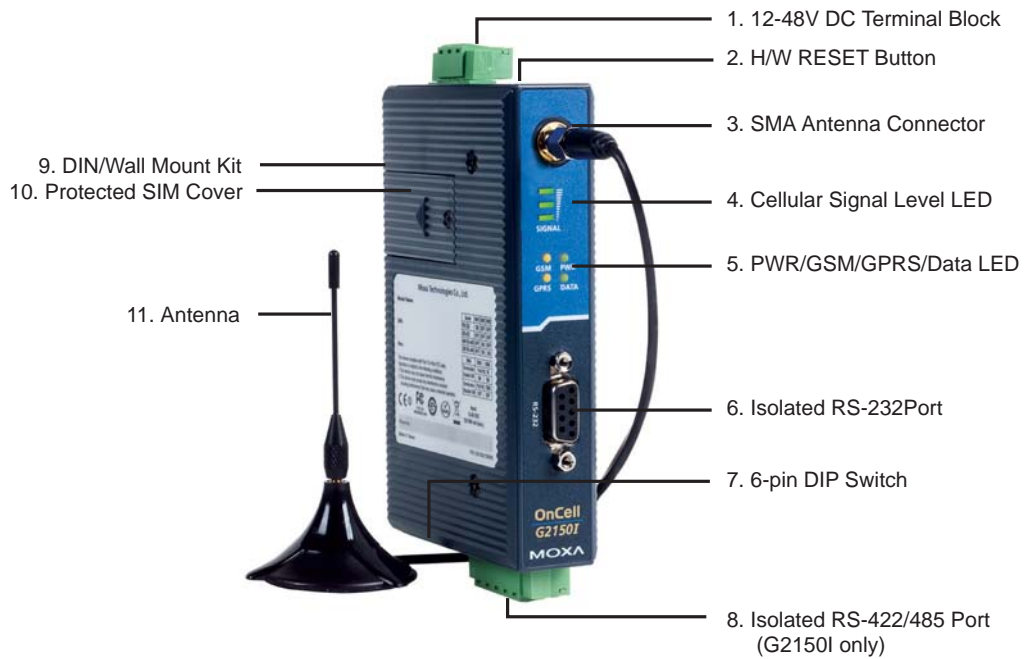

## Dimensions

### OnCell G2150I

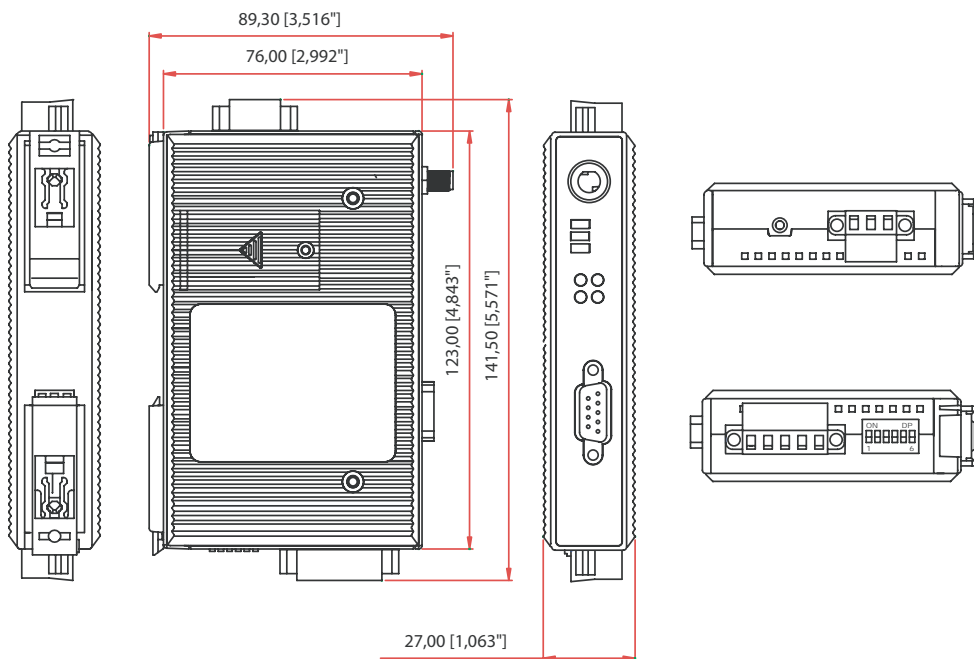

OnCell G2110, G2110-T

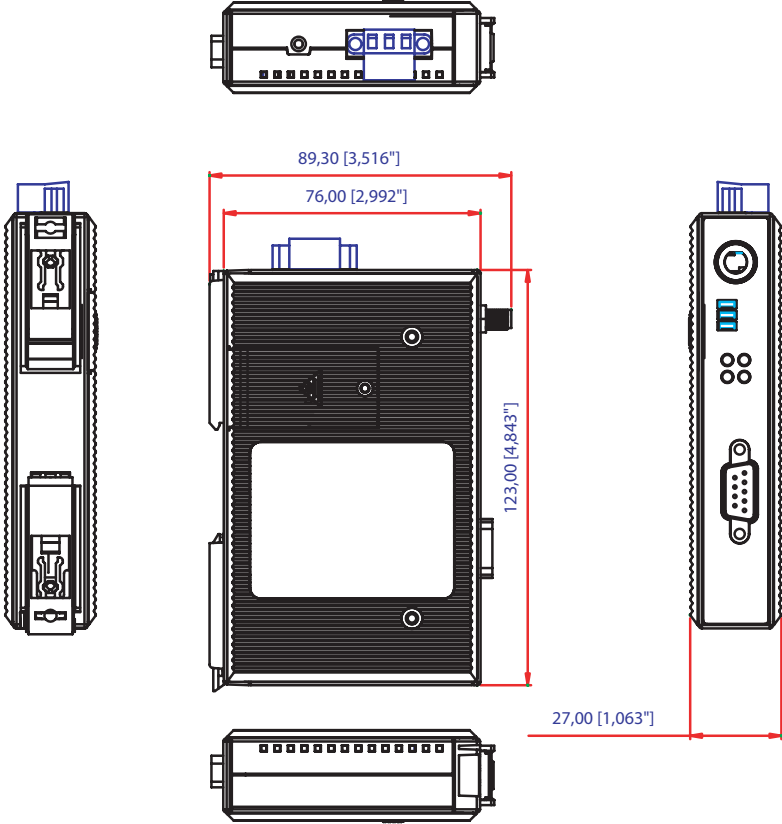

## Connecting the Hardware

This section describes how to connect the OnCell G2100 Series modem to a host PC or serial devices for initial testing and configuration.

### Wiring Requirements



#### ATTENTION

**Safety First!**

Be sure to disconnect the power cord before installing and/or wiring your device.

**Wiring Caution!**

Calculate the maximum possible current in each power wire and common wire. Observe all electrical codes dictating the maximum current allowable for each wire size. If the current goes above the maximum ratings, the wiring could overheat, causing serious damage to your equipment.

**Temperature Caution!**

Be careful when handling the device. When plugged in, the device's internal components generate heat and the casing may feel hot to the touch.

You should also pay attention to the following guidelines:

- Use separate paths to route wiring for power and devices. If power wiring and device wiring paths must cross, make sure the wires are perpendicular at the intersection point.

**NOTE:** Do not run signal or communication wiring and power wiring in the same wire conduit. To avoid interference, wires with different signal characteristics should be routed separately.

- Use the type of signal transmitted through a wire to determine which wires should be kept separate. Generally, if different wires share similar electrical characteristics, they can be bundled together.
- Keep input wiring and output wiring separate.
- If possible, it is recommended that all device wiring be clearly labeled.

## SIM Card Installation

In order to protect the SIM card, the SIM card slot is located inside the casing. You will need to unscrew and remove the outer cover before installing or removing the SIM card.

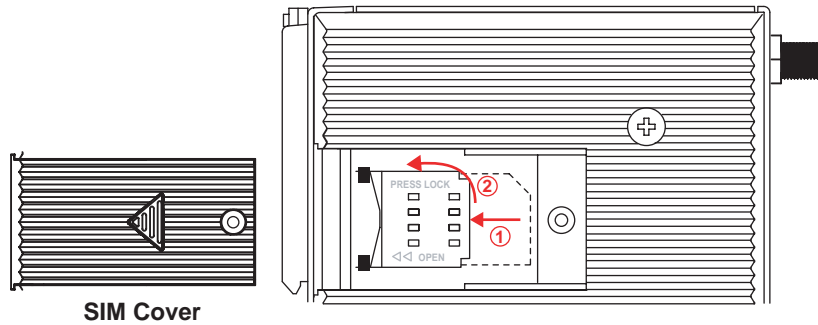

Follow these steps to remove or install the SIM card:

1. Unscrew the outer cover.
2. Slide the outer cover to the left to remove it.
3. Slide the SIM card cradle to the left and pull it towards you. Insert the SIM card into the cradle.
4. Swing the cradle back against the unit and slide it back into place. Replace the outer SIM card cover.



### ATTENTION

The SIGNAL LEDs on the front panel provide a convenient way of checking if the SIM card is installed properly. One of the three SIGNAL LEDs should remain on as long as the antenna is installed and the network is operating normally. If none of the SIGNAL LEDs are on, then the SIM card may not be installed properly. Since the PIN code is stored on the SIM card, the modem will not be accessible from the cellular network if the SIM card is not installed correctly.

## DIN-Rail Mounting

Built-in mounting appendages allow the modem to be mounted to a flat wall or on a DIN-rail. Follow the instructions below to mount the modem on a DIN-rail.



### ATTENTION

Before mounting the OnCell G2100 Series modem, we strongly recommend that you first remove the antenna connection.

**STEP 1:**  
Use a flat-blade screw driver to pull the bottom mounting appendage out. It should snap into place.

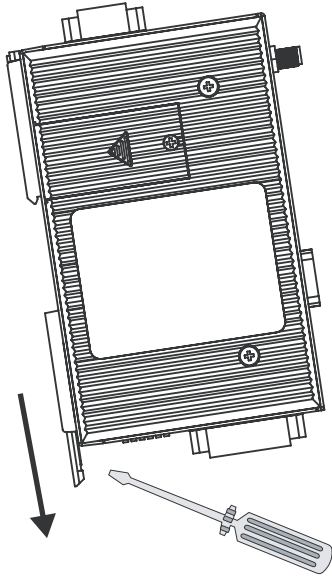

**STEP 2:**  
Hook the modem over the top edge of the DIN-rail as shown.

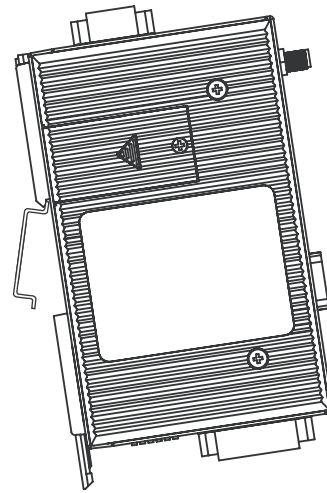

**STEP 3:**  
Place the modem flush against the DIN-rail as shown.

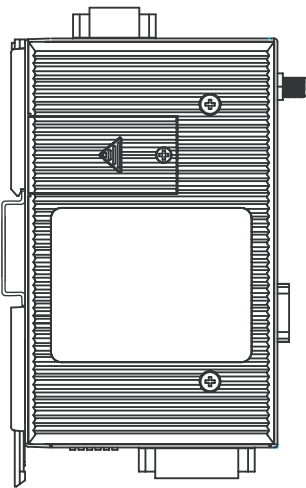

**STEP 4:**  
Slide the bottom mounting appendage back in. It should snap into place over the bottom edge of the DIN-rail.

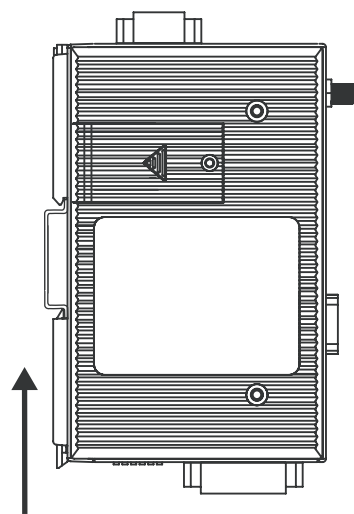

**ATTENTION**

Grounding and wire routing help limit the effects of noise due to electromagnetic interference (EMI). There are two grounding points for the unit. One point is the 3-pin terminal block connector for power. Underneath the bottom mounting appendage is another grounding point.

**For DIN-rail mounted units:** Ground the DIN-rail itself. The modem's grounding point under the mounting appendage will be in direct contact with the rail. Be sure to ground the DIN-rail before connecting the modem to the DIN-rail.

**For wall or panel-mounted units:** Run a ground wire from the right-most pin of the terminal block connector. Be sure to connect the ground wire before connecting devices to the modem.

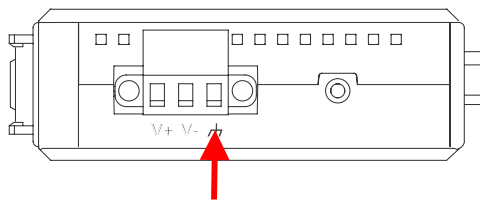



## Wall Mounting

Follow the instructions below to mount the OnCell Series modem on a wall:

**STEP 1:**

Remove the 3-pin power terminal block. For the OnCell G2150I, also remove the 5-pin RS-422/485 terminal block.

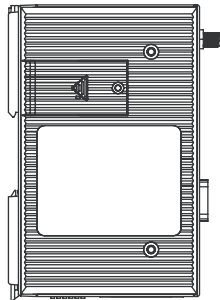

**STEP 2:**

Use a flat-blade screw driver to pull out both the top and bottom mounting appendages.

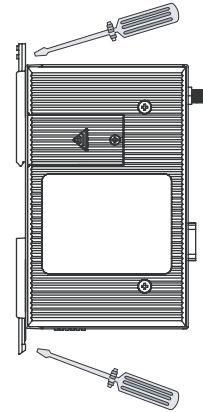

**STEP 3:**

Use screws and the mounting appendages to mount the unit onto the wall.

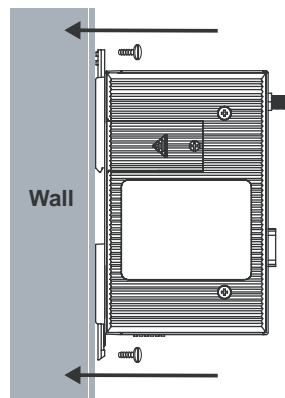

**STEP 4:**

Reattach the terminal block(s) to the modem.

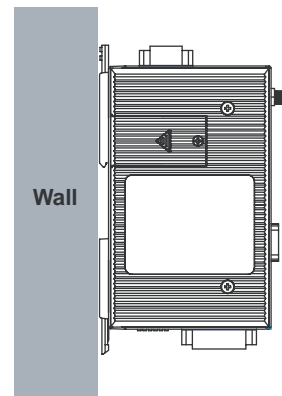

## Connecting the Antenna



### ATTENTION

Make sure the transmitter antenna is placed so that it is at least 20 cm (8 inches) away from any people or users. The modem is not designed for applications where users will be in close proximity for prolonged periods.

Turn the unit off for the following situations:

- When in an aircraft
- When around gasoline or diesel-fuel pumps and before filling your vehicle with fuel
- When in hospitals and any other place where medical equipment may be in use

Respect any restrictions on the use of radio equipment, especially around fuel depots, chemical plants, and blasting operations.

The OnCell G2100 Series modem may present a hazard for inadequately protected personal medical devices such as hearing aids and pacemakers. Consult the manufacturer of the medical device to determine if it is adequately protected.

The OnCell G2100 Series modem may cause interference for inadequately protected electronic equipment. Observe any warning signs and manufacturers' recommendations.

All OnCell G2100 Series modems are shipped with a 0 dBi antenna with SMA connector and magnetic mount. The 3-meter patch cord is ideal for installing the modem in places such as a metal cabinet or a vending machine.

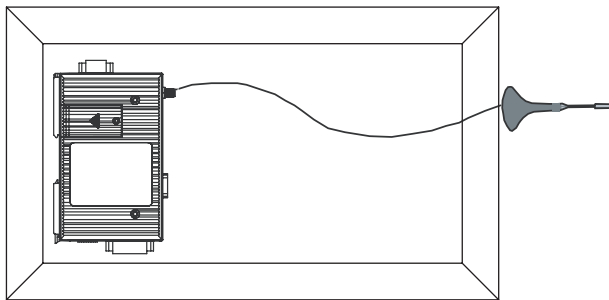

## Connecting Power

The power connector is a 3-pin terminal block. It can connect to different types of field power sources that support 12 to 48 VDC. When power is connected, the "PWR" LED will light up. It will glow a steady green when the system is ready.

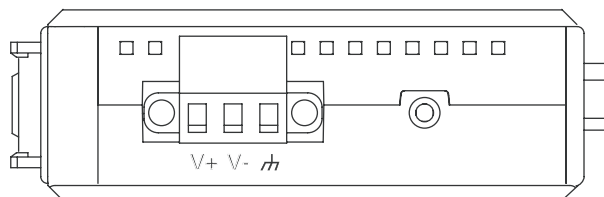

A terminal block adaptor with power jack connector is provided to connect to AC power instead of DC power. Compatible AC power adaptors are listed on the Moxa website, [www.moxa.com](http://www.moxa.com).



**ATTENTION**

Always install the antenna first and then connect power. Do not connect power if the antenna has not been installed! Doing so may damage the unit.

### Connecting a Serial Device

The RS-232 serial interface come with 15 KV ESD serial line protection and matches the pinouts of a standard D-shell connector. A serial device or PC COM port can be connected with a DB9(M) to DB9(F) serial cable, such as Moxa's CBL-F9M9-150 (100 cm) or CBL-F9M9-20 (20 cm).

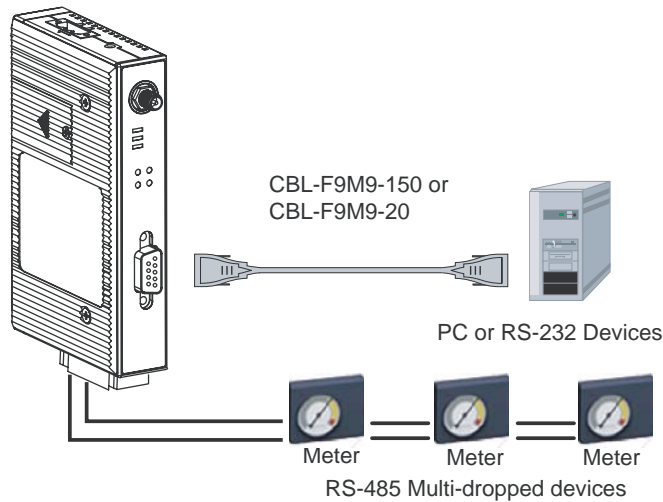

### For OnCell G2150I Only

A separate 5-pin terminal block connector on the bottom panel is used for RS-422, 2-wire RS-485, and 4-wire RS-485 connections. A built-in 120 Ω terminal resistor can be activated by DIP switch if required. Pull high/low resistor adjustments are also allowed. Both the RS-232 and RS-422/485 interfaces come with two types of protection: (1) 2.5 KV RMS isolation for 1 min and (2) 15 KV ESD serial line protection.

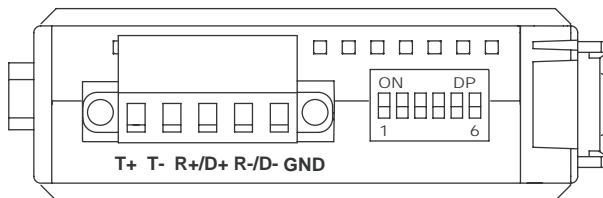

RS-422/485 settings are configured by DIP switch, on the bottom panel.

- Switches 1, 2, and 3 select the serial interface.
- Switch 4 enables or disables the termination resistor.
- Switches 5 and 6 set the pull high/low resistor.

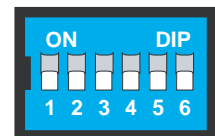

Serial Interface	SW1	SW2	SW3
RS-232	ON	OFF	OFF
RS-422	OFF	OFF	OFF
4W RS-485	OFF	ON	OFF
2W RS-485	OFF	ON	ON

Termination Resistor	SW4
Enabled	ON
Disabled	OFF

Pull High/Low Resistor	SW5	SW6
1 K $\Omega$	ON	ON
150 K $\Omega$	OFF	OFF

## LED Indicators

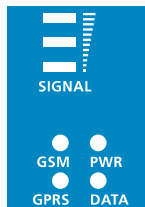

Name	Color	Function
SIGNAL (3 LEDS)	Green	Signal level (data transmission requires at least 2 bars)
PWR	Green	DC power connection
GSM	Amber	Steady: GSM/CSD connected Blinking: SMS Tunnel is enabled (registered to a carrier)
GPRS	Amber	GPRS connected
DATA	Green	Serial Tx/Rx

Signal LEDs	Function
None	No signal or SIM card not installed properly
1 bar	Weak or insufficient signal (SMS only)
2 bars	Average signal (GSM/CSD and GPRS connections)
3 bars	Exceptional signal (GSM/CSD and GPRS connections)

# 3

## OnCell Configurator

---

Most modems are configured using AT commands. Moxa's OnCell Configurator provides an easy and convenient alternative to configure the OnCell 2100 Series modem.

This chapter covers the following topics:

- Overview**
- Installing OnCell Configurator**
- Launching OnCell Configurator**
- Configuring Serial Connection and Device Name**
- Configuring the PIN Setting**
- Configuring the Radio Band**
- Initial Strings**
- Saving the Configuration Profile**
- Applying Modem Settings**
- Retrieving the Modem Settings**
- Loading a Profile**
- Signal Strength Monitor**
- Upgrading the Firmware**
- Setting Modem Defaults**

## Overview

**OnCell Configurator** is a PC-based utility for managing and configuring your OnCell G2100 Series modem. With its Windows-based graphical interface, even first-time users will find it easy to learn. You can configure general settings, modes, and dial-out parameters without any knowledge of the associated AT commands. It is much more convenient than traditional methods of configuration that require users to search through a thick AT command reference manual.

OnCell Configurator also makes it more convenient to implement mass deployment or pre-configuration.

- An installation wizard provides step-by-step configuration of the modem.
- The configuration is easily stored and replicated on other modems.

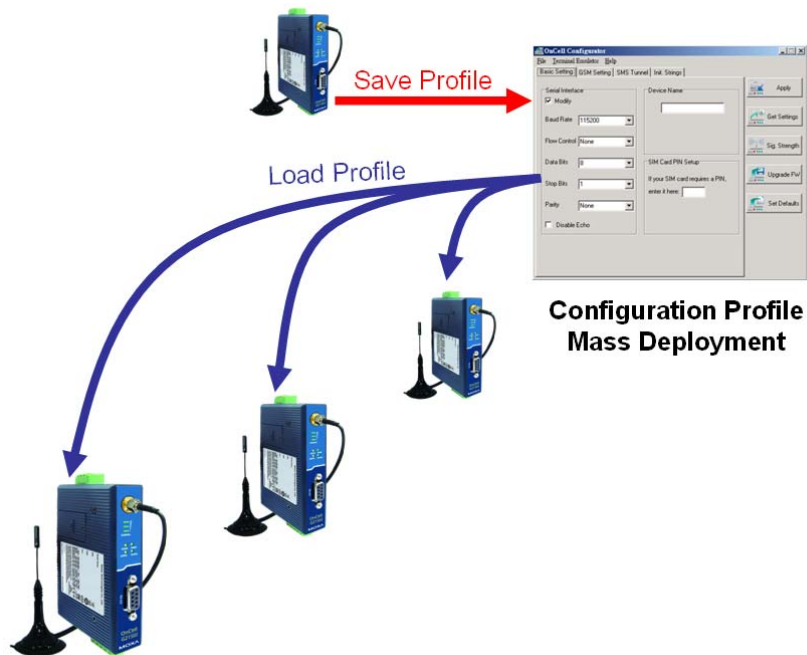

## Installing OnCell Configurator

To install OnCell Configurator, follow the instructions below. After installation, users will be able to use the Configurator, Wizard, and Terminal Emulator for further operations.



### ATTENTION

OnCell Configurator supports Windows 2000, XP, 2003, and Vista.

1. Find the installation file on the Document and Software CD. The installation file will be located in the /Configurator/ directory and will be named "**OnCell\_Configurator\_Install\_1.1.exe**" or something similar.

2. Double click the installation file.



3. Click **Next** to proceed.

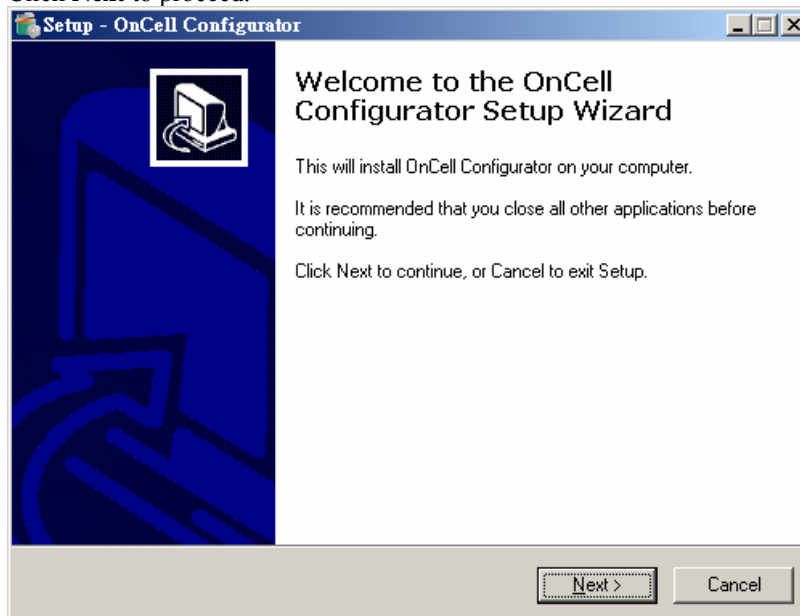

4. Choose **I accept the agreement** and click **Next**.

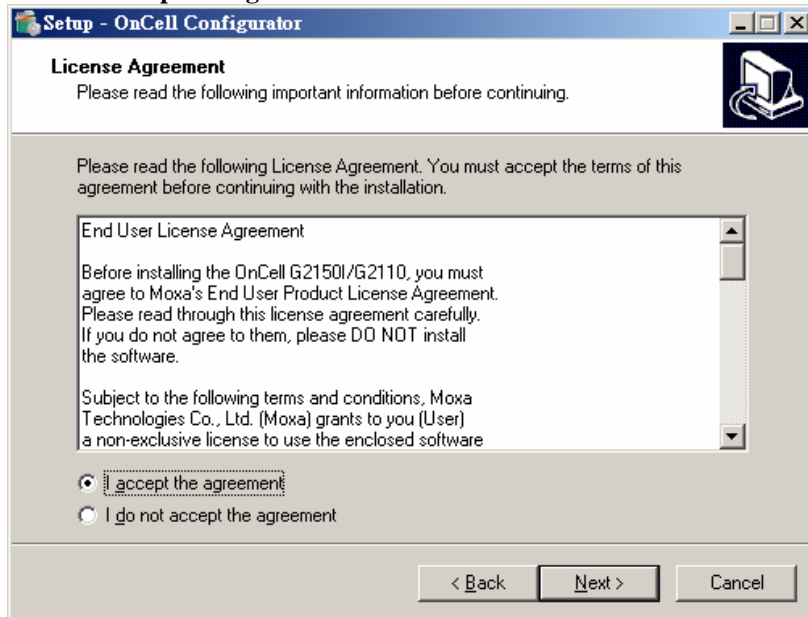

5. Click **Next** to proceed.

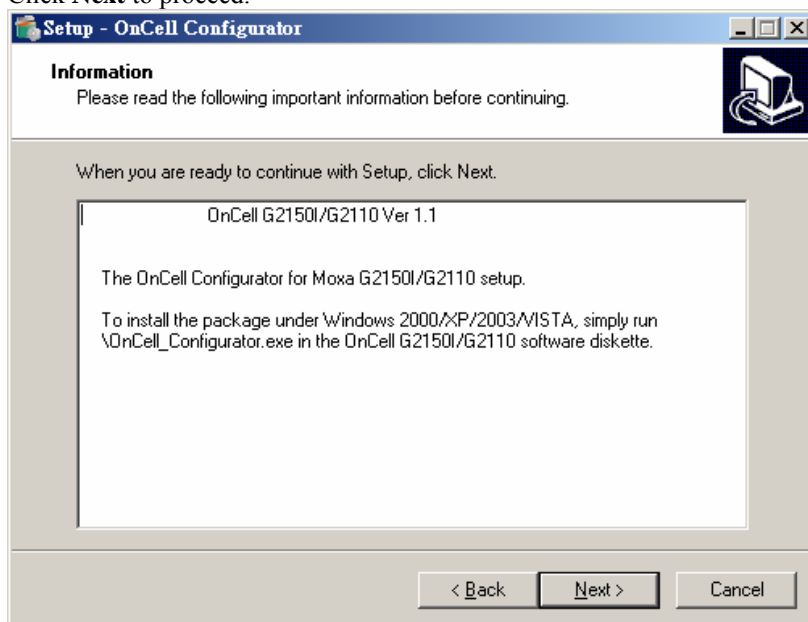



6. Click **Next**, or browse to a proper folder to proceed.

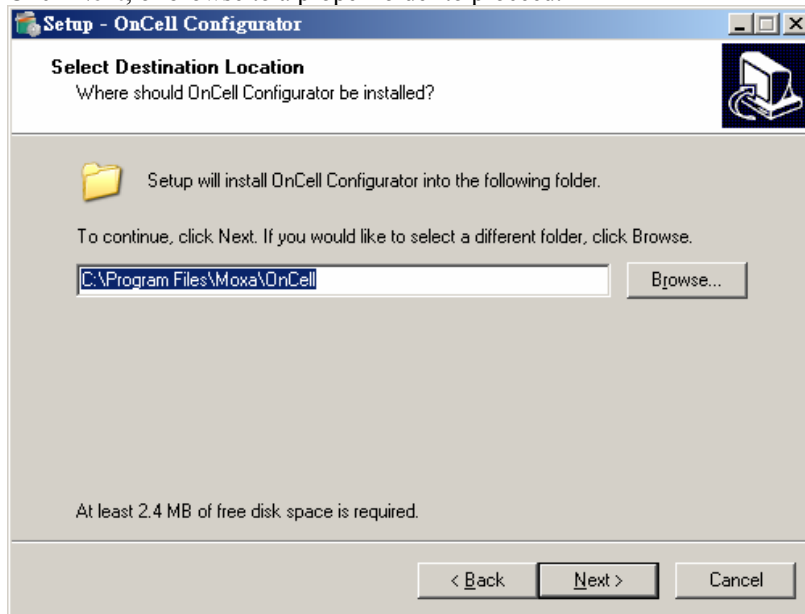

7. Click **Next** to proceed.

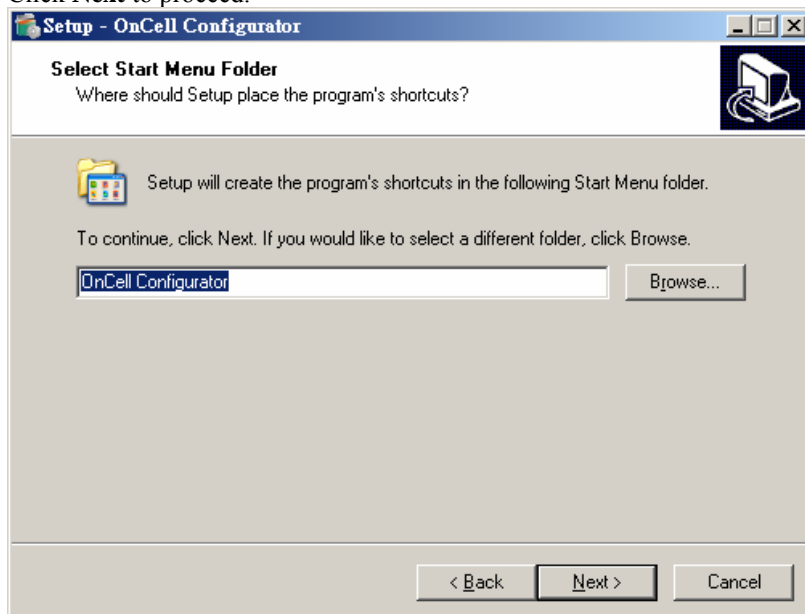

8. Click **Next** to proceed.

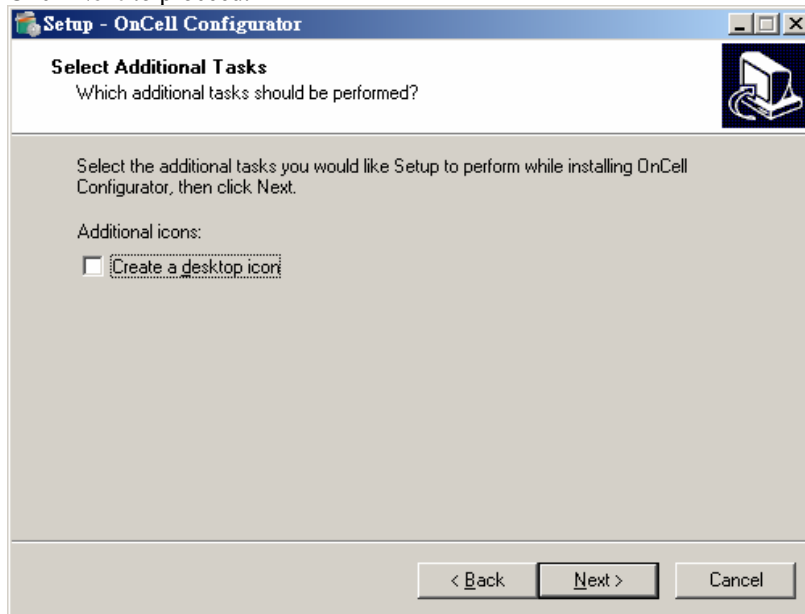

9. Click **Install** to start the software installation.

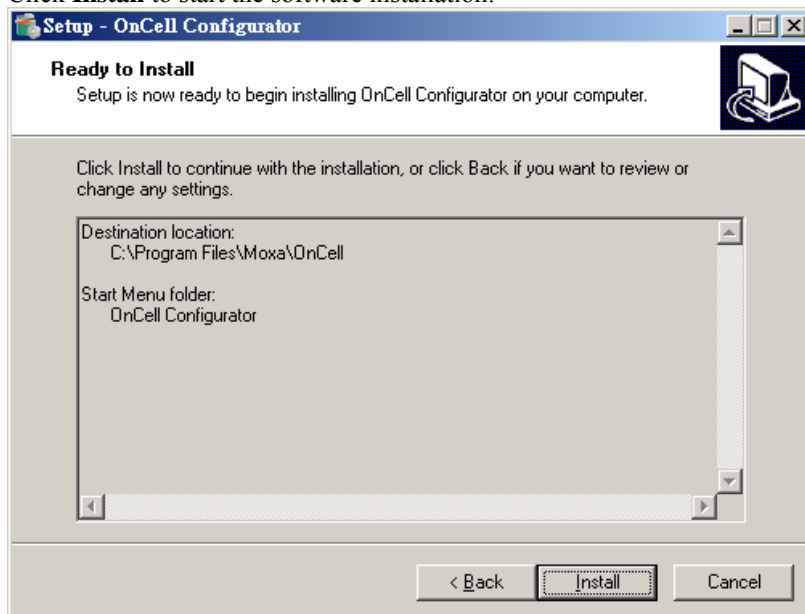

10. Wait until the installation is complete.

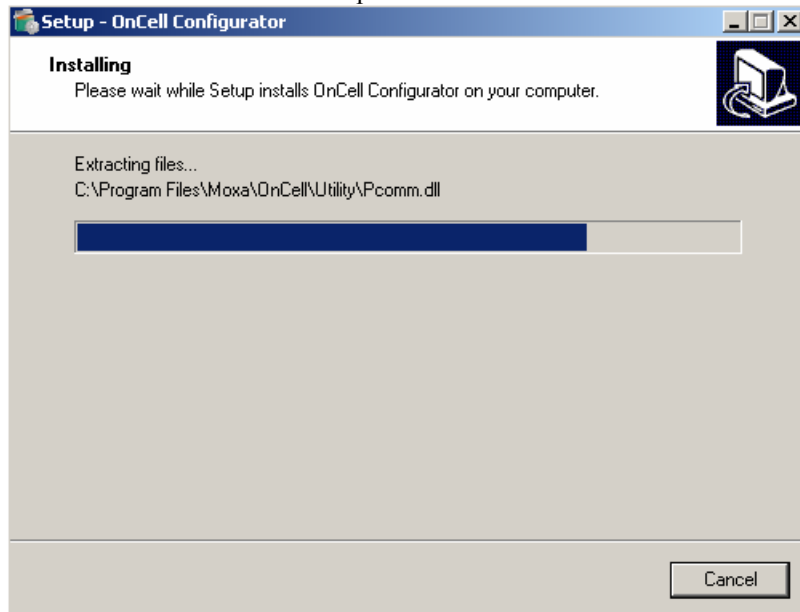

11. Click **Next** to proceed.

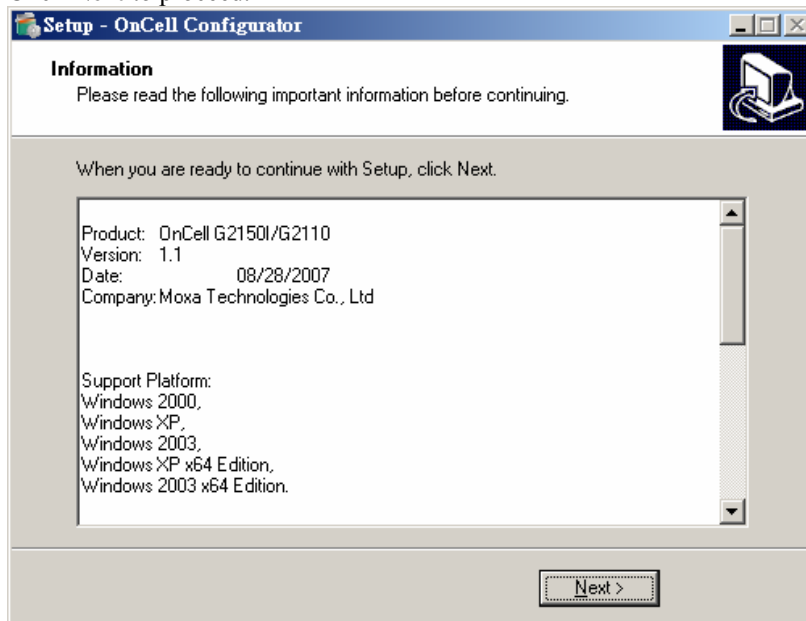

12. Click **Finish**.

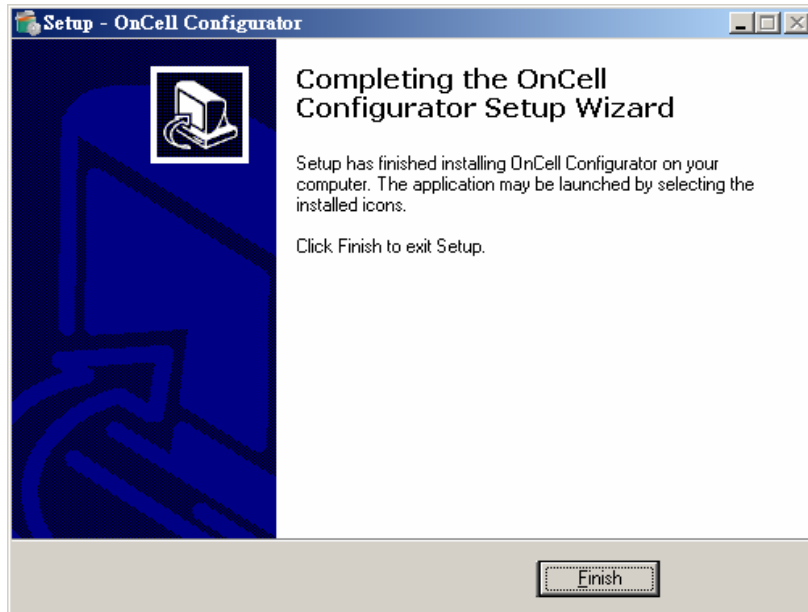

## Launching OnCell Configurator

1. Start OnCell Configurator from the Windows Start menu.

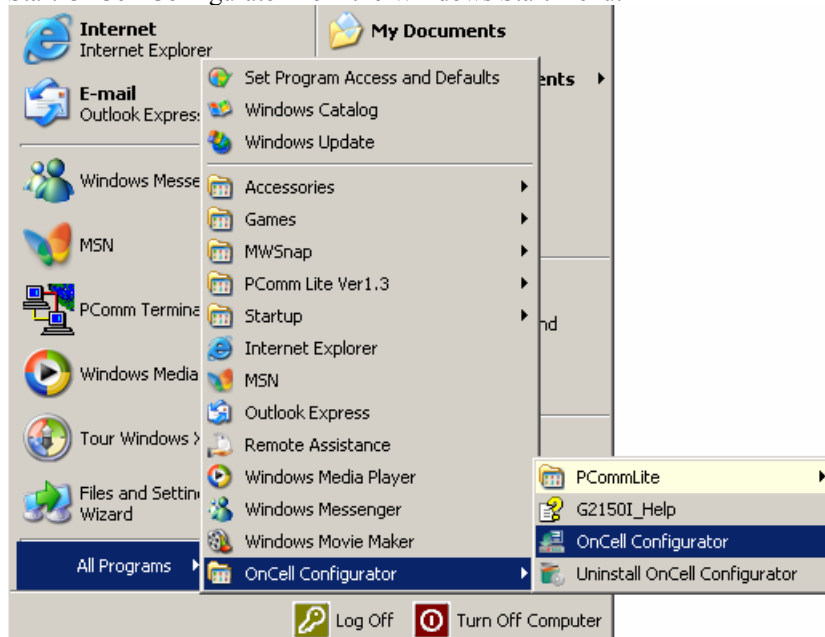

2. Select one of the three options:

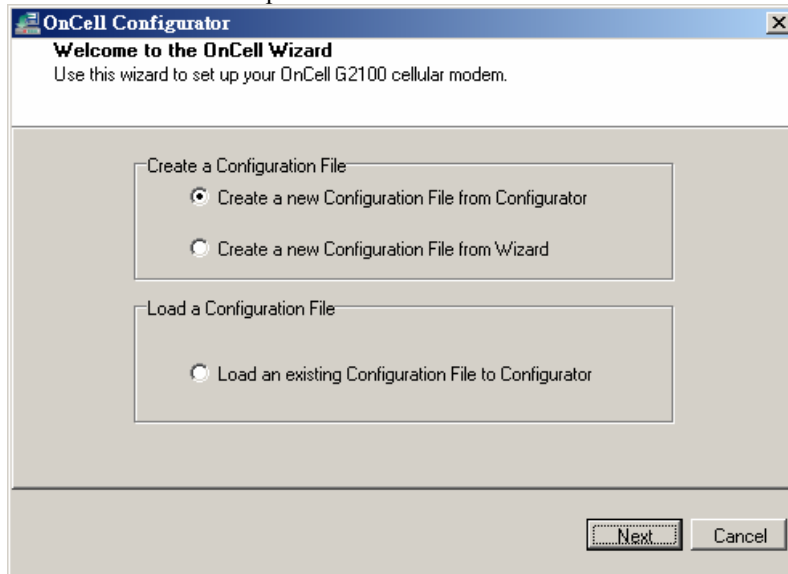

3. Whether you use the **Configurator** or the **Wizard**, any modifications to the settings will not go into effect until you click **Apply**.

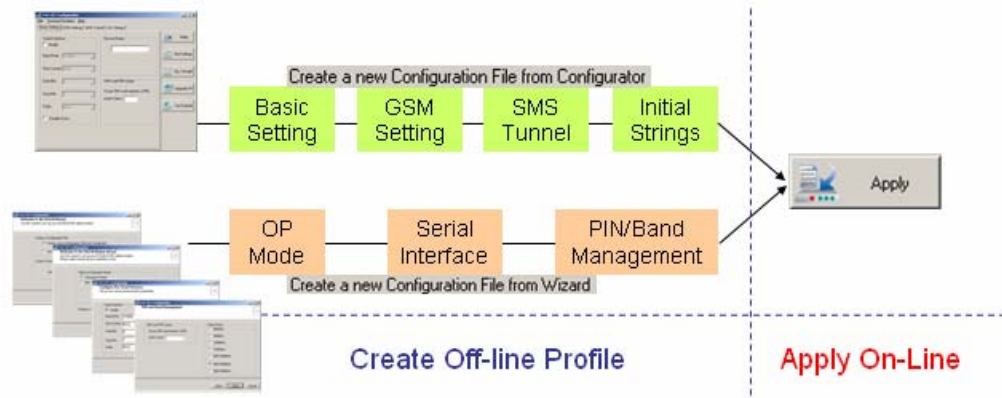

## Configuring Serial Connection and Device Name

The following instructions explain how to configure the serial communication parameters using **Configurator**.

1. Connect the RS-232 port of the OnCell G2100 Series modem to a host PC. On the OnCell G2150I, make sure the RS-232 port is connected and DIP switch 1 is set to **ON**.
2. Start OnCell Configurator and select **Create a new Configuration File from Configurator**.

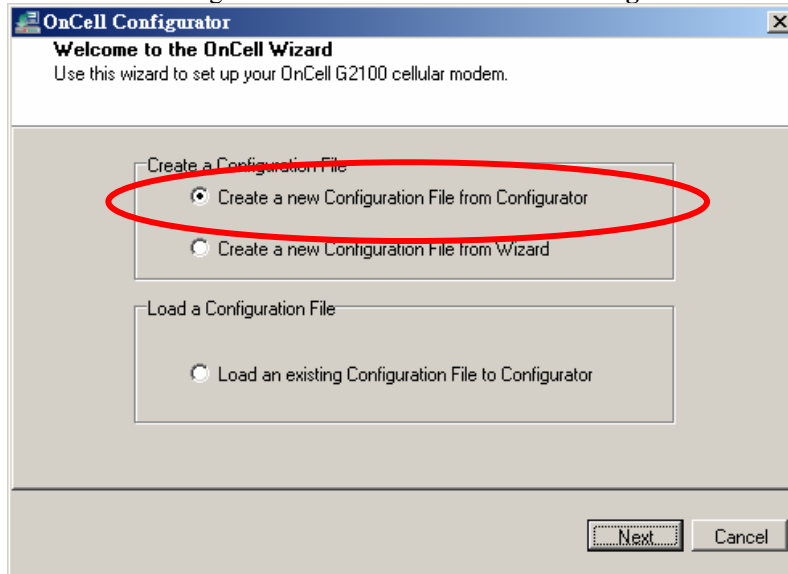

3. On the Basic Setting tab, click **Modify** and configure the serial interface as necessary. Enter the device name in the text input box.

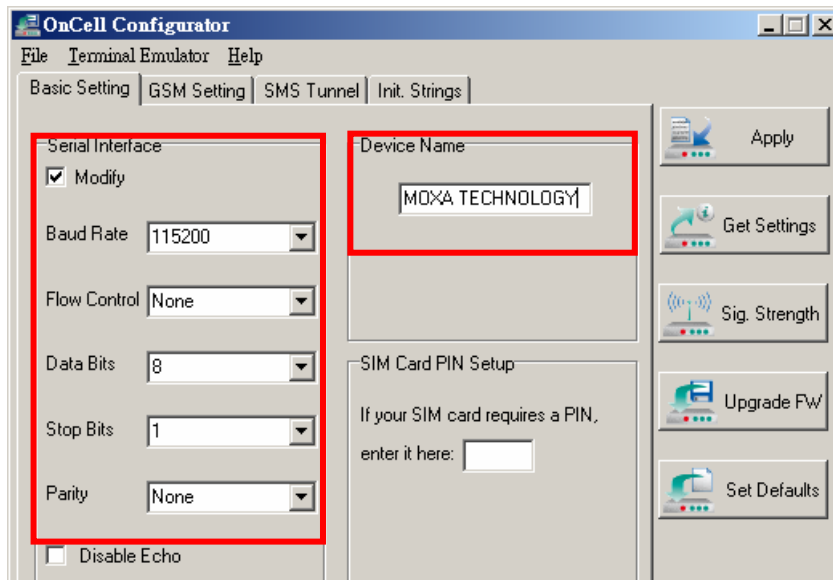

**ATTENTION**

Use the command **AT+IPR=0** to enable **Autobauding**. Please refer to Chapter 4 for details. **Autobauding** and the +++ escape command only work with 8n1 and e71 settings. Using other settings will disable these functions.

Stop bits can only be set to 2 only when parity is set to none.

The default parameters are 115200, 8n1, and RTS/CTS flow control.

The following instructions explain how to configure the serial communication parameters using **Wizard**.

1. Connect the RS-232 port of the OnCell G2100 Series modem to a host PC. On the OnCell G2150I, make sure the RS-232 port is connected and DIP switch 1 is set to **ON**.
2. Start OnCell Configurator and select the **Create a new Configuration File from Wizard** option.

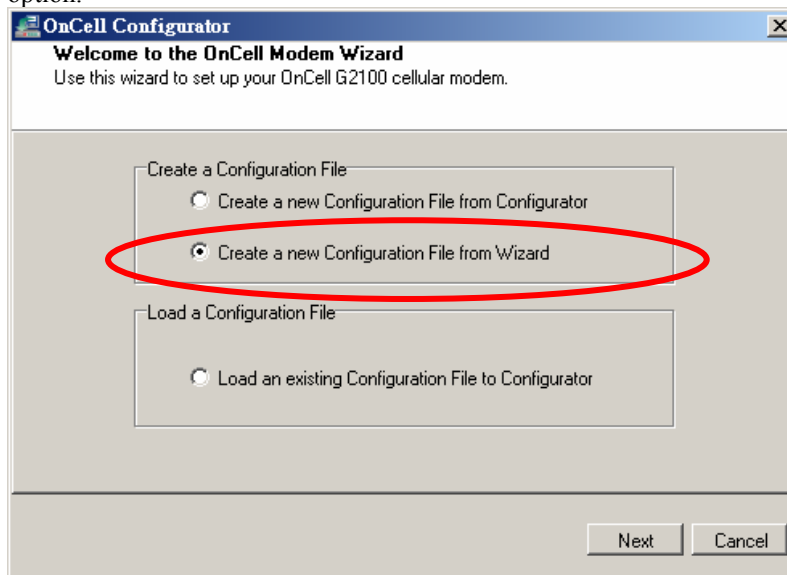

3. On the **Configure the Serial Interface** page, click **Modify** and configure the serial device settings. Enter the device name in the text input box.

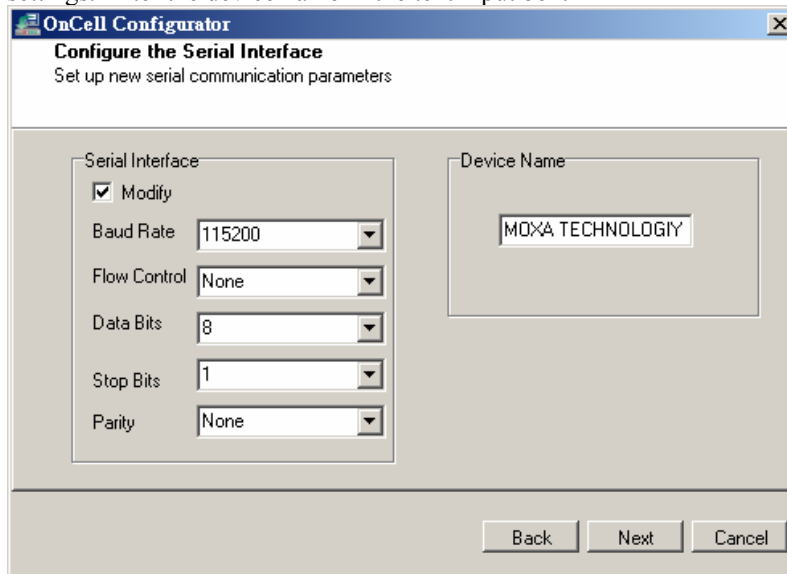

The screenshot shows a window titled "OnCell Configurator" with a sub-header "Configure the Serial Interface" and the instruction "Set up new serial communication parameters". The window is divided into two main sections: "Serial Interface" and "Device Name".

**Serial Interface**

- Modify
- Baud Rate: 115200
- Flow Control: None
- Data Bits: 8
- Stop Bits: 1
- Parity: None

**Device Name**

MOXA TECHNOLOGY

At the bottom right, there are three buttons: "Back", "Next", and "Cancel".



## Configuring the PIN Setting

The following instructions explain how to configure the PIN code using **Configurator**.

1. Connect the RS-232 port of the OnCell G2100 Series modem to a host PC. On the OnCell G2150I, make sure the RS-232 port is connected and DIP switch 1 is set to **ON**.
2. Start OnCell Configurator and select the **Create a new Configuration File from Configurator** option.

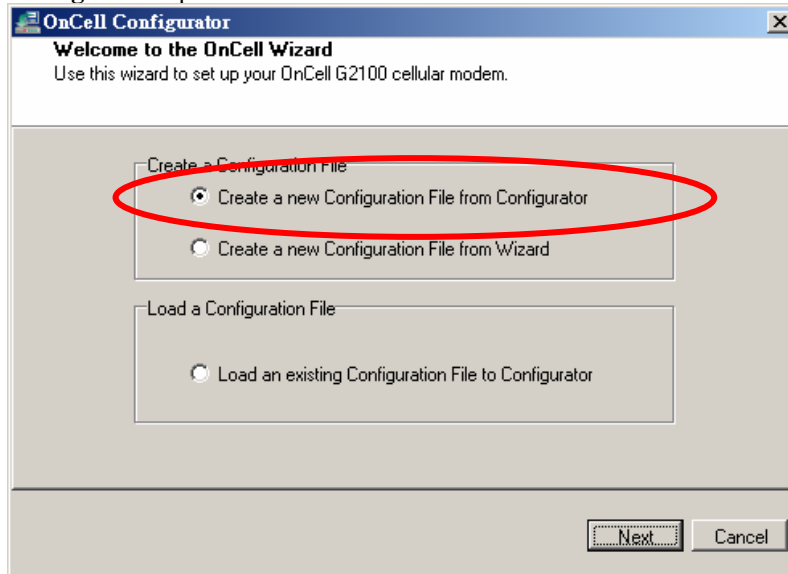

3. On the Basic Setting tab, and enter the correct PIN in the text input box.

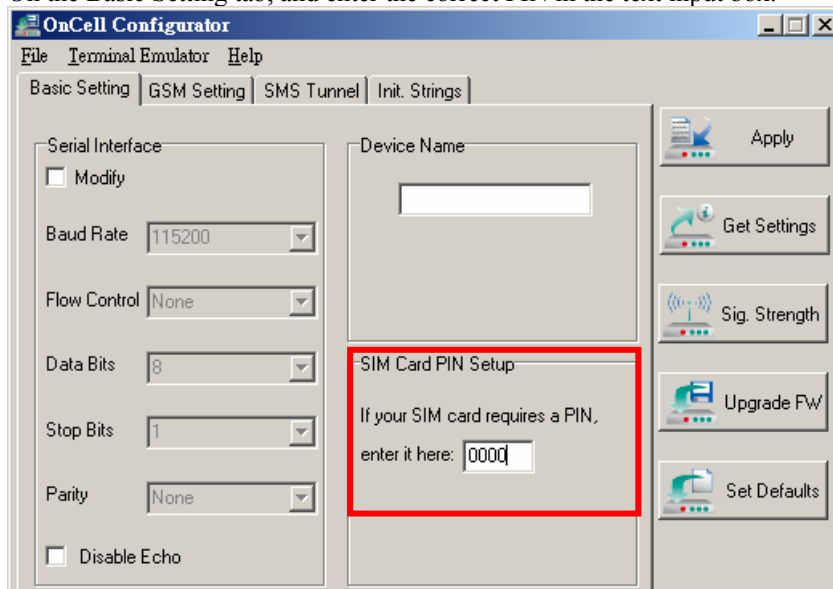

**ATTENTION**

Once the correct PIN is entered using the **AT+ CPIN** command or OnCell Configurator, the system (firmware V1.2 or above) will activate the **Automatic PIN Entry** function. This function will store the current PIN in its memory, and then enter the PIN automatically each time the system boots up. If the SIM card does not match the current PIN, the **Automatic PIN Entry** function will be deactivated.

To activate the **Automatic PIN Entry** function again, use the **AT+ CPIN** command or OnCell Configurator to enter the correct PIN.

To disable the Automatic PIN Entry, use the **AT\*USEPIN=0** command. Please refer to the **OnCell G2100 Series AT Commands Set**, which can be found on the Document and Software CD.

The following instructions show how to configure the PIN code using **Wizard**.

1. Connect the RS-232 port of the OnCell G2100 Series modem to a host PC. On the OnCell G2150I, make sure the RS-232 port is connected and DIP switch 1 is set to ON.
2. Start OnCell Configurator and select the **Create a new Configuration File from Wizard** option.

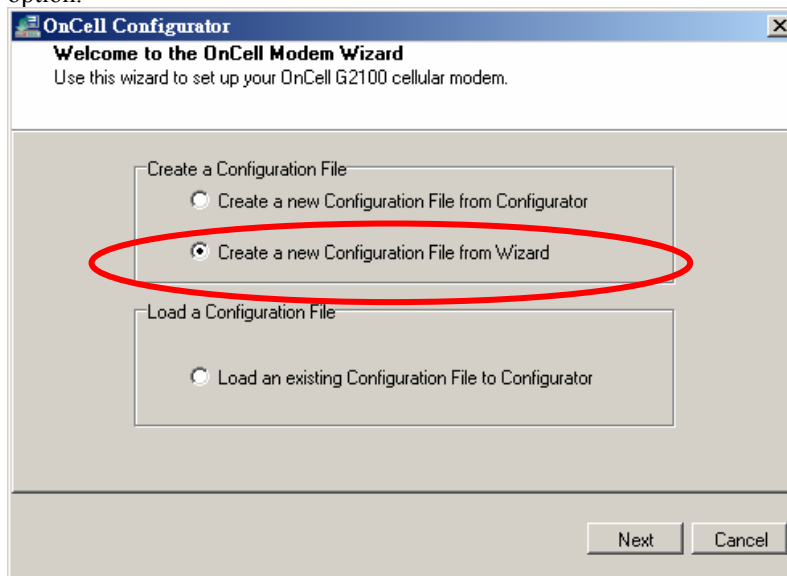

3. On the **PIN and Band Management** page, enter the correct PIN in the text input box.

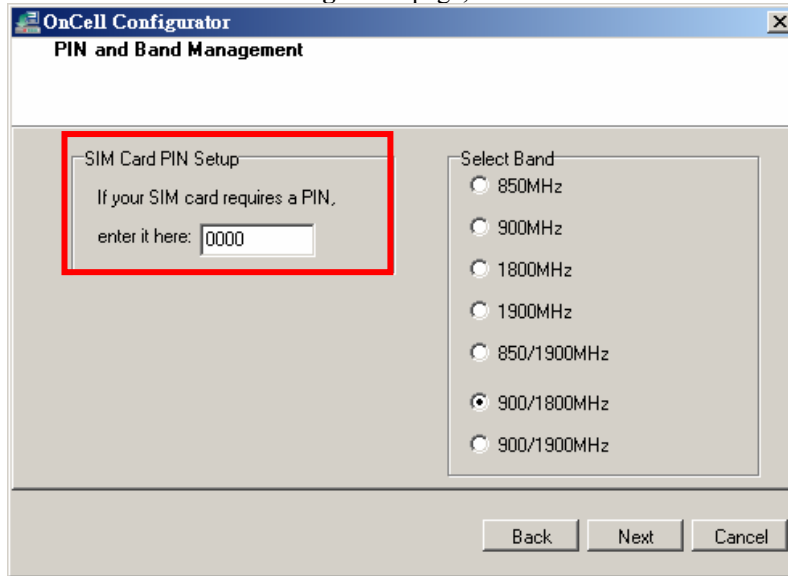

## Configuring the Radio Band

The following instructions illustrate how to configure the radio band using **Configurator**.

1. Connect the RS-232 port of the OnCell G2100 Series modem to a host PC. On the OnCell G2150I, make sure the RS-232 port is connected and DIP switch 1 is set to ON.
2. Start OnCell Configurator and select the **Create a new Configuration File from Configurator**.

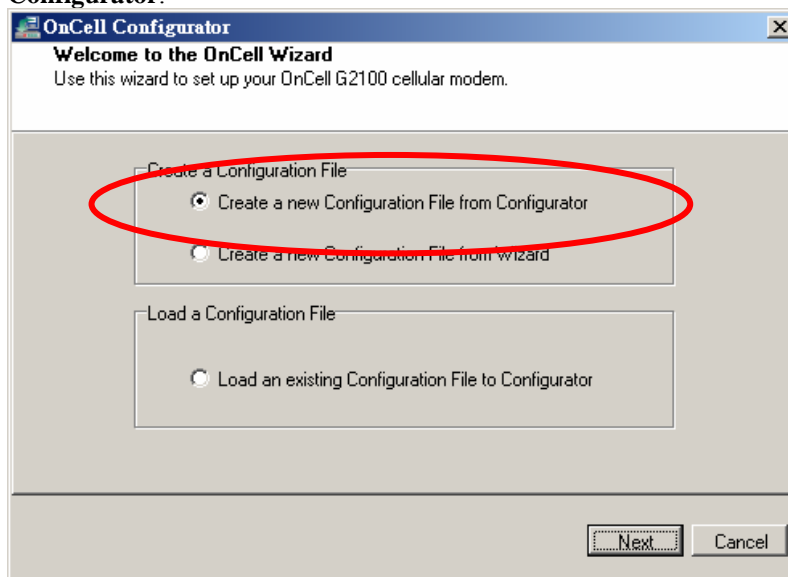

3. On the **GSM Setting** tab, select the correct radio band for your application.

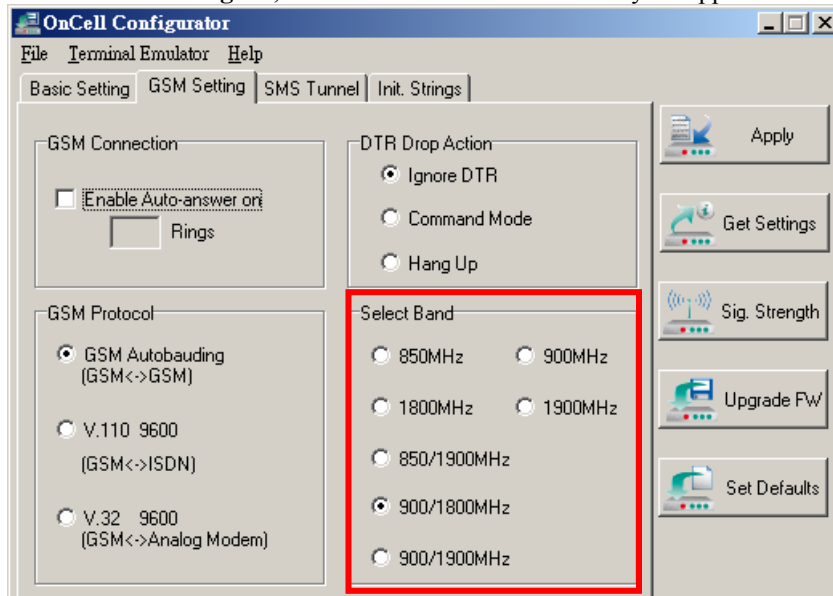

The following instructions illustrate how to configure the radio band using the **Wizard**.

1. Connect the RS-232 port of the OnCell G2100 Series modem to a host PC. On the OnCell G2150I, make sure the RS-232 port is connected and DIP switch 1 is set to ON.
2. Start OnCell Configurator and select the **Create a new Configuration File from Wizard** option.

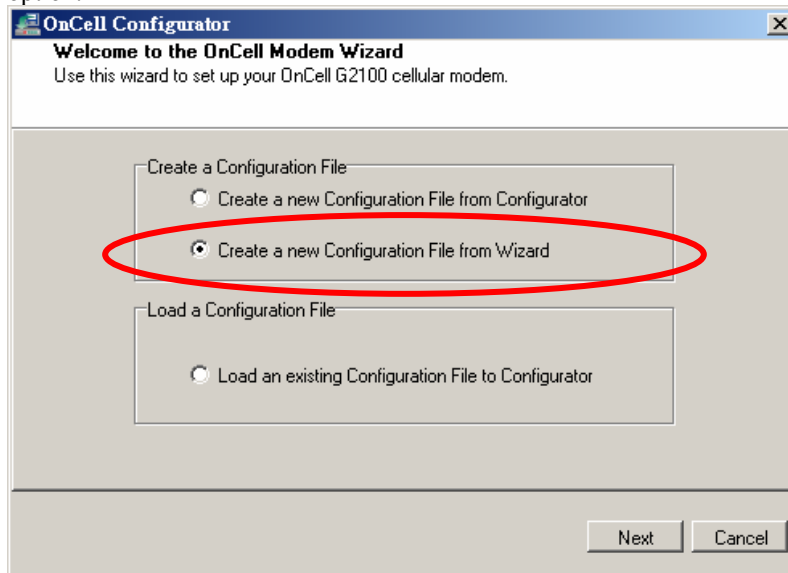

3. On the **PIN and Band Management** page, select the correct radio band for your application.

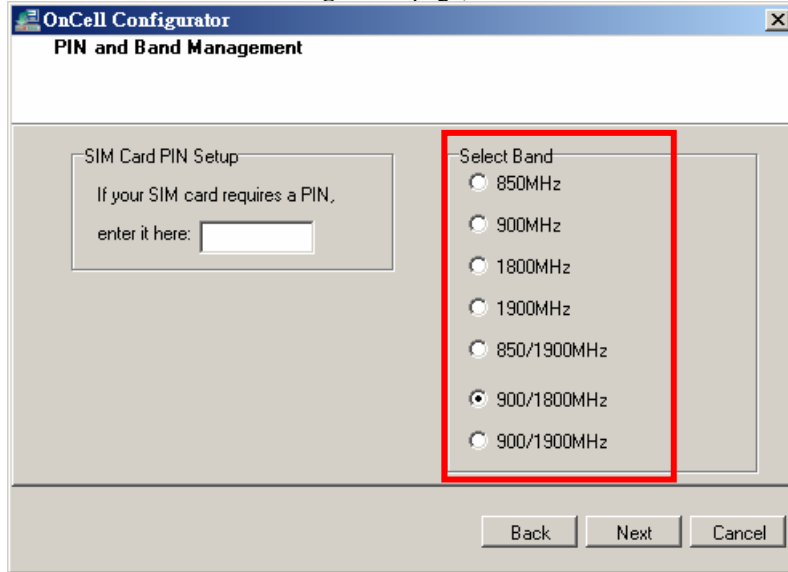

## Initial Strings

The following instructions illustrate how to configure the initial strings using **Configurator**.

1. Connect the RS-232 port of the OnCell G2100 Series modem to a host PC. On the OnCell G2150I, make sure the RS-232 port is connected and DIP switch 1 is set to ON.
2. Start OnCell Configurator and select the **Create a new Configuration File from Configurator** option.

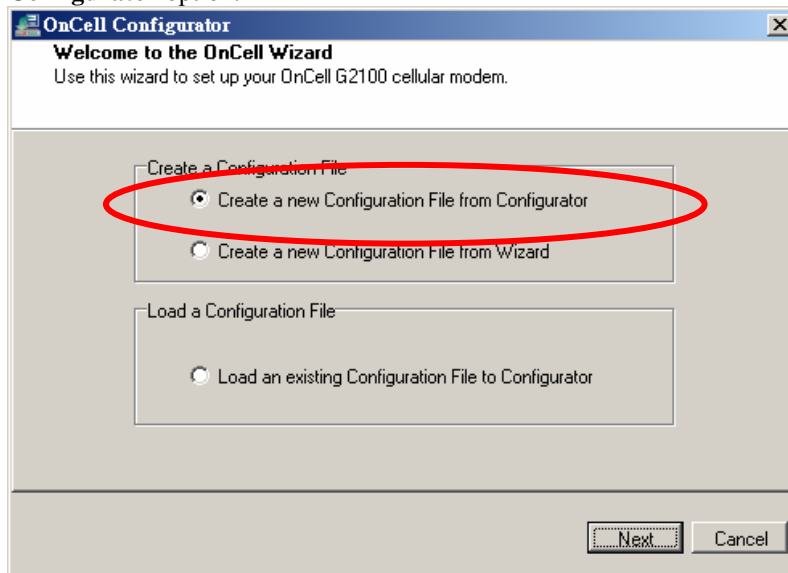

3. On the **Init. Strings** tab, enter the initial string in the text input box.

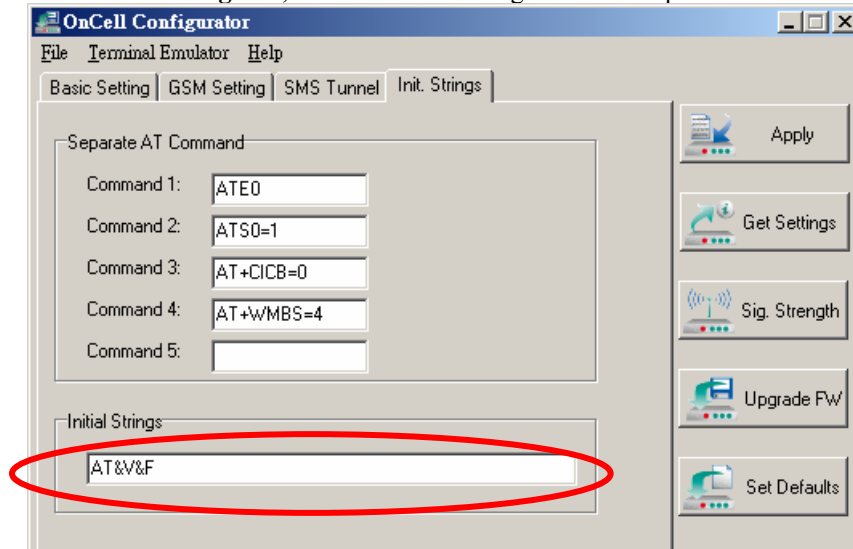

**ATTENTION**

A maximum of 39 characters is allowed for each initial string.

## Saving the Configuration Profile

The following instructions illustrate how to configure the serial communication parameters using Configurator.

1. Connect the RS-232 port of the OnCell G2100 Series modem to a host PC. On the OnCell G2150I, make sure the RS-232 port is connected and DIP switch 1 is set to ON.
2. Start OnCell Configurator and select **Create a new Configuration File from Configurator**.

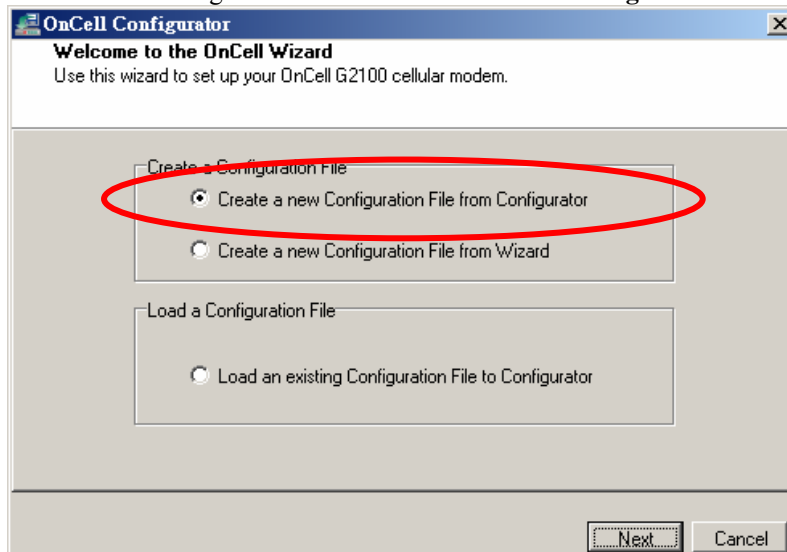

3. Select **Save File** from the **File** menu.

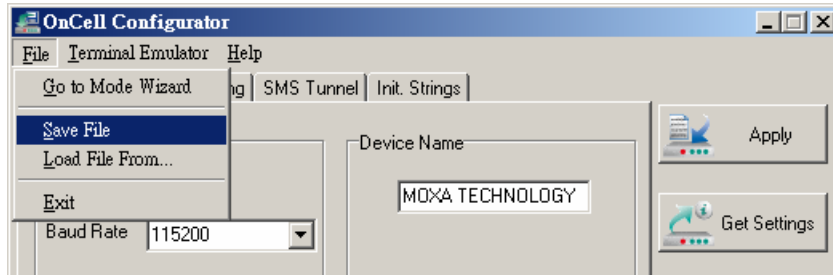

4. Select a folder and enter the file name for the profile. Click **Save**.

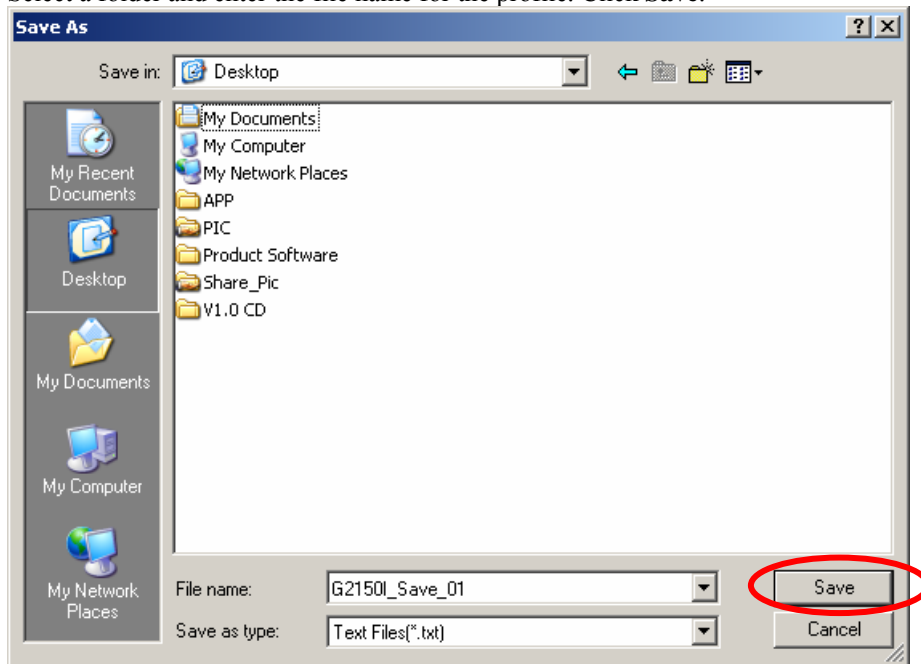

## Applying Modem Settings

The following instructions illustrate how to apply the current settings to an OnCell G2100 Series modem using **Configurator**.

1. Connect the RS-232 port of the OnCell G2100 Series modem to a host PC. On the OnCell G2150I, make sure the RS-232 port is connected and DIP switch 1 is set to ON.



### ATTENTION

The RS-232 connector uses the standard pinouts. A direct male DB9 to female DB9 cable, such as Moxa's CBL-F9M9-150 (100 cm) or CBL-F9M9-20 (20 cm), can be used to connect to a PC's serial port. If you use a USB-to-serial product to configure the OnCell G2100 Series modem, we strongly recommend using Moxa's **UPort 1110**. Other USB-to-serial products may cause unexpected errors when configuring the OnCell G2100 Series modem.

2. Start OnCell Configurator and select the **Create a new Configuration File from Configurator** option.

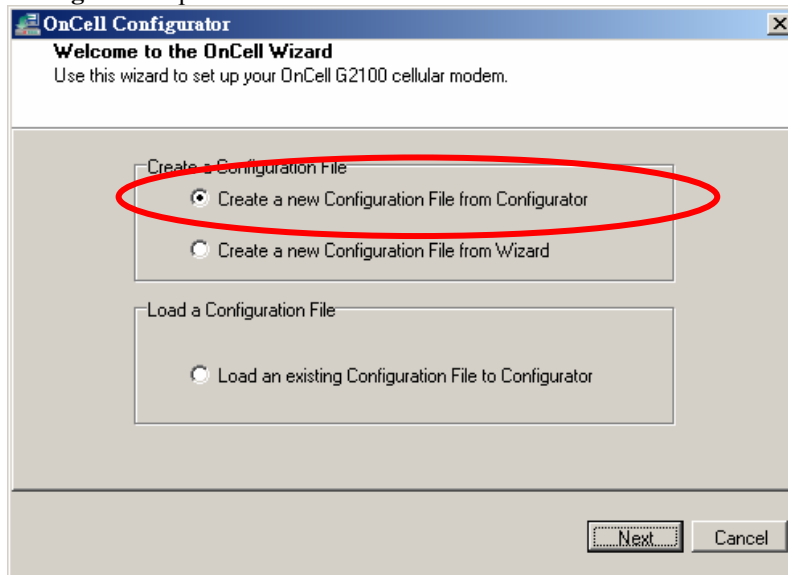



- 3. Click **Apply**.

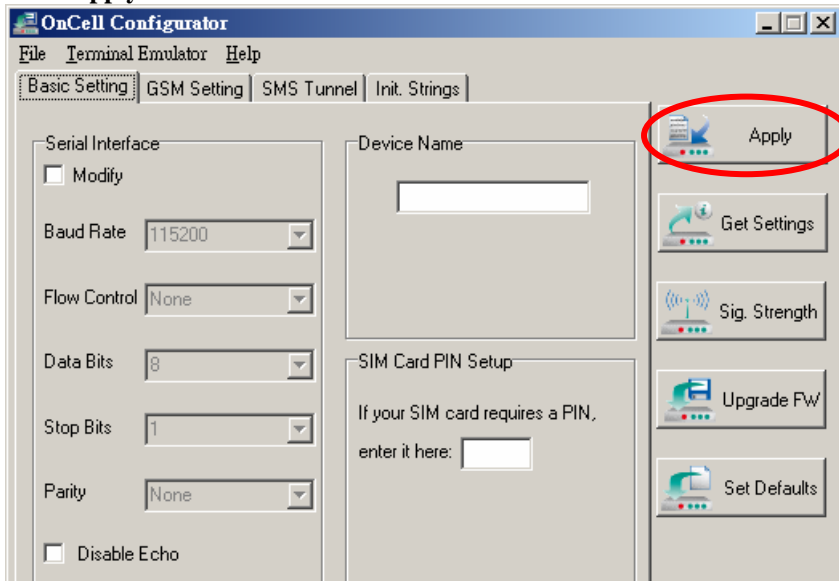

- 4. Select the appropriate COM port and communication parameters for connecting to the modem. Click **OK** to proceed.

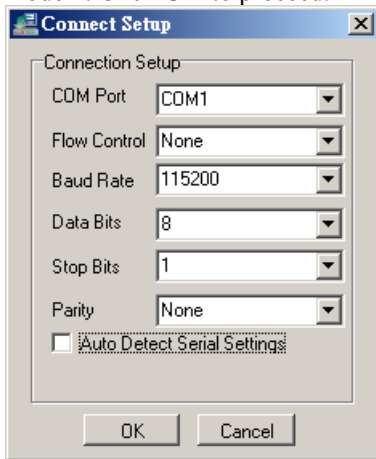

**ATTENTION**

If you are not sure which communication parameters you should use, please select the **Auto Detect Serial Settings** option and follow the onscreen instructions. The procedure may take few minutes to complete. When using the **Auto Detect Serial Settings** function, if the **GSM** or the **GPRS** LED is **ON** or blinking, you must remove the SIM card, or use the escape command (+++) on the terminal to disconnect the current connection.

The default parameters are 115200, 8n1, and RTS/CTS flow control.

5. Wait a few moments for the settings to be applied. Click **OK** to finish.

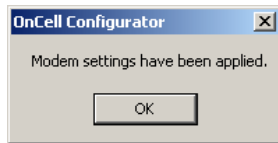
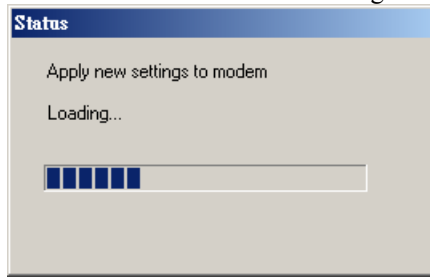

## Retrieving the Modem Settings

The following instructions illustrate how to use Configurator to get the current settings of an OnCell G2100 Series modem.

1. Connect the RS-232 port of the OnCell G2100 Series modem to a host PC. On the OnCell G2150I, make sure the RS-232 port is connected and DIP switch 1 is set to ON.



### ATTENTION

The RS-232 connector uses the standard pinouts. A direct male DB9 to female DB9 cable, such as Moxa's CBL-F9M9-150 (100 cm) or CBL-F9M9-20 (20 cm), can be used to connect to a PC's serial port. If you use a USB-to-serial product to configure the OnCell G2100 Series modem, we strongly recommend using Moxa's **UPort 1110**. Other USB-to-serial products may cause unexpected errors when configuring the OnCell G2100 Series modem.

2. Start OnCell Configurator and select the **Create a new Configuration File from Configurator** option.

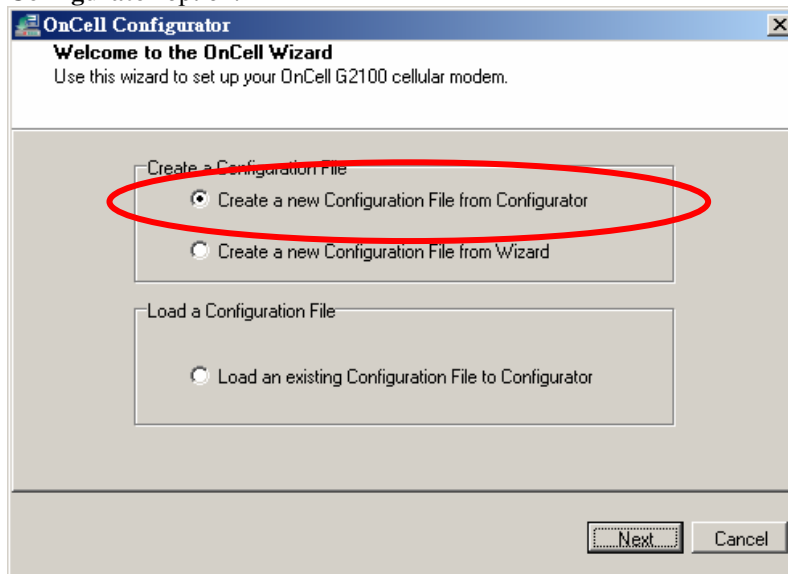

- 3. Click the **Get Settings** button on the right side of the window.

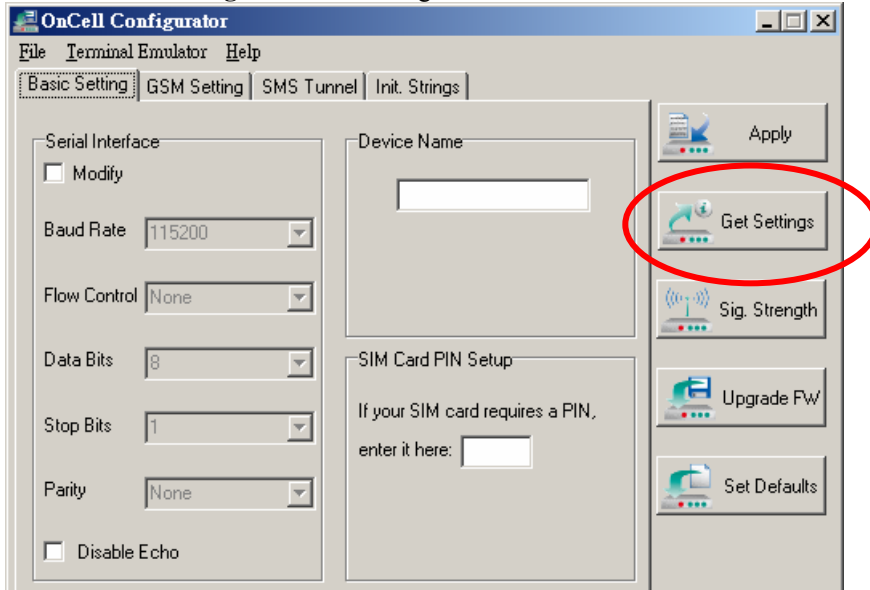

- 4. Select the appropriate COM port and communication parameters for connecting to the modem. Click **OK** to proceed.

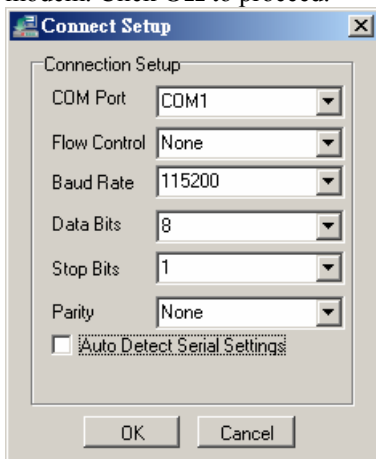

**ATTENTION**

If you are not sure which communication parameters you should use, please select the **Auto Detect Serial Settings** option and follow the onscreen instructions. The procedure may take few minutes to complete. When using the **Auto Detect Serial Settings** function, if the **GSM** or the **GPRS** LED is **ON** or blinking, you must remove the SIM card, or use the escape command (+++) on the terminal to disconnect the current connection.

The default parameters are 115200, 8n1, and RTS/CTS flow control.

- Wait a few moments for the settings to be retrieved. Click **OK** when prompted.

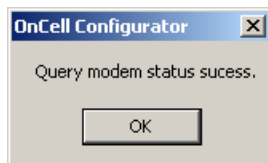
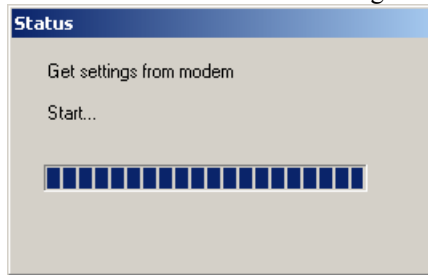

- The settings will be displayed in the **Configurator** window. The current firmware version will also be displayed.

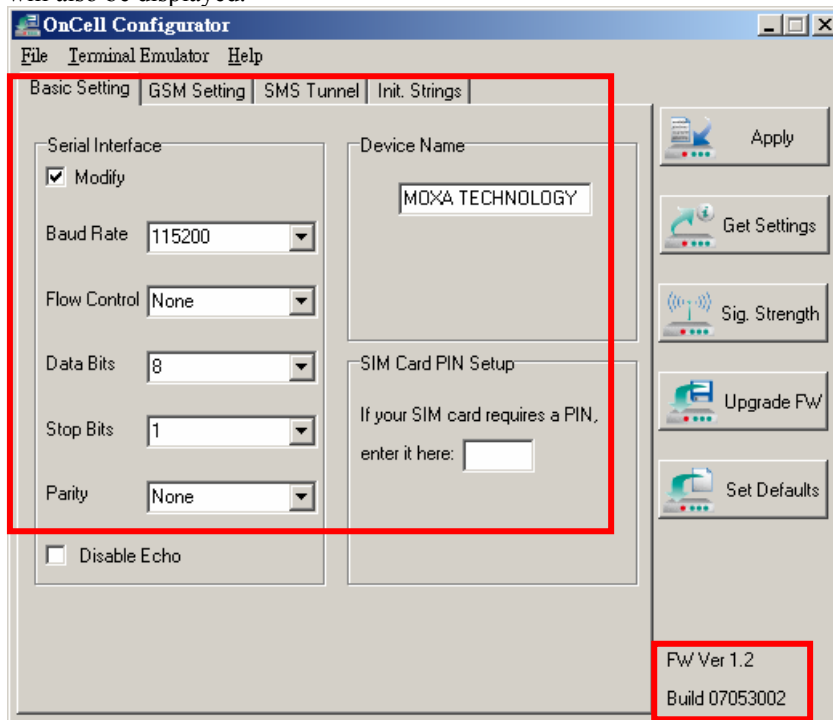

## Loading a Profile

The following instructions illustrate how to load a profile using **Configurator**.

1. Connect the RS-232 port of the OnCell G2100 Series modem to a host PC. On the OnCell G2150I, make sure the RS-232 port is connected and DIP switch 1 is set to ON.
2. Start OnCell Configurator and select the **Create a new Configuration File from Configurator** option.

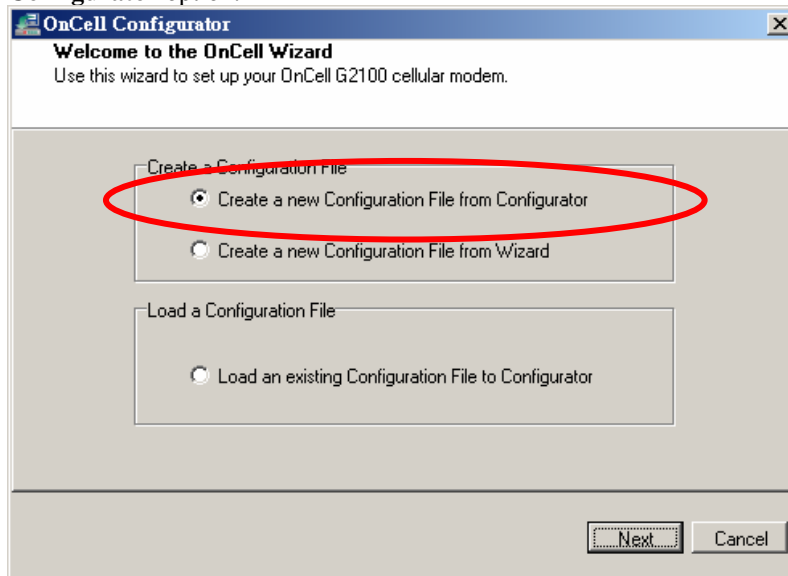

3. In the **File** menu, select **Load File from...**

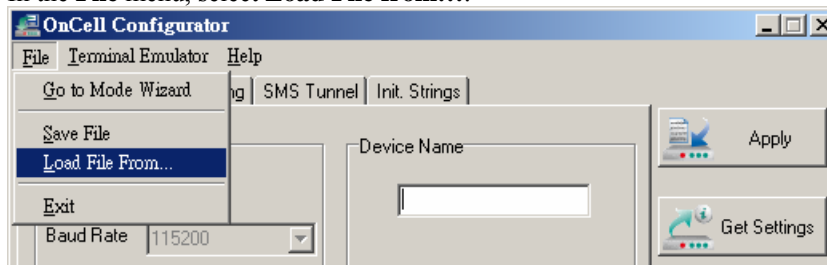

4. Select a folder and profile and click **Open**.

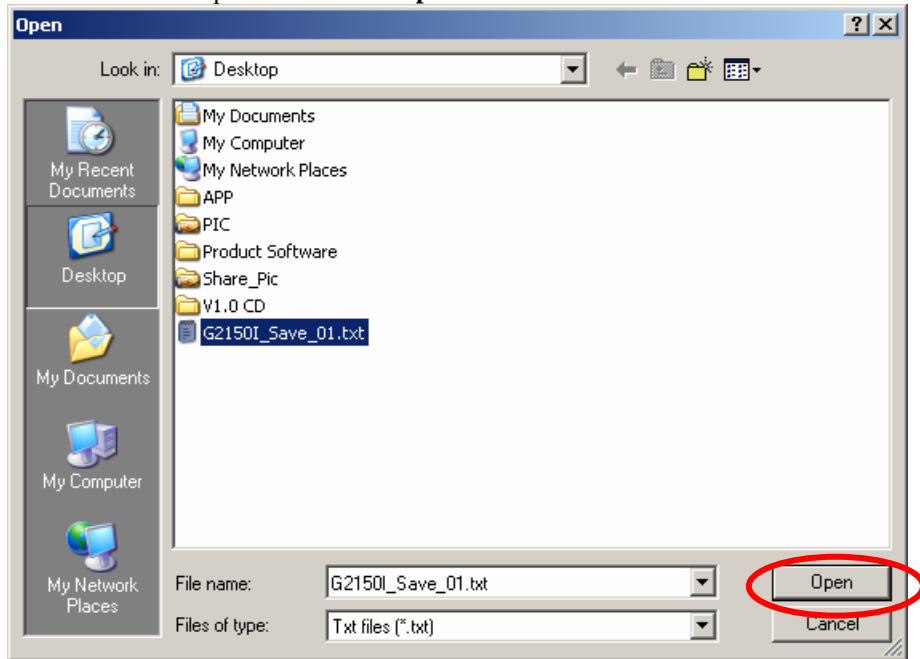

5. The modem configuration stored in the profile will be displayed in **Configurator**.

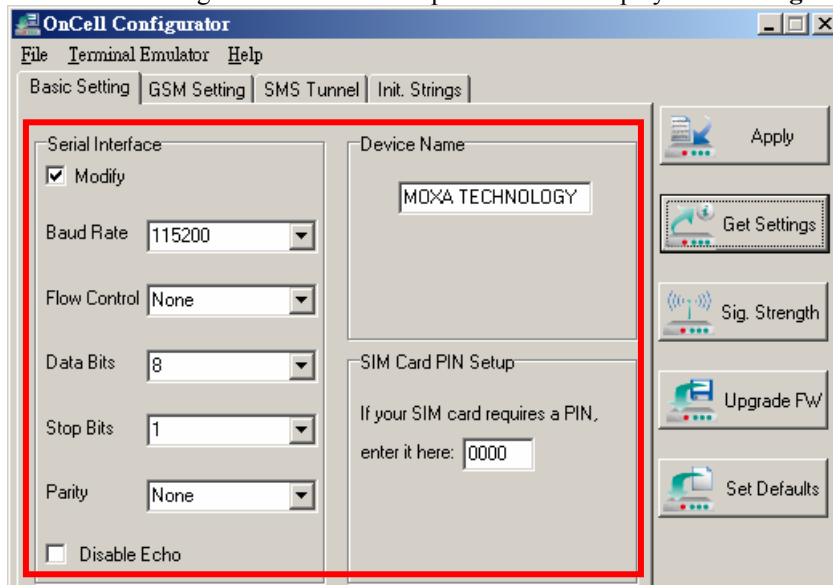

The following instructions illustrate how to load a profile using the **Wizard**.

1. Connect the RS-232 port of the OnCell G2100 Series modem to a host PC. On the OnCell G2150I, make sure the RS-232 port is connected and DIP switch 1 is set to ON.

2. Start OnCell Configurator and select the **Load an existing Configuration file to Configurator** option.

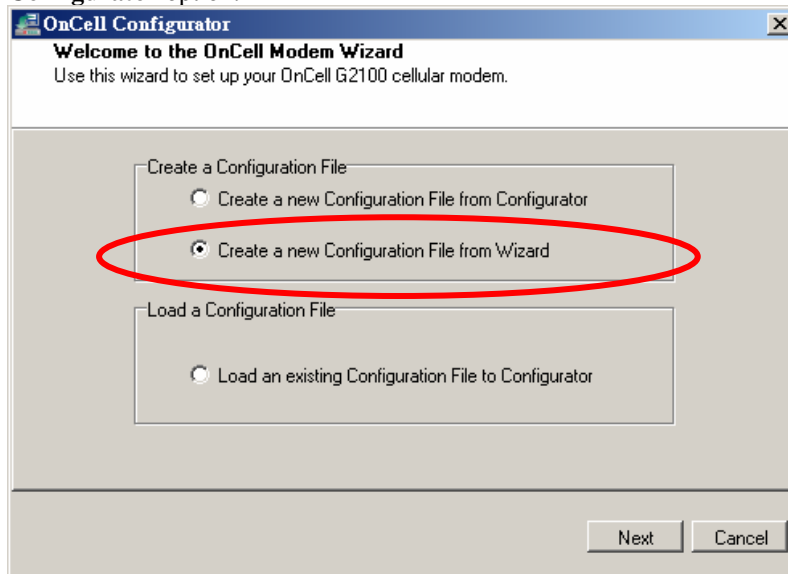

3. Select a folder and profile and click **Open**.

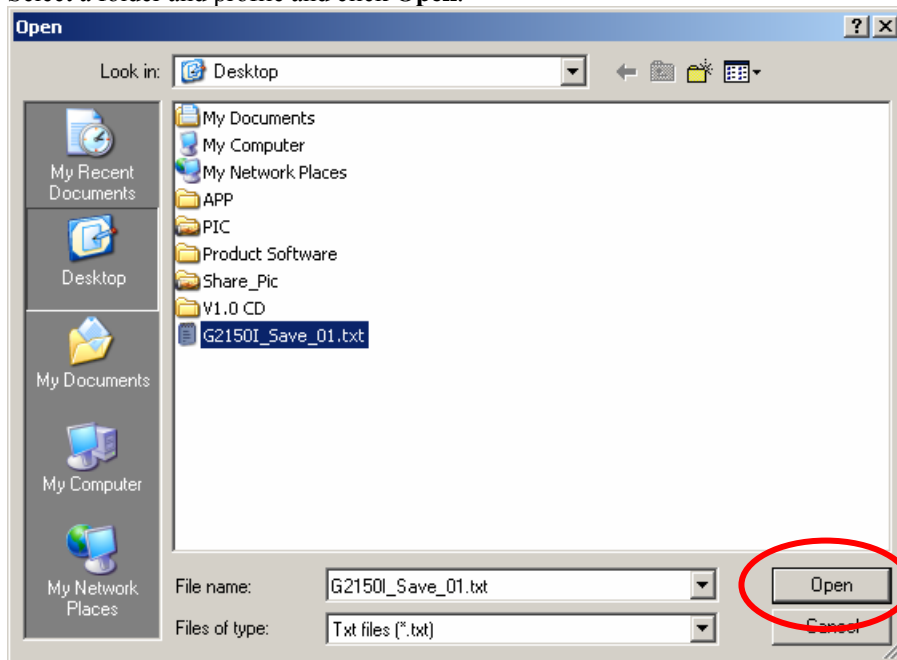



- 4. The modem configuration stored in the profile will be displayed in **Configurator**.

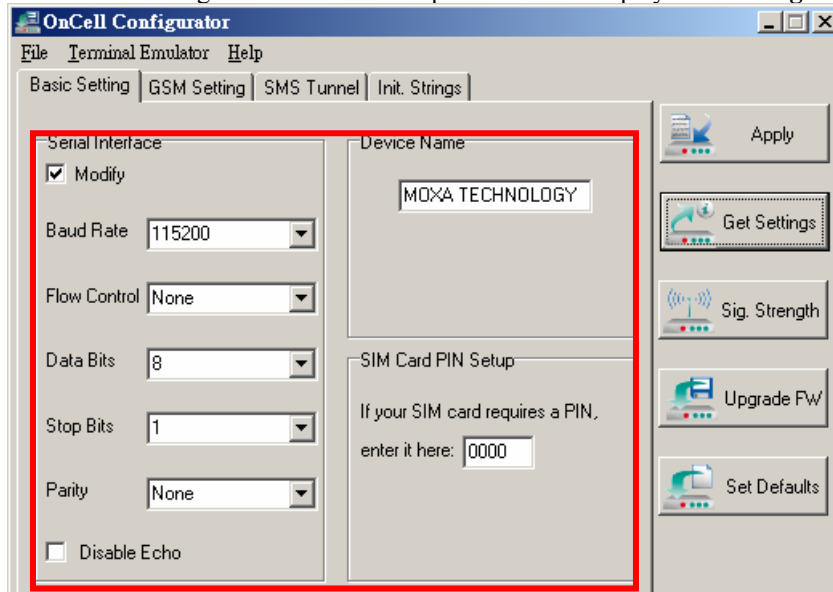

## Signal Strength Monitor

The following instructions illustrate how to configure the serial communication parameters using **Configurator**.

1. Connect the RS-232 port of the OnCell G2100 Series modem to a host PC. On the OnCell G2150I, make sure the RS-232 port is connected and DIP switch 1 is set to ON.



### ATTENTION

The RS-232 connector uses the standard pinouts. A direct male DB9 to female DB9 cable, such as Moxa's CBL-F9M9-150 (100 cm) or CBL-F9M9-20 (20 cm), can be used to connect to a PC's serial port. If you use a USB-to-serial product to configure the OnCell G2100 Series modem, we strongly recommend using Moxa's **UPort 1110**. Other USB-to-serial products may cause unexpected errors when configuring the OnCell G2100 Series modem.

2. Start OnCell Configurator and select the **Create a new Configuration File from Configurator** option.

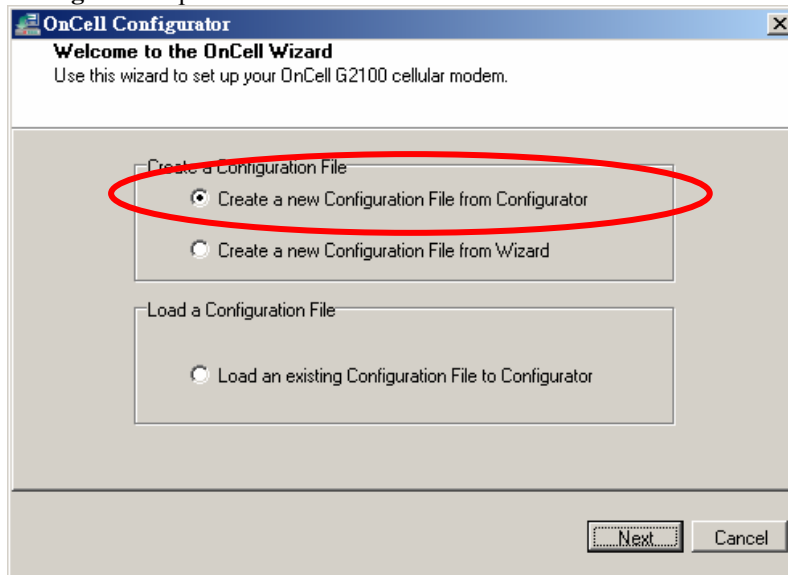

- 3. Click the **Sig. Strength** button on the right side of the window.

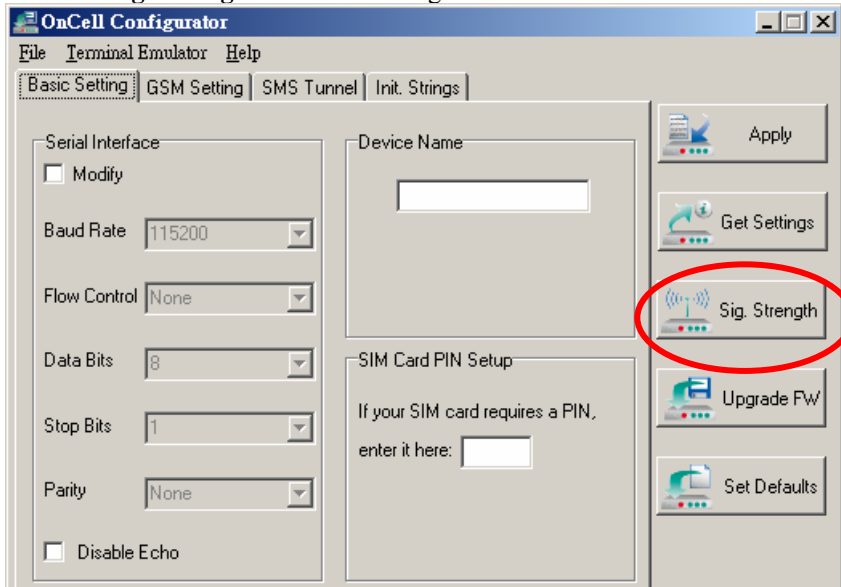

- 4. Select the appropriate COM port and communication parameters for connecting to the modem and click **OK** to proceed.

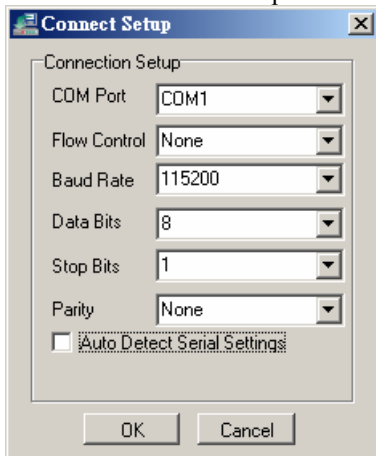

**ATTENTION**

If you are not sure which communication parameters you should use, please select the **Auto Detect Serial Settings** option and follow the onscreen instructions. The procedure may take few minutes to complete. When using the **Auto Detect Serial Settings** function, if the **GSM** or the **GPRS** LED is **ON** or blinking, you must remove the SIM card, or use the escape command (+++) on the terminal to disconnect the current connection.

The default parameters are 115200, 8n1, and RTS/CTS flow control.

- Wait a few moments for the signal strength and the carrier information to be queried. Click **OK** to finish.

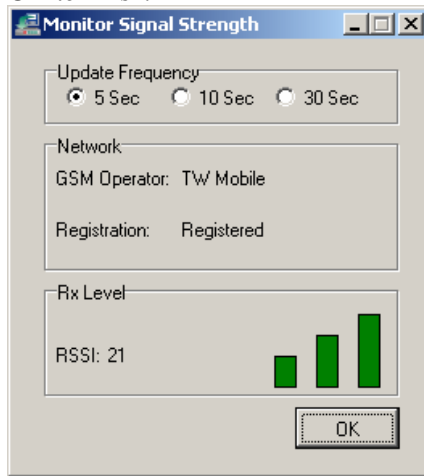

Signal Strength Indicator	Description
None	No signal, or SIM card is not installed properly
1 bar	Weak or insufficient (SMS only)
2 bars	Average (good for GSM CSD and GPRS connections)
3 bars	Exceptional (good for GSM CSD and GPRS connections)

## Upgrading the Firmware

The following instructions illustrate how to use Configurator to upgrade the firmware of an OnCell G2100 Series.

- Connect the RS-232 port of the OnCell G2100 Series modem to a host PC. On the OnCell G2150I, make sure the RS-232 port is connected and DIP switch 1 is set to ON.



### ATTENTION

The RS-232 connector uses the standard pinouts. A direct male DB9 to female DB9 cable, such as Moxa's CBL-F9M9-150 (100 cm) or CBL-F9M9-20 (20 cm), can be used to connect to a PC's serial port. If you use a USB-to-serial product to configure the OnCell G2100 Series modem, we strongly recommend using Moxa's UPort 1110. Other USB-to-serial products may cause unexpected errors when configuring the OnCell G2100 Series modem.

- 2. Start OnCell Configurator and select **Create a new Configuration File from Configurator**.

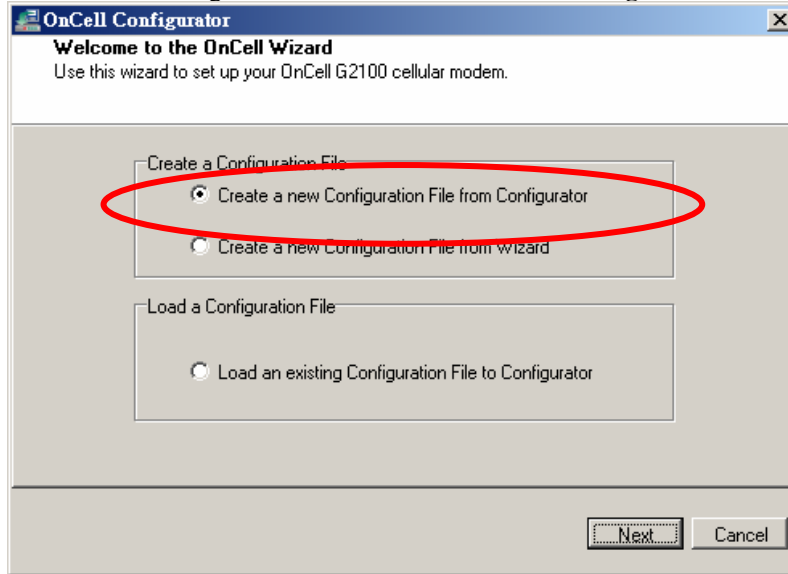

- 3. Click **Upgrade FW** on the right side of the window.

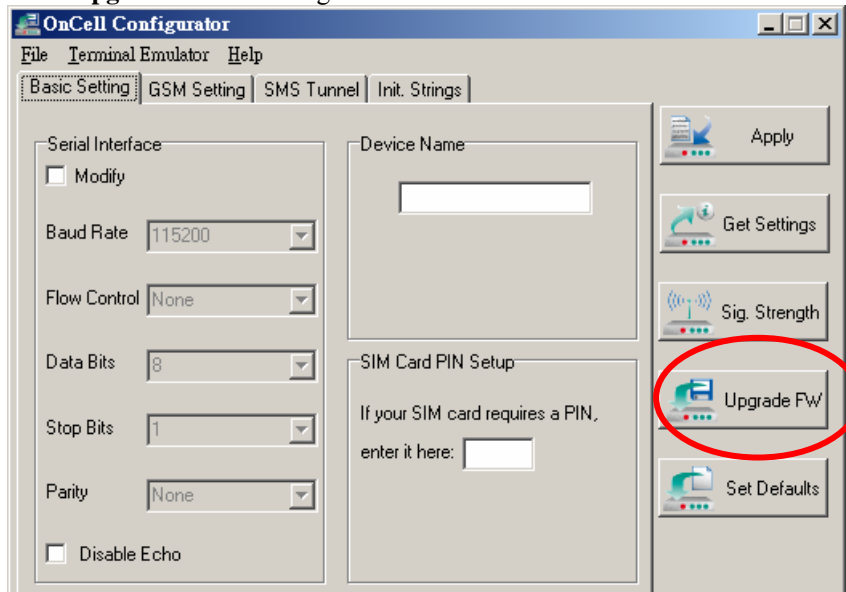

- 4. Upgrading the firmware will clear all current configuration settings in the OnCell G2100 Series modem. To exit and save the current settings, click **NO**. To proceed, click **Yes**.

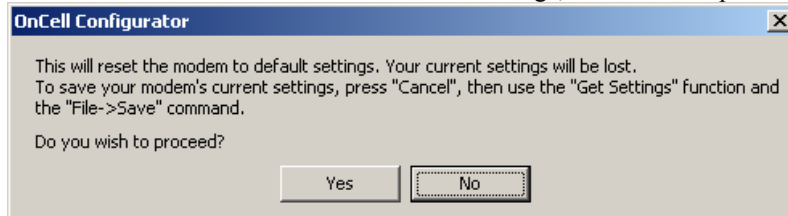

- 5. Select a firmware file from the disk and click **Open** to proceed.

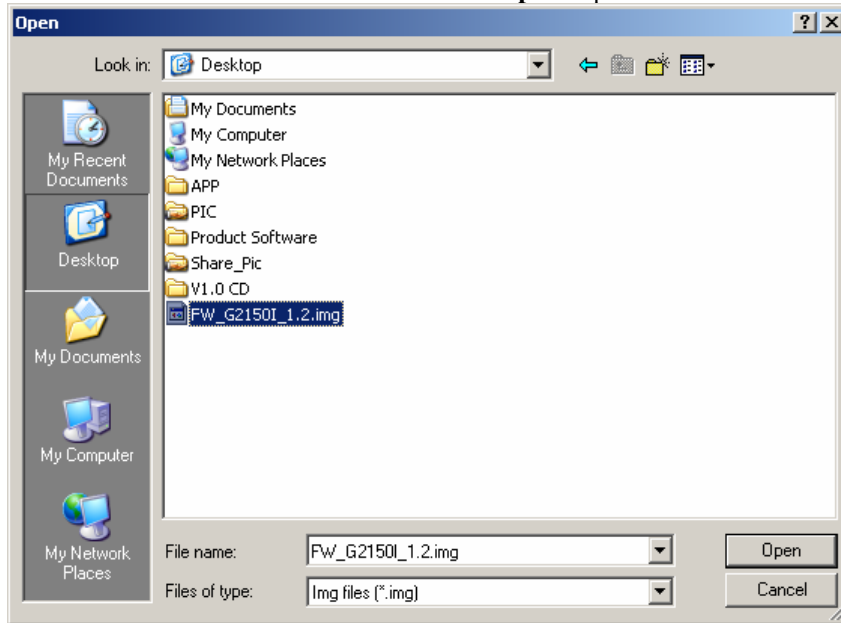

**ATTENTION**

Be sure to use the right firmware image file for your model. The OnCell G2110 and OnCell G2110-T both use the same firmware image file. The OnCell G2150I uses a different firmware image file.

- 6. Select the appropriate COM port and communication parameters for connecting to the modem. Click **OK** to proceed.

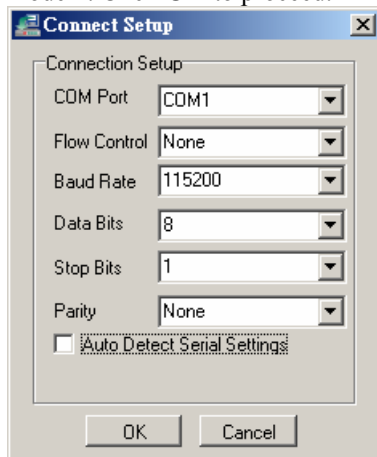

**ATTENTION**

If you are not sure which communication parameters you should use, please select the **Auto Detect Serial Settings** option and follow the onscreen instructions. The procedure may take few minutes to complete. When using the **Auto Detect Serial Settings** function, if the **GSM** or the **GPRS** LED is **ON** or blinking, you must remove the SIM card, or use the escape command (+++) on the terminal to disconnect the current connection.

The default parameters are 115200, 8n1, and RTS/CTS flow control.

7. Wait a few moments for the firmware to be downloaded to the OnCell G2100 Series modem.

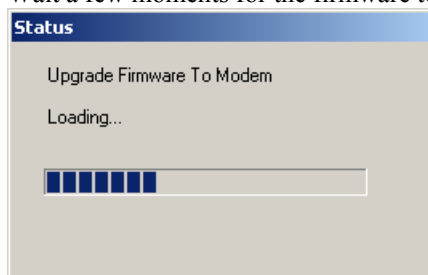

8. Click **OK** to finish.

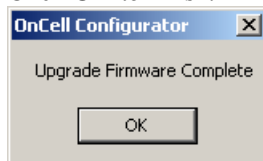

## Setting Modem Defaults

The following instructions illustrate how to use Configurator to load the factory default settings into the OnCell G2100 Series modem.

1. Connect the RS-232 port of the OnCell G2100 Series modem to a host PC. On the OnCell G2150I, make sure the RS-232 port is connected and DIP switch 1 is set to ON.



### ATTENTION

The RS-232 connector uses the standard pinouts. A direct male DB9 to female DB9 cable, such as Moxa's CBL-F9M9-150 (100 cm) or CBL-F9M9-20 (20 cm), can be used to connect to a PC's serial port. If you use a USB-to-serial product to configure the OnCell G2100 Series modem, we strongly recommend using Moxa's UPort 1110. Other USB-to-serial products may cause unexpected errors when configuring the OnCell G2100 Series modem.

2. Start OnCell Configurator and select the **Create a new Configuration File from Configurator** option.

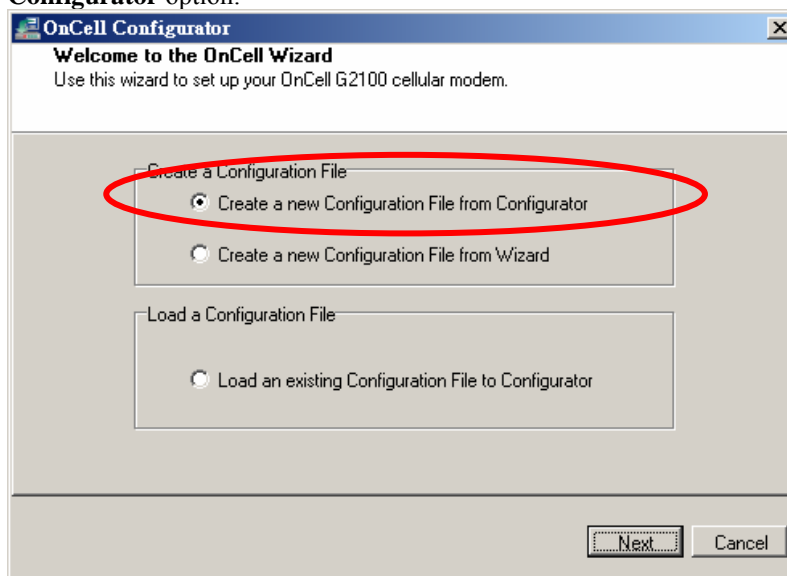



- 3. Click **Set Defaults** on the right side of the window.

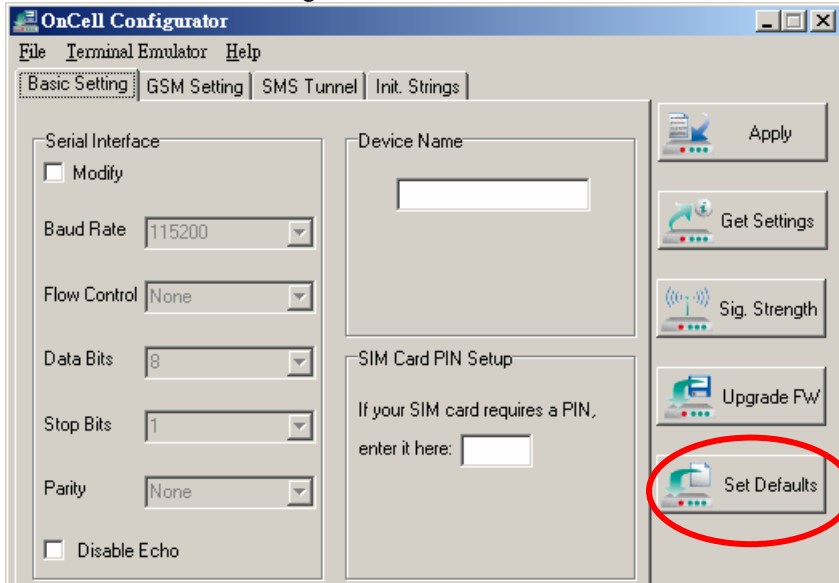

- 4. Select the appropriate COM port and communication parameters for connecting to the modem and click **OK** to proceed.

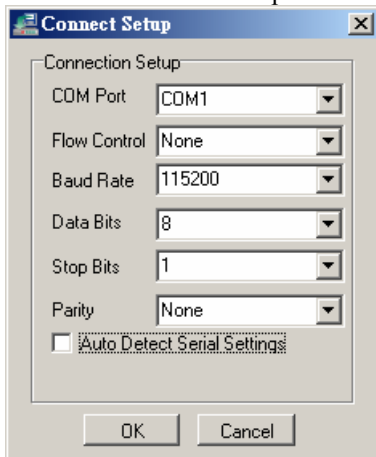

**ATTENTION**

If you are not sure which communication parameters you should use, please select the **Auto Detect Serial Settings** option and follow the onscreen instructions. The procedure may take few minutes to complete. When using the **Auto Detect Serial Settings** function, if the **GSM** or the **GPRS LED** is **ON** or blinking, you must remove the SIM card, or use the escape command (+++) on the terminal to disconnect the current connection.

The default parameters are 115200, 8n1, and RTS/CTS flow control.

- Wait a few seconds for the default settings to load and click **OK** to finish.

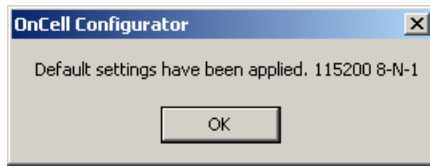
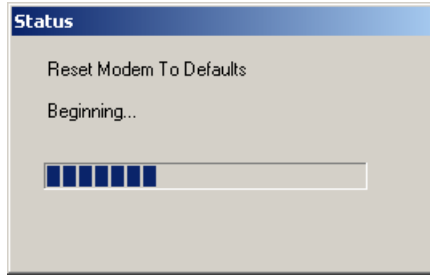

On recent hardware revisions of the OnCell G2100 Series modem, default settings can be restored using the reset button. Simply hold the RESET button down for 10 seconds and the modem will be reset to the factory default settings. This feature is implemented on the following model revisions and later: the OnCell G2150I Rev. 1.3, OnCell G2110 Rev 1.1, and OnCell G2110-T Rev. 1.1.

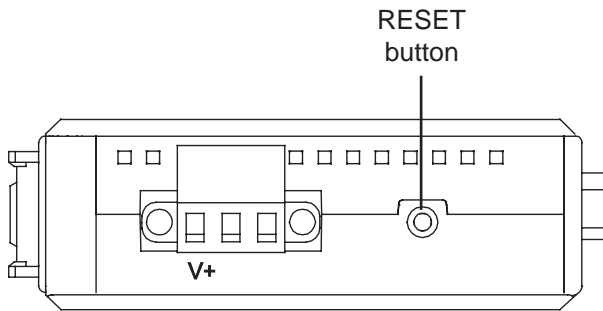

The RESET button performs different operations depending on how long it is held down, as follows:

Interval	Action
1 to 3 sec	Restart the system
3 to 10 sec	GSM/GPRS/SMS Tunnel stop running, PWR LED blinks
Over 10 sec	LEDs turn OFF and ON, factory default settings restored

The AT Command Set can be used to operate, configure and query the OnCell G2100 Series modem. This chapter includes information about the AT Command Set of the OnCell G2100 Series modem.

The following topics are covered in this chapter:

- AT Command Set Introduction**
- Starting Moxa Terminal Emulator**
- AT Command Examples**
- Radio Band Selection**
- PIN Code Management**
- Serial Line Settings**
- 2-wire RS-485 Communication (OnCell G2150I Only)**
- Additional Information**

## AT Command Set Introduction

The OnCell G2100 Series modem supports the V.25ter AT command set. The "AT" prefix (also known as the Attention Code) signals the modem that one or more commands are to follow. The AT command set is an industry-standard language that is used to communicate with modems. The OnCell G2100 Series modem is always either in command mode or in on-line mode. When first powered up, the modem will enter command mode. The modem will only accept commands when it is in command mode. Commands that are received when the modem is in on-line mode are treated as data, not as commands. Commands may be entered from terminal software such as Windows HyperTerminal, or Moxa PComm Lite Terminal Emulator.

Settings made with AT commands are automatically reused by the modem until another command is received to change the settings, or the modem is turned off.

All but two of the commands must begin with the characters AT. The two exceptions are the escape sequence (+++), and the repeat command (A/). The command line prefix (letters AT) and the command sequences that follow can be entered in upper case or lower case, but the cases must not be mixed. More than one command can be typed on one line, and commands can be separated by spaces to make them easier to read. The spaces are ignored by the modem's command interpreter. The command line buffer accepts up to 39 characters including, "A" and "T". Spaces, carriage returns, and line feed characters are not placed in the buffer and do not count towards the 39-character limit. If more than 39 characters are entered, or if a syntax error is encountered in the command sequence, the modem returns an ERROR result code, and the command input is ignored.

The modem will acknowledge most commands almost immediately. As soon as you type in a command ending with the carriage return character, your modem will respond with OK.



### ATTENTION

+++

This is one of the two commands that do not use the AT prefix. The 3 "plus" signs are used for the Escape Character Sequence. After you have connected to another modem, you may need to return to command mode to modify the modem's configuration or to hang up. To do this, leave your keyboard idle (do not press any keys) for at least one second, and then press "+" three times. You do not need to press the Enter key. After a moment, the modem will respond with OK, indicating that Command mode is now active.

## Starting Moxa Terminal Emulator

The following instructions explain how to install the Moxa PComm Lite Package. After installing PComm Lite, you can use the built-in Moxa Terminal Emulator to handle your modem operations.



### ATTENTION

OnCell Terminal Emulator is designed for Windows 2000, XP, 2003, and Vista. If you are running Windows 98, ME, or NT, use PComm Lite V2.6, which can be downloaded on the Moxa website.

1. Terminal Emulator is installed with OnCell Configurator. Please refer to Chapter 3 for details.
2. Start Terminal Emulator from the Windows Start menu.

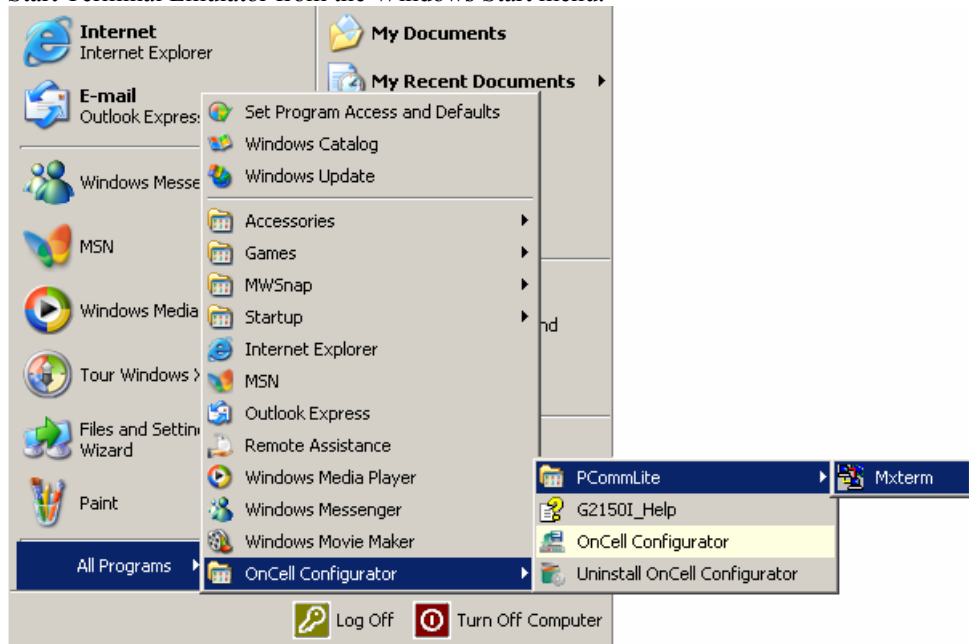

3. The PComm Terminal Emulator user interface will appear. Click the **Open** button, which is the first blue icon on the tool bar.

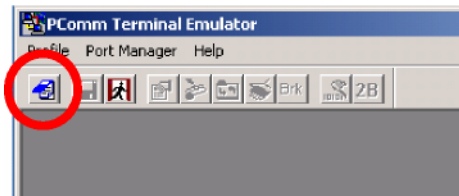

- 4. Select the target COM port and communication parameters. Click **OK** to open the port.

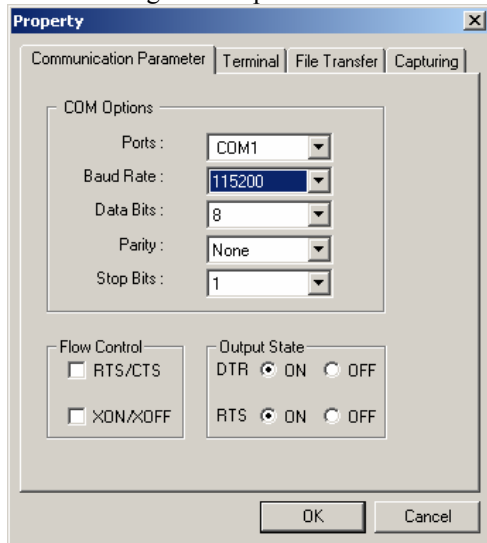

- 5. Terminal Emulator will connect to the target COM port.

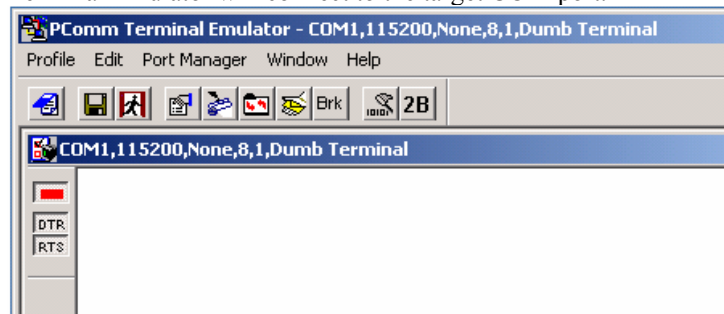

## AT Command Examples

The following examples can give users a better understanding of how to use the AT Commands.



### ATTENTION

Make sure that the RS-232 port of the OnCell G2100 Series modem is connected. For the OnCell G2150I, make sure DIP switch 1 is set to **ON**.

## Modem Acknowledgement

Connect the RS-232 port of the OnCell G2100 Series modem to a host PC. Start PComm Terminal Emulator with the current communication parameters (default: 115200 bps, 8 data bits, None parity, 1 stop bits, and no flow control). Type **AT** and press **Enter**. A modem response of **OK** indicates that the modem is ready.

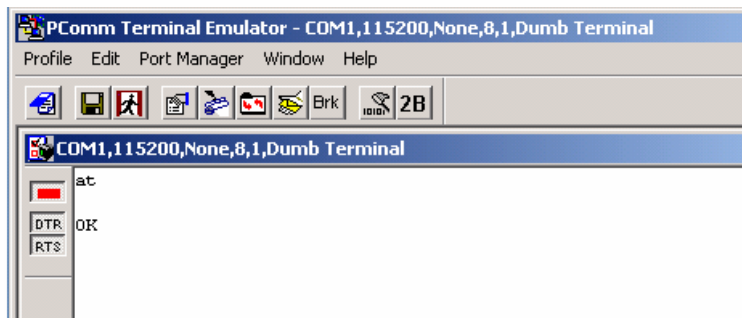

## Verify Signal Strength

Connect the RS-232 port of the OnCell G2100 Series modem to a host PC. Open PComm Terminal Emulator with the current communication parameters (default: 115200 bps, 8 data bits, None parity, 1 stop bits, and no flow control). Type **AT+CSQ** and press **Enter**. The modem will respond with the receive signal strength (RSSI) and channel bit error rate (BER).

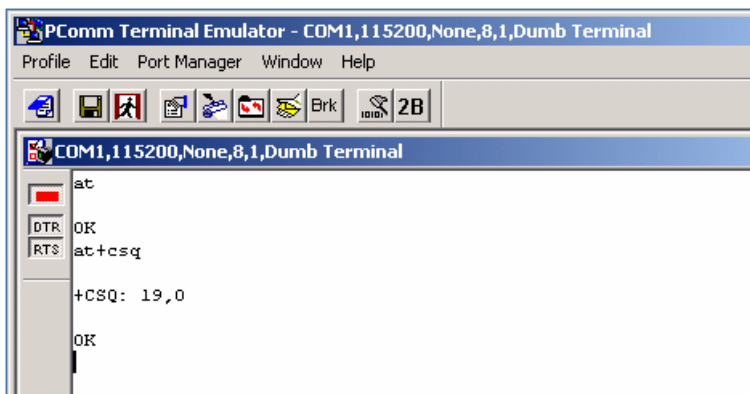

Signal Strength Verification	
0 to 12	Weak or insufficient
13 to 19	Average
20 to 31	Exceptional
99	No signal

BER ranges from 0 to 7, with 7 corresponding to a higher error rate.



#### ATTENTION

RSSI should be higher than 12 if you wish to create or accept GSM/CSD data calls or establish a GPRS connection. If the RSSI is less than 12, you will only be able to transmit and receive SMS (short message).

Another way to verify RSSI is to check the "SIGNAL" LEDs on the front panel. See Chapter 2 for more information.

## Radio Band Selection

Although GSM-900 and GSM-1800 are used in most parts of the world, operators in United States, Canada, and many other countries in the Americas use GSM-850 or GSM-1900. A quad-band industrial cellular modem such as the OnCell G2100 Series modem makes it relatively easy to prepare the product for shipment to different parts of the world.

The GSM/GPRS band of OnCell G2100 Series is configured to 900/1800 MHz by default. For users NOT in this service area, follow the instructions below to set up the correct radio bands.



#### ATTENTION

The following procedures can also be carried out using OnCell Configurator

1. Connect the RS-232 port of the OnCell G2100 Series modem to a host PC. Start PComm Terminal Emulator using the current communication parameters (default: 115200 bps, 8 data bits, None parity, 1 stop bits, and no flow control).
2. Type **AT+WMBS=x**, where x represents one of the band selections shown in the following table, and then press **Enter**.

Radio Band Selection	
0	Mono-band, 850 MHz
1	Mono-band, 900 MHz
2	Mono-band, 1800 MHz
3	Mono-band, 1900 MHz
4	Dual-band, 850/1900 MHz
*5	Dual-band, 900/1800MHz (default)
6	Dual-band, 900/1900MHz



For example, users in North America would type the following:

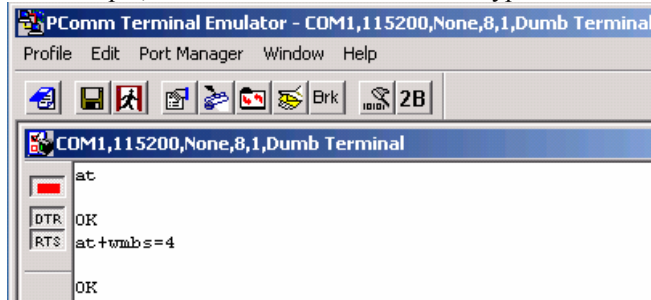

## PIN Code Management

Operation of the OnCell G2100 Series modem requires the installation of an active SIM (Subscriber Identity Module) card. The SIM card contains the necessary data to identify the modem to the network service provider. It is also used to store the GSM/GPRS modem PIN (Personal Identification Number.) and PUK (Personal Unblocking Key), which are also used with mobile phones. The PIN helps prevent unauthorized persons from using the mobile devices. Users must enter the PIN each time the modem is powered up. The PUK is used to unlock a SIM card when an incorrect PIN code has been entered three times.

### Query the Current PIN Status

1. Connect the RS-232 port of the OnCell G2100 Series modem to a host PC. Start PComm Terminal Emulator with the current communication parameters (default: 115200 bps, 8 data bits, None parity, 1 stop bit, and no flow control.)
2. Type **AT+CPIN?** and press **Enter**.

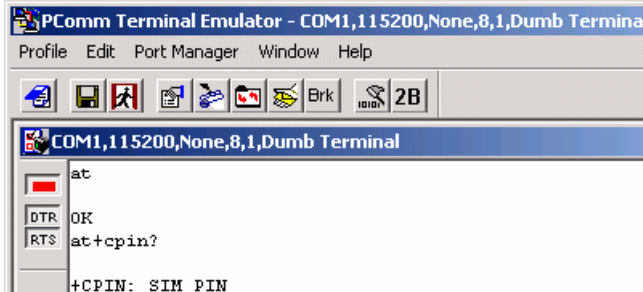

If the OnCell G2100 Series modem responds with “+CPIN: SIM PIN” then the user must enter the SIM’s PIN code.

AT+CPIN? responses	
+CPIN: READY	Modem is not pending for any password
+CPIN: SIM PIN	PIN1 is required
+CPIN: SIM PUK	PUK1 is required

If the OnCell G2100 Series modem responds with “+CPIN: READY” then the SIM security is disabled, or the PIN for the SIM was entered correctly.

3. If the modem responds with **+CPIN: SIM PIN**, type **AT+CPIN=<pin>** where **<pin>** is the correct **PIN**. Press **Enter**. The following example shows "0000" being entered for the PIN.

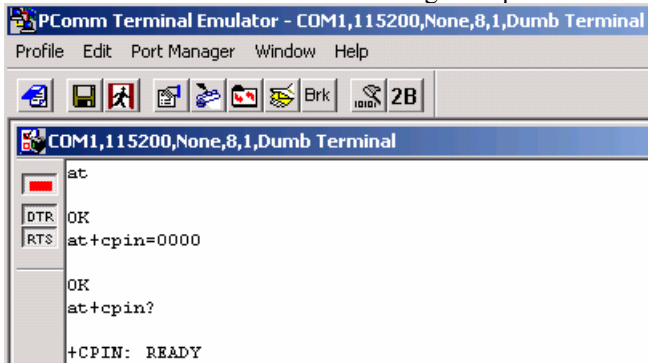

**ATTENTION**

Be careful when entering the PIN codes.

After 3 unsuccessful attempts at entering the PIN, you will need to use the PUK to proceed. PUK validation forces the user to enter a new PIN code as a second parameter, and this will be the new PIN code if PUK validation succeeds. CHV1 will be enabled if PUK1 is correct. Therefore, the application uses the following command:

**AT+CPIN=<PUK>,<NewPIN>**

Note that users must apply for PUK codes from the mobile service provider.

### Disable the Facility Lock

Disabling the facility lock will allow the OnCell G2100 Series modem to operate without entering the PIN code each time the modem is powered up.

1. Type **AT+CPIN=<pin>** where **<pin>** is the correct PIN. Press **Enter**.
2. Type **AT+CLCK="SC",0,<pin>** where SC should be capitals and **<pin>** is the correct PIN. The following example shows "0000" being entered for the PIN:

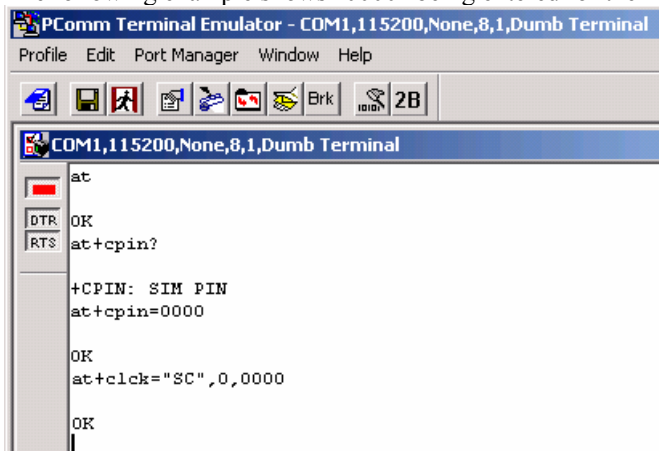

- To enable the facility lock, type **AT+CLCK="SC",1,<pin>**  
The following example shows "0000" being used for the PIN.

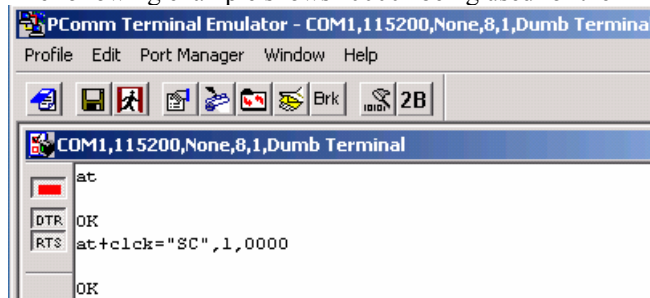

The screenshot shows a window titled "PComm Terminal Emulator - COM1,115200,None,8,1,Dumb Terminal". The window has a menu bar with "Profile", "Edit", "Port Manager", "Window", and "Help". Below the menu bar is a toolbar with various icons, including a red "Brk" button and a "2B" button. The main terminal area shows the following text:

```
at
DTR OK
RTS at+clck="SC",1,0000
OK
```



#### ATTENTION

Once the correct PIN is entered, the system (firmware V1.2 or above) will activate the **Automatic PIN Entry** function. This function will store the current PIN in its memory and enter it into the OnCell G2100 Series modem each time the system boots up. If the SIM card does not match the current PIN, the **Automatic PIN Entry** function will be deactivated.

To activate the **Automatic PIN Entry** function again, use the **AT+ CPIN** command or OnCell Configurator to enter the correct PIN.

To disable **Automatic PIN Entry** once and for all, use the **AT\*USEPIN=0** command.

## Serial Line Settings



### ATTENTION

Changes to the serial communication parameters take effect immediately. You will need to update your terminal settings to match any changes in the serial communication parameters.

Configuration can also be performed with the **AT\*SERIAL** command or **OnCell Configurator**.

The default serial communication parameters are **115200 bps, 8 data bits, None parity, RTS/CTS flow control, and 1 stop bit**. Before changing the settings, first connect the RS-232 port of the OnCell G2100 Series modem to a host PC. Open PComm Terminal Emulator with the current communication parameters.

### Modifying Baudrate

1. Type **AT+IPR=x** and press **Enter**, where x corresponds to one of the following baudrates: **300, 600, 1200, 2400, 4800, 9600, 19200, 38400, 57600, 115200, 0 (autobauding)**. For example, type **AT+IPR=9600** to change the baudrate to **9600** bps:

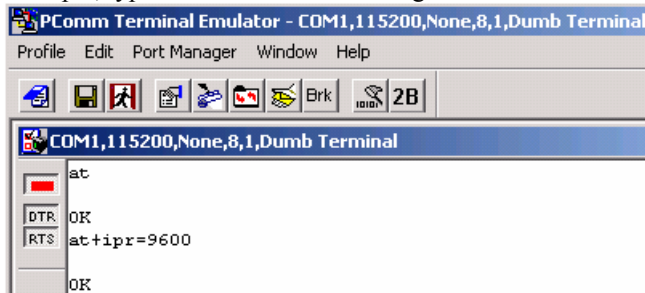

2. Modify the terminal settings to match the new serial communication parameters.

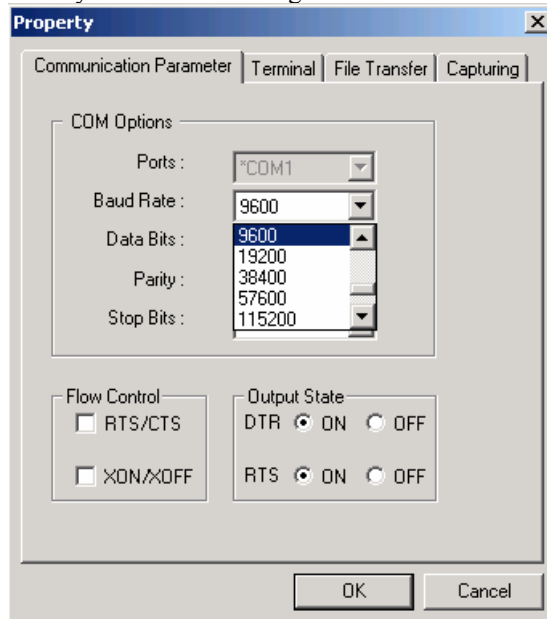

3. Type **AT&W** and press **Enter** to save the settings.

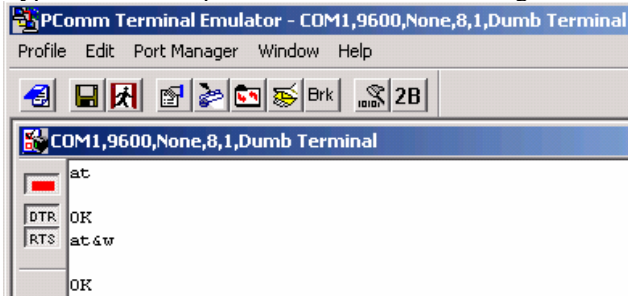

### Modifying Data Bits and Parity

1. Type **AT+ICF=x,y** and press **Enter**, where **x** and **y** correspond to the following parameters.

x = Data bits/ stop bits	1	8 data bits, 2 stop bits
	2	8 data bits, 1 parity, 1 stop bit
	3	8 data bits, 1 stop (default)
	4	7 data bits, 2 stop bits
	5	7 data bits, 1 parity, 1 stop bit
	6	7 data bits, 1 stop bit
y = Parity	0	Odd parity
	1	Even parity
	2	Mark parity
	3	Space parity
	4	None parity (default)

For example, type **AT+ICF=5,1** to change the parameters from **8n1** to **e71**:

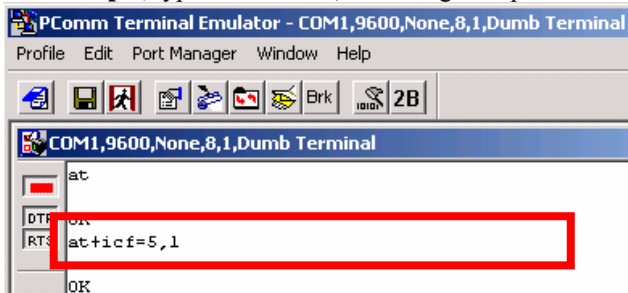

2. Modify the terminal settings to match the new serial communication parameters.

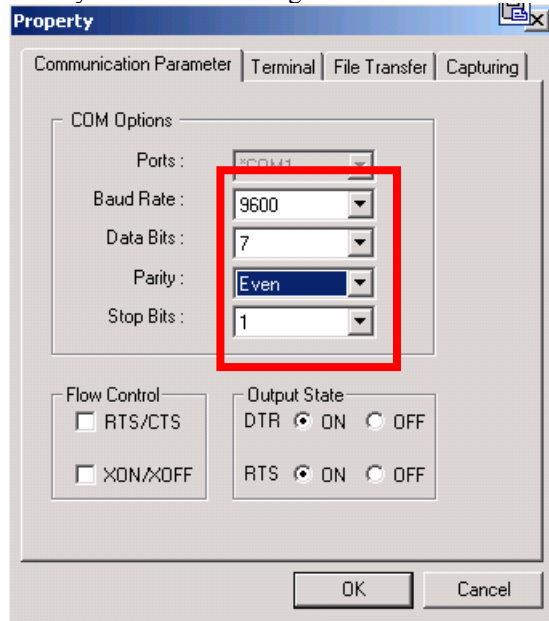

3. Type **AT&W** and press **Enter** to save the settings.

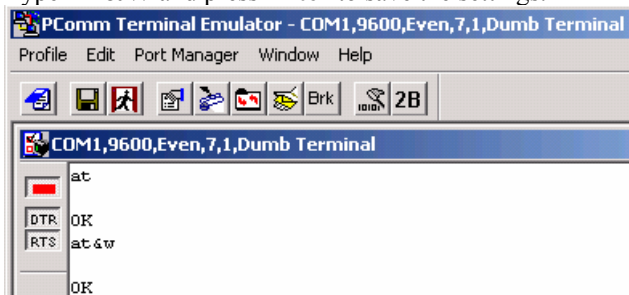

**ATTENTION**

Changes to the serial communication parameters take effect immediately. You will need to update your terminal settings to match any changes in the serial communication parameters.

**Autobauding** and +++ escape command only work with 8n1 or e71 settings. Using other settings will disable these functions.

2 stop bits are only allowed with None parity.

## Flow Control

The default RTS/CTS flow control setting is **none**. Follow these steps to enable flow control:

1. Type **AT+ICF=2,2** and press **Enter**. To disable flow control again, type **AT+ICF=0,0** and press **Enter**.

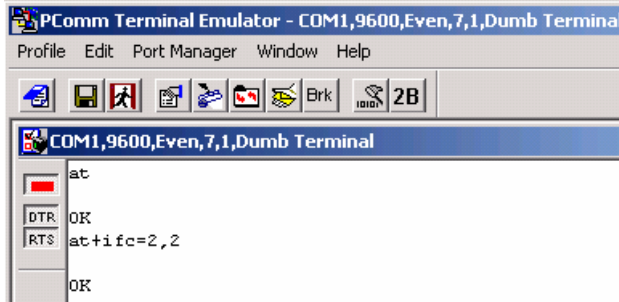

2. Type **AT&W** and press **Enter** to save the settings.



### ATTENTION

Changes to the serial communication parameters take effect immediately. You will need to update your terminal settings to match any changes in the serial communication parameters.

XON/XOFF flow control is not supported.

## 2-wire RS-485 Communication (OnCell G2150I Only)

2-wire RS-485 is half-duplex communication. For this reason, the modem's local echo should be disabled. Follow these steps to disable local echo:



### ATTENTION

The local echo function can also be disabled using **OnCell Configurator**.

1. On the bottom of the modem, set DIP switch 1 to **ON**.
2. Connect the modem's RS-232 port to a host PC. Start PComm Terminal Emulator with the current communication parameters (default: 115200 bps, 8 data bits, None parity, 1 stop bits).
3. Type **ATE0** and press **Enter** to disable the local echo.

- Type **AT&W** and press **Enter** to save the settings. Note that because the local echo is disabled, users will not see any response from the modem at the terminal screen.

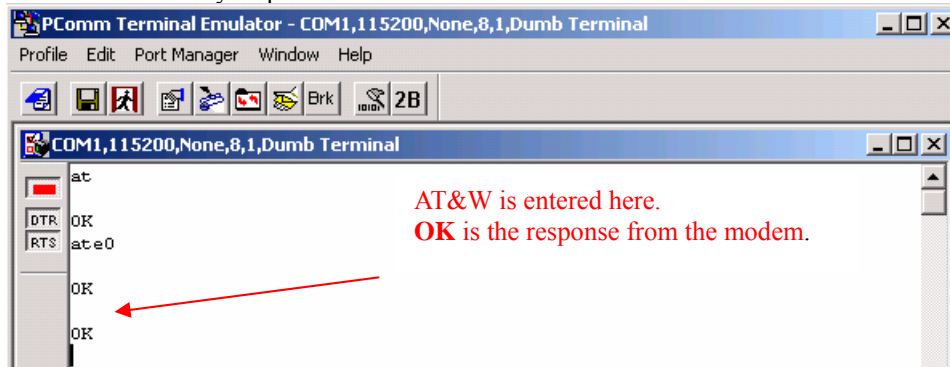

- On the bottom of the modem, set DIP switch 1 to **OFF**, DIP switch 2 to **ON**, and DIP switch 3 to **ON**. This configures the modem for 2-wire RS-485 communication.

## Additional Information

- **V.25ter recommendation**  
Commands that are not listed in the **OnCell G2100 Series AT Commands Guide** (on the Document and Software CD) are not supported. For commands that are not supported, the OnCell G2100 Series modem will respond with "ERROR". Modulation control, error control, and data compression commands are not recognized. An "ERROR" string will be returned.
- **GSM 07.05 recommendation**  
07.05 commands that are not described in this manual will not be implemented. An "ERROR" string will be returned.
- **GSM 07.07 recommendation**  
07.07 commands that are not described in this manual will not be implemented. An "ERROR" string will be returned.
- The **ATQ1** command for "Result Code Suppression – not transmitted" is not supported.
- Moxa's proprietary AT commands are supported by firmware versions V1.2 and later. Please refer to the **OnCell G2100 Series AT Commands Guide** on the Document and Software CD for further information.



# 5

## GSM/CSD Connection

---

A Circuit-Switched Data Connection makes the wireless modem work in a manner similar to a regular analog modem. You must have CSD service in order to make a CSD call.

This chapter covers the following topics:

- Overview**
- Initiating a CSD Connection**
- Answering a CSD Connection**

## Overview

CSD (Circuit Switched Data) is the original form of data transmission developed for GSM systems. By using a single radio time slot, CSD is able to deliver 9.6 to 14.4 kbit/s data transmission to both the GSM network and PSTN switching subsystem through direct calls. Most of the time, it is initiated by standard AT commands. Using the modem to access remote devices by CSD is often more convenient than installing cables and data lines. Data collection and monitoring will be more flexible since CSD can be used for applications that are hard to wire or hard to access.

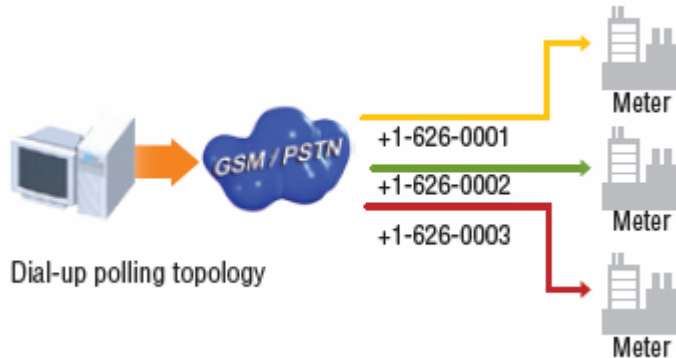

## Initiating a CSD Connection

A CSD connection can be initiated using the OnCell G2100 Series modem and PComm Terminal Emulator.

1. Start PComm Terminal Emulator with the current communication parameters default: 115200 bps, 8 data bits, None parity, 1 stop bit, and no flow control.

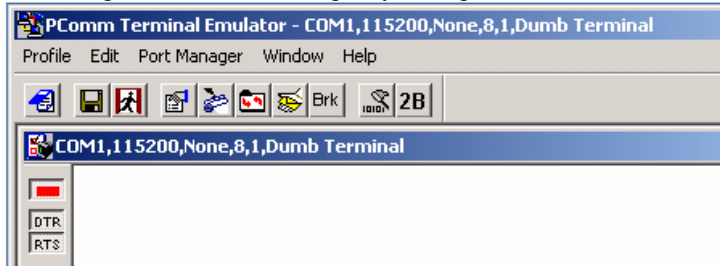

### ATTENTION

Check the “SIGNAL” LED indicators on the front panel of the OnCell G2100 Series modem. If the LEDs are all off, then the SIM card is not installed properly, or there is no signal present.

If only one LED is illuminated, then the signal is not strong enough to create a CSD connection. Adjust the position of the antenna, change the location of the modem, or use an optional high-gain antenna.

Verify that your SIM card has CSD service activated. For most regions, you must apply with your mobile service provider to receive this service.

Verify that the RS-232 port on the OnCell G2100 Series modem is connected. For the OnCell G2150I, verify that DIP switch 1 is set to **ON**.

2. Type **ATD** <phone number> and press **Enter**. For example, type **ATD 0289191230** if the phone number is 0289191230.
3. Check the GSM indicator on the front panel of the modem. If the LED is on and an amber color, the CSD connection has been established successfully. You can switch to data mode to proceed with data communication.
4. To close the CSD connection, type **+++**. The modem will respond with **OK** to indicate that you have already switched back to the command mode.
5. Type **ATH** and press **Enter** to disconnect.

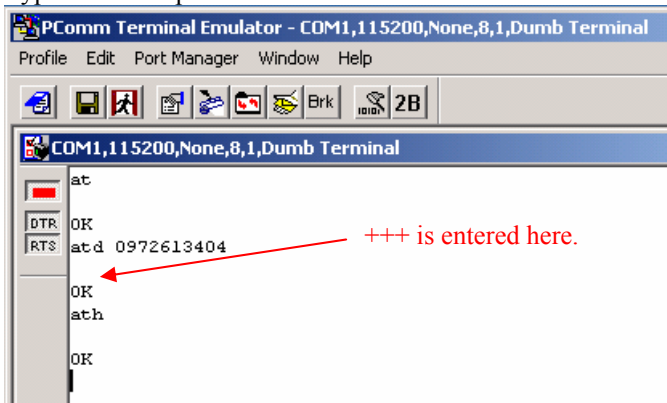

The screenshot shows a window titled "PComm Terminal Emulator - COM1,115200,None,8,1,Dumb Terminal". The window has a menu bar with "Profile", "Edit", "Port Manager", "Window", and "Help". Below the menu bar is a toolbar with various icons, including a modem icon and a "2B" indicator. The main terminal area shows the following text:

```
at
OK
DTR:
RTS: atd 0972613404
OK
ath
OK
```

A red arrow points to the "atd 0972613404" line, with the text "+++ is entered here." written in red next to it.

**ATTENTION**

+++ is the escape sequence, and **ATH** is the hang-up command.

For international calls, the local international prefix does not required, but the + character is. You would type **ATD+886289191230**.

## Answering a CSD Connection

PComm Terminal Emulator can be used to answer a CSD call manually:

1. When the terminal displays "RING", type **ATA** and press **Enter**.

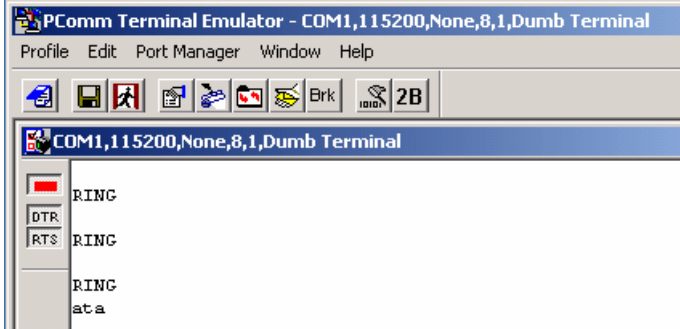

2. Check the GSM indicator on the front panel. If the LED is on and an amber color, the CSD connection has been established successfully. The modem will automatically switch to data mode. At this point, you can proceed with data communication.

PComm Terminal Emulator can be used to configure the modem to answer CSD calls automatically:

1. In the terminal window, type **ATS0=x** and press **Enter**. For **x**, substitute the number of rings that the modem should receive before answering the call. For example, to answer after the first ring, type **ATS0=1**.
2. Type **AT&W** and press **Enter**.

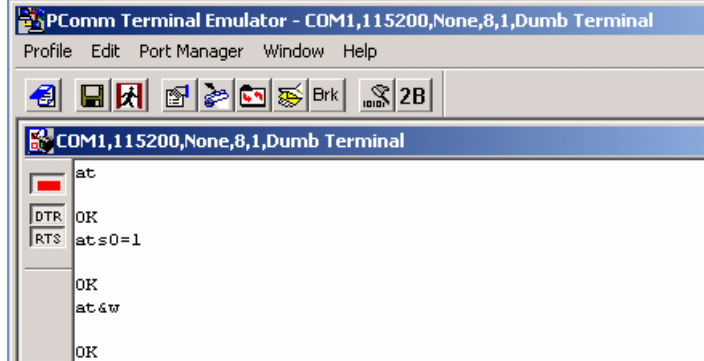

To disconnect the modem, type **+++**. The modem will respond with **OK**, which means that you have already switched back to command mode. Type **ATH** and press **Enter** to disconnect.



ATTENTION

ATA is the answer command. ATSO=<x> is the auto-answer command. The AT&W command saves the current settings to the modem.

It is much easier to configure auto-answer with OnCell Configurator. On the GSM Setting tab, select **Enable Auto-answer on** \_\_\_ Rings and enter the desired number of rings.

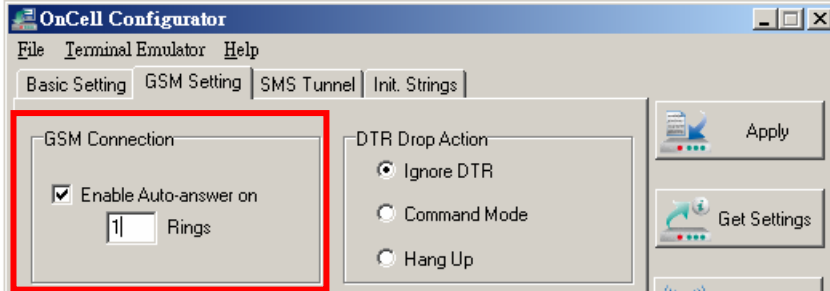

ATTENTION

If you are answering a call from a PSTN dial-up modem, type **AT+CICB=0** to force the incoming call to be a data call. Type **AT+CBST=7, 0, 1** to select bearer type to V.32 modem (9600 bps). In addition, type **AT&W** to save the settings. For further information, please refer to the OnCell G2100 Series AT Commands Guide on the Document and Software CD.

This task can be performed easily in OnCell Configurator. Select the V32. 9600 option and click **Apply** to activate the function.

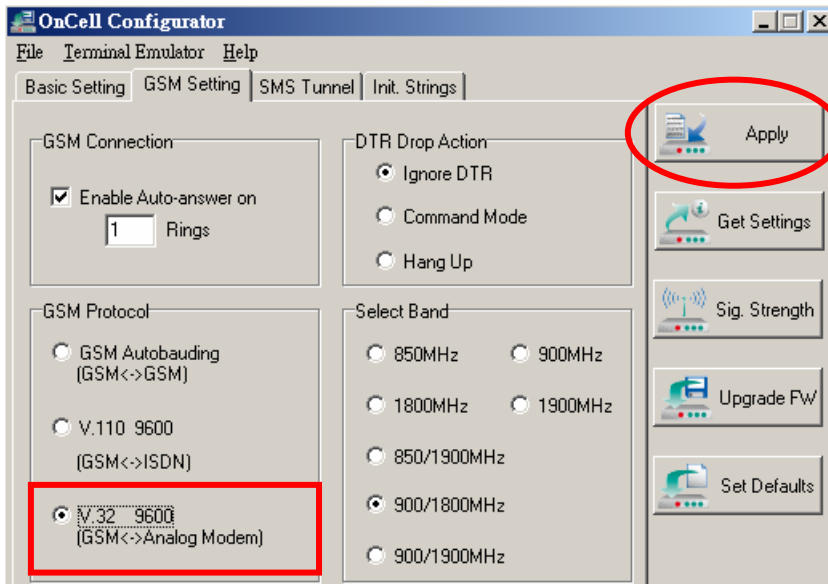

# 6

## Using Short Message Services

---

GSM technology offers the benefit of using SMS (short message service) as an easy way to communicate over the mobile network. In this chapter, we explain how to use SMS with the OnCell G2100 Series modem.

The following topics are covered in this chapter:

- Sending Short Messages**
- Reading Short Messages**
- Deleting Short Messages**
- SMS Tunnel Mode**

## Sending Short Messages

Follow these instructions to send a short message to a specific phone number.

1. Type **AT+CMGF=1** and press **Enter**.
2. Type **AT+CMGS=<phone number>** and press **Enter**. The terminal will present a ">" prompt. Enter your message at the prompt.
3. Press **Ctrl + Z** to deliver the message.

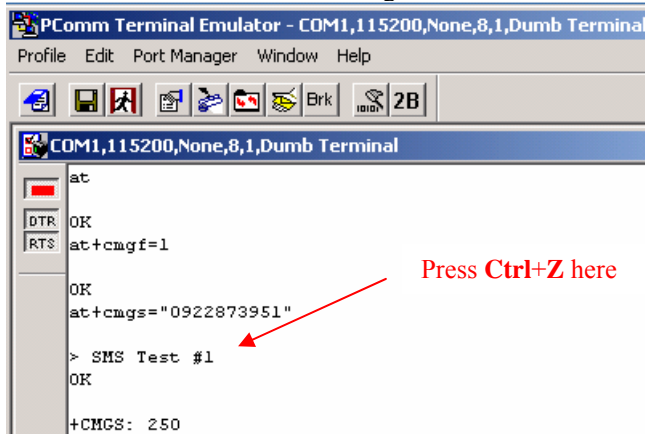

### ATTENTION

AT+CMGF=1 sets the SMS to Text mode.

## Reading Short Messages

Follow these instructions to read a short message that was sent to the OnCell.

1. Type **AT+CMGF=1** and press **Enter**.
2. When a short message is received, the modem will respond with a storage number for the message. The storage number will appear as **+CMTI: "SM", x** (where **x** is the storage number).
3. Type **AT+CMGR=x** to read the message (where **x** is the storage number of the message).

In the example, the storage number is **5**, which means that the message is stored in the 5<sup>th</sup> storage location.

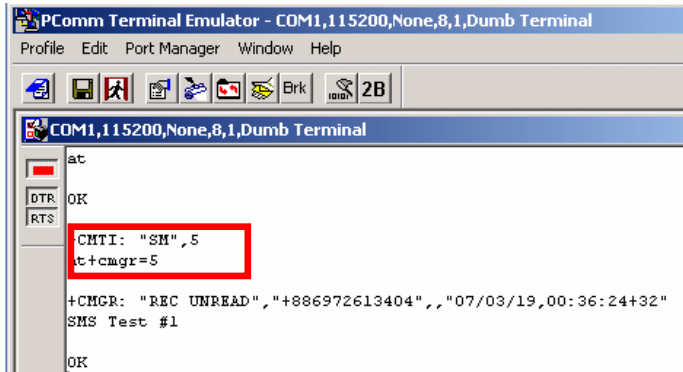

## Deleting Short Messages

Follow these instructions to delete a short message.

1. Type **AT+CMGD=x,n** and press **Enter**. For **x**, select one of the following options:

<b>"REC UNREAD"</b>	Shows received unread messages
<b>"REC READ"</b>	Shows received read messages
<b>"STO UNSENT"</b>	Shows stored unsent messages
<b>"STO SENT"</b>	Shows stored sent messages
<b>"ALL"</b>	Shows messages

For **n**, select one of the following options:

- 0** Delete message at location <include the index number>
- 1** Delete all READ messages.
- 2** Delete all READ and SENT messages.
- 3** Delete all READ, SENT, and UNSENT messages.
- 4** Delete ALL messages. "REC UNREAD" Shows received unread messages.

2. The following example shows how to delete all short messages in the storage.

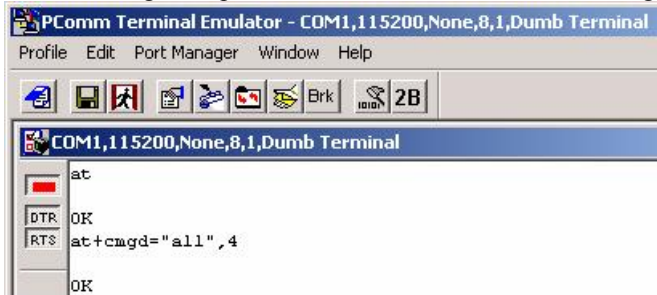

### ATTENTION

Please refer to the OnCell G2100 Series AT Command Set on the Document and Software CD for additional information on AT commands for SMS.



## SMS Tunnel Mode

A major benefit of GSM technology is that it supports short messages (SMS) for easy communication over the mobile network. Moxa's proprietary SMS Tunnel Mode allows you to expand your applications and reduce cost. For example, SMS Tunnel Mode can be used to update the message on a highway display panel, place refill orders for vending machines, or handle maintenance for remote rental equipment. SMS Tunnel Mode can even generate SMS alarms by converting text, binary, or Unicode data from a legacy device to short messages without the use of AT commands. SMS Tunnel Mode is particularly suitable for devices that communicate infrequently or lack access to the local network. SMS Tunnel Mode converts both ASCII and binary data to short messages transparently and bidirectionally. In addition, caller ID (phone number) can be used to block messages from uncertified users, broadcast messages, and unwanted SMS advertisements.

SMS Tunnel Mode has the following features:

- Transparently converts serial data to short message or vice versa without using AT Commands.
- Text, binary, and Unicode formats are supported.
- Verification of Incoming Caller ID is implemented to block uncertified users.
- The configuration profile can be easily stored and copied to other modems.



The following instructions explain how to use Configurator to configure SMS Tunnel Mode.

1. Connect the RS-232 port of the OnCell G2100 Series modem to a host PC. On the OnCell G2150I, make sure the RS-232 port is connected and DIP switch 1 is set to ON.
2. Start OnCell Configurator and select the **Create a new Configuration File from Configurator** option.

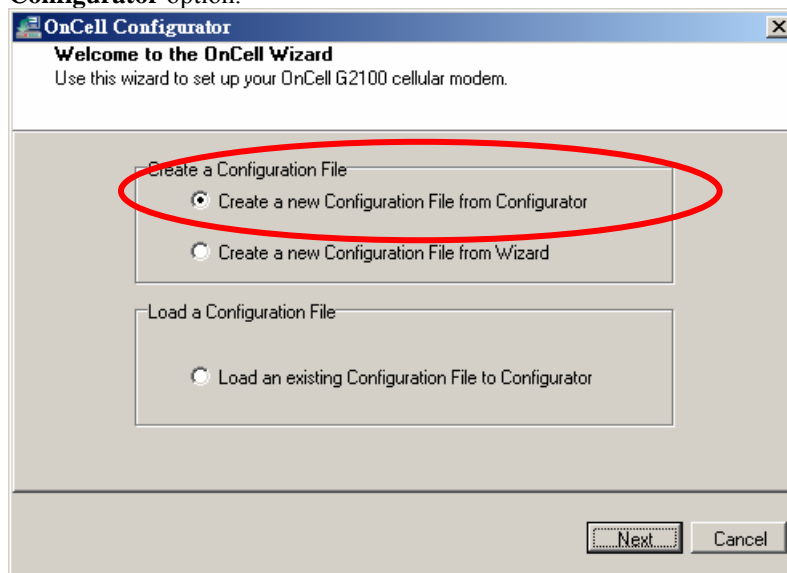

- On the **SMS Tunnel** tab, select **SMS-IN** to forward incoming short messages to the attached serial device. Select **SMS-OUT** to transmit serial data from the attached serial device as SMS messages. The **Caller ID Verification** (phone number) and **Target Phone Number** should be specified.

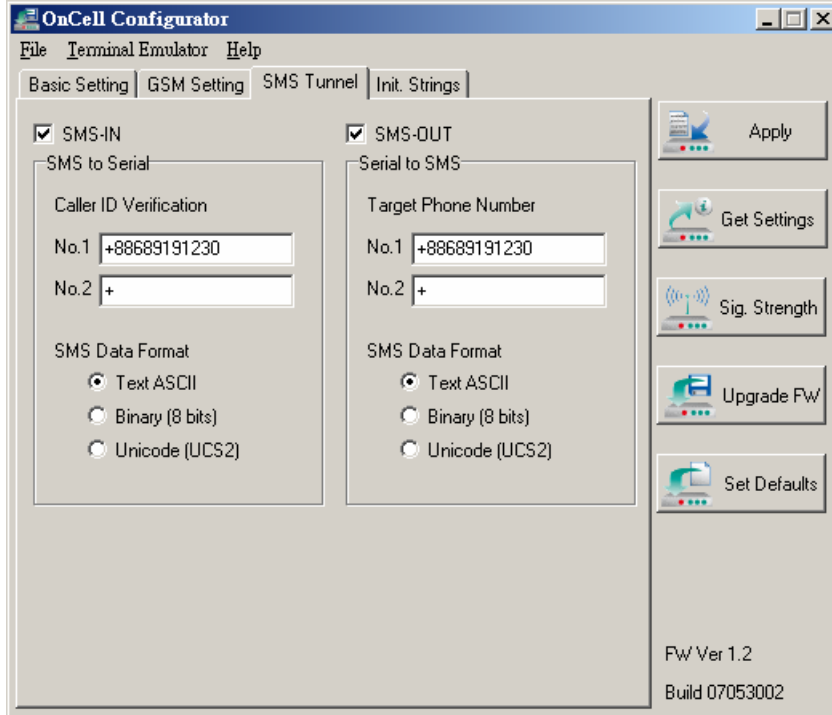

SMS Data Format	
Text ASCII	7 bits text format (160 bytes per packet)
Binary	8 bits binary (140 bytes per packet)
Unicode	16 bits Unicode (UCS2) format (70 bytes per packet)



ATTENTION

The **Target Phone Number** must be specified if **SMS-OUT** is activated.

The **Target Phone Number** and **Caller ID Verification** must be written in international format, starting with “+” followed by the country code.

If you leave **Caller ID Verification** blank, the OnCell G2100 Series modem will allow all incoming short messages to be forwarded to the attached serial device. This includes system broadcasts and advertisements.

Once the SMS Tunnel (SMS-OUT, SMS-IN or both) is activated and the SIM has registered to a carrier, the **GSM LED** will start blinking. The mode will be **Data Mode**, which does not allow users to enter AT Commands. If necessary, use the **escape command** (+++) from the terminal to switch to **Command Mode**. Command Mode allows the use of AT commands or OnCell Configurator.

**SMS Tunnel Mode** will disable auto-answering and connections by GSM, CSD, and GPRS.

The timeout between characters is 0.5 seconds. Messages that require a longer time period will be split into 2 or more messages.

The following instructions show how to configure SMS Tunnel mode using the **Wizard**.

1. Connect the RS-232 port of the OnCell G2100 Series modem to a host PC. On the OnCell G2150I, make sure the RS-232 port is connected and DIP switch 1 is set to ON.
2. Start OnCell Configurator and select the **Create a new Configuration File from Wizard** option.

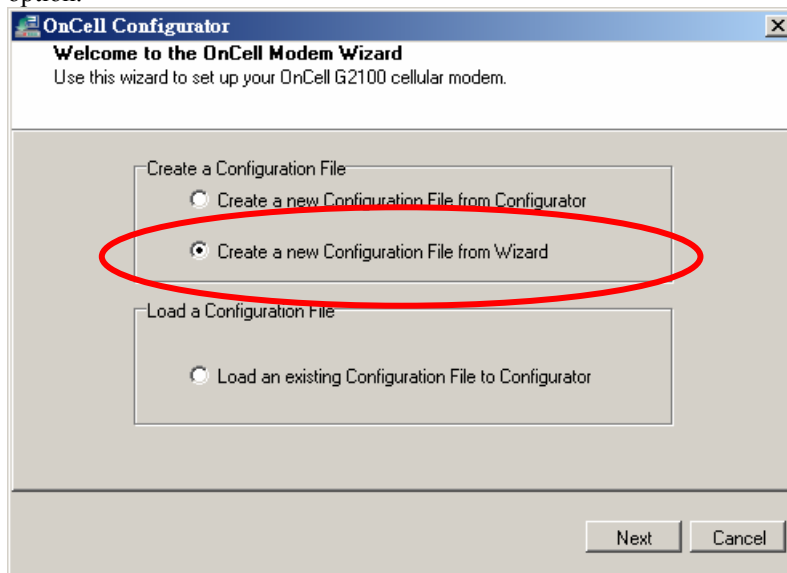

3. Select **SMS Tunnel Mode** and click **Next** to proceed.

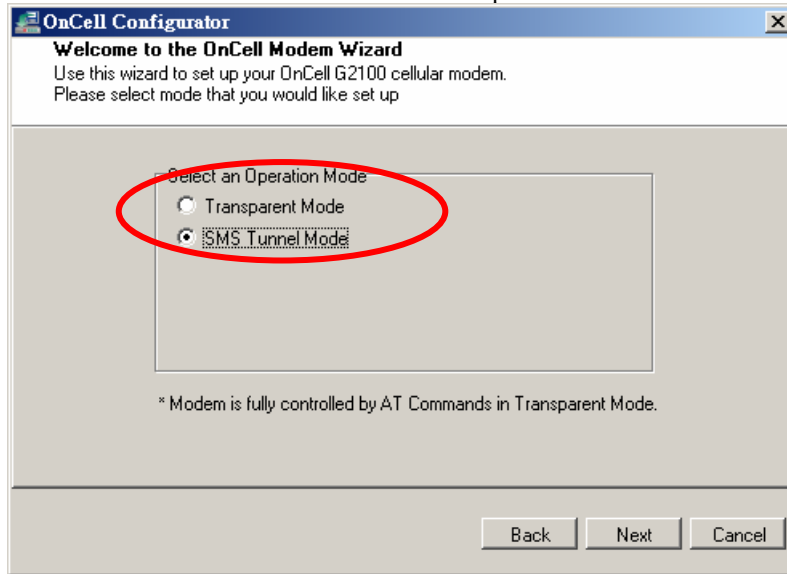

**ATTENTION**

Transparent Mode provides the general functions of a GSM/GPRS modem.

4. On the **SMS Tunnel Mode Settings** page, select **SMS-IN** to forward incoming short messages to the attached serial device. Select **SMS-OUT** to transmit serial data from the attached serial device as SMS messages. The **Caller ID Verification** (phone number) and **Target Phone Number** should be specified. Click **Next** to proceed.

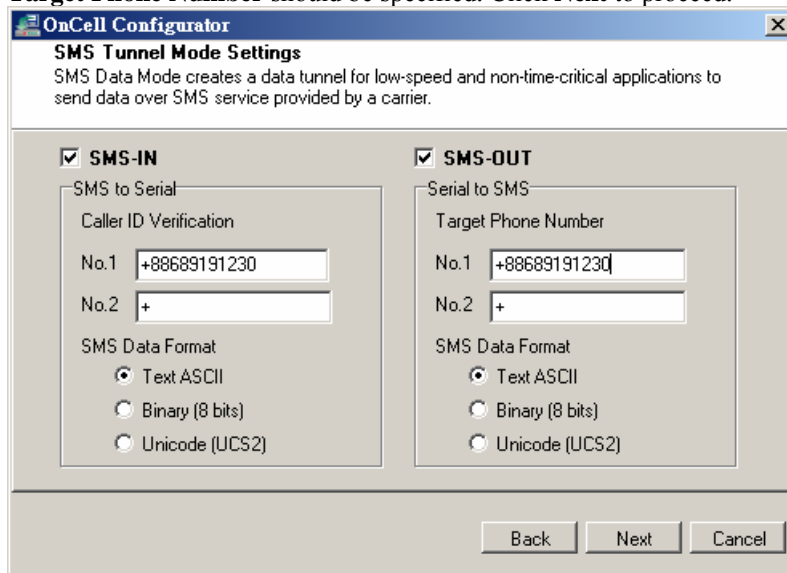

SMS Data Format	
Text ASCII	7 bits text format (160 bytes per packet)
Binary	8 bits binary (140 bytes per packet)
Unicode	16 bits Unicode (UCS2) format (70 bytes per packet)



**ATTENTION**

The **Target Phone Number** must be specified if **SMS-OUT** is activated.

The **Target Phone Number** and **Caller ID Verification** must be written in international format, starting with “+” followed by the country code.

If you leave **Caller ID Verification** blank, the OnCell G2100 Series modem will allow all incoming short messages to be forwarded to the attached serial device. This includes system broadcasts and advertisements.

Once the SMS Tunnel (SMS-OUT, SMS-IN or both) is activated and the SIM has registered to a carrier, the **GSM LED** will start blinking. The mode will be **Data Mode**, which does not allow users to enter AT Commands. If necessary, use the **escape command** (+++) from the terminal to switch to **Command Mode**. Command Mode allows the use of AT commands or OnCell Configurator.

**SMS Tunnel Mode** will disable auto-answering and connections by GSM, CSD, and GPRS.

The timeout between characters is 0.5 seconds. Messages that require a longer time period will be split into 2 or more messages.

- The complete profile will be displayed in **Configurator**. Click **Apply** to save the settings onto the modem.

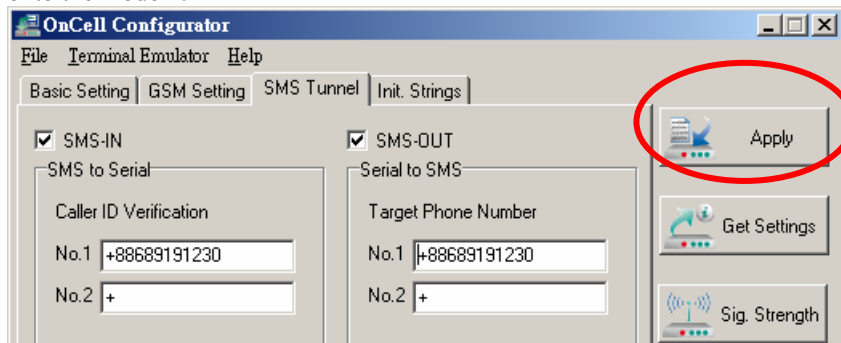

# 7

## GPRS Connection

---

The following topics are covered in this chapter:

- ❑ **GPRS Overview**
- ❑ **Windows GPRS Access**
  - Installing Modem Driver
  - Modem Diagnostics
  - Setting up the APN
  - Adding Windows DUN Entr

## GPRS Overview

GPRS is a packet-switched technology, which means that multiple users share the same transmission channel. In addition, transmission only occurs when there is outgoing data. This means that the available bandwidth can be dedicated solely to data communication as needed. In general, a GPRS network can be viewed as a special IP network that offers IP connectivity to IP terminals. Devices such as PCs, embedded computers, and PLCs that are PPP-enabled can be easily connected to the IP network and the Internet.



The OnCell G2100 Series modem is a multi-slot Class 10 device, which means that there are **4 Rx** timeslots plus **1 Tx** timeslot, or **3 Rx** timeslots plus **1 Tx** timeslot. This requires that the provider support CS-1 to CS-4 coding schemes. GPRS offers no guaranteed data rates or bandwidth. The value assigned by the provider (coding scheme and timeslots) can change dynamically during a connection.

In general, for the **1 Tx + 4 Rx** combination, the **Tx** throughput is around 8 to 12 Kbps and the **Rx** throughput is around 32 to 48 Kbps.

For the **2 Tx + 3 Rx** combination, the **Tx** throughput is around 8 to 12 Kbps and the **Rx** throughput is around 32 to 48 Kbps.

## Windows GPRS Access

The OnCell G2100 Series modem can use Windows DUN (Dial-up Networking) to provide Internet access through the GPRS mobile network. The following pages explain how to configure the modem and your Windows system for GPRS access.



### ATTENTION

The specific steps may vary depending on your version of Windows and your Windows settings.

### Installing Modem Driver

1. In the Control Panel, open "Phone and Modem Options" and go to the "Modem" tab. Click **Add** to add a new modem.

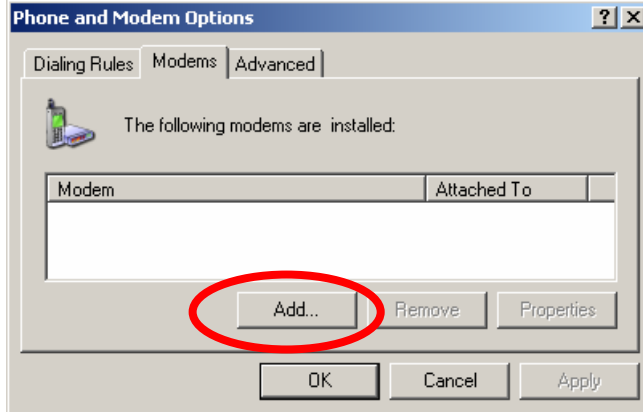

#### ATTENTION

The first time you access the Phone and Modem Options, Windows will ask you to input the area code. Enter the area code to proceed.

2. When the Install Mode window opens, select **Don't detect my modem, I will select it from a list** and click **Next**.

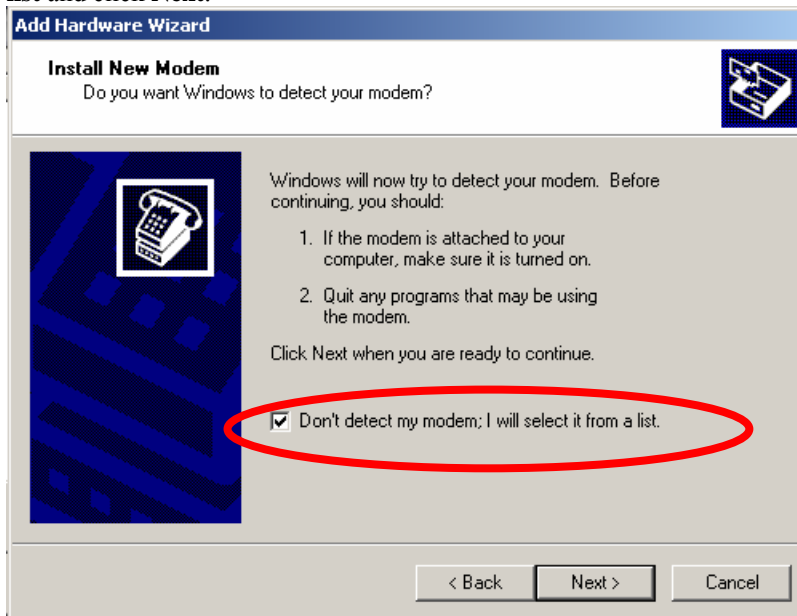



- Next, click **Have Disk**.

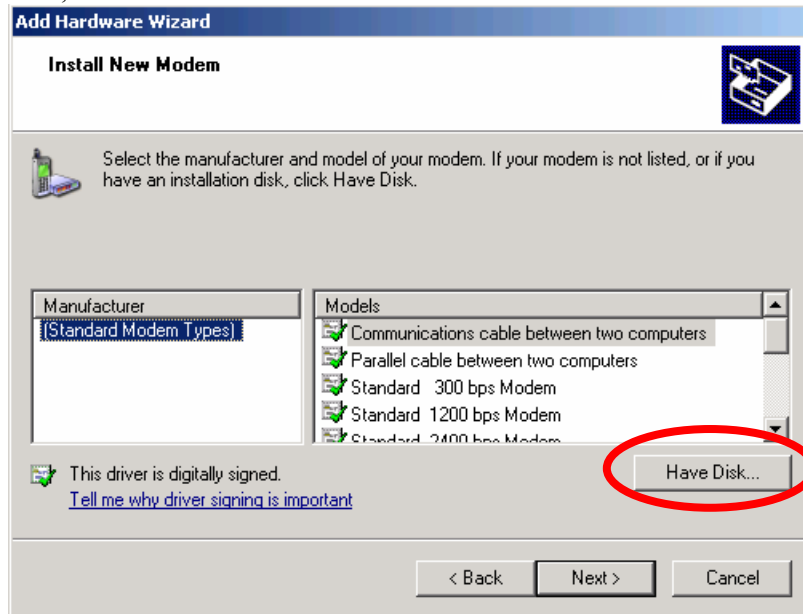

- When the Install From Disk window opens, click **Browse**.

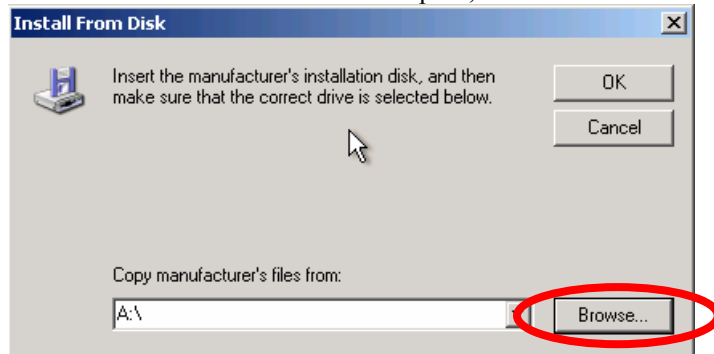

- Select the **OnCell\_G2100\_Series.inf** driver. The file is located in the **Win\_Driver** directory on the Document and Software CD. Click **Open** to proceed.

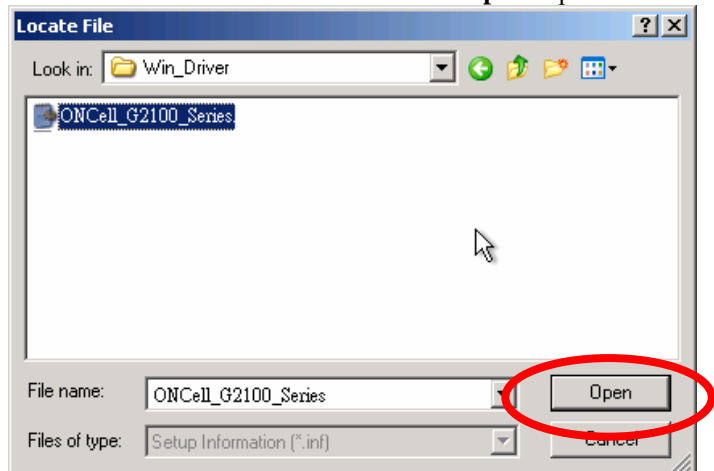

- 6. When the Install From Disk page opens, click **OK**.

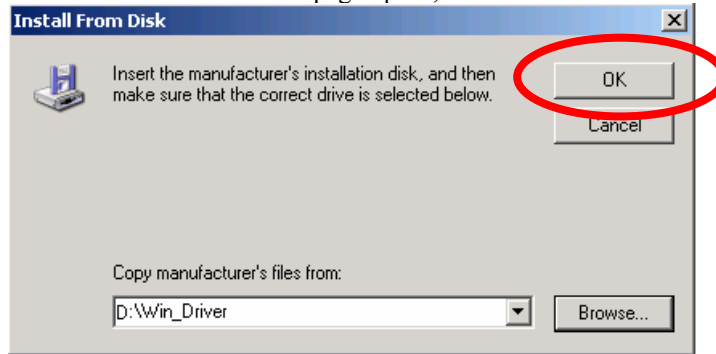

- 7. Click **Next**.

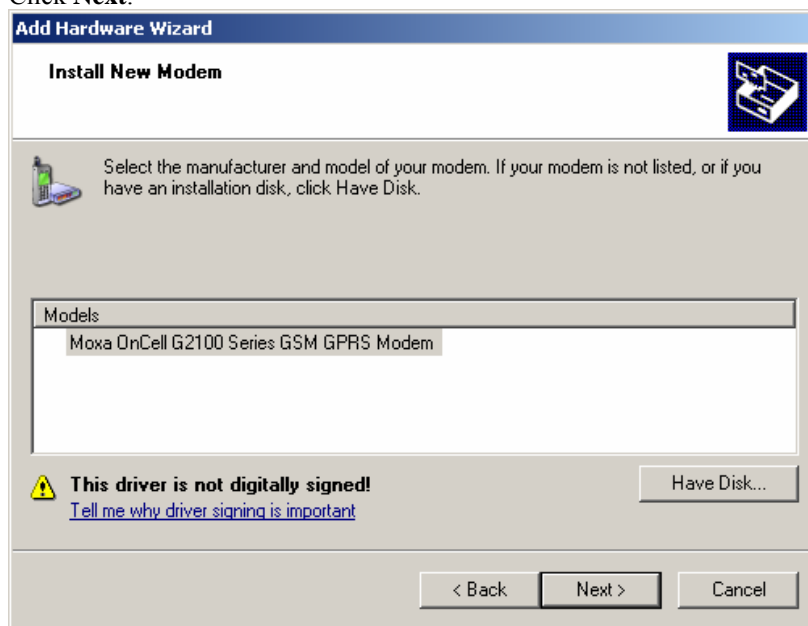

8. When the next window opens, select the COM port that you are using and click **Next**.

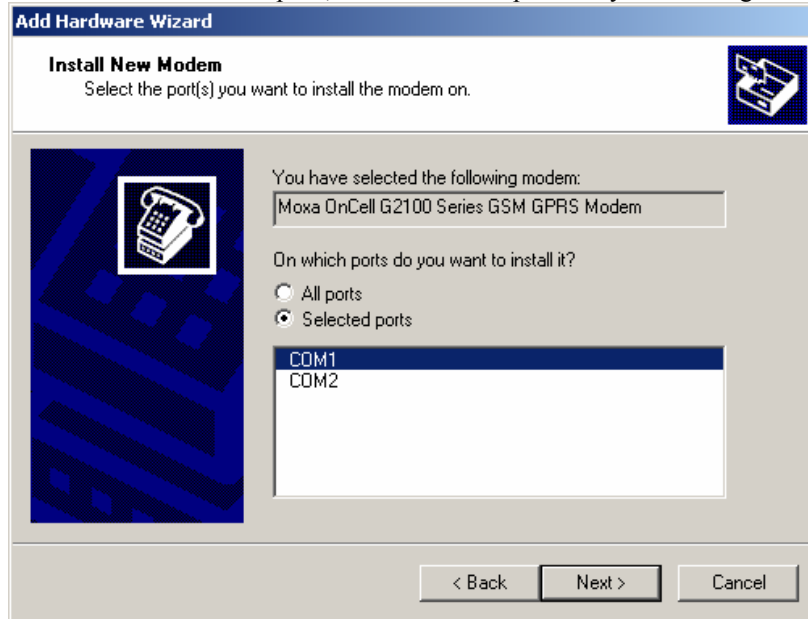

9. A message will appear stating that the driver has not passed Windows Logo testing. Click **Continue Anyway** to proceed.

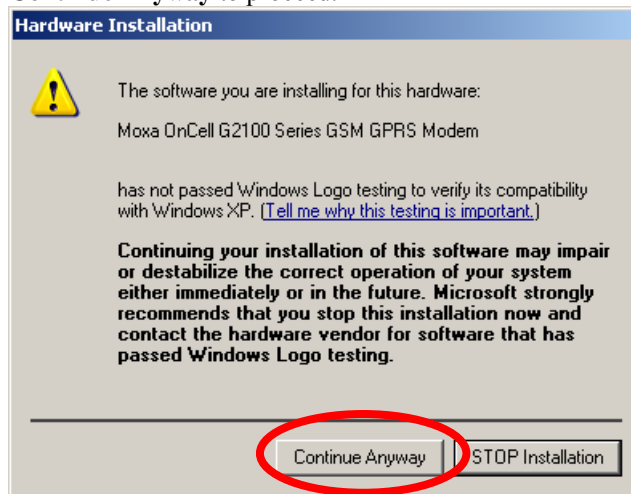

10. Click **Finish** to complete the installation procedure.

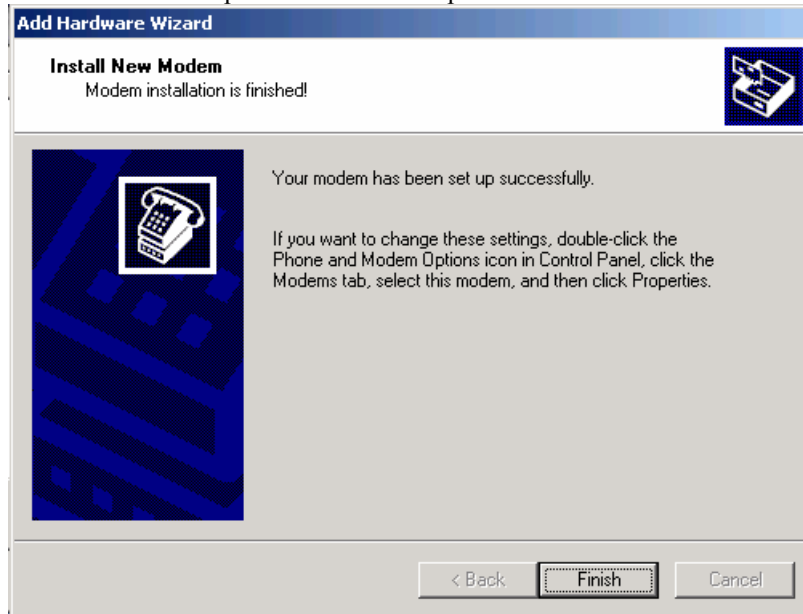

11. At this point, the OnCell G2100 Series driver should be listed in "Phone and Modem Options" on the "Modems" tab.

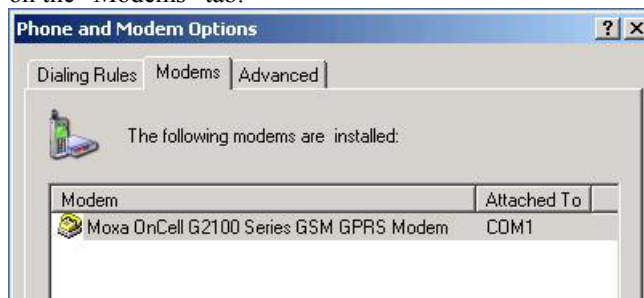

## Modem Diagnostics

The following instructions explain how to verify that the modem is installed properly and has been activated.

1. From the Control Panel, open **Phone and Modem Options**. On the **Modem** tab, click **Properties**.

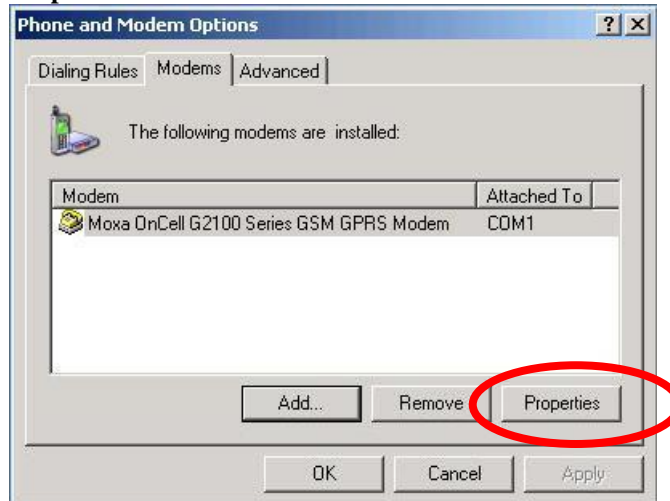

### ATTENTION

Make sure that the RS-232 port of the OnCell G2100 Series modem is connected. For the OnCell G2150I, make sure DIP switch 1 is set to **ON**.

Make sure the **SMS Tunnel Mode** is disabled. If the GSM LED is blinking, that means that SMS Tunnel Mode is enabled and activated. To switch back to Command Mode, you must send the **escape command** (+++) using terminal software, or remove the SIM card directly.

- 2. On the Diagnostics tab, click **Query Modem**.

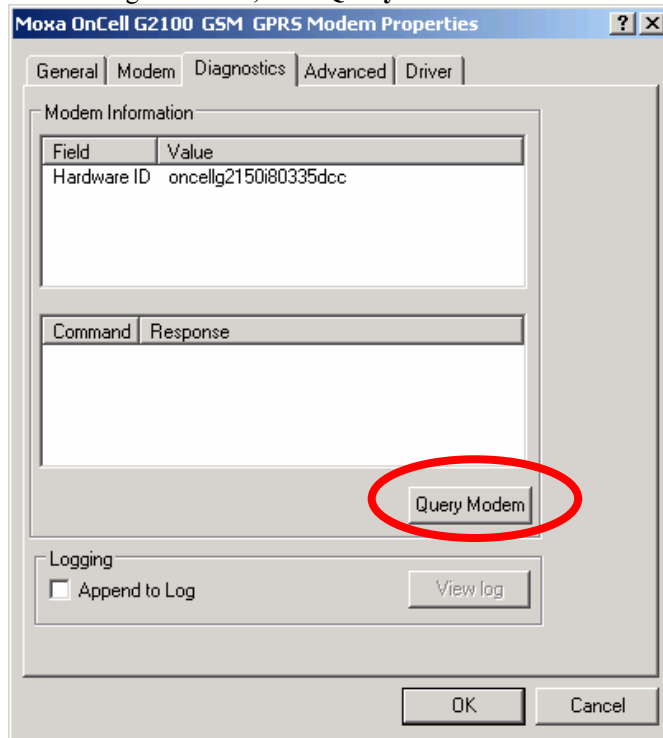

- 3. If the query is successful, you will be able to see commands that are sent to the modem and the modem's responses.

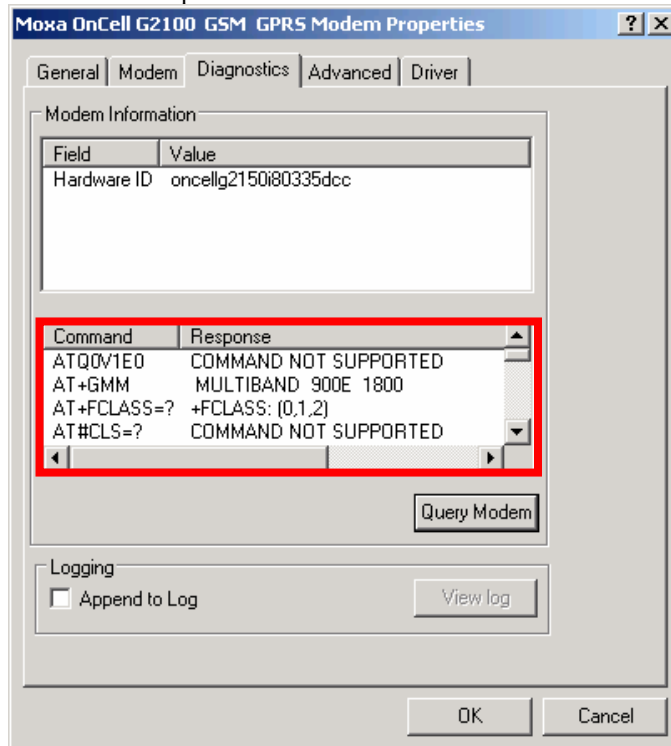

## Setting up the APN

Before using GPRS connection in Windows, the APN (Access Point Name) must be added as a modem initialization command. The following instructions explain how to set up the APN.



### ATTENTION

Check the signal strength indicators on the front panel of the OnCell G2100 Series modem. If the LED indicators are dark, then the SIM card is not installed properly, or the modem is not picking up a signal. If only one bar lights up, the signal is not strong enough for a GPRS connection. Adjust the position of the antenna, change the location of the installation, or use an optional high-gain antenna instead.

Make sure that your SIM card account supports GPRS service. In most regions, you will need to apply with your mobile service provider to activate the service.

Make sure that the RS-232 port of the OnCell G2100 Series modem is connected. For the OnCell G2150I, make sure DIP switch 1 is set to **ON**.

1. From the Control Panel, open **Phone and Modem Options**. On the **Modem** tab, click **Properties**.

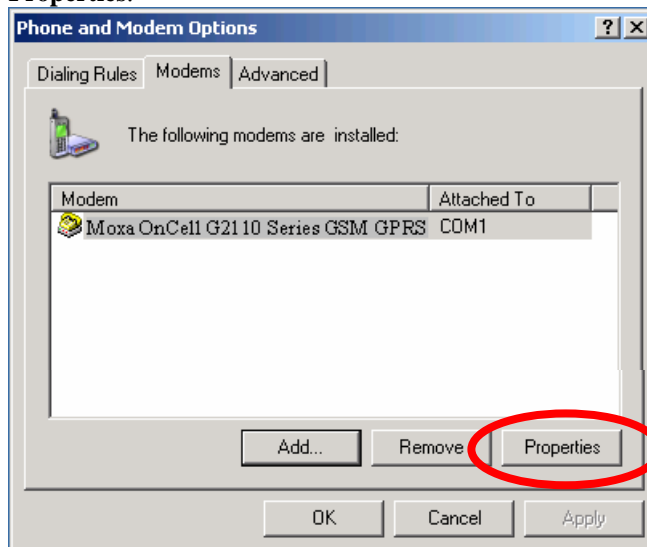

2. On the **Advanced** tab, enter the following in the **Extra initialization commands** field:  
`AT+CGDCONT=1,"IP",<APN>`

For <APN>, use the correct service for your account, as in this example;

`AT+CGDCONT=1,"IP","ISP.CINGULAR"`

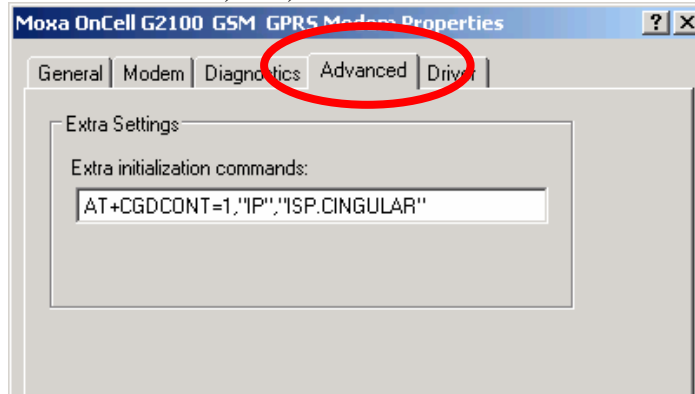

#### ATTENTION

The APN should be entered between the displayed brackets. Remember that the APN is case sensitive.

Note that "**IP**" should be written in all capital letters.

For a list of APNs, please refer to the **APN List** on the Document and Software CD.

3. Click **OK** to close the **Properties** window.



## Adding Windows DUN Entry

The following instructions explain how to add a Windows Dial-up Networking entry.

1. In the Control Panel, open Network Connections and click **Create a new connection**.
2. When the **New Connection Wizard** window opens, select **Connect to the Internet** and click **Next**.

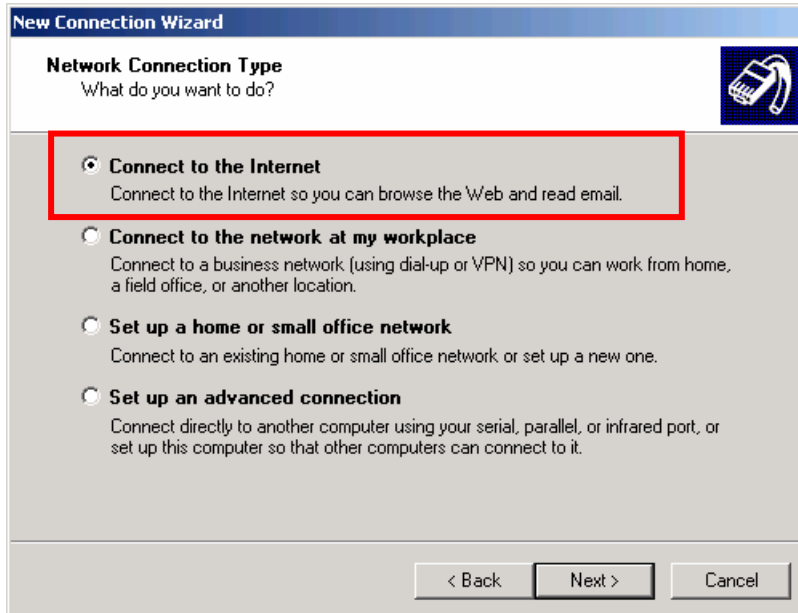

3. Select **Set up my connection manually** and click **Next**.

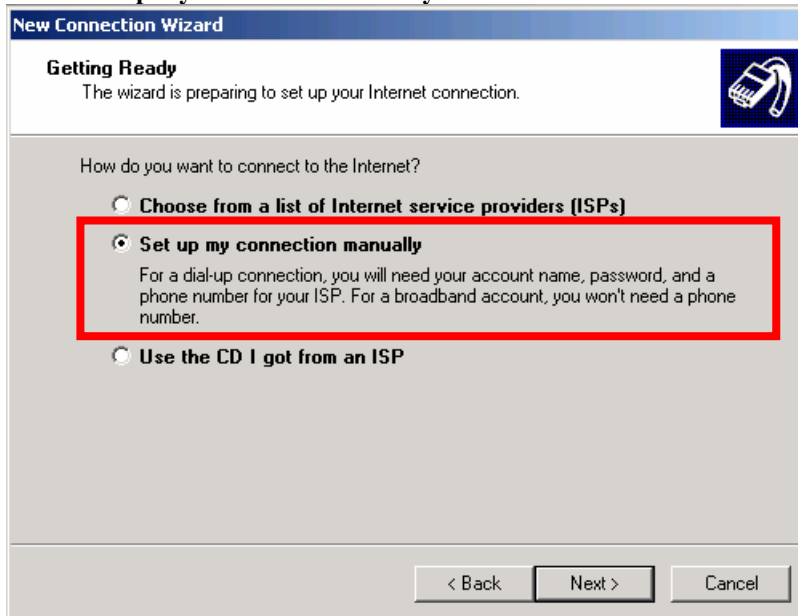

4. Select **Connect using a dial-up modem** and click **Next**.

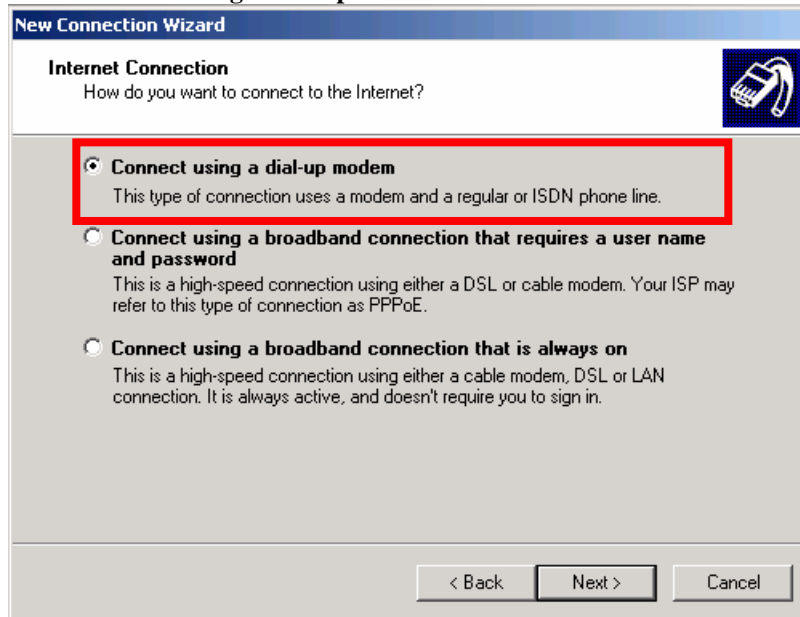

5. Enter the name of your service provider and click **Next**.

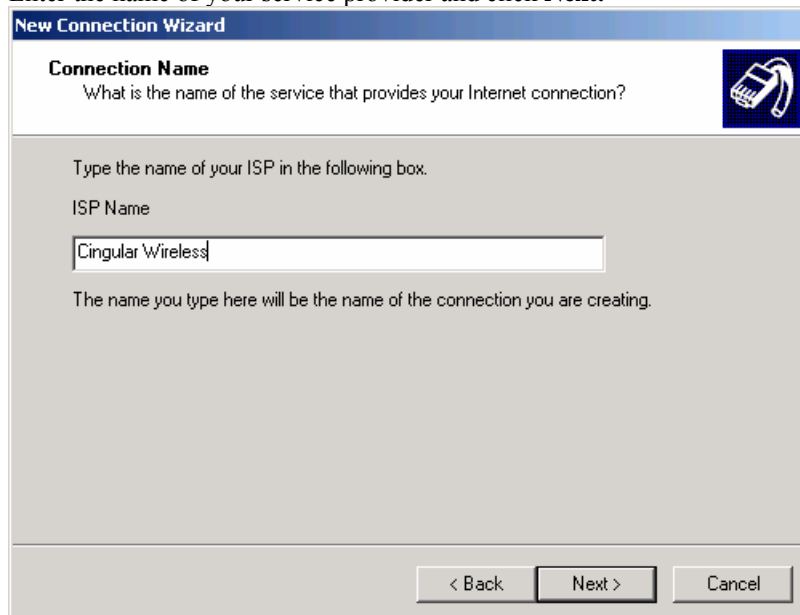

6. Enter **\*99\*\*\*1#** for the phone number and click **Next**.

The screenshot shows a dialog box titled "New Connection Wizard" with a blue header bar. Below the header, the title "Phone Number to Dial" is displayed in bold, followed by the question "What is your ISP's phone number?". To the right of the text is a small icon of a mobile phone. Below this, the instruction "Type the phone number below." is shown. A text input field labeled "Phone number:" contains the text "\*99\*\*\*1#". Below the input field, a paragraph of text reads: "You might need to include a '1' or the area code, or both. If you are not sure you need the extra numbers, dial the phone number on your telephone. If you hear a modem sound, the number dialed is correct." At the bottom of the dialog box, there are three buttons: "< Back", "Next >", and "Cancel".



**ATTENTION**

The phone number **\*99\*\*\*1#** is a special phone number that is used globally to request GPRS IP service from the carrier. **DO NOT** modify this phone number in any way. The same number is used regardless of the country that you are located in.

7. Enter the **User name** and **Password** as prompted and click **Next**.

The screenshot shows a dialog box titled "New Connection Wizard" with a blue header bar. Below the header, the title "Internet Account Information" is displayed in bold, followed by the instruction "You will need an account name and password to sign in to your Internet account." To the right of the text is a small icon of a mobile phone. Below this, the instruction "Type an ISP account name and password, then write down this information and store it in a safe place. (If you have forgotten an existing account name or password, contact your ISP.)" is shown. There are three text input fields: "User name:" containing "ispda@cingulargprs.com", "Password:" containing eight dots, and "Confirm password:" containing eight dots. Below the input fields are two checkboxes: " Use this account name and password when anyone connects to the Internet from this computer" and " Make this the default Internet connection". At the bottom of the dialog box, there are three buttons: "< Back", "Next >", and "Cancel".



**ATTENTION**

For a list of User names and Passwords, refer to **APN List** on the Document and Software CD, or consult your service provider for further details.

8. Click **Finish**.



9. In the next window that opens, click **Properties**.

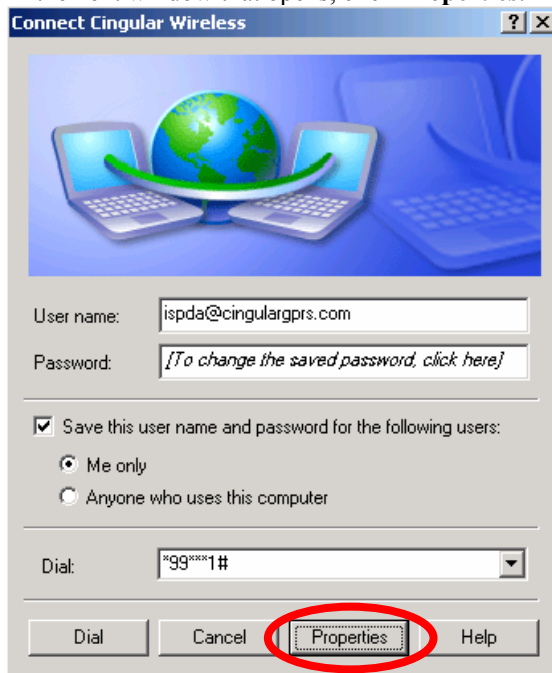

- Verify that **Use dialing rules** on the **General** tab is NOT selected.

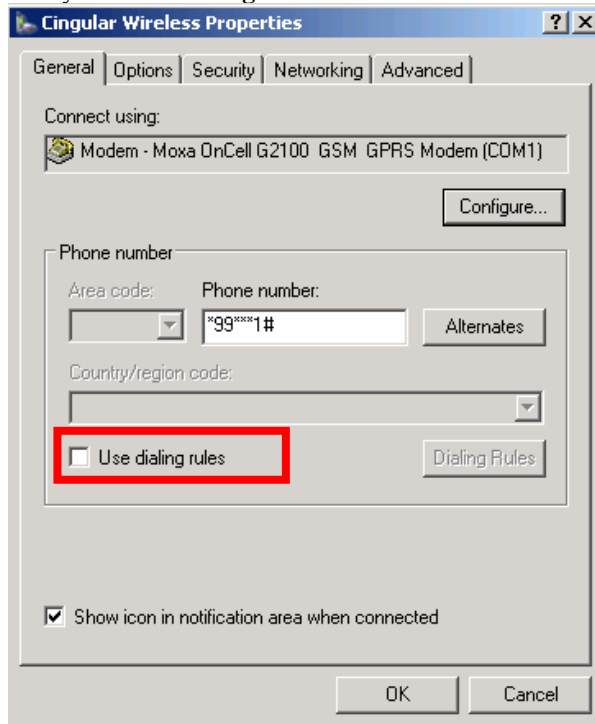

- On the **Networking** tab, select **Internet Protocol (TCP/IP)** and click **Properties** to set the DNS IP address.

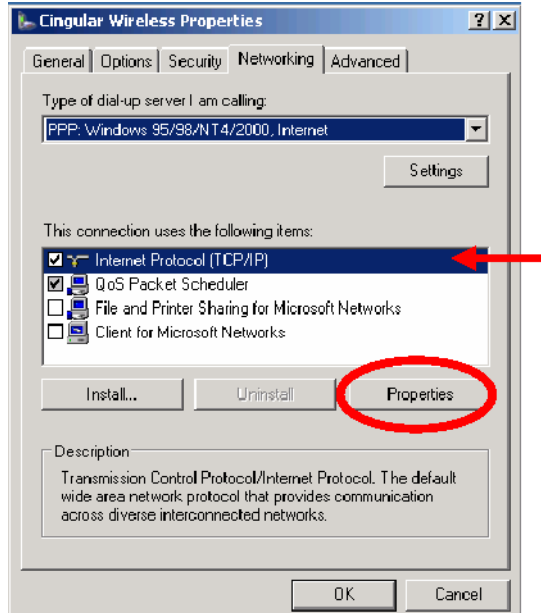

12. If you know the IP address of the DNS server, select **Use the following DNS server addresses** and enter the IP address(es) as prompted. Click **OK**.

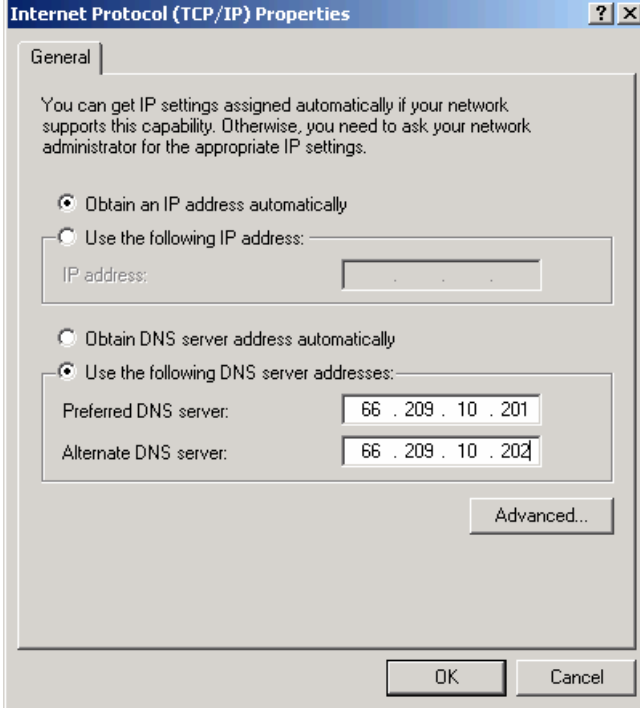

The screenshot shows the 'Internet Protocol (TCP/IP) Properties' dialog box with the 'General' tab selected. The text inside reads: 'You can get IP settings assigned automatically if your network supports this capability. Otherwise, you need to ask your network administrator for the appropriate IP settings.' There are two radio button options: 'Obtain an IP address automatically' (selected) and 'Use the following IP address:'. Below the second option is an empty text box labeled 'IP address:'. There are also two radio button options for DNS: 'Obtain DNS server address automatically' (not selected) and 'Use the following DNS server addresses:'. Below the second option are two text boxes: 'Preferred DNS server:' containing '66 . 209 . 10 . 201' and 'Alternate DNS server:' containing '66 . 209 . 10 . 202'. At the bottom right of the dialog is an 'Advanced...' button. At the very bottom are 'OK' and 'Cancel' buttons.

**ATTENTION**

For detailed DNS information, please refer to the **APN List** on the Document and Software, or consult your service provider for further details.

13. Click **OK**.

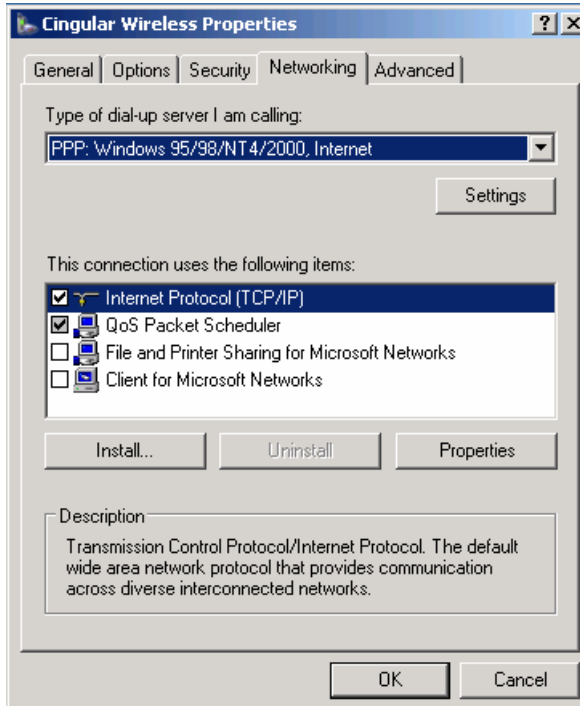

14. In the next window that appears, click **Dial** to establish the connection.

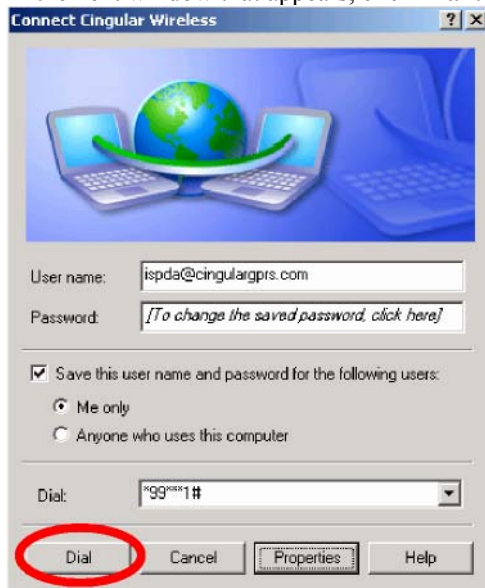

# A

## GPRS with UC-7110, UC-7112

---

Moxa's UC-7110 and UC-7112 are small embedded computers that can be used for applications such as transportation control, light control, factory/building automation, and power utilities. However, for some applications it is either inconvenient or impossible to connect to the embedded computers with a traditional landline. In this case, the OnCell G2100 Series modem is a great solution for providing GSM/GPRS connectivity to the UC-7110 or UC-7112.



You can refer to step-by-step installation guide and a reference script in the **/Linux** folder on the Document and Software CD.



# B

## Federal Communication Commission Interference Statement

---

This equipment has been tested and found to comply with the limits for a Class A digital device, pursuant to Part 15 of the FCC Rules. These limits are designed to provide reasonable protection against harmful interference in a residential installation. This equipment generates, uses and can radiate radio frequency energy and, if not installed and used in accordance with the instructions, may cause harmful interference to radio communications. However, there is no guarantee that interference will not occur in a particular installation. If this equipment does cause harmful interference to radio or television reception, which can be determined by turning the equipment off and on, the user is encouraged to try to correct the interference by one or more of the following measures:

- Reorient or relocate the receiving antenna.
- Increase the separation between the equipment and receiver.
- Connect the equipment into an outlet on a circuit different from that to which the receiver is connected.
- Consult the dealer or an experienced radio/TV technician for help.

### CAUTION:

Any changes or modifications not expressly approved by the grantee of this device could void the user's authority to operate the equipment.

### FCC RF Radiation Exposure Statement

This equipment complies with FCC RF radiation exposure limits set forth for an uncontrolled environment. This equipment should be installed and operated with a minimum distance of 20cm between the radiator and your body.

This device complies with Part 15 of the FCC Rules. Operation is subject to the following two conditions:

- (1) This device may not cause harmful interference and
- (2) This device must accept any interference received, including interference that may cause undesired operation.