

# ioThinX 4510 Series User's Manual

---

Edition 1.0, November 2018

[www.moxa.com/product](http://www.moxa.com/product)

**MOXA**®

© 2018 Moxa Inc. All rights reserved.

# ioThinX 4510 Series User's Manual

The software described in this manual is furnished under a license agreement and may be used only in accordance with the terms of that agreement.

## Copyright Notice

© 2018 Moxa Inc. All rights reserved.

## Trademarks

The MOXA logo is a registered trademark of Moxa Inc.  
All other trademarks or registered marks in this manual belong to their respective manufacturers.

## Disclaimer

Information in this document is subject to change without notice and does not represent a commitment on the part of Moxa.

Moxa provides this document as is, without warranty of any kind, either expressed or implied, including, but not limited to, its particular purpose. Moxa reserves the right to make improvements and/or changes to this manual, or to the products and/or the programs described in this manual, at any time.

Information provided in this manual is intended to be accurate and reliable. However, Moxa assumes no responsibility for its use, or for any infringements on the rights of third parties that may result from its use.

This product might include unintentional technical or typographical errors. Changes are periodically made to the information herein to correct such errors, and these changes are incorporated into new editions of the publication.

## Technical Support Contact Information

[www.moxa.com/support](http://www.moxa.com/support)

### Moxa Americas

Toll-free: 1-888-669-2872  
Tel: +1-714-528-6777  
Fax: +1-714-528-6778

### Moxa Europe

Tel: +49-89-3 70 03 99-0  
Fax: +49-89-3 70 03 99-99

### Moxa India

Tel: +91-80-4172-9088  
Fax: +91-80-4132-1045

### Moxa China (Shanghai office)

Toll-free: 800-820-5036  
Tel: +86-21-5258-9955  
Fax: +86-21-5258-5505

### Moxa Asia-Pacific

Tel: +886-2-8919-1230  
Fax: +886-2-8919-1231

# Safety Symbols



## **DANGER**

Indicates a high-risk, imminently hazardous situation which, if not avoided, will result in death or serious injury.



## **WARNING**

Indicates a moderate risk, which, if not avoided can cause a potentially hazardous situation.



## **CAUTION**

Indicates a low-risk, potentially hazardous situation which, if not avoided, may result in minor or moderate injury.

## **NOTE**

Indicates a potential malfunction which, if not avoided, will not result in damage to property.

## **INFORMATION**

This information is important for preventing errors.

# Table of Contents

<b>1. Preface</b>	<b>1-1</b>
Revision History	1-2
Relevant Models	1-2
Package Contents	1-2
Usage Scenarios	1-2
Hardware and Software Requirements	1-3
Safety Precautions	1-3
Additional Resources	1-4
<b>2. Product Overview</b>	<b>2-1</b>
Technical Data	2-2
Common Specifications	2-2
Appearance	2-3
Front View	2-3
Physical Dimensions	2-4
LED Indicators	2-5
<b>3. Hardware Installation</b>	<b>3-1</b>
Wiring System and Field Power	3-2
System Power	3-2
Field Power	3-3
Wiring Ethernet Ports	3-3
Wiring Serial Port(s)	3-4
Grounding the Unit	3-5
Connecting the System Power Ground	3-5
Connecting the Field Power Ground	3-5
Mounting the Unit	3-6
Installing the Unit on a DIN Rail	3-6
Removing the Unit from a DIN Rail	3-7
Installing Covers on the Device and the Right-Most I/O Module	3-8
Removing a Cover from the Right-Most Module	3-8
Horizontal Installation	3-9
Powering on the Unit	3-9
<b>4. Software Tools</b>	<b>4-1</b>
Preparing Software Tools	4-2
Connecting Web Console	4-2
Preparing IOxpress Utility	4-2
Preparing Moxa CLI Configuration Tool	4-2
Web Console	4-3
Dashboard	4-4
System	4-7
Security	4-10
Network	4-13
Module	4-13
Serial Port	4-16
I/O	4-19
Internal Register	4-26
Protocol	4-27
<b>5. Quick Start Guide</b>	<b>5-1</b>
Configuring the Unit	5-2
Login to the Unit	5-2
Configuring Module Settings	5-2
Changing Device Name	5-4
Changing Username & Password	5-4
Configuring Service Settings	5-5
Configuring Account Settings	5-5
Configuring Network Settings	5-6
Configuring Serial Port & IR Settings	5-6
Configuring I/O Settings	5-7
Configuring Modbus Address Settings	5-8
Configuring SNMP Settings	5-9
Mass-deploying the Settings	5-10
Updating Configuration to Multiple Units	5-13
Setting Date and Time to Multiple Units	5-14
Monitoring & Operating the Unit	5-15
Monitoring Module & I/O Status	5-15
Monitoring Connection Status	5-16
Exiting Safe Mode Status	5-16
Maintaining the Unit	5-17

Backing up Configuration Files .....	5-17
Updating the Firmware.....	5-17
Restarting the Unit .....	5-18
Loading Factory Default Settings .....	5-19
<b>A. Appendix .....</b>	<b>A-1</b>
Network Port Usage .....	A-2
Modbus/TCP Slave Rules.....	A-2
Supported Function Code .....	A-2
Exception Code .....	A-2
System Registers .....	A-2
45MR-1600 (-T), 16 DIs Registers.....	A-3
45MR-1601 (-T), 16 DIs Registers.....	A-3
45MR-2404 (-T), 4 Relays Registers .....	A-4
45MR-2600 (-T), 16 DOs Registers .....	A-4
45MR-2601 (-T), 16 DOs Registers.....	A-5
45MR-2606 (-T), 8 DIs, 8 DOs Registers .....	A-5
45MR-3800 (-T), 8 AIs Registers.....	A-6
45MR-3810 (-T), 8 AIs Registers.....	A-6
45MR-4420 (-T), 4 AOs Registers.....	A-7
45MR-6600 (-T), 6 RTDs Registers .....	A-7
45MR-6810 (-T), 8 TCs Registers .....	A-8
SNMP Rules .....	A-8
RESTful API Rules.....	A-8
Supported Request Method.....	A-8
GET Request Components .....	A-9
PUT Request Components.....	A-9
RESTful API List .....	A-9
Exception Code .....	A-11
Troubleshooting.....	A-11
Forgot username & password.....	A-12
Forgot IP address of the unit.....	A-12
Failed to update firmware.....	A-13
Failed to update configuration .....	A-13
Failed to access the unit through IP address & IOxpress.....	A-14
Failed to Enter System Ready Mode.....	A-14

In this chapter, we explain the scope of and how to use this document.

The following topics are covered in this chapter:

- ❑ **Revision History**
- ❑ **Relevant Models**
- ❑ **Package Contents**
- ❑ **Usage Scenarios**
- ❑ **Hardware and Software Requirements**
- ❑ **Safety Precautions**
- ❑ **Additional Resources**

# Revision History

Version	Change	Date
V1.0	First Release	2018-11-12

# Relevant Models

This document is only applicable to the models listed below.

Model Name	Description
ioThinx 4510	Advanced I/O, Ethernet network adapter, 3-in-1 serial port(s), -20 to 60°C operating temperature
ioThinx 4510-T	Advanced I/O, Ethernet network adapter, 3-in-1 serial port(s), -40 to 75°C operating temperature

# Package Contents

The following items are included in the product package.

- The ioThinx 4510 device
- Quick installation guide (Printed)
- Warranty card

# Usage Scenarios

The ioThinx 4510 Series can be used for the following applications:

1. PLC I/O expansion

The ioThinx 4510 Series can be used to expand the number of I/O points on a PLC.

2. Remote I/O

The ioThinx 4510 Series can be accessed by master software, such as SCADA software, using IT or OT protocols to collect I/O data.

3. Modbus Gateway

The ioThinx 4510 Series has one or more serial ports to connect serial devices. It collects serial data using a Modbus RTU master protocol, which can be accessed by a PLC or master software with IT or OT protocols.

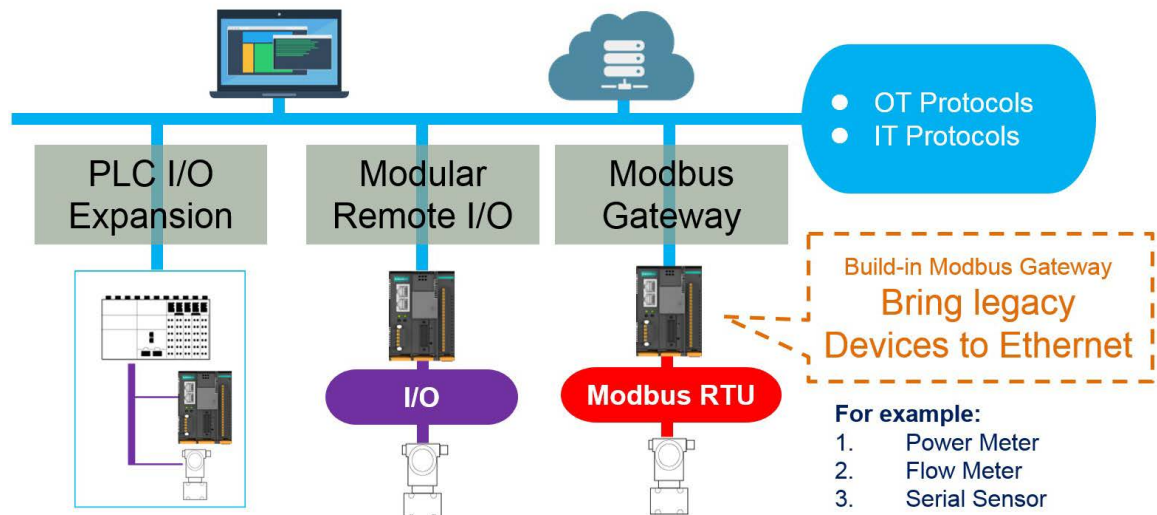

# Hardware and Software Requirements

You will need the following hardware and software to use the ioThinX 4510 Series.

- A power source that provides 12 to 48 VDC, and power wires
- A PC running a Windows OS with Chrome installed and an Ethernet cable
- 45MR modules, if available
- IOxpress software utility (optional)
- Moxa CLI Configuration Tool (optional)

## Safety Precautions

Please observe the following safety precautions when installing and using the ioThinX 4510 Series:



### DANGER

Never work on the device while the power source is switched on. Disconnect all power sources to the device before performing installation, repair, or maintenance work.



### DANGER

Disconnect the power when you want to remove or replace components, or disconnect equipment unless the area is known to be free of ignitable substances.

- If you connect or disconnect the Removable Terminal Block when field power is applied, an electrical arc can occur. This could cause an explosion when installed in hazardous locations. Ensure that power is removed or the area is nonhazardous before installation.
- If you connect or disconnect wiring while the power is on, an electrical arc can occur. This could cause an explosion in hazardous environments. Ensure that power is removed or the area is nonhazardous before installation.
- Do not disconnect the unit unless the power has been disconnected or the area is known to be nonhazardous. In a hazardous area, the unit must be powered down before removing it.



### WARNING

This unit is sensitive to Electrostatic Discharge, which can cause internal damage and affect operations. Follow these guidelines when you handle this unit:

- Touch a grounded object to discharge potential static.
- Wear an approved grounding wristband.
- Do not touch connectors or pins on component boards.
- Do not touch circuit components inside the equipment.
- Use a static-safe workstation, if available.
- Store the device in appropriate static-safe packaging when not in use.



### WARNING

Check the voltage supplied by the power source. Make sure the voltage provided by the power source matches the voltage required by the device.



**WARNING**

Check the voltage or current of the sensors or loads. Make sure the voltage and/or current indicated on the sensors or loads corresponds to the specifications of your 45M module before you connect the device.

**WARNING**

Connect your device to an earthed ground.

**CAUTION**

Do not use the device if the device is already damaged. Replace defective or damaged devices to ensure that your devices function properly.

**CAUTION**

Do not attempt to repair the device yourself. If your device needs to be repaired, return the device to Moxa's customer service department. Attempting to repair the device yourself could invalidate the device's warranty.

## Additional Resources

Refer to the following documents for additional information.

- Datasheets for the following products:
  - ioThinx 4510 Series
  - ioThinx 4500 Series (45MR) Modules
- User's Manual for the following products:
  - ioThinx 4500 (45M) Module Series
  - Moxa CLI Configuration Tool

## Product Overview

---

In this chapter, we give an overview of each of the 45MR modules.

The following topics are covered in this chapter:

- ❑ **Technical Data**
  - Common Specifications
- ❑ **Appearance**
  - Front View
  - Physical Dimensions
- ❑ **LED Indicators**

# Technical Data

## Common Specifications

### Input/Output Interface

**Expansion Modules:** Up to 32

**Note:** Compatible with 45MR Series only

### Ethernet Interface

**10/100BaseT(X) Ports (RJ45 connector):** 2

### Ethernet Software Features

#### Industrial Protocols:

Modbus TCP Server (Slave)

RESTful API

SNMPv1/v2c/v3

### Serial Interface

**Serial Standards:** 1 x RS-232/422 or 2 x RS-485 (2-wire)

**Connector:** Removable Terminal block

**Wiring:** 16 to 28 AWG

### Serial Software Features

**Industrial Protocols:** Modbus RTU Client (master)

### System Power Parameter

**Input Voltage:** 12 to 48 VDC

**Connector:** Removable terminal block

**Wiring:** 12 to 26 AWG

### Field Power Parameter

**Input Voltage:** 12/24 VDC

**Connector:** Removable terminal block

**Wiring:** 12 to 26 AWG

### Physical Characteristics

**Dimensions:** 42.3 x 99 x 75 mm (1.67 x 3.9 x 2.69 in)

**Installation:** DIN-rail

### Environmental Limits

#### Operating Temperature:

Standard Models: -20 to 60°C (-4 to 140°F)

Wide Temp. Models: -40 to 75°C (-40 to 167°F)

# Appearance

## Front View

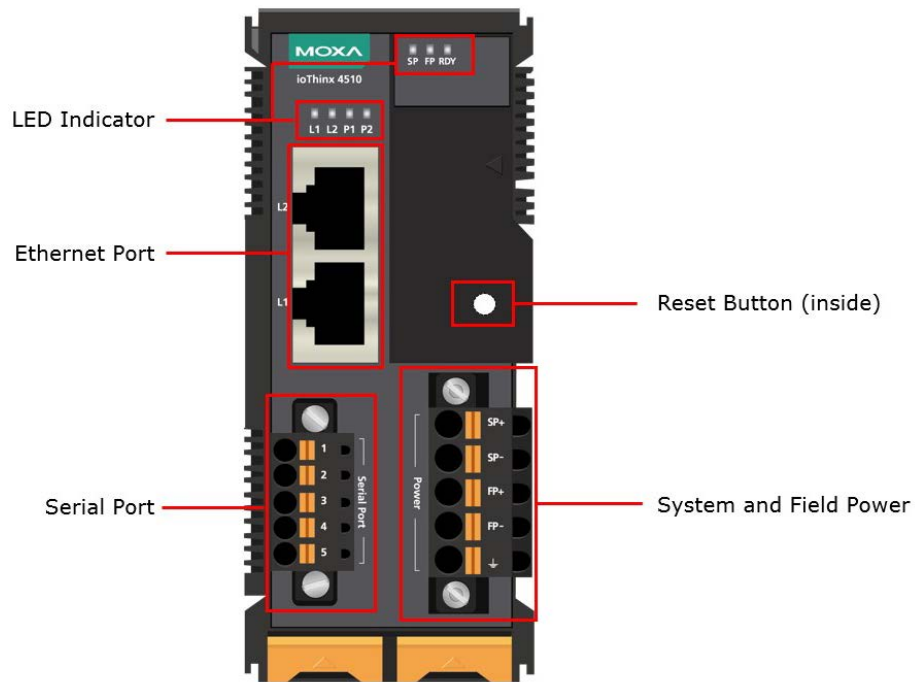

# Physical Dimensions

Unit: mm (in)

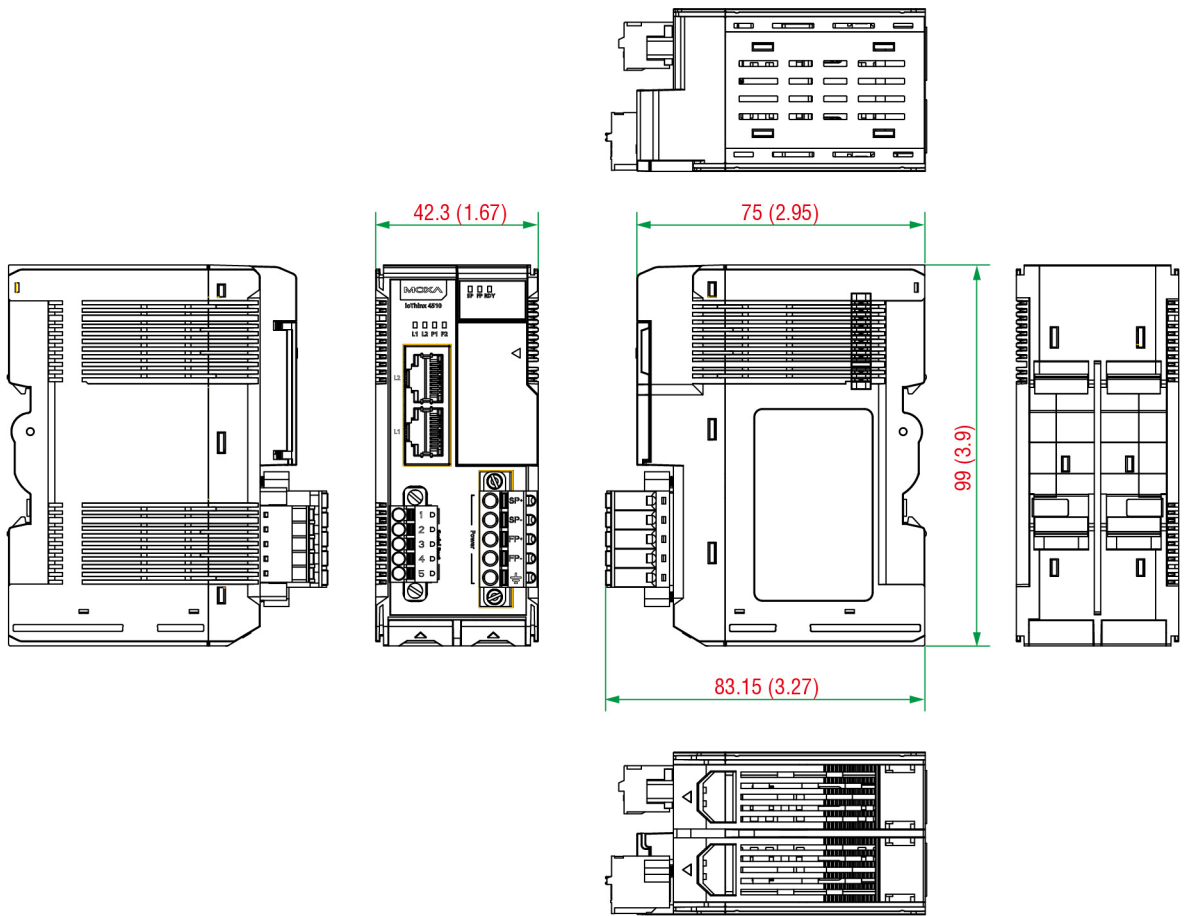

# LED Indicators



Labeling	Indication	LED Qty	LED Color	LED Action
SP	System Power	1	Green	On: power on Off: power off
FP	Field Power	1	Green	On: power on Off: power off
RDY	System (Kernel)	1	Green/Red	Green: system ready Green slow blinking: booting up Red: system error or module mismatch Red slow blinking: loading factory default settings, upgrading firmware, or system recovery Red fast blinking: safe mode Off: power off
L1/L2	Ethernet	1 for each	Green/Amber	Green: 100mb Amber: 10mb Blinking: data transmitting Off: disconnected
P1/P2	Serial	1 for each	Green/Amber	Green: Tx Amber: Rx Non-simultaneous blinking: data transmitting Off: disconnected or no data transmitting

**NOTE** DO NOT DISCONNECT THE POWER OR NETWORK CABLE when the RDY LED is blinking slowly.

**INFORMATION** Refer to **Failed to Enter System Ready Mode** in the troubleshooting section for addition information about the system recovery process.

# Hardware Installation

---

In this chapter, we describe how to install the 45MR modules.

The following topics are covered in this chapter:

❑ **Wiring System and Field Power**

- System Power
- Field Power

❑ **Wiring Ethernet Ports**

❑ **Wiring Serial Port(s)**

❑ **Grounding the Unit**

- Connecting the System Power Ground
- Connecting the Field Power Ground

❑ **Mounting the Unit**

- Installing the Unit on a DIN Rail
- Removing the Unit from a DIN Rail
- Installing Covers on the Device and the Right-Most I/O Module
- Removing a Cover from the Right-Most Module
- Horizontal Installation

❑ **Powering on the Unit**

# Wiring System and Field Power

Wire range: 12 to 26 AWG (Ferrule diameter: 2.0 to 0.4 mm)

Wire strip length: 10 mm

Unit: mm (in.)

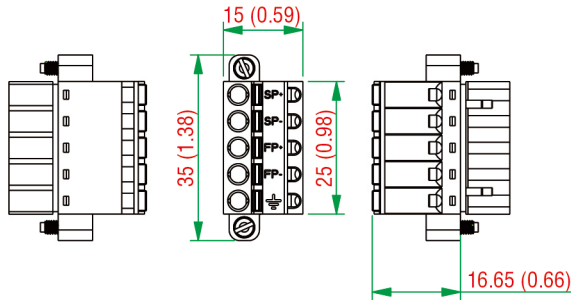

**NOTE** Powering the unit requires connecting both the system and field power to the power supply. If only one of the power sources is connected, the device may not work properly.

**NOTE** We recommended using different power supplies to ensure that the system power and field power are isolated from each other. If using the same power supply for system power and field power, 3 KV or above isolation between them is recommended.

## System Power

This device requires a 12 to 48 VDC system power input. The system power powers this device and the expansion modules via an internal bus, which is galvanically connected to the system power supply.

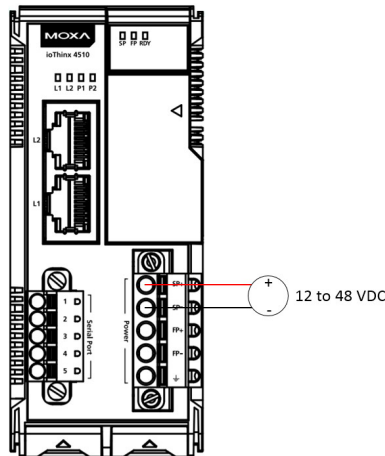

The amount of system current required to support an expansion module is 1 A. If more modules and more power consumption is needed, an additional power module (45MR-7210) is required. Below is an example:

- 10 x 45MR-1600 (59.4 mA) = 594 mA
- 5 x 45MR-3810 (187 mA) = 935 mA

The total system current is 1.594 A, which is greater than 1 A. Therefore, an additional 45MR-7210 is needed.

**NOTE** Install the 45MR-7210 to the left hand side of the module where the power consumption would be exceeded.

**NOTE** To avoid damaging your devices, reset all power supplies connected to this device and 45MR-7210 modules at the same time.



## Field Power

This device provides 12/24 VDC field power input, which is a passive power supply without protection and the maximum current output is 2 A.

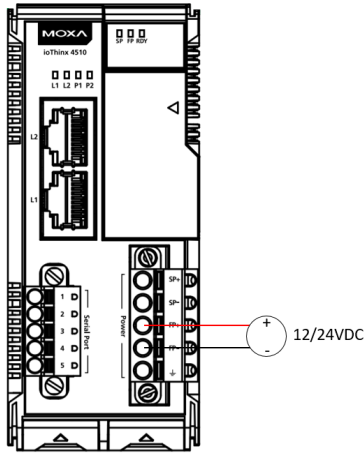

**NOTE** The 12/24 VDC field power supply can be connected directly to 45MR modules. If more connection points are needed, purchase 45MR-7820 (8 x FP+ and 8 x FP-) modules.

## Wiring Ethernet Ports

The maximum cable length of a 10/100BaseT connection is usually stated as 100 m (350 feet), but the actual limit for your application could be longer or shorter depending on the amount of electrical noise in the environment. To minimize the amount of noise, Ethernet cables should not run parallel to power cables or other types of cables that generate electrical noise. The following diagram and table shows the pin assignments for the RJ45 Ethernet ports:

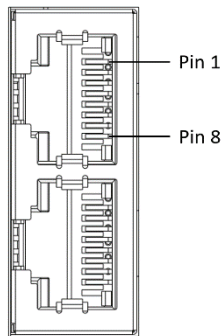

Pin	Media Direct Interface Signal
1	Tx+ (transmit)
2	Tx- (transmit)
3	Rx+ (receive)
4	Not used
5	Not used
6	Rx- (receive)
7	Not used
8	Not used

## Wiring Serial Port(s)

Wire range: 16 to 28 AWG (Ferrule diameter: 1.2 to 0.3 mm)

Wire strip length: 9.0 mm

Unit: mm (in.)

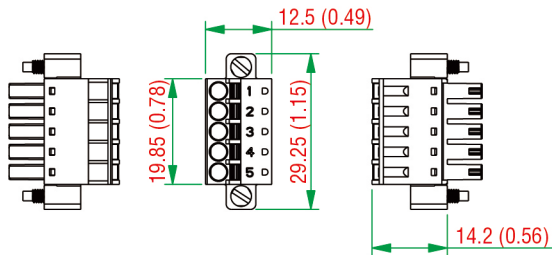

Pin	RS-232	RS-422	RS-485 (P1/P2)
1	TXD	TXD+	DATA1+
2	RXD	TXD-	DATA1-
3	RTS	RXD+	DATA2+
4	CTS	RXD-	DATA2-
5	GND	GND	GND

**NOTE** Connect the signal common pin (e.g. GND pin on the serial port pin assignment) between each of the serial device units. For insulated wire (shielding cable) that is used to reduce electrical noise, connect the cable shield drain wire to the chassis ground.

**NOTE** To ensure that wires are securely connected to terminal block connectors, strip 7 to 9 mm of insulation off the ends of the wires before connecting them to the terminal block.

# Grounding the Unit

This device has two ground pins. One pin is for system power and the other pin is for field power.

## Connecting the System Power Ground

The system power ground connector is at the back of the unit. Once the device has been installed on a DIN rail, the system power ground connector will connect to the DIN rail.

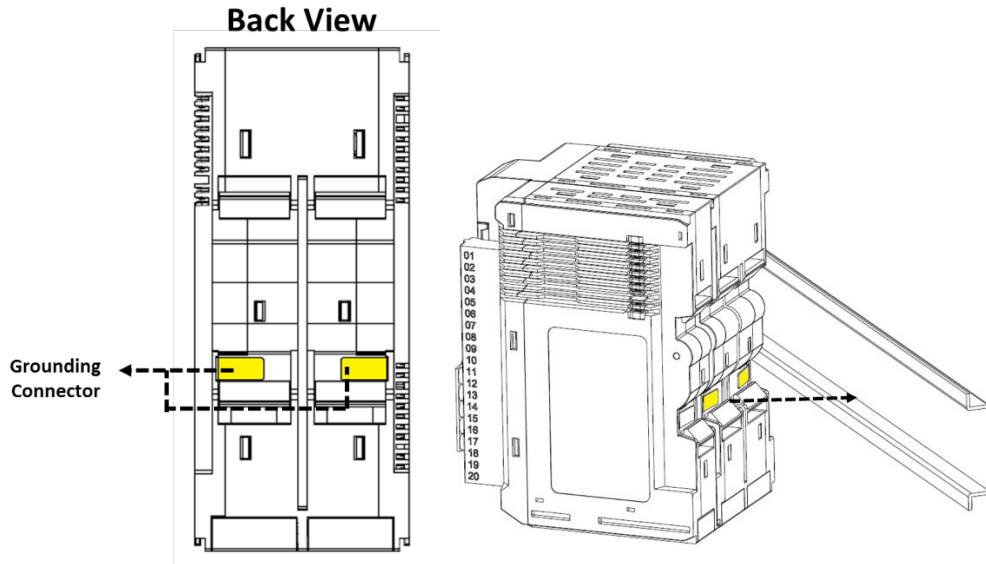

### CAUTION

For surge protection, connect the DIN rail to earth ground.

## Connecting the Field Power Ground

Connect the field power ground pin ( $\ominus$ ) to your field power ground.

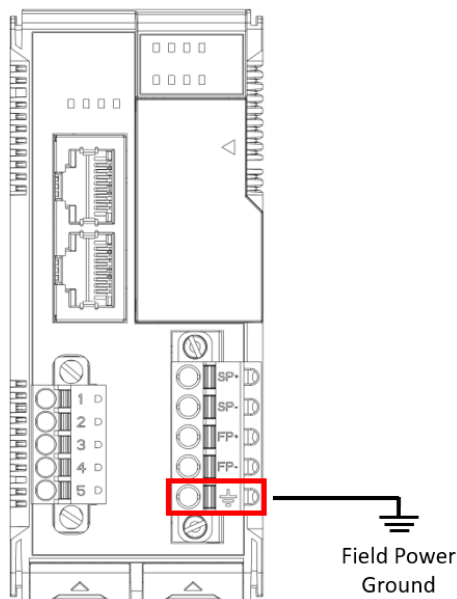

**CAUTION**

Be sure to note the maximum possible current for each power wire and common wire. Observe all electrical codes dictating the maximum current allowable for each wire size. If currents exceed the maximum rating, the wires will overheat, which could cause serious damage to your equipment. For safety reasons, we recommend using 2 mm diameter wire to connect to the power supply (e.g., 12 AWG).

## Mounting the Unit

In this section, we describe how to mount the device on a DIN rail and how to unmount the device from a DIN rail.

**DANGER**

Never install the device while the power source is switched on.

## Installing the Unit on a DIN Rail

Take the following steps to install the unit on a DIN rail.

**Step 1:** Hook the mounting clip of the unit onto the DIN rail, and then lower the clip onto the DIN rail. At least 55 mm of space above the DIN rail should be kept free to ensure that the installation can be done correctly.

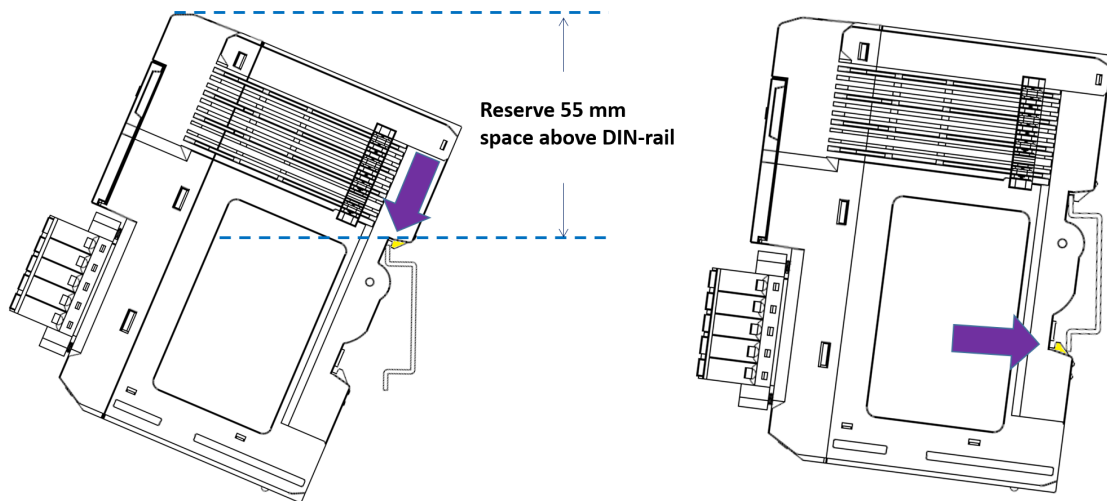

**Step 2:** Push the unit towards the DIN rail until the end of the mounting clip snaps into place.

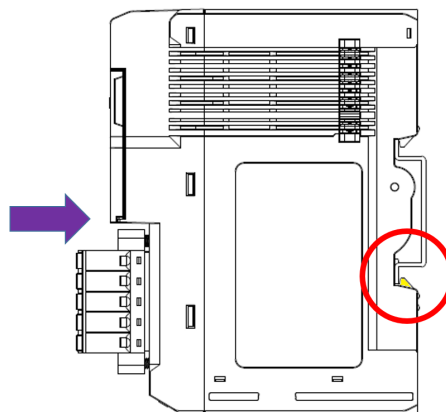

**INFORMATION** When the I/O module is inserted into the correct position, the connection between the internal bus and the previous module is established.

## Removing the Unit from a DIN Rail

Take the following steps to remove the unit from a DIN rail.

**Step 1:** Use your finger to pull the release tab on the lower part of the module.

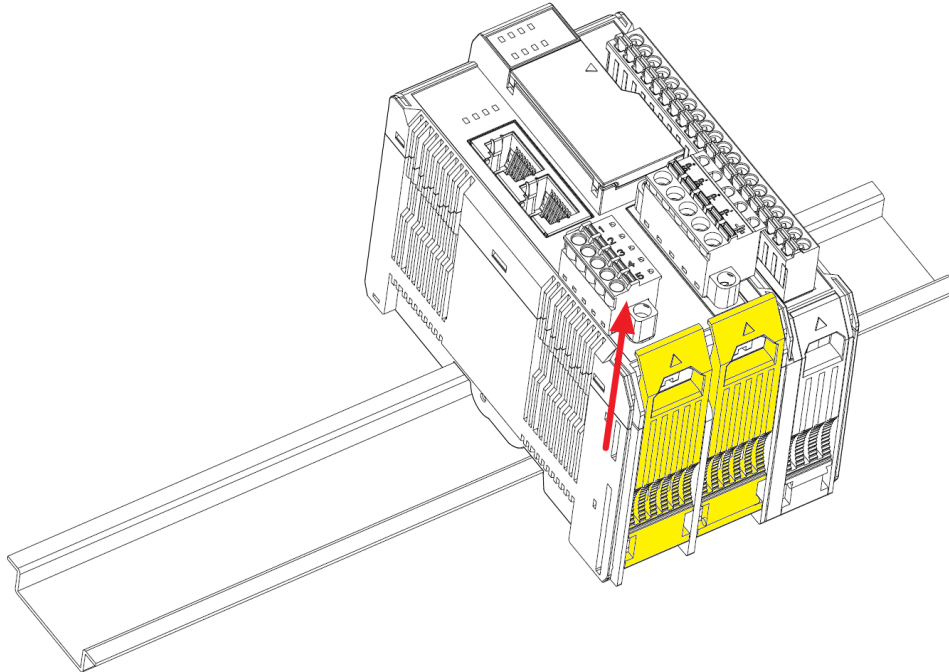

**Step 2:** Press the release tab (item 1 in the figure) and then remove the CPU module from the DIN rail (item 2 in the figure).

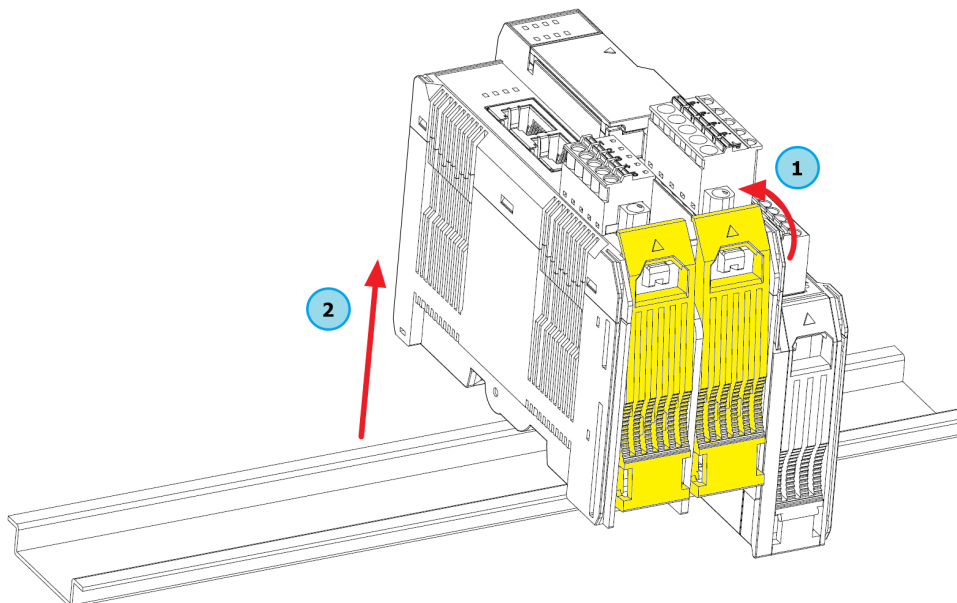

**NOTE** Disconnect all connections, including Ethernet, serial, and power cables, from the device before removing the device from the DIN rail.

## Installing Covers on the Device and the Right-Most I/O Module

Insert the covers on the left side of the device and on the right side of the I/O module that is installed furthest to the right. Make sure the covers cover the internal bus of the module.

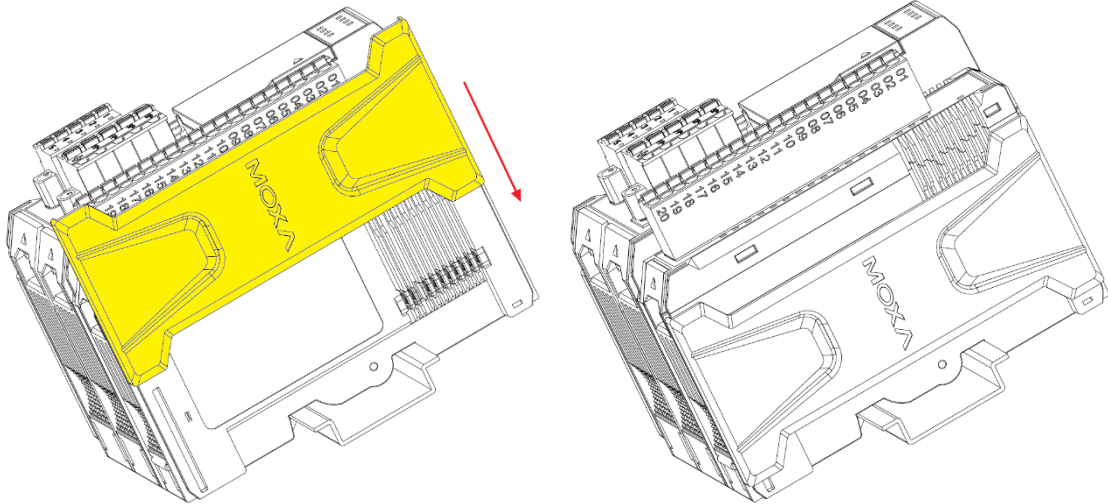

**NOTE** The covers provide protection against electrostatic discharge.

## Removing a Cover from the Right-Most Module

Before adding a new module to the right-most module, remove the cover first. Place your hand on the cover and slide it up as indicated in the diagram below.

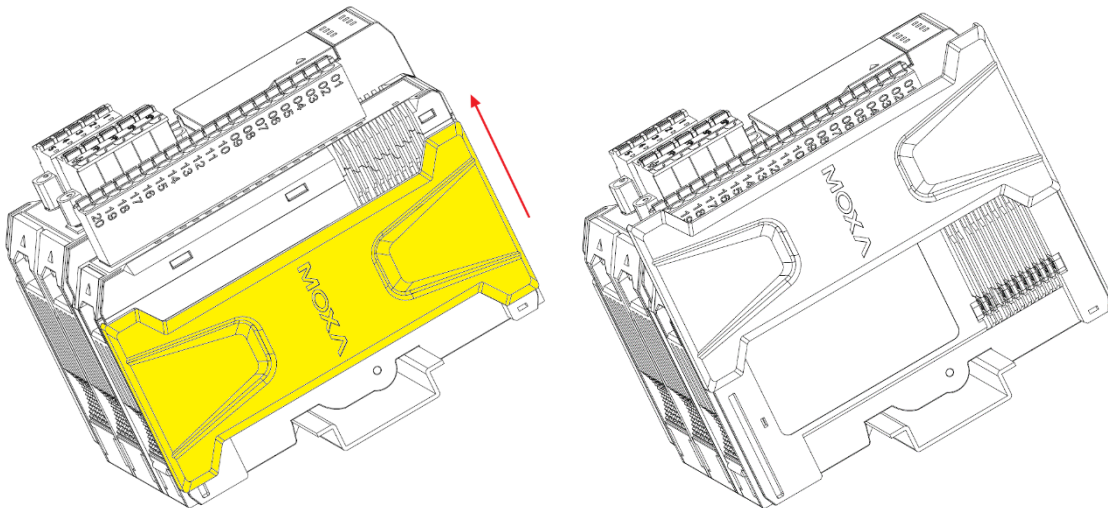

## Horizontal Installation

Before installing the device, ensure there is enough space around the device so that it can dissipate heat. In order to ensure the device works properly, we suggest reserving the space shown in the figure below.

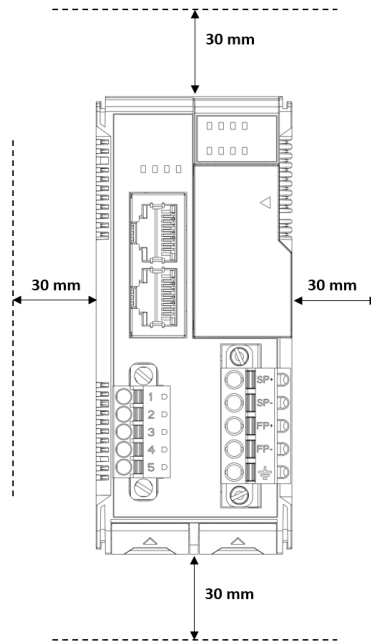

### CAUTION

DO NOT install the device vertically, as the fan-less heat dissipation design will not perform as intended.

## Powering on the Unit

After turning on the power supply, it will take 5 to 10 seconds for the operating system to boot up. The green Ready LED will illuminate continuously until the operating system is ready.

## Software Tools

---

In this chapter, we introduce which software tools can be used with this device.

The following topics are covered in this chapter:

### ▣ **Preparing Software Tools**

- Connecting Web Console
- Preparing IOxpress Utility
- Preparing Moxa CLI Configuration Tool

### ▣ **Web Console**

- Dashboard
- System
- Security
- Network
- Module
- Serial Port
- I/O
- Internal Register
- Protocol



# Preparing Software Tools

## Connecting Web Console

The Web Console is already embedded in this device. Use the web console to check the device status, configure settings, or update the firmware of the device. Follow the steps below to connect to the web console.

1. Connect the device to your PC through an Ethernet cable.
2. Power on the unit.
3. Open a web browser (Chrome is recommended) on your PC, and type the default IP address shown on the model label of the unit.

**INFORMATION** Type in the IP address (if the IP address is not set by default). If the IP address is not available, use the IOxpress utility to search for the device, or load the factory default settings by holding down the RESET button to access the device through the default IP address.

## Preparing IOxpress Utility

The IOxpress Utility can be downloaded from the Moxa website at [www.moxa.com](http://www.moxa.com). After downloading the file, unzip it and run setup.exe. The installation program will guide you through the installation process.

The IOxpress utility can be used for any of the purposes below. Multiple devices can be used at one time.

- Update configurations to the device
- Get configurations from the device
- Update firmware of the device
- Set device date and time
- Restart the device
- Load the factory default settings

Refer to the **Mass-deploying the Settings** section for detailed instructions.

**NOTE** The ioThinx 4510 Series is only compatible with IOxpress v2.2 or later.

## Preparing Moxa CLI Configuration Tool

Moxa CLI Configuration Tool (MCC\_Tool) can be downloaded from the Moxa website at [www.moxa.com](http://www.moxa.com). After downloading the file, unzip it and run setup.exe. The installation program will guide you through the installation process.

It is a command line tool that provides the following functions to manage field devices.

- Report firmware versions
- Upgrade firmware
- Import/export configuration files
- Change password

Management tasks can be performed according to which devices the user requires (1 for single device or 1 for multiple devices) and across different subnet networks.

Refer to **Moxa CLI Configuration Tool** User's Manual for detailed instructions.

# Web Console

The Web Console is the main software tool to configure, monitor, and operate a device. If mass deploying to multiple devices is required, use IOxpress utility instead.

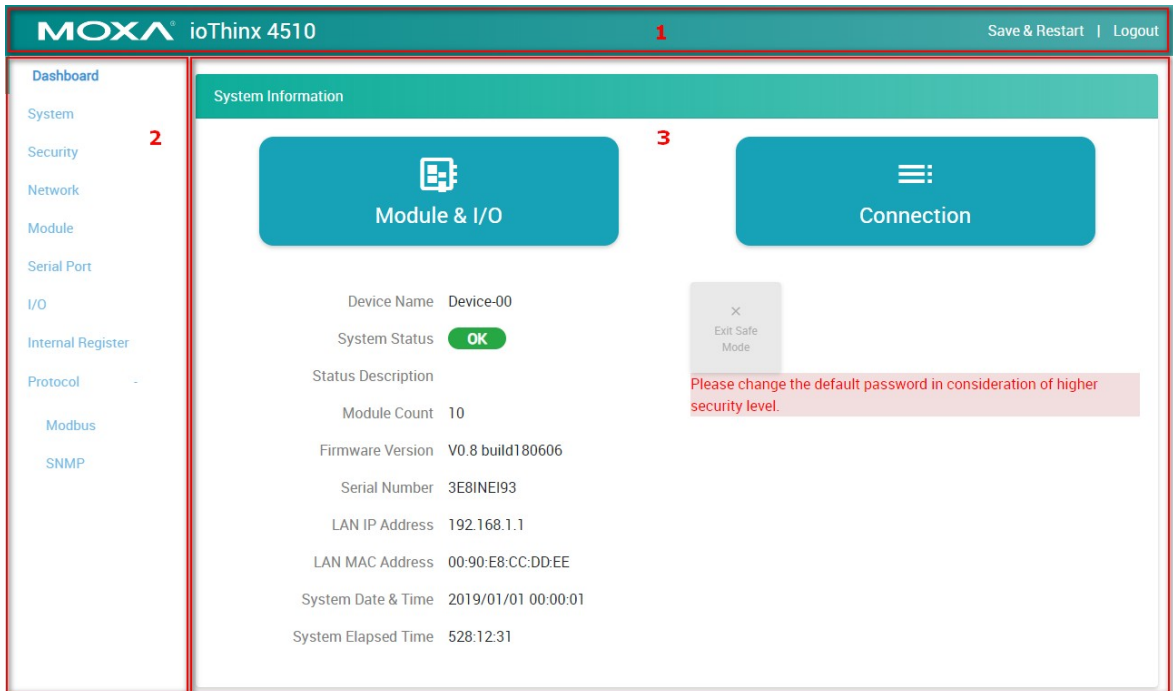

The Web Console is divided into three regions:

1. **Title Panel:** It provides Login, Save & Restart, and Logout functions.
2. **Menu panel:** It provides access to configure the functions or services.
3. **Web page panel:** The web page associated with the function selected in the Menu panel.

**INFORMATION** Whenever any configuration is modified, the **Save & Restart** will become red and blink. Click **Save & Restart** to make the changes effective.

Save & Restart | Logout

**NOTE** For security reasons, click **Logout** when no longer accessing this device. DO NOT leave the web console unattended.

## Dashboard

The dashboard provides information about the system, modules, I/Os, and the connection status. It also allows you to exit the safe mode status or to change the I/O status.

## System Information

The one page system information provides detailed information for this device. For information regarding modules and I/Os, click **Module & I/O** to get the detailed information. For the status of external connections, click **Connection** to get the detailed information.

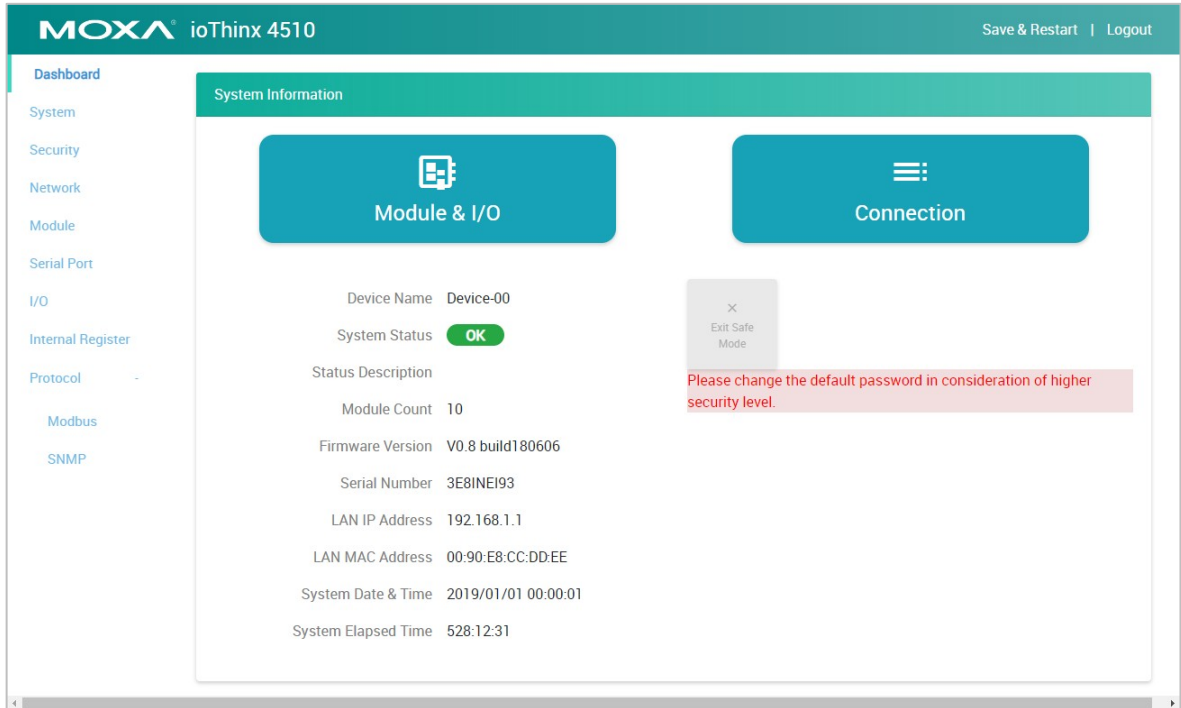

**Exit Safe Mode:** Manually exit the safe mode status of this device. Refer to the **Security** section for more information about the Safe Mode function.

## Module & I/O

The **Module & I/O** provides information about modules and I/Os status. It also allows you to change the I/O status.

**Module Drop-Down List:** It lists all of the I/O modules of this device. Select the specific module for its module and I/O information.

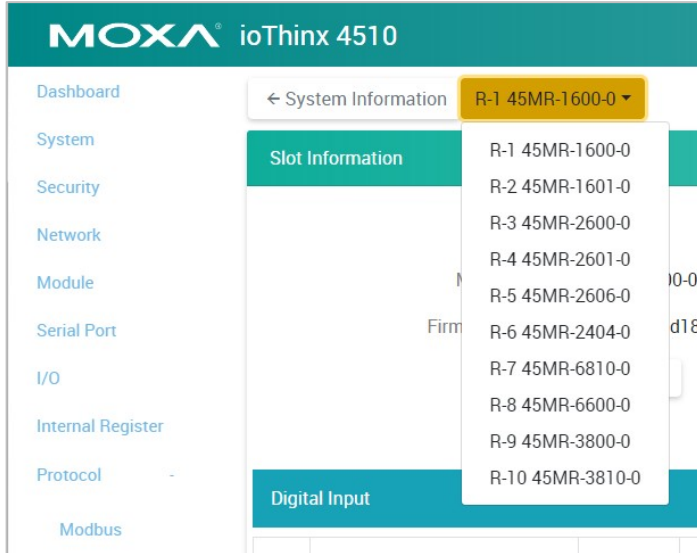

**Locate:** Identify the physical location of the module and the module's status LED will blink green.



**DI Channel (DI Mode):** It shows the status of this channel. No operation is allowed.

No.	Name	Mode	Value	Trigger	Filter	Status	Operation
0	DI-00	DI	--	--	500 us	On	--

**DI Channel (Counter Mode):** It shows the status of this channel. Type a value between 0 and 4294967295, and then click **SET** to set the current counter value. Click **RUN** or **PAUSE** to change the counter status.

No.	Name	Mode	Value	Trigger	Filter	Status	Operation
0	DI-00	Counter	65535	Rising edge	500000 us	Running	65535 <input type="button" value="SET"/> <input type="button" value="PAUSE"/>

**DO Channel (DO Mode):** It shows the status of this channel. Click **ON** or **OFF** to change the DO status.

No.	Name	Mode	ON Width	OFF Width	Pulse Count	Status	Operation
0	DO-00	DO	--	--	--	On	<input type="button" value="OFF"/>

**DO Channel (Pulse Mode):** It shows the status of this channel. Click **START** or **STOP** to change the pulse output status.

No.	Name	Mode	ON Width	OFF Width	Pulse Count	Status	Operation
0	DO-00	Pulse	500 us	500 us	10	Start	STOP

**Relay Channel:** It shows the status of this channel. Click **ON** or **OFF** to change the relay status.

No.	Name	Mode	Status	Operation
0	RELAY-00	Relay	On	OFF

**AI Channel:** It shows the status of this channel. Click **RESET** to reset the minimum and maximum values.

No.	Name	Scaled Range	Value	Min	Max	Min/Max
0	AI-00	0.000 - 20.000 mA	11.000 mA	8.000 mA	16.000 mA	RESET

**RTD Channel:** It shows the status of this channel. Click **RESET** to reset the minimum and maximum values.

No.	Name	Sensor Type	Value	Min	Max	Min/Max
0	RTD-00	PT 50	1.000 C	-10.000 C	350.000 C	RESET

**TC Channel:** It shows the status of this channel. Click **RESET** to reset the minimum and maximum values. Apply the reference temperature value in the calibration field and click **SET** to execute calibration.

No.	Name	Sensor Type	Value	Min	Max	Min/Max	Calibration
0	TC-00	J TYPE	250.000 C	0.000 C	750.000 C	RESET	0 SET

## Connection

The connection page shows the connection status from other hosts. This information can assist you with managing your devices.

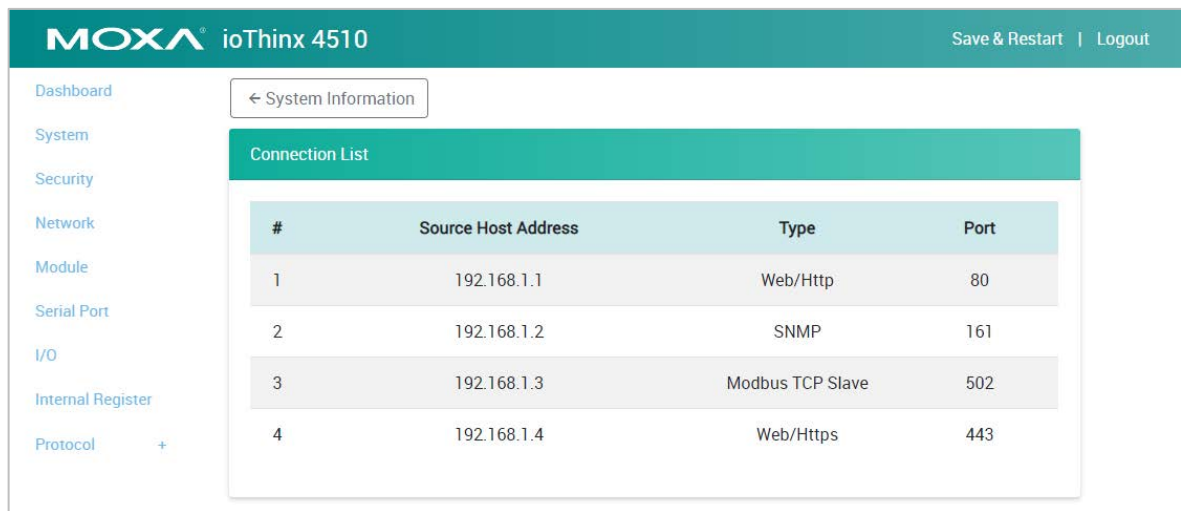

**MOXA<sup>®</sup> ioThinx 4510** Save & Restart | Logout

Dashboard  
System  
Security  
Network  
Module  
Serial Port  
I/O  
Internal Register  
Protocol +

← System Information

**Connection List**

#	Source Host Address	Type	Port
1	192.168.1.1	Web/Http	80
2	192.168.1.2	SNMP	161
3	192.168.1.3	Modbus TCP Slave	502
4	192.168.1.4	Web/Https	443

## System

This section introduces the functions of the device's system.

### Device Settings

**Device Name:** Set the name of this device (max length = 16, '.' is not allowed).

**Language:** Select the language of the web console.

### Time Settings

**System Date & Time:** Select the date for the device. Click **Set Time** to set the time of the device.

**Enable NTP Server:** Click the checkbox to enable date and time synchronization with the NTP sever.

**NTP Server:** Set the URL or IP address of the NTP server.

**Sync Interval:** Set the synchronization interval with the NTP sever (unit: min(s), 1 to 43200, default = 1440).

**INFORMATION** This device does not have a battery. Therefore, if the device is powered off, the system date and time will have to be set again. If the NTP server is not available, set the date and time of the device after rebooting.

## Watchdog

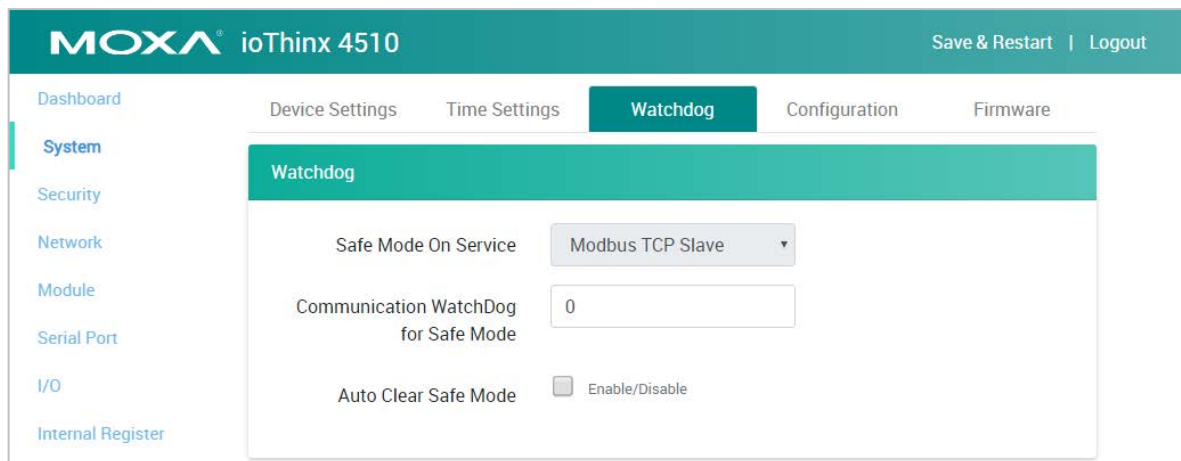

**Safe Mode on Service:** Select the service that you want to link the watchdog to in order to keep monitoring the connection status (option: Modbus TCP Slave).

**Communication Watchdog for Safe Mode:** The timeout value when the master of **Safe Mode on Service** is disconnected (unit: sec(s), 0 to 65535, 0 is disable).

**Auto Clear Safe Mode:** Click the checkbox to enable or disable automatically clearing the safe mode status.

Once the communication watchdog is timeout, the safe mode will be enabled. The behavior of ioThinX 4510 and 45MR modules are listed below:

	ioThinX 4510	45MR modules
<b>Behavior</b>	<ul style="list-style-type: none"> <li>Wait for Modbus/TCP Master’s re-connection</li> <li>Output channels cannot be controlled via any access e.g. RESTful API or web console</li> </ul>	<ul style="list-style-type: none"> <li>Input channels: no change</li> <li>Output channels: set the channel status according to pre-defined safe mode settings</li> </ul>
<b>LED status</b>	RDY: Red fast blinking	Status: Red fast blinking (applied to the modules which have output channels only)

Once the connection is recovered, the behavior of the ioThinX 4510 and 45MR modules are listed below.

1. Auto Clear Safe Mode: Enabled

	ioThinX 4510	45MR modules
<b>Behavior</b>	Recovered to normal status	Recovered to normal status
<b>LED status</b>	RDY: Green	Status: Green

2. Auto Clear Safe Mode: Disabled

	ioThinX 4510	45MR modules
<b>Behavior</b>	Status will remain on safe mode until the safe mode flag is cleared.	Status will remain on safe mode until the safe mode flag is cleared.
<b>LED status</b>	RDY: Red fast blinking until the error flag is cleared manually	Status: Red fast blinking until the error flag is cleared manually

**NOTE** To exit the safe mode status, click the "Exit Safe Mode" button on the dashboard or type "0" to the "watchdogAlarmFlagClear" register through Modbus. Otherwise, output channels cannot be controlled via any access e.g. RESTful API or web console.

## Configuration

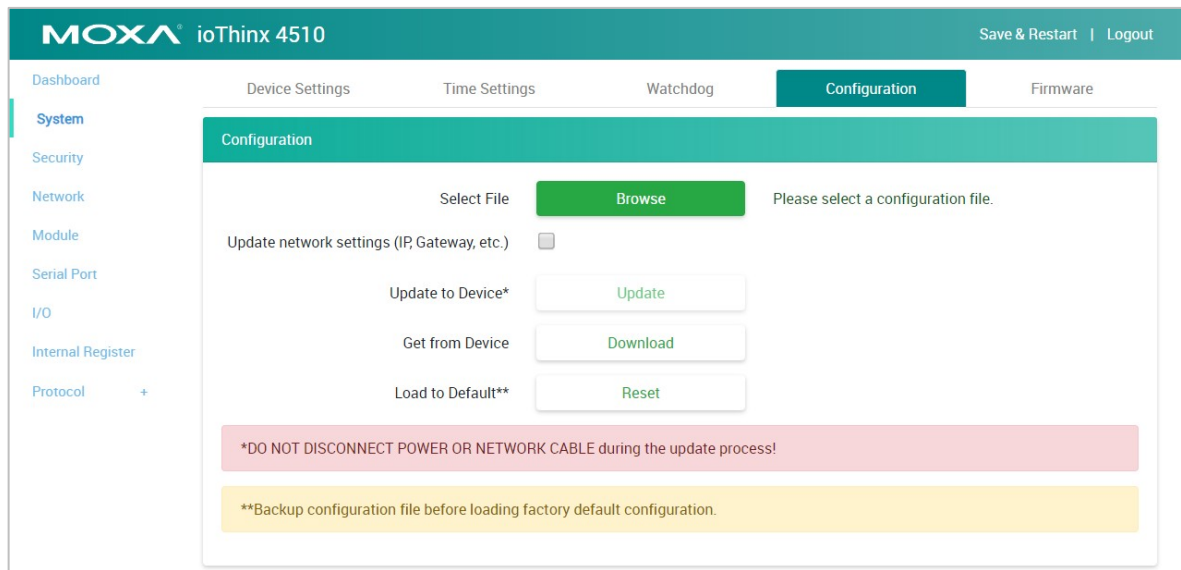

**Select File:** Click **Browse** to select a configuration file to update the device.

**Update network settings (IP, Gateway, etc.):** Click the checkbox if the network settings need to be updated.

**Update to Device:** Click **Update** to update the firmware to the device.

**Get from Device:** Get the configuration file of the device.

**Load to Default:** Load the factory default settings of the current firmware version.

**NOTE** Do not disconnect the power or network cable during the update process.

**INFORMATION** Back up the configuration file before loading the factory default configurations.

## Firmware

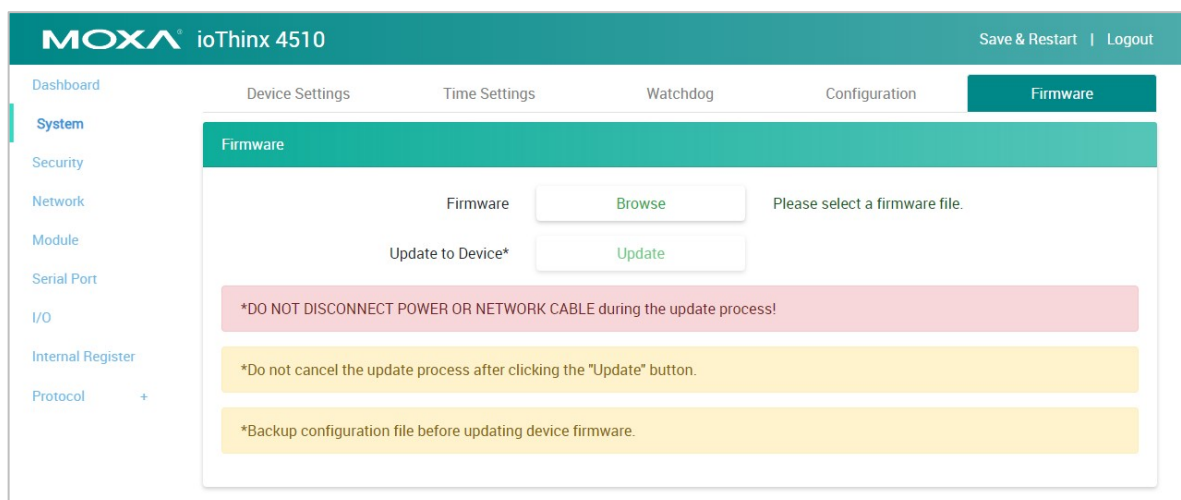

**Firmware:** Click **Browse** to select a firmware file to update the device.

**Update to Device:** Click **Update** to update the firmware to the device.



**NOTE** Do not disconnect the power or network cable during the update process.

**NOTE** This device supports firmware automatic recovery function. If the firmware in the device is corrupted, the system will load the backup firmware automatically to overwrite the corrupted one. When the system is in recovery mode, the RDY LED will slowly blink red. DO NOT DISCONNECT the power cable when the recovery process is underway. After the recovery process is complete, you can update the firmware again.

**INFORMATION** The update process cannot be canceled after "Update" is clicked.

**INFORMATION** Back up the configuration file before updating the device firmware.

## Security

The **Security** section allows you to manage the security policy of the device.

**NOTE** Do not expose the device to the public Internet without any security protection. To increase the security of the device, we suggest configuring security settings prior to other settings.

## Service Settings

Enable/disable services to prevent unwanted access. The Default configuration enables Web Server.

<input type="checkbox"/>	No.	Service	TCP/UDP	Port
<input checked="" type="checkbox"/>	1	Web Server	TCP	80
<input type="checkbox"/>	2	RESTful API	TCP	80
<input type="checkbox"/>	3	SNMP Agent	UDP	161
<input type="checkbox"/>	4	Modbus/TCP Slave	TCP	502
<input type="checkbox"/>	5	IOxpress/MCC Tool	TCP/UDP	10124/4800

**NOTE** If all services are disabled, this device will no longer be accessible, and you will need to load the factory default configurations to access the device.

## User Settings

Enable/Disable user type, or configure the username and password for Administrator, Operator, and Users.

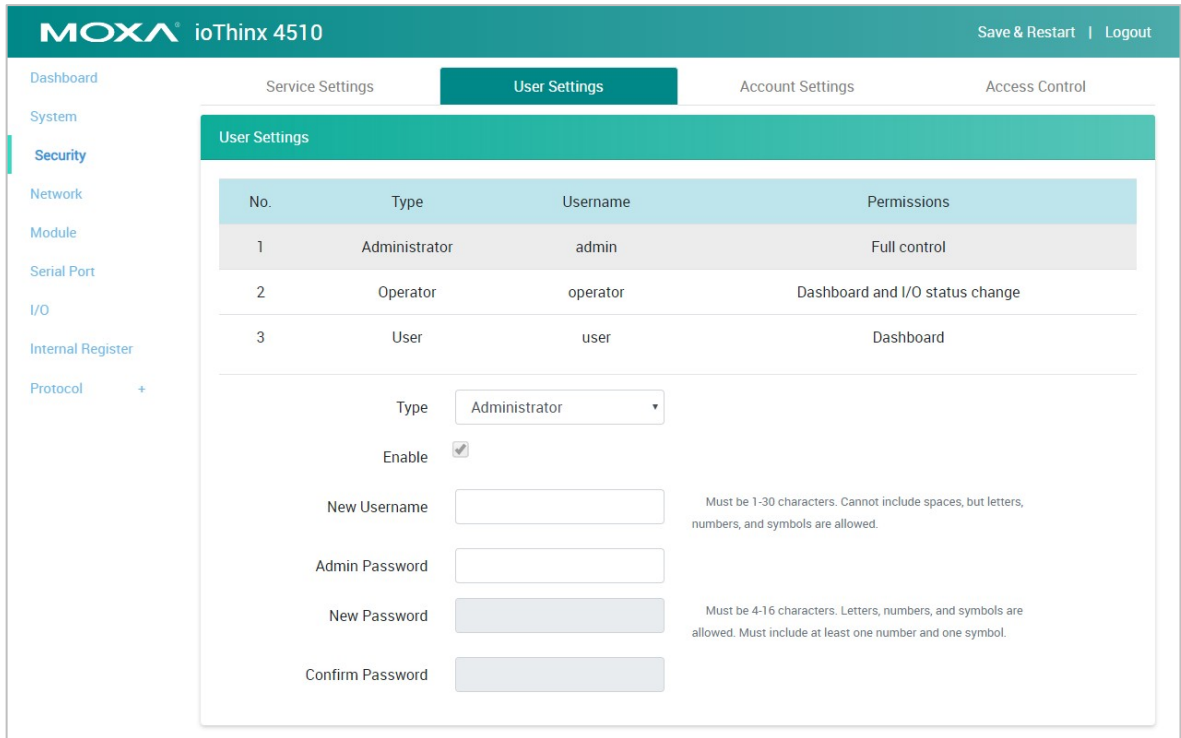

**Type:** Select a user type to change the username and password.

**Enable:** Enable or disable the type you select.

**New Username:** It allows you to change the username of the selected user type (Must be 1 to 30 characters in length. Letters, numbers, and symbols are allowed, but not spaces).

**Admin Password:** Type the password for the administrator to gain authorization to make changes.

**New Password:** It allows you to change the password of the selected user type (Must be 1 to 30 characters in length and include at least one number and one symbol. Letters, numbers, and symbols are allowed but spaces are not).

**Confirm Password:** Type in your new password again.

**NOTE** Change the default password in order to enhance security when you first login.

**INFORMATION** The default username is admin, and the default password is moxa.

## Account Settings

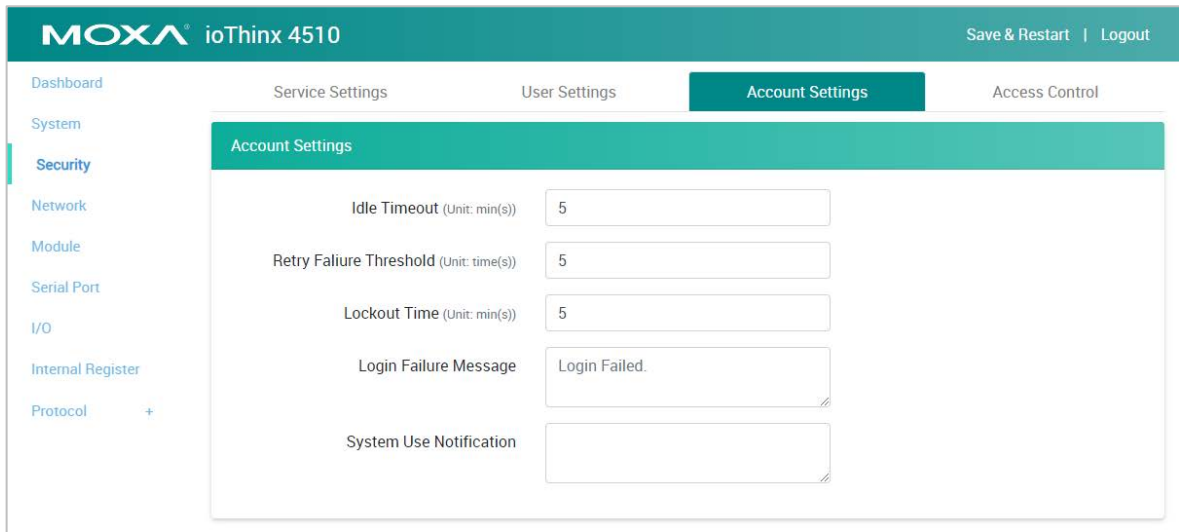

**Idle Timeout:** The timeout value when the user account is idle (unit: min(s), 0 to 1440 mins, default: 5 mins)  
Note: 0 for disabled.

**Retry Failure Threshold:** The maximum number of retries for the user account to log in (unit: time(s), 1 to 10 times, default: 5 times).

**Lockout Time:** The timeout value for when the user account will be locked due to reaching the retry failure threshold (unit: min(s), 1 to 60 mins, default: 5 mins).

**Login Failure Message:** Create the message shown on the login webpage after the user account fails to log in (character limit = 200).

**System Use Notification:** Define the message shown on the login webpage when the user account connects to the Web Console (character limit = 200).

## Access Control

Use IP Address/Netmask combinations to control which devices can access the device.

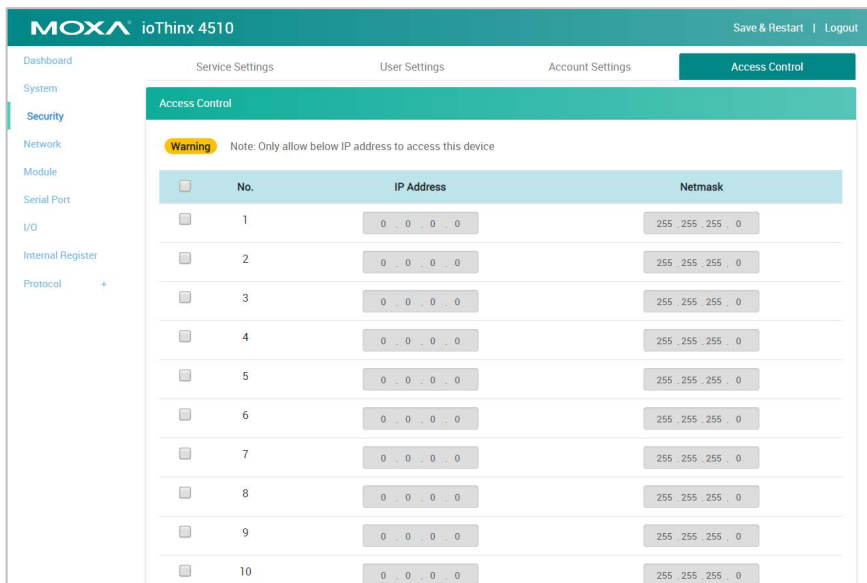

# Network

This section introduces the Network settings function.

## LAN Settings

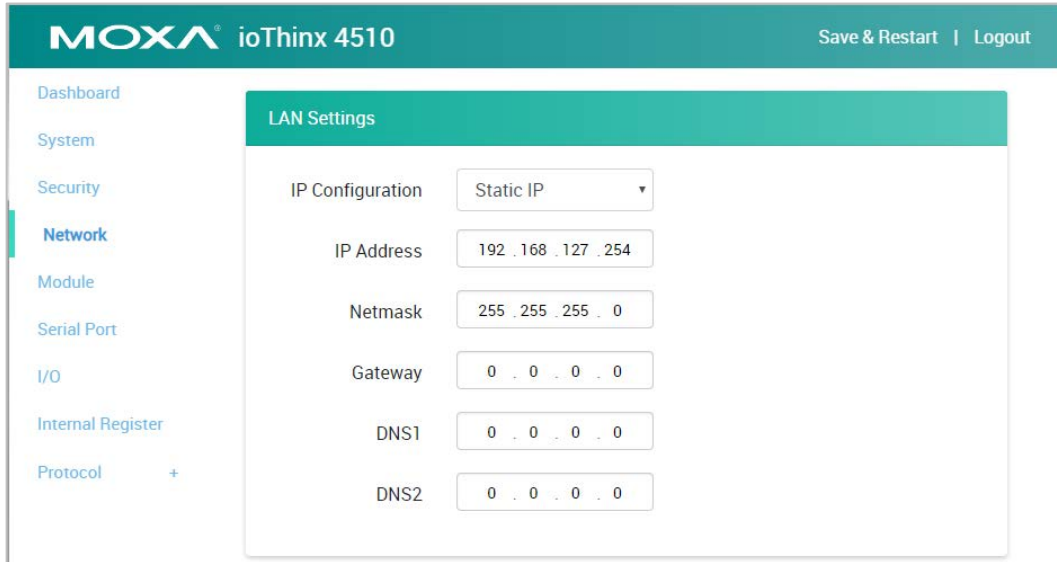

**IP Configuration:** Configure the following settings if **Static IP** is selected. If **DHCP** is selected, the following settings are not allowed (option: Static IP or DHCP).

**IP Address:** Set the IP address of the device (0 to 255).

**Netmask:** Define the logical subdivision of an IP network and specify the network's available hosts (0 to 255).

**Gateway:** Define the router that can route the network traffic to the other network or Internet (0 to 255).

**DNS1 and DNS2:** Define DNS server(s) that can translate URL to IP address (0 to 255).

**INFORMATION** The IP address of the device must be unique. Two devices in the network cannot share the same IP address as it causes an IP address conflict.

## Module

This section introduces the Module settings function.



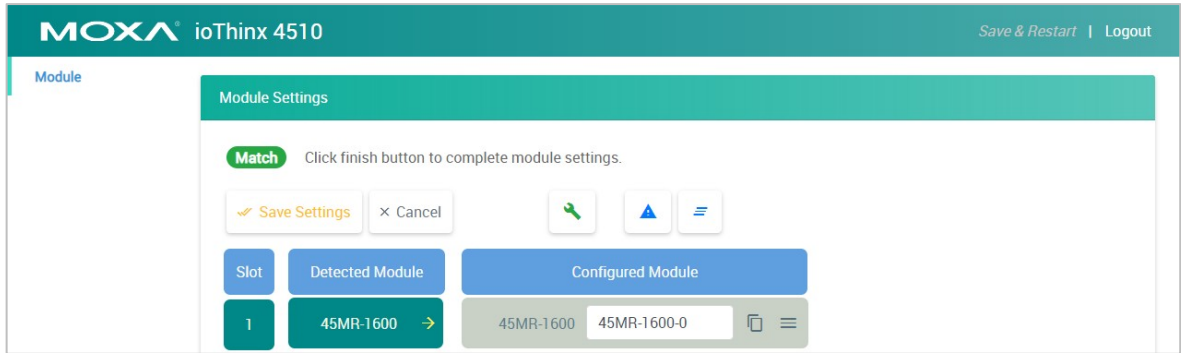

**Edit:** Click this button to enter edit mode.



**Save Settings:** This button only appears in edit mode. Click this button to finish module settings and exit edit mode.

**Cancel:** This button only appears in edit mode. Click this button to cancel module settings and exit edit mode.

**Auto Matching** : Click this button to automatically match all configured modules with all detected modules.

**Load Default** : Click this button to load the default settings of all configured modules.

**Reload** : Click this button to reload the module settings before entering edit mode.

**Slot:** The slot position of the detected module.

**Detected Module:** The physical module detected by the system. The yellow arrow allows you to insert the specific module into the configured module.

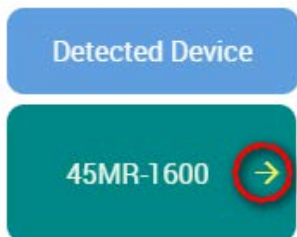

**Configured Module:** The module settings for the detected module. A unique module name is required in the textbox (max. length = 16, "." is not allowed).



The delete icon appears when you place your mouse over the place indicated below. It allows you to delete the configured module.



The drag icon allows you to drag the configured module and drop it to the position you need.



**NOTE** The detected module should match the configured module. Otherwise, the Web Console will not allow you to configure other settings.

**NOTE** The detected module should match the configured module. Otherwise, the Web Console will not allow you to click **Finish**.

**INFORMATION** Use **Auto Matching** to quickly match the configured module with the detected module.

**INFORMATION** Once the setting of a configured module is changed, the configured module will be highlighted by an orange rectangle.

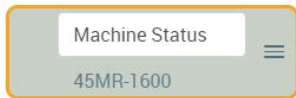

**INFORMATION** If the configured module does not match the detected module, the configured module will be highlighted by a red rectangle.

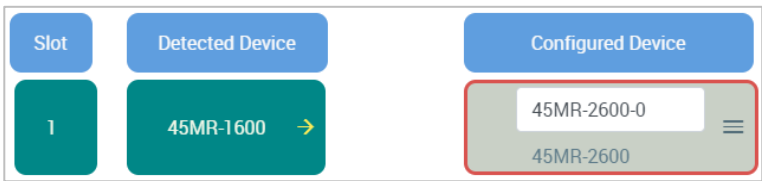

## Serial Port

This section introduces the serial port settings function.

### Port 1/Port 2

Click the tab to configure the settings of Port 1 or Port 2.

**NOTE** The Port 2 tab is only available when the **Mode** of the Port 1 is **RS-485 2-Wire**.

The screenshot shows the MOXA ioThinX 4510 web interface. The top navigation bar includes 'Save & Restart' and 'Logout'. The left sidebar contains a menu with 'Serial Port' selected. The main content area is titled 'Port Settings' and is divided into two tabs: 'Port 1' (active) and 'Port 2'. The settings for Port 1 are as follows:

Setting	Value
Mode	RS-485 2-Wire
Baudrate	9600
Parity	NONE
Data Bits	8
Stop Bits	1
Flow Control	None

**Mode:** The standard of the serial device connected to this port (option: RS-232, RS-422, or RS-485 2-Wire).

**Baudrate:** The data transmission rate (option: 300, 1200, 2400, 4800, 9600, 19200, 38400, 57600, or 115200 bps).

**Parity:** The method of detecting errors in transmission (option: Even, Odd, or None).

**Data Bits:** The data bits in each character (option: 5, 6, 7, or 8).

**Stop Bits:** The stop bits sent at the end of every character (option: 1 or 2).

**Flow Control:** The handshaking method (option: None, RTC/CTS, or XON/XOFF).

## Modbus RTU Device

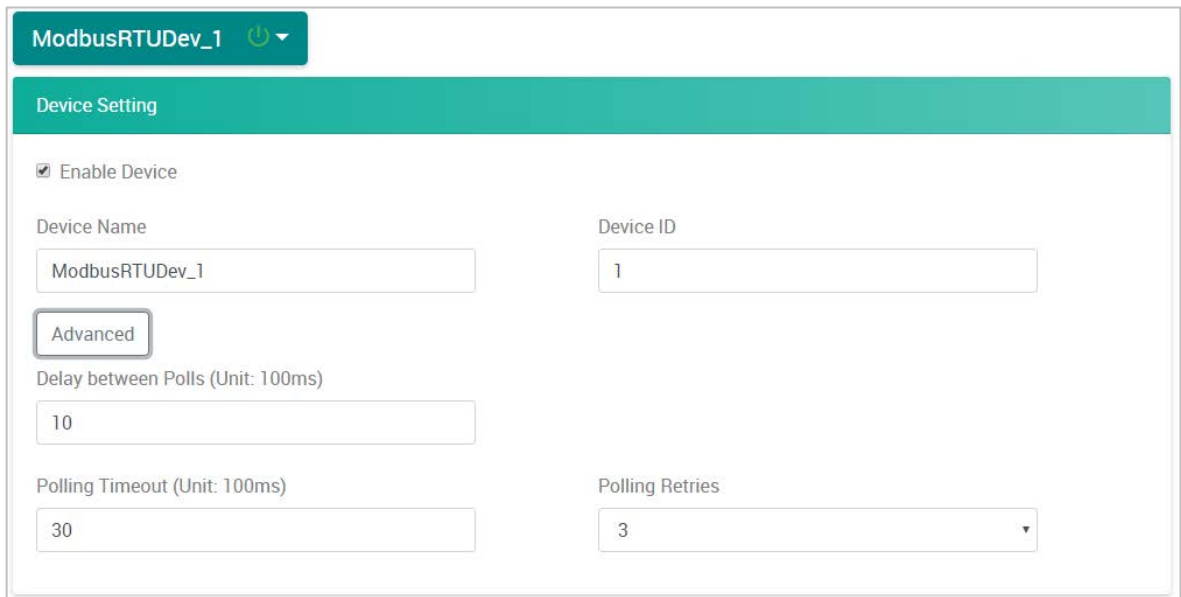

**Device Drop-Down List:** It shows the device name of the Modbus RTU devices. Select one of the devices to configure its settings. The green icon shows that data collection from the device is enabled.

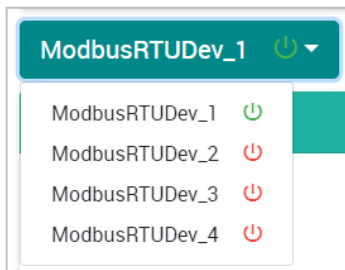

**Enable Device:** Click the checkbox to enable data collection from the device. The icon beside the Modbus device in the **Device Drop-Down List** will change from red to green after being enabled.

**Device Name:** Name of the Modbus device (max. length = 16; "." is not allowed).

**Device ID:** The device ID of this Modbus device (options: 1 to 247; default: 1).

**Advanced Button:** Click this button to show/hide the following settings.

**Delay between Polls:** The delay time after polling the Modbus register(s) of the Modbus device (unit: 100 ms; 100 to 3600000; 0 disabled; default: 10).

**Polling Timeout:** The timeout value when polling data from the Modbus device (unit: 100 ms; 0 to 30000; default: 30).

**Polling Retries:** The maximum number of retries after a polling timeout occurs (options: 0 to 10; default: 3).

**NOTE** A maximum of four Modbus RTU devices can be connected to one serial port when the RS-485 mode is selected.



## Modbus RTU Device Profile

Click **Add New Profile** to create a profile of the selected device.

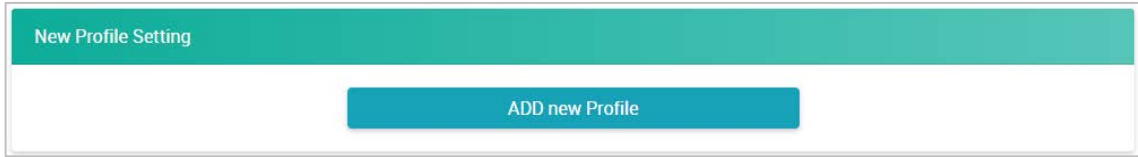

After creating a new profile, configure the settings of the profile.

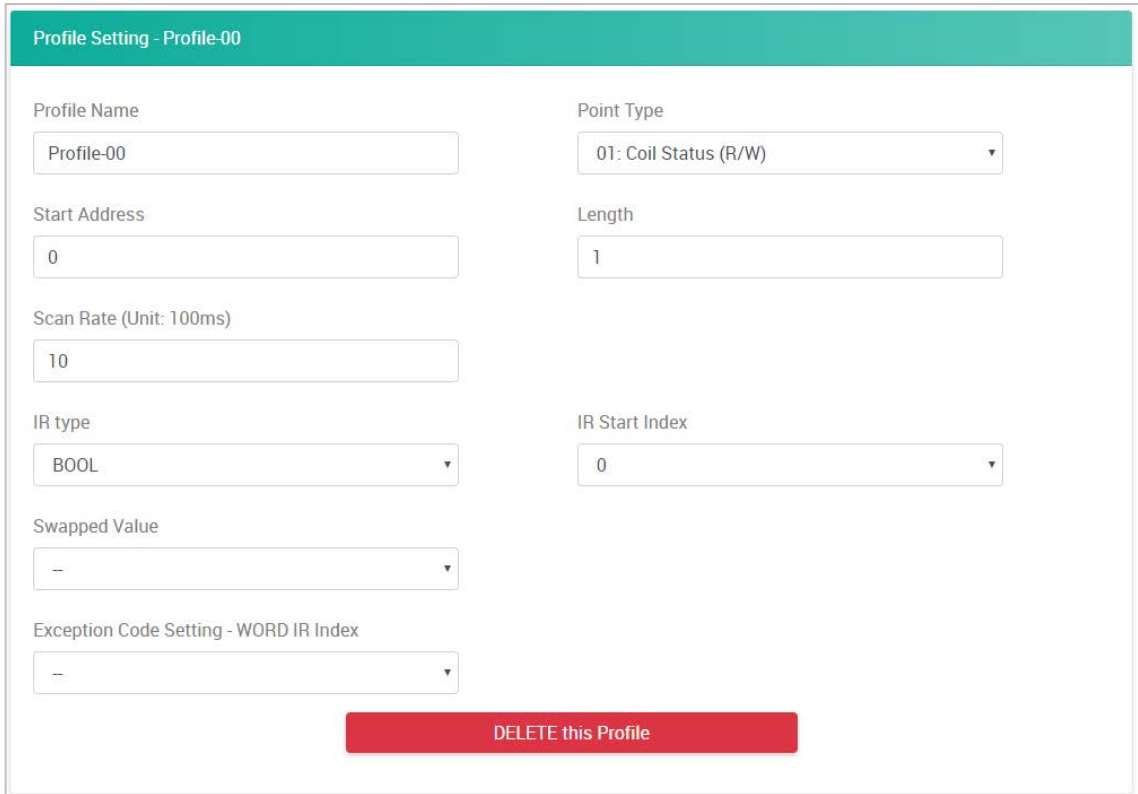

**Profile Name:** Name the profile of the Modbus device (max. length = 16; "." is not allowed).

**Point Type:** Set the corresponding Modbus point type setting (option: 01: Coil Status (R/W), 02: Input Status (R), 03: Holding Register (R/W), or 04: Input Register (R))

**Start Address:** Define the start address of this Modbus tag (0 to 65535).

**Length:** Define the length of the coil (1 to 2000) or the register (1 to 125).

**Scan Rate:** Define how quickly to poll the profile data (unit: 100 ms; 100 to 3600000; default: 10).

**IR Type:** Set the internal register data type (option: BOOL, WORD, DWORD, or FLOAT).

**IR Start Index:** Set the start number of the internal register for storing data. It only allows you to select available internal registers, depending on the length you define.

**Swapped Value:** Select a data conversion option.

IR Type	Option
WORD	1. HiByte & LoByte 2. LoByte & HiByte
DWORD	1. HiWord & LoWord 2. LoWord & HiWord
FLOAT	1. HiWord & LoWord 2. LoWord & HiWord

**Exception Code Setting - WORD IR Index:** Set the internal register for exception code. It only allows you to select one of the available internal registers.

**Delete this Profile:** Click this button to delete this profile.

**NOTE** The maximum number of Modbus RTU device profiles that can be created is 8.

## I/O

This section introduces the I/O and IR (Internal Register) settings functions.

### I/O Settings

**Module Drop-Down List:** It lists all the I/O modules of this device. Select the specific module for I/O configuration.

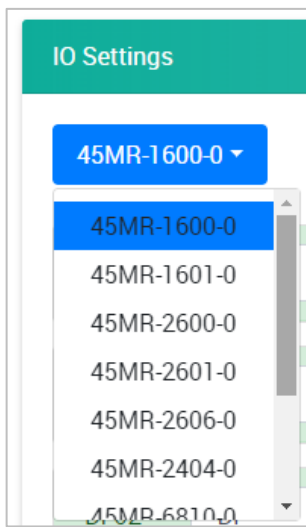

### Digital Input Channel Settings

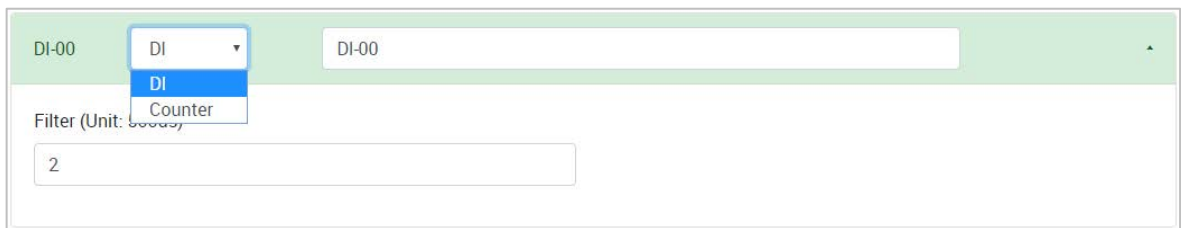

**Channel Mode Drop-Down List:** It lists all of the channel modes, which can be operated by this channel. Select **DI** or **Counter** mode for each channel (option: DI or Counter).

**Channel Name:** The channel name is used for representing this channel (max. length = 16, "." is not allowed).

**INFORMATION** Every channel in each module must have a different name.

**DI Mode**

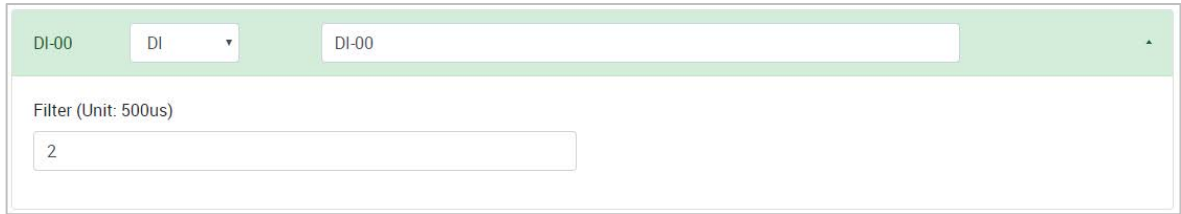

**Filter:** Software filtering is used to avoid switch bounces (unit: 500µs, 0 to 65535).

**Counter Mode**

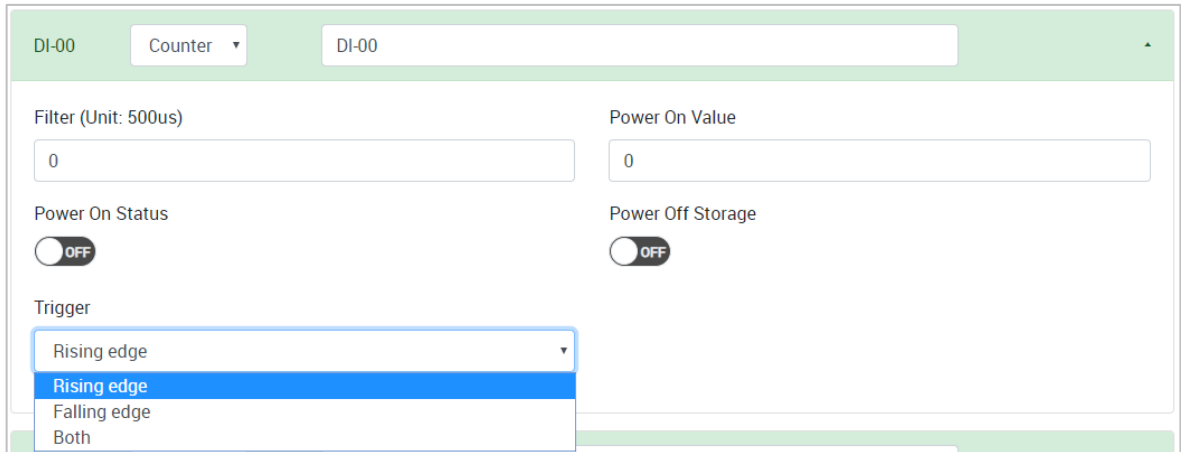

**Filter:** Software filtering is used to avoid switch bounces (unit: 500µs, 0 to 65535).

**Power on Value:** The initial counter value upon powering up (0 to 4294927695).

**Power on Status:** The counter status upon powering up (option: ON or OFF).

**Power off Storage:** Save counter value to memory during powering off. The saved value will be the initial value upon next powering up (option: ON or OFF).

**Trigger:** The channel accepts limit or proximity switches and counts events according to the ON/OFF status. When **Rising edge** is selected, the counter value increases when the attached switch is pushed. When **Falling edge** is selected, the counter value increases when the switch is released. When **Both** is selected, the counter value increases when the attached switch is pushed or released (option: Rising edge, Falling edge, or Both).

**NOTE** Not all DI channels support counter mode. Refer to the **ioThinx 4500 Series (45MR) Modules** datasheet for detailed specifications.

**Digital Output Channel Settings**

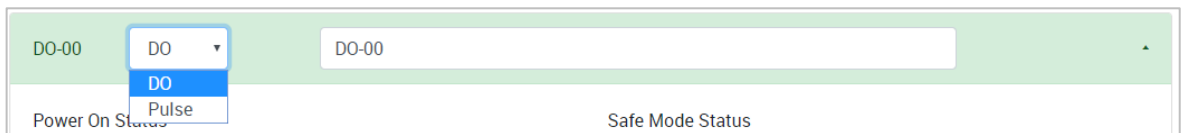

**Channel Mode Drop-Down List:** It lists all of the channel modes, which can be operated by this channel. Select **DO** or **Pulse** mode for each channel (option: DO or Pulse).

**Channel Name:** The channel name is used for representing this channel (max. length = 16, "." is not allowed).

**DO Mode**

DO-00
DO ▾
DO-00
▴

Power On Status

OFF

Safe Mode Status

OFF

Power On Delay (Unit: sec)

**Power on Status:** The DO status upon powering up (option: ON or OFF).

**Safe Mode Status:** The DO status when the device is in safe mode (option: ON or OFF).

**Power on Delay:** The time delay before triggering **Power on Status** after powering up (unit: sec(s), 0 to 65535).

**Pulse Mode**

DO-00
Pulse ▾
DO-00
▴

Power On Status

OFF

Safe Mode Status

OFF

Power On Delay (Unit: sec)

Pulse Count

ON Width (Unit: 500us)

OFF Width (Unit: 500us)

**Power on Status:** The Pulse status upon powering up (option: ON or OFF).

**Safe Mode Status:** The Pulse status when the device is in safe mode (option: ON, OFF, or Hold Last).

**Power on Delay:** The time delay before triggering **Power on Status** after powering up (unit: sec(s), 0 to 65535).

**Pulse Count:** The number of pulses per triggering (0 to 4294967295, "0" for continuous pulse output).

**On Width/Off Width:** The high and low level widths of a pulse (unit: 500µs, 1 to 65535).

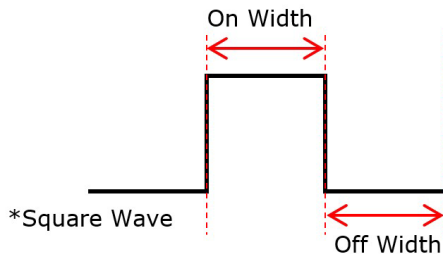

**NOTE** Not all DO channels support pulse mode. Refer to the **ioThinx 4500 Series (45MR) Modules** datasheet for detailed specifications.

## Relay Channel Settings

**Channel Name:** The channel name is used for representing this channel (max. length = 16, "." is not allowed).

**Power on Status:** The Relay status upon powering up (option: ON or OFF).

**Safe Mode Status:** The Relay status when the device is in safe mode (option: ON or OFF).

**Power on Delay:** The time delay before triggering **Power on Status** after powering up (unit: sec(s), 0 to 65535).

## Analog Input Channel Settings

### Current Module

### Voltage Module

**Channel Mode Drop-Down List:** It lists all of the channel modes, which can be operated by this channel. Select **0-20 mA**, **4-20 mA burnout**, or **4-20 mA** mode for each channel of the current module. Select **0-10 V** or **±10 V** mode for each channel of the voltage module.

**Channel Name:** The channel name is used for representing this channel (max. length = 16, "." is not allowed).

### Disable Mode

The AI channel can be disabled. It only allows you to disable the channel one-by-one from the last AI channel. When a channel has been disabled, the sample rate of the remaining channels will be increased automatically.

**0-20 mA/4-20 mA burnout/4-20 mA/0-10 V/±10 V Mode**

AI-00
4-20 mA burnout
AI-00

Burnout Value (Unit: mA)

1<sup>st</sup> Point Measured Value

2<sup>nd</sup> Point Measured Value

Unit

mA

1<sup>st</sup> Point Scaled Value

2<sup>nd</sup> Point Scaled Value

Scaled Unit

**Burnout Value (only for 4-20 mA burnout mode):** The 4–20 mA burnout mode is shown in the diagram below.

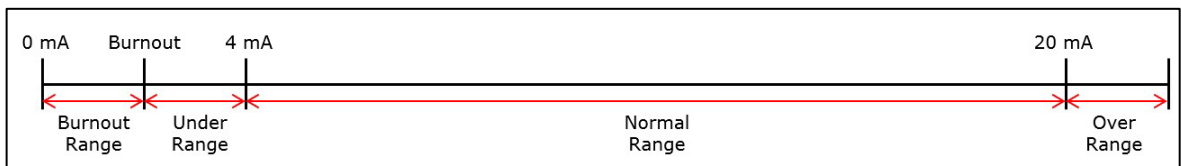

The Burnout Value (default = 2 mA) is definable (unit: mA, 0.000 to 4.000). When input values are in the burnout range, raw data will register as 0000h to indicate that the analog input has burned out. The definition of raw data can be found in the table below.

Range	Modbus Data
0.000 ≤ AI < Burnout Value	0x0000h
Burnout Value ≤ AI ≤ 20.000 mA	Raw Data
AI > 20.000 mA	0xFFFFh

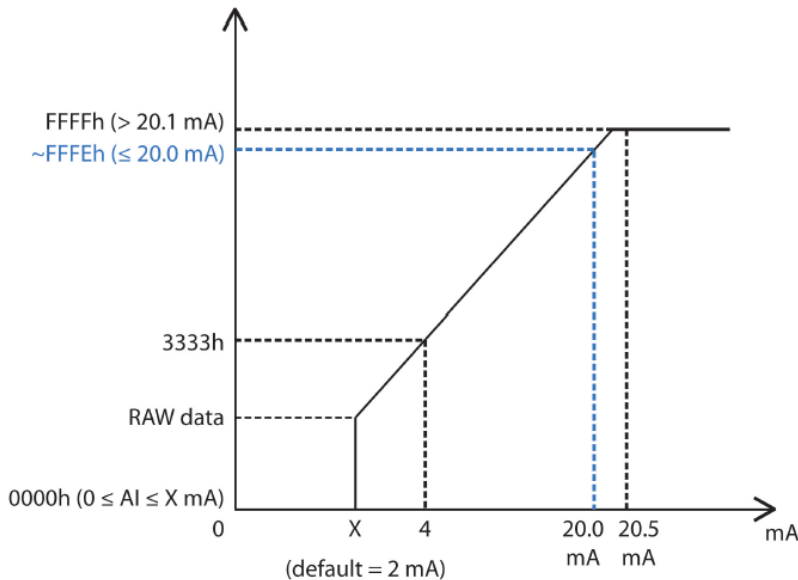

**1<sup>st</sup> Point Measured Value:** The 1<sup>st</sup> point value in the range of channel mode to be scaled to the **1st Point Scaled Value** (unit: mA, 4.000 to 20.000).

**2<sup>nd</sup> Point Measured Value:** The 2<sup>nd</sup> point value in the range of channel mode to be scaled to the **2nd Point Scaled Value** (unit: mA, 4.000 to 20.000).

**Unit:** The unit of the measured value.

**1<sup>st</sup> Point Scaled Value:** The scaled value of the 1<sup>st</sup> point (-4294967295 to 4294967295).

**2<sup>nd</sup> Point Scaled Value:** The scaled value of the 2<sup>nd</sup> point (-4294967295 to 4294967295).

**Scaled Unit:** The unit of the scaled value (max. length = 8, "." is not allowed).

### RTD Channel Settings

RTD-00	PT100	RTD-00
RTD-01	PT100	RTD-01
RTD-02	310 Ohm	RTD-02
RTD-03	JPT100	RTD-03
RTD-04	NI100	RTD-04
RTD-05	NI1000	RTD-05

**Sensor Type Drop-Down List:** It lists all of the sensor types, which can be connected to this channel. Select the sensor type for each channel (option: PT50, PT100, PT200, PT500, PT1000, 310 ohms, 620 ohms, 1250 ohms, 2200 ohms, JPT100, JPT200, JPT500, JPT1000, NI100, NI200, NI500, NI1000, or NI120).

**Channel Name:** The channel name is used for representing this channel (max. length = 16, "." is not allowed).

RTD-00	PT 100	RTD-00
1 <sup>st</sup> Point Measured Value	2 <sup>nd</sup> Point Measured Value	Unit
-200.000	850.000	C
1 <sup>st</sup> Point Scaled Value	2 <sup>nd</sup> Point Scaled Value	Scaled Unit
-200.000	850.000	C

**1<sup>st</sup> Point Measured Value:** The 1<sup>st</sup> point value in the range of channel mode to be scaled to the **1st Point Scaled Value** (acceptable input value depends on the type of sensor).

**2<sup>nd</sup> Point Measured Value:** The 2<sup>nd</sup> point value in the range of channel mode to be scaled to the **2nd Point Scaled Value** (acceptable input value depends on the type of sensor).

**Unit:** The unit of the measured value.

**1<sup>st</sup> Point Scaled Value:** The scaled value of the 1<sup>st</sup> point (-4294967295 to 4294967295).

**2<sup>nd</sup> Point Scaled Value:** The scaled value of the 2<sup>nd</sup> point (-4294967295 to 4294967295).

**Scaled Unit:** The unit of the scaled value (max. length = 8, "." is not allowed).

## TC Channel Settings

TC-00	<div style="border: 1px solid black; padding: 2px;">             K Type              J Type  <b>K Type</b>              T Type              E Type              R Type              S Type              B Type              N Type              ±78.126 mV              ±39.062 mV              ±19.532 mV           </div>	TC-00
TC-01		TC-01
TC-02		TC-02
TC-03		TC-03

**Sensor Type Drop-Down List:** It lists all of the sensor types, which can be connected to this channel. Select the sensor type for each channel (option: J Type, K Type, T Type, E Type, R Type, S Type, B Type, N Type, ±19.532 mV, ±39.062 mV, or ±78.126 mV).

**Channel Name:** The channel name is used for representing this channel (max. length = 16, "." is not allowed).

TC-00	K TYPE	TC-00
1 <sup>st</sup> Point Measured Value	2 <sup>nd</sup> Point Measured Value	Unit
-200.000	1250.000	C
1 <sup>st</sup> Point Scaled Value	2 <sup>nd</sup> Point Scaled Value	Scaled Unit
-200.000	1250.000	C

**1<sup>st</sup> Point Measured Value:** The 1<sup>st</sup> point value in the range of the channel mode to be scaled to the **1st Point Scaled Value** (acceptable input value depends on the type of sensor).

**2<sup>nd</sup> Point Measured Value:** The 2<sup>nd</sup> point value in the range of the channel mode to be scaled to the **2nd Point Scaled Value** (acceptable input value depends on the type of sensor).

**Unit:** The unit of the measured value.

**1<sup>st</sup> Point Scaled Value:** The scaled value of the 1<sup>st</sup> point (-4294967295 to 4294967295).

**2<sup>nd</sup> Point Scaled Value:** The scaled value of the 2<sup>nd</sup> point (-4294967295 to 4294967295).

**Scaled Unit:** The unit of the scaled value (max. length = 8, "." is not allowed).



# Internal Register

This section introduces functions of Internal Register settings.

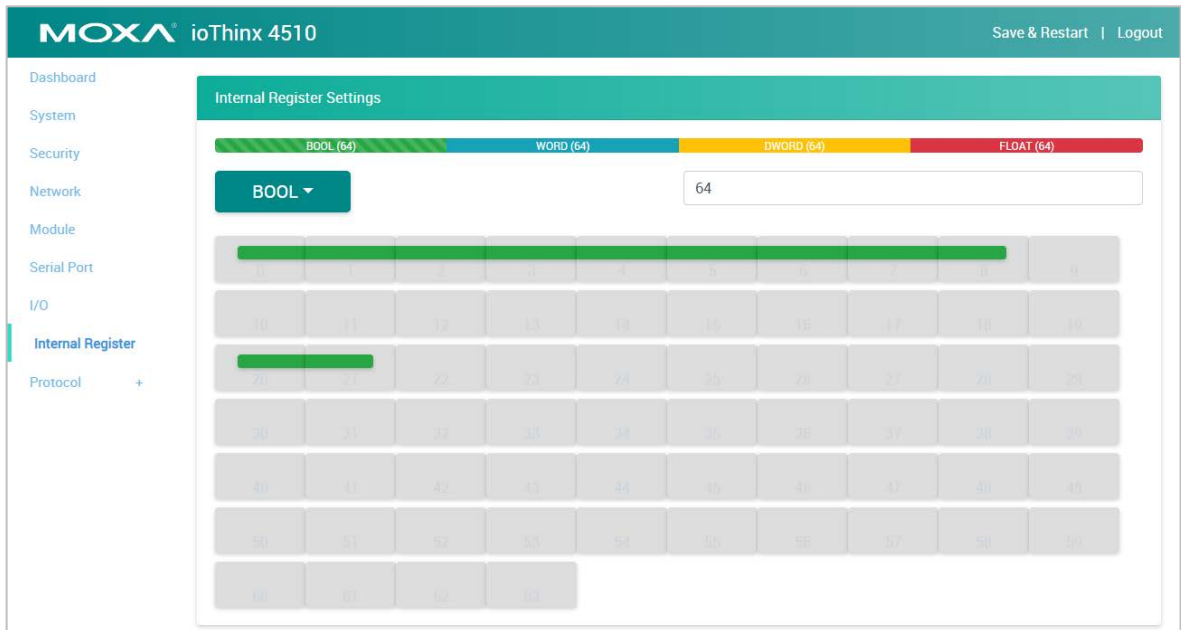

**IR Type Drop-Down List:** It lists all of the IR types. Select the IR type to modify or view its settings.

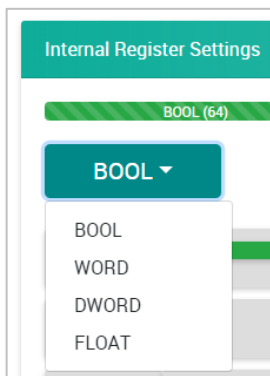

**IR Quantity:** Apply a number to adjust the quantity of the selected IR type. The total available IR quantity is 256.

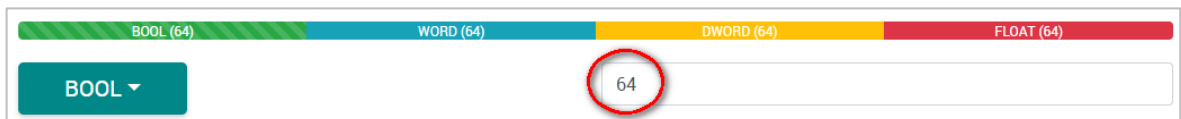

**IR Information:** The IR status window will pop-up after you click one of the IR blocks. The name is used for representing this internal register (max. length = 16, "." is not allowed).

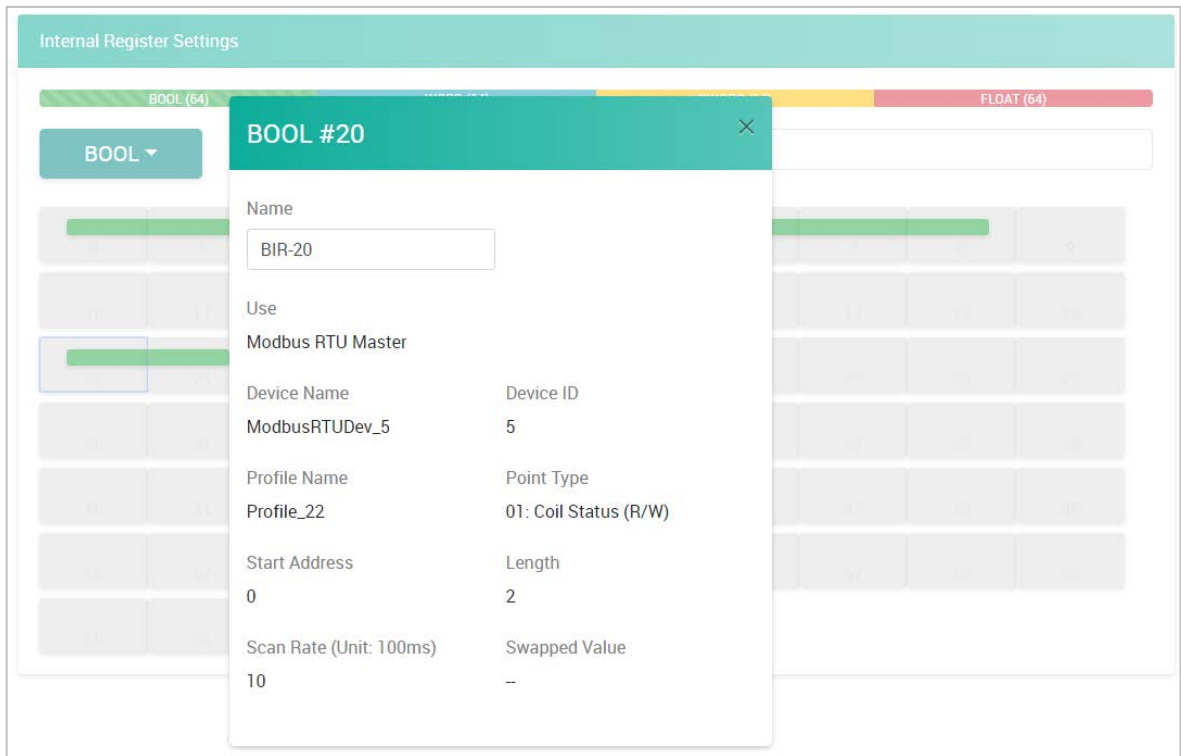

## Protocol

This section introduces the protocol settings functions.

### Modbus TCP Slave

The **Modbus TCP Slave** section shows the definition of the device's Modbus registers. It allows you to define your own data point type or address of the Modbus registers. The point type and address of a register can be default, existing configuration, or user-defined.

**Load Default:** Click this button to load default settings of all Modbus registers.

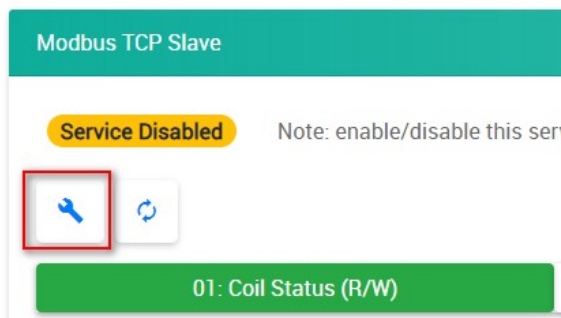

**Reload Configuration:** Click this button to reload the configuration settings of all Modbus registers.

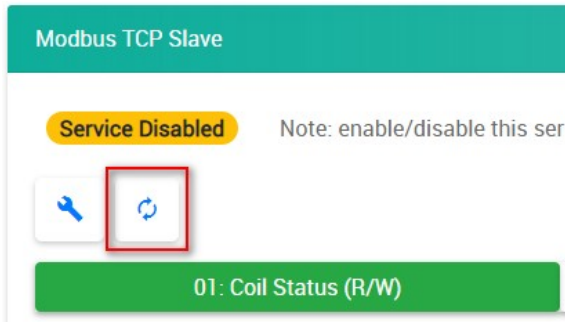

**Filter:** Type characters into the textbox to filter the items in the Modbus Table.

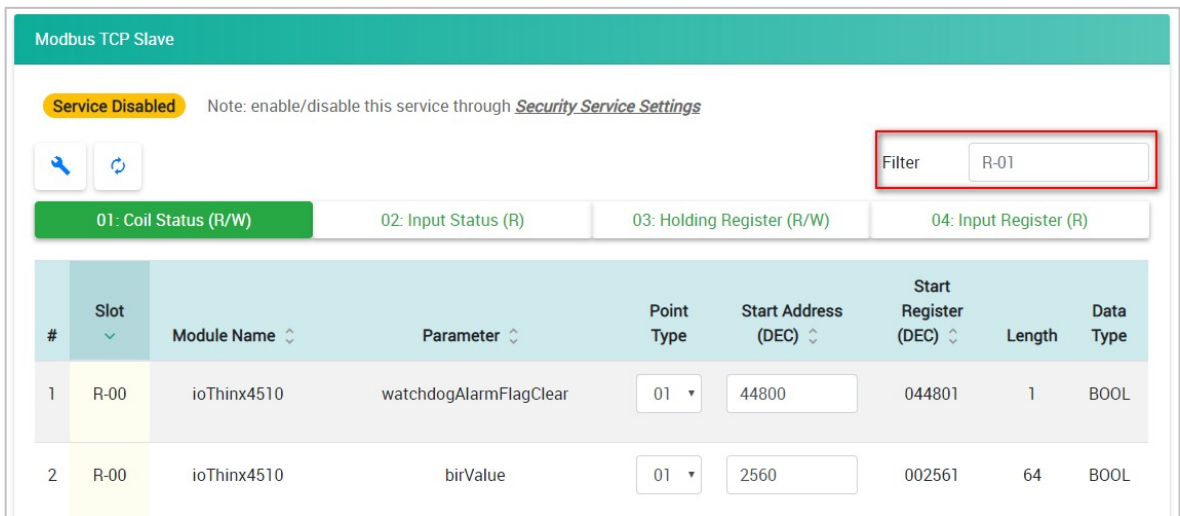

**Point Type Category:** Click **01: Coil Status (R/W)**, **02: Input Status (R)**, **03: Holding Register (R/W)**, or **04: Input Register (R)** tab to see the registers under the specific point type.



**Point Type Drop-Down List:** Select the point type of the parameter when it needs to move to the other point type. After you select the other point type, the parameter will disappear in the current-viewed category and will move to the point type category you just selected (option: 01, 02, 03, or 04).

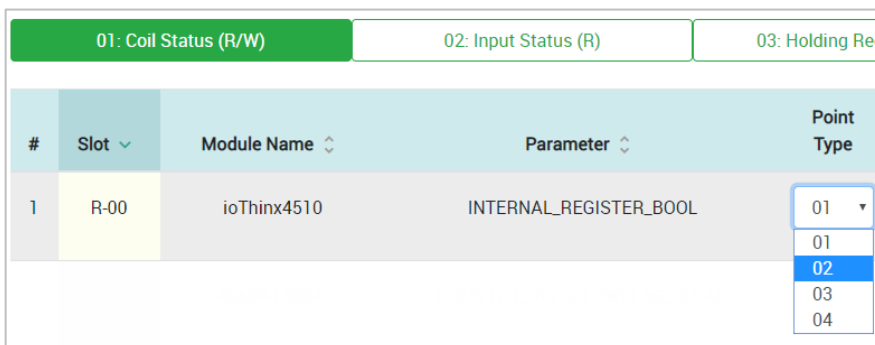

**Start Address Textbox:** Change the value of the Start Address in the textbox (0 to 65535 or leave it blank). When there is no value in the textbox, it will be displayed in light yellow. When it conflicts with another register, it will be displayed in red. Revise the value to prevent address conflict. You can use the **Sort** function to see where there is a conflict of addresses.

#	Slot	Module Name	Parameter	Point Type	Start Address (DEC)	Start Register (DEC)	Length	Data Type
1	R-04	45MR-2601-0	doStatus	01		--	16	BOOL
2	R-03	45MR-2600-0	doStatus	01	32	000001	16	BOOL
3	R-05	45MR-2606-0	doStatus	01	32	000033	8	BOOL

**Sort:** The default-sorted column is the **Slot** from the lowest to highest slot number. Click the green arrow to change the sorting method. Click the gray arrows on the other columns to sort that specific column.

#	Slot	Module Name	Parameter	Point Type	Start Address (DEC)	Start Register (DEC)	Length	Data Type
1	R-00	ioThinx4510	SYS_WATCHDOG_ALARM_FLAG_CLEAR	01	44800	044801	1	BOOL
2	R-00	ioThinx4510	INTERNAL_REGISTER_BOOL	01	2560	02561	1	BOOL

**INFORMATION** Enable/disable this service through **Security** → **Service Settings**.

**INFORMATION** In the event that a conflict address value is entered, whenever you click on a different point type tab, the previous configurations will be restored to avoid the conflict.

**INFORMATION** Refer to **Modbus/TCP Slave Rules** for the available Modbus register.

## SNMP

### SNMP Settings

SNMP Settings

Service Disabled

Note: enable/disable this service through [Security Service Settings](#)

Version

Contact

Location

**Version:** Select one of the SNMP version options (option: v1 and v2c, v3 only, or v1 and v2c and v3), through which the SNMP Manager can access the SNMP agent of the device.

**Contact:** Type the contact of the SNMP server (max length = 30).

**Location:** Type the physical location of the SNMP server (max length = 30).

**INFORMATION** Enable/disable this service through **Security** → **Service Settings**.

### SNMPv1, SNMPv2c Settings



The form titled "SNMPv1, SNMPv2c Settings" contains two input fields. The first field is labeled "Read Community" and contains the text "public". The second field is labeled "Write Community" and contains the text "private".

**Read Community:** Type the community string matching for read authentication (max length = 30, default = "public").

**Write Community:** Type the community string matching for write authentication (max length = 30, default = "private").

### SNMPv3 Settings – Read Only

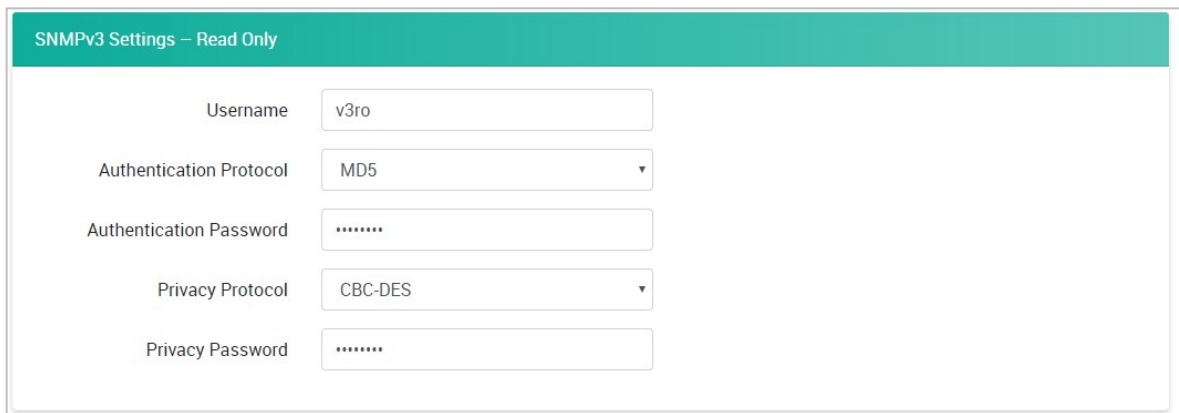

The form titled "SNMPv3 Settings – Read Only" contains five input fields. The "Username" field contains "v3ro". The "Authentication Protocol" dropdown menu is set to "MD5". The "Authentication Password" field contains seven asterisks. The "Privacy Protocol" dropdown menu is set to "CBC-DES". The "Privacy Password" field contains seven asterisks.

**Username:** Type the username for SNMP v3 settings (min. length = 1; max length = 30; A to Z, a to z, 0 to 9, symbols, spaces are not allowed, default = "v3ro").

**Authentication Protocol:** Select **Disable**, **MD5**, or **SHA** for the authentication protocol setting (default: MD5).

**Authentication Password:** Type the password for the authentication password settings (min. length = 8; max length = 16; A to Z, a to z, 0 to 9, symbols, at least one symbol and one number, spaces are not allowed, default = "moxa-123").

**Privacy Protocol:** Select **Disable** or **CBC-DES** for privacy protocol setting (default: CBC-DES).

**Privacy Password:** Type the password for the privacy password settings (min. length = 8; max length = 16; A to Z, a to z, 0 to 9, symbols, at least one symbol and one number, spaces are not allowed, default = "moxa-123").

## SNMPv3 Settings – Read/Write

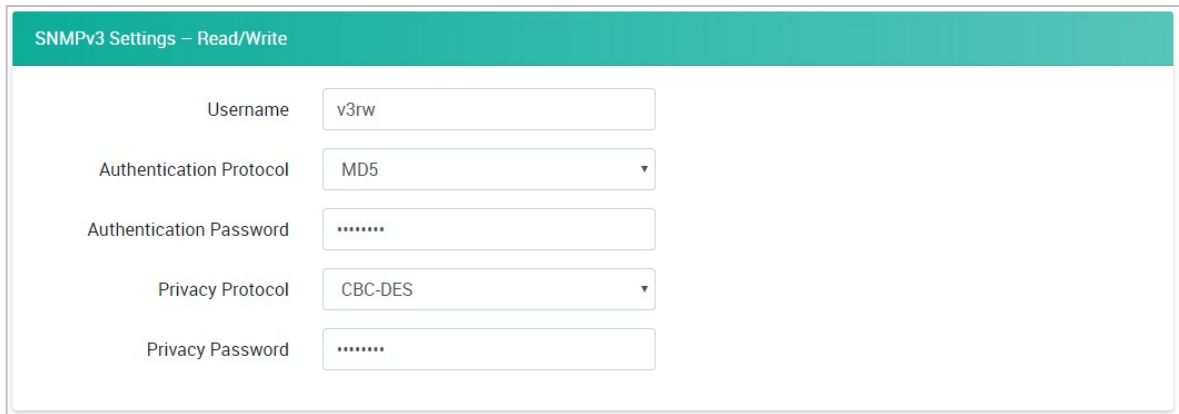

Username	<input type="text" value="v3rw"/>
Authentication Protocol	<input type="text" value="MD5"/>
Authentication Password	<input type="password" value="*****"/>
Privacy Protocol	<input type="text" value="CBC-DES"/>
Privacy Password	<input type="password" value="*****"/>

**Username:** Type the username for the SNMP v3 settings (min. length = 1; max length = 30; A to Z, a to z, 0 to 9, symbols, spaces are not allowed, default = "v3rw").

**Authentication Protocol:** Select **Disable**, **MD5**, or **SHA** for the authentication protocol settings (default: MD5).

**Authentication Password:** Type the password for the authentication password settings (min. length = 8; max length = 16; A to Z, a to z, 0 to 9, symbols, at least one symbol and one number, spaces are not allowed, default = "moxa-123").

**Privacy Protocol:** Select **Disable** or **CBC-DES** for privacy protocol settings (default: CBC-DES).

**Privacy Password:** Type the password for the privacy password settings (min. length = 8; max length = 16; A to Z, a to z, 0 to 9, symbols, at least one symbol and one number, spaces are not allowed, default = "moxa-123").

**INFORMATION** Refer to **SNMP Rules** for detailed SNMP OID information.

The following topics are covered in this chapter:

### ❑ **Configuring the Unit**

- Login to the Unit
- Configuring Module Settings
- Changing Device Name
- Changing Username & Password
- Configuring Service Settings
- Configuring Account Settings
- Configuring Network Settings
- Configuring Serial Port & IR Settings
- Configuring I/O Settings
- Configuring Modbus Address Settings
- Configuring SNMP Settings

### ❑ **Mass-deploying the Settings**

- Updating Configuration to Multiple Units
- Setting Date and Time to Multiple Units

### ❑ **Monitoring & Operating the Unit**

- Monitoring Module & I/O Status
- Monitoring Connection Status
- Exiting Safe Mode Status

### ❑ **Maintaining the Unit**

- Backing up Configuration Files
- Updating the Firmware
- Restarting the Unit
- Loading Factory Default Settings

# Configuring the Unit

This section explains how to configure this device through the Web Console from the beginning. If you require additional information, please refer to Preparing Software Tools before reading this section.

## Login to the Unit

Follow the steps to log in to the unit.

**Step 1:** Open your web browser and type the default IP address of the device, 192.168.127.254.

**Step 2:** On the login page, type the default username/password (admin/moxa) to log in to the Web Console.

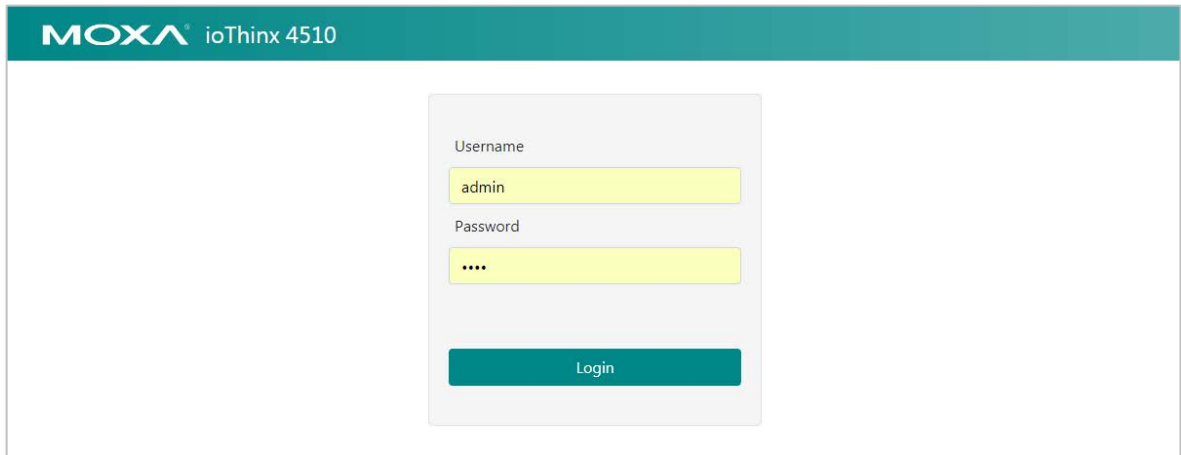

The image shows the login page for the MOXA ioThinx 4510. It features a teal header with the MOXA logo and the device name. Below the header is a central login form with two input fields: 'Username' containing 'admin' and 'Password' containing four dots. A teal 'Login' button is positioned below the password field.

## Configuring Module Settings

After you have logged in, you can see the dashboard or the module settings page. If the detected module matches the configured module, you will see the **Dashboard** as below. Then click **Module** in the Menu panel to go to the module settings page.

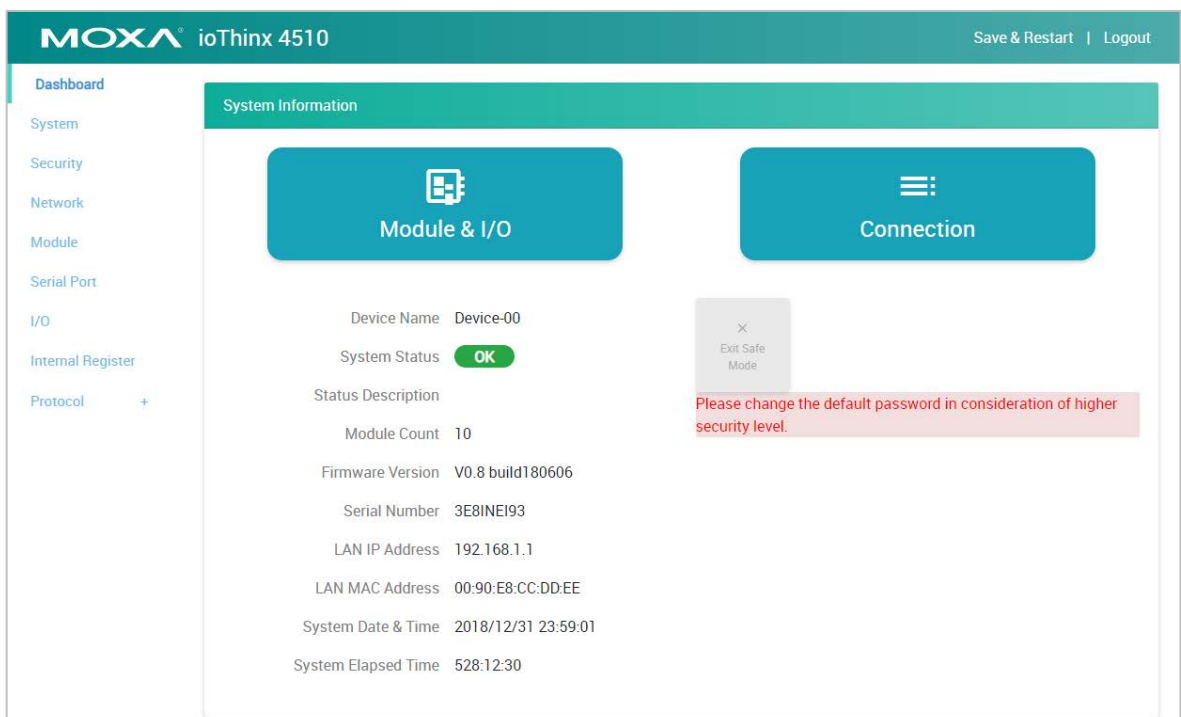

The image displays the dashboard of the MOXA ioThinx 4510. The top header includes the MOXA logo, the device name, and links for 'Save & Restart' and 'Logout'. A left sidebar menu lists various system settings. The main content area is titled 'System Information' and contains two large teal buttons: 'Module & I/O' and 'Connection'. Below these buttons is a table of system information, and a red warning message is displayed on the right side.

Parameter	Value
Device Name	Device-00
System Status	OK
Status Description	
Module Count	10
Firmware Version	V0.8 build180606
Serial Number	3E8INEI93
LAN IP Address	192.168.1.1
LAN MAC Address	00:90:E8:CC:DD:EE
System Date & Time	2018/12/31 23:59:01
System Elapsed Time	528:12:30

Please change the default password in consideration of higher security level.



If you see the module settings page as opposed to the dashboard, click **Edit** to enter the edit mode and start editing the module settings.

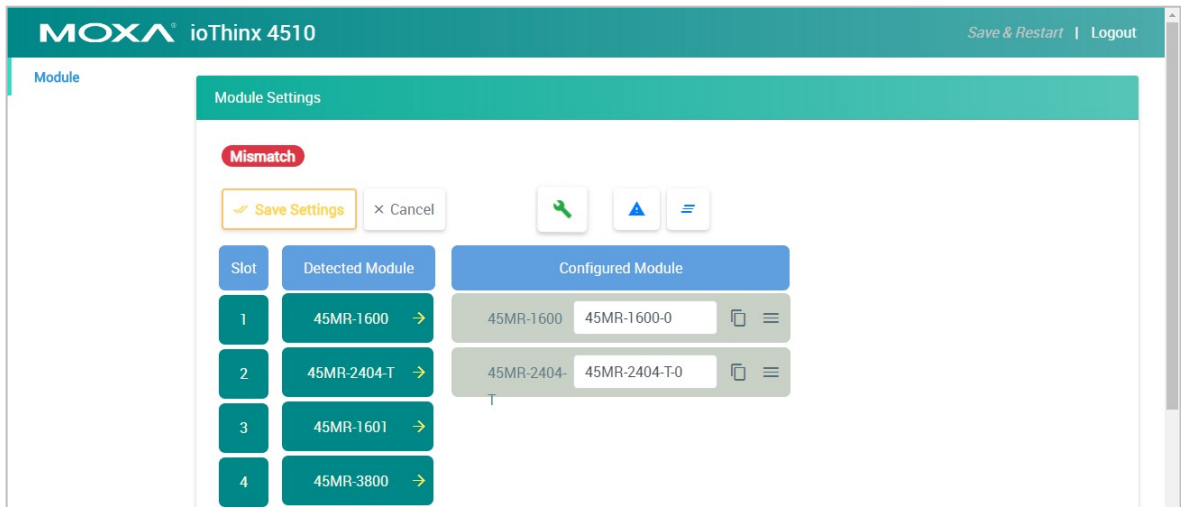

In edit mode, if any detected module and configured module do not match, the configured module will be highlighted as shown below.

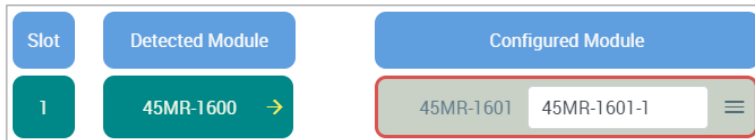

Click **Auto Matching** to match the conflicted modules.

If not, you can use the "Auto Match" function or swap the module to change the module sequence.

If you want to re-arrange the 45MR modules automatically, you can click "Auto Match".

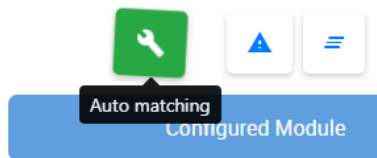

If you want to change configurations, you can use the swap function. To swap the module sequence, move the point to the module, click the left button on the mouse and hold it. After the module color changes to green, you can move it to change the position of the module.

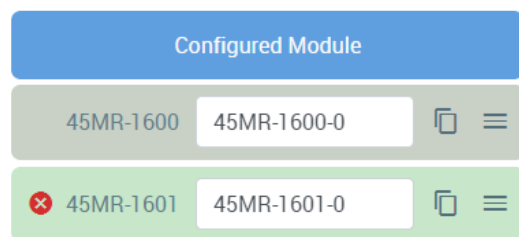

## Changing Device Name

Set the name of this device through **System → Device Settings**. We recommend choosing a unique name for the device in order to easily differentiate it from other devices.

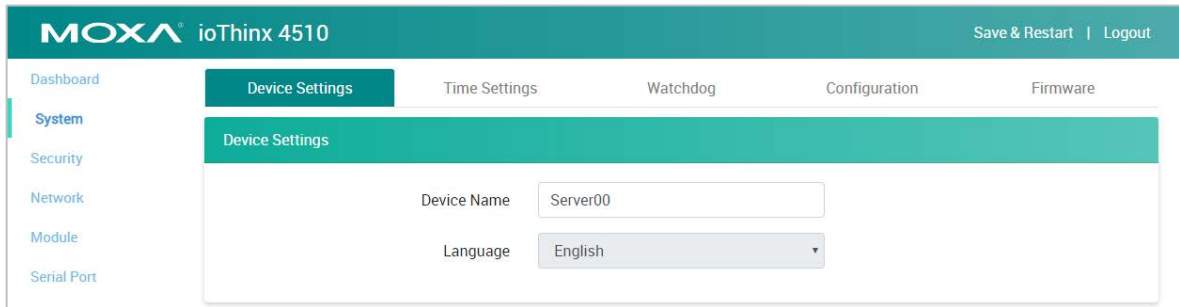

## Changing Username & Password

In order to have higher levels of security, we recommend changing the username and password after your first log in. Click **Security → User Settings** as shown in the screenshot below.

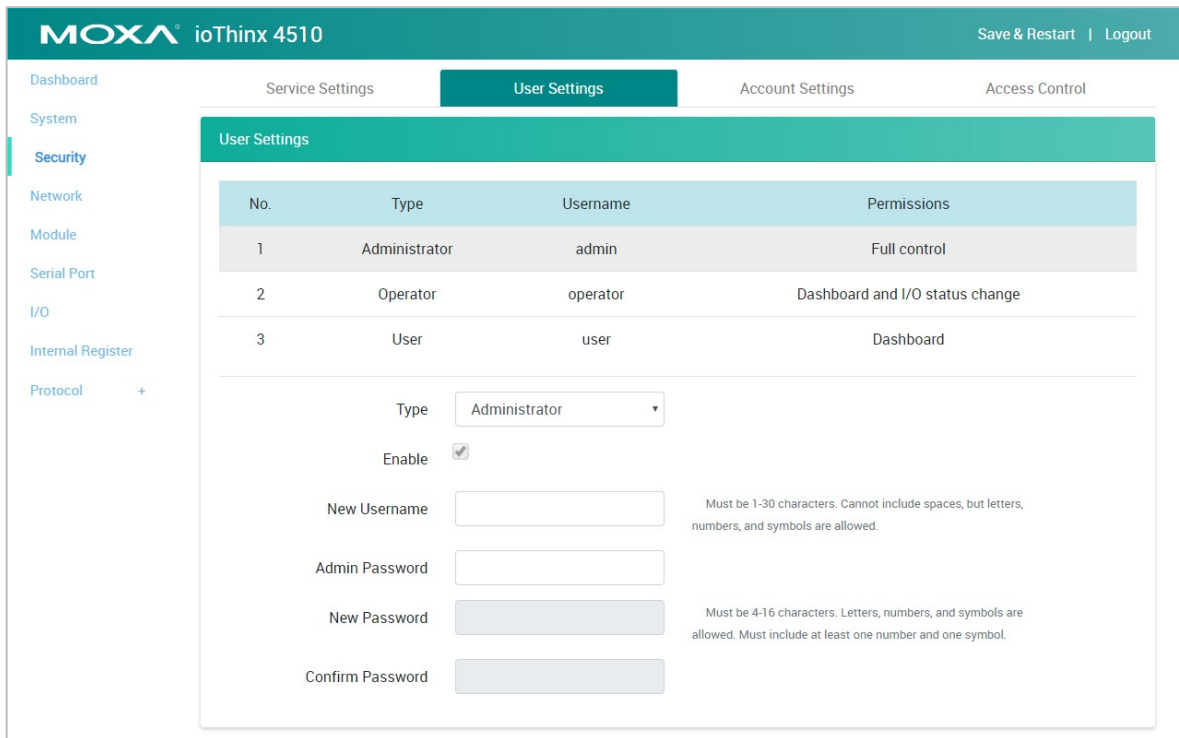

**INFORMATION** The default username is admin, and the default password is moxa.

## Configuring Service Settings

Click **Security** on the menu panel to enter the security settings page as shown below. For service settings, the user can enable or disable the service in order to control access.

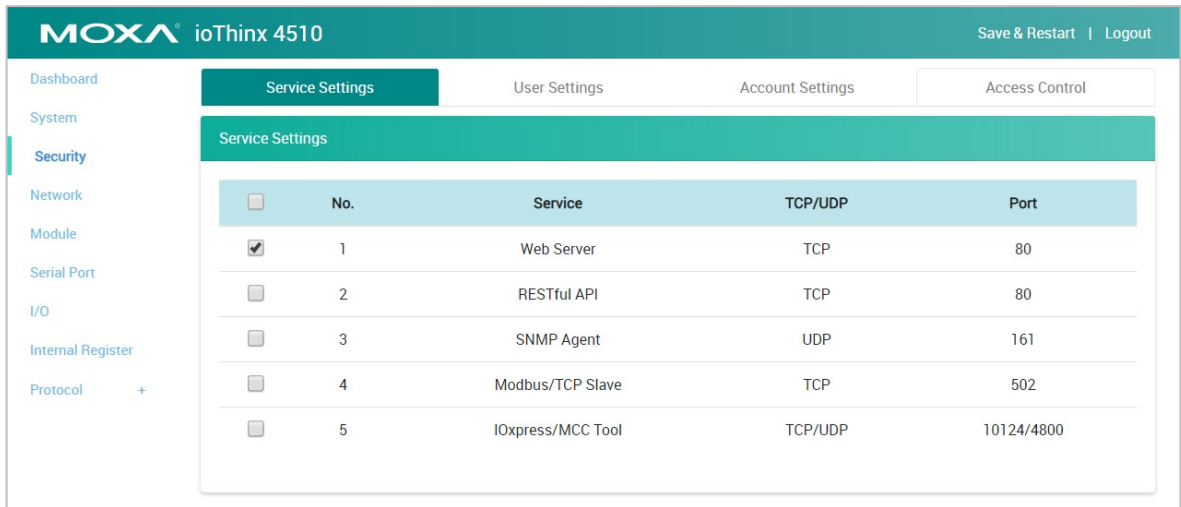

## Configuring Account Settings

For account settings, the user can modify the parameters and define the login failure message and system usage notifications. If the user wants to know the access history, the ioThinX 4510 Series supports access log export, which can store up to 1000 records.

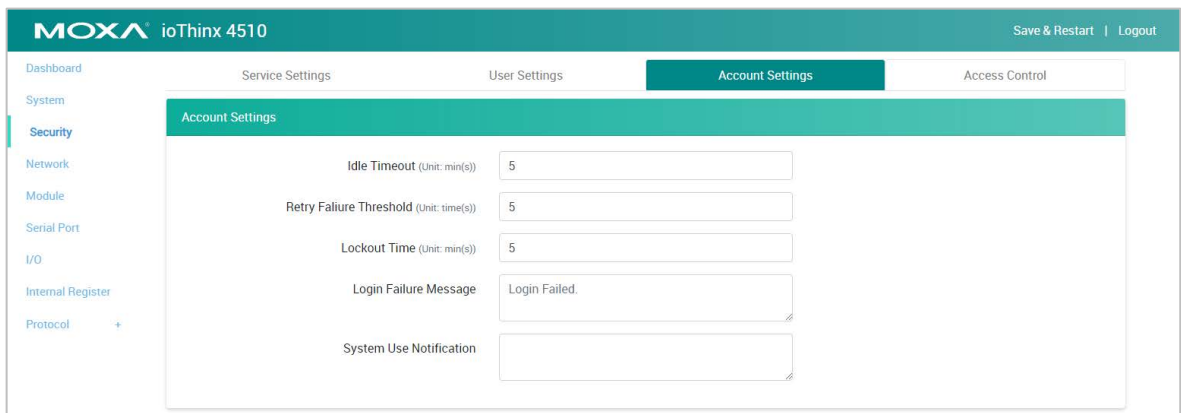

## Configuring Network Settings

Click **Network** on the menu panel to enter the network settings page as shown below. The ioThinx 4510 Series supports Ethernet daisy-chain topology with one MAC address. For this LAN port, it supports static IP and DHCP mode. The user can configure it via the LAN settings.



## Configuring Serial Port & IR Settings

Click **Serial Port** on the menu panel to enter the serial port settings page. For more detailed information, please refer to the **Serial Port** chapter.

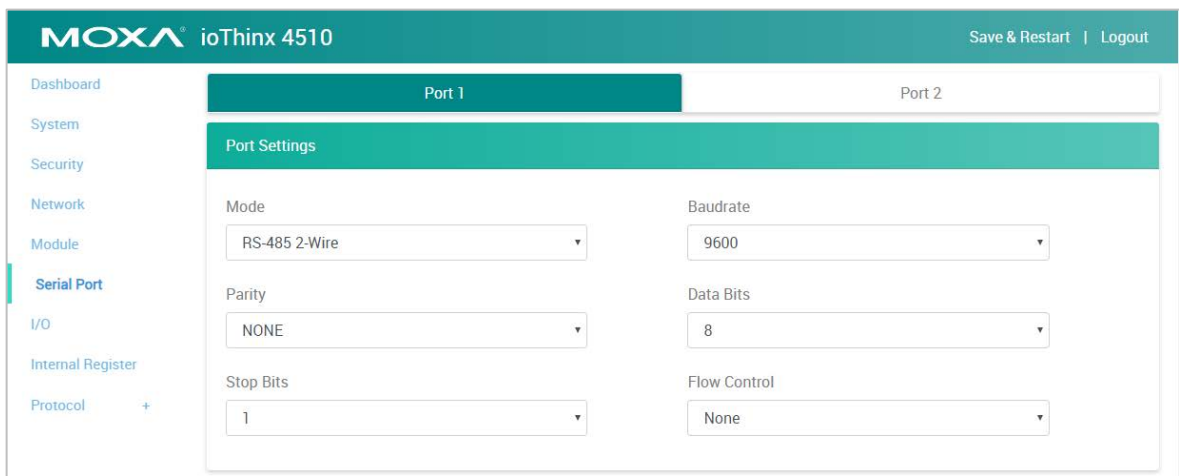

Click **Internal Register** on the menu panel to enter the internal register settings page. For more detailed information, please refer to the **Internal Register** chapter.

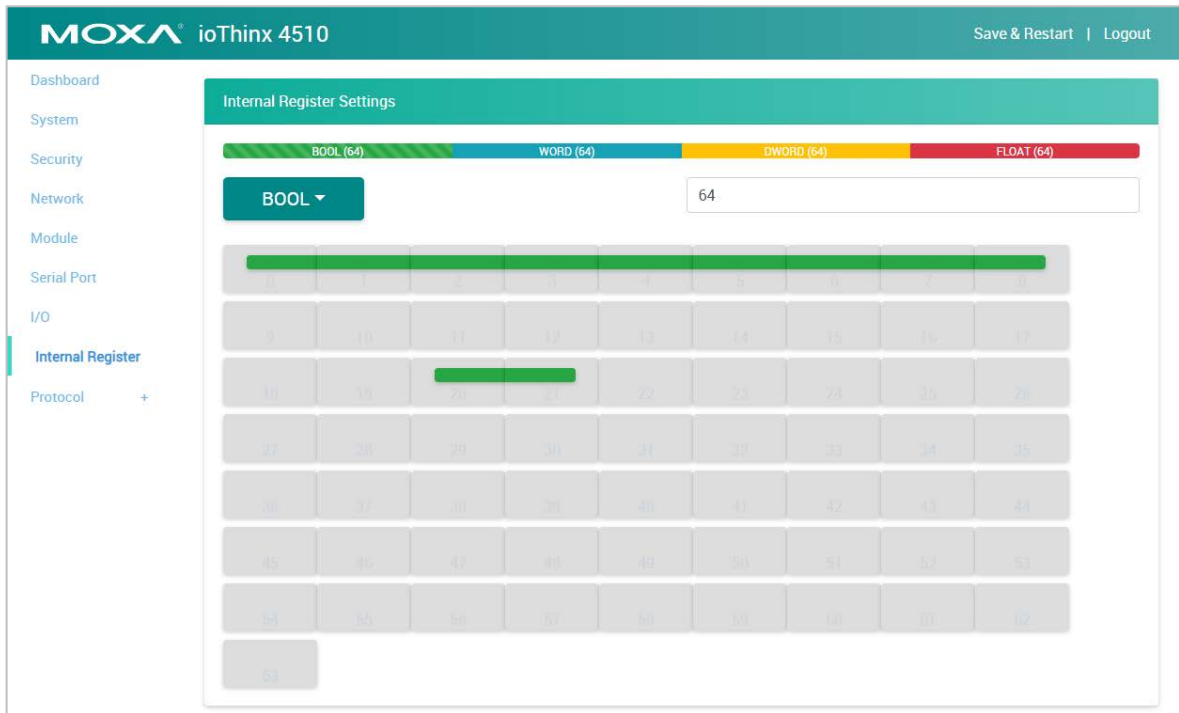

## Configuring I/O Settings

Click **I/O** on the menu panel to enter the I/O settings page. For more detailed information, please refer to the **I/O Settings** chapter.



## Configuring Modbus Address Settings

Click **Modbus** on the menu panel to enter the Modbus TCP Slave setting page. On this page, users can see all of the Modbus TCP addresses categorized by coil status, input status, holding register, and input register.

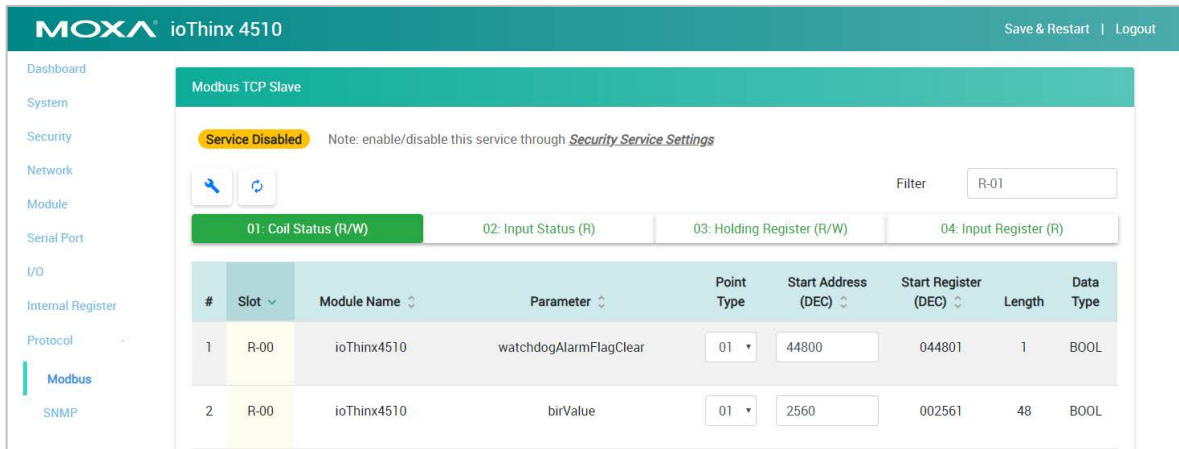

To change Modbus addresses, users can click **Reload default Modbus address**, **Reload current device address**, or manually modify the addresses.

## Configuring SNMP Settings

Click **SNMP** on the menu panel to enter the SNMP settings page as shown below.

### SNMP Settings

**Service Disabled** Note: enable/disable this service through [Security Service Settings](#)

Version

Contact

Location

### SNMPv1, SNMPv2c Settings

Read Community

Write Community

### SNMPv3 Settings – Read Only

Username

Authentication Protocol

Authentication Password

Privacy Protocol

Privacy Password

### SNMPv3 Settings – Read/Write

Username

Authentication Protocol

Authentication Password

Privacy Protocol

Privacy Password

The ioThinx 4510 Series supports SNMP V1, V2c, and V3 and after configuring it, please download the mib file from Moxa's website. For detailed information on the structure of the mib file, please refer to the **SNMP** chapter.

# Mass-deploying the Settings

The mass-deploying function can be performed by IOxpress utility. IOxpress is a Windows utility and the system requirements are listed below:

OS	Microsoft Windows 2000, XP or later
CPU	Intel Pentium 4 CPU or higher
RAM	Min. 512 MB, 1024 MB is recommended
Network	10/100 Ethernet

**NOTE** The ioThinx 4510 Series is only compatible with IOxpress v2.3 or later.

**INFORMATION** To get the latest version of IOxpress, please download it from [www.moxa.com](http://www.moxa.com)

Users can change IP address, update configurations, change the device name, and set the date and time to multiple units by IOxpress. Before starting to use the mass-deploying function, please complete the following steps to search for all devices first.

**Step 1:** Make sure the IOxpress service is enabled in **Security** → **Service Settings**.

The screenshot shows the MOXA ioThinx 4510 web interface. The top navigation bar includes 'Save & Restart' and 'Logout'. The left sidebar lists various settings categories: Dashboard, System, Security (highlighted), Network, Module, Serial Port, I/O, Internal Register, and Protocol. The main content area is titled 'Service Settings' and contains a table with the following data:

<input type="checkbox"/>	No.	Service	TCP/UDP	Port
<input checked="" type="checkbox"/>	1	Web Server	TCP	80
<input type="checkbox"/>	2	RESTful API	TCP	80
<input type="checkbox"/>	3	SNMP Agent	UDP	161
<input type="checkbox"/>	4	Modbus/TCP Slave	TCP	502
<input checked="" type="checkbox"/>	5	IOxpress/MCC Tool	TCP/UDP	10124/4800

**Step 2:** Connect the devices by Ethernet cables and then power them on.





**Step 4:** In the **Search for Devices** window, choose the product series you would like to search for in the **By Product Series** dropdown menu, and then click **Submit**. IOxpress will start to search the devices and list them in the table.

Search for Devices

LAN WAN CDA

By Product Series All

By Product Model All

By MAC Address 00 : 90 : E8 : 00 : 00 : 01

By IP Address 192 . 168 . 1 . 1 to 192 . 168 . 1 . 254 (leave second IP blank if searching for a single device)

Mask 255 . 255 . 255 . 0

Submit Cancel

**NOTE** If the devices cannot be found, check the network setting of the devices.

## Updating Configuration to Multiple Units

IOxpress supports updating configuration of multiple units. Follow the steps to complete this task.

**Step 1:** Export the configuration file of a device through the Web Console. Refer to **Backing up Configuration Files** for more details.

**Step 2:** Select **Update Configuration to Device** in the dropdown menu.

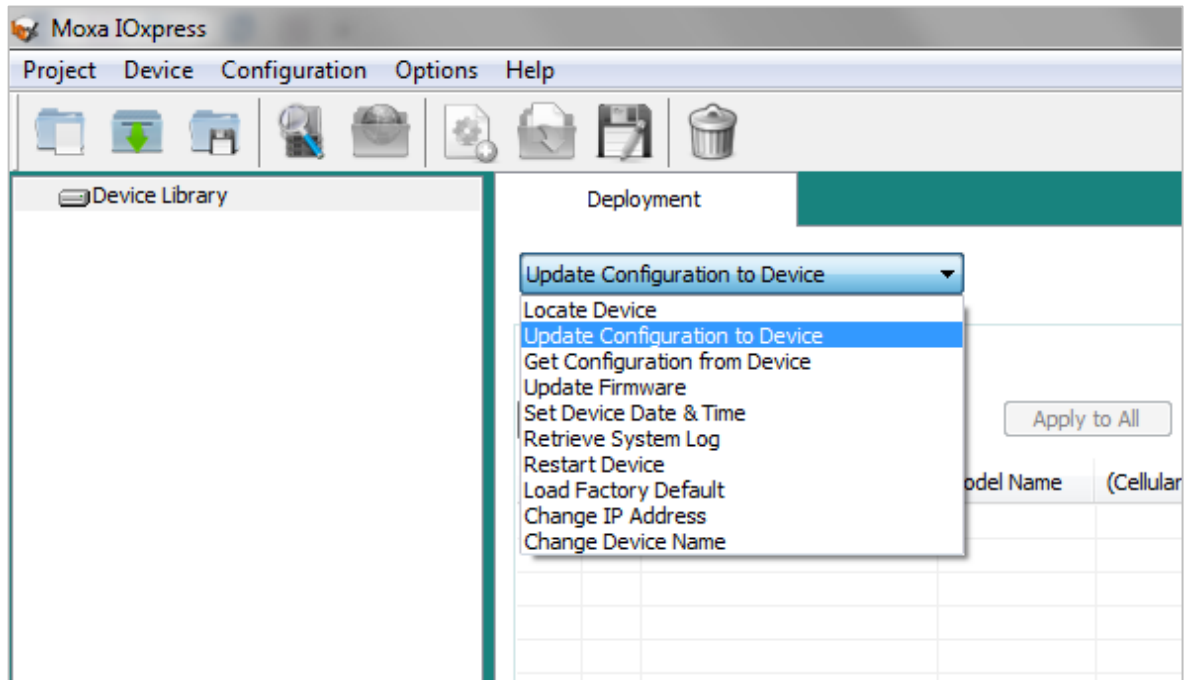

**Step 3:** Click the **File** column of the selected device in the table and then choose the configuration file from Step 1.

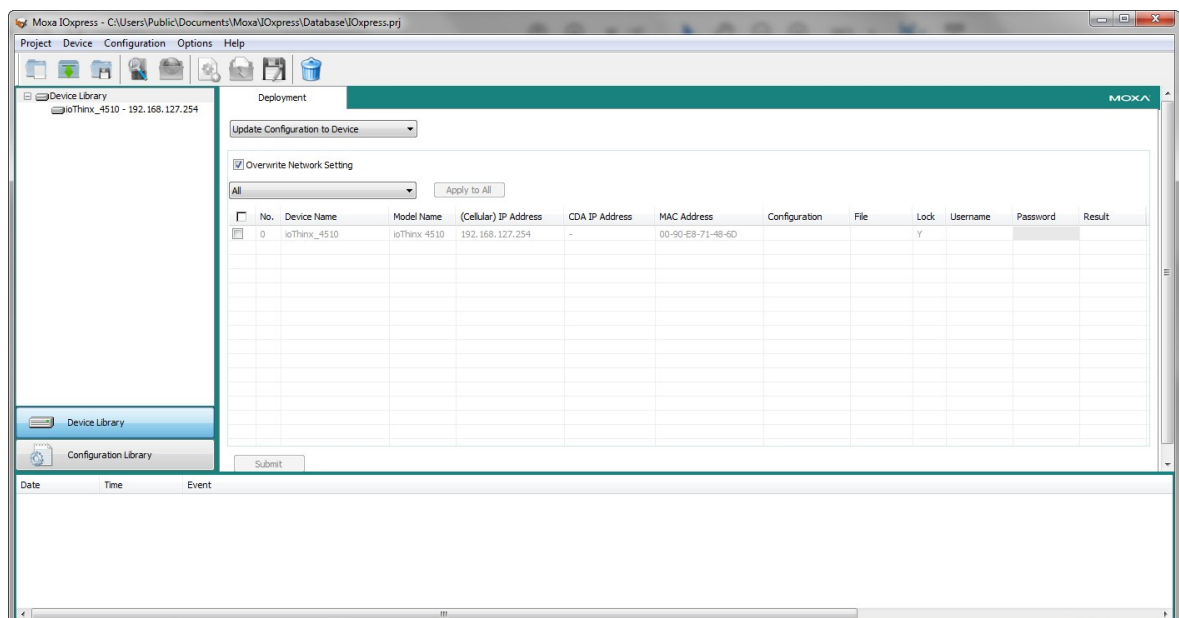

**Step 4:** Select the device(s), type the **Username** and **Password**, and then click **Submit**. Then, IOxpress will start to execute the task on the selected devices. The success message will show up in the **Result** column if the process is successfully completed.

**INFORMATION** Click **Apply to All** if the selected devices have the same settings.

## Setting Date and Time to Multiple Units

The IOxpress supports setting the date and time of multiple units. Follow these steps to complete this task.

**Step 1:** Select **Set Device Date & Time** in the dropdown button

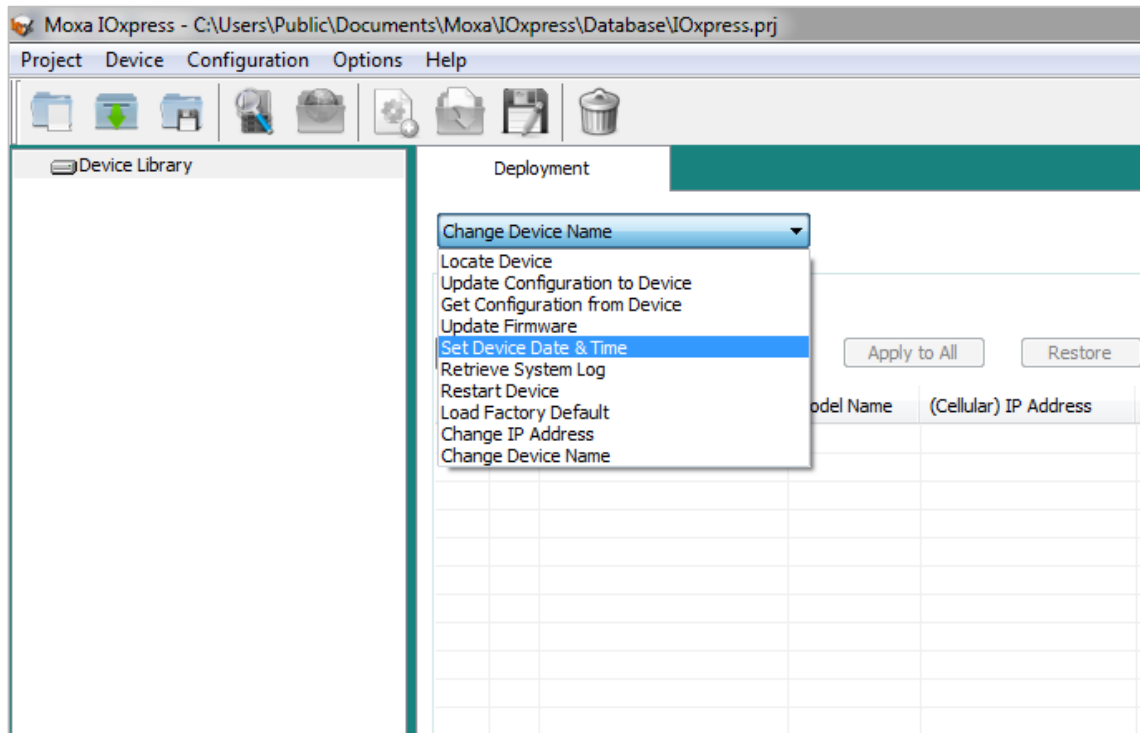

**Step 2:** Select either **Sync with PC** or **Manual Setting**. For Manual Setting, type the Local Date and Time, which will be set on the device(s).

**Step 3:** Select the device(s), type the **Username** and **Password**, and then click **Submit**. IOxpress will start to execute the task on the selected devices. The success message will show up in the **Result** column if the process is successfully completed.

**INFORMATION** Click **Apply to All** if the selected devices have the same settings.

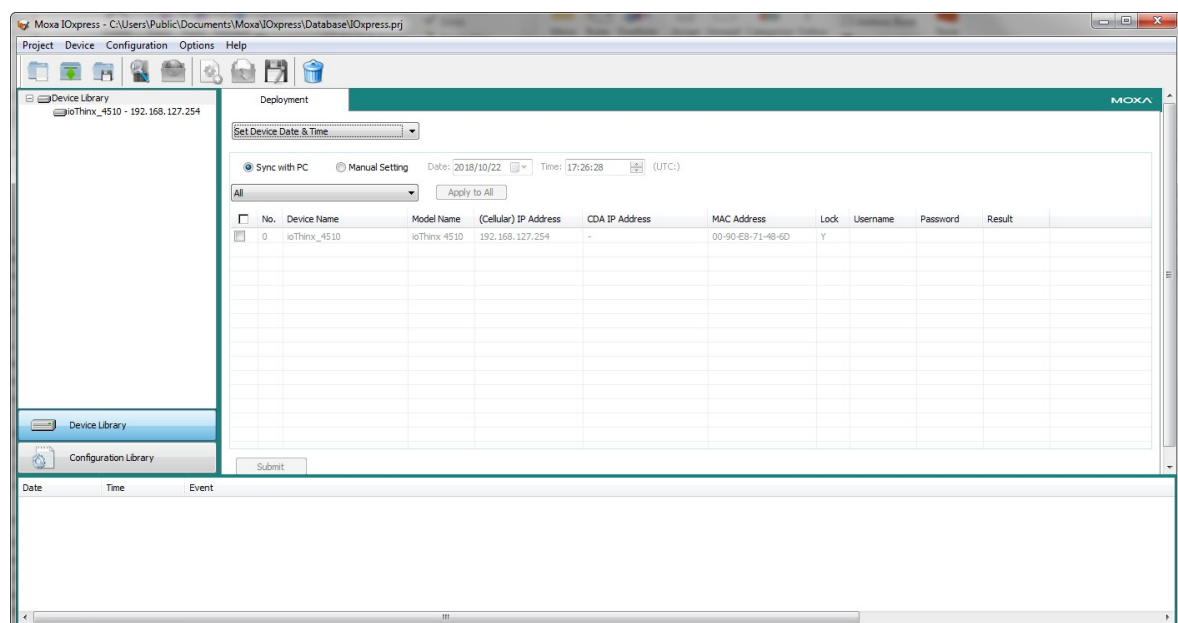

# Monitoring & Operating the Unit

To monitor and operate the device, go to the **Dashboard** of the Web Console.

**INFORMATION** The ioThinx 4510 Series supports three different user profiles (Administrator, Operator, and User). Refer to **User Settings** for the permission information of each profile.

## Monitoring Module & I/O Status

Under the **Dashboard** of the Web Console, click **Module & I/O** to go to the module and I/O status web page.

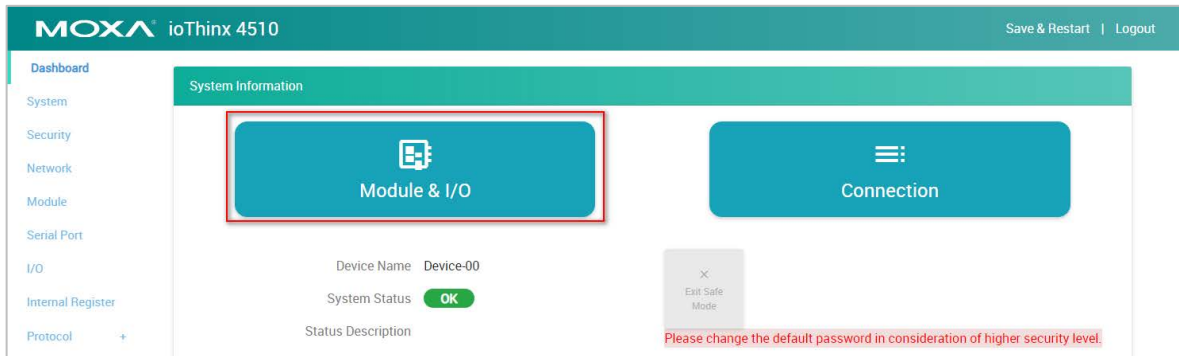

The upper side of this page shows the module status, including **Slot** position, module **Status**, **Firmware Version**, **Module Name**, **Model Name**, and **Serial Number**. Click **Locate** to identify the physical location of the module. The module’s LED will blink green.

The lower side of the page shows the I/O status and allows you to operate the status of the output channels, such as DO, Pulse, or Relay channels. Refer to the **Module & I/O** section for detailed information.

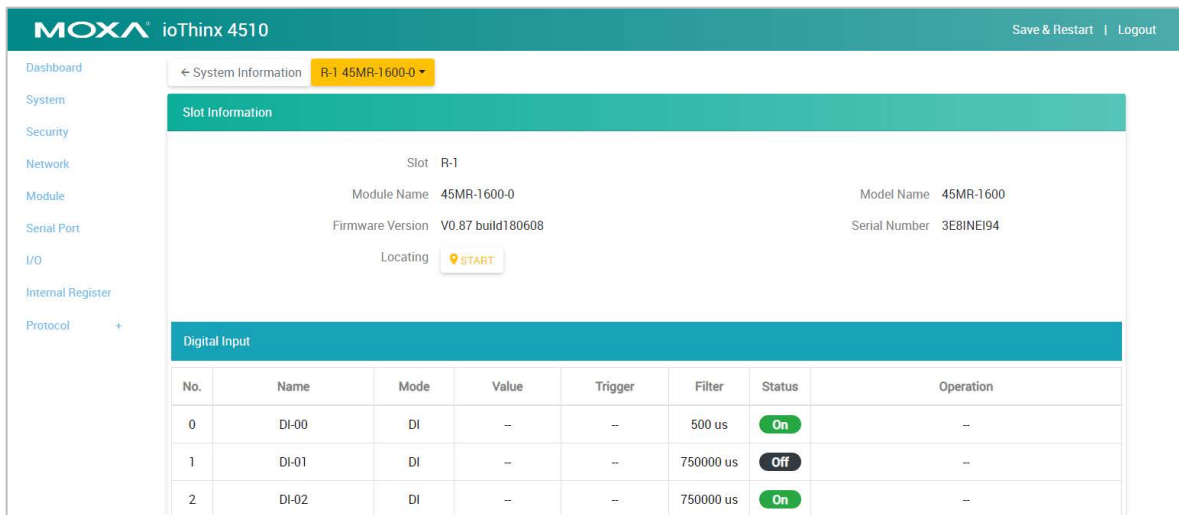

## Monitoring Connection Status

Under the **Dashboard** of the Web Console, click the **Connection** button to go to the connection status web page.

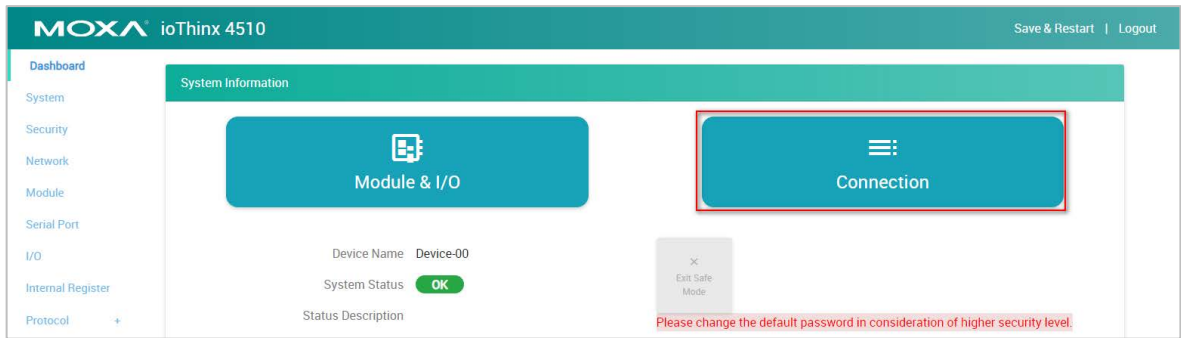

The connection status page lists the connection information from other hosts.

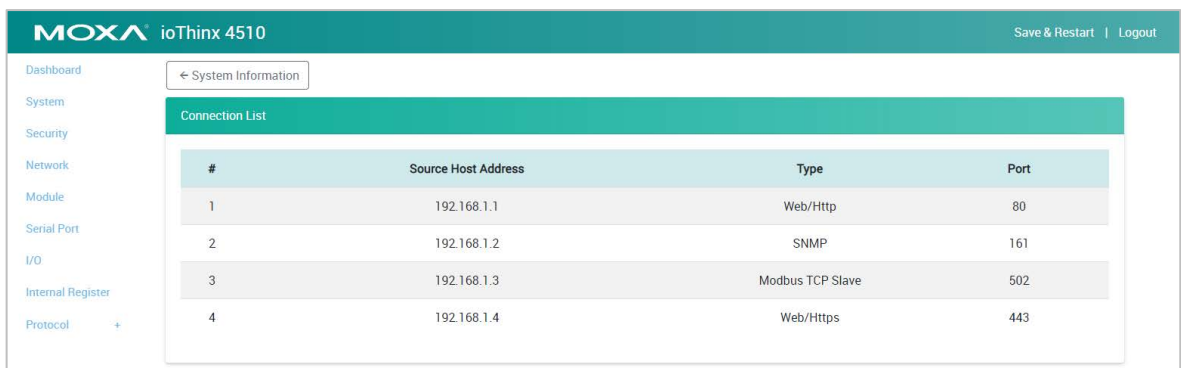

**NOTE** Some browsers may create more than one Web Https connection at the beginning. Once the connection is established, the browsers will only keep one and drop the others. Thus, it is normal that more than one Web Https connection is listed in the table at the beginning.

## Exiting Safe Mode Status

This device has a watchdog service to monitor the status of the pre-defined TCP connection (refer to **Account Settings** for detailed settings). If the pre-defined TCP connection has no response for a designated period, the device will enter the safe mode status. To exit safe mode status, log in to the device's Web Console and click the **Exit Safe Mode** button to revert the device back to the normal mode.

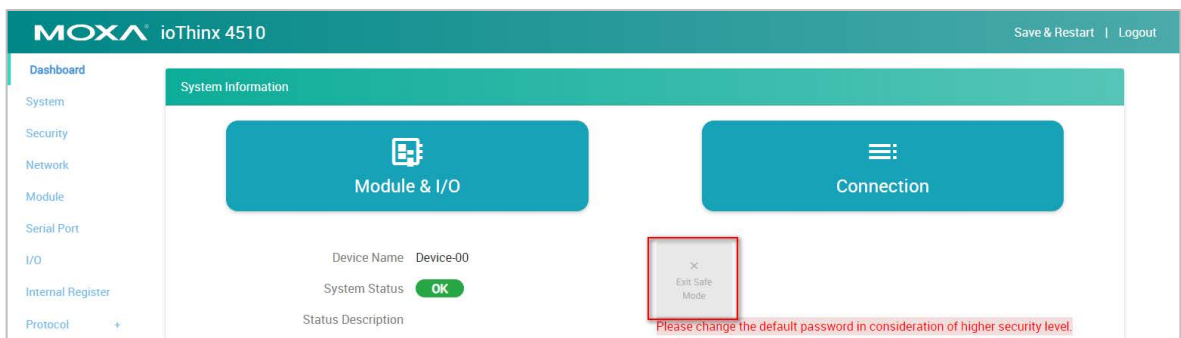

# Maintaining the Unit

This section introduces the maintenance functions of the ioThinx 4510 Series.

## Backing up Configuration Files

This device can only be configured through the web console. After configuration, the configuration file can be retrieved from the device to perform backup and mass deployment. Follow the steps to retrieve the configuration file from the device.

**Step 1:** Go to the configuration page via **Menu → System → Configuration**

**Step 2:** Click **Download** from **Get from Device** and choose the location to save the .cfg file.

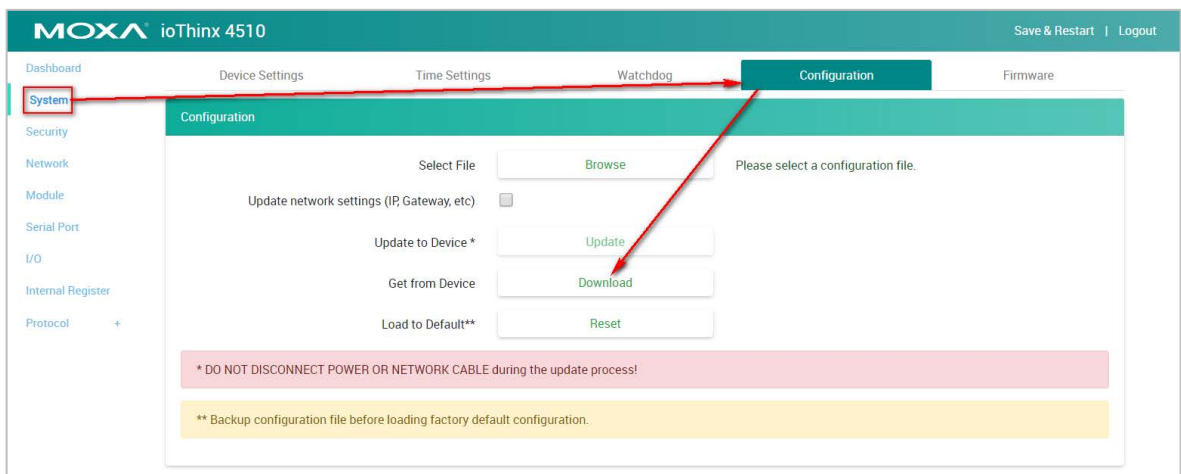

## Updating the Firmware

Follow the steps to update the firmware to the device.

**Step 1:** Go to the configuration page via **Menu → System → Firmware**

**Step 2:** Click the **Browse** button to select a firmware file to update

**Step 3:** Click the **Update** button to start the update process

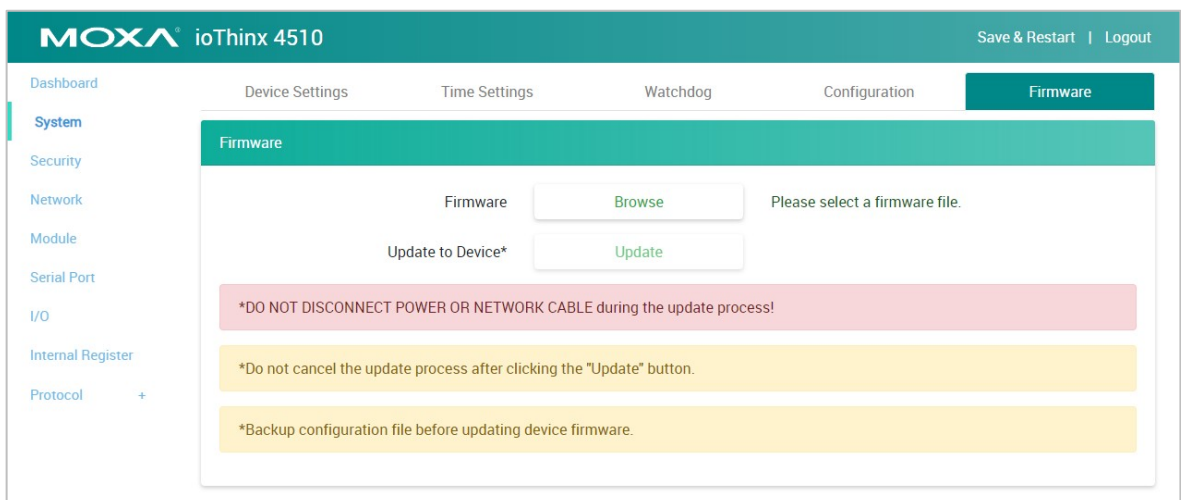

**NOTE** When the device is updating, do not turn the power off as it might corrupt the device.

**NOTE** Performing a firmware update will delete the configurations in the device. Backup the configurations before performing the firmware update.

## Restarting the Unit

This device will restart automatically after the firmware and configurations have been updated. The user can also restart the device manually.

**Step 1:** Click **Save & Restart** on the right upper corner of the page.

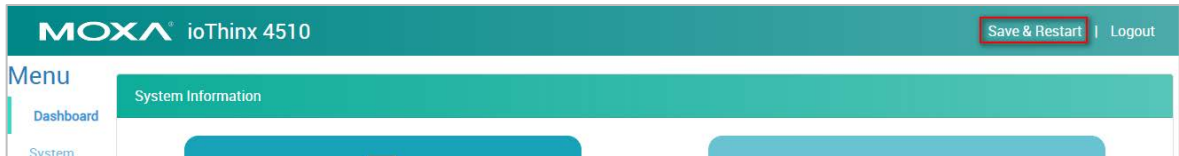

**Step 2:** The device will confirm that you want to perform a restart. Click **Restart Device** in order to restart the device.

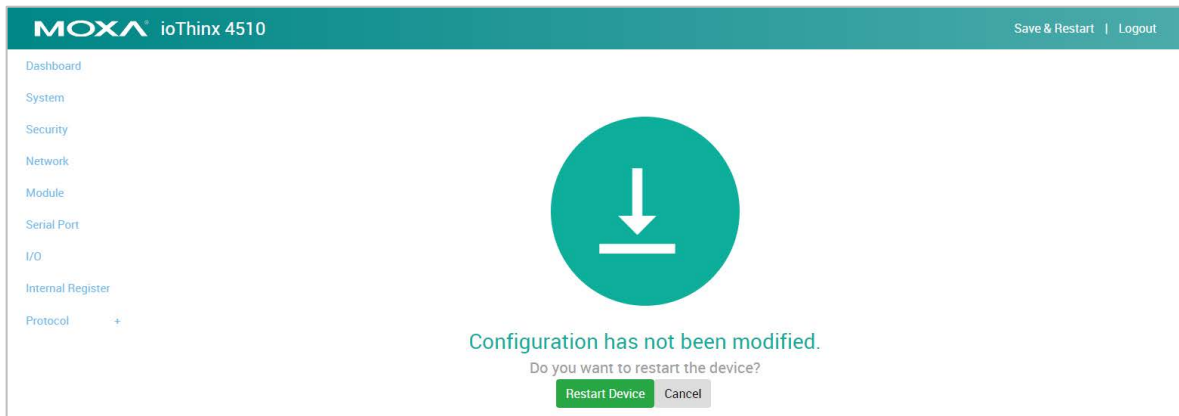

**INFORMATION** This device does not have a battery. Therefore, if the device is powered off, the system date and time will have to be set again. If the NTP server is not available, set the date and time of the device after rebooting.



## Loading Factory Default Settings

There are three ways to restore the device to factory default settings.

1. Follow the steps to load the factory default settings from the web console.

**Step 1:** Go to the configuration page via **Menu → System → Configuration**

**Step 2:** Click **Reset** located under **Load to Default** and then the device will return to default settings.

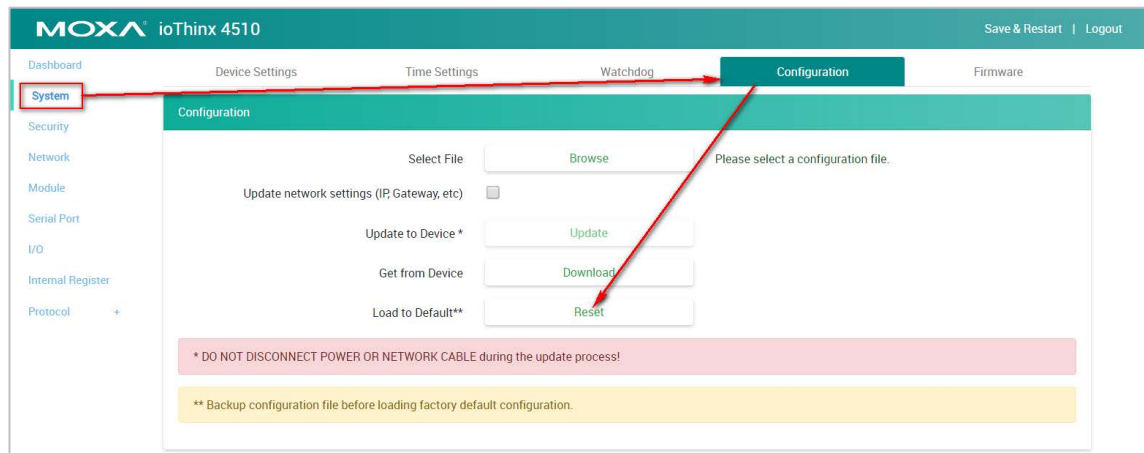

**NOTE** Loading the factory default settings will delete the configurations from this device. Please back up the configurations before loading the factory default settings.

2. Follow the steps to load the factory default settings from IOxpress.

**Step 1:** Select **Load Factory Default** from the dropdown menu.

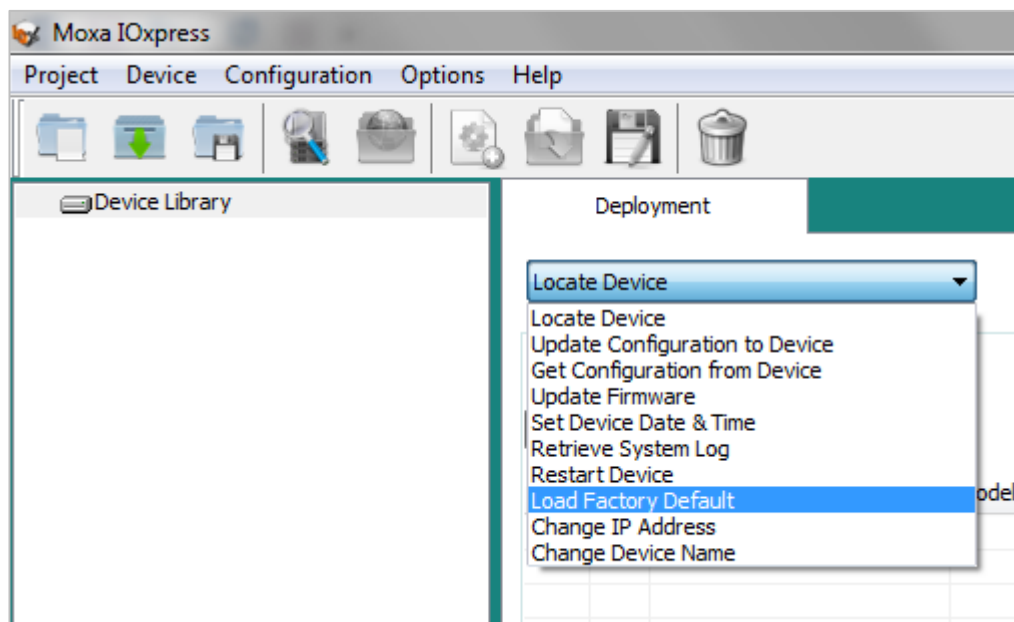

**Step 2:** Select the device(s), type the **Username** and **Password**, and then click **Submit**. IOxpress will start to perform the task on the selected devices. The success message will show up in the **Result** column when the process has been completed.

**INFORMATION** Click **Apply to All** if the selected devices have the same settings.

3. Hold down the RESET button for 10 seconds to load factory default settings. The system will load the default settings and then restart the device. The system is ready when the RDY LED turns green.

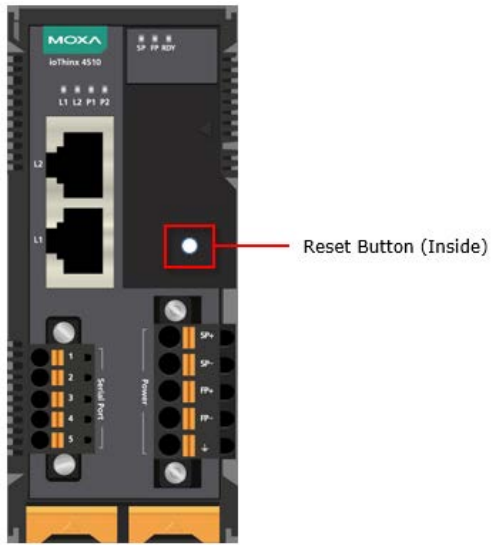

# A

## Appendix

---

The following topics are covered in this appendix:

### ❑ Network Port Usage

#### ❑ Modbus/TCP Slave Rules

- Supported Function Code
- Exception Code
- System Registers
- 45MR-1600 (-T), 16 DIs Registers
- 45MR-1601 (-T), 16 DIs Registers
- 45MR-2404 (-T), 4 Relays Registers
- 45MR-2600 (-T), 16 DOs Registers
- 45MR-2601 (-T), 16 DOs Registers
- 45MR-2606 (-T), 8 DIs, 8 DOs Registers
- 45MR-3800 (-T), 8 AIs Registers
- 45MR-3810 (-T), 8 AIs Registers
- 45MR-4420 (-T), 4 AOs Registers
- 45MR-6600 (-T), 6 RTDs Registers
- 45MR-6810 (-T), 8 TCs Registers

#### ❑ SNMP Rules

#### ❑ RESTful API Rules

- Supported Request Method
- GET Request Components
- PUT Request Components
- RESTful API List
- Exception Code

#### ❑ Troubleshooting

- Forgot username & password
- Forgot IP address of the unit
- Failed to update firmware
- Failed to update configuration
- Failed to access the unit through IP address & IOxpress
- Failed to Enter System Ready Mode

## Network Port Usage

Service Type	TCP/UDP	Port	Default
DHCP	UDP	68	Disabled
Web Server	TCP	80	Enabled
RESTful API	TCP	80	Disabled
SNMP Agent	UDP	161	Disabled
HTTPs	TCP	443	Disabled
Modbus/TCP Slave	TCP	502	Enabled
Auto Search	UDP	4800	Enabled
IOxpress/CLI	TCP	10124	Enabled

## Modbus/TCP Slave Rules

### Supported Function Code

Point Type	Register (decimal)	Access	Type	Supported Function Code
01: COIL STATUS	0xxxx	R/W	bit	1, 5, 15
02: INPUT STATUS	1xxxx	R	bit	2
03: HOLDING REGISTER	4xxxx	R/W	word	3, 6, 16
04: INPUT REGISTER	3xxxx	R	word	4

### Exception Code

Code	Name	Comments
1	ILLEGAL FUNCTION	Function code is not valid.
2	ILLEGAL DATA ADDRESS	Data address is not valid.
3	ILLEGAL DATA VALUE	Writing value is not accepted.
4	SLAVE DEVICE FAILURE	Unrecoverable error occurred.

## System Registers

### 01: COIL STATUS

Parameter	Description	Length	Type
boolInternalRegister	BOOL Internal Register (BIR)	48	BOOL

### 02: INPUT STATUS

Parameter	Description	Length	Type
watchdogAlarmFlag	Watchdog alarm flag status (0: Normal, 1: alarm)	1	BOOL

### 03: HOLDING REGISTER

Parameter	Description	Length	Type
wirValue	WORD IR - Value	48	WORD
dirValue	DWORD IR - Value	96	DWORD
firValue	FLOAT IR - Value	96	REAL

**04: INPUT REGISTER**

Parameter	Description	Length	Type
modbusRtuMasterDeviceStatus	Modbus/RTU Master - device status	4	WORD
modbusRtuMasterprofileErrorCode	Modbus/RTU Master - profile error code	8	WORD
deviceName	device name	8	BYTE
deviceDate	device date e.g. 2016/06/28 -> 20160628	2	DWORD
deviceTime	device local time e.g. 15:48:25 -> 154825	2	DWORD
deviceUpTime	unit: sec(s)	2	DWORD
firmwareVersion	Each byte represents ASCII code. e.g. 1.2.3 --> V1.2.3 , 11.13.12 -->V11.13.12	4	BYTE
firmwareBuildDate	Each byte represents ASCII code. E.g. 16051718 --> Build16051718	4	BYTE
serialNumber	Each byte represents ASCII code of serial number English character : e.g. TAGCB1100001	6	BYTE
IanMac	MAC address	4	BYTE
IanIp	IP address	2	BYTE
systemError	System Error	1	WORD

**45MR-1600 (-T), 16 DIs Registers****01: COIL STATUS**

Parameter	Description	Length	Type
diCounterStatus	DI - Counter mode - status (0: Pause, 1: Run)	4	BOOL
diCounterOverflowFlagClear	DI - Counter mode - clear overflow flag (1: Clear)	4	BOOL

**02: INPUT STATUS**

Parameter	Description	Length	Type
diStatus	DI - DI mode - status (0: OFF, 1: ON)	16	BOOL
diMode	DI - mode (0: DI, 1: Counter)	16	BOOL
diCounterOverflowFlag	DI - Counter mode - overflow flag (0: Normal, 1: Overflow)	4	BOOL

**03: HOLDING REGISTER**

Parameter	Description	Length	Type
diCounterValue	DI - Counter mode - value	8	DWORD
diCounterStatusAll	DI - Counter mode - status (0: Pause, 1: Run)	1	WORD
diCounterOverflowFlagClearAll	DI - Counter mode - clear overflow flag (1: Clear)	1	WORD

**04: INPUT REGISTER**

Parameter	Description	Length	Type
diStatusAll	DI - DI mode - status (0: OFF, 1: ON)	1	WORD
diCounterOverflowFlagAll	DI - Counter mode - overflow flag (0: Normal, 1: Overflow)	1	WORD
diModeAll	DI - mode (0: DI, 1: Counter)	1	WORD

**45MR-1601 (-T), 16 DIs Registers****01: COIL STATUS**

Parameter	Description	Length	Type
diCounterStatus	DI - Counter mode - status (0: Pause, 1: Run)	4	BOOL
diCounterOverflowFlagClear	DI - Counter mode - clear overflow flag (1: Clear)	4	BOOL

**02: INPUT STATUS**

Parameter	Description	Length	Type
diStatus	DI - DI mode - status (0: OFF, 1: ON)	16	BOOL
diMode	DI - mode (0: DI, 1: Counter)	16	BOOL
diCounterOverflowFlag	DI - Counter mode - overflow flag (0: Normal, 1: Overflow)	4	BOOL

**03: HOLDING REGISTER**

Parameter	Description	Length	Type
diCounterValue	DI - Counter mode - value	8	DWORD
diCounterStatusAll	DI - Counter mode - status (0: Pause, 1: Run)	1	WORD
diCounterOverflowFlagClearAll	DI - Counter mode - clear overflow flag (1: Clear)	1	WORD

**04: INPUT REGISTER**

Parameter	Description	Length	Type
diStatusAll	DI - DI mode - status (0: OFF, 1: ON)	1	WORD
diCounterOverflowFlagAll	DI - Counter mode - overflow flag (0: Normal, 1: Overflow)	1	WORD
diModeAll	DI - mode (0: DI, 1: Counter)	1	WORD

**45MR-2404 (-T), 4 Relays Registers****01: COIL STATUS**

Parameter	Description	Length	Type
relayStatus	Relay - Relay mode - status (0: OFF, 1: ON)	4	BOOL
relayCurrentCountReset	Relay - reset current count (1: Reset)	4	BOOL

**03: HOLDING REGISTER**

Parameter	Description	Length	Type
relayStatusAll	Relay - Relay mode - status (0: OFF, 1: ON)	1	WORD

**04: INPUT REGISTER**

Parameter	Description	Length	Type
relayTotalCount	Relay - total count	8	DWORD
relayCurrentCount	Relay - current count	8	DWORD

**45MR-2600 (-T), 16 DOs Registers****01: COIL STATUS**

Parameter	Description	Length	Type
doStatus	DO - status (0: OFF, 1: ON)	16	BOOL
doPulseStatus	DO - Pulse mode - status (0: Stop, 1: Start)	4	BOOL

**02: INPUT STATUS**

Parameter	Description	Length	Type
doMode	DO - mode (0: DO, 1: Pulse)	16	BOOL

**03: HOLDING REGISTER**

Parameter	Description	Length	Type
doStatusAll	DO - status (0: OFF, 1: ON)	1	WORD
doPulseCount	DO - Pulse mode - count	8	DWORD
doPulseOnWidth	DO - Pulse mode - ON width (unit: 500 us)	4	WORD
doPulseOffWidth	DO - Pulse mode - OFF width (unit: 500 us)	4	WORD
doPulseStatusAll	DO - Pulse mode - status (0: Stop, 1: Start)	1	WORD

**04: INPUT REGISTER**

Parameter	Description	Length	Type
doModeAll	DO - mode (0: DO, 1: Pulse)	1	WORD

**45MR-2601 (-T), 16 DOs Registers****01: COIL STATUS**

Parameter	Description	Length	Type
doStatus	DO - status (0: OFF, 1: ON)	16	BOOL
doPulseStatus	DO - Pulse mode - status (0: Stop, 1: Start)	4	BOOL

**02: INPUT STATUS**

Parameter	Description	Length	Type
doMode	DO - mode (0: DO, 1: Pulse)	16	BOOL

**03: HOLDING REGISTER**

Parameter	Description	Length	Type
doStatusAll	DO - status (0: OFF, 1: ON)	1	WORD
doPulseCount	DO - Pulse mode - count	8	DWORD
doPulseOnWidth	DO - Pulse mode - ON width (unit: 500 us)	4	WORD
doPulseOffWidth	DO - Pulse mode - OFF width (unit: 500 us)	4	WORD
doPulseStatusAll	DO - Pulse mode - status (0: Stop, 1: Start)	1	WORD

**04: INPUT REGISTER**

Parameter	Description	Length	Type
doModeAll	DO - mode (0: DO, 1: Pulse)	1	WORD

**45MR-2606 (-T), 8 DIs, 8 DOs Registers****01: COIL STATUS**

Parameter	Description	Length	Type
doStatus	DO - status (0: OFF, 1: ON)	8	BOOL
diCounterStatus	DI - Counter mode - status (0: Pause, 1: Run)	2	BOOL
diCounterOverflowFlagClear	DI - Counter mode - clear overflow flag (1: Clear)	2	BOOL
doPulseStatus	DO - Pulse mode - status (0: Stop, 1: Start)	2	BOOL

**02: INPUT STATUS**

Parameter	Description	Length	Type
diStatus	DI - DI mode - status (0: OFF, 1: ON)	8	BOOL
diMode	DI - mode (0: DI, 1: Counter)	8	BOOL
doMode	DO - mode (0: DO, 1: Pulse)	8	BOOL
diCounterOverflowFlag	DI - Counter mode - overflow flag (0: Normal, 1: Overflow)	2	BOOL

**03: HOLDING REGISTER**

Parameter	Description	Length	Type
diCounterValue	DI - Counter mode - value	4	DWORD
doStatusAll	DO - status (0: OFF, 1: ON)	1	WORD
doPulseCount	DO - Pulse mode - count	4	DWORD
doPulseOnWidth	DO - Pulse mode - ON width (unit: 500 us)	2	WORD
doPulseOffWidth	DO - Pulse mode - OFF width (unit: 500 us)	2	WORD
doPulseStatusAll	DO - Pulse mode - status (0: Stop, 1: Start)	1	WORD
diCounterStatusAll	DI - Counter mode - status (0: Pause, 1: Run)	1	WORD
diCounterOverflowFlagClearAll	DI - Counter mode - clear overflow flag (1: Clear)	1	WORD

**04: INPUT REGISTER**

Parameter	Description	Length	Type
diStatusAll	DI - DI mode - status (0: OFF, 1: ON)	1	WORD
diCounterOverflowFlagAll	DI - Counter mode - overflow flag (0: Normal, 1: Overflow)	1	WORD
diModeAll	DI - mode (0: DI, 1: Counter)	1	WORD
doModeAll	DO - mode (0: DO, 1: Pulse)	1	WORD

**45MR-3800 (-T), 8 AIs Registers****01: COIL STATUS**

Parameter	Description	Length	Type
aiResetMinValue	AI - reset minimum value (1: Reset)	8	BOOL
aiResetMaxValue	AI - reset maximum value (1: Reset)	8	BOOL

**03: HOLDING REGISTER**

Parameter	Description	Length	Type
aiResetMinValueAll	AI - reset minimum value (1: Reset)	1	WORD
aiResetMaxValueAll	AI - reset maximum value (1: Reset)	1	WORD

**04: INPUT REGISTER**

Parameter	Description	Length	Type
aiValueRaw	AI - raw value	8	WORD
aiValueRawMin	AI - minimum raw value	8	WORD
aiValueRawMax	AI - maximum raw value	8	WORD
aiValueScaled	AI - scaled value	16	REAL
aiValueScaledMin	AI - minimum scaled value	16	REAL
aiValueScaledMax	AI - maximum scaled value	16	REAL
aiStatus	AI - status (0: normal, 1: burnout, 2: over range, 3: under range)	8	WORD
aiBurnoutValueScaled	AI - scaled burnout value	16	REAL
aiMode	AI - mode (0: disable, 1: 0-10 V, 2: 0-20 mA, 3: 4-20 mA burnout, 4: 4-20 mA, 5: $\pm 10$ V)	8	WORD

**45MR-3810 (-T), 8 AIs Registers****01: COIL STATUS**

Parameter	Description	Length	Type
aiResetMinValue	AI - reset minimum value (1: Reset)	8	BOOL
aiResetMaxValue	AI - reset maximum value (1: Reset)	8	BOOL

**03: HOLDING REGISTER**

Parameter	Description	Length	Type
aiResetMinValueAll	AI - reset minimum value (1: Reset)	1	WORD
aiResetMaxValueAll	AI - reset maximum value (1: Reset)	1	WORD



**04: INPUT REGISTER**

Parameter	Description	Length	Type
aiValueRaw	AI - raw value	8	WORD
aiValueRawMin	AI - minimum raw value	8	WORD
aiValueRawMax	AI - maximum raw value	8	WORD
aiValueScaled	AI - scaled value	16	REAL
aiValueScaledMin	AI - minimum scaled value	16	REAL
aiValueScaledMax	AI - maximum scaled value	16	REAL
aiStatus	AI - status (0: normal, 1: burnout, 2: over range, 3. under range)	8	WORD
aiBurnoutValueScaled	AI - scaled burnout value	16	REAL
aiMode	AI - mode (0: disable, 1: 0-10 V, 2: 0-20 mA, 3: 4-20 mA burnout, 4: 4-20 mA, 5: $\pm 10$ V)	8	WORD

**45MR-4420 (-T), 4 AOs Registers****03: HOLDING REGISTER**

Parameter	Description	Length	Type
aoValueRaw	AO - raw value	4	WORD
aoValueScaled	AO - scaled value	8	WORD

**04: INPUT REGISTER**

Parameter	Description	Length	Type
aoMode	AO - mode (0: disable, 1: 0-10 V, 2: 0-20 mA, 3: 4-20 mA, 4: $\pm 10$ V)	4	WORD

**45MR-6600 (-T), 6 RTDs Registers****01: COIL STATUS**

Parameter	Description	Length	Type
rtdResetMinValue	RTD - reset minimum value (1: Reset)	6	BOOL
rtdResetMaxValue	RTD - reset maximum value (1: Reset)	6	BOOL

**03: HOLDING REGISTER**

Parameter	Description	Length	Type
rtdResetMinValueAll	RTD - reset minimum value (1: Reset)	1	WORD
rtdResetMaxValueAll	RTD - reset maximum value (1: Reset)	1	WORD

**04: INPUT REGISTER**

Parameter	Description	Length	Type
rtdValueScaled	RTD - scaled value	12	REAL
rtdValueScaledMin	RTD - minimum scaled value	12	REAL
rtdValueScaledMax	RTD - maximum scaled value	12	REAL
rtdType	RTD - Type (0: PT50, 1: PT100, 2: PT200, 3: PT500, 4: PT1000; 14: 310 Ohm, 15: 620 Ohm, 16: 1250 Ohm, 17: 2200 Ohm; 20: JPT100, 21: JPT200, 22: JPT500, 23: JPT1000; 30: NI100, 31: NI200, 32: NI500, 33: NI1000, 34: NI120)	6	WORD
rtdStatus	RTD - Status (0: normal, 1: burnout)	6	WORD

## 45MR-6810 (-T), 8 TCs Registers

### 01: COIL STATUS

Parameter	Description	Length	Type
tcResetMinValue	TC - reset minimum value (1: Reset)	8	BOOL
tcResetMaxValue	TC - reset maximum value (1: Reset)	8	BOOL

### 03: HOLDING REGISTER

Parameter	Description	Length	Type
tcResetMinValueAll	TC - reset minimum value (1: Reset)	1	WORD
tcResetMaxValueAll	TC - reset maximum value (1: Reset)	1	WORD

### 04: INPUT REGISTER

Parameter	Description	Length	Type
tcValueScaled	TC - scaled value	16	REAL
tcValueScaledMin	TC - minimum scaled value	16	REAL
tcValueScaledMax	TC - maximum scaled value	16	REAL
tcType	TC - Type (0: J Type, 1: K Type, 2: T Type, 3: E Type, 4: R Type, 5: S Type, 6: B Type, 7: N Type, 14: $\pm 78.126$ mV, 15: $\pm 39.062$ mV, 16: $\pm 19.532$ mV)	8	WORD
tcStatus	TC - Status (0: normal, 1: burnout)	8	WORD

## SNMP Rules

All OIDs of this device begin with .1.3.6.1.4.1.8691.10.4510. The data can be read or written by a network management software with the following OIDs. Download the latest version of the MIB file from [www.moxa.com](http://www.moxa.com) for additional information.

OID	Type
.1.3.6.1.4.1.8691.10.4510.1	systemInfo
.1.3.6.1.4.1.8691.10.4510.11	di
.1.3.6.1.4.1.8691.10.4510.12	do
.1.3.6.1.4.1.8691.10.4510.13	relay
.1.3.6.1.4.1.8691.10.4510.21	ai
.1.3.6.1.4.1.8691.10.4510.23	rtd
.1.3.6.1.4.1.8691.10.4510.24	tc
.1.3.6.1.4.1.8691.10.4510.41	internalRegister

## RESTful API Rules

### Supported Request Method

Request	Description
GET	The GET method is used to retrieve information from the given server using a given URI. Requests using GET should only retrieve data and should have no other effect on the data.
PUT	Replaces all the current representations of the target resource with the uploaded content.
OPTIONS	Describe the communication options for the target resource.

## GET Request Components

Component	Content	Description
Request Method	GET	Use GET request to retrieve information
URL	http://{IP address}/{RESTful API}	Refer to <b>RESTful API List</b>
Headers	Accept: vdn.dac.v2 Content-Type: application/json	Headers are mandatory for all RESTful API requests

## PUT Request Components

Component	Content	Description
Request Method	PUT	Use PUT request to replace current representation
URL	http://{IP address}/{RESTful API}	Refer to <b>RESTful API List</b>
Headers	Accept: vdn.dac.v2 Content-Type: application/json	Headers are mandatory for all RESTful API requests
Body	{"value": 1}	Uploaded content for replacing current representation

## RESTful API List

Here lists the RESTful APIs supported by this device. The {ioName} is composed with three elements, including **Module\_Name**, **@**, and **I/O\_Channel\_Name**. For example, the {ioName} of the module name "45MR-1600-0" and the DI channel name "DI-00" is 45MR-1600-0@DI-00.

RESTful API	Description	Access	Format
/api/sysInfo	All system information	R	
/api/sysInfo/device	Device name	R	
	Device local date and time	R	yyyy/mm/dd hh:mm:ss
	Device up time	R	hh:mm:ss
	Firmware version	R	
	Serial number	R	
	System error	R	
/api/sysInfo/network	All network information	R	
/api/sysInfo/network/LAN	All LAN information	R	
/api/sysInfo/network/LAN/1	MAC address	R	xx:xx:xx:xx:xx:xx
	IP address	R	xxx.xxx.xxx.xxx
/api/io/ir/{ioName}	IR - value	R	By data type
/api/io/ir/{ioName}/irvalue	IR - value	RW	By data type
/api/io/di/{ioName}/diMode	DI - mode (0: DI, 1: Counter)	R	0 or 1
/api/io/di/{ioName}/diStatus	DI - DI mode - status (0: OFF, 1: ON)	R	0 or 1
/api/io/di/{ioName}/diCounterValue	DI - Counter mode - value	R/W	0 to 4294967295
/api/io/di/{ioName}/diCounterOverflowFlag	DI - Counter mode - overflow flag (0: Normal, 1: Overflow)	R	0 or 1
/api/io/di/{ioName}/diCounterOverflowFlag Clear	DI - Counter mode - clear overflow flag (1: Clear)	R/W	0 or 1
/api/io/di/{ioName}/diCounterStatus	DI - Counter mode - status (0: pause, 1: run)	R/W	0 or 1
/api/io/do/{ioName}/doMode	DO - mode (0: DO, 1: Pulse)	R	0 or 1

RESTful API	Description	Access	Format
/api/io/do/{ioName}/doStatus	DO - status (0: OFF, 1: ON)	R/W	0 or 1
/api/io/do/{ioName}/doPulseCount	DO - Pulse mode - count	R/W	0 to 65535
/api/io/do/{ioName}/doPulseOnWidth	DO - Pulse mode - ON width (unit: 500us)	R/W	1 to 65535
/api/io/do/{ioName}/doPulseOffWidth	DO - Pulse mode - OFF width (unit: 500us)	R/W	1 to 65535
/api/io/do/{ioName}/doPulseStatus	DO - Pulse mode - status (0: Stop 1: Start)	R/W	0 or 1
/api/io/relay/{ioName}/relayTotalCount	Relay - total count	R	0 to 4294967295
/api/io/relay/{ioName}/relayCurrentCount	Relay - current count	R	0 to 4294967295
/api/io/relay/{ioName}/relayCurrentCountReset	Relay - reset current count (1: Reset)	R/W	0 or 1
/api/io/relay/{ioName}/relayStatus	Relay - Relay mode - status (0: OFF, 1: ON)	R/W	0 or 1
/api/io/ai/{ioName}/aiMode	AI - mode (0: disable 1: 0-10 V, 2: 0-20 mA, 3: 4-20 mA burnout, 4: 4-20 mA, 5: ±10 V)	R	0, 1, 2, 3, 4, 5
/api/io/ai/{ioName}/aiValueRaw	AI - raw value	R	0 to 65535
/api/io/ai/{ioName}/aiValueRawMin	AI - minimum raw value	R	0 to 65535
/api/io/ai/{ioName}/aiValueRawMax	AI - maximum raw value	R	0 to 65535
/api/io/ai/{ioName}/aiResetMinValue	AI - reset minimum value (1: Reset)	R/W	1
/api/io/ai/{ioName}/aiResetMaxValue	AI - reset maximum value (1: Reset)	R/W	1
/api/io/ai/{ioName}/aiStatus	AI - status (0: normal, 1: burnout, 2: over range, 3. under range)	R	0, 1, 2, 3
/api/io/ai/{ioName}/aiBurnoutValueScaled	AI - scaled burnout value	R	Float
/api/io/ai/{ioName}/aiValueScaled	AI - scaled value	R	Float
/api/io/ai/{ioName}/aiValueScaledMin	AI - minimum scaled value	R	Float
/api/io/ai/{ioName}/aiValueScaledMax	AI - maximum scaled value	R	Float
/api/io/ao/{ioName}/aoMode	AO - mode (0: disable, 1: 0-10 V, 2: 0-20mA, 3: 4-20 mA, 4: +/-10V)	R	0, 1, 2, 3, 4
/api/io/ao/{ioName}/aoValueRaw	AO - raw value	R/W	0 to 65535
/api/io/ao/{ioName}/aoValueScaled	AO - scaled value	R/W	0 to 4294967295
/api/io/rtd/{ioName}/rtdStatus	RTD - Status (0: normal, 1: burnout)	R	0 or 1
/api/io/rtd/{ioName}/rtdMode	RTD - Type (0: PT50, 1: PT100, 2: PT200, 3: PT500, 4: PT1000; 14: 310 Ohm, 15: 620 Ohm, 16: 1250 Ohm, 17: 2200 Ohm; 20: JPT100, 21: JPT200, 22: JPT500, 23: JPT1000; 30: NI100, 31: NI200, 32: NI500, 33: NI1000, 34: NI120)	R	
/api/io/rtd/{ioName}/rtdValueScaled	RTD - scaled value	R	Float
/api/io/rtd/{ioName}/rtdValueScaledMin	RTD - minimum scaled value	R	Float
/api/io/rtd/{ioName}/rtdValueScaledMax	RTD - maximum scaled	R	Float

RESTful API	Description	Access	Format
	value		
/api/io/rtd/{ioName}/rtdResetMinValue	RTD - reset minimum value (1: RESET)	R/W	1
/api/io/rtd/{ioName}/rtdResetMaxValue	RTD - reset maximum value (1: RESET)	R/W	1
/api/io/tc/{ioName}/tcStatus	TC - Status (0: normal, 1: burnout)	R	0 or 1
/api/io/tc/{ioName}/tcType	TC - Type (0: J Type, 1: K Type, 2: T Type, 3: E Type, 4: R Type, 5: S Type, 6: B Type, 7: N Type, 14: $\pm 78.126$ mV, 15: $\pm 39.062$ mV, 16: $\pm 19.532$ mV)	R	
/api/io/tc/{ioName}/tcValueScaled	TC - scaled value	R	Float
/api/io/tc/{ioName}/tcValueScaledMin	TC - minimum scaled value	R	Float
/api/io/tc/{ioName}/tcValueScaledMax	TC - maximum scaled value	R	Float
/api/io/tc/{ioName}/tcResetMinValue	TC - reset minimum value (1: RESET)	R/W	1
/api/io/tc/{ioName}/tcResetMaxValue	TC - reset maximum value (1: RESET)	R/W	1

## Exception Code

HTTP Status Code		Moxa Status Code/Description		User message
400	Bad Request	101	UnsupportedVersion	The content version specified in the request is not supported.
400	Bad Request	102	UnsupportedDocFormat	The document format specified in the request is not supported.
400	Bad Request	201	InvalidJsonFormat	The json format in the request is not valid.
400	Bad Request	202	InvalidNodeValue	One of the node value is invalid.
400	Bad Request	203	WrongChannelOrder	The I/O channels are disordered.
400	Bad Request	204	MissingRequiredChannel	A required channel index was not specified in the request body.
400	Bad Request	206	MissingRequiredNode	A required node was not specified in the request body.
400	Bad Request	300	ContentFailed	One of the channel contents in the request could not be set. Please refer to the detailed information.
400	Bad Request	301	ContentFailedToSet	The content in the request could not be set (invalid value).
200	OK	N/A		
404	Bad Request	N/A		
405	Method Not Allowed	N/A		

## Troubleshooting

This section provides troubleshooting instructions for this device.

## Forgot username & password

If you forget your username and password, use a pointed object such as a straightened paper clip to hold down the Reset Button for 10 seconds. This will restart the unit and reset all settings on the device, including the username and password. The factory defaults will be loaded once the READY LED turns green again.

**INFORMATION** The default username is admin, and the default password is moxa.

## Forgot IP address of the unit

If you forget the IP address of the unit, use IOExpress utility to search for the device if IOExpress service is already enabled in **Security** → **Service Settings**. Otherwise, load the factory default settings and access the unit with the default IP address.

**Step 1:** Open IOExpress, go to **Device Library** and click **Device** → **Search** in the menu.

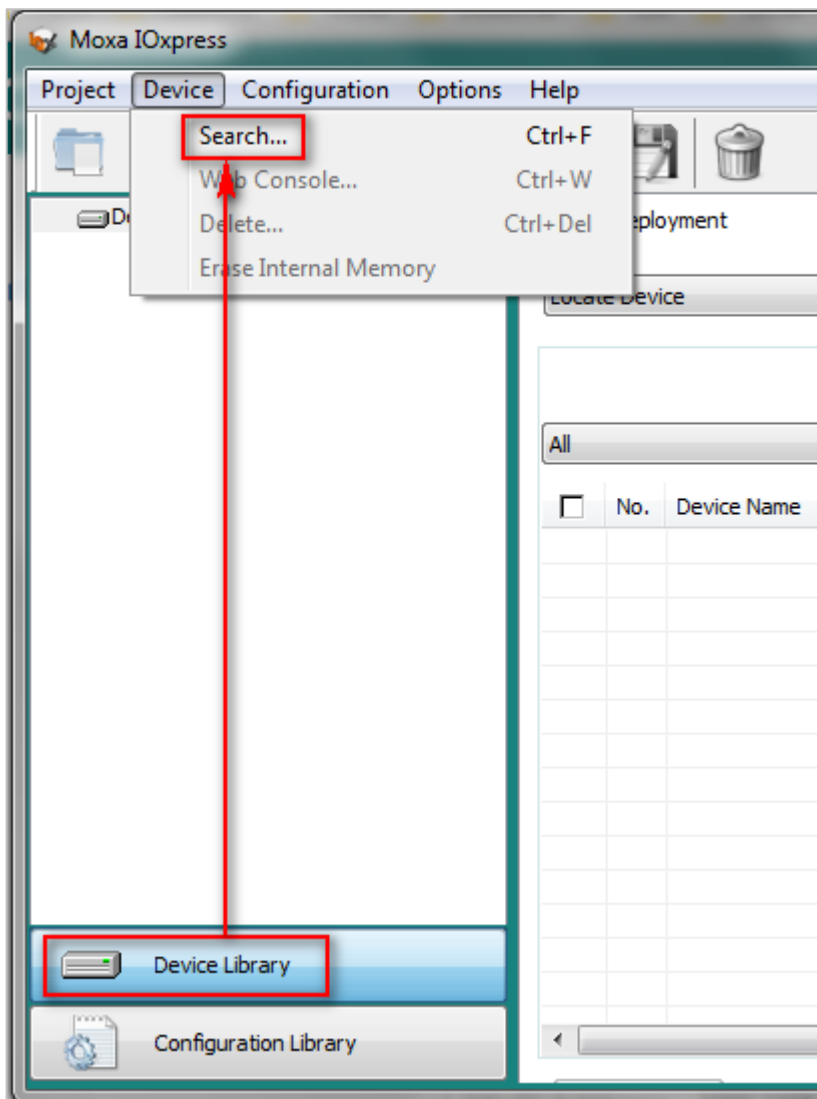

**Step 2:** In the **Search for Devices** window, choose the product series you would like to search in the **By Product Series** dropdown menu, and then click the **Submit** button. IOxpress will start to search the devices and list them in the table.

The screenshot shows the 'Search for Devices' dialog box with the following configuration:

- Tab: LAN
- Search Method:  By Product Series (dropdown: All)
- Search Method:  By Product Model (dropdown: All)
- Search Method:  By MAC Address (00 : 90 : E8 : 00 : 00 : 01)
- Search Method:  By IP Address (192 . 168 . 1 . 1 to 192 . 168 . 1 . 254)
- Mask:  Mask (255 . 255 . 255 . 0)
- Buttons: Submit, Cancel

## Failed to update firmware

If the firmware update process fails, the firmware file may be corrupted. Download the firmware file from Moxa's official website. Otherwise, check if the power supply is stable. An unstable power supply can lead to an incomplete firmware update.

**NOTE** This device supports firmware automatic recovery function. If the firmware in the device is corrupted, the system will load the backup firmware automatically to overwrite the corrupted one. When the system is in recovery mode, the RDY LED will blink RED slowly. Do not disconnect the power cable when performing the recovery process. After the recovery process is complete, you can update firmware again.

## Failed to update configuration

If the configuration update process fails, the configuration file may be corrupted. Get the configuration file and update it again. Otherwise, check to see if the power supply is stable. An unstable power supply can result in the configurations not being successfully updated.

## Failed to access the unit through IP address & IOxpress

Incorrect network configurations can result in the user not being able to access the unit. Check if the device and PC are in the same subnet by following the procedure below.

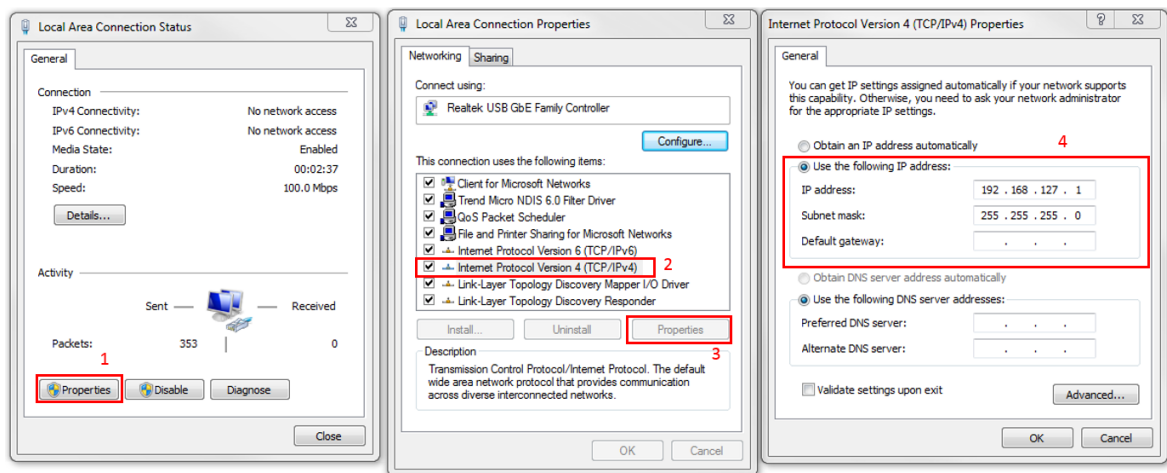

**INFORMATION** The default IP address of the device is 192.168.127.254.

This may also occur when you try to configure multiple devices with the same computer. The reason for this could be that multiple devices have the same default IP address. When sending TCP/IP packets, the packet may get sent to the wrong MAC address, as it follows the previous record in the computer's ARP Cache. To rectify this problem, you can erase the ARP Cache records by entering "arp -d" command in the built-in Command-Line tools.

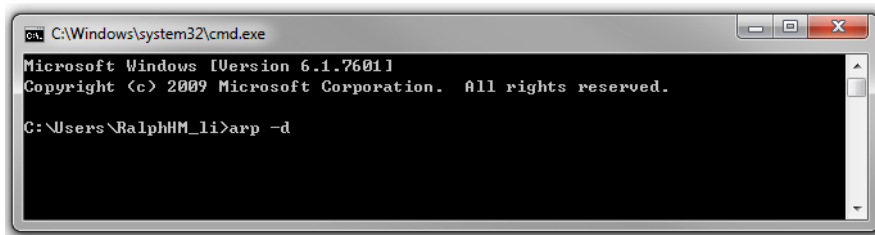

## Failed to Enter System Ready Mode

If the RDY LED stays red, and your web console is not accessible, it means that the system is experiencing an error. Follow the steps to recover the system.

**Step 1:** Hold down the RESET button for 30 seconds to trigger the system recovery process. The system will load the backup firmware and then restart the unit. The system is ready when the RDY LED is green.

**Step 2:** Open the web console and then update the firmware and configurations to the device.