

ioLogik E2260 User's Manual

Fourth Edition, June 2009

www.moxa.com/product

MOXA®

© 2009 Moxa Inc. All rights reserved.
Reproduction without permission is prohibited.

ioLogik E2260 User's Manual

The software described in this manual is furnished under a license agreement, and may be used only in accordance with the terms of that agreement.

Copyright Notice

Copyright © 2009 Moxa Inc.
All rights reserved.
Reproduction without permission is prohibited.

Trademarks

MOXA is a registered trademark of Moxa Inc.
All other trademarks or registered marks in this manual belong to their respective manufacturers.

Disclaimer

Information in this document is subject to change without notice, and does not represent a commitment on the part of Moxa.

Moxa provides this document “as is,” without warranty of any kind, either expressed or implied, including, but not limited to, its particular purpose. Moxa reserves the right to make improvements, and/or changes to this manual, or to the products, and/or the programs described in this manual, at any time.

Information provided in this manual is intended to be accurate, and reliable. However, Moxa assumes no responsibility for its use, or for any infringements on the rights of third parties that may result from its use.

This manual might include unintentional technical or typographical errors. Changes are made periodically to the information herein to correct such errors, and these changes are incorporated into new editions of the manual.

Technical Support Contact Information

www.moxa.com/support

Moxa Americas:

Toll-free: 1-888-669-2872
Tel: +1-714-528-6777
Fax: +1-714-528-6778

Moxa China (Shanghai office):

Toll-free: 800-820-5036
Tel: +86-21-5258-9955
Fax: +86-10-6872-3958

Moxa Europe:

Tel: +49-89-3 70 03 99-0
Fax: +49-89-3 70 03 99-99

Moxa Asia-Pacific:

Tel: +886-2-8919-1230
Fax: +886-2-8919-1231

Table of Contents

Chapter 1.	Introduction	1-1
	Overview	1-2
	Traditional Remote I/O.....	1-2
	Active Ethernet I/O.....	1-2
	Click&Go	1-3
	Optional Liquid Crystal Display Module (LCM)	1-3
	Product Features	1-3
	Packing List.....	1-3
	Product Specifications.....	1-4
	Physical Dimensions	1-6
	With LCD Module.....	1-6
	Without LCD Module.....	1-7
	Hardware Reference	1-7
	Panel Guide	1-7
	LED Indicators	1-8
Chapter 2.	Initial Setup.....	2-1
	Hardware Installation	2-2
	Connecting the Power.....	2-2
	Grounding the ioLogik E2260.....	2-2
	Connecting to the Network.....	2-2
	Setting the RS-485 Baudrate	2-2
	Adding More I/O Channels	2-3
	Software Installation.....	2-3
Chapter 3.	Utilities	3-1
	Introduction to ioAdmin	3-2
	Features of ioAdmin	3-2
	ioAdmin Main Screen.....	3-4
	Main Screen Overview	3-4
	Wiring Guide	3-5
	Menu Items.....	3-5
	File.....	3-5
	System	3-6
	Sort	3-7
	Help	3-7
	Quick Links	3-7
	Main Window	3-8
	I/O Configuration Tab (General)	3-8
	Server Info Tab.....	3-8
	Server Settings Tab (General)	3-9
	Message Monitor Tab.....	3-9
	ioAdmin Administrator Functions	3-10
	I/O Configuration Tab (Administrator)	3-10
	Server Settings Tab (Administrator).....	3-13
	Network Tab.....	3-15
	Firmware Update Tab.....	3-17
	Watchdog Tab.....	3-17
	Click&Go Logic Tab	3-18

	Active Tags Tab.....	3-19
	SNMP Settings Tab	3-20
	Server Context Menu	3-20
	Using TFTP to Import/Export Configuration	3-22
	Using ioEventLog.....	3-23
	Installing ioEventLog	3-23
	Basic Functions.....	3-23
	Configuration.....	3-24
	Checking Connected Devices	3-25
	Opening Log Files	3-25
	Clearing the Log	3-26
Chapter 4.	Using the Web Console	4-1
	Introduction to the Web Console	4-2
	Basic Settings	4-2
	Network Settings	4-3
	General Settings.....	4-3
	Ethernet Configuration	4-3
	RS-485 Settings	4-4
	I/O Settings.....	4-4
	RTD Channels	4-4
	DO Channels	4-5
	System Management	4-6
	Accessible IP Settings.....	4-6
	SNMP Agent	4-7
	Network Connection.....	4-7
	Firmware Update	4-8
	Import System Config	4-8
	Export System Config	4-8
	LCM	4-9
	Change Password.....	4-9
	Load Factory Default.....	4-9
	Save/Restart.....	4-9
Chapter 5.	Active OPC Server Lite	5-1
	Overview	5-2
	Introduction to Active OPC Server Lite	5-2
	Active OPC Server Lite – From Pull to Push	5-3
	Features of Active OPC Server Lite	5-4
	Active OPC Server Lite Specifications	5-5
	Installation of Active OPC Server Lite.....	5-5
	Installation of OPC Core Components	5-5
	Active OPC Server Lite.....	5-6
	Main Screen Overview	5-6
	Menu Items.....	5-7
	File.....	5-7
	System	5-7
	Sort	5-8
	Quick Links	5-8
	Tag Generation	5-9
	Push Tag Configuration from ioAdmin	5-9
	Advanced Settings	5-11

	Heartbeat Interval	5-11
	Read/Write Privilege	5-12
	OPC Test Client.....	5-12
Appendix A.	Liquid Crystal Display Module (LCM).....	A-1
Appendix B.	Modbus/TCP Address Mappings	B-1
	0xxxx Read/Write Coils (Functions 1, 5, 15)	B-1
	3xxxx Read Only Registers (Function 4)	B-2
	4xxxx Read/Write Registers (Functions 3, 6, 16).....	B-3
Appendix C.	Used Network Port Numbers.....	C-1
Appendix D.	SNMP MIB II	D-1
	RFC1213 MIB II Supported SNMP Variables.....	D-1
	Private MIB File and SNMP Variables	D-4
Appendix E.	CGI Commands	E-1
Appendix F.	Factory Default Settings	F-1
Appendix G.	Pinouts and Cable Wiring	G-1
	Ethernet Port Pinouts	G-1
	Serial Port Pinouts	G-1
	RTD Input Wiring.....	G-1
	Structure	G-1
	2-wire.....	G-2
	3-wire.....	G-2
	Digital Output.....	G-2
	Structure	G-2
	Output Channel.....	G-3
	Terminal Block Pin Assignments.....	G-3
Appendix H.	Accuracy	H-1
	Calibration	H-1
	Simple Verification at Your Site	H-1
	Verification with RTD Sensor	H-1
	Verification with Precision Resistor	H-1

The ioLogik E2260 is a stand-alone Active Ethernet I/O server. It connects RTD sensors and digital output on/off switches for automation applications over Ethernet and IP-based networks.

The following topics are covered in this chapter:

- Overview**
 - Traditional Remote I/O
 - Active Ethernet I/O
 - Click&Go
 - Optional Liquid Crystal Display Module (LCM)
- Product Features**
- Packing List**
- Product Specifications**
- Physical Dimensions**
 - With LCD Module
 - Without LCD Module
- Hardware Reference**
 - Panel Guide
 - LED Indicators

Overview



(shown with and without optional LCM)

The ioLogik E2260 is part of the E2000 line of ioLogik Active Ethernet I/O servers, which are designed for intelligent, pro-active status reporting of attached sensors, transmitters, transducers, and valves over a network. It includes 2 MB of Flash ROM and 8 MB of SDRAM. An optional hot-pluggable Liquid Crystal Display Module (LCM) can be used to view and configure device settings.

Traditional Remote I/O

Ethernet remote I/O solutions have been on the market for a long time. Traditional solutions are “passive,” in the sense that I/O servers wait passively to be polled by a host computer. The response time in this type of setup, however, tends to be on the order of seconds. The “passive” remote I/O structure is simply inadequate for data acquisition and control systems that require a response time on the order of hundredths of seconds.

Active Ethernet I/O

Moxa's Active Ethernet I/O line was developed specifically to address the limitations of the traditional passive approach. Rather than having the host computer poll the I/O device server over the network for the status of each I/O device, the Active Ethernet I/O server intelligently sends the host computer status information under user-specified conditions. This is a report by exception approach, which greatly reduces the load on CPU and network resources. Network packets are far fewer in number and far smaller in size, since I/O information is only sent when necessary, and only information from the specified I/O device is sent. Based on field tests of an ioLogik E2000 series server used in an RFID system, 50 ms is the typical response time over a 100 Mbps Ethernet network. Moxa's active I/O messaging system uses TCP or UDP for I/O messaging and supports sending messages to up to ten host computers simultaneously.

In addition to providing intelligent status reporting, Active Ethernet I/O servers are backwards compatible, with all of the functions and capabilities of traditional passive remote I/O servers.

Click&Go

Moxa developed the Click&Go Logic control interface for easy configuration and deployment of Active Ethernet I/O. Click&Go's intuitive, graphical interface lets administrators use simple IF/THEN statements as rules to determine how the Active Ethernet I/O server responds to different I/O conditions. For example, the Active Ethernet I/O server could be programmed so that if the temperature recorded by an attached sensor reaches a certain value, an attached switch is turned on and an e-mail is sent to an administrator. Click&Go makes it easy to define a set of these rules, which will become the basis for your Active Ethernet I/O system.

Optional Liquid Crystal Display Module (LCM)

In order to make user easy view, the ioLogik E2260 supports an optional hot-pluggable Liquid Crystal Display Module (LCM) for field management and configuration. The LCM can display network and I/O settings such as temperature value. The ioLogik E2260's IP address and netmask may also be configured using the LCM, and one LCM can be used to maintain and configure all ioLogik 2000 devices.

Product Features

- Click&Go Logic for easy configuration of your Active Ethernet I/O system
- High-speed active I/O messaging
- 6 input channels for 2-wire or 3-wire resistance temperature devices (RTD) such as PT100, JPT100, and more, with software selectable filtering time
- 4 channels for 24 VDC output with Pulse Output mode and software selectable pulse width
- 10/100 Mbps Ethernet supporting Modbus/TCP and up to 10 hosts
- Windows utility and quick programming library for VB, VC++, BCB (coming soon)
- Expandable I/O through optional RS-485 modules
- Supports SCADA software including Wonderware InTouch and GE Intellution iFix32
- SNMP for system management and I/O status
- Remote management over the network including firmware updates
- Supports TFTP server to import configuration
- Power-on and safe status settings for digital output
- Optional hot-pluggable LCM for status display and configuration

Packing List

The ioLogik E2260 is shipped with the following items:

Standard Accessories

- ioLogik E2260 Active Ethernet I/O server
- Document and Software CD

Optional Accessories

- LDP1602 ioLogik liquid crystal display module (LCM)

NOTE: Notify your sales representative if any of the above items are missing or damaged.

Product Specifications

LAN

Ethernet	10/100 Mbps, RJ45
Protection	1.5 KV magnetic isolation
Protocols	Modbus/TCP, TCP/IP, UDP, DHCP, Bootp, SNMP(MIB for I/O and Network), HTTP

Serial

Interface	RS-485 (2-wire): Data+, Data-, GND
Serial Line Protection	15 KV ESD for all signals

Serial Communication Parameters

Parity	None
Data Bits	8
Stop Bits	1
Flow Control	None
Speed	1200 to 115200 bps
Protocol	Modbus/RTU
Built-in RTC	Yes

RTD Input

Channels	6, resistance temperature devices
I/O Mode	PT, JPT, Ni, resistor with burn-out detection
Input Impedance	5 M Ω (typical), 625 K Ω (min.)
Input Connection	2 or 3 wire
Resolution	16 bits
Sample Rate	12 samples/sec (all channels)
Accuracy	+/-0.1%
Zero Drift	+/- 3 μ V/C (typical)
Span Drift	+/- 25 ppm/C
CMR @50/60Hz	120 dB
NMR @50/60Hz	100 dB
Optical Isolation	2 KVRms / 3 KVDC
Supported RTD Types	

<u>Sensor Type</u>	<u>Degree</u>	<u>Degree</u>	<u>Count</u>
Res. 100 m Ω	1 to 2200 Ω	1 to 2200 Ω	10 to 22000
Res. 50 m Ω	1 to 1250 Ω	1 to 1250 Ω	20 to 25000
Res. 20 m Ω	1 to 620 Ω	1 to 620 Ω	50 to 31000
Res. 10 m Ω	1 to 310 Ω	1 to 310 Ω	100 to 31000
PT50, 0.00385	-200 to 850 $^{\circ}$ C	-328 to 1562 $^{\circ}$ F	-2000 to 8500
PT100, 0.00385	-200 to 850 $^{\circ}$ C	-328 to 1562 $^{\circ}$ F	-2000 to 8500
PT200, 0.00385	-200 to 850 $^{\circ}$ C	-328 to 1562 $^{\circ}$ F	-2000 to 8500
PT500, 0.00385	-200 to 850 $^{\circ}$ C	-328 to 1562 $^{\circ}$ F	-2000 to 8500
PT1000, 0.00385	-200 to 350 $^{\circ}$ C	-328 to 662 $^{\circ}$ F	-2000 to 3500
JPT100, 0.003916	-200 to 640 $^{\circ}$ C	-328 to 1184 $^{\circ}$ F	-2000 to 6400
JPT200, 0.003916	-200 to 640 $^{\circ}$ C	-328 to 1184 $^{\circ}$ F	-2000 to 6400
JPT500, 0.003916	-200 to 640 $^{\circ}$ C	-328 to 1184 $^{\circ}$ F	-2000 to 6400
JPT1000, 0.003916	-200 to 350 $^{\circ}$ C	-328 to 662 $^{\circ}$ F	-2000 to 3500
Ni100, 0.00618	-60 to 250 $^{\circ}$ C	-76 to 482 $^{\circ}$ F	-600 to 2500
Ni200, 0.00618	-60 to 250 $^{\circ}$ C	-76 to 482 $^{\circ}$ F	-600 to 2500
Ni500, 0.00618	-60 to 250 $^{\circ}$ C	-76 to 482 $^{\circ}$ F	-600 to 2500
Ni1000, 0.00618	-60 to 180 $^{\circ}$ C	-76 to 356 $^{\circ}$ F	-600 to 1800
Ni120, 0.00672	-80 to 260 $^{\circ}$ C	-112 to 500 $^{\circ}$ F	-800 to 2600

Virtual RTD	
Channels	6
Operation Mode	Average, Subtraction
Digital Output	
Channels	4, sink type
On-state Voltage	24 VDC nominal, 30 VDC max.
Output Current Rating	Max. 200 mA per channel
Optical Isolation	2 KVrms/3 KVDC
Protection	Over temperature shutdown: 170°C Over current limit: 750 mA/channel (typical)
Power Requirements	
Power Input	24 VDC nominal, 12 to 48 VDC (max.)
Power Consumption	2.16 W @ 24 VDC (typical) 3.54 W with LCM (max.)
Field Power	24 VDC nominal, up to 48 VDC
Mechanical Specifications	
Wiring	I/O cable max. 14 AWG
Environmental	
Operating Temperature	-10 to 60°C (14 to 140°F), 5 to 95%RH
Storage Temperature	-40 to 85°C (-4 to 185°F), 5 to 95%RH
Shock	IEC60068-2-27
Freefall	IEC60068-2-32
Vibration	IEC60068-2-6
MTBF	> 200,000 hrs @ 25°C
Agency Approvals	
EMC	FCC Part 15, CISPR (EN55022) Class A CE-IEC61000-4-2 (ESD), Level 2/3 CE-IEC61000-4-3 (RS), Level 2 CE-IEC61000-4-4 (EFT), Level 2 CE-IEC61000-4-5 (Surge), Level 3 CE-IEC61000-4-6 (CS), Level 2 CE-IEC61000-4-8 (PM), Level 1 CE-IEC61000-4-11 (Dip) CE-EN61000-6-2 CE-EN61000-6-4
Safety	UL 508
Warranty	
Period	2 years

Physical Dimensions

With LCD Module

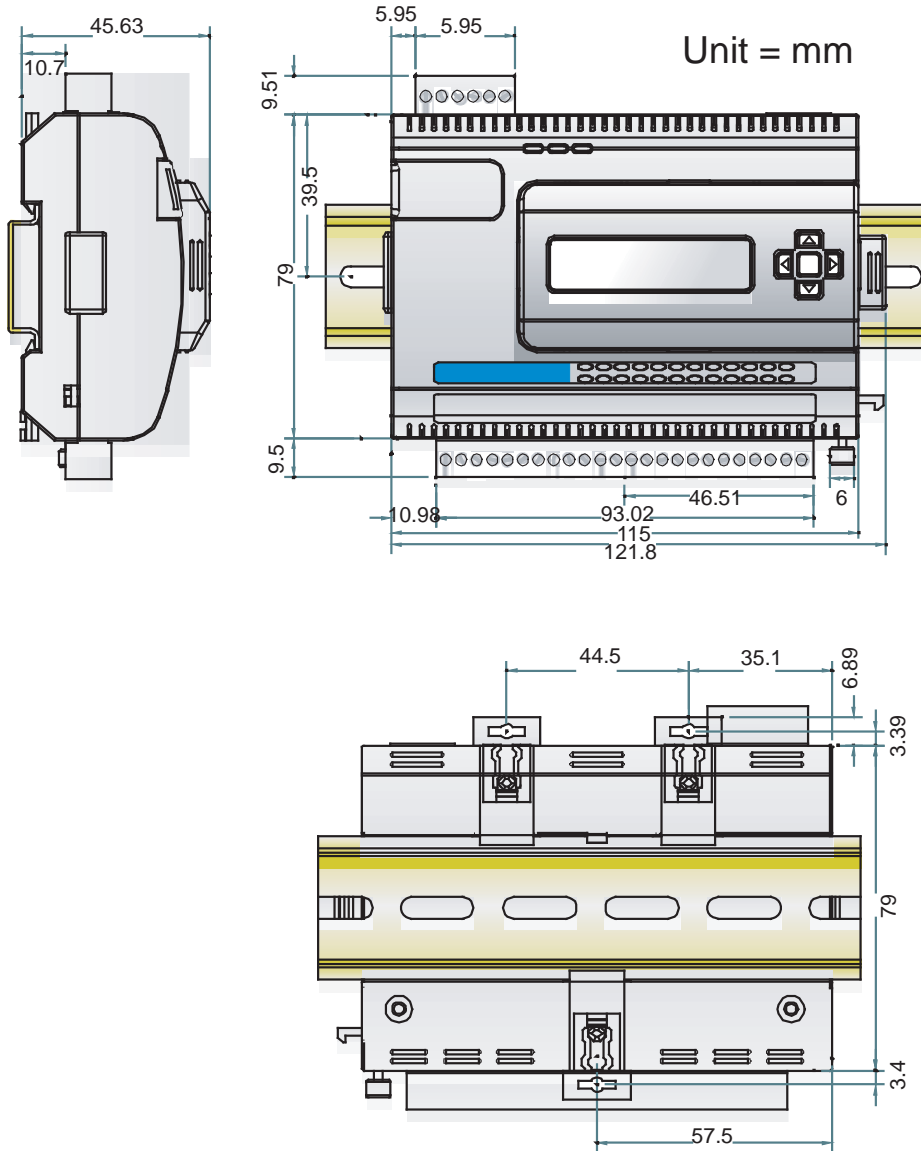

Without LCD Module

Unit = mm

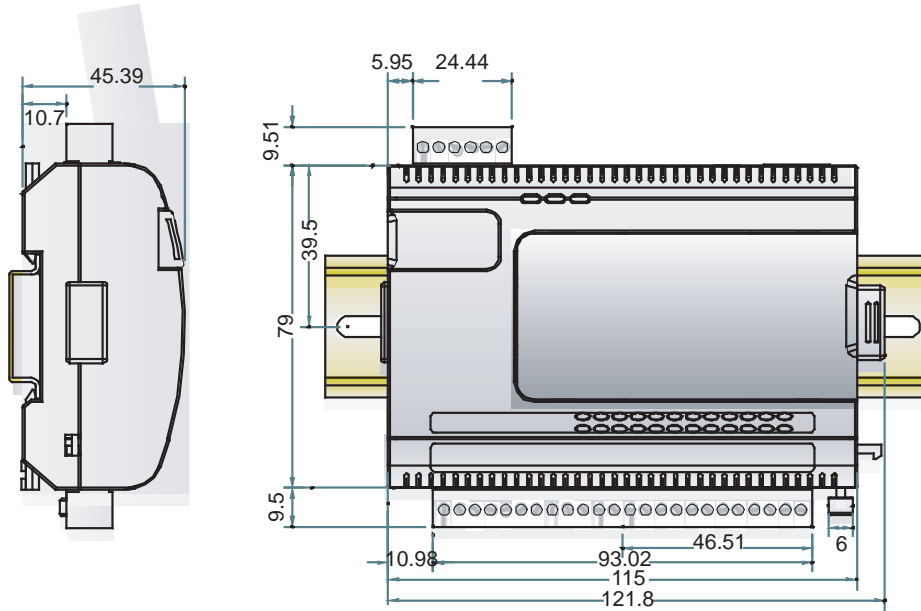

Hardware Reference

Panel Guide

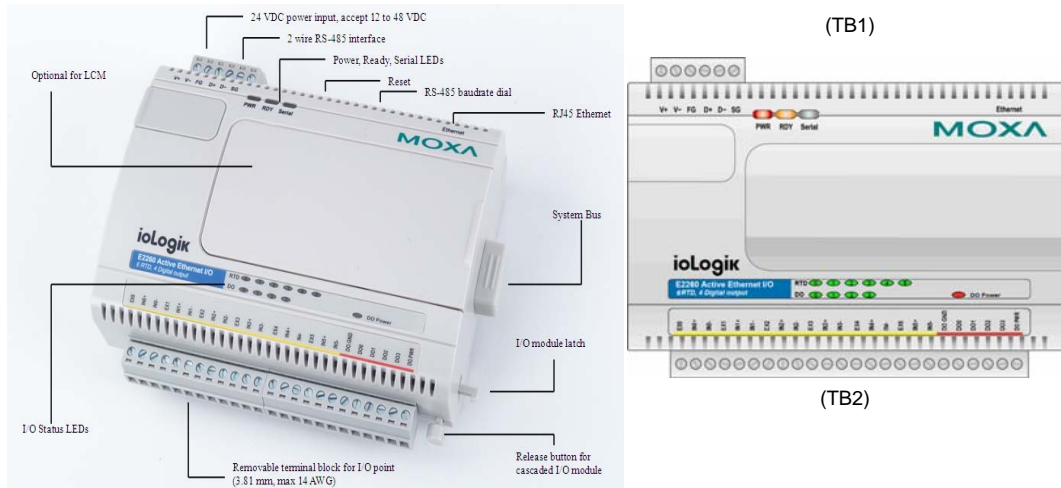

NOTE: The reset button restarts the server and resets all settings to factory defaults. Use a pointed object such as a straightened paper clip to hold the reset button down for 15 sec. The RDY LED will turn red as you are holding the reset button down. The factory defaults will be loaded once the RDY LED turns green again. You may then release the reset button.

LED Indicators

Ethernet		
Ethernet	orange	Valid 10 Mbps Ethernet connection
	green	Valid 100 Mbps Ethernet connection
	(flashing)	Transmitting or receiving data
System		
PWR	red	Power is on
	off	Power is off
RDY	red	System error
	green (steady)	Unit is functioning normally
	green (flashing)	Click&Go ruleset is active
	green & red (flashing)	Safe status settings activated
	off	Power is off or there is a power problem.
Serial	(flashing)	Serial port is receiving/transmitting data
RTD		
RTD × 6 pins	green	Normal operation
	red	Channel error or no connection
	off	Channel off
Digital Output		
DO × 4 pins	green	ON status
	off	OFF status
DO PWR	red	ON status
	off	No power in

2

Initial Setup

This chapter describes how to install the ioLogik E2260.

The following topics are covered:

- Hardware Installation**
 - Connecting the Power
 - Grounding the ioLogik E2260
 - Connecting to the Network
 - Setting the RS-485 Baudrate
 - Adding More I/O Channels
- Software Installation**

Hardware Installation

Connecting the Power

Connect the 12 to 48 VDC power line to the ioLogik E2260's terminal block (TB1). If power is properly supplied, the Power LED will glow a solid red color until the system is ready



ATTENTION

Disconnect the power before installing and wiring

Disconnect the power cord before installing and/or wiring your ioLogik E2260.

Do not exceed the maximum current for the wiring

Determine the maximum possible current for each power wire and common wire. Observe all electrical codes dictating the maximum current allowable for each wire size.

If the current exceeds the maximum rating, the wiring could overheat, causing serious damage to your equipment.

Grounding the ioLogik E2260

There are two grounding points on the ioLogik E2260: the wall mounting point and the DIN-rail mounting plate. Note that both grounding points are actually connected to the same conducting pathway.

Connecting to the Network

1. Connect the ioLogik E2260 to the host PC with an Ethernet cable. For initial setup of the ioLogik E2260, it is recommended that the ioLogik E2260 be configured using a direct connection to a host computer rather than remotely over the network.
2. Note the ioLogik's default IP settings:

IP Address	Netmask	Gateway
192.168.127.254	255.255.255.0	None

Configure the host PC's IP address to 192.168.127.xxx. (xxx: from 001 to 253) so the ioLogik will be visible on the network. In Windows, you will need to do this through the Control Panel.

3. Use ioAdmin or the web console to detect the ioLogik E2260. Once the ioLogik E2260 has been detected, modify the settings as needed for your network environment, then restart the ioLogik E2260. For information on ioAdmin, please refer to Software Installation later in this chapter.

Setting the RS-485 Baudrate

The RS-485 port on the ioLogik E2260 is reserved for connecting to another RS-485 I/O server. The RS-485 port can run Modbus/RTU or I/O command sets. The baudrate is set by a physical dial on the back of the ioLogik E2260. The default settings are baudrate = 115200, parity check = N, data bits = 8, and stop bit = 1.

	Baudrate for RS-485 (parameters are N, 8, 1)	Dial setting and corresponding baudrate:			
		0:115200	1:57600	2:38400	3:19200
		4:9600	5:4800	6:2400	7:1200

Remember to restart the ioLogik E2260 after making any changes to the RS-485 baudrate.

Adding More I/O Channels

A cost effective way to add more I/O channels to your ioLogik E2000 I/O server is to attach the appropriate ioLogik R2000 I/O server. The two servers can be snapped together using the RS-485 system bus connector, as shown in the following figure. Digital I/O channels can be added using the ioLogik R2110, and analog I/O channels can be added using the ioLogik E2140. For additional details, please refer to the ioLogik R2110 or R2140 user's manual.



Software Installation

ioAdmin is a Windows utility provided for the configuration and management of the ioLogik E2260 and attached I/O devices. It may be used from anywhere on the network to monitor and configure the ioLogik E2260. You may also configure some of the settings through the web console or optional LCM.

1. **Installation from CD:** Insert the Document and Software CD into the host computer. In the root directory of the CD, locate and run SETUP.EXE. The installation program will guide you through the installation process and install the ioAdmin utility. You can also install the MXIO DLL library or ioEventLog separately.
2. **Open ioAdmin:** After installation is finished, run **ioAdmin** from **Start → Program Files → Moxa → IO Server → Utility → ioAdmin**.
3. **Search the network for the server:** On the menu bar, select **System → Auto Scan Active Ethernet I/O Server**. In the dialog window that appears, click **Start Search** to begin searching for the ioLogik E2260.

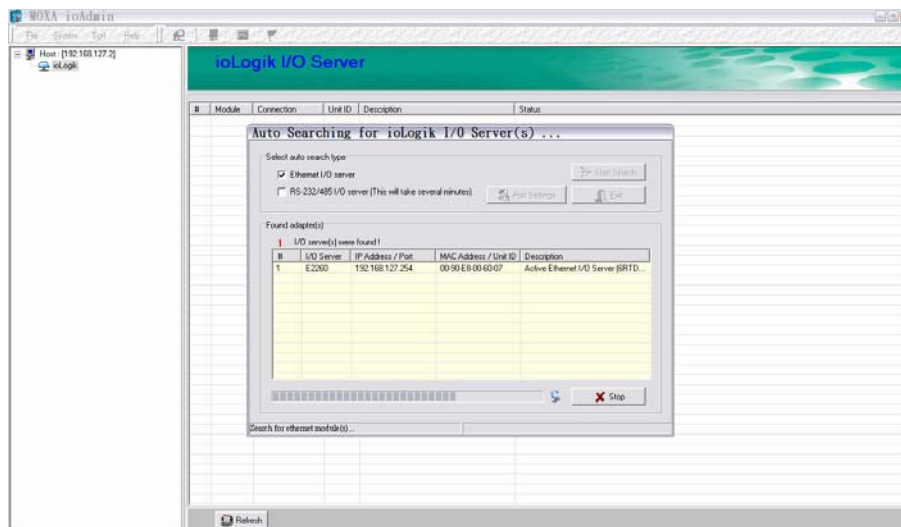

If ioAdmin is unable to find the ioLogik E2260, there may be a problem with your network settings.

When **multiple ioLogik E2000 units** are on the same network, remember that each unit has the same default IP address. You will need to assign a different IP address to each unit to avoid IP conflicts. ioAdmin automatically detects IP conflicts and gives you a chance to modify each unit's IP address in the "IP Address" columns. Click the "Set" button to reboot the corresponding unit with its new IP address. Click the "**Re-Search**" button to refresh the list of units found by ioAdmin.

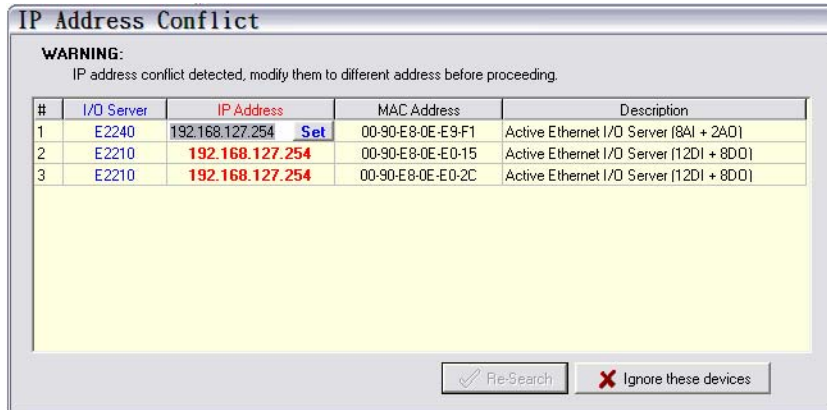

4. **Monitoring I/O status:** Once the ioLogik E2260 is found by ioAdmin, you may view the status of all I/O devices on ioAdmin's main screen.

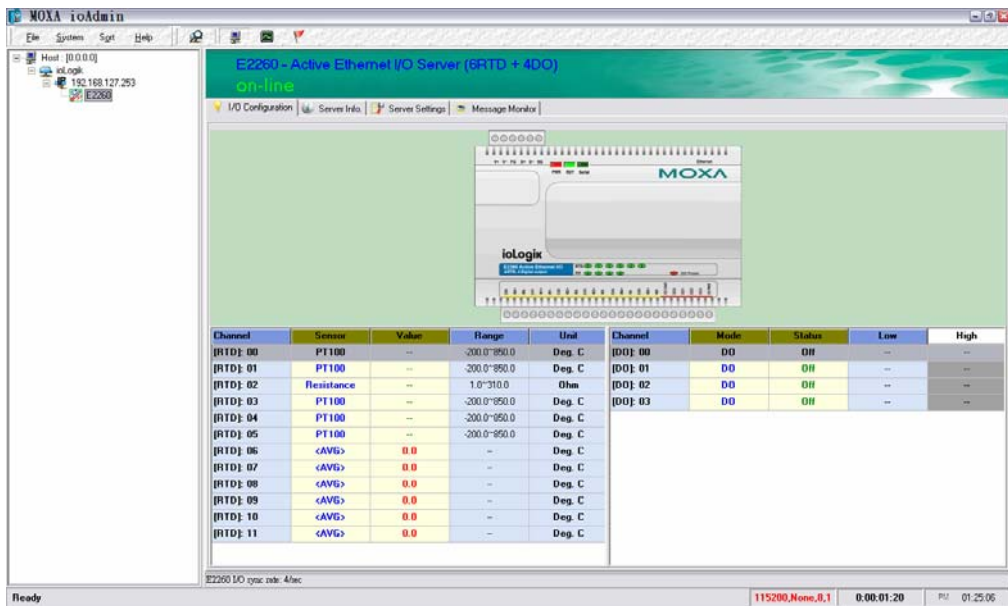

You may now use ioAdmin to set up or configure your ioLogik E2260.

This chapter goes over the functions available in ioAdmin, the ioLogik E2260's main configuration and management utility.

The following topics are covered:

- Introduction to ioAdmin**
- Features of ioAdmin**
- ioAdmin Main Screen**
 - Main Screen Overview
 - Wiring Guide
- Menu Items**
 - File
 - System
 - Sort
 - Help
 - Quick Links
- Main Window**
 - I/O Configuration Tab (General)
 - Server Info Tab
 - Server Settings Tab (General)
 - Message Monitor Tab
- ioAdmin Administrator Functions**
 - I/O Configuration Tab (Administrator)
 - Server Settings Tab (Administrator)
 - Network Tab
 - Firmware Update Tab
 - Watchdog Tab
 - Click&Go Logic Tab
- Server Context Menu**
- Using TFTP to Import/Export Configuration**
- Using ioEventLog**

Introduction to ioAdmin

The ioLogik I/O server may be managed and configured over the Ethernet by ioAdmin, a Windows utility provided with your ioLogik E2260. ioAdmin's graphical user interface gives you easy access to all status information and settings.

The ioLogik E2260 also supports configuration by web console and by optional LCM, but full configuration and management is only available through ioAdmin.

A new feature in ioAdmin automatically detects IP conflicts between ioLogik E2000 units. If ioAdmin detects an IP conflict, a window will appear that allows you to resolve the IP conflict immediately and restart each unit.

ioAdmin also includes Click&Go Logic control for the configuration of your Active Ethernet I/O system.

ioAdmin consists of following software:

- **ioAdmin with Click&Go Logic**
- **ioLogik 2000 Wiring Guide**
- **ioLogik 4000 Wiring Guide**

Features of ioAdmin

Remote Management

Over the Ethernet network, ioAdmin allows users to

- find and configure multiple ioLogik servers
- monitor and configure attached I/O devices
- test I/O devices
- reset the server

On-line Wiring Guide

An on-line wiring guide can be opened from within ioAdmin for your convenience. The easily accessible wiring guide can save administrators much time while planning or troubleshooting.

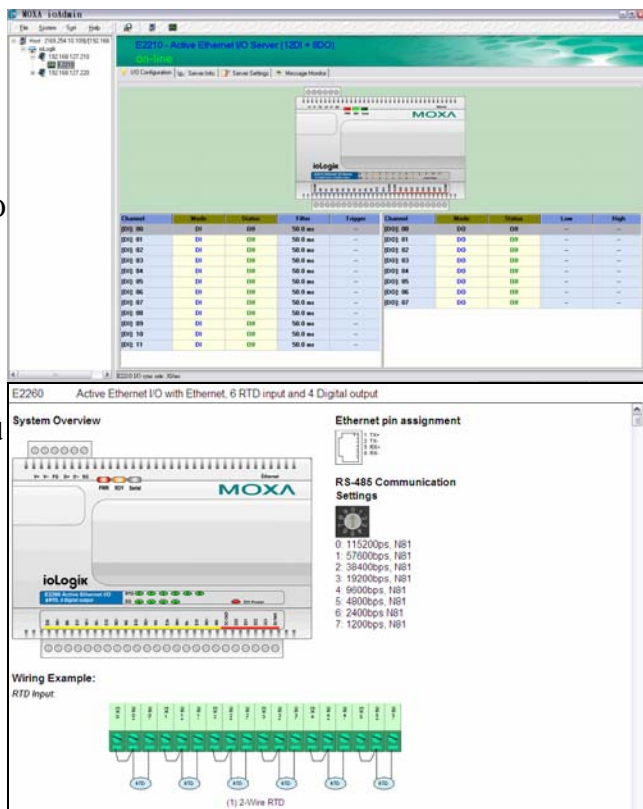

Configuration File

ioAdmin allows the entire configuration of the ioLogik E2260 to be saved as a file. The file is viewable as text and can serve three purposes:

- as a record or backup of configuration
- as a template for the configuration of other servers
- as a quick reference guide for you to configure Modbus drivers in a SCADA system

The file includes the following information:

1. file name, date, and time
2. model information
3. Modbus addresses

Server Management List

ioAdmin can import and export a list of ioLogik servers that are being managed. This file can make it easier to manage all devices on the network, and includes the following information:

1. Server Name
2. Module Type
3. IP Address
4. Unit ID

```
ioLogik E2260 Network I/O Server Configuration
=====
Date: 2007/10/30
Time: 16:33:38
Firmware: 01.0 Build07103011
[1. Model]
-----
MOD_TYPE=E2260 - Active Ethernet I/O Server (6RTD + 4DO)
MOD_LDC=
MOD_NAME=

[2. I/O Configurations]
-----
RTD00=0,(C) ,Sensor Type=1,(PT 100) ,Enable=1
RTD01=0,(C) ,Sensor Type=1,(PT 100) ,Enable=1
RTD02=2,(Ω) ,Sensor Type=14,(Resistance) ,Enable=1
RTD03=0,(C) ,Sensor Type=1,(PT 100) ,Enable=1
RTD04=0,(C) ,Sensor Type=1,(PT 100) ,Enable=1
RTD05=0,(C) ,Sensor Type=1,(PT 100) ,Enable=1
RTD06=0,(C) ,Sensor Type=20,(AVG) ,Enable=1 ,Formula=0
RTD07=0,(C) ,Sensor Type=20,(AVG) ,Enable=1 ,Formula=0
RTD08=0,(C) ,Sensor Type=20,(AVG) ,Enable=1 ,Formula=0
RTD09=0,(C) ,Sensor Type=20,(AVG) ,Enable=1 ,Formula=0
RTD10=0,(C) ,Sensor Type=20,(AVG) ,Enable=1 ,Formula=0
RTD11=0,(C) ,Sensor Type=20,(AVG) ,Enable=1 ,Formula=0

DO00=0,(DO) , DO00_PWN=0,(OFF) , DO00_SAFE=0,(OFF)
DO01=0,(DO) , DO01_PWN=0,(OFF) , DO01_SAFE=0,(OFF)
DO02=0,(DO) , DO02_PWN=0,(OFF) , DO02_SAFE=0,(OFF)
DO03=0,(DO) , DO03_PWN=0,(OFF) , DO03_SAFE=0,(OFF)

[3. Modbus address table]
-----
CHANNEL I/O TYPE MODBUS REFERENCE MODBUS ADDRESS (Dec, Hex)
RTD00 Input 30001 , 0x0000
RTD01 Input 30002 , 0x0001
RTD02 Input 30003 , 0x0002
RTD03 Input 30004 , 0x0003
```

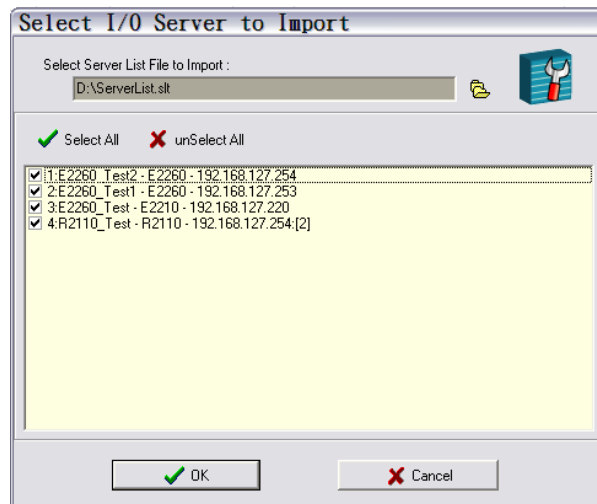

ioAdmin Main Screen

Main Screen Overview

This is ioAdmin's main screen. The main window defaults to the I/O Configuration tab, which displays a figure of the ioLogik E2260 and the status of every I/O channel below it. The other tabs in the main window take you to server and network settings, and further functions are available when you log on as an administrator. Note that configuration options are not available until you log on as an administrator.

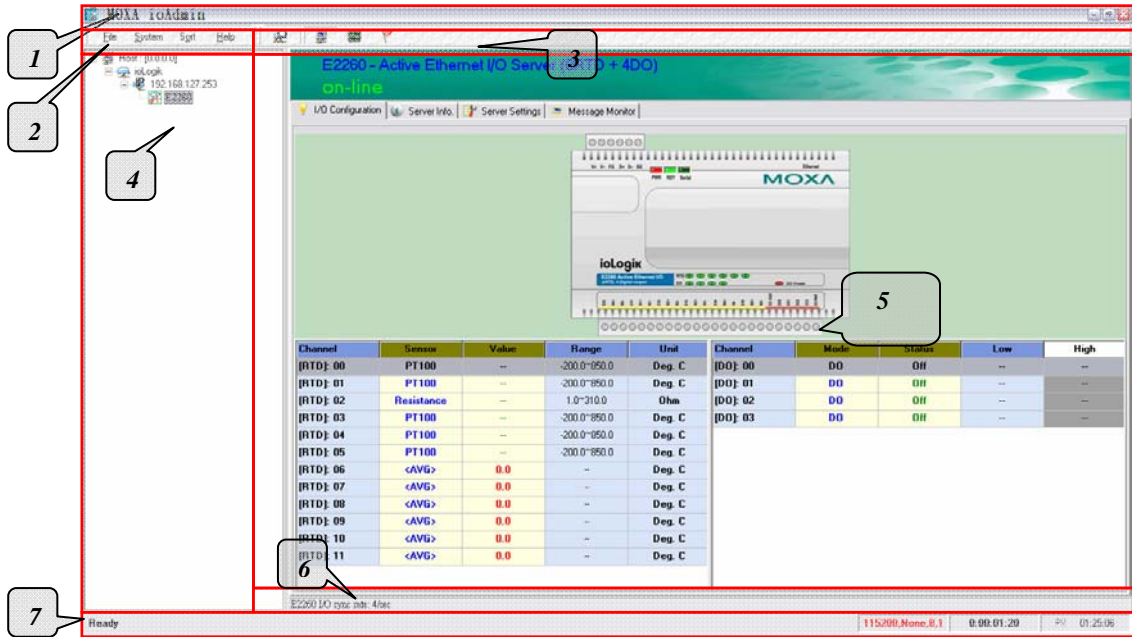

ioAdmin Main Screen	
1.	Title
2.	Menu bar
3.	Quick link
4.	Navigation panel
5.	Main window
6.	Sync. rate status
7.	Status bar

Wiring Guide

ioAdmin provides a wiring guide to the ioLogik E2260. You may access the wiring guide by right-clicking the figure of the ioLogik E2260 in the I/O Configuration tab. Select “Wiring Guide” in the submenu to open a help file showing the wiring information and electrical characteristics of the ioLogik E2260.

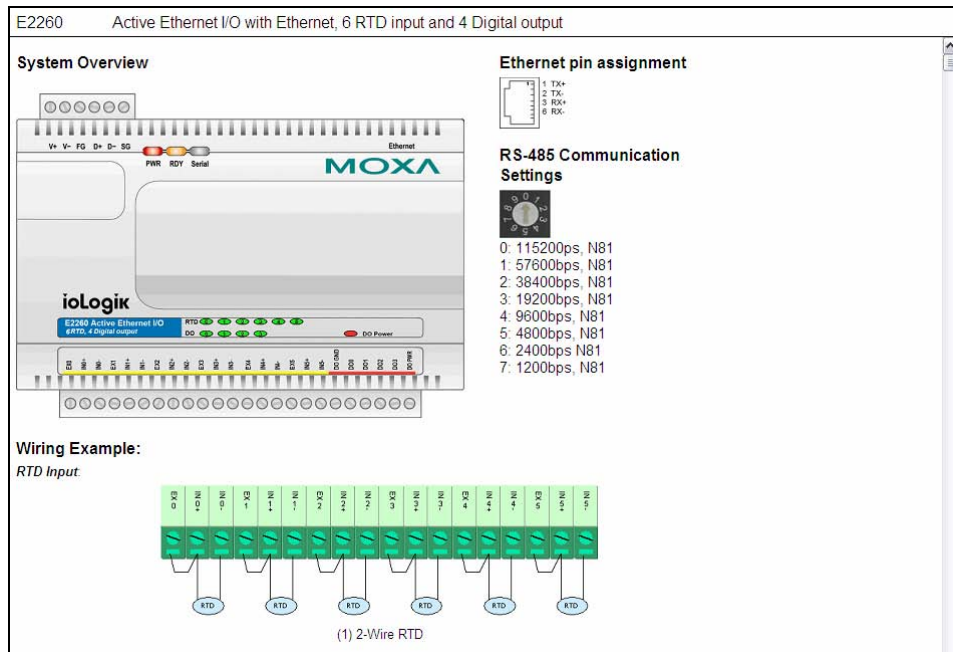

Menu Items

File

From the File menu, you can export the list of I/O servers that are currently displayed in the navigation panel. You also can import a list of I/O servers into ioAdmin.

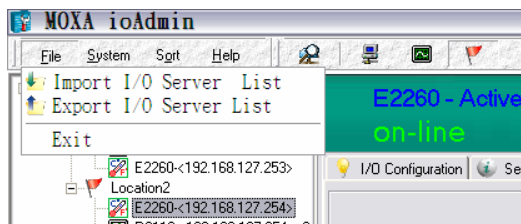

When importing a server list, you will be prompted to select which servers on the list need to be imported.

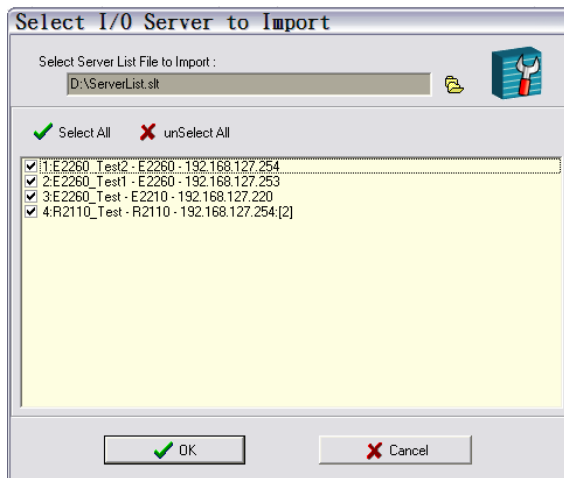

The file will have a .SLT extension and can be opened as a text file. The server list will provide the following information for each server:

1. Server Name
2. Module Type
3. IP Address
4. Unit ID

System

Several operations are possible from the System menu.

Auto Scan Active Ethernet I/O Server will search for ioLogik servers on the network. When connecting for the first time or recovering from a network disconnection, you can use this command to find I/O servers that are on the network.

Network Interface allows you to select a network to use, if the PC has multiple network adapters installed.

I/O Status Refresh Rate is used to adjust how often the I/O server is polled for device status. The current rate is displayed on the status bar at the bottom of the window. Note that higher sync rates result in higher loads on the network.

TCP Socket Timeout Interval allows you to select the preferred timeout value for TCP socket communication.

COM Port Setting is used to set the parameters for Modbus communication, such as baudrate, data bits, and timeout interval. For most applications, this will involve connecting to ioLogik R-Series devices.

Active Message Listen Port specifies the port number to use for Active Ethernet I/O messages. If your network uses a firewall, you can coordinate this setting with your firewall settings to ensure that active messages get through.

Reset NA4010 Network Adapter IP is used to re-assign an IP address to the NA-4010 network adapter, for ioLogik 4000 systems.

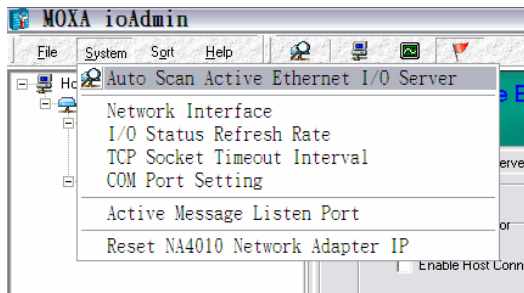

Sort

The Sort menu allows the server list in the navigation panel to be sorted by connection, type, and location.

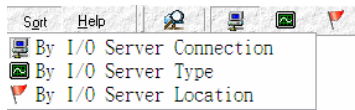

Help

In the Help menu, you can view wiring guides and information about ioAdmin.

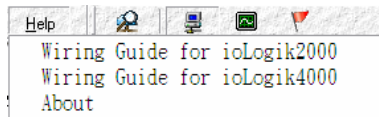



Quick Links

Quick links are provided to search for I/O servers on the network and sort the server list.



 Search network for I/O servers

 Sort by connection

 Sort by I/O server type

 Sort by location

Main Window

I/O Configuration Tab (General)

The I/O Configuration tab shows the status of every I/O channel. This is the default tab when you first open ioAdmin.

Channel	Sensor	Value	Range	Unit	Channel	Mode	Status	Low	High
[RTD]: 00	PT100	24.9	-200.0~850.0	Deg. C	[DO]: 00	DO	Off	--	--
[RTD]: 01	--	--	--	--	[DO]: 01	DO	Off	--	--
[RTD]: 02	--	--	--	--	[DO]: 02	DO	Off	--	--
[RTD]: 03	--	--	--	--	[DO]: 03	DO	Off	--	--
[RTD]: 04	--	--	--	--					
[RTD]: 05	--	--	--	--					
[RTD]: 06	<AVG>	0.0	--	Deg. C					
[RTD]: 07	<AVG>	0.0	--	Deg. C					
[RTD]: 08	<AVG>	0.0	--	Deg. C					
[RTD]: 09	<AVG>	0.0	--	Deg. C					
[RTD]: 10	<AVG>	0.0	--	Deg. C					
[RTD]: 11	<AVG>	0.0	--	Deg. C					

Server Info Tab

Server information, such as firmware revision, is displayed in the Server Info tab.

Address	Value/Status	Access	Description
34097	0x1393	Read	Vendor ID
34098	0x0001	Read	Unit ID for MODBUS/RTU
34100	Moxa Technologies Inc.,	Read	Vendor Name
34101	E2260 Active Ethernet I/O Server	Read	Product Name
34103	V1.0	Read	Firmware Version
34104	Build07092114 (09/21/2007)	Read	Firmware Release Date
34105	3	Read	Number of TCP connection
34106	0x0100	Read	Ethernet Interface Speed, 10/100
34107	00-90-E8-00-60-07	Read	MAC Address
34108	1	Read	LCM Detection
34109	V1.0	Read	LCM Firmware Revision
34110	Build06030112 (03/01/2006)	Read	LCM Firmware Release Date
34111	1172	Read	System Elapsed Time (in sec)
44097	192.168.127.254	Read/Write	IP Address
44098	255.255.255.0	Read/Write	Subnet Mask
44099	0.0.0.0	Read/Write	Gateway
44100	60	Read/Write	Modbus/TCP Alive Check Timeout
44101	0003 0040 0004 0028 0009 2007	Read/Write	System Local Time
44102	23	Read/Write	System Time Zone
44104	255.255.255.255	Read/Write	DNS1 Server Address
44105	255.255.255.255	Read/Write	DNS2 Server Address
44106	1	Read/Write	Enable/Disable Web Access
44111	0	Read/Write	Timeout for Communication Watchdog

Server Settings Tab (General)

The Server Settings tab is where you log in as an administrator. This is required in order to gain access to the ioLogik E2260 configuration options. If no administrator password has been set up, simply click **Login** and leave the **Password for entry** field blank. Please refer to the ioAdmin Administrator Functions section later on in this chapter for more detail.

The screenshot shows the 'Server Settings' tab in the ioLogik E2260 web interface. The interface is divided into several sections:

- Password for entry:** A text input field followed by 'Login' and 'Logout' buttons.
- Management Settings:**
 - Change Password (8 char max.):** A text input field.
 - Reconfirm Password:** A text input field with an 'Update' button.
 - Server Name:** A text input field with 'E2260_Test2' and an 'Update' button.
 - Server Location:** A text input field with 'Location2' and an 'Update' button.
- Time Settings:**
 - Local:** A text input field.
 - Date:** A date picker showing '2007/9/28'.
 - Time:** A time picker showing '4:34:9'.
 - Time Zone:** A dropdown menu showing '(GMT)Greenwich Mean Time: Dut'.
 - Time Server:** A text input field with an 'Update' button.
- System Log:**
 - Server Address:** A text input field with '192.168.127.2'.
 - Port:** A dropdown menu with '4040' and an 'Update' button.
- Refresh:** A button at the bottom center.

Message Monitor Tab

The Message Monitor tab will display any TCP/UDP I/O messages received from the ioLogik E2260. When you install the ioLogik E2260 for the first time, the Click&Go ruleset will not have been defined yet, so no messages will be displayed. Please refer to Chapter 5 for information on using Click&Go. Once a ruleset has been defined and activated, any TCP/UDP messages sent from the ioLogik E2260 will be displayed in the Message Monitor tab.

The screenshot shows the 'Message Monitor' tab in the ioLogik E2260 web interface. The interface is mostly empty, with a large white area for displaying messages. At the bottom, there are three buttons: 'Copy', 'Clear', and a checkbox labeled 'Toggle HEX'.

Messages can be displayed in ASCII or in HEX. To display messages in HEX, make sure that "Toggle HEX" is checked.

ioAdmin Administrator Functions

For full access to all configuration options, log in as an administrator in the Server Settings tab. This is required whenever you start up ioAdmin or boot up/restart the ioLogik E2260. When you install the ioLogik E2260 for the first time, the password will be blank and you may simply click **Login**. Additional functions will available after logging in, including the following new tabs:

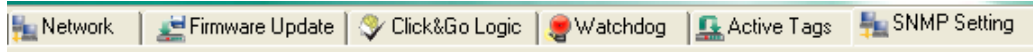

When making configuration changes, you will need to click **Update** or **Apply** to save the changes. Some changes will require a restart of the ioLogik E2260 in order to take effect, and you will be given the option to restart the computer if necessary.

ATTENTION



You **MUST** log in to access any administrator function, including Network, Communication Watchdog Timer, and Firmware Update tabs. If you forget the password, you may hold down the ioLogik's reset button to clear the password and load factory defaults. **This will result in the loss of all configuration settings and your Click&Go Logic ruleset!**

I/O Configuration Tab (Administrator)

When logged on as an administrator, you may double click on a channel in the I/O Configuration tab to configure that channel's settings. A window will open with configuration options for that channel. Settings made in this window can be copied to all I/O channels using the "Apply to all channels" option. Options for Power On Settings and Safe Status Settings are also available.

Configuring RTD Input Channels

The ioLogik E2260 provides 6 fixed physical RTD input (Resistance Temperature Detector) channels, each supporting up to 18 different types including PT50, PT100, JPT100, and more. The RTD channels are numbered from channel 0 to channel 5. Channels 6 through 11 are virtual temperature channels that report running averages or deviations of selected RTD channels.

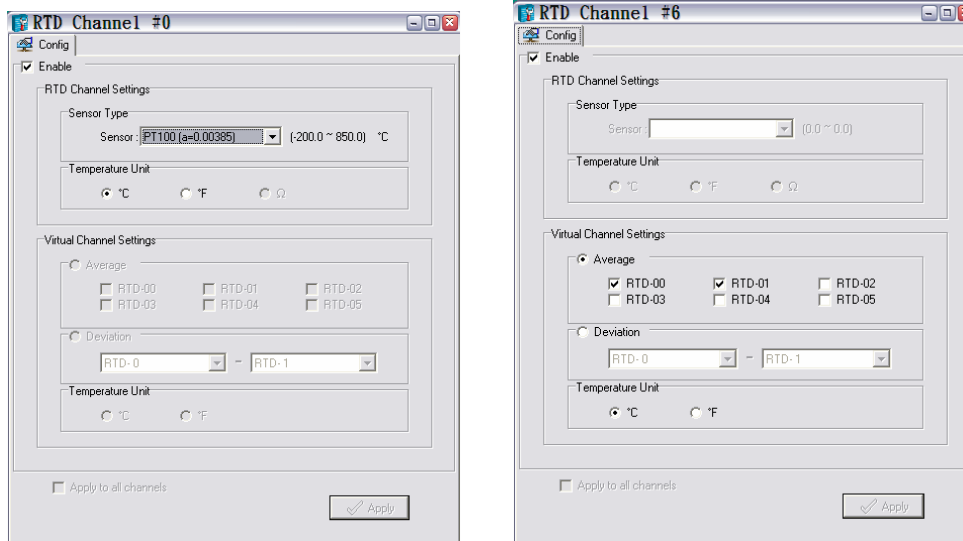

Alias Name

Click the **Alias Name** tab to customize the channel name. You may use names with up to 16 characters. If you have already set the Alias Name on the I/O Configuration page, the channel name will appear in Click&Go, Active message, and Web.

The following table is a list of supported sensor types and ranges.

Sensor Type	Degree	Degree	Count
Res. 100 mΩ	1 to 2200 Ω	1 to 2200 Ω	10 to 22000
Res. 50 mΩ	1 to 1250 Ω	1 to 1250 Ω	20 to 25000
Res. 20 mΩ	1 to 620 Ω	1 to 620 Ω	50 to 31000
Res. 10 mΩ	1 to 310 Ω	1 to 310 Ω	100 to 31000
PT50, 0.00385	-200 to 850°C	-328 to 1562°F	-2000 to 8500
PT100, 0.00385	-200 to 850°C	-328 to 1562°F	-2000 to 8500
PT200, 0.00385	-200 to 850°C	-328 to 1562°F	-2000 to 8500
PT500, 0.00385	-200 to 850°C	-328 to 1562°F	-2000 to 8500
PT1000, 0.00385	-200 to 350°C	-328 to 662°F	-2000 to 3500
JPT100, 0.003916	-200 to 640°C	-328 to 1184°F	-2000 to 6400
JPT200, 0.003916	-200 to 640°C	-328 to 1184°F	-2000 to 6400
JPT500, 0.003916	-200 to 640°C	-328 to 1184°F	-2000 to 6400
JPT1000, 0.003916	-200 to 350°C	-328 to 662°F	-2000 to 3500
Ni100, 0.00618	-60 to 250°C	-76 to 482°F	-600 to 2500
Ni200, 0.00618	-60 to 250°C	-76 to 482°F	-600 to 2500
Ni500, 0.00618	-60 to 250°C	-76 to 482°F	-600 to 2500
Ni1000, 0.00618	-60 to 180°C	-76 to 356°F	-600 to 1800
Ni120, 0.00672	-80 to 260°C	-112 to 500°F	-800 to 2600

The status of attached sensors will be reported by the count value, which corresponds to the sensor ranges shown above. For example, for a 100 mΩ resistor, a count value of 10 corresponds to a 1 Ω reading. Moxa can only guarantee accuracy within the ranges shown above. Be sure to verify the sensor type. Accurate readings beyond these ranges cannot be guaranteed.

Virtual Channels

The ioLogik E2260 provides virtual channels so you can easily determine the average or deviation values for any attached temperature sensor. A virtual channel can operate in Average Mode or Deviation Mode. In Average Mode, up to 6 physical channels are selected and the virtual channel reports the average value of the selected channels. In Deviation mode, two physical channels are selected and the virtual channel reports the difference between the channels.

When using virtual channels, if there are errors on any of the selected physical channels, that channel's readings will simply be ignored. You can refer to the LED indicators to see if any errors are encountered with any of the physical channels.

Note that virtual channels only support temperature units and cannot be used with resistance units. Any channel that is connected to a resistance sensor will be treated as an error channel.

Configuring Digital Output Channels

The ioLogik E2260 is equipped with 4 digital output channels that can be set individually to “DO” or “Pulse Output” mode.

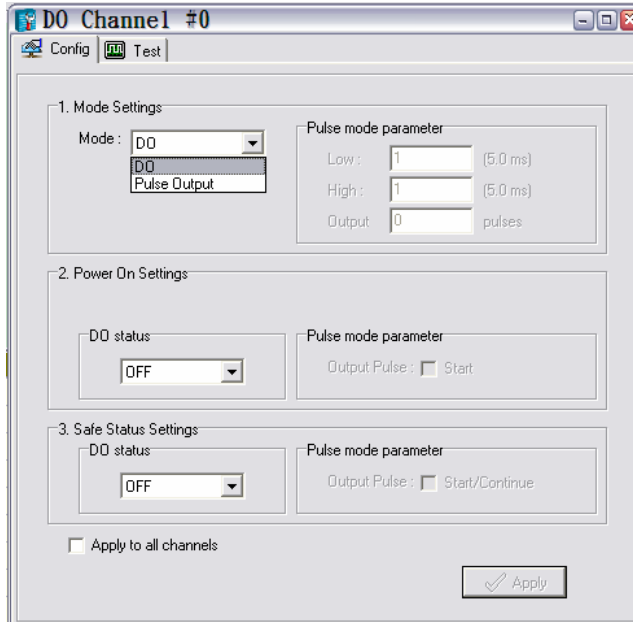

In DO mode, the specification is as follows.

Type	Logic 0 (OFF)	Logic 1 (ON)
DO mode	Open	Short

In Pulse Output mode, the selected digital output channel will generate a square wave as specified in the pulse mode parameters. The low and high level widths are entered in multiples of 5 ms, with a maximum setting of 4,294,967,295, or 248 days, 13 hours, 13 minutes, and 56 seconds. To set the low level width for 500 ms, you would enter 100 (because $100 \times 5 \text{ ms} = 500 \text{ ms}$). If the low width value is 500 and the high width value is 500, the pulse output would be a square wave with a 5-second pulse cycle. If continuous pulse output is desired, enter “0” for the number of pulses, otherwise enter the desired number of pulses between 1 and 4,294,967,295.

Power On Settings

Use this field to set the initial behavior of the DO channel when the ioLogik E2260 is powered on. You may configure whether or not the DO is set to OFF or ON at power up. For DO channels in Output Pulse mode, you may configure whether or not the pulse output commences at power up.

Safe Status Settings

Use this field to specify how the DO channel behaves when the network connection is lost. When the network connection is lost for the amount of time specified in the Host Connection Watchdog, each output channel will be reset to its Safe Status settings. Note that the Host Connection Watchdog is disabled by default. If the Host Connection Watchdog is disabled, the Safe Status settings will have no effect.

You can configure whether or not the DO is set to OFF or ON for Safe Status. For DO channels in Output Pulse mode, you can configure whether or not the output pulse commences or continues for Safe Status.

Test DO

You may test the DO channel by using ioAdmin.

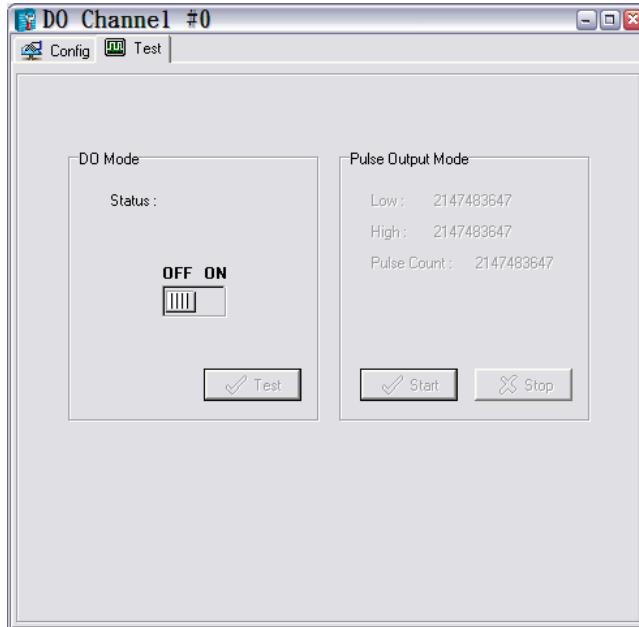

DO-DO: set the DO to “ON” or “OFF”

DO-Pulse: activate or stop pulse generation.

Server Settings Tab (Administrator)

You may set the password, server name, location, date, time, time zone, and time server in the Server Settings tab. ioAdmin supports long server names and a location description up to 58 characters.

Firmware Update	Click&Go Logic	Watchdog	Active Tags	SNMP Setting
I/O Configuration	Server Info.	Server Settings	Message Monitor	Network

Enter Password :

<p>Management Settings</p> <p>Change Password (8 char max.) : <input type="text"/></p> <p>Reconfirm Password : <input type="text"/> <input type="button" value="Update"/></p> <p>Server Name : <input type="text"/> <input type="button" value="Update"/></p> <p>Server Location : <input type="text"/> <input type="button" value="Update"/></p>	<p>Time Settings</p> <p>Local :</p> <p>Date : 2009 / 5 / 22</p> <p>Time : 6 : 57 : 41</p> <p>Time Zone : (GMT)Greenwich Mean Time: Dut</p> <p>Time Server : <input type="text"/></p> <p> Daylight Saving <input type="button" value="Update"/></p>
--	---

<p>System Log</p> <p>Server Address : <input type="text"/> Port : 4040 <input type="button" value="Update"/></p>

You may set up the Daylight Saving schedule by clicking the “Daylight Saving” button. You may choose EU type, US type, or User defined type. User defined type allows you to define the days and offset hours.

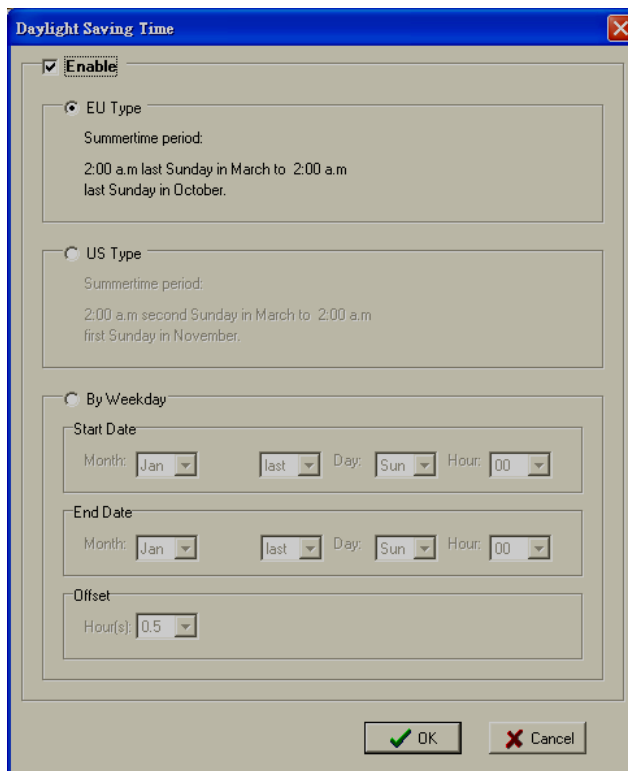

If you will be using ioEventLog to receive server status reports, such as for warm or cold starts, you need to specify the IP address and port number for the PC that will be running ioEventLog in the "System Log" field. The default port number is 4040. For additional information, please refer to the ioEventLog section later in this chapter.

Network Tab

The Network tab is where you configure IP settings, Modbus/TCP Alive Check Timeout settings, DNS settings, Serial settings, and Web Access settings for the ioLogik E2260.

The screenshot displays the configuration utility for the ioLogik E2260. At the top, it indicates 'Number of Modbus/TCP connection(s): 2'. The interface is divided into several sections:

- IP Settings:** Includes a dropdown for 'IP Configuration' (set to 'Static'), text boxes for 'IP Address' (192.168.127.254), 'Subnet Mask' (255.255.255.0), and 'Gateway' (0.0.0.0). The 'MAC' is displayed as 00-90-E8-14-05-19. There is an 'Accessible IP' icon and an 'Update' button.
- Serial Settings:** Shows 'Unit ID' (1), 'Baud Rate' (115200), 'Data Bits' (8), 'Stop Bits' (1), 'Parity' (None), and 'Timeout (ms)' (2500). An 'Update' button is present.
- Modbus/TCP Alive Check Timeout:** Features a checked checkbox for 'Enable Modbus/TCP idle connection timeout interval' and a spinner box set to '60' seconds. An 'Update' button is located below.
- Web Access Settings:** Includes a checked checkbox for 'Enable' and an 'Update' button.
- DNS Settings:** Contains two text boxes for 'DNS #1' and 'DNS #2', both set to 255.255.255.255. An 'Update' button is at the bottom.

A 'Refresh' button with a circular arrow icon is located at the bottom right of the utility window.

IP Settings: You can assign a static or dynamic IP address to the ioLogik E2260, as well as the subnet mask and gateway address. The Accessible IP screen can be used to control network access to the ioLogik E2260 and attached sensors. The ioLogik will reject all requests that do not originate from sources listed in the accessible IP list. Leave this list blank in order to allow requests from any IP address.

Modbus/TCP Alive Check Timeout: The Modbus/TCP Alive Check Timeout is designed to avoid TCP connection failure. When the host is down, the ioLogik E2260 will continue to wait for a response from the host. This will cause the TCP port to be indefinitely occupied by the host. When the Modbus/TCP idle connection timeout interval is enabled, the ioLogik E2260 will close the TCP connection automatically if there is no TCP activity for the specified time. Please note that Modbus/TCP connections will be blocked when setting up Accessible IP.

DNS Settings: Use this field to specify up to 2 DNS servers. These two DNS servers may be used to automatically find available e-mail addresses when using Click&Go Logic.

Serial Settings: You may view the reserved RS-485 communication parameters here, and you may set the timeout value for breaks in RS-485 communication. Note that the other serial communication parameters cannot be modified. If you wish to adjust the baudrate, you will need to use the physical dial on the back panel of the ioLogik E2260.

Web Access Settings: This field enables and disables the ioLogik E2260's web console. The web console allows the configuration of many settings using a web browser that is directed to the server's IP address. If the web console is not enabled in this field, you will not be able to access the web console.

Firmware Update Tab

The ioLogik E2260 supports remote firmware updates through the Firmware Update tab. Enter the path to the firmware file or click on the icon to browse for the file. Click **Update** to update the firmware. The wizard will lead you through the process until the server is restarted.

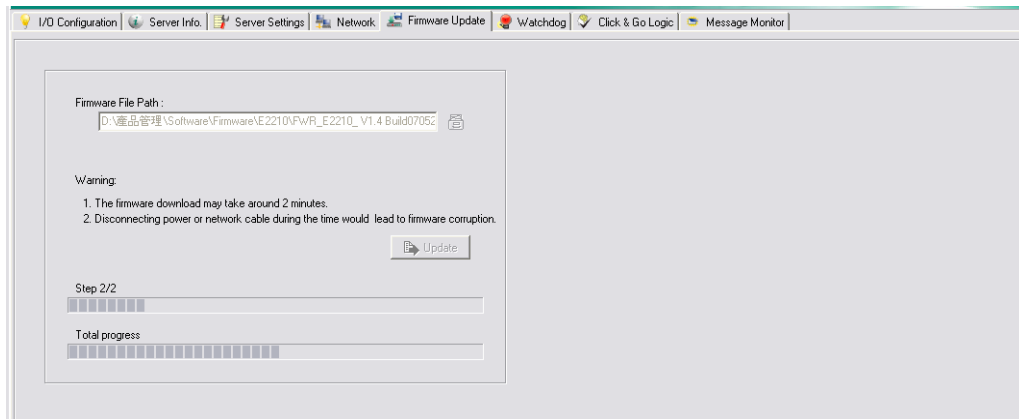

WARNING

Do not interrupt the firmware update process! An interruption in the process may result in your device becoming unrecoverable.

After the firmware is updated, the ioLogik will restart and you will have to log in again to access administrator functions.

The firmware on any attached I/O expansion module, such as an ioLogik R2000 server, must be updated over the RS-485 bus. Firmware on cascaded modules cannot be updated over Ethernet.

Watchdog Tab

The Watchdog tab is where you configure the Host Connection Watchdog, which is used with the Safe Status settings to define each DO channel's response to a lost network connection. When the Host Connection Watchdog is enabled, the ioLogik E2260 will respond to network disconnections that exceed the specified amount of time. The ioLogik will respond by resetting DO channels to their Safe Status settings. By default, the Watchdog is disabled. To enable the Watchdog, make sure **Enable Host Connection Watchdog** is checked, set the **Timeout value**, then click the **Update** button.

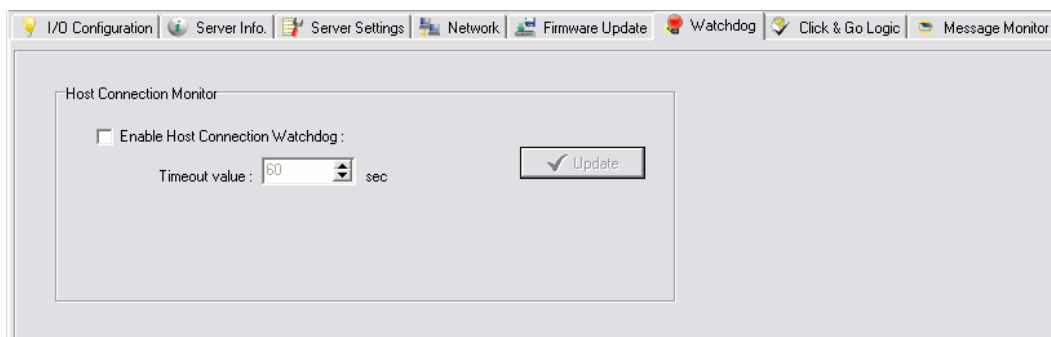

If the Watchdog is enabled and the network connection has been lost, you will need to return to the Watchdog Tab in order to resume normal operation. There will be a message saying “Host Connection Lost”, indicating that Safe Status settings have been activated. Click **Clear Alarm** to exit Safe Status and return to normal operation.

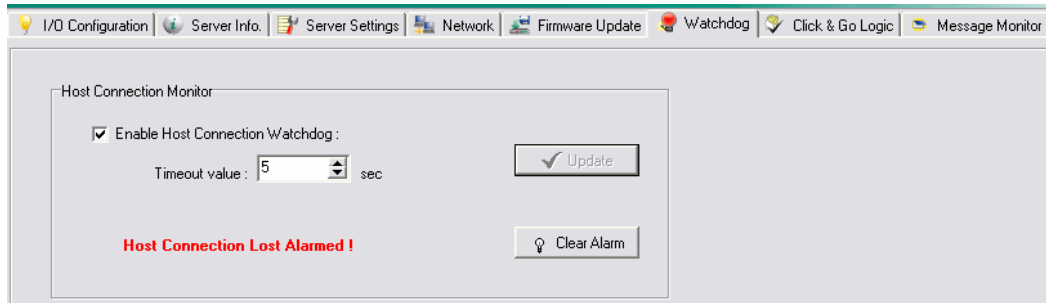

Click&Go Logic Tab

The Click&Go Logic tab is where Active Ethernet I/O operation is configured. While traditional Ethernet I/O involves an I/O server that reacts passively to polling requests from a network host, Active Ethernet I/O involves an I/O server that actively reports I/O data under user-specified conditions. Click&Go Logic is a powerful and easy-to-use tool to define the conditions for reporting I/O data. Please refer to Chapter 5 for more information.

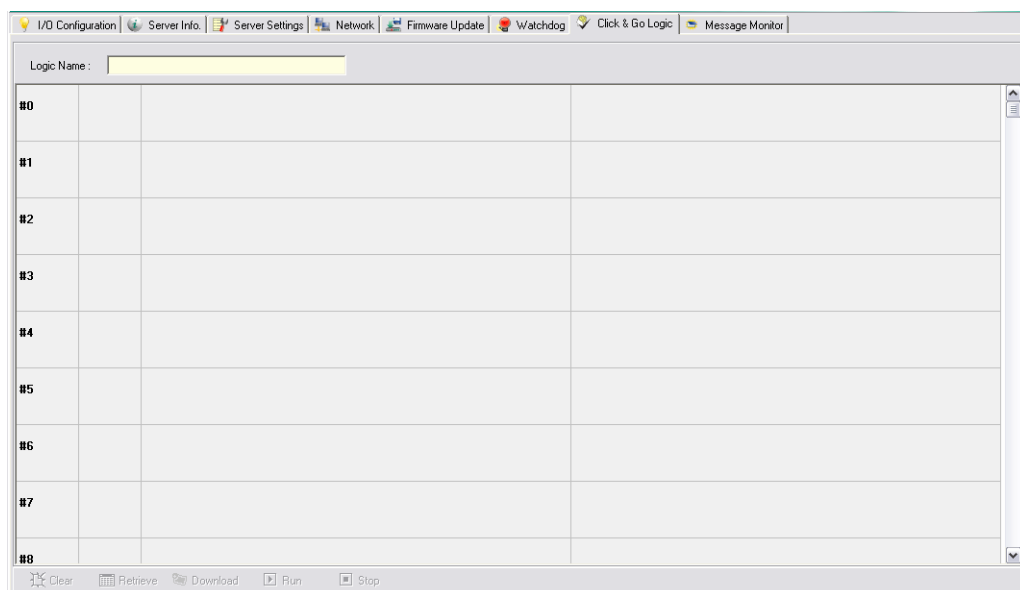

Changes made in the Click&Go Logic tab are not effective until the ioLogik E2260 is restarted, just like changes made in other tabs. Note that when an I/O channel is used in Click&Go Logic, its range and units become fixed and cannot be modified.

Active Tags Tab

When logged in as an administrator, fill in the IP address in the **Active Tags** tab to configure Active OPC Address and Port settings. ioLogik Active Ethernet I/O can support up to 5 IPs at the same time. The Active OPC Server Address can be filled in using the IP address. The default port number is 9900. The port number should be the same as the setting in Active OPC Server's "Active Tag Listen Port". After the OPC setting and Channel Tags have been configured as desired, click **Create Tags**. The ioLogik Active Ethernet I/O will reboot in order for the settings to take effect.

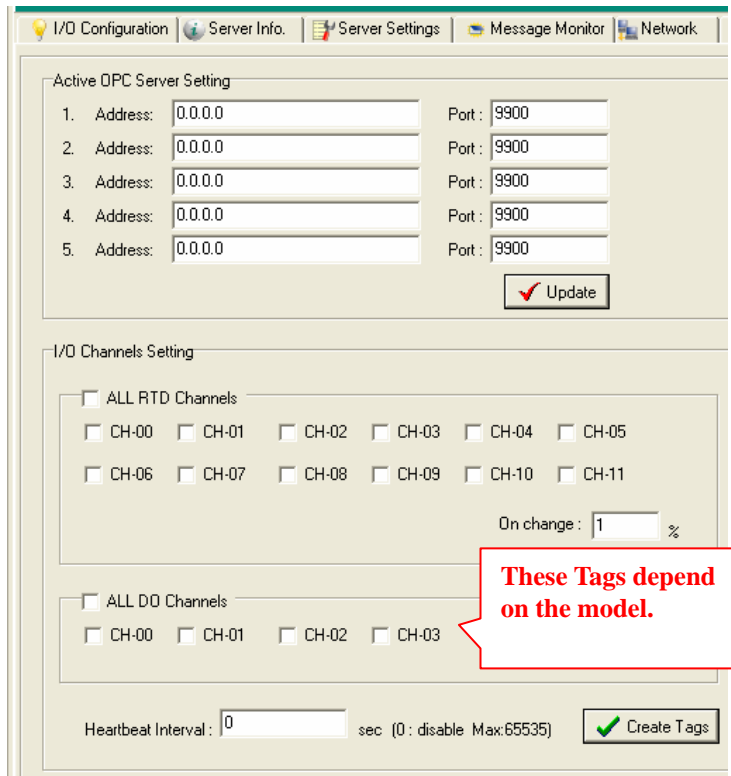

The Heartbeat Interval is the time between each instance Active OPC server is informed that ioLogik is still working. The tags for Analog Value, such as AI, AO, RTD, TC, are synchronized with pre-defined percentages that are filled in the **On Change** column. The updated DI/DO/Relay tags can be synchronized by changing the status. If counter mode is used, **Advanced Settings** allows you to synchronize time by 100 to 60,000 ms. Please refer to the Active OPC Server section for more details about how to use Active OPC server.

SNMP Settings Tab

The ioLogik Ethernet I/O supports SNMP V1, V2c, and V3 (Simple Network Management Protocol) to monitor network and I/O devices with SNMP Network Management software. It is useful in building automation and telecom applications. Use these fields to enable SNMP and set the read and write community strings for SNMP V1 and V2c, or use authentication for SNMP V3.

The screenshot shows the SNMP Settings Tab in the ioAdmin interface. It is divided into several sections:

- Enable SNMP:** A checked checkbox.
- Global Setting:**
 - Version: A dropdown menu with options V1, V2c, V3.
 - Contact: A text input field.
 - Location: A text input field.
- SNMP V1, V2c:**
 - Read Community: A text input field containing 'public'.
 - Write Community: A text input field containing 'private'.
- SNMP V3: Read only:**
 - User Name: A text input field.
 - Authentication Password: A text input field.
 - Authentication Protocol: A dropdown menu with 'DISABLE' selected.
 - Privacy Password: A text input field.
 - Privacy Protocol: A dropdown menu with 'DISABLE' selected.
- SNMP V3: Read/Write:**
 - User Name: A text input field.
 - Authentication Password: A text input field.
 - Authentication Protocol: A dropdown menu with 'DISABLE' selected.
 - Privacy Password: A text input field.
 - Privacy Protocol: A dropdown menu with 'DISABLE' selected.

At the bottom of the form, there are two buttons: 'Update' (with a checkmark icon) and 'Refresh' (with a circular arrow icon).

Server Context Menu

The Server context menu is accessed by right clicking on the server model name in the navigation panel.

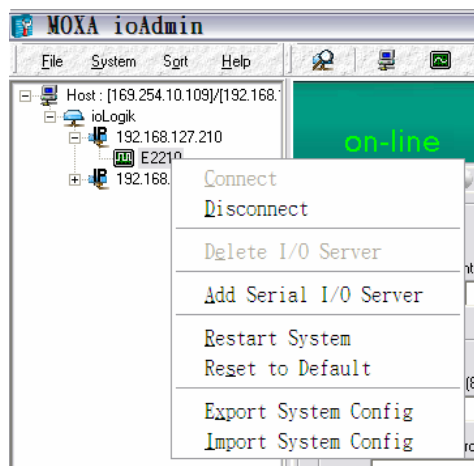

Connect

Select this command to have ioAdmin attempt a re-connection over the network to the selected ioLogik server.

Disconnect

Select this command to have ioAdmin drop the network connection with the selected ioLogik server.

Delete I/O Server

Select this command to have ioAdmin remove the selected server.

Add Serial I/O Server

Select this command to manually add a serial I/O server by using its Unit ID.

Restart System

Select this command to restart the selected ioLogik server. You will need to log in as an administrator to use this function.

Reset to Default

Select this command to reset all settings for the selected ioLogik server, including console password and IP address, to factory default values. You will need to log in as an administrator to use this function.

Export System Config

Select this command to export the configuration of the selected ioLogik server to a text file. You will need to log in as an administrator to use this function. It is strongly recommended you use this method to back up your configuration after you have finished configuring the ioLogik for your application.

The following is an example of the exported configuration file:

```
ioLogik E2260 Network I/O Server Configuration
=====
Date: 2007/10/30
Time: 16:33:38
Firmware: V1.0 Build07103011
[1. Model]
-----
MOD_TYPE=E2260 - Active Ethernet I/O Server (6RTD + 4DO)
MOD_LOC=
MOD_NAME=

[2. I/O Configurations]
-----
RTD00=0,(°C) ,Sensor Type=1,(PT 100) ,Enable=1
RTD01=0,(°C) ,Sensor Type=1,(PT 100) ,Enable=1
RTD02=2,(Ω) ,Sensor Type=14,(Resistance) ,Enable=1
RTD03=0,(°C) ,Sensor Type=1,(PT 100) ,Enable=1
RTD04=0,(°C) ,Sensor Type=1,(PT 100) ,Enable=1
RTD05=0,(°C) ,Sensor Type=1,(PT 100) ,Enable=1
RTD06=0,(°C) ,Sensor Type=20,(AUG) ,Enable=1 ,Formula=0
RTD07=0,(°C) ,Sensor Type=20,(AUG) ,Enable=1 ,Formula=0
RTD08=0,(°C) ,Sensor Type=20,(AUG) ,Enable=1 ,Formula=0
RTD09=0,(°C) ,Sensor Type=20,(AUG) ,Enable=1 ,Formula=0
RTD10=0,(°C) ,Sensor Type=20,(AUG) ,Enable=1 ,Formula=0
RTD11=0,(°C) ,Sensor Type=20,(AUG) ,Enable=1 ,Formula=0

DO00=0,(DO) ,          DO00_PWN=0,(Off) ,          DO00_SAFE=0,(Off)
DO01=0,(DO) ,          DO01_PWN=0,(Off) ,          DO01_SAFE=0,(Off)
DO02=0,(DO) ,          DO02_PWN=0,(Off) ,          DO02_SAFE=0,(Off)
DO03=0,(DO) ,          DO03_PWN=0,(Off) ,          DO03_SAFE=0,(Off)

[3. Modbus address table]
-----
CHANNEL      I/O TYPE      MODBUS REFERENCE      MODBUS ADDRESS (Dec, Hex)
RTD00        Input         30001                  , 0x0000
RTD01        Input         30002                  , 0x0001
RTD02        Input         30003                  , 0x0002
RTD03        Input         30004                  , 0x0003
```

Import System Config

Select this command to reload a configuration that was exported to a text file. You will need to log in as an administrator to use this function. You will need to restart the ioLogik server in order for the new configuration to take effect. This command may be used to restore a configuration after loading the factory defaults, or to duplicate a configuration to multiple ioLogik servers.

Using TFTP to Import/Export Configuration

TFTP (Trivial File Transfer Protocol) provides basic FTP functionality in a very simple protocol. Due to TFTP's simplicity, it can be implemented using a very small amount of memory, an important consideration when it was first developed. The ioLogik E2260 supports the use of TFTP to import or export configuration files.

The following is an example using Windows TFTP and an ioLogik E2260 with an IP address of 192.168.127.254:

1. Enter "TFTP 192.168.127.254 GET ik2260.txt" to get the ioLogik's configuration file.
2. Enter "TFTP 192.168.127.254 PUT ik2260.txt" to load a configuration file onto the ioLogik.

You must use "ik2260.txt" as the destination filename when copying a configuration file to the ioLogik E2260. Otherwise, you will receive an error message as shown below:

```
Error on server : ioServer - Fail to write file !!cess Protocol
pcmail-srv      158/tcp          #PCMail Server
snmp            161/udp          #SNMP
snmptrap        162/udp          #SNMP trap
print-srv       170/tcp          #Network PostScript
bgp             179/tcp          #Border Gateway Protocol
irc            194/tcp          #Internet Relay Chat Protocol
!
ipx            213/udp          #IPX over IP
ldap           389/tcp          #Lightweight Directory Access
s Protocol
https          443/tcp          MCom
https          443/udp          MCo
https          443/tcp          MCom
https          443/udp          MCo? █
```

You can use TFTP in a batch file to transfer configuration files for different units. For example, you might have two configuration files that need to be copied to two different servers: ik2260_1.txt for 192.168.127.253, and ik2260_2.txt for 192.168.127.254. A batch file could be written as follows:

```
tftp 192.168.127.253 put ik2260_1.txt ik2260.txt
```

```
tftp 192.168.127.254 put ik2260_2.txt ik2260.txt
```

**ATTENTION**

You can also run TFTP client software, open the configuration file, and enter the remote server's IP. Note that both ASCII and Octet mode are supported. When the download process is complete, the I/O server will reboot.

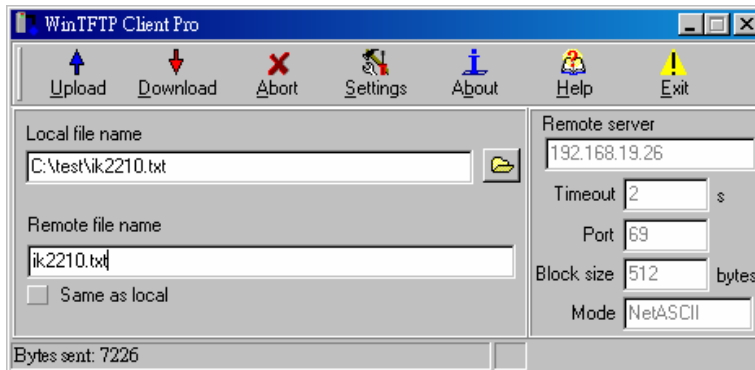

WinTFTP Client Pro is a trademark of WinTFTP. All rights reserved.

Using ioEventLog

Installing ioEventLog

ioEventLog is a Windows utility provided for the monitoring of the ioLogik E2260 and attached I/O devices. It may be used from anywhere on the network to monitor the ioLogik E2260.

1. **Installation from CD:** Insert the Document and Software CD into the host computer. Run SETUP.EXE, which is located in the root directory. The installation program will guide you through the installation process and install the ioEventLog utility.
2. **Open ioEventLog:** After installation is finished, run **ioEventLog** from **Start → Program Files → Moxa → IO Server → Utility → ioEventLog**.

Basic Functions

ioEventLog is installed along with ioAdmin from the Document and Software CD. It is designed to help you keep a record of ioLogik status events over the network. The log is stored on the Windows PC. You will need to set up your ioLogik server to send status events to the PC's IP address. The following events are monitored:

- cold start
- warm start

For each event, the following information is provided. The log can be sorted by any of these fields:

- Event type
- Event date and time
- ioLogik server source name
- Source IP
- Destination IP
- Host date and time

- Source model

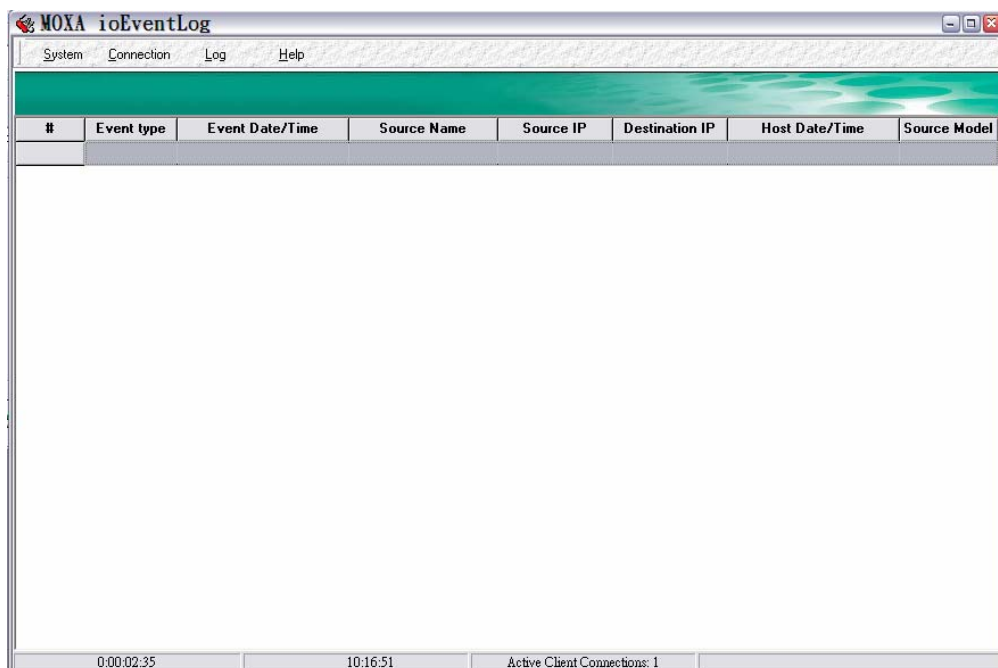

Configuration

In the System menu, select **Settings** to configure ioEventLog.

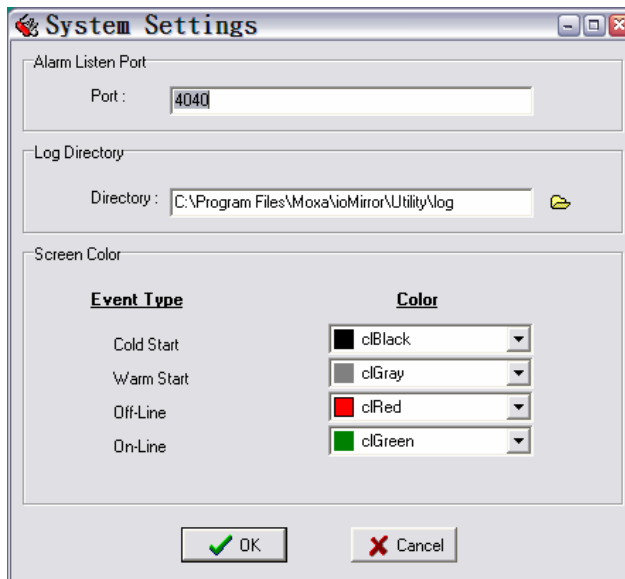

The **Alarm Listen Port** is the TCP port number that will be monitored for status events. You can modify this setting as necessary to receive signals through a firewall. It will need to match the settings for the ioLogik server that is being monitored.

The **Log Directory** is where the log files will be stored. The default directory is C:\Program Files\Moxa\ioMirror\log. A separate log file is created for each day, with file names assigned automatically.

You can also select the color of each event type in the log.

Checking Connected Devices

You can see which I/O servers are already connected to ioEventLog by selecting **Connected Device List** from the **Connection** menu. You will be prompted to view which devices are connected.



Opening Log Files

You can view previously saved logs by selecting **Open** from the Log menu. You will be prompted for the data that you wish to view.

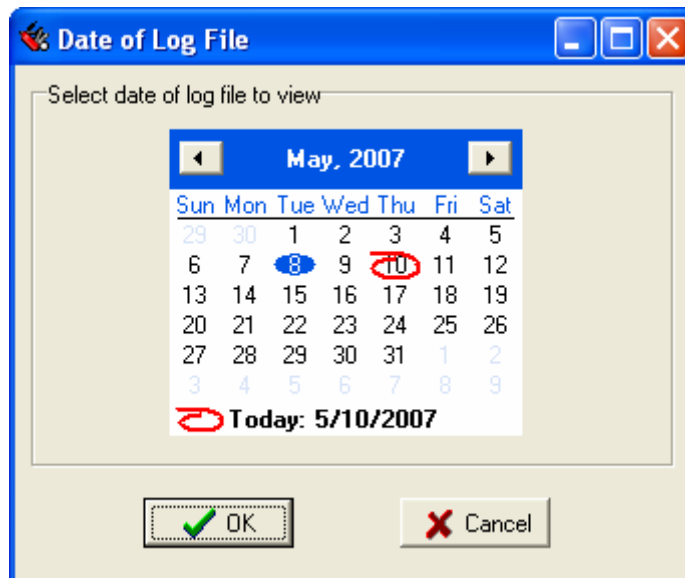

The logs for the day that you select will be displayed in the Alarm Log Viewer window.

Clearing the Log

If you wish to clear the log, you can select Clear from Log menu. This will clear all events for the current day. The cleared events will not be saved in that day's logs. After the logs are cleared, new events will be displayed and recorded as usual.

Using the Web Console

You may use the ioLogik E2260's built in web console to configure many options.

The following topics are covered:

- Introduction to the Web Console**
- Basic Settings**
- Network Settings**
 - General Settings
 - Ethernet Configuration
 - RS-485 Settings
- I/O Settings**
 - RTD Channels
 - DO Channels
- System Management**
 - Accessible IP Settings
 - SNMP Agent
 - Network Connection
 - Firmware Update
 - Import System Config
 - Export System Config
- LCM**
- Change Password**
- Load Factory Default**
- Save/Restart**

Introduction to the Web Console

The ioLogik E2260 web console is a browser-based configuration utility. When the ioLogik E2260 is connected to your network, you may enter the server's IP address in your web browser to access the web console. Note that although most configuration options are available in the web console, some settings are only available through ioAdmin. Furthermore, the web console can be disabled under Web Access Settings in ioAdmin. If you are unable to access the web console, check the Web Access Settings in ioAdmin.

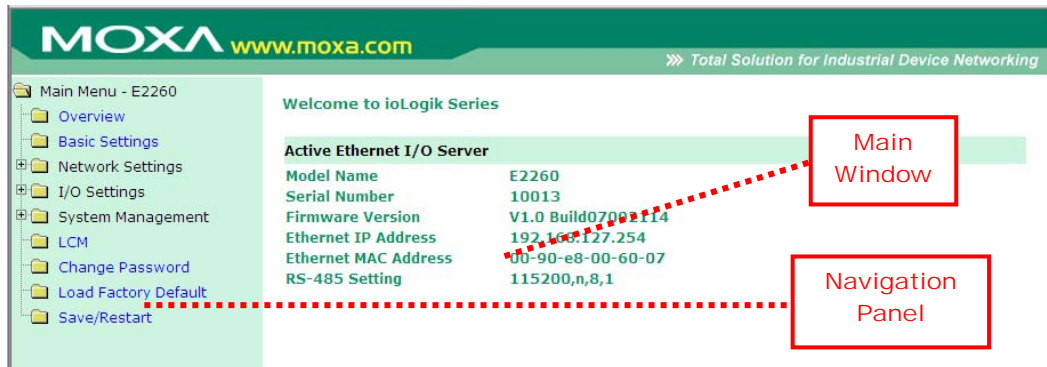

The left panel is the navigation panel and contains an expandable menu tree for navigating among the various settings and categories. When you click on a menu item in the navigation panel, the main window will display the corresponding options for that item. Configuration changes can then be made in the main window. For example, if you select Basic Settings in the navigation panel, the main window will show a page of basic settings that you can configure.

You must click the **Submit** button after making configuration changes. The Submit button will be located at the bottom of every page that has configurable settings. If you navigate to another page without clicking the Submit button, your changes will not be retained.

Submitted changes will not take effect until they are saved and the ioLogik E2260 is restarted! You may save and restart the server in one step by clicking the **Save/Restart** button after you submit a change. If you need to make several changes before restarting, you may save your changes without restarting by selecting Save/Restart in the navigation panel. If you restart the ioLogik E2260 without saving your configuration, the ioLogik E2260 will discard all submitted changes.

Basic Settings

On the Basic Settings page, you may set the ioLogik E2260's system time or provide the IP address of a time server for time synchronization.

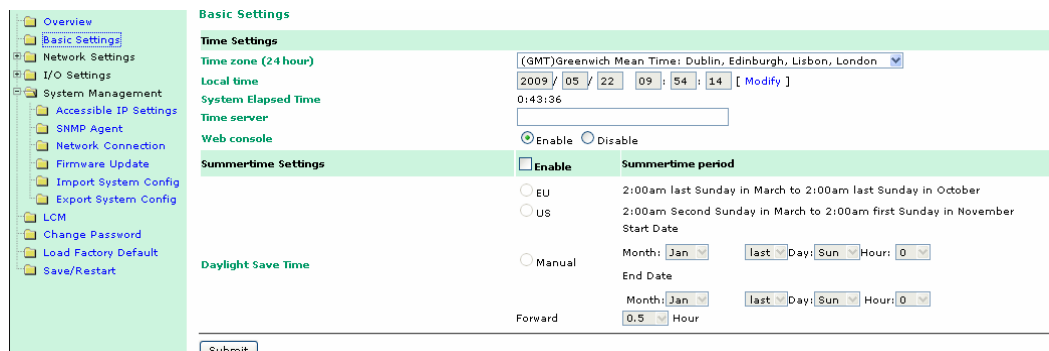

Network Settings

General Settings

On the General Settings page, you may assign a server name and location to assist you in differentiating between different I/O servers. You may also enable the Host Communication Watchdog and define the timeout value.

I/O Server Settings	
Server Name	E2260_Test2
Server Location	Location2
DNS Server 1	255.255.255.255
DNS Server 2	255.255.255.255
<input type="checkbox"/> Enable communication watchdog	0 sec

When enabled, the Host Connection Watchdog activates Safe Status settings for DO channels when the ioLogik E2260 loses its network connection for the specified amount of time. By default, the Watchdog is disabled. You may use ioAdmin to configure each DO channel's Safe Status setting.

To enable the Watchdog, make sure that **Enable connection watchdog** is checked, set the timeout value, and restart the server.

Ethernet Configuration

On the Ethernet Configuration page, you may set up a static or dynamic IP address for the ioLogik E2260, as well as the subnet mask and gateway address.

Ethernet Parameters	
IP Configuration	Static
IP Address	192.168.127.254
Subnet Mask	255.255.255.0
Gateway	0.0.0.0

RS-485 Settings

On the RS-485 Settings page, you may view the serial communication parameters, but no configuration changes are allowed. The baudrate may only be configured by the physical dial on the back of the ioLogik E2260. This is a reserved function.

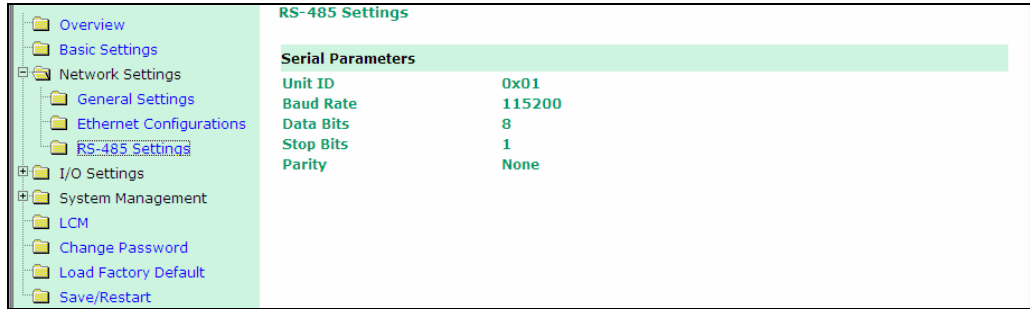

I/O Settings

RTD Channels

On the RTD Channels page, you may view the status of channels RTD-00 through RTD-11, which includes both physical and virtual channels.

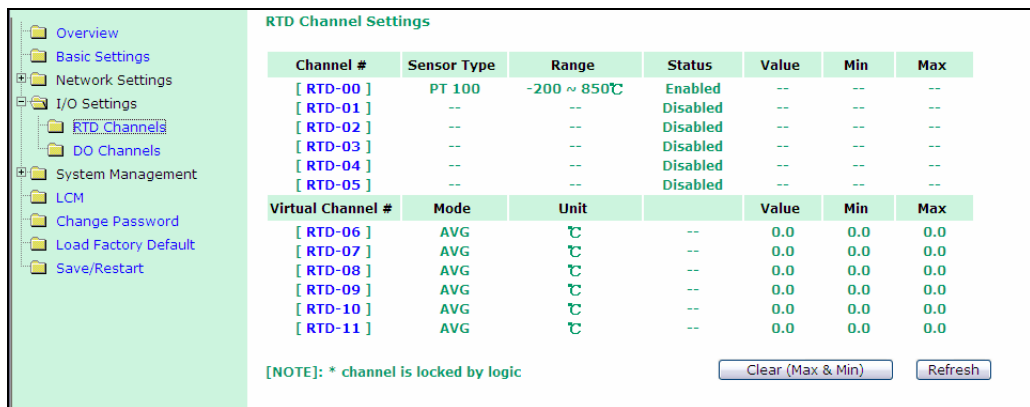

You may click on each channel to enable or disable it, or to configure the RTD input mode. When a channel has been disabled, the sample rate of the remaining channels will be increased automatically.

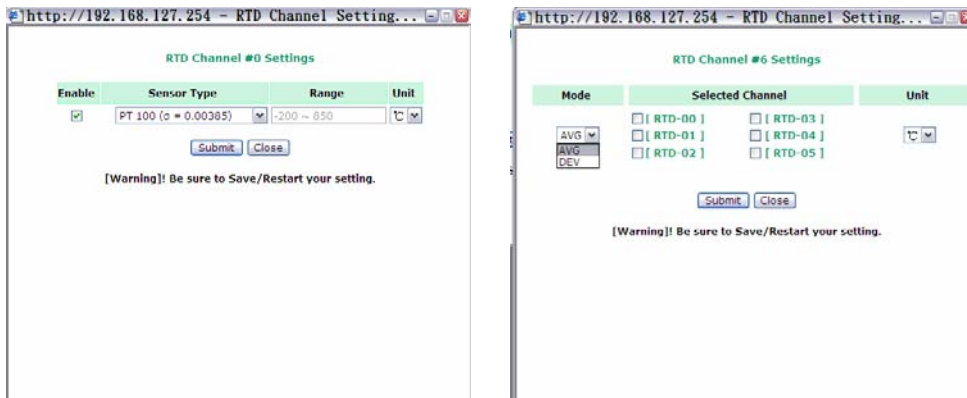

The following table is a list of supported sensor types and ranges.

Sensor Type	Degree	Count
PT50, 0.00385	-200 to 850°C	-2000 to 8500
PT100, 0.00385	-200 to 850°C	-2000 to 8500
PT200, 0.00385	-200 to 850°C	-2000 to 8500
PT500, 0.00385	-200 to 850°C	-2000 to 8500
PT1000, 0.00385	-200 to 350°C	-2000 to 3500
JPT100, 0.003916	-200 to 640°C	-2000 to 6400
JPT200, 0.003916	-200 to 640°C	-2000 to 6400
JPT500, 0.003916	-200 to 640°C	-2000 to 6400
JPT1000, 0.003916	-200 to 350°C	-2000 to 3500
Res. 100 mΩ	1 to 2200 Ω	10 to 22000
Res. 50 mΩ	1 to 1250 Ω	20 to 25000
Res. 20 mΩ	1 to 620 Ω	50 to 31000
Res. 10 mΩ	1 to 310 Ω	100 to 31000
Ni100, 0.00618	-60 to 250°C	-600 to 2500
Ni200, 0.00618	-60 to 250°C	-600 to 2500
Ni500, 0.00618	-60 to 250°C	-600 to 2500
Ni1000, 0.00618	-60 to 180°C	-600 to 1800
Ni120, 0.00672	-80 to 260°C	-800 to 2600

Channels 6 through 11 are virtual channels. You can click on a virtual channel to configure whether it will return current averages or deviations for the specified physical channels (RTD-00 through RTD-05).

DO Channels

On the DO Channels page, you may configure each DO (digital output) channel by clicking on the channel. DO Channels can operate in DO mode or Pulse Output mode. In DO mode, output is either on or off. In Pulse Output mode, a configurable square wave is generated.

DO Channel Settings					
DO Channel #	Mode	Status	Low Width	High Width	
[DO-00]	DO	Off	--	--	
[DO-01]	DO	Off	--	--	
[DO-02]	DO	Off	--	--	
[DO-03]	DO	Off	--	--	

[NOTE]: * channel is locked by logic

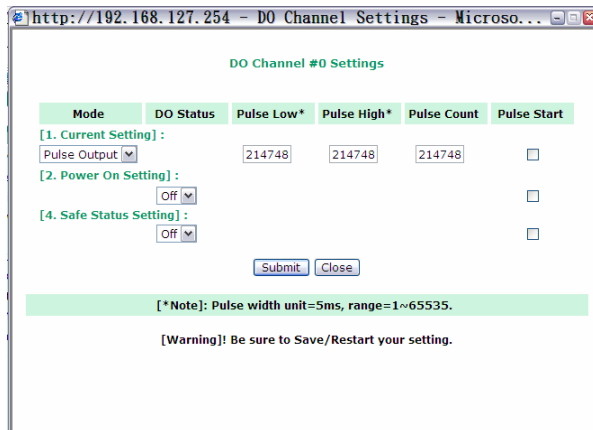

You may use the Power On Setting field to specify the channel's status when the ioLogik E2260 is powered on, and the Safe Status Setting field to specify the channel's status if the network is disconnected. Note that Safe Status is controlled by the Host Connection Watchdog, which is disabled by default. If the Host Connection Watchdog is disabled, the channels' Safe Status settings will have no effect.

System Management

Accessible IP Settings

On the Accessible IP Settings page, you may control network access to the ioLogik E2260. When the accessible IP list is enabled, a host's IP address must be listed in order to have access to the ioLogik E2260.

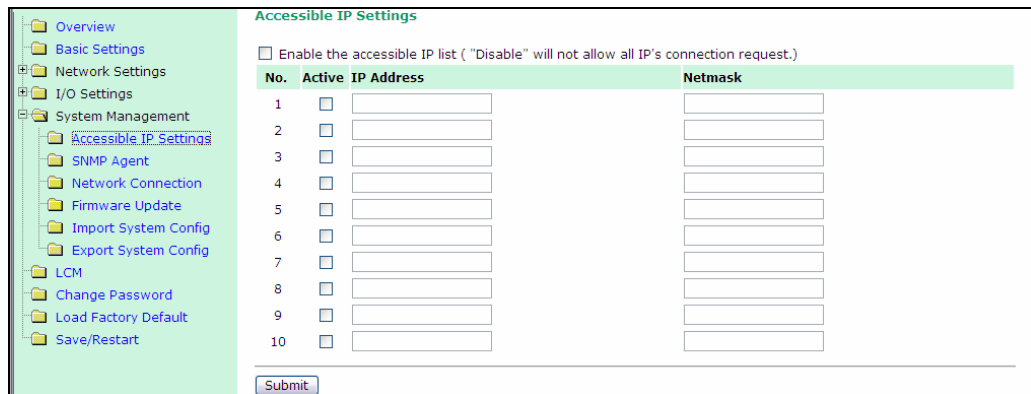

You may add a specific address or range of addresses by using a combination of IP address and netmask, as follows:

- To allow access to a specific IP address**
Enter the IP address in the corresponding field; enter **255.255.255.255** for the netmask.
- To allow access to hosts on a specific subnet**
For both the IP address and netmask, use 0 for the last digit (e.g., 192.168.1.0 and 255.255.255.0).
- To allow unrestricted access**
Deselect the Enable the accessible IP list option.

Refer to the following table for additional configuration examples.

Allowed Hosts	IP address/Netmask
Any host	Disable
192.168.1.120	192.168.1.120 / 255.255.255.255
192.168.1.1 to 192.168.1.254	192.168.1.0 / 255.255.255.0
192.168.0.1 to 192.168.255.254	192.168.0.0 / 255.255.0.0
192.168.1.1 to 192.168.1.126	192.168.1.0 / 255.255.255.128
192.168.1.129 to 192.168.1.254	192.168.1.128 / 255.255.255.128

SNMP Agent

On the SNMP Agent page, you may enable SNMP and set the read and write settings. The ioLogik Ethernet I/O device supports SNMP v1, v2c, and V3 (Simple Network Management Protocol) to allow monitoring of network and I/O devices with SNMP Network Management software. It is useful in building automation and telecom applications. Use these fields to enable SNMP and set the read and write community strings for SNMP v1 and v2c, or use authentication for SNMP v3.

Network Connection

On the Network Connection page, you may view the TCP connections from other hosts. This may assist you in the management of your devices.

Firmware Update

On the Firmware Update page, you may load new or updated firmware onto the ioLogik.

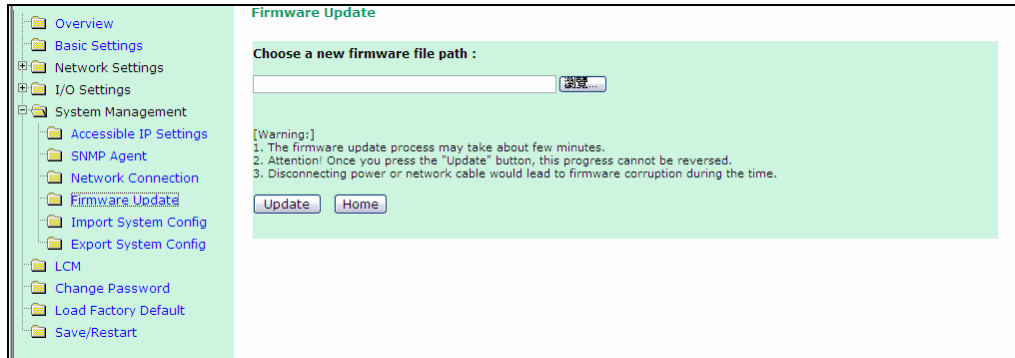

Import System Config

On the Import System Config page, you may import a configuration onto the ioLogik server. The configuration file must have been generated by ioAdmin or through the web console. This function can be used to duplicate settings between ioLogik servers. You will be prompted for the location of the configuration file (i.e., "ik2260.txt").

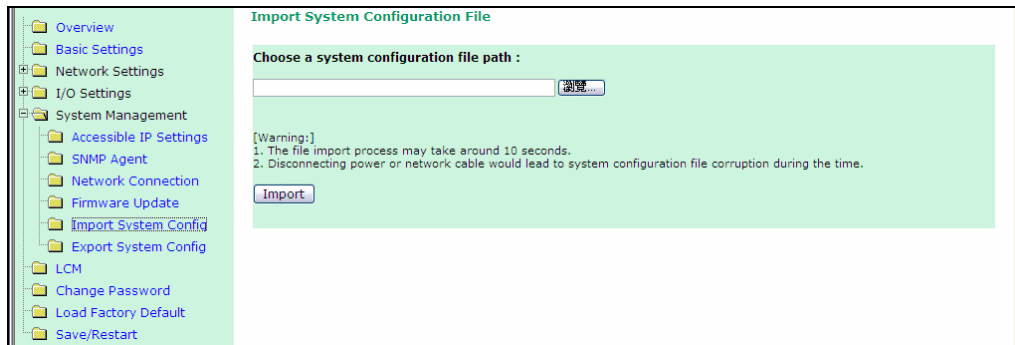

Export System Config

On the Export System Config page, you may save the ioLogik's configuration into a file for backup or import into another ioLogik server.

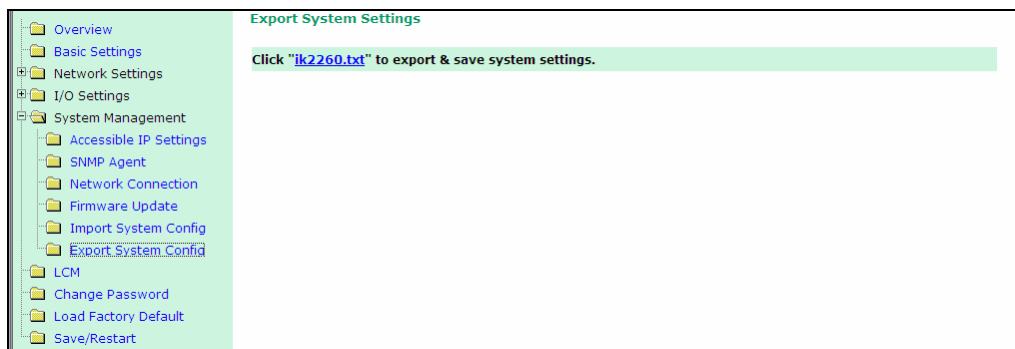

LCM

If you have installed the optional LCM, you may view the LCM's status and firmware details on the LCM page.



Change Password

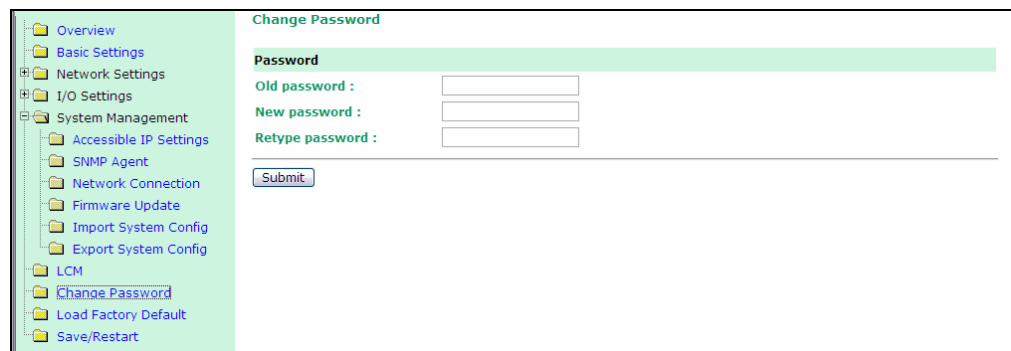

When changing the ioLogik E2260's password settings, you will first need to enter the old password. Leave this blank if you are setting up password protection for the first time. To set up a new password or change the existing password, enter your desired password under both **New password** and **Confirm password**. To remove password protection, leave the New password and Confirm password fields blank.



ATTENTION

If you forget the password, the **ONLY** way to configure the ioLogik E2260 is by using the reset button to load the factory defaults.

Before you set a password for the first time, it is a good idea to complete the ioLogik's configuration and export the configuration to a file. The configuration can then be easily loaded imported back into the ioLogik E2260 if it has been reset to factory defaults.

Load Factory Default

This function will reset all of the ioLogik E2260's settings to the factory default values. All previous settings including the console password will be lost.

Save/Restart

If you change the configuration, do not forget to reboot the system.

5

Active OPC Server Lite

In this chapter, we explain how to use ioAdmin to configure your ioLogik product.

The following topics are covered in this chapter:

- Overview**
- Introduction to Active OPC Server Lite**
- Active OPC Server Lite – From Pull to Push**
- Features of Active OPC Server Lite**
- Active OPC Server Lite Specifications**
 - Installation of Active OPC Server Lite
 - Installation of OPC Core Components
- Active OPC Server Lite**
 - Main Screen Overview
- Menu Items**
 - File
 - System
 - Sort
 - Quick Links
- Tag Generation**
 - Push Tag Configuration from ioAdmin
 - Advanced Settings
 - Heartbeat Interval
 - Read/Write Privilege
 - OPC Test Client

Overview

OPC (originally OLE for process control) is an industry standard created with the collaboration of a number of leading worldwide automation hardware and software suppliers, working in cooperation with Microsoft. The standard defines methods for exchanging real-time automation data between PC-based clients using Microsoft operating systems. The organization that manages this standard is the OPC Foundation.

The OPC Specification is a non-proprietary technical specification that defines a set of standard interfaces based upon Microsoft's OLE/COM/DCOM platform and .NET technology. The application of the OPC standard interface makes possible interoperability between automation/control applications, field systems/devices and business/office applications.

Traditionally, each software or application developer was required to write a custom interface, or server/driver, to exchange data with hardware field devices. OPC eliminates this requirement by defining a common, high performance interface that permits this work to be done once, and then easily reused by HMI, SCADA, Control and custom applications.

[Drivers must be installed several times to connect to different devices]

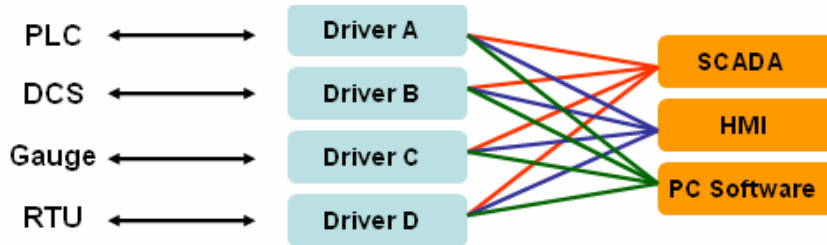

[OPC Client/Server creates a common interface connecting to different devices]

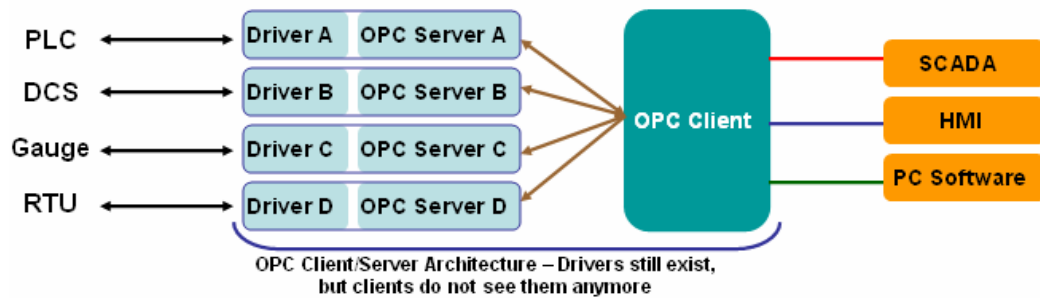

Introduction to Active OPC Server Lite

Moxa Active OPC Server Lite is a software package operated as an OPC driver of an HMI or SCADA system. It offers seamless connection from Moxa ioLogik series products to the SCADA systems, including the most popular Wonderware, Citect, and iFix. Active OPC Server Lite meets the latest standard of OPC DA3.0 that allows connections to various kinds of devices and host OPC machines.

Active OPC Server Lite – From Pull to Push

When first looking up the I/O devices' Modbus table, users need to create one tag within 19 or more steps including specifying the IP address, selection of the protocols, and define the data type. The procedure is repeated over and over again until all the devices and tags are created. A technician can expect to take 1 minute to create just one tag. But what if there are 400 tags in the OPC system? Also, the more tags are used, the higher CPU loading will be taken.

The general OPC also requires the connected I/O devices to use fixed IP address, if there are applications running on a public network (usually dynamic IPs) or portable measurements, there is no way to connect to an I/O device using OPC. This architecture is also called "pull" technology because the OPC server always polls the I/O devices from tag creation, IP connection and the tag status update.

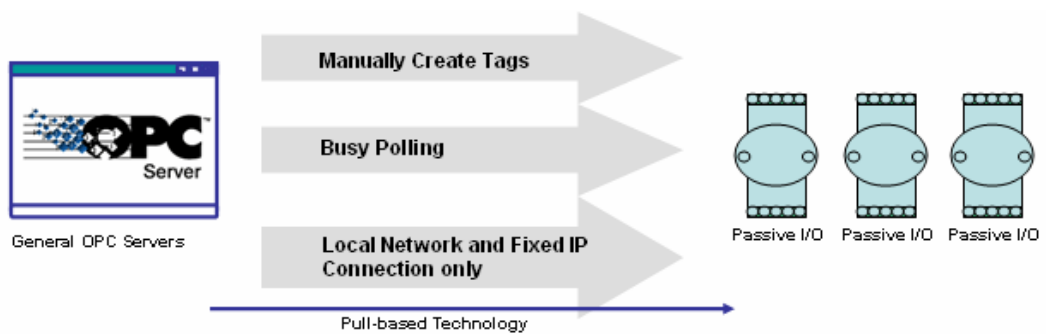

Moxa Active Ethernet I/O – ioLogik series products provide the I/O status report via TCP/UDP message, e-mail or SNMP traps. These benefits have now expanded to the OPC technology. Without asking any questions, even the IP address, settings of a tag are automatically created by the ioLogik itself to notify which tag should be created. Users need only to launch the Active OPC Server program, and those I/O channels selected by a user will be "pushed" from an ioLogik to Active OPC Server.

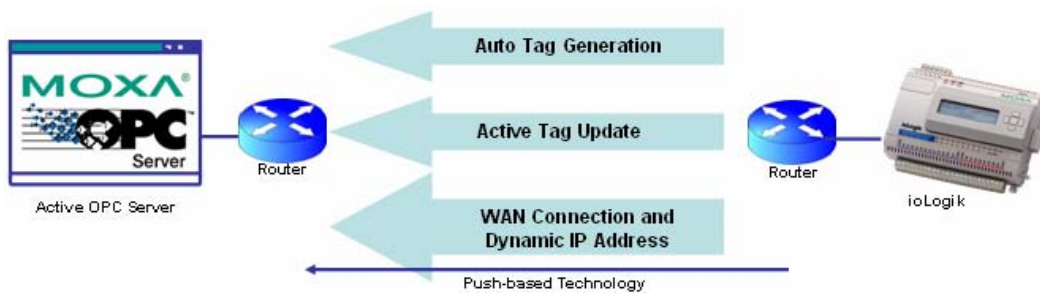

The “push” technology also includes the update for the tags. When the I/O the status changes, there will be updates from the ioLogik to Active OPC Server Lite. Compared to constantly polling (pull-based) the status, this feature efficiently reduces the network bandwidth usage and speeds up the response time with event-driven, push-based status updates. At the same time, the heartbeat function visual confirms that ioLogik is “alive” and working.

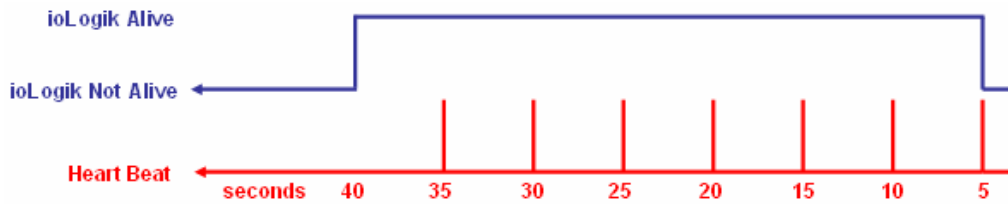
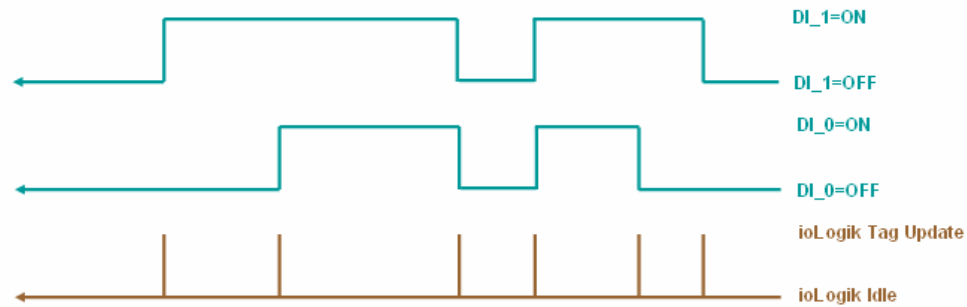

Features of Active OPC Server Lite

Automatic tag generation

Without specifying IP addresses, I/O channels, and data formats one by one or editing and importing any configuration text files, Active OPC Server Lite creates the tags for the target ioLogik automatically. These tags are not fixed but created by users. After selecting the channels required to be update to Active OPC Server Lite, it will generate the tag configuration without asking any questions. Training for installation and configuration should be required to implement a general OPC Server package. For ioLogik users, learning the OPC technology, looking up Modbus address, configuring data format, assigning target IP and so on are not required.

Active tag update with heartbeat detection

ioLogik uses “Active” technology to update the I/O status. This includes the tag status update to Active OPC Server Lite. Compared to traditional OPC Servers, this mechanism reduces Ethernet bandwidth usage by 80%. At the same time, it increases the response time of the I/O channels 7 timers faster than before. The SCADA PC can now also be load balanced for its CPU time because it simply waits for updates instead of polling the I/O channel all the time.

Dynamic IP Address Support

Active OPC Server also delivers the flexibility of using dynamic IP addresses on the ioLogik. As for the traditional data acquisition application, I/O devices are not capable of using this approach. The flexibility of connections through firewall is also expanded.

Active OPC Server Lite Specifications

Hardware Requirements

CPU	Intel Pentium (Pentium 4 and above)
RAM	512 MB (1024 MB recommended)
Network Interface	10/100Mb Ethernet

Software Requirements

Operating System	Microsoft Windows 2000, XP or later
Editor (Not necessary)	Microsoft Office 2003 (Access 2003) or later

OPC Server Specifications

OPC Data Access	1.0a, 2.0, 2.05a, 3.0
Max. tags	256

ioLogik Support

Product Model	ioLogik E2210, E2212, E2214, E2240, E2242, E2260, E2262
Firmware version	V3.0 or above
ioAdmin version	V3.0 or above

Installation of Active OPC Server Lite

Active OPC Server Lite can be found in the **Document and Software CD**, or downloaded from Moxa Website. The following steps show how to install Active OPC Server Lite from the CD.

1. **Installation from CD:** Insert the Document and Software CD into the host computer. In the Software\AOPCLite directory of the CD, locate and run SETUP.EXE. The installation program will guide you through the installation process and install the Active OPC Server Lite utility.
2. **Open Active OPC Server Lite:** After installation is finished, run Active OPC Server Lite from the Windows Start menu: **Start → Program Files → MOXA → IO Server → ActiveOPC → ActiveOPC.**

Installation of OPC Core Components

OPC Core Components provides the necessary connection library of Active OPC Server Lite. This package must be installed in the computer where Active OPC Server Lite is.

1. After Active OPC Server Lite installation is finished, run Setup OPC Core Components from the Windows Start menu: **Start → Program Files → MOXA → IO Server → ActiveOPC → Setup OPC Core Components**

The installation program will guide you through the installation process.

Active OPC Server Lite

Main Screen Overview

Active OPC Server Lite's main screen displays a figure of the mapped ioLogik with the status of every I/O tag. Note that configuration and tags are not available until you have the ioLogik to create the tags.

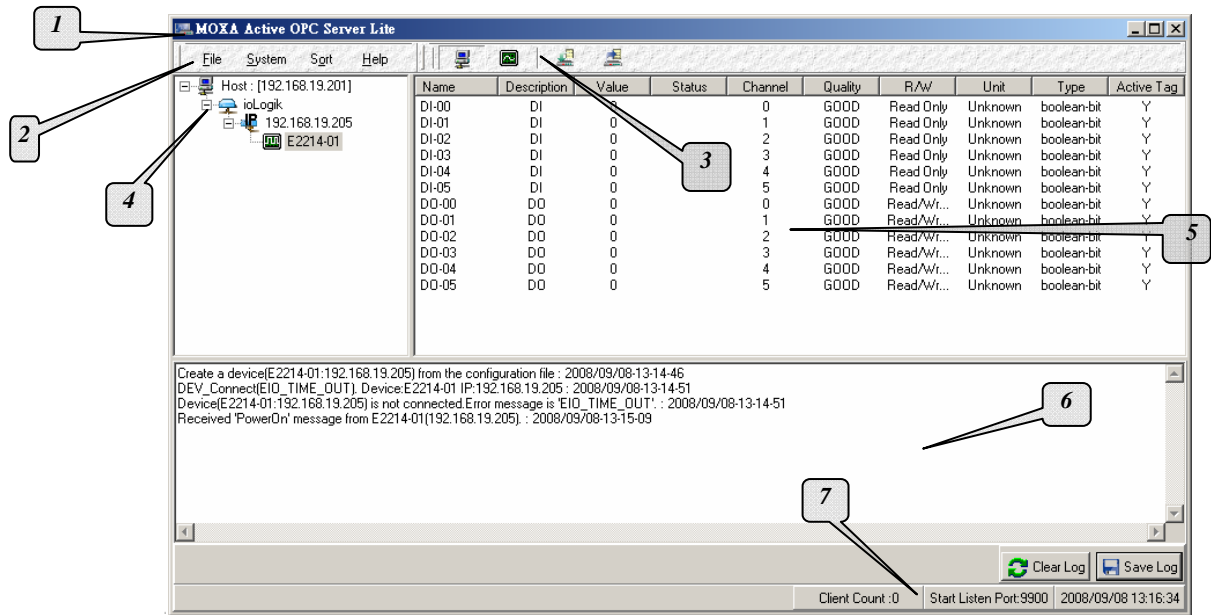

Active OPC Server Lite Main Screen
1. Title
2. Menu bar
3. Quick link
4. Navigation panel
5. Tag Window
6. Log Monitor
7. Status bar

Menu Items

File

From the **File** menu, you can export the list of the ioLogik that are currently displayed in the navigation panel. You also can import a list into Active OPC Server Lite.

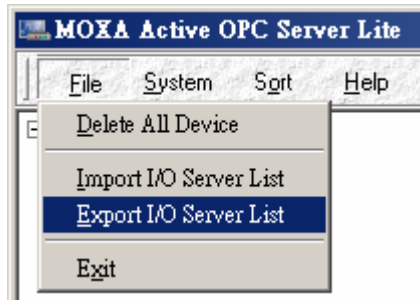

The file will have **.mdb** extension and can be opened using Microsoft Office - Access. The server list includes the current tag information of the mapped ioLogik. Saving the configuration when exiting the Active OPC Server is also recommended.

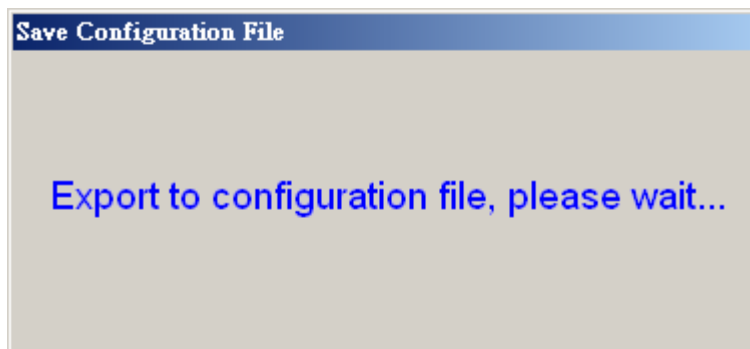

System

Several operations can be accessed from the **System** menu.

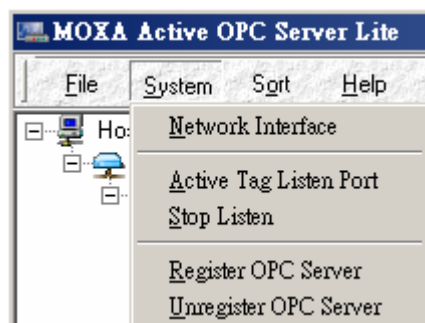

Network Interface allows you to select a network to use, if the PC has multiple network adaptors installed.

Active Tag Listen Port allows you to select the preferred TCP socket port for tag generation from ioAdmin.

Stop Listen allows you to stop getting tag generation messages and I/O status updates.

Register OPC Server is used to register the DCOM components to the Windows system. After Active OPC Server Lite is installed, it will automatically configure the DCOM.

Unregister OPC Server is used to cancel the registration of the DCOM components from the Windows system.

Sort





The **Sort** menu allows the server list in the navigation panel to be sorted by connection and type (model).



Quick Links

Quick links are provided to sort the server list and import/export configuration.



	Sort by connection
	Sort by server type
	Import configuration
	Export configuration

Tag Generation

Push Tag Configuration from ioAdmin

Tag configuration of an ioLogik is specified by ioAdmin configuration utility. Start the ioAdmin, log in as an administrator and go to the **Active Tags**.

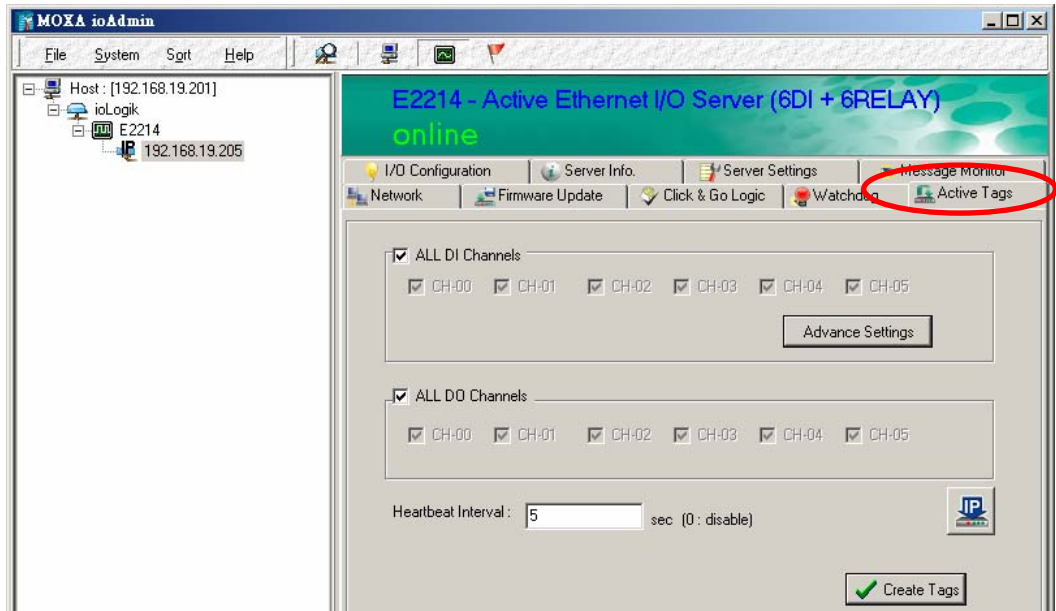

Following are the steps to create the tags.

1. Click on the **Set OPC Server Address** () button to specify the IP address of Active OPC Server Lite.

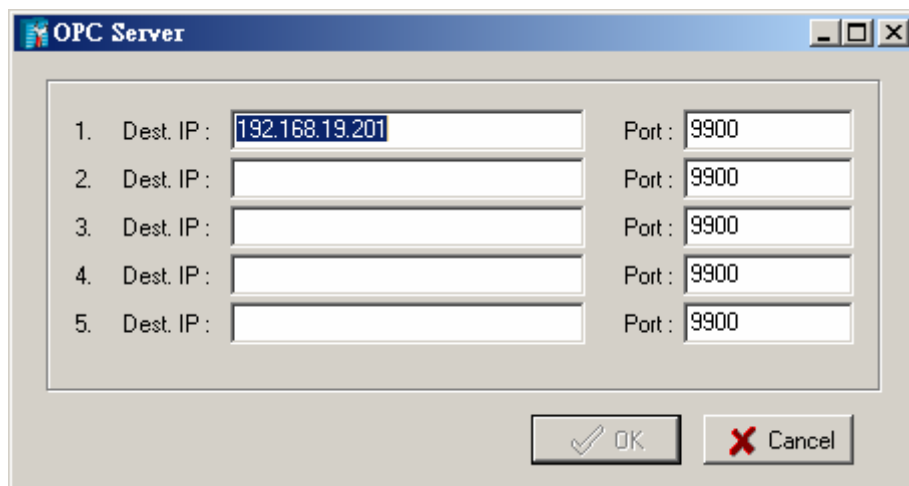

- Click **Yes** to restart the ioLogik.



- Specify the channels needed to be monitored by Active OPC Server Lite.

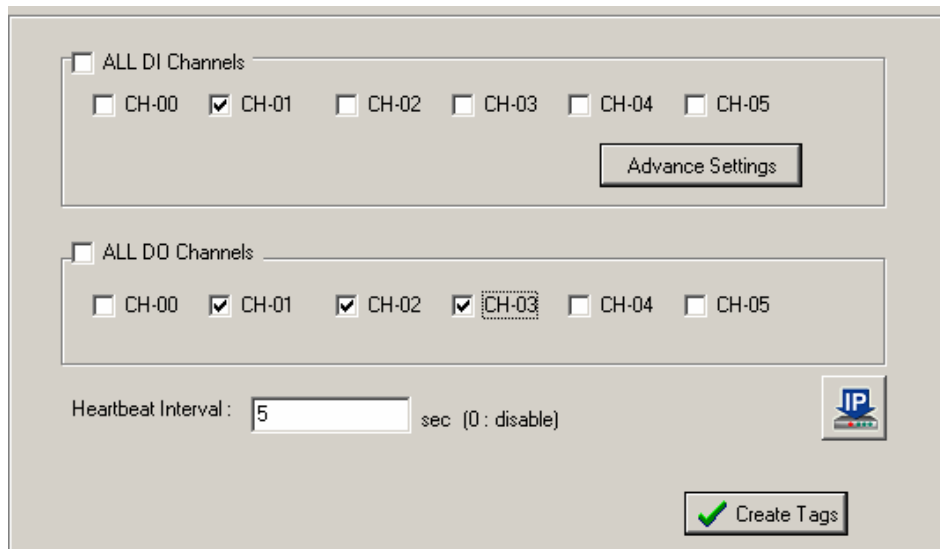

- Click on the Create Tags button to push the tag configuration to Active OPC Server Lite.
- Start the Active OPC Server Lite from Windows Start Menu. In the log monitor, a message will appear to confirm that the configuration was received. After that, tags are automatically created.

Advanced Settings

Advanced settings of the tags define the period that an ioLogik checks for the counter input status. By default, the status is checked as soon as it changes. Users can define the interval starting from 100 ms to 60 seconds.

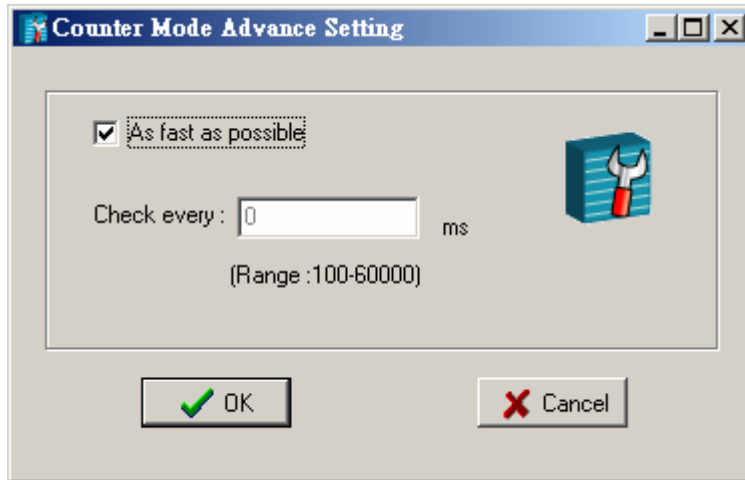

Heartbeat Interval

Tags are event-driven and updated only when the status of an I/O channel changes, so when the status remains unchanged, there will not be an update to Active OPC Server Lite. To ensure the ioLogik is connected and alive, **Heartbeat Interval** can be used to determine the connection status between the ioLogik and Active OPC Server Lite. If the heartbeat interval is set and the network between the ioLogik and Active OPC Server Lite is down, Active OPC Server Lite will detect the stop of the heartbeat and the Quality column will show **BAD** to indicate the loss of the connection. Default interval is set to 0 seconds, which disables the heartbeat. The maximum interval is 65,535 seconds.

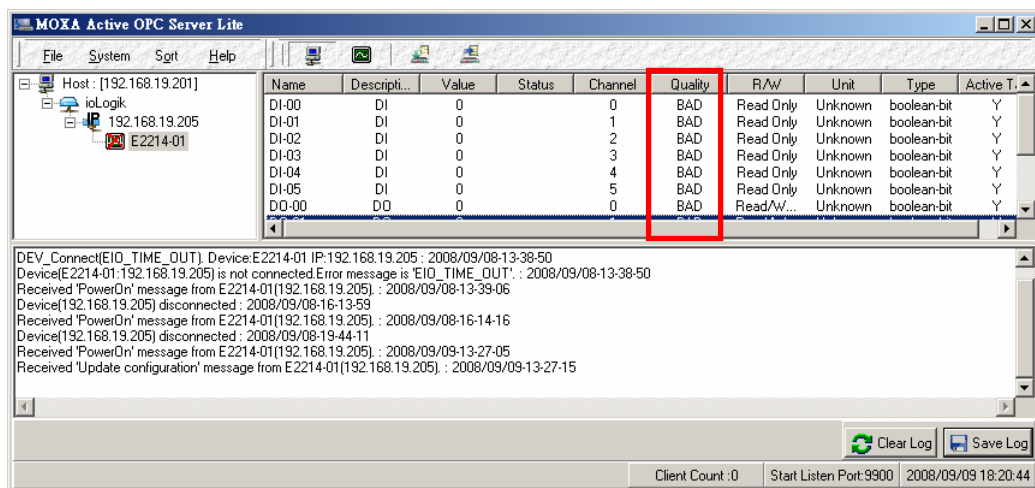

Read/Write Privilege

An input channel can only be read while an output channel is read/write acceptable showing on the Active OPC Server Lite. Note that if an output channel has been used in the Click&Go logic, the tags for that channel are read-only.

OPC Test Client

An OPC client software is embedded into the Active OPC Server Lite package for test purposes. After configuring the tags on the Active OPC Server Lite, this **ClientTest** can be launched from the Windows Start menu: **Start → Program Files → MOXA → IO Server → ActiveOPC → ClientTest.**

If Active OPC Server Lite is installed locally in the same PC, select **Connect → Local** from the menu bar. Specify the **MOXA ACTIVE OPC SERVER** in the **Server Name** column.

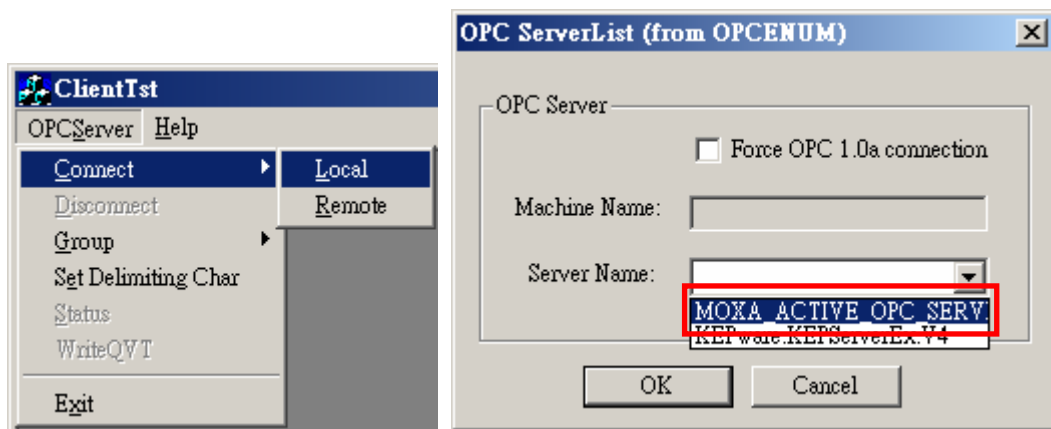

If the Active OPC Server Lite is installed on a remote PC, select **Connect → Remote** from the menu bar. Input the host name (i.e. Moxa_Client) or IP address and specify **MOXA ACTIVE OPC SERVER** in the **Server Name** column.

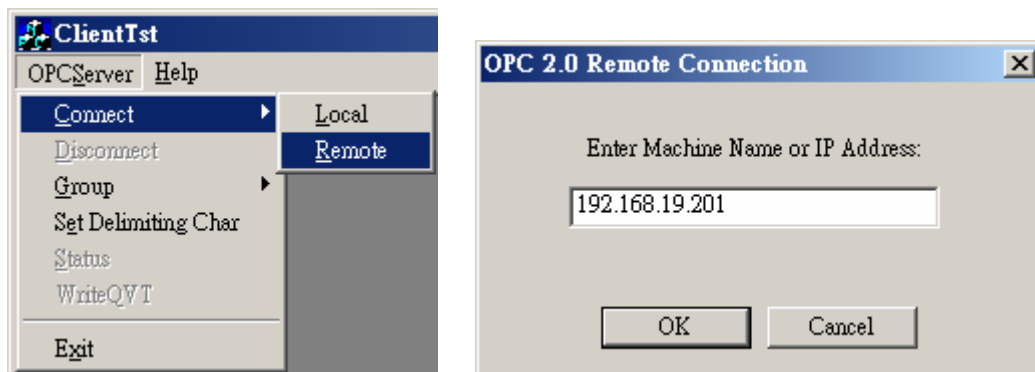

Click on the **Group** → **Add** and specify the **Group Name** (user-defined). A blank tag monitoring screen will start.

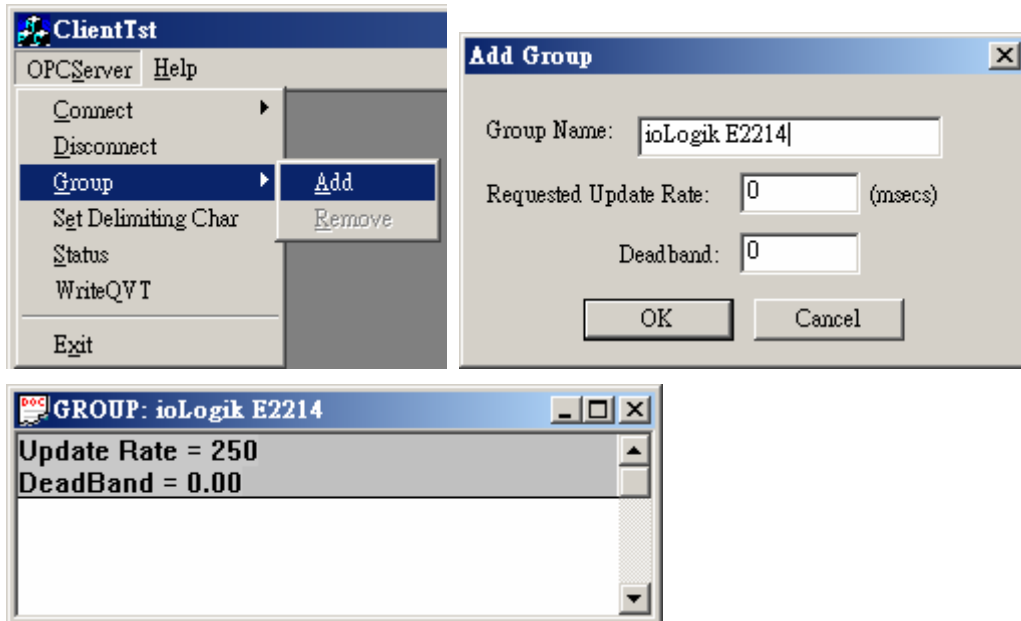

Click **Item** → **Browse** and select the channel needed to be monitored.

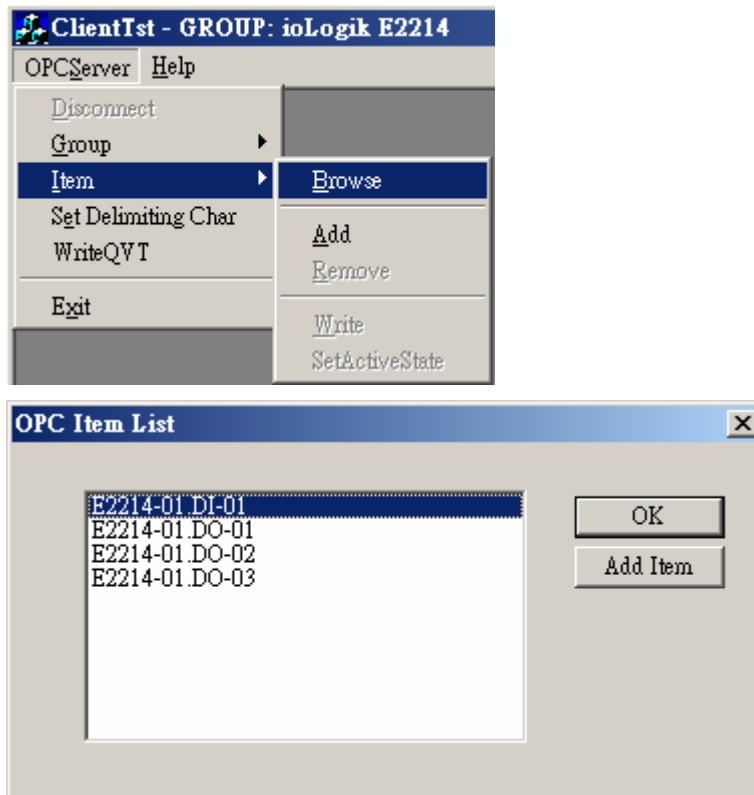

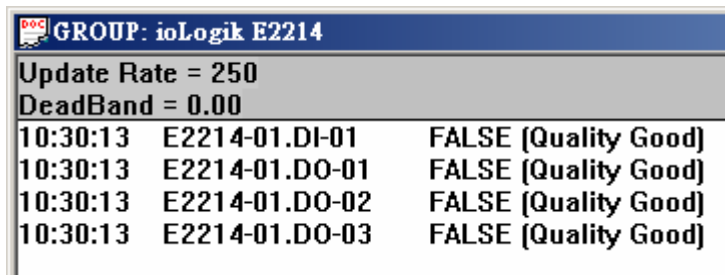

GROUP: ioLogik E2214		
Update Rate = 250		
DeadBand = 0.00		
10:30:13	E2214-01.DI-01	FALSE (Quality Good)
10:30:13	E2214-01.DO-01	FALSE (Quality Good)
10:30:13	E2214-01.DO-02	FALSE (Quality Good)
10:30:13	E2214-01.DO-03	FALSE (Quality Good)

To write to the output channel, specify an output channel first. Then, select **Item** → **Write** from the menu bar.

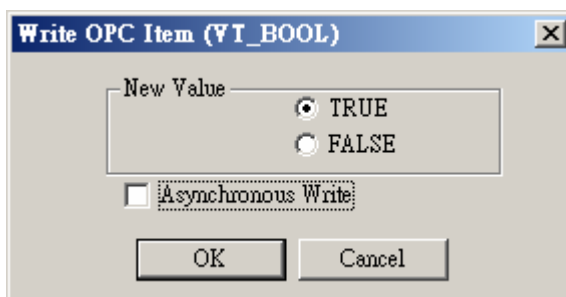
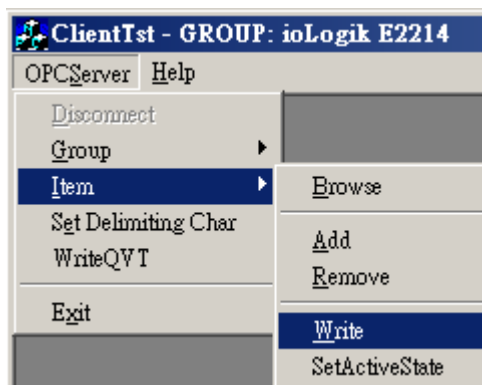

A

Liquid Crystal Display Module (LCM)

The ioLogik E2260 supports an optional detachable Liquid Crystal Display Module (LCM) for easier field maintenance. The LCM is hot-pluggable and can be used to configure the network settings or display other settings. When plugged in, the LCM displays the ioLogik E2260 “home page,” and pressing any button takes you into the settings and configuration.

LCM Controls

The up and down buttons navigate between the current options. The right and left buttons enter and exit the submenus. The center button is used when modifying settings or restarting the server.

Button	Function
Up	go to the previous item
Down	go to the next item
Left	exit the current submenu and return to the previous menu (go up one level)
Right	enter the selected submenu (go down one level)
Center	enter/exit editing mode

An “e” in the upper right hand corner of the display indicates that the parameter can be modified. Press the center button on the LCM to modify that parameter’s settings.

LCM Options

Display	Explanation / Actions
<ioLogik E2260>	This is the default “home page” showing the IP address. Press the down button to view the submenus.
<ioLogik E2260> server	Enter this submenu to display information about the specific server you are viewing: <ul style="list-style-type: none">● serial number● name● location● e2260 f/w ver● lcm f/w ver● model name

Display	Explanation / Actions
<ioLogik E2260> network	Enter this submenu to display information and settings for the network: <ul style="list-style-type: none"> ● ethernet link ● MAC address ● IP mode ● IP address ● netmask ● gateway ● DNS server-1 ● DNS server-2
<ioLogik E2260> click&go	Enter this submenu to display information about the ruleset being used by the active I/O system. <ul style="list-style-type: none"> ● name ● status
<ioLogik E2260> serial port	Enter this submenu to display the RS-485 cascade port settings.
<ioLogik E2260> i/o setting	Enter this submenu to access I/O channel status. Here are examples of settings that you might see: <ul style="list-style-type: none"> ● RTD-00 XXX °C Press up or down to navigate through the different I/O channels without having to go back to the previous menu.
<ioLogik E2260> console	Enter this submenu to see if the web console is enabled or disabled.
<ioLogik E2260> ping	Select this option to enter an IP address to ping. If you get a "timeout" error, it indicates that the E2260 cannot reach that IP address. Otherwise, the display will show the response time.
<ioLogik E2260> save/restart	Enter this submenu to display the restart now submenu. Enter the restart now submenu to display the restart option. Press the center button to modify this option, then select enable to save changes and reboot the I/O server. The disable option has no effect.

**WARNING**

Any configuration changes that are made through the LCM will not take effect until the ioLogik E2260 is restarted.

B

Modbus/TCP Address Mappings

0xxxx Read/Write Coils (Functions 1, 5, 15)

Reference	Address	Data Type	Description
00001	0x0000	1 bit	CH0 RTD Reset Minimum Value <R> Always 0 <W> 1=Reset to current value, 0=return illegal data value
00002	0x0001	1 bit	CH1 RTD Reset Minimum Value
00003	0x0002	1 bit	CH2 RTD Reset Minimum Value
00004	0x0003	1 bit	CH3 RTD Reset Minimum Value
00005	0x0004	1 bit	CH4 RTD Reset Minimum Value
00006	0x0005	1 bit	CH5 RTD Reset Minimum Value
00007	0x0006	1 bit	Virtual CH6 RTD Reset Maximum Value
00008	0x0007	1 bit	Virtual CH7 RTD Reset Minimum Value
00009	0x0008	1 bit	Virtual CH8 RTD Reset Minimum Value
00010	0x0009	1 bit	Virtual CH9 RTD Reset Minimum Value
00011	0x000A	1 bit	Virtual CH10 RTD Reset Minimum Value
00012	0x000B	1 bit	Virtual CH11 RTD Reset Minimum Value
00013	0x000C	1 bit	CH0 RTD Reset Maximum Value
00014	0x000D	1 bit	CH1 RTD Reset Maximum Value
00015	0x000E	1 bit	CH2 RTD Reset Maximum Value
00016	0x000F	1 bit	CH3 RTD Reset Maximum Value
00017	0x0010	1 bit	CH4 RTD Reset Maximum Value
00018	0x0011	1 bit	CH5 RTD Reset Maximum Value
00019	0x0012	1 bit	Virtual CH6 RTD Reset Maximum Value
00020	0x0013	1 bit	Virtual CH7 RTD Reset Maximum Value
00021	0x0014	1 bit	Virtual CH8 RTD Reset Maximum Value
00022	0x0015	1 bit	Virtual CH9 RTD Reset Maximum Value
00023	0x0016	1 bit	Virtual CH10 RTD Reset Maximum Value
00024	0x0017	1 bit	Virtual CH11 RTD Reset Maximum Value
00025	0x0018	1 bit	CH0 RTD Enable <RW> 0=Disable, 1=Enable
00026	0x0019	1 bit	CH1 RTD Enable
00027	0x001A	1 bit	CH2 RTD Enable
00028	0x001B	1 bit	CH3 RTD Enable
00029	0x001C	1 bit	CH4 RTD Enable
00030	0x001D	1 bit	CH5 RTD Enable
00031	0x001E	1 bit	CH0 DO Status <RW> 0=OFF, 1=ON

Reference	Address	Data Type	Description
00032	0x001F	1 bit	CH1 DO Status
00033	0x0020	1 bit	CH2 DO Status
00034	0x0021	1 bit	CH3 DO Status
00035	0x0022	1 bit	CH0 DO Power-On Status <RW> 0=OFF, 1=ON
00036	0x0023	1 bit	CH1 DO Power-On Status
00037	0x0024	1 bit	CH2 DO Power-On Status
00038	0x0025	1 bit	CH3 DO Power-On Status
00039	0x0026	1 bit	CH0 DO Safe Status <RW> 0=OFF, 1=ON
00040	0x0027	1 bit	CH1 DO Safe Status
00041	0x0028	1 bit	CH2 DO Safe Status
00042	0x0029	1 bit	CH3 DO Safe Status
00043	0x002A	1 bit	CH0 DO Pulse Output Status <RW> 0=Stop, 1=Start
00044	0x002B	1 bit	CH1 DO Pulse Output Status
00045	0x002C	1 bit	CH2 DO Pulse Output Status
00046	0x002D	1 bit	CH3 DO Pulse Output Status
00047	0x002E	1 bit	CH0 DO Power-On Pulse Output Status <RW> 0=Stop, 1=Start
00048	0x002F	1 bit	CH1 DO Power-On Pulse Output Status
00049	0x0030	1 bit	CH2 DO Power-On Pulse Output Status
00050	0x0031	1 bit	CH3 DO Power-On Pulse Output Status
00051	0x0032	1 bit	CH0 DO Safe Mode Pulse Output Status <RW> 0=Stop, 1=Start
00052	0x0033	1 bit	CH1 DO Safe Mode Pulse Output Status
00053	0x0034	1 bit	CH2 DO Safe Mode Pulse Output Status
00054	0x0035	1 bit	CH3 DO Safe Mode Pulse Output Status

3xxxx Read Only Registers (Function 4)

Reference	Address	Data Type	Description
30001	0x0000	1 word	CH0 RTD Value <R> 0~65535, Unit:0.1 (Ohm, Celsius, Fahrenheit)
30002	0x0001	1 word	CH1 RTD Value
30003	0x0002	1 word	CH2 RTD Value
30004	0x0003	1 word	CH3 RTD Value
30005	0x0004	1 word	CH4 RTD Value
30006	0x0005	1 word	CH5 RTD Value
30007	0x0006	1 word	Virtual CH6 RTD Value <R> 0~65535, Unit:0.1 (Celsius, Fahrenheit)
30008	0x0007	1 word	Virtual CH7 RTD Value
30009	0x0008	1 word	Virtual CH8 RTD Value
30010	0x0009	1 word	Virtual CH9 RTD Value
30011	0x000A	1 word	Virtual CH10 RTD Value
30012	0x000B	1 word	Virtual CH11 RTD Value
30013	0x000C	1 word	CH0 RTD Minimum Value <R> 0~65535, Unit:0.1 (Ohm, Celsius, Fahrenheit)

Reference	Address	Data Type	Description
30014	0x000D	1 word	CH1 RTD Minimum Value
30015	0x000E	1 word	CH2 RTD Minimum Value
30016	0x000F	1 word	CH3 RTD Minimum Value
30017	0x0010	1 word	CH4 RTD Minimum Value
30018	0x0011	1 word	CH5 RTD Minimum Value
30019	0x0012	1 word	Virtual CH6 RTD Minimum Value
30020	0x0013	1 word	Virtual CH7 RTD Minimum Value
30021	0x0014	1 word	Virtual CH8 RTD Minimum Value
30022	0x0015	1 word	Virtual CH9 RTD Minimum Value
30023	0x0016	1 word	Virtual CH10 RTD Minimum Value
30024	0x0017	1 word	Virtual CH11 RTD Minimum Value
30025	0x0018	1 word	CH0 RTD Maximum Value <R> 0~65535, Unit:0.1 (Ohm, Celsius, Fahrenheit)
30026	0x0019	1 word	CH1 RTD Maximum Value
30027	0x001A	1 word	CH2 RTD Maximum Value
30028	0x001B	1 word	CH3 RTD Maximum Value
30029	0x001C	1 word	CH4 RTD Maximum Value
30030	0x001D	1 word	CH5 RTD Maximum Value
30031	0x001E	1 word	CH1 RTD Maximum Value
30032	0x001F	1 word	CH2 RTD Maximum Value
30033	0x0020	1 word	CH2 RTD Maximum Value
30034	0x0021	1 word	CH3 RTD Maximum Value
30035	0x0022	1 word	CH4 RTD Maximum Value
30036	0x0023	1 word	CH5 RTD Maximum Value

4xxxx Read/Write Registers (Functions 3, 6, 16)

Reference	Address	Data Type	Description
40001	0x0000	1 word	CH0 DO Pulse Output Count Value Hi Word <RW> 0~4294967295
40002	0x0001	1 word	CH0 DO Pulse Output Count Value Lo Word <RW> 0~4294967295
40003	0x0002	1 word	CH1 DO Pulse Output Count Value Hi Word
40004	0x0003	1 word	CH1 DO Pulse Output Count Value Lo Word
40005	0x0004	1 word	CH2 DO Pulse Output Count Value Hi Word
40006	0x0005	1 word	CH2 DO Pulse Output Count Value Lo Word
40007	0x0006	1 word	CH3 DO Pulse Output Count Value Hi Word
40008	0x0007	1 word	CH3 DO Pulse Output Count Value Lo Word
40009	0x0008	1 word	CH0 DO Pulse Output Low Signal Width – Hi Word <RW> 0~4294967295
40010	0x0009	1 word	CH0 DO Pulse Output Low Signal Width – Lo Word <RW> 0~4294967295
40011	0x000A	1 word	CH1 DO Pulse Output Low Signal Width – Hi Word
40012	0x000B	1 word	CH1 DO Pulse Output Low Signal Width – Lo Word
40013	0x000C	1 word	CH2 DO Pulse Output Low Signal Width – Hi Word
40014	0x000D	1 word	CH2 DO Pulse Output Low Signal Width – Lo Word
40015	0x000E	1 word	CH3 DO Pulse Output Low Signal Width – Hi Word
40016	0x000F	1 word	CH3 DO Pulse Output Low Signal Width – Lo Word

Reference	Address	Data Type	Description
40017	0x0010	1 word	CH0 DO Pulse Output High Signal Width – Hi Word <RW> 0~4294967295
40018	0x0011	1 word	CH0 DO Pulse Output High Signal Width – Lo Word <RW> 0~4294967295
40019	0x0012	1 word	CH1 DO Pulse Output High Signal Width – Hi Word
40020	0x0013	1 word	CH1 DO Pulse Output High Signal Width – Lo Word
40021	0x0014	1 word	CH2 DO Pulse Output High Signal Width – Hi Word
40022	0x0015	1 word	CH2 DO Pulse Output High Signal Width – Lo Word
40023	0x0016	1 word	CH3 DO Pulse Output High Signal Width – Hi Word
40024	0x0017	1 word	CH3 DO Pulse Output High Signal Width – Lo Word
40025	0x0018	1 word	CH0 DO Operation Mode <RW> 0=DO Mode, 1=Pulse Output Mode
40026	0x0019	1 word	CH1 DO Operation Mode
40027	0x001A	1 word	CH2 DO Operation Mode
40028	0x001B	1 word	CH3 DO Operation Mode
40029	0x001C	1 word	CH0 RTD Engineering Unit 0=Ohm, 1=Celsius, 2=Fahrenheit
40030	0x001D	1 word	CH1 RTD Engineering Unit
40031	0x001E	1 word	CH2 RTD Engineering Unit
40032	0x001F	1 word	CH3 RTD Engineering Unit
40033	0x0020	1 word	CH4 RTD Engineering Unit
40034	0x0021	1 word	CH5 RTD Engineering Unit
40035	0x0022	1 word	Virtual CH6 RTD Engineering Unit 1=Celsius, 2=Fahrenheit
40036	0x0023	1 word	Virtual CH7 RTD Engineering Unit
40037	0x0024	1 word	Virtual CH8 RTD Engineering Unit
40038	0x0025	1 word	Virtual CH9 RTD Engineering Unit
40039	0x0026	1 word	Virtual CH10 RTD Engineering Unit
40040	0x0027	1 word	Virtual CH11 RTD Engineering Unit
40041	0x0028	1 word	CH0 RTD Sensor Type 0=PT50 1=PT100 2=PT200 3=PT500 4=PT1000 5=JPT100 6=JPT200 7=JPT500 8=JPT1000 9=NI100 10=NI200 11=NI500 12=NI1000 13=NI120 14=310 Ohm 15=620 Ohm 16=1250 Ohm 17=2500 Ohm
40042	0x0029	1 word	CH1 RTD Sensor Type

Reference	Address	Data Type	Description
40043	0x002A	1 word	CH2 RTD Sensor Type
40044	0x002B	1 word	CH3 RTD Sensor Type
40045	0x002C	1 word	CH4 RTD Sensor Type
40046	0x002D	1 word	CH5 RTD Sensor Type
40047	0x002E	1 word	CH6 RTD Sensor Type 20=AVG 21=DIV
40048	0x002F	1 word	Virtual CH7 RTD Sensor Type
40049	0x0030	1 word	Virtual CH8 RTD Sensor Type
40050	0x0031	1 word	Virtual CH9 RTD Sensor Type
40051	0x0032	1 word	Virtual CH10 RTD Sensor Type
40052	0x0033	1 word	Virtual CH11 RTD Sensor Type
40053	0x0034	1 word	CH0 RTD Reset Minimum Value <R> Always 0 <W> 1=Reset, 0=return illegal data value
40054	0x0035	1 word	CH1 RTD Reset Minimum Value
40055	0x0036	1 word	CH2 RTD Reset Minimum Value
40056	0x0037	1 word	CH3 RTD Reset Minimum Value
40057	0x0038	1 word	CH4 RTD Reset Minimum Value
40058	0x0039	1 word	CH5 RTD Reset Minimum Value
40059	0x003A	1 word	Virtual CH6 RTD Reset Minimum Value
40060	0x003B	1 word	Virtual CH7 RTD Reset Minimum Value
40061	0x003C	1 word	Virtual CH8 RTD Reset Minimum Value
40062	0x003D	1 word	Virtual CH9 RTD Reset Minimum Value
40063	0x003E	1 word	Virtual CH10 RTD Reset Minimum Value
40064	0x003F	1 word	Virtual CH11 RTD Reset Minimum Value
40065	0x0040	1 word	CH0 RTD Reset Maximum Value <R> Always 0 <W> 1=Reset, 0=return illegal data value
40066	0x0041	1 word	CH1 RTD Reset Maximum Value
40067	0x0042	1 word	CH2 RTD Reset Maximum Value
40068	0x0043	1 word	CH3 RTD Reset Maximum Value
40069	0x0044	1 word	CH4 RTD Reset Maximum Value
40070	0x0045	1 word	CH5 RTD Reset Maximum Value
40071	0x0046	1 word	Virtual CH6 RTD Reset Maximum Value
40072	0x0047	1 word	Virtual CH7 RTD Reset Maximum Value
40073	0x0048	1 word	Virtual CH8 RTD Reset Maximum Value
40074	0x0049	1 word	Virtual CH9 RTD Reset Maximum Value
40075	0x004A	1 word	Virtual CH10 RTD Reset Maximum Value
40076	0x004B	1 word	Virtual CH11 RTD Reset Maximum Value
40077	0x004C	1 word	CH0 DO Status <RW> 0=OFF, 1=ON
40078	0x004D	1 word	CH1 DO Status
40079	0x004E	1 word	CH2 DO Status
40080	0x004F	1 word	CH3 DO Status
40081	0x0050	1 word	CH0 DO Power On Status <RW> 0=OFF, 1=ON
40082	0x0051	1 word	CH1 DO Status
40083	0x0052	1 word	CH2 DO Status

Reference	Address	Data Type	Description
40084	0x0053	1 word	CH3 DO Status
40085	0x0054	1 word	CH0 DO Safe Status <RW> 0=OFF, 1=ON
40086	0x0055	1 word	CH1 DO Status
40087	0x0056	1 word	CH2 DO Status
40088	0x0057	1 word	CH3 DO Status
40089	0x0058	1 word	CH0 DO Pulse Output Status <RW> 0=Stop, 1=Start
40090	0x0059	1 word	CH1 DO Pulse Output Status
40091	0x005A	1 word	CH2 DO Pulse Output Status
40092	0x005B	1 word	CH3 DO Pulse Output Status
40093	0x005C	1 word	CH0 DO Power On Pulse Output Status <RW> 0=Stop, 1=Start
40094	0x005D	1 word	CH1 DO Pulse Output Status
40095	0x005E	1 word	CH2 DO Pulse Output Status
40096	0x005F	1 word	CH3 DO Pulse Output Status
40097	0x0060	1 word	CH0 DO Safe Pulse Output Status <RW> 0=Stop, 1=Start
40098	0x0061	1 word	CH1 DO Pulse Output Status
40099	0x0062	1 word	CH2 DO Pulse Output Status
40100	0x0063	1 word	CH3 DO Pulse Output Status
40101	0x0064	1 word	CH0 RTD Enable <RW> 0 =Disable, 1=Enable
40102	0x0065	1 word	CH1 RTD Enable
40103	0x0066	1 word	CH2 RTD Enable
40104	0x0067	1 word	CH3 RTD Enable
40105	0x0068	1 word	CH4 RTD Enable
40106	0x0069	1 word	CH5 RTD Enable
40337	0x0150	1 word	Internal Register 00 Value
40338	0x0151	1 word	Internal Register 01 Value
40339	0x0152	1 word	Internal Register 02 Value
40340	0x0153	1 word	Internal Register 03 Value
40341	0x0154	1 word	Internal Register 04 Value
40342	0x0155	1 word	Internal Register 05 Value
40343	0x0156	1 word	Internal Register 06 Value
40344	0x0157	1 word	Internal Register 07 Value
40345	0x0158	1 word	Internal Register 08 Value
40346	0x0159	1 word	Internal Register 09 Value
40347	0x015A	1 word	Internal Register 10 Value
40348	0x015B	1 word	Internal Register 11 Value
40349	0x015C	1 word	Internal Register 12 Value
40350	0x015D	1 word	Internal Register 13 Value
40351	0x015E	1 word	Internal Register 14 Value
40352	0x015F	1 word	Internal Register 15 Value
40353	0x0160	1 word	Internal Register 16 Value
40354	0x0161	1 word	Internal Register 17 Value

Reference	Address	Data Type	Description
40355	0x0162	1 word	Internal Register 18 Value
40356	0x0163	1 word	Internal Register 19 Value
40357	0x0164	1 word	Internal Register 20 Value
40358	0x0165	1 word	Internal Register 21 Value
40359	0x0166	1 word	Internal Register 22 Value
40360	0x0167	1 word	Internal Register 23 Value

Used Network Port Numbers

E2260 Network Port Usage

Port	Type	Usage
68	UDP	BOOTPC
68	UDP	DHCP
69	UDP	Export/Import File
80	TCP	Web Server
161	TCP	SNMP
502	TCP	Modbus Communication
4040	TCP	ioEventLog
4800	UDP	Auto Search
9000	TCP	Active Message (Default)
9000	UDP	Active Message (Default)
9020	TCP	Peer-to-Peer Function
9900	TCP	Active Tags updates (default)

RFC1213 MIB II Supported SNMP Variables

The following SNMP variables are built into the ioLogik firmware and are compliant with RFC1213 MIB II.

System MIB
SysContact
SysDescr
SysLocation
SysName
SysObjectID
SysServices
SysUpTime

Interfaces MIB	
ifAdminStatus	ifOutErrors
ifDescr	ifOutNUcastPkts
ifIndex	ifOutOctets
ifInDiscards	ifOutQLen
ifInErrors	ifOutUcastPkts
ifInNUcastPkts	ifPhysAddress
ifInOctets	ifSpecific
ifInUcastPkts	ifSpeed
ifInUnknownProtos	ifType
ifLastChange	
ifMtu	
ifNumber	
ifOperStatus	
ifOutDiscards	

IP MIB		
ipAdEntAddr	ipInHdrErrors	ipRouteAge
ipAdEntBcastAddr	ipInreceives	ipRouteDest
ipAdEntIfIndex	ipInUnknownProtos	ipRouteIfIndex
ipAdEntNetMask	IpNetToMediaIfIndex	ipRouteInfo
ipAdEntReasmMaxSize	IpNetToMediaNetAddress	ipRouteMask
ipDefaultTTL	IpNetToMediaPhysAddress	ipRouteMetric1
ipForwarding	IpNetToMediaType	ipRouteMetric2
ipForwDatagrams	ipOutDiscards	ipRouteMetric3
ipFragCreates	ipOutNoRoutes	ipRouteMetric4
ipFragFails	ipOutRequests	ipRouteMetric5
ipFragOKs	ipReasmFails	ipRouteNextHop
ipInAddrErrors	ipReasmOKs	ipRouteProto
ipInDelivers	ipReasmReqds	ipRouteType
ipInDiscards	ipReasmTimeout	IpRoutingDiscards

ICMP MIB		
IcmpInAddrMasks	IcmpInTimeExcds	IcmpOutParmProbs
IcmpInDestUnreachs	IcmpInTimestamps	IcmpOutRedirects
IcmpInEchoReps	IcmpOutAddrMaskReps	IcmpOutSrcQuenchs
IcmpInEchos	IcmpOutAddrMasks	IcmpOutTimeExcds
IcmpInErrors	IcmpOutDestUnreachs	IcmpOutTimestampReps
IcmpInMsgs	IcmpOutEchoReps	IcmpOutTimestamps
IcmpInParmProbs	IcmpOutEchos	IcmpTimestampReps
IcmpInRedirects	IcmpOutErrors	
IcmpInSrcQuenchs	IcmpOutMsgs	

UDP MIB
UdpInDatagrams
UdpInErrors
UdpLocalAddress
UdpLocalPort
UdpNoPorts
UdpOutDatagrams

Address Translation MIB
AtIfIndex
AtNetAddress
AtNetAddress
AtPhysAddress

TCP MIB		
tcpActiveOpens	tcpCurrEstab	tcpPassiveOpens
tcpAttempFails	tcpEstabResets	tcpRetransSegs
tcpConnLocalAddress	tcpInErrs	tcpRtoAlgorithm
tcpConnLocalPort	tcpInSegs	tcpRtoMax
tcpConnRemAddress	tcpMaxConn	tcpRtoMin
tcpConnRemPort	tcpOutRsts	
tcpConnState	tcpOutSegs	

SNMP MIB	
snmpEnableAuthenTraps	snmpOutGenErrs
snmpInASNParseErrs	snmpOutGetNexts
snmpInBadCommunityNames	snmpOutGetRequests
snmpInBadCommunityUses	snmpOutGetResponses
snmpInBadValues	snmpOutNoSuchNames
snmpInBadVersions	snmpOutPkts
snmpInGenErrs	snmpOutSetRequests
snmpInGetNexts	snmpOutTooBig
snmpInGetRequests	snmpOutTraps
snmpInGetResponses	
snmpInNoSuchNames	
snmpInPkts	
snmpInReadOnly	
snmpInSetRequests	
snmpInTooBig	
snmpInTotalReqVars	
snmpInTotalSetVars	
snmpInTraps	
snmpOutBadValues	

Private MIB File and SNMP Variables

Moxa also provides an SNMP to I/O MIB file that can help you monitor I/O status with SNMP software. You can find the MIB file on the Document and Software CD.

Moxa IO MIB		
firmwareVersion	rtd00-Enable	rtd06-UnitType
serverModel	rtd00-Index	rtd06-Value
systemTime	rtd00-Type	rtd07-Index
totalChannelNumber	rtd00-UnitType	rtd07-Type
DO00-HighWidth	rtd00-Value	rtd07-UnitType
DO00-Index	rtd01-Enable	rtd07-Value
DO00-LowWidth	rtd01-Index	rtd08-Index
DO00-Mode	rtd01-Type	rtd08-Type
DO00-PulseStart	rtd01-UnitType	rtd08-UnitType
DO00-Status	rtd01-Value	rtd08-Value
DO00-Type	rtd02-Enable	rtd09-Index
DO01-HighWidth	rtd02-Index	rtd09-Type
DO01-Index	rtd02-Type	rtd09-UnitType
DO01-LowWidth	rtd02-UnitType	rtd09-Value
DO01-Mode	rtd02-Value	rtd10-Index
DO01-PulseStart	rtd03-Enable	rtd10-Type
DO01-Status	rtd03-Index	rtd10-UnitType
DO01-Type	rtd03-Type	rtd10-Value
DO02-HighWidth	rtd03-UnitType	rtd11-Index
DO02-Index	rtd03-Value	rtd11-Type
DO02-LowWidth	rtd04-Enable	rtd11-UnitType
DO02-Mode	rtd04-Index	rtd11-Value
DO02-PulseStart	rtd04-Type	
DO02-Status	rtd04-UnitType	
DO02-Type	rtd04-Value	
DO03-HighWidth	rtd05-Enable	
DO03-Index	rtd05-Index	
DO03-LowWidth	rtd05-Type	
DO03-Mode	rtd05-UnitType	
DO03-PulseStart	rtd05-Value	
DO03-Status	rtd06-Index	
DO03-Type	rtd06-Type	

E

CGI Commands

Using a web browser or standard HTTP protocol will make it easier for a Security SCADA system to monitor and control an ioLogik via CGI commands.

Syntax to get the settings is as follows. Starting with the ioLogik's IP or URL, specify **getParam.cgi** with a question mark. Then specify the command with another question mark as the ending. The commands are case sensitive and the **&** sign is used to combine multiple commands.

[**http://IP/getParam.cgi?command_channel=?&command_channel=?&.....\(Max 200 char\)**](http://IP/getParam.cgi?command_channel=?&command_channel=?&.....(Max 200 char))

Commands to get system information	Commands to get system information
DATE	FWR_V
TIME	MOD_NAME
IP	SN_NUM
LOC	MAC_ADDR
DESC	

Commands to get RTD information	Commands to get RTD information
RtdEnable_00 (0:Disable, 1:Enable)	RtdEnable_01 (0:Disable, 1:Enable)
RtdStype_00 (0:PT50, 1:Pt100, 2:Pt200, 3:Pt500, 4:Pt1000, 5:JPt100, 6:JPt200, 7:JPt500, 8:JPt1000, 9 :Ni 100, 10 :Ni 200, 11 :Ni 500, 12 :Ni 1000, 13 :Ni 120, 14 :Resistance (1-310 mΩ), 15:Resistance (1-620 mΩ), 16 :Resistance (1-1250 mΩ), 17:Resistance (1-2200 mΩ))	RtdStype_01 (0:PT50, 1:Pt100, 2:Pt200, 3:Pt500, 4:Pt1000, 5:JPt100, 6:JPt200, 7:JPt500, 8:JPt1000, 9 :Ni 100, 10 :Ni 200, 11 :Ni 500, 12 :Ni 1000, 13 :Ni 120, 14 :Resistance (1-310 mΩ), 15:Resistance (1-620 mΩ), 16 :Resistance (1-1250 mΩ), 17:Resistance (1-2200 mΩ))
RtdUtype_00 (Unit Types. 0:°C, 1:°F, 2:Ω)	RtdUtype_01 (Unit Types. 0:°C, 1:°F, 2:Ω)
RtdStatus_00	RtdStatus_01
RtdEnable_02 (0:Disable, 1:Enable)	RtdEnable_03 (0:Disable, 1:Enable)
RtdStype_02 (0:PT50, 1:Pt100, 2:Pt200, 3:Pt500, 4:Pt1000, 5:JPt100, 6:JPt200, 7:JPt500, 8:JPt1000, 9 :Ni 100, 10 :Ni 200, 11 :Ni 500, 12 :Ni 1000, 13 :Ni 120, 14 :Resistance (1-310 mΩ), 15:Resistance (1-620 mΩ), 16 :Resistance (1-1250 mΩ), 17:Resistance (1-2200 mΩ))	RtdStype_03 (0:PT50, 1:Pt100, 2:Pt200, 3:Pt500, 4:Pt1000, 5:JPt100, 6:JPt200, 7:JPt500, 8:JPt1000, 9 :Ni 100, 10 :Ni 200, 11 :Ni 500, 12 :Ni 1000, 13 :Ni 120, 14 :Resistance (1-310 mΩ), 15:Resistance (1-620 mΩ), 16 :Resistance (1-1250 mΩ), 17:Resistance (1-2200 mΩ))
RtdUtype_02 (Unit Types. 0:°C, 1:°F, 2:Ω)	RtdUtype_03 (Unit Types. 0:°C, 1:°F, 2:Ω)
RtdStatus_02	RtdStatus_03
RtdEnable_04 (0:Disable, 1:Enable)	RtdEnable_05 (0:Disable, 1:Enable)
RtdStype_04 (0:PT50, 1:Pt100, 2:Pt200, 3:Pt500, 4:Pt1000, 5:JPt100,	RtdStype_05 (0:PT50, 1:Pt100, 2:Pt200, 3:Pt500, 4:Pt1000, 5:JPt100,

6:JpT200, 7:JpT500, 8:JpT1000, 9 :Ni 100, 10 :Ni 200, 11 :Ni 500, 12 :Ni 1000, 13 :Ni 120, 14 :Resistance (1-310 mΩ), 15:Resistance (1-620 mΩ), 16 :Resistance (1-1250 mΩ), 17:Resistance (1-2200 mΩ))	6:JpT200, 7:JpT500, 8:JpT1000, 9 :Ni 100, 10 :Ni 200, 11 :Ni 500, 12 :Ni 1000, 13 :Ni 120, 14 :Resistance (1-310 mΩ), 15:Resistance (1-620 mΩ), 16 :Resistance (1-1250 mΩ), 17:Resistance (1-2200 mΩ))
RtdUtype_04 (Unit Types. 0:°C, 1:°F, 2:Ω)	RtdUtype_05 (Unit Types. 0:°C, 1:°F, 2:Ω)
RtdStatus_04	RtdStatus_05

Commands to get RTD Virtual Channel information	Commands to get RTD Virtual Channel information
RtdEnable_06 (0:Disable, 1:Enable)	RtdEnable_07 (0:Disable, 1:Enable)
RtdStype_06 (20:Average – For Virtual Channel only, 21: Deviation – For Virtual Channel Only)	RtdStype_07 (20:Average – For Virtual Channel only, 21: Deviation – For Virtual Channel Only)
RtdUtype_06 (Unit Types. 0:°C, 1:°F, 2:Ω)	RtdUtype_07 (Unit Types. 0:°C, 1:°F, 2:Ω)
RtdStatus_06	RtdStatus_07
RtdEnable_08 (0:Disable, 1:Enable)	RtdEnable_09 (0:Disable, 1:Enable)
RtdStype_08 (20:Average – For Virtual Channel only, 21: Deviation – For Virtual Channel Only)	RtdStype_09 (20:Average – For Virtual Channel only, 21: Deviation – For Virtual Channel Only)
RtdUtype_08 (Unit Types. 0:°C, 1:°F, 2:Ω)	RtdUtype_09 (Unit Types. 0:°C, 1:°F, 2:Ω)
RtdStatus_08	RtdStatus_09
RtdEnable_10 (0:Disable, 1:Enable)	RtdEnable_11 (0:Disable, 1:Enable)
RtdStype_10 (20:Average – For Virtual Channel only, 21: Deviation – For Virtual Channel Only)	RtdStype_11 (20:Average – For Virtual Channel only, 21: Deviation – For Virtual Channel Only)
RtdUtype_10 (Unit Types. 0:°C, 1:°F, 2:Ω)	RtdUtype_11 (Unit Types. 0:°C, 1:°F, 2:Ω)
RtdStatus_10	RtdStatus_11

Commands to get DO information	Commands to get DO information
DOMode_00 (0:DO, 1:PULSE OUTPUT)	DOMode_01 (0:DO, 1:PULSE OUTPUT)
DOStatus_00 (0:OFF, 1:ON)	DOStatus_01 (0:OFF, 1:ON)
DOLowWidth_00	DOLowWidth_01
DOHighWidth_00	DOHighWidth_01
DOPulseStart_00 (0:STOP, 1:START)	DOPulseStart_01 (0:STOP, 1:START)
DOMode_02 (0:DO, 1:PULSE OUTPUT)	DOMode_03 (0:DO, 1:PULSE OUTPUT)
DOStatus_02 (0:OFF, 1:ON)	DOStatus_03 (0:OFF, 1:ON)
DOLowWidth_02	DOLowWidth_03
DOHighWidth_02	DOHighWidth_03
DOPulseStart_02 (0:STOP, 1:START)	DOPulseStart_03 (0:STOP, 1:START)

Syntax to get the settings is as follows. Starting with the ioLogik's IP or URL, specify **setParam.cgi** with a question mark. Then specify the command with another question mark as the ending. Those commands are case sensitive and the **&** sign is used to combine multiple commands.

Commands to set RTD channels	Commands to set RTD channels
RtdEnable_00 (0:Disable, 1:Enable)	RtdEnable_01 (0:Disable, 1:Enable)
RtdStyle_00 (0:PT50, 1:Pt100, 2:Pt200, 3:Pt500, 4:Pt1000, 5:JPt100, 6:JPt200, 7:JPt500, 8:JPt1000, 9 :Ni 100, 10 :Ni 200, 11 :Ni 500, 12 :Ni 1000, 13 :Ni 120, 14 :Resistance (1-310 mΩ), 15:Resistance (1-620 mΩ), 16 :Resistance (1-1250 mΩ), 17:Resistance (1-2200 mΩ))	RtdStyle_01 (0:PT50, 1:Pt100, 2:Pt200, 3:Pt500, 4:Pt1000, 5:JPt100, 6:JPt200, 7:JPt500, 8:JPt1000, 9 :Ni 100, 10 :Ni 200, 11 :Ni 500, 12 :Ni 1000, 13 :Ni 120, 14 :Resistance (1-310 mΩ), 15:Resistance (1-620 mΩ), 16 :Resistance (1-1250 mΩ), 17:Resistance (1-2200 mΩ))
RtdUtype_00 (Unit Types. 0:°C, 1:°F, 2:Ω)	RtdUtype_01 (Unit Types. 0:°C, 1:°F, 2:Ω)
RtdEnable_02 (0:Disable, 1:Enable)	RtdEnable_03 (0:Disable, 1:Enable)
RtdStyle_02 (0:PT50, 1:Pt100, 2:Pt200, 3:Pt500, 4:Pt1000, 5:JPt100, 6:JPt200, 7:JPt500, 8:JPt1000, 9 :Ni 100, 10 :Ni 200, 11 :Ni 500, 12 :Ni 1000, 13 :Ni 120, 14 :Resistance (1-310 mΩ), 15:Resistance (1-620 mΩ), 16 :Resistance (1-1250 mΩ), 17:Resistance (1-2200 mΩ))	RtdStyle_03 (0:PT50, 1:Pt100, 2:Pt200, 3:Pt500, 4:Pt1000, 5:JPt100, 6:JPt200, 7:JPt500, 8:JPt1000, 9 :Ni 100, 10 :Ni 200, 11 :Ni 500, 12 :Ni 1000, 13 :Ni 120, 14 :Resistance (1-310 mΩ), 15:Resistance (1-620 mΩ), 16 :Resistance (1-1250 mΩ), 17:Resistance (1-2200 mΩ))
RtdUtype_02 (Unit Types. 0:°C, 1:°F, 2:Ω)	RtdUtype_03 (Unit Types. 0:°C, 1:°F, 2:Ω)
RtdEnable_04 (0:Disable, 1:Enable)	RtdEnable_05 (0:Disable, 1:Enable)
RtdStyle_04 (0:PT50, 1:Pt100, 2:Pt200, 3:Pt500, 4:Pt1000, 5:JPt100, 6:JPt200, 7:JPt500, 8:JPt1000, 9 :Ni 100, 10 :Ni 200, 11 :Ni 500, 12 :Ni 1000, 13 :Ni 120, 14 :Resistance (1-310 mΩ), 15:Resistance (1-620 mΩ), 16 :Resistance (1-1250 mΩ), 17:Resistance (1-2200 mΩ))	RtdStyle_05 (0:PT50, 1:Pt100, 2:Pt200, 3:Pt500, 4:Pt1000, 5:JPt100, 6:JPt200, 7:JPt500, 8:JPt1000, 9 :Ni 100, 10 :Ni 200, 11 :Ni 500, 12 :Ni 1000, 13 :Ni 120, 14 :Resistance (1-310 mΩ), 15:Resistance (1-620 mΩ), 16 :Resistance (1-1250 mΩ), 17:Resistance (1-2200 mΩ))
RtdUtype_04 (Unit Types. 0:°C, 1:°F, 2:Ω)	RtdUtype_05 (Unit Types. 0:°C, 1:°F, 2:Ω)

Commands to set RTD Virtual Channel information	Commands to set RTD Virtual Channel information
RtdStyle_06 (20:Average, 21: Deviation)	RtdStyle_07 (20:Average, 21: Deviation)
RtdUtype_06 (Unit Types. 0:°C, 1:°F, 2:Ω)	RtdUtype_07 (Unit Types. 0:°C, 1:°F, 2:Ω)
RtdStyle_08 (20:Average, 21: Deviation)	RtdStyle_09 (20:Average, 21: Deviation)
RtdUtype_08 (Unit Types. 0:°C, 1:°F, 2:Ω)	RtdUtype_09 (Unit Types. 0:°C, 1:°F, 2:Ω)
RtdStyle_10 (20:Average, 21: Deviation)	RtdStyle_11 (20:Average, 21: Deviation)
RtdUtype_10 (Unit Types. 0:°C, 1:°F, 2:Ω)	RtdUtype_11 (Unit Types. 0:°C, 1:°F, 2:Ω)

Commands to set DO channels	Commands to set DO Channels
DOMode_00 (0:DO, 1:PULSE OUTPUT)	DOMode_01 (0:DO, 1:PULSE OUTPUT)
DOSTatus_00 (0:OFF, 1:ON)	DOSTatus_01 (0:OFF, 1:ON)
DOLowWidth_00	DOLowWidth_01
DOHighWidth_00	DOHighWidth_01
DOPulseStart_00 (0:STOP, 1:START)	DOPulseStart_01 (0:STOP, 1:START)
DOMode_02 (0:DO, 1:PULSE OUTPUT)	DOMode_03 (0:DO, 1:PULSE OUTPUT)
DOSTatus_02 (0:OFF, 1:ON)	DOSTatus_03 (0:OFF, 1:ON)
DOLowWidth_02	DOLowWidth_03
DOHighWidth_02	DOHighWidth_03
DOPulseStart_02 (0:STOP, 1:START)	DOPulseStart_03 (0:STOP, 1:START)

F

Factory Default Settings

The ioLogik E2260 is configured with the following factory defaults:

Default IP Address:	192.168.127.254
Default Netmask:	255.255.255.0
Default Gateway:	0.0.0.0
Communication Watchdog:	Disable
RTD Mode:	PT 100
Unit:	Degree C
DO Mode:	DO
DO Safe Status:	Off
Power On Status:	Off
Low Width for Pulse:	1 × 5 ms
Hi Width for Pulse:	1 × 5 ms
Output Pulses:	0 (continuous)
Password:	NONE
Module Name:	NONE
Module Location:	NONE
SNMP:	Enable
Community:	Public
Contact:	NONE
Location:	NONE
Click&Go	NONE

Ethernet Port Pinouts

Pin	Signal
1	Tx+
2	Tx-
3	Rx+
6	Rx-

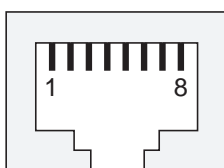

Serial Port Pinouts

E2260 RS-485 Network Adapter Pin Assignment

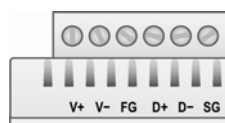

RTD Input Wiring

Structure

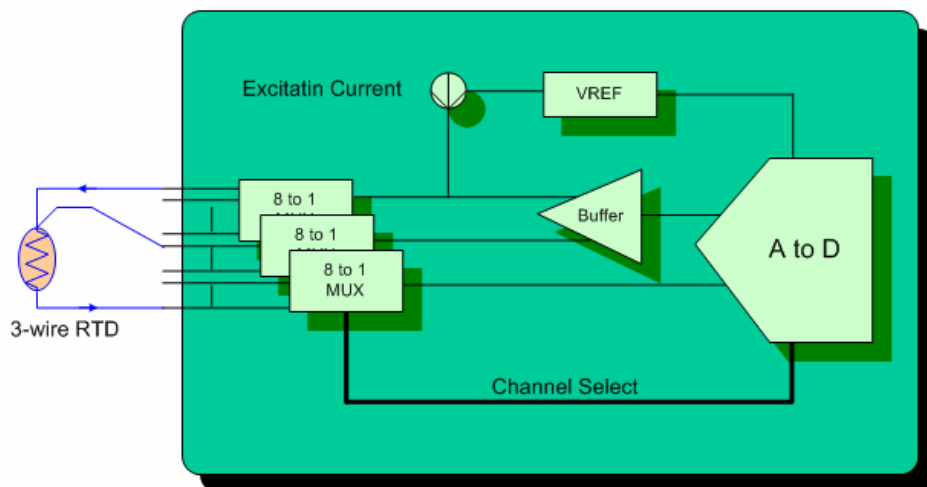

2-wire

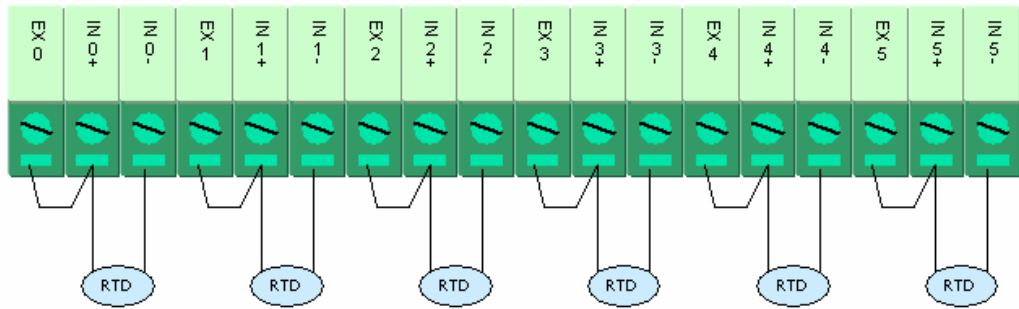

3-wire

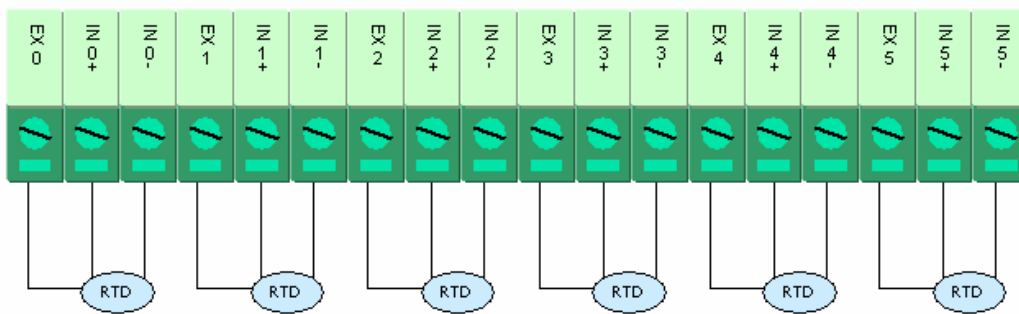

Digital Output

Structure

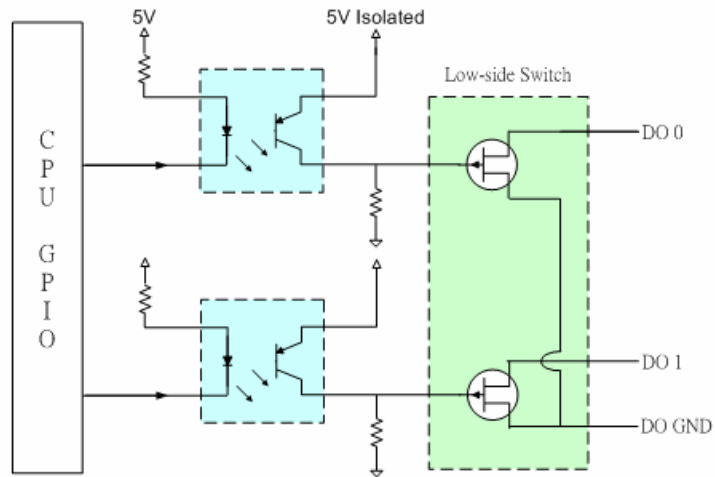

Output Channel

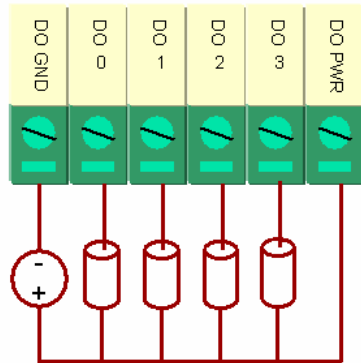

* DO PWR is for powering up the *field Power* LED.

Terminal Block Pin Assignments

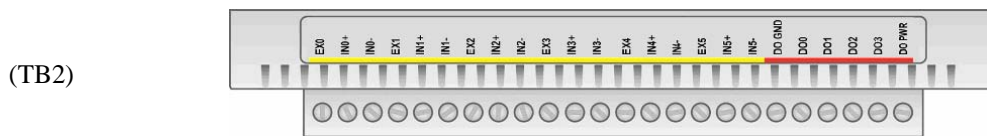

TB1

(Power Input)			(RS-485)		
1	2	3	4	5	6
V+ (12-48V)	V-	FG	Data+	Data-	SG

TB2

1	2	3	4	5	6	7	8	9	10	11	12	13	14	15	16	17	18	19	20	21	22	23	24
EX0	IN0+	IN0-	EX1	IN1+	IN1-	EX2	IN2+	IN2-	EX3	IN3+	IN3-	EX4	IN4+	IN4-	EX5	IN5+	IN5-	DO GND	DO 0	DO 1	DO 2	DO 3	DO PWR



Calibration

The ioLogik E2260 achieves accuracy in temperature measurements as follows:

1. At room temperature ($25 \pm 3^\circ\text{C}$), accuracy should be within 0.1% FSR. The measurement range of a PT-100 sensor is -200°C to 850°C . That means that readings are accurate to within $\pm 1.05^\circ\text{C}$. If an object's temperature is measured at 100°C , the actual temperature should be between 98.95°C and 101.05°C . A reading of 600°C would include temperatures between 598.95°C and 601.05°C .
2. At an ambient temperature of -10°C or 60°C , accuracy should be within 0.3% FSR. If an object's temperature is measured at 100°C the actual temperature should be between 96.85°C and 103.15°C . A reading of 600°C would include temperatures between 596.85°C and 603.15°C .

A calibrator, such as provided by Yokogawa or Fluke, is used for the standard signal source. These products allow Moxa to guarantee accurate measurements to within $\pm 0.1\%$ of FSR. The actual error rates may differ between products. For example, when measuring a 500°C object, one product might achieve accuracy to within 0.1°C , while another product may achieve accuracy to within 0.5°C .

Simple Verification at Your Site

Product specifications may be verified by using a qualified RTD sensor. The sensor can be placed into 0°C or 100°C water to see if the temperature readings are correct. A high precision resistor may also be used for measurement.

Verification with RTD Sensor

When using an RTD sensor, measurement errors are introduced through the sensor itself and through the analog-to-digital signal processing. For example, suppose that the RTD sensor introduces 0.05% error and the AD conversion introduces 0.1% error. For water at a 100°C , the measured temperature would fall somewhere within $100 \pm 1050 * (0.1\% + 0.05\%)$, or between 98.425°C and 101.575°C . The 1050 corresponds to the full range of the PT100 RTD sensor, which is -200°C to 850°C .

Therefore, with an RTD sensor that boasts accuracy within 0.05%, the measured temperature will be accurate to within 0.15% of FSR.

Verification with Precision Resistor

A resistor with Ohm input could be used for verification. Suppose that you use the ioLogik E2260, which is rated at 100Ω 1%, and select 1-310 Ω mode. The measured temperature would fall within $100 \pm (100 \times 1\% + 310 \Omega \times 0.1\%)$, or between 98.69Ω and 101.31Ω . The 310 corresponds to the full scale range of 1-310 Ω mode.