

NPort IA5450A Series User's Manual

First Edition, May 2010

www.moxa.com/product



© 2010 Moxa Inc. All rights reserved.
Reproduction without permission is prohibited.

NPort IA5450A Series User's Manual

The software described in this manual is furnished under a license agreement and may be used only in accordance with the terms of that agreement.

Copyright Notice

Copyright ©2010 Moxa Inc.
All rights reserved.
Reproduction without permission is prohibited.

Trademarks

The MOXA logo is a registered trademark of Moxa Inc.
All other trademarks or registered marks in this manual belong to their respective manufacturers.

Disclaimer

Information in this document is subject to change without notice and does not represent a commitment on the part of Moxa.

Moxa provides this document as is, without warranty of any kind, either expressed or implied, including, but not limited to, its particular purpose. Moxa reserves the right to make improvements and/or changes to this manual, or to the products and/or the programs described in this manual, at any time.

Information provided in this manual is intended to be accurate and reliable. However, Moxa assumes no responsibility for its use, or for any infringements on the rights of third parties that may result from its use.

This product might include unintentional technical or typographical errors. Changes are periodically made to the information herein to correct such errors, and these changes are incorporated into new editions of the publication.

Technical Support Contact Information

www.moxa.com/support

Moxa Americas

Toll-free: 1-888-669-2872
Tel: +1-714-528-6777
Fax: +1-714-528-6778

Moxa Europe

Tel: +49-89-3 70 03 99-0
Fax: +49-89-3 70 03 99-99

Moxa China (Shanghai office)

Toll-free: 800-820-5036
Tel: +86-21-5258-9955
Fax: +86-10-6872-3958

Moxa Asia-Pacific

Tel: +886-2-8919-1230
Fax: +886-2-8919-1231

Table of Contents

1. Introduction	1-1
Overview	1-2
Package Checklist	1-2
Product Features	1-2
Product Specifications	1-3
2. Getting Started	2-1
NPort IA5450A Series Appearance	2-2
Connecting the Hardware	2-2
Wiring Requirements	2-2
Connecting the Power	2-3
Grounding the NPort IA5450A Series	2-3
Connecting to the Network	2-3
Connecting to a Serial Device	2-3
LED Indicators	2-4
Pull-high/Pull-low and Terminator for RS-485	2-4
3. Initial IP Address Configuration	3-1
Initializing the NPort's IP Address	3-2
Factory Default IP Address	3-2
NPort Administration Suite	3-2
ARP	3-2
Telnet Console	3-3
Serial Console (19200, n, 8, 1)	3-6
4. Choosing the Proper Operation Mode	4-1
Overview	4-2
Real COM Mode	4-2
RFC2217 Mode	4-3
TCP Server Mode	4-3
TCP Client Mode	4-3
UDP Mode	4-4
Pair Connection Mode	4-4
Ethernet Modem Mode	4-4
Reverse Telnet Mode	4-5
Disabled Mode	4-5
5. Web Console Configuration	5-1
Opening Your Browser	5-2
Quick Setup	5-3
Export/Import	5-5
Basic Settings	5-6
Network Settings	5-7
Serial Settings	5-10
Operating Settings	5-12
Real COM Mode	5-12
RFC2217 Mode	5-15
TCP Server Mode	5-17
TCP Client Mode	5-20
UDP Mode	5-24
Pair Connection Mode	5-26
Ethernet Modem Mode	5-28
Reverse Telnet Mode	5-30
Disabled Mode	5-31
Accessible IP Settings	5-32
Auto Warning Settings	5-33
Auto warning: Email and SNMP trap	5-33
Event Type	5-34
Upgrade Firmware	5-36
Monitor	5-36
Monitor Line	5-36
Monitor Async	5-37
Monitor Async-Settings	5-37
Monitor Relay Output	5-38
Change Password	5-38
Load Factory Default	5-39
Save/Restart	5-39
6. Configuring NPort Administrator	6-1
Overview	6-2
Installing NPort Administrator	6-2

Configuration	6-4
Broadcast Search	6-5
Unlock Password Protection	6-6
Configuring the NPort IA5450A	6-7
Upgrading the Firmware	6-9
Export Configuration	6-10
Import Configuration	6-10
Monitor	6-11
Port Monitor	6-15
COM Mapping	6-15
On-line COM Mapping	6-16
Off-line COM Mapping	6-19
COM Grouping	6-20
Creating a COM Group	6-20
Deleting a COM Group	6-22
Adding a Port to a COM Group	6-24
Removing a Port from a COM Group	6-25
Modify Ports in a COM Group	6-27
Changing the COM Number of a COM Group	6-27
Changing Advanced Settings and Serial Parameters of the COM Group	6-29
Changing the Serial Port Specified as Signal Port for the COM Group	6-31
IP Address Report	6-32
7. IP Serial LIB	7-1
Overview	7-2
IP Serial LIB Function Groups	7-3
Example Program	7-3
A. Pinouts and Cable Wiring	A-1
Port Pinout Diagrams	A-2
Ethernet Port Pinouts	A-2
RS-232/422/485 (male DB9) Pinouts	A-2
Power Input and Relay Output Pinouts	A-2
Serial Cable Wiring Diagrams	A-3
Female DB9 to Male DB9	A-3
Female DB9 to Male DB25	A-3
B. Well Known Port Numbers	B-1
C. SNMP Agents with MIB II & RS-232 Like Groups	C-1
D. Auto IP Report Protocol	D-1
E. Compliance Notice	E-1

Introduction

Welcome to the NPort IA5400A Series of industrial serial device servers. In this manual, we refer to the four products in the series collectively as “NPort IA5450A Series.”

The four models in the NPort IA5450A Series are:

NPort IA5450A	4-port RS-232/422/485 industrial automation device server with serial/LAN/power surge protection, two 10/100BaseT(X) ports (1 IP), 0 to 60°C operating temperature
NPort IA5450A-T	4-port RS-232/422/485 industrial automation device server with serial/LAN/power surge protection, two 10/100BaseT(X) ports (1 IP), -40 to 75°C operating temperature
NPort IA5450AI	4-port RS-232/422/485 industrial automation device server with serial/LAN/power surge protection, two 10/100BaseT(X) ports (1 IP), 0 to 60°C operating temperature, 2KV isolation
NPort IA5450AI-T	4-port RS-232/422/485 industrial automation device server with serial/LAN/power surge protection, two 10/100BaseT(X) ports (1 IP), -40 to 75°C operating temperature, 2KV isolation

The following topics are covered in this chapter:

- ❑ **Overview**
- ❑ **Package Checklist**
- ❑ **Product Features**
- ❑ **Product Specifications**

Overview

Compared to previous NPort IA device servers, advanced NPort IA device servers have more rugged casing, connectors, mounting methods and surge protection. In addition to upgraded hardware, more flexible and user-friendly software is added to advanced NPort IA series device servers. The NPort IA5450A series of device servers deliver easy and reliable serial-to-Ethernet connectivity for the industrial automation market. The NPort IA5450A Series is designed to allow any serial device to connect to an Ethernet network. The compact size of NPort IA5450A device servers makes them an ideal choice for connecting RS-232/422/485 serial devices, such as PLCs, sensors, meters, motors, drives, barcode readers, and operator displays. The NPort IA5450A Series device servers come with compact casing and a DIN-Rail mounting kit.

NPort IA5450A serial device servers ensure the compatibility of network software that uses a standard network API (Winsock or BSD Sockets) by providing five modes: TCP Server, TCP Client, UDP, Pair Connection, Ethernet Modem, and Rtelnet. Thanks to NPort IA5450A Series' Real COM/TTY drivers, software that works with COM/TTY ports can be set up to work over a TCP/IP network, without modifying the serial COM software applications. This excellent feature preserves your software investment and lets you enjoy the benefits of networking your serial devices instantly.

NPort IA5450A serial device servers support automatic IP configuration protocols (DHCP, BOOTP) and manual configuration via a handy web browser console. Both methods ensure quick and effective installation. And with NPort IA5450A's Windows Utility, installation is very straightforward, since all system parameters can be stored and then copied to other device servers simultaneously.

Package Checklist

NPort IA5450A Series device servers are shipped with the following items:

Standard Accessories

- 1 NPort IA5450A serial device server
- Documentation & Software CD
- NPort IA5450A Series Quick Installation Guide
- Warranty Card

Optional Accessories

- DR-4524: 45W/2A DIN-Rail 24 VDC Power Supply with universal 85 to 264 VAC input
- DR-75-24: 75W/3.2A DIN-Rail 24 VDC Power Supply with universal 85 to 264 VAC input
- DR-120-24: 120W/5A DIN-Rail 24 VDC Power Supply with 88 to 132 VAC/176 to 264 VAC input by switch

NOTE: Notify your sales representative if any of the above items is missing or damaged.

Product Features

NPort IA5450A Series device servers have the following features:

- Make your serial devices Internet ready
- Versatile socket operating modes, including TCP Server, TCP Client, UDP, Reverse Telnet, RFC 2217, and Real COM driver
- 2- or 4-wire RS-485 with patented ADDC™ (Automatic Data Direction Control)
- Slim type, inch-wide industrial strength casing
- DIN-Rail or wall mountable
- Built-in Ethernet cascading ports for easy wiring (RJ45 only)
- Redundant dual DC power inputs
- Warning by relay output and E-mail

Product Specifications

Ethernet Interface

Number of Ports: 2

Speed: 10/100 Mbps, auto MDI/MDIX

Connector: 8-pin RJ45

Magnetic Isolation Protection: 1.5 KV built-in

Serial Interface

Number of Ports: 4

Serial Standards: RS-232/422/485

Connector: DB9 male for RS-232/422/485

Serial Line Protection:

- 15 KV ESD protection for all signals
- 2 KV isolation protection (NPort® IA5450AI, NPort® IA5450AI-T)
- 1 KV surge protection (Level 2)

RS-485 Data Direction Control: ADDC® (automatic data direction control)

Serial Communication Parameters

Data Bits: 5, 6, 7, 8

Stop Bits: 1, 1.5, 2

Parity: None, Even, Odd, Space, Mark

Flow Control: RTS/CTS and DTR/DSR (RS-232 only), XON/XOFF

Baudrate: 50 to 921.6 Kbps

Serial Signals

RS-232: TxD, RxD, RTS, CTS, DTR, DSR, DCD, GND

RS-422: Tx+, Tx-, Rx+, Rx-, GND

RS-485-4w: Tx+, Tx-, Rx+, Rx-, GND

RS-485-2w: Data+, Data-, GND

Software

Network Protocols: ICMP, IP, TCP, UDP, DHCP, BOOTP, Telnet, Rtelnet, DNS, SNMP, HTTP, SMTP, SNTP, IGMP

Configuration Options: Web Console, Serial Console, Telnet Console, Windows Utility

Windows Real COM Drivers: Windows 95/98/ME/NT/2000, Windows XP/2003/Vista/2008/7 x86/x64

Fixed TTY Drivers: SCO Unix, SCO OpenServer, UnixWare 7, UnixWare 2.1, SVR 4.2, QNX 4.25, QNX 6, Solaris 10, FreeBSD, AIX 5.x, HP-UX 11i

Linux Real TTY Drivers: Linux kernel 2.4.x, 2.6.x

Physical Characteristics

Housing: Metal

Weight: 0.56 kg (1.23 lb)

Dimensions: 45.8 x 134 x 105 mm (1.80 x 5.28 x 4.13 in)

Environmental Limits

Operating Temperature:

Standard Models: 0 to 60°C (32 to 140°F)

Wide Temp. Models: -40 to 75°C (-40 to 167°F)

Operating Humidity: 5 to 95% RH

Storage Temperature: -40 to 85°C (-40 to 185°F)

Power Requirements

Input Voltage: 12 to 48 VDC

Power Consumption:

NPort® IA5450A: 12 to 48 VDC, 374 mA @ 12 VDC; 184 mA @ 24 VDC

NPort® IA5450AI: 12 to 48 VDC, 512 mA @ 12 VDC; 242 mA @ 24 VDC

Regulatory Approvals

EMC: CE (EN55022 Class A, EN55024), FCC Part 15 Subpart B Class A

Safety: UL508, LVD

Hazardous Location: UL/cUL Class 1 Division 2 Groups A, B, C and D

ATEX: Class I, Zone 2

EMS:

EN61000-4-2 (ESD), Criteria B, Level 3

EN61000-4-3 (RS), Criteria A, Level 3

EN61000-4-4 (EFT), Criteria B, Level 4

EN61000-4-5 (Surge), Criteria B, Level 3 for power line, Level 2 for communication line

EN61000-4-6 (CS), Criteria A, Level 3

EN61000-4-8, Criteria A, Level 3

EN61000-4-11

Shock: IEC60068-2-27

Freefall: IEC60068-2-32

Vibration: IEC60068-2-6

Reliability

Alert Tools: Built-in buzzer and relay output

Automatic Reboot Trigger: Built-in WDT (watchdog timer)

Warranty

Warranty Period: 5 years

Details: See www.moxa.com/warranty

2

Getting Started

In this chapter, we give instructions on installing NPort IA5450A device servers. Software installation is covered in subsequent chapters.

The following topics are covered in this chapter:

- ▣ **NPort IA5450A Series Appearance**
- ▣ **Connecting the Hardware**
 - Wiring Requirements
 - Connecting the Power
 - Grounding the NPort IA5450A Series
 - Connecting to the Network
 - Connecting to a Serial Device
 - LED Indicators
 - Pull-high/Pull-low and Terminator for RS-485

NPort IA5450A Series Appearance

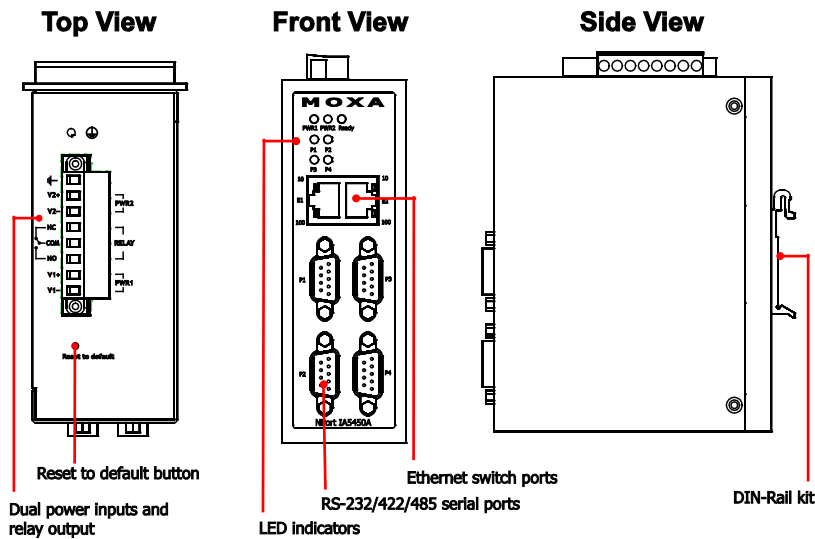

Connecting the Hardware

This section describes how to connect NPort IA5450A to serial devices for first time testing purposes. We cover **Wiring Requirements**, **Connecting the Power**, **Grounding NPort IA5450A Series**, **Connecting to the Network**, **Connecting to a Serial Device**, and **LED Indicators**.

Wiring Requirements



ATTENTION

Safety First!

Be sure to disconnect the power cord before installing and/or wiring your NPort IA5450A Series.

Wiring Caution!

Calculate the maximum possible current in each power wire and common wire. Observe all electrical codes dictating the maximum current allowable for each wire size.

If the current goes above the maximum ratings, the wiring could overheat, causing serious damage to your equipment.

Temperature Caution!

Please take care when handling NPort IA5450A. When plugged in, NPort IA5450A's internal components generate heat, and consequently the casing may feel hot to the touch. When installed with other components, make sure that there is at least 2 cm clearance on all sides of NPort IA5450A in order to allow proper heat dissipation.

You should heed the following:

- Use separate paths to route wiring for power and devices. If power wiring and device wiring paths must cross, make sure the wires are perpendicular at the intersection point.
NOTE: Do not run signal or communication wiring and power wiring in the same wire conduit. To avoid interference, wires with different signal characteristics should be routed separately.
- You can use the type of signal transmitted through a wire to determine which wires should be kept separate. The rule of thumb is that wiring that shares similar electrical characteristics can be bundled together.
- Keep input wiring and output wiring separate.
- Where necessary, it is strongly advised that you label wiring to all devices in the system.

Connecting the Power

Connect the 12-48 VDC power line with the NPort IA5450A's terminal block. If the power is properly supplied, the "Ready" LED will show a solid red color until the system is ready, at which time the "Ready" LED will change to a green color.

Grounding the NPort IA5450A Series

Grounding and wire routing helps limit the effects of noise caused by electromagnetic interference (EMI). Run the ground connection from the ground screw to the grounding surface prior to connecting devices.



ATTENTION

This product is intended to be mounted to a well-grounded mounting surface such as a metal panel.

SG: The Shielded Ground (sometimes called Protected Ground) contact is the left most contact of the 8 contact power terminal block connector when viewed from the angle shown here. Connect the SG wire to an appropriate grounded metal surface.

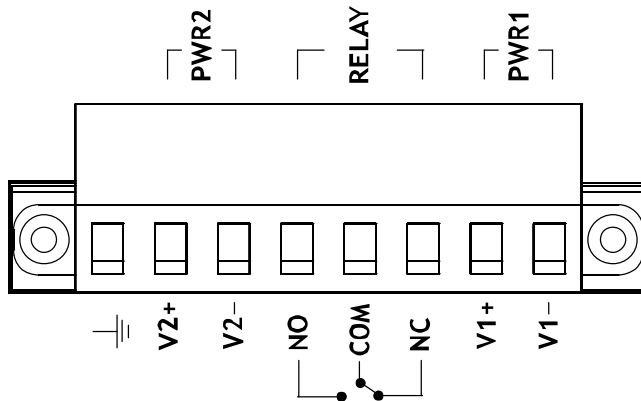

Connecting to the Network

Connect one end of the Ethernet cable to the NPort IA5450A's 10/100M Ethernet port and the other end of the cable to the Ethernet network. If the cable is properly connected, the NPort IA5450A will indicate a valid connection to the Ethernet in the following ways:

- The Ethernet LED maintains a solid green color when connected to a 100 Mbps Ethernet network.
- The Ethernet LED maintains a solid orange color when connected to a 10 Mbps Ethernet network.
- The Ethernet LED will flash when Ethernet packets are being transmitted or received.



ATTENTION

NPort IA5450A Series has 2 Ethernet ports, which can be used to create an open chain of NPort IA5450A device servers. You must be careful not to connect the Ethernet ports of the two device servers at the ends of the chain. In other words, NPort IA5450A does NOT support a closed chain.

Connecting to a Serial Device

Connect the serial data cable between NPort IA5450A and the serial device. Serial data cables are optional accessories for NPort.

LED Indicators

The top panels of all NPort IA5450A have four LED indicators, as described in the following table.

LED Name	LED Color	LED Function	
PWR1, PWR2	red	Power is being supplied to power input PWR1, PWR2.	
Ready	red	Steady on:	Power is on and NPort IA5450A is booting up.
		Blinking:	Indicates an IP conflict, or DHCP or BOOTP server did not respond properly, or a relay output occurred. When the above two conditions occur at the same time, check the relay output first. If after resolving the relay output the Ready LED is still blinking, then there is an IP conflict, or the DHCP or BOOTP server did not respond properly.
	green	Steady on:	Power is on and NPort IA5450A is functioning normally.
		Blinking:	The device server has been located by Administrator's Location function.
	off	Power is off, or power error condition exists.	
E1, E2	orange	10 Mbps Ethernet connection.	
	green	100 Mbps Ethernet connection.	
	off	Ethernet cable is disconnected, or has a short.	
P1, P2, P3, P4	orange	Serial port is receiving data.	
	green	Serial port is transmitting data.	
	off	No data is being transmitted or received through the serial port.	

Pull-high/Pull-low and Terminator for RS-485

Please follow the instructions below to change pull high/low DIP switch settings.

Step 1: Remove the case



Step 2: Remove the first tier



Step 3: Remove the 4 pillars



Step 4: Pull high/low DIP switches are located on the backside of the board

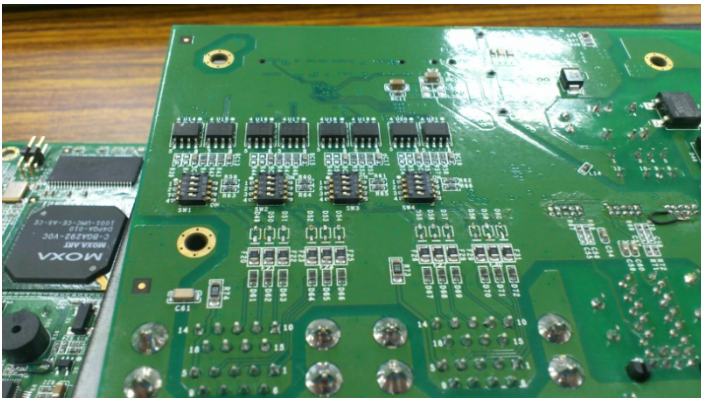

The functions of SW1~3 are shown in the table below, SW4 is reserved

Pull high/low resistors for the RS-485 Port

SW	1	2	3
		Pull High	Pull Low
ON	1 K Ω	1 K Ω	120 Ω
Default OFF	150 K Ω	150 K Ω	---

Initial IP Address Configuration

When setting up your NPort IA5450A for the first time, the first thing you should do is configure the IP address. This chapter introduces the methods that can be used to configure the device server's IP address. **Select one of the initial IP Address configuration methods to configure NPort IA5450A's IP Address.** For more details about network settings, see the **Network Settings** section from **Chapter 5, Web Console Configuration**.

The following topics are covered in this chapter:

- ❑ **Initializing the NPort's IP Address**
- ❑ **Factory Default IP Address**
- ❑ **NPort Administration Suite**
- ❑ **ARP**
- ❑ **Telnet Console**
- ❑ **Serial Console (19200, n, 8, 1)**

Initializing the NPort's IP Address

1. Determine whether your NPort IA5450A needs to use a Static IP or Dynamic IP (either DHCP or BOOTP application).
2. **If the NPort IA5450A is used in a Static IP environment**, you can use NPort Administration Suite, ARP, Web Console, Telnet Console, or Serial Console to configure the new IP address.
3. **If the NPort IA5450A is used in a Dynamic IP environment**, you can use NPort IA5450A Administration Suite, Web Console, Telnet Console, or Serial Console to configure NPort IA5450A to get an IP address dynamically with DHCP, DHCP/BOOTP, or BOOTP.



ATTENTION

Consult your network administrator on how to reserve a fixed IP address for your NPort IA5450A in the MAC-IP mapping table when using a DHCP Server or BOOTP Server. In most applications, you should assign a fixed IP address to your NPort IA5450A.

Factory Default IP Address

NPort IA5450A products are configured with the following default private IP address:

Default IP address: 192.168.127.254

(IP addresses of the form 192.168.xxx.xxx are referred to as private IP addresses, since it is not possible to directly access a device configured with a private IP address from a public network. For example, you would not be able to ping such a device from an outside Internet connection. NPort IA5450A applications that require sending data over a public network, such as the Internet, require setting up the server with a valid public IP address, which can be leased from a local ISP.)

NPort Administration Suite

NPort Administration Suite consists of some useful utility programs that are used to configure and manage your NPort IA5450A.

See Chapter 5 for details on how to install NPort Administration Suite, and how to use this suite of useful utilities to set up IP addresses and configure your NPort IA5450A Series serial device servers.

ARP

You can make use of the ARP (Address Resolution Protocol) command to set up an IP address for your NPort IA5450A. The ARP command tells your computer to associate the NPort IA5450A's MAC address with the intended IP address. You must then use Telnet to access the NPort IA5450A, at which point the device server's IP address will be reconfigured.



ATTENTION

In order to use this setup method, both your computer and NPort IA5450A must be connected to the same LAN. Or, you may use a cross-over Ethernet cable to connect the NPort IA5450A directly to your computer's Ethernet card. Before executing the ARP command, your NPort IA5450A must be configured with the factory default IP address (192.168.127.254), and your computer and the NPort IA5450A must be on the same subnet.

Take the following steps to use ARP to configure the IP address:

1. Obtain a valid IP address for your NPort IA5450A from your network administrator.
2. Obtain the NPort IA5450A's MAC address from the label on its bottom panel.
3. Execute the 'arp -s' command from your computer's MS-DOS prompt by typing:

```
arp -s 192.168.200.100 00-90-E8-xx-xx-xx
```

This is where 192.168.200.100 is the new IP address and 00-90-E8-xx-xx-xx is the MAC address for your NPort IA5450A. (Be sure to use the actual IP address and MAC address for your NPort IA5450A.)

4. Next, execute a special Telnet command by typing:

```
telnet 192.168.200.100 6000
```

After issuing this command, a Connect failed message will appear, as shown here. After the NPort reboots, its IP address should be updated to the new address, and you can reconnect using either Telnet, Web, or Administrator to check that the update was successful.

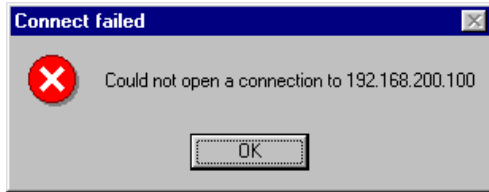

Telnet Console

Depending on how your computer and network are configured, you may find it convenient to use network access to set up your NPort IA5450A's IP address. This can be done using Telnet.



ATTENTION

Figures in this chapter were generated using the NPort IA5450AI.

1. From the Windows desktop, click on **Start** and then select **Run**.
2. Type **telnet 192.168.127.254** (use the correct IP address if different from the default) in the Open text input box, and then click **OK**.

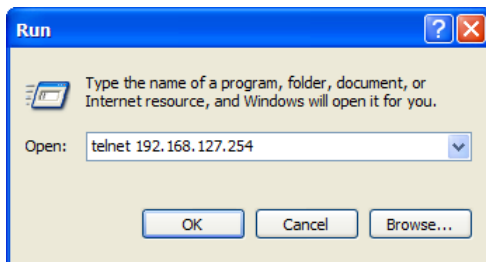

3. When the Telnet window opens, if you are prompted to input the Console password, input the password and then press **Enter**.

Note that this page will only appear if the NPort is password protected.

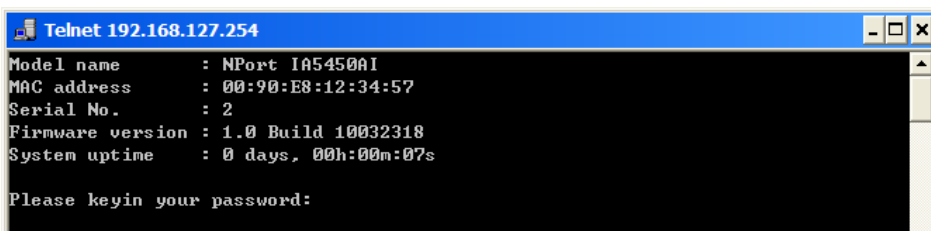

4. Type **2** to select Network settings, and then press **Enter**.

```
<< Main menu >>
(1) Basic settings
(2) Network settings
(3) Serial settings
(4) Operating settings
(5) Accessible IP settings
(6) Auto warning settings
(7) Monitor
(8) Ping
(9) Change password
(a) Load factory default
(v) View settings
(s) Save/Restart
(q) Quit

Key in your selection: 2_
```

5. Type **1** to select IP address and then press **Enter**.

```
<< Main menu->Network settings >>
(1) IP address
(2) Netmask
(3) Gateway
(4) IP configuration
(5) DNS server 1
(6) DNS server 2
(7) SNMP
(8) SNMP community name
(9) SNMP contact
(a) SNMP location
(b) Auto IP report to IP
(c) Auto IP report to UDP port
(d) Auto IP report period
(v) View settings
(m) Back to main menu
(q) Quit

Key in your selection: 1
```

6. Use the **Backspace** key to erase the current IP address, type in the **new IP address**, and then press **Enter**.

```
<< Main menu->Network settings >>
(1) IP address
(2) Netmask
(3) Gateway
(4) IP configuration
(5) DNS server 1
(6) DNS server 2
(7) SNMP
(8) SNMP community name
(9) SNMP contact
(a) SNMP location
(b) Auto IP report to IP
(c) Auto IP report to UDP port
(d) Auto IP report period
(v) View settings
(m) Back to main menu
(q) Quit

Key in your selection: 1
IP address: 192.168.127.253
```

7. Press any key to continue...

```

<< Main menu->Network settings >>
(1) IP address
(2) Netmask
(3) Gateway
(4) IP configuration
(5) DNS server 1
(6) DNS server 2
(7) SNMP
(8) SNMP community name
(9) SNMP contact
(a) SNMP location
(b) Auto IP report to IP
(c) Auto IP report to UDP port
(d) Auto IP report period
(v) View settings
(m) Back to main menu
(q) Quit

Key in your selection: 1
IP address: 192.168.127.253
Set IP address success

Press any key to continue...

```

8. Type **m** and then press **Enter** to return to the main menu.

```

<< Main menu->Network settings >>
(1) IP address
(2) Netmask
(3) Gateway
(4) IP configuration
(5) DNS server 1
(6) DNS server 2
(7) SNMP
(8) SNMP community name
(9) SNMP contact
(a) SNMP location
(b) Auto IP report to IP
(c) Auto IP report to UDP port
(d) Auto IP report period
(v) View settings
(m) Back to main menu
(q) Quit

Key in your selection: m

```

9. Type **s** and then press **Enter** to Save/Restart the system.

```

Model name       : NPort IA5450AI
MAC address      : 00:90:E8:12:34:57
Serial No.       : 2
Firmware version : 1.0 Build 10032318
System uptime    : 0 days, 00h:06m:48s
-----
<< Main menu >>
(1) Basic settings
(2) Network settings
(3) Serial settings
(4) Operating settings
(5) Accessible IP settings
(6) Auto warning settings
(7) Monitor
(8) Ping
(9) Change password
(a) Load factory default
(v) View settings
(s) Save/Restart
(q) Quit

Key in your selection: s

```

10. Type **y** and then press **Enter** to save the new IP address and restart the NPort IA5450A.

```

Save change?
(y) Yes
(n) No

Key in your selection: y

```

Serial Console (19200, n, 8, 1)

You may use the RS-232 console port to set up the IP address for NPort IA5450A. We suggest using PComm Terminal Emulator, which is available free of charge as part of the PComm Lite program suite, to carry out the installation procedure, although other similar utilities may also be used.



ATTENTION

The **Serial Console** is at serial port 1 of the NPort IA5450A Series, with RS-232 mode.

Before you start to configure the NPort IA5450A via serial console, turn off the power and connect the serial cable from NPort IA5450A to your computer's serial port.

1. Connect NPort IA5450A's serial port 1 directly to your computer's male RS-232 serial port.
2. From the Windows desktop click on **Start → Programs → PComm Lite → Terminal Emulator**.
3. When the PComm Terminal Emulator window opens, first click on the **Port Manager** menu item and select **Open**, or simply click on the Open icon.

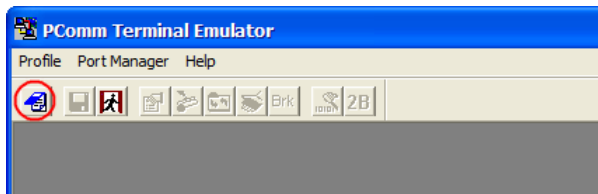

4. The Property window opens automatically. From the **Communication Parameter** page, select the appropriate COM port for the connection, COM1 in this example, and 19200 for Baud Rate, 8 for Data Bits, None for Parity, and 1 for Stop Bits.
5. From the **Property** window's Terminal page, select **ANSI** or **VT100** for **Terminal Type** and then click **OK**.
Note: If you select Dumb Terminal as the terminal type, some of the console functions—especially the "Monitor" function—may not work properly.

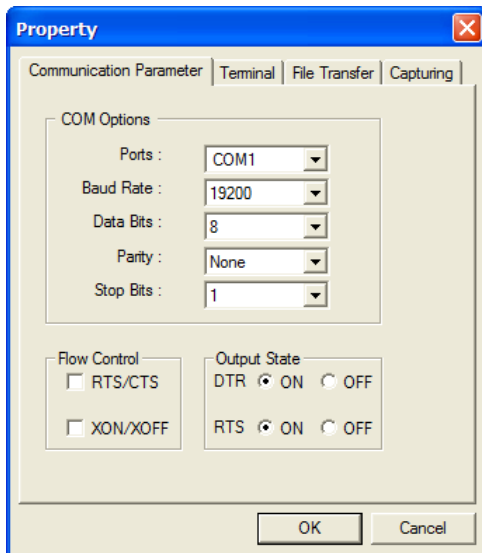

6. Press the " ` " key continuously and then power on the NPort IA5450A.

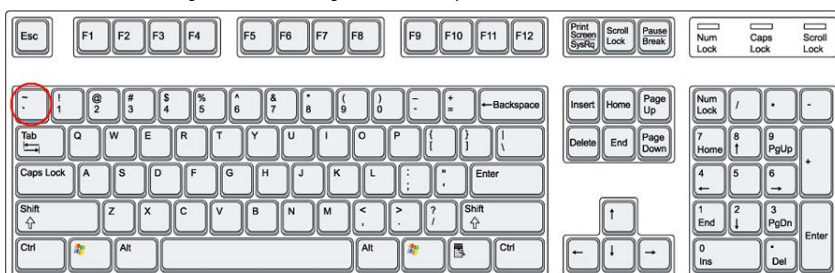

7. The NPort IA5450A will automatically switch from data mode to console mode as it receives a continuous string of “ ` ” characters.
8. Input the **password** when prompted. Note that this page will only appear when the NPort IA5450A has been set up for password protection.

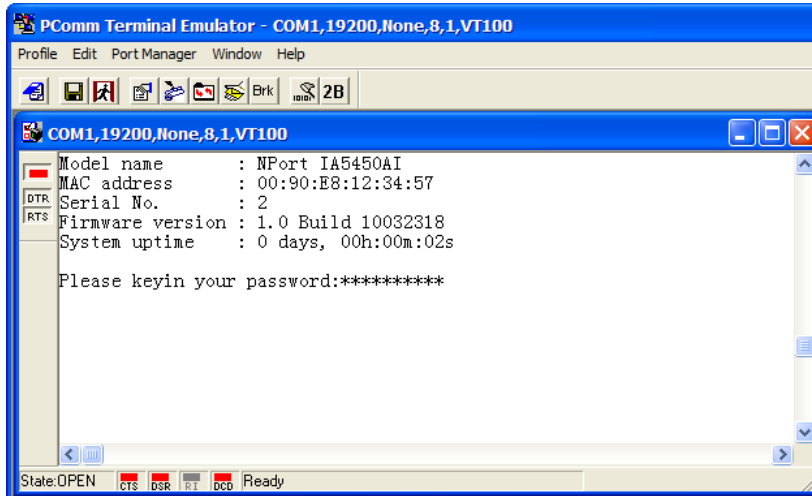

9. Start configuring the IP address under Network Settings. Refer to step 4 in the Telnet Console section for the rest of the IP settings.

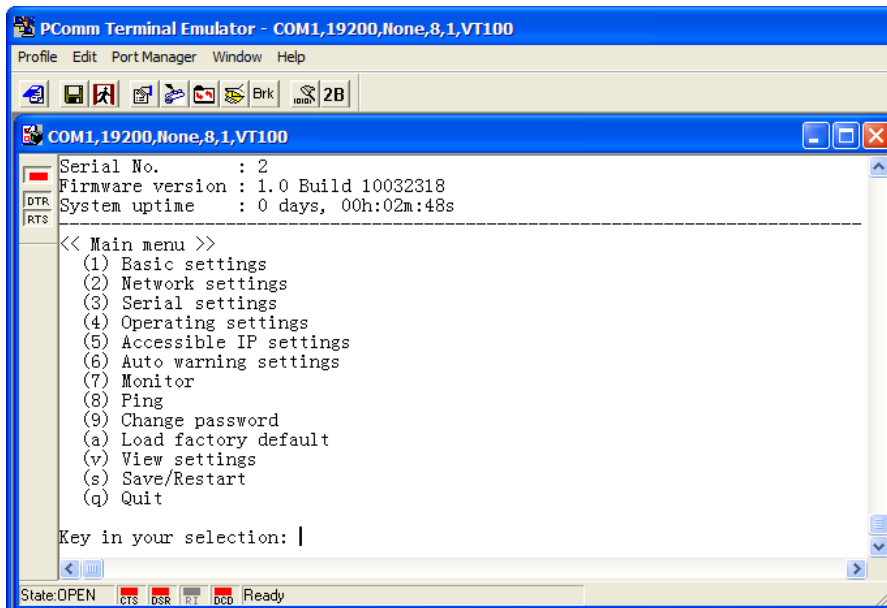

Choosing the Proper Operation Mode

In this chapter, we describe the various NPort IA5450A operation modes. The options include an operation mode that uses a driver installed on the host computer, and operation modes that rely on TCP/IP socket programming concepts. After choosing the proper operation mode in this chapter, refer to Chapter 5 for detailed configuration parameter definitions.

The following topics are covered in this chapter:

- ❑ **Overview**
- ❑ **Real COM Mode**
- ❑ **RFC2217 Mode**
- ❑ **TCP Server Mode**
- ❑ **TCP Client Mode**
- ❑ **UDP Mode**
- ❑ **Pair Connection Mode**
- ❑ **Ethernet Modem Mode**
- ❑ **Reverse Telnet Mode**
- ❑ **Disabled Mode**

Overview

NPort IA5450A Serial Device Servers network-enable traditional RS-232/422/485 devices, in which a Serial Device Server is a tiny computer equipped with a CPU, real-time OS, and TCP/IP protocols that can bi-directionally translate data between the serial and Ethernet formats. Your computer can access, manage, and configure remote facilities and equipment over the Internet from anywhere in the world.

Traditional SCADA and data collection systems rely on serial ports (RS-232/422/485) to collect data from various kinds of instruments. Since NPort IA5450A Serial Device Servers network-enable instruments equipped with an RS-232/422/485 communication port, your SCADA and data collection system will be able to access all instruments connected to a standard TCP/IP network, regardless of whether the devices are used locally or at a remote site.

NPort IA5450A is an external IP-based network device that allows you to expand the number of serial ports for a host computer on demand. As long as your host computer supports the TCP/IP protocol, you won't be limited by the host computer's bus limitation (such as ISA or PCI), or lack of drivers for various operating systems.

In addition to providing socket access, NPort IA5450A also comes with a Real COM/TTY driver that transmits all serial signals intact. This means that your existing COM/TTY-based software can be preserved, without needing to invest in additional software.

Three different Socket Modes are available: TCP Server, TCP Client, and UDP Server/Client. The main difference between the TCP and UDP protocols is that TCP guarantees delivery of data by requiring the recipient to send an acknowledgement to the sender. UDP does not require this type of verification, making it possible to offer speedier delivery. UDP also allows unicast or multicast of data to only one IP or groups of IP addresses.

Real COM Mode

NPort IA5450A comes equipped with COM drivers that work with Windows 95/98/ME/NT/2000/XP//2003/Vista/2008/7/XP x64/2003 x64/Vista x64/2008 x64/7 x64 systems, and also TTY drivers for Linux or Unix systems. The driver establishes a transparent connection between host and serial device by mapping the IP:Port of the NPort IA5450A's serial port to a local COM/TTY port on the host computer. Real COM Mode also supports up to 8 simultaneous connections, so that multiple hosts can collect data from the same serial device at the same time.

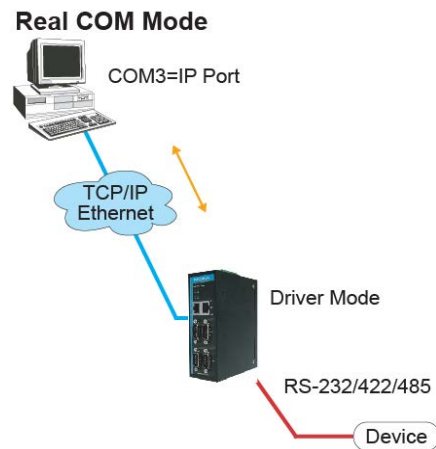



ATTENTION

The driver used for Real COM Mode comes with the NPort Administrator. The driver is installed automatically on your computer when you install NPort Administration Suite.

One of the major conveniences of using Real COM Mode is that Real COM Mode allows users to continue using RS-232/422/485 serial communications software that was written for pure serial communications applications. The driver intercepts data sent to the host's COM port, packs it into a TCP/IP packet, and then redirects it through the host's Ethernet card. At the other end of the connection, the NPort IA5450A accepts the Ethernet frame, unpacks the TCP/IP packet, and then transparently sends it to the appropriate serial device attached to one of the NPort IA5450A's serial ports.

**ATTENTION**

Real COM Mode allows several hosts to have access control over the same NPort IA5450A. The driver that comes with your NPort IA5450A controls host access to attached serial devices by checking the host's IP address. Refer to Accessible IP Settings in Chapter 5 for more details.

RFC2217 Mode

RFC2217 mode is similar to Real COM mode in that a driver is used to establish a transparent connection between a host computer and a serial device by mapping the serial port on the NPort IA5450A to a local COM port on the host computer. RFC2217 defines general COM port control options based on the Telnet protocol. Third party drivers that support RFC2217 are widely available on the Internet and can be used to implement Virtual COM mapping to your NPort IA5450A serial port(s).

TCP Server Mode

In TCP Server mode, NPort IA5450A is configured with a unique IP:Port address on a TCP/IP network. NPort IA5450A waits passively to be contacted by the host computer, allowing the host computer to establish a connection with and get data from the serial device. This operation mode also supports up to 8 simultaneous connections, so that multiple hosts can collect data from the same serial device—at the same time.

As illustrated in the figure, data transmission proceeds as follows:

1. The host requests a connection from the NPort IA5450A configured for TCP Server Mode.
2. Once the connection is established, data can be transmitted in both directions—from the host to the NPort IA5450A, and from the NPort IA5450A to the host.

TCP Server Mode

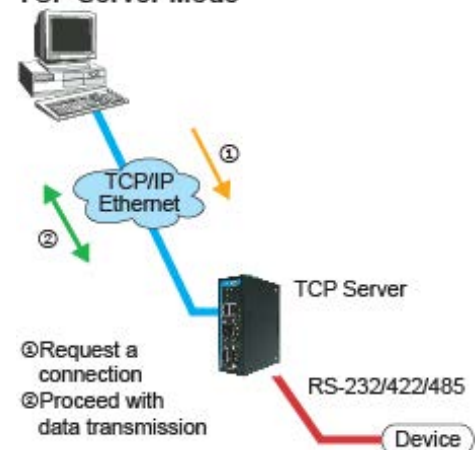

TCP Client Mode

In TCP Client mode, the NPort IA5450A can actively establish a TCP connection to a pre-defined host computer when serial data arrives.

After the data has been transferred, the NPort can automatically disconnect from the host computer by using the **TCP alive check time** or **Inactivity time** settings. Refer to chapter 5 for more details.

As illustrated in the figure, data transmission proceeds as follows:

1. The NPort IA5450A configured for TCP Client Mode requests a connection from the host.
2. Once the connection is established, data can be transmitted in both directions—from the host to the NPort IA5450A, and from the NPort IA5450A to the host.

TCP Client Mode

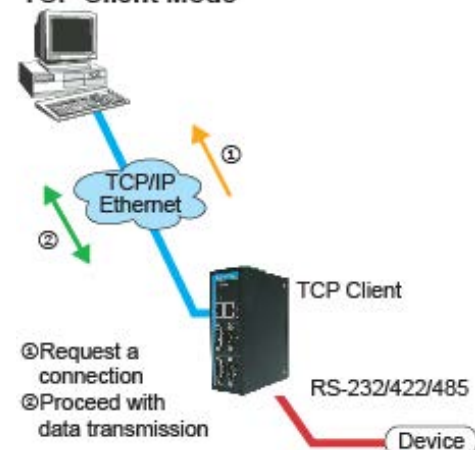

UDP Mode

Compared to TCP communication, UDP is faster and more efficient. In UDP mode, you can not only unicast but also multicast data from the serial device to multiple host computers, and the serial device can also receive data from multiple host computers, making this mode ideal for message display applications.

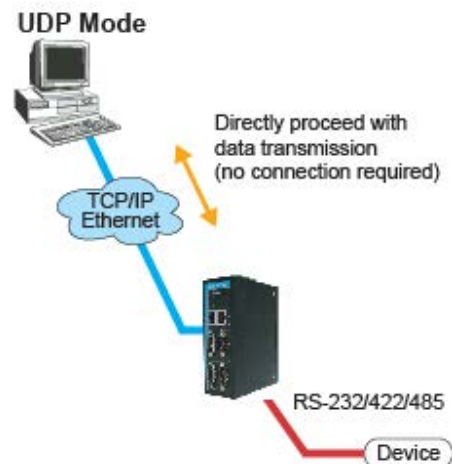

Pair Connection Mode

Pair Connection Mode employs two NPort IA5450A units in tandem, and can be used to remove the 15-meter distance limitation imposed by the RS-232 interface. One NPort IA5450A is connected from its RS-232 port to the COM port of a PC or other type of computer, such as a hand-held PDA, and the serial device is connected to the RS-232 port of the other NPort IA5450A. The two NPort IA5450A units are then connected to each other with a cross-over Ethernet cable, both are connected to the same LAN, or in a more advanced setup, they communicate with each other over a WAN (i.e., through one or more routers). Pair Connection Mode transparently transfers both data and modem control signals (although it cannot transmit the DCD signal) between the two NPort device servers.

Ethernet Modem Mode

Ethernet Modem Mode is designed for use with legacy operating systems, such as MS-DOS, that do not support TCP/IP Ethernet. By connecting one of NPort IA5450A's serial port to the MS-DOS computer's serial port, it is possible to use legacy software originally designed to transmit data via modem, but now transmit the data over the Ethernet.

Reverse Telnet Mode

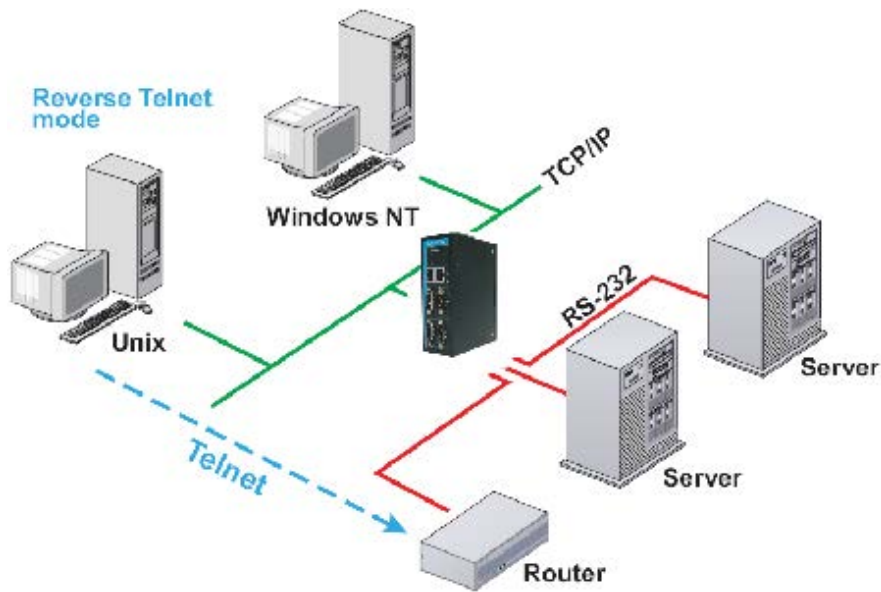

Console management is commonly used by connecting to Console/AUX or COM ports of routers, switches, and UPS units. Rtelnet works the same as RAW mode in that only one TCP port is listened to after booting up. The system then waits for a host on the network to initiate a connection. The difference is that the RAW mode does not provide the conversion function provided by Telnet. If the connected devices need to use the CR/LF conversion function when controlling, then users must choose Rtelnet mode.

Disabled Mode

When the Operation Mode for a particular port is set to **Disabled**, that port will be disabled.

Web Console Configuration

The Web Console is the most user-friendly of the methods available to configure the NPort IA5450A. In this chapter, we introduce the Web Console function groups and function definitions.

The following topics are covered in this chapter:

- ❑ **Opening Your Browser**
- ❑ **Quick Setup**
- ❑ **Export/Import**
- ❑ **Basic Settings**
- ❑ **Network Settings**
- ❑ **Serial Settings**
- ❑ **Operating Settings**
 - Real COM Mode
 - RFC2217 Mode
 - TCP Server Mode
 - TCP Client Mode
 - UDP Mode
 - Pair Connection Mode
 - Ethernet Modem Mode
 - Reverse Telnet Mode
 - Disabled Mode
- ❑ **Accessible IP Settings**
- ❑ **Auto Warning Settings**
 - Auto warning: Email and SNMP trap
 - Event Type
- ❑ **Upgrade Firmware**
- ❑ **Monitor**
 - Monitor Line
 - Monitor Async
 - Monitor Async-Settings
 - Monitor Relay Output
- ❑ **Change Password**
- ❑ **Load Factory Default**
- ❑ **Save/Restart**

Opening Your Browser

1. Make sure your browser has cookies enabled. To enable cookies in Internet Explorer, right click on the Internet Explorer icon on your desktop, select Properties, click on the Security tab, and then select Enable under Allow cookies that are stored on your computer, Allow per-session cookies (not stored), and File download.

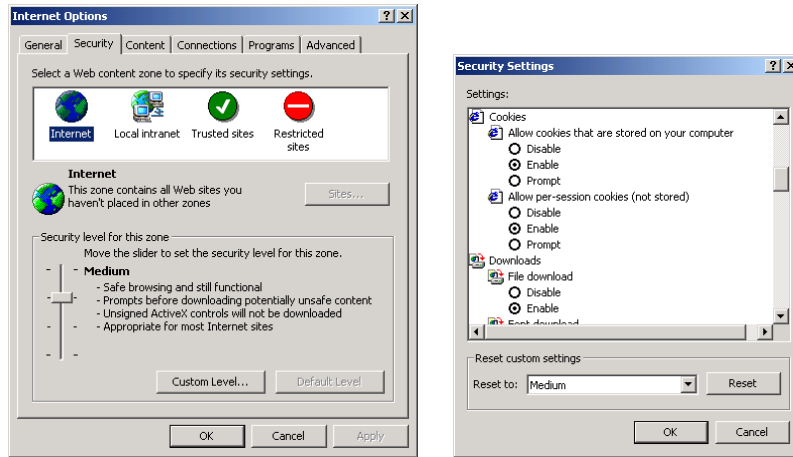

2. Enter the IP address of your device in the address field of the browser, then press the Enter key. The default IP address is **192.168.127.254**.
3. Input the password if prompted. The password will be transmitted with MD5 encryption over Ethernet. Note that you will not be prompted to enter the password if the NPort IA5450A is not currently password-protected.

MOXA® Total Solution for Industrial Device Networking www.moxa.com

Model	- NPort IA5450AI	IP	- 192.168.127.254	MAC Address	- 00:90:E8:12:34:57
Name	- NP1A5450AI_2	Serial NO.	- 2	Firmware	- 1.0 Build 10032318

Password:



ATTENTION

If you use other web browsers, remember to enable the functions to “allow cookies that are stored on your computer” or “allow per-session cookies.”
NPort IA5450A uses cookies only for password transmission.



ATTENTION

Refer to Chapter 3, **Initial IP Address Configuration**, to see how to configure the IP address. Examples shown in this chapter use the Factory Default IP address (192.168.127.254).

4. The NPort IA5450A homepage will open next. There are two buttons on this page: **Quick setup** and **Export/Import**. You can click **Overview** at any time to go back to this page. The following sections introduce these two convenient functions and all the other specific settings in the **Main Menu** on the left.



ATTENTION

If you can't remember the password, the **ONLY** way to configure the NPort IA5450A is to load factory defaults by using the "Reset to default" button located at the top side of NPort IA5450A. Remember to export the configuration file when you have finished the configuration. After using the "Reset to default" button to load factory defaults, your configuration can be easily reloaded into the NPort IA5450A with the **Import** function.



ATTENTION

If your NPort IA5450A application requires using password protection, you must enable the cookie function in your browser. If the cookie function is disabled, you will not be allowed to enter the Web Console Screen.

Quick Setup

Quick Setup streamlines configuration of your NPort into three basic and quick steps that covers the most commonly-used settings. At any time while in Quick Setup you may click the **Back** button to return to the previous step, or the **Cancel** button to reverse all settings. For more detailed settings, please refer to the "Basic Settings," "Network Settings," "Serial Settings," and "Operating Settings," sections later in this chapter.

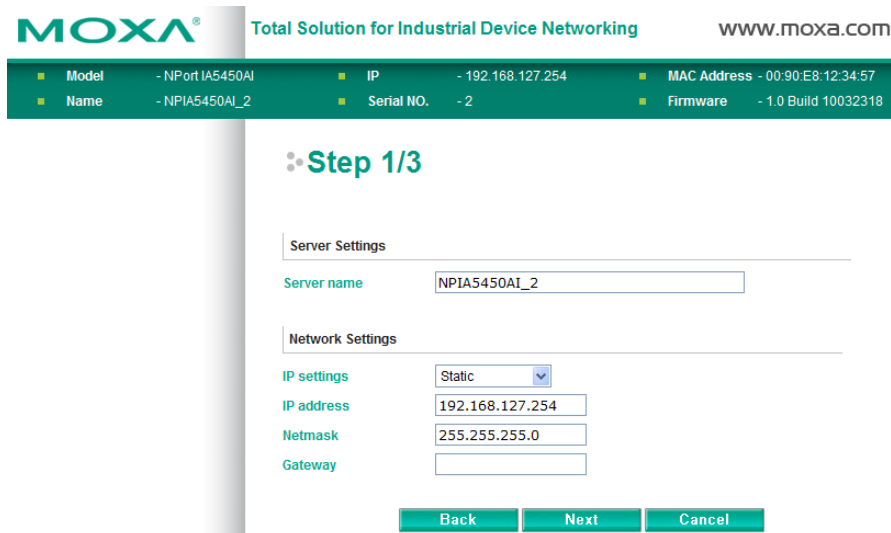

In Step 1/3, you must assign a valid IP address to the NPort IA5450A before it will work in your network environment. Your network system administrator should provide you with an IP address and related settings for your network. In addition, the server name field is a useful way to specify the location or application of different NPort IA5450As.

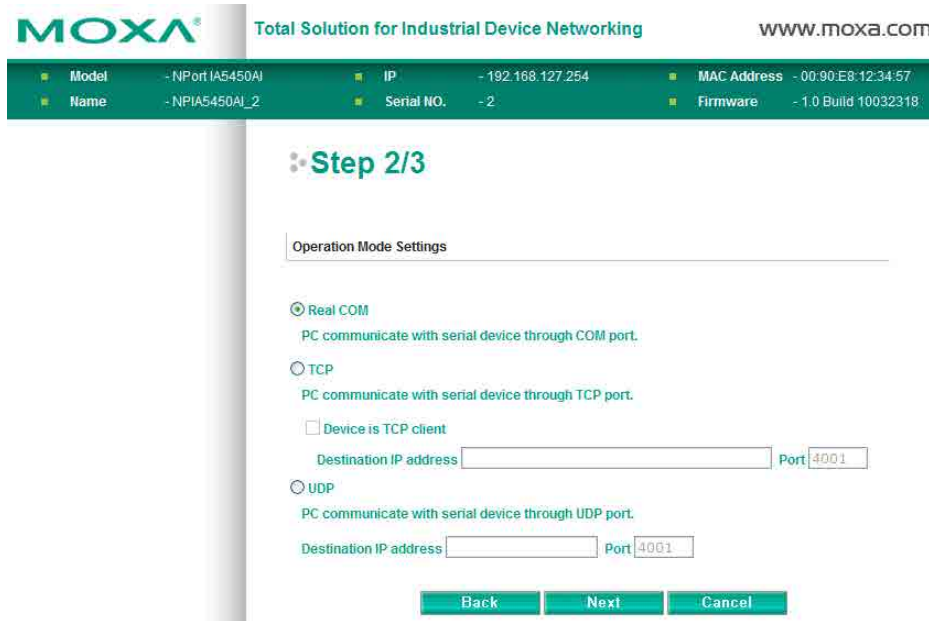

In the Step 2/3, you must specify which operation mode you will use. If your operation mode is not **Real COM**, **TCP Server**, **TCP Client** or **UDP mode**, please click **Cancel** and to go back to main menu and choose **Operating Settings** to select your proper setting.

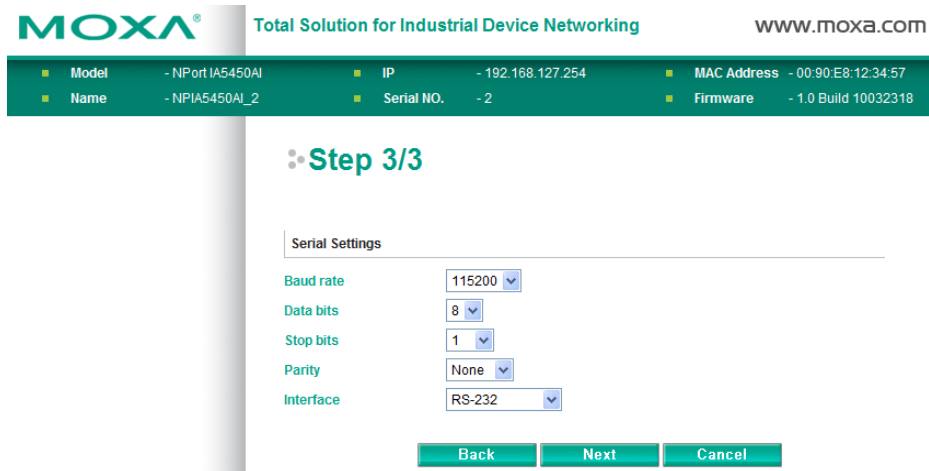

In the Step 3/3, you can modify the serial settings.

Review your settings at the **Finish Settings** page to confirm that they are correct, and then click the **Save/Restart** button to restart the device with the new settings.

Note that if you changed the IP address, you will not be able to return to the Home Page with the **Home** button.

Export/Import

Export/Import allows you to back up and recover your settings.

Click **Export** to store all configuration data into a default file, **<Servername>.txt**. Click the **Import** button to upload a configuration file to the NPort IA5450A.

Basic Settings

Server name

Setting	Factory Default	Necessity
1 to 39 characters	NP[model name]_[Serial No.]	Optional

This option is useful for specifying the location or application of different NPort IA5450As.

Web/Telnet Console

The “Disable” option for “Web Console” and “Telnet Console” is included for security reasons. In some cases, you may want to disable one or both of these console utilities as an extra precaution to prevent unauthorized users from accessing your NPort IA5450A. The factory default for both Web console and Telnet console is **Enable**.

Web console

Setting	Factory Default	Necessity
Enable or Disable	Enable	Required

Telnet console

Setting	Factory Default	Necessity
Enable or Disable	Enable	Required



ATTENTION

If you disable both the “Web console” and “Telnet console,” you can still use NPort Administrator to configure NPort IA5450A device servers locally or remotely over the network. Refer to Chapter 6 for more details.

Reset button protect

Setting	Factory Default	Necessity
No or Yes	None	Optional

Network Settings

You must assign a valid IP address to the NPort IA5450A before it will work in your network environment. Your network system administrator should provide you with an IP address and related settings for your network. The IP address must be unique within the network (otherwise, the NPort IA5450A will not have a valid connection to the network). First time users can refer to Chapter 3, **Initial IP Address Configuration**, for more information.

You can choose from four possible **IP Configuration** modes—**Static**, **DHCP**, **DHCP/BOOTP**, and **BOOTP**—located under the web console screen’s IP configuration drop-down box.

IP configuration

Method	Function Definition	Default
Static	User defined IP address, Netmask, Gateway.	
DHCP	DHCP Server assigned IP address, Netmask, Gateway, DNS, and Time Server	
DHCP/BOOTP	DHCP Server assigned IP address, Netmask, Gateway, DNS, and Time Server, or BOOTP Server assigned IP address (if the DHCP Server does not respond)	
BOOTP	BOOTP Server assigns IP address	

IP address

Setting	Factory Default	Necessity
E.g., 192.168.1.1 (IP addresses of the form x.x.x.0 and x.x.x.255 are invalid.)	192.168.127.254	Required

An IP address is a number assigned to a network device (such as a computer) as a permanent address on the network. Computers use the IP address to identify and talk to each other over the network. Choose a proper IP address which is unique and valid in your network environment.

Netmask

Setting	Factory Default	Necessity
E.g., 255.255.255.0	255.255.255.0	Required

A subnet mask represents all of the network hosts at one geographic location, in one building, or on the same local area network. When a packet is sent out over the network, the NPort IA5450A will use the subnet mask to check whether the desired TCP/IP host specified in the packet is on the local network segment. If the address is on the same network segment as the NPort IA5450A, a connection is established directly from the NPort IA5450A. Otherwise, the connection is established through the given default gateway.

Gateway

Setting	Factory Default	Necessity
E.g., 192.168.1.1	None	Optional

A gateway is a network gateway that acts as an entrance to another network. Usually, the computers that control traffic within the network or at the local Internet service provider are gateway nodes. NPort IA5450A needs to know the IP address of the default gateway computer in order to communicate with the hosts outside the local network environment. For correct gateway IP address information, consult the network administrator.

IP configuration

Setting	Factory Default	Necessity
Static, DHCP, DHCP/BOOTP, BOOTP	Static	Required



ATTENTION

In Dynamic IP environments, the firmware will retry 3 times every 30 seconds until network settings are assigned by the DHCP or BOOTP server. The Timeout for each try increases from 1 second, to 3 seconds, to 5 seconds. If the DHCP/BOOTP Server is unavailable, the firmware will use the default IP address (192.168.127.254), Netmask, and Gateway for IP settings.

DNS server 1 / DNS server 2

Setting	Factory Default	Necessity
(IP addresses of the form x.x.x.0 and x.x.x.255 are invalid.)	None	Optional

When the user wants to visit a particular website, the computer asks a Domain Name System (DNS) server for the website's correct IP address, and then the computer uses the response to connect to the web server. DNS is the way that Internet domain names are identified and translated into IP addresses. A domain name is an alphanumeric name, such as moxa.com, that it is usually easier to remember. A DNS server is a host that translates this kind of text-based domain name into the numeric IP address used to establish a TCP/IP connection.

In order to use NPort IA5450A's DNS feature, you need to configure the DNS server. Doing so allows NPort IA5450A to use a host's domain name to access the host. NPort IA5450A provides DNS server 1 and DNS server 2 configuration items to configure the IP address of the DNS server. DNS Server 2 is included for use when DNS sever 1 is unavailable.

NPort IA5450A plays the role of DNS client, in the sense that the NPort IA5450A will actively query the DNS server for the IP address associated with a particular domain name. NPort IA5450A functions that support domain name are **Time server**, **Destination IP Address in TCP Client mode**, **Mail Server**, **SNMP trap server**, and **Auto report to IP**.

SNMP Settings

Community name

Setting	Factory Default	Necessity
1 to 39 characters	public	Optional

A community name is a plain-text password mechanism that is used to weakly authenticate queries to agents of managed network devices.

Contact

Setting	Factory Default	Necessity
1 to 39 characters (E.g., Support, 886-89191230 #300)	None	Optional

The SNMP contact information usually includes an emergency contact name and telephone or pager number.

Location

Setting	Factory Default	Necessity
1 to 39 characters (E.g., Floor 1, office 2)	None	Optional

Specify the location string for SNMP agents such as the NPort IA5450A. This string is usually set to the street address where the NPort IA5450A is physically located.

IP Address Report

When NPort IA5450A products are used in a dynamic IP environment, users must spend more time with IP management tasks. For example, if the NPort IA5450A works as a server (TCP or UDP), then the host, which acts as a client, must know the IP address of the server. If the DHCP server assigns a new IP address to the NPort IA5450A, the host must have some way of determining the NPort IA5450A's new IP address.

NPort IA5450A products help out by periodically reporting their IP address to the IP location server, in case the dynamic IP has changed. The parameters shown below are used to configure the Auto IP report function. There are two ways to develop an "Auto IP report Server" to receive the NPort IA5450A's Auto IP report.

1. Use the NPort Administrator's IP Address Report function.
2. The Auto IP report protocol can automatically receive the Auto IP report on a regular basis, and is also available to help you develop your own software. Refer to Appendix E for the "Auto IP report protocol".

Auto report to IP

Setting	Factory Default	Necessity
E.g., 192.168.1.1 or URL (IP addresses of the form x.x.x.0 and x.x.x.255 are invalid.)	None	Optional

Reports generated by the Auto report function will be automatically sent to this IP address.

Auto report to TCP port

Setting	Factory Default	Necessity
E.g., 4001	4002	Optional

Auto report period

Setting	Factory Default	Necessity
Time interval (in seconds)	10	Optional

Serial Settings

Click **Serial Settings**, located under **Main Menu**, to display serial port settings for port 1.

MOXA Total Solution for Industrial Device Networking WWW.MOXA.COM

Model - NPort IA5450AI
IP - 192.168.127.254
MAC Address - 00:90:E8:12:34:57
Name - NPIA5450AI_2
Serial NO. - 2
Firmware - 1.0 Build 10032318

Serial Settings

Port	Alias	Baud rate	Data bits	Stop bits	Parity	FIFO	Flow ctrl	Interface
1		115200	8	1	None	Enable	RTS/CTS	RS-232
2		115200	8	1	None	Enable	RTS/CTS	RS-232
3		115200	8	1	None	Enable	RTS/CTS	RS-232
4		115200	8	1	None	Enable	RTS/CTS	RS-232

To modify serial settings for a particular port, click either **Port X (X=1 or 2 or 3 or 4)** under **Serial Settings**, located under **Main Menu** on the left side of the browser window.

MOXA Total Solution for Industrial Device Networking WWW.MOXA.COM

Model - NPort IA5450AI
IP - 192.168.127.254
MAC Address - 00:90:E8:12:34:57
Name - NPIA5450AI_2
Serial NO. - 2
Firmware - 1.0 Build 10032318

Serial Settings

Port 1

Port alias

Serial Settings

Baud rate
Data bits
Stop bits
Parity
Flow control
FIFO Enable Disable
Interface

Apply the above settings to P1 P2 P3 P4
 All ports

Port alias

Setting	Factory Default	Necessity
1 to 15 characters (E.g., PLC-No.1)	None	Optional

“Port alias” is included to allow easy identification of the serial devices that are connected to the NPort IA5450A's serial ports.

Serial Parameters



ATTENTION

Check the serial communication parameters in your serial device's user's manual. You should set up the NPort IA5450A's serial parameters with the same communication parameters used by your serial devices.

Baudrate

Setting	Factory Default	Necessity
50 bps to 921.6 Kbps	115.2 Kbps	Required

Data bits

Setting	Factory Default	Necessity
5, 6, 7, 8	8	Required

When the user sets **Data bits** to 5 bits, the **Stop bits** setting will automatically change to 1.5 bits.

Stop bits

Setting	Factory Default	Necessity
1, 1.5, 2	1	Required

Stop bits will be set to 1.5 when **Data bits** is set to 5 bits.

Parity

Setting	Factory Default	Necessity
None, Even, Odd, Space, Mark	None	Required

Flow control

Setting	Factory Default	Necessity
None, RTS/CTS, DTR/DSR, Xon/Xoff	RTS/CTS	Required

FIFO

Setting	Factory Default	Necessity
Enable, Disable	Enable	Required

The NPort IA5450A's serial ports provide a 16-byte FIFO in both the Tx and Rx directions. To prevent unexpected communication, disable the FIFO setting when your serial device does not have a FIFO.

Interface

Setting	Factory Default	Necessity
RS-232/422/485	RS-232	Required

Operating Settings

Click **Operating Settings**, located under **Main Menu**, to display the operating settings for both of the NPort IA5450A's serial ports.

Real COM Mode

TCP alive check time

Setting	Factory Default	Necessity
0 to 99 min	7 min	Optional

0 min: The TCP connection will not be closed due to an idle TCP connection.

1 to 99 min: NPort IA5450A automatically closes the TCP connection if there is no TCP activity for the given time. After the connection is closed, the NPort IA5450A starts listening for another Real COM driver connection from another host.

Max connection

Setting	Factory Default	Necessity
1, 2, 3, 4, 5, 6, 7, 8	1	Required

Max connection is usually used when the user needs to receive data from different hosts simultaneously. The factory default is 1. In this case, only one specific host can access this port of the NPort IA5450A, and the Real COM driver on that host will have full control over the port.

Max Connection 1:

Allows only 1 host's Real COM driver to open the specific NPort IA5450A serial port.

Max Connection 2 to 8:

Allows 2 to 8 host's Real COM drivers to open the specific NPort IA5450A serial port, at the same time. When multiple hosts' Real COM drivers open the serial port at the same time, the COM driver only provides a pure data tunnel without control ability. That is, this serial port parameter will use the firmware's settings, not depend on your application program (AP).

Application software that is based on the COM driver will receive a driver response of "success" when the software uses any of the Win32 API functions. The firmware will only send the data back to the driver on the host.

Data will be sent first-in-first-out when data comes into the NPort IA5450A from the Ethernet interface.

**ATTENTION**

When "Max connection" is set greater than 1, this means that the NPort IA5450A will be using a "multi connection application" (i.e., Up to 8 hosts are allowed access to the port at the same time). When using a multi connection application, the NPort IA5450A will use the serial communication parameters set in the console. All of the hosts connected to that port must use the same serial settings. If one of the hosts opens the COM port with parameters that are different from the NPort IA5450A's console setting, data communication may not work properly.

Ignore jammed IP

Setting	Factory Default	Necessity
No or Yes	No	Optional

By default, when **Max connection** is greater than 1, and the serial device is transmitting data, if any one of the connected hosts is not responding, it will wait until the data has been transmitted successfully before transmitting the second group of data to all hosts. If you select **Yes** under **Ignore jammed IP**, the host that is not responding will be ignored, but the data will still be transmitted to the other hosts.

Allow driver control

Setting	Factory Default	Necessity
No or Yes	No	Optional

If **Max connection** is greater than 1, NPort will ignore driver control commands from all connected hosts. However, if you set **Allow driver control** to **Yes**, control commands will be accepted. Note that since the NPort IA5450A may get configuration changes from multiple hosts, the most recent command received will take precedence.

Packing length

Setting	Factory Default	Necessity
0 to 1024	0	Optional

Default = 0, The Delimiter Process will be followed, regardless of the length of the data packet. If the data length (in bytes) matches the configured value, the data will be forced out. The data length can be configured for 0 to 1024 bytes. Set to 0 if you do not need to limit the length.

Delimiter 1

Setting	Factory Default	Necessity
00 to FF (hex)	None	Optional

Delimiter 2

Setting	Factory Default	Necessity
00 to FF (hex)	None	Optional

Once the NPort IA5450A receives both delimiters through its serial port, it immediately packs all data currently in its buffer and sends it to the NPort IA5450A's Ethernet port.

**ATTENTION**

Delimiter 2 is optional. If left blank, then Delimiter 1 alone trips clearing of the buffer. If the size of the serial data received is greater than 1 KB, the NPort IA5450A will automatically pack the data and send it to the Ethernet port. However, to use the delimiter function, you must at least enable Delimiter 1. If Delimiter 1 is left blank and Delimiter 2 is enabled, the delimiter function will not work properly.

Delimiter process

Setting	Factory Default	Necessity
Do nothing, Delimiter + 1, Delimiter + 2, Strip Delimiter	Do Nothing	Optional

Delimiter + 1 or **Delimiter + 2**: The data will be transmitted when an additional byte (for **Delimiter + 1**), or an additional 2 bytes (for **Delimiter + 2**) of data is received after receiving the Delimiter.

Strip Delimiter: When the Delimiter is received, the Delimiter is deleted (i.e., stripped), and the remaining data is transmitted.

Do nothing: The data will be transmitted when the Delimiter is received.

Force transmit

Setting	Factory Default	Necessity
0 to 65535 ms	0 ms	Optional

0: Disable the force transmit timeout.

1 to 65535: Forces the NPort IA5450A's TCP/IP protocol software to try to pack serial data received during the specified time into the same data frame.

This parameter defines the time interval during which the NPort IA5450A fetches the serial data from its internal buffer. If data is incoming through the serial port, the NPort IA5450A stores the data in the internal buffer. The NPort IA5450A transmits data stored in the buffer via TCP/IP, but only if the internal buffer is full or if the Force transmit time interval reaches the time specified under **Force transmit**.

The optimal Force transmit timeout depends on your application, but it must be at least larger than one character interval within the specified baudrate. For example, assume that the serial port is set to 1200 bps, 8 data bits, 1 stop bit, and no parity. In this case, the total number of bits needed to send a character is 10 bits, and the time required to transfer one character is

$$(10 \text{ (bits)} / 1200 \text{ (bits/s)}) * 1000 \text{ (ms/s)} = 8.3 \text{ ms.}$$

Therefore, you should set Force transmit timeout to be larger than 8.3 ms, so in this case, it must be greater than or equal to 10 ms.

If the user wants to send a series of characters in the same packet, the serial device attached to the NPort IA5450A should send that series of characters during a time interval less than the Force transmit timeout for the NPort IA5450A, and the total length of data must be less than or equal to the NPort IA5450A's internal buffer size. The serial communication buffer size for the NPort IA5450A is 1 KB per port.

RFC2217 Mode

TCP alive check time

Setting	Factory Default	Necessity
0 to 99 min	7 min	Optional

0 min: TCP connection is not closed due to an idle TCP connection.

1 to 99 min: The NPort IA5450A automatically closes the TCP connection if there is no TCP activity for the given time. After the connection is closed, the NPort IA5450A starts listening for another host's TCP connection.

Local TCP port

Setting	Factory Default	Necessity
1 to 65535	4001	Required

The **Local TCP port** is the TCP port that the NPort IA5450A uses to listen to connections, and that other devices must use to contact the NPort IA5450A. To avoid conflicts with well known TCP ports, the default is set to 4001.

Packing length

Setting	Factory Default	Necessity
0 to 1024	0	Optional

Default = 0: The Delimiter Process will be followed, regardless of the length of the data packet. If the data length (in bytes) matches the configured value, the data will be forced out. The data length can be configured for 0 to 1024 bytes. Set to 0 if you do not need to limit the length.

Delimiter 1

Setting	Factory Default	Necessity
00 to FF	None	Optional

Delimiter 2

Setting	Factory Default	Necessity
00 to FF	None	Optional

Once the NPort IA5450A receives both delimiters through its serial port, it immediately packs all data currently in its buffer and sends it out the NPort IA5450A's Ethernet port.

Delimiter process

Setting	Factory Default	Necessity
Do Nothing, Delimiter + 1, Delimiter + 2, Strip Delimiter	Do Nothing	Optional

Delimiter + 1 or **Delimiter + 2**: The data will be transmitted when an additional byte (for Delimiter +1), or an additional 2 bytes (for Delimiter +2) of data is received after receiving the Delimiter.

Strip Delimiter: When the Delimiter is received, the Delimiter is deleted (i.e., stripped), and the remaining data is transmitted.

Do Nothing: The data will be transmitted when the Delimiter is received.

Force transmit

Setting	Factory Default	Necessity
0 to 65535 ms	0 ms	Optional

0: Disable the force transmit timeout.

1 to 65535: Forces the NPort IA5450A's TCP/IP protocol software to try to pack serial data received during the specified time into the same data frame.

This parameter defines the time interval during which the NPort IA5450A fetches the serial data from its internal buffer. If data is incoming through the serial port, the NPort IA5450A stores the data in the internal buffer. The NPort IA5450A transmits data stored in the buffer via TCP/IP, but only if the internal buffer is full or if the Force transmit time interval reaches the time specified under Force transmit timeout.

The optimal Force transmit timeout depends on your application, but it must be at least larger than one character interval within the specified baudrate. For example, assume that the serial port is set to 1200 bps, 8 data bits, 1 stop bit, and no parity. In this case, the total number of bits needed to send a character is 10 bits, and the time required to transfer one character is

$$(10 \text{ (bits)} / 1200 \text{ (bits/s)}) * 1000 \text{ (ms/s)} = 8.3 \text{ ms.}$$

Therefore, you should set Force transmit timeout to a value larger than 8.3 ms, so in this case, it must be greater than or equal to 10 ms.

If the user wants to send a series of characters in the same packet, the serial device attached to the NPort IA5450A should send that series of characters during a time interval less than the Force transmit timeout for the NPort IA5450A, and the total length of data must be less than or equal to the NPort IA5450A's internal buffer size. The serial communication buffer size for the NPort IA5450A is 1 KB per port.

TCP Server Mode

TCP alive check time

Setting	Factory Default	Necessity
0 to 99 min	7 min	Optional

0 min: The TCP connection will not be closed due to an idle TCP connection.

1 to 99 min: The NPort IA5450A automatically closes the TCP connection if there is no TCP activity for the given time. After the connection is closed, the NPort IA5450A starts listening for another host's TCP connection.

Inactivity time

Setting	Factory Default	Necessity
0 to 65535 ms	0 ms	Optional

0 ms: TCP connection will not be closed due to an idle serial line.

0-65535 ms: The NPort IA5450A automatically closes the TCP connection if there is no serial data activity for the given time. After the connection is closed, the NPort IA5450A starts listening for another host's TCP connection.

This parameter defines the maintenance status as Closed or Listen for the TCP connection. The connection is closed if there is no incoming or outgoing data through the serial port during the specific Inactivity time.

If the Inactivity time is set to 0, the current TCP connection is kept active until a connection close request is received. Although Inactivity time is disabled, the NPort IA5450A will check the connection status between the NPort IA5450A and remote host by sending "keep alive" packets periodically. If the remote host does not respond to the packet, the NPort IA5450A assumes that the connection was closed down unintentionally. The NPort IA5450A will then force the existing TCP connection to close.

**ATTENTION**

The **Inactivity time** should be configured to be larger than the **Force transmit** timeout setting. To prevent the unintended loss of data due to the session disconnection, it is highly recommended that you set this value large enough so that the intended data transfer is completed.

Max connection

Setting	Factory Default	Necessity
1, 2, 3, 4, 5, 6, 7, 8	1	Required

Max connection is usually used when the user needs to receive data from different hosts simultaneously. The factory default only allows for 1 connection at a time.

Max connection 1: The NPort only allows 1 host to open the TCP connection to the specific serial port.

Max connection 2 to 8: Allows 2 to 8 host's TCP connection request to open this NPort IA5450A serial port, at the same time. When multiple hosts establish a TCP connection to the specific serial port at the same time, the NPort IA5450A will duplicate the serial data and transmit to all of the hosts. Ethernet data is sent on a first-in-first-out basis to the serial port when data comes into the NPort IA5450A from the Ethernet interface.

Ignore jammed IP

Setting	Factory Default	Necessity
No or Yes	No	Optional

By default, when **Max connection** is greater than 1, and the serial device is transmitting data, if any one of the connected hosts is not responding, it will wait until the data has been transmitted successfully before transmitting the second group of data to all hosts. If you select **Yes** for **Ignore jammed IP**, the host that is not responding will be ignored, but the data will still be transmitted to the other hosts.

Allow driver control

Setting	Factory Default	Necessity
No or Yes	No	Optional

If **Max connection** is greater than 1, the NPort will ignore driver control commands from all connected hosts. However, if you set **Allow driver control** to **Yes**, control commands will be accepted. Note that since the NPort IA5450A may get configuration changes from multiple hosts, the most recent command received will take precedence.

Packing length

Setting	Factory Default	Necessity
0 to 1024	0	Optional

Default = 0, The Delimiter Process will be followed, regardless of the length of the data packet. If the data length (in bytes) matches the configured value, the data will be forced out. The data length can be configured for 0 to 1024 bytes. Set to 0 if you do not need to limit the length.

Delimiter 1

Setting	Factory Default	Necessity
00 to FF	None	Optional

Delimiter 2

Setting	Factory Default	Necessity
00 to FF	None	Optional

Once the NPort IA5450A receives both delimiters through its serial port, it immediately packs all data currently in its buffer and sends it out the NPort IA5450A's Ethernet port.

**ATTENTION**

Delimiter 2 is optional. If left blank, then Delimiter 1 alone trips clearing of the buffer. If the size of the serial data received is greater than 1 KB, the NPort IA5450A will automatically pack the data and send it to the Ethernet. However, to use the delimiter function, you must at least enable Delimiter 1. If Delimiter 1 is left blank and Delimiter 2 is enabled, the delimiter function will not work properly.

Delimiter process

Setting	Factory Default	Necessity
Do Nothing, Delimiter + 1, Delimiter + 2, Strip Delimiter	Do Nothing	Optional

Delimiter + 1 or **Delimiter + 2**: The data will be transmitted when an additional byte (for Delimiter +1), or an additional 2 bytes (for Delimiter +2) of data is received after receiving the Delimiter.

Strip Delimiter: When the Delimiter is received, the Delimiter is deleted (i.e., stripped), and the remaining data is transmitted.

Do Nothing: The data will be transmitted when the Delimiter is received.

Force transmit

Setting	Factory Default	Necessity
0 to 65535 ms	0 ms	Optional

0: Disable the force transmit timeout.

1 to 65535: Forces the NPort IA5450A's TCP/IP protocol software to try to pack serial data received during the specified time into the same data frame.

This parameter defines the time interval during which the NPort IA5450A fetches the serial data from its internal buffer. If data is incoming through the serial port, the NPort IA5450A stores the data in the internal buffer. The NPort IA5450A transmits data stored in the buffer via TCP/IP, but only if the internal buffer is full or if the Force transmit time interval reaches the time specified under Force transmit timeout.

The optimal Force transmit timeout depends on your application, but it must be at least larger than one character interval within the specified baudrate. For example, assume that the serial port is set to 1200 bps, 8 data bits, 1 stop bit, and no parity. In this case, the total number of bits needed to send a character is 10 bits, and the time required to transfer one character is

$$(10 \text{ (bits)} / 1200 \text{ (bits/s)}) * 1000 \text{ (ms/s)} = 8.3 \text{ ms.}$$

Therefore, you should set Force transmit timeout to be larger than 8.3 ms, so in this case, it must be greater than or equal to 10 ms.

If the user wants to send a series of characters in the same packet, the serial device attached to the NPort IA5450A should send that series of characters during a time interval less than the Force transmit timeout for the NPort IA5450A, and the total length of data must be less than or equal to the NPort IA5450A's internal buffer size. The serial communication buffer size for the NPort IA5450A is 1 KB per port.

Local TCP port

Setting	Factory Default	Necessity
1 to 65535	4001	Required

The **Local TCP port** is the TCP port that the NPort IA5450A uses to listen to connections, and that other devices must use to contact the NPort IA5450A. To avoid conflicts with well known TCP ports, the default is set to 4001.

Command port

Setting	Factory Default	Necessity
1 to 65535	966	Optional

The **Command port** is a listen TCP port for IP-Serial Lib commands from the host. In order to prevent a TCP port conflict with other applications, the user can set the Command port to another port if needed. IP-Serial Lib will automatically check the Command Port on NPort IA5450A so that the user does not need to configure the program.

TCP Client Mode

TCP alive check time

Setting	Factory Default	Necessity
0 to 99 min	7 min	Optional

0 min: The TCP connection will not be closed due to an idle TCP connection.

1 to 99 min: The NPort IA5450A automatically closes the TCP connection if there is no TCP activity for the given time.

Inactivity time

Setting	Factory Default	Necessity
0 to 65535 ms	0 ms	Optional

0 ms: The TCP connection will not be closed due to an idle serial line.

0-65535 ms: NPort IA5450A automatically closes the TCP connection if there is no serial data activity for the given time.

This parameter defines the maintenance status as Closed or Listen for the TCP connection. The connection is closed if there is no incoming or outgoing data through the serial port during the specific Inactivity time.

If the Inactivity time is set to 0, the current TCP connection is kept active until a connection close request is received. Although Inactivity time is disabled, the NPort IA5450A will check the connection status between the NPort IA5450A and remote host by sending "keep alive" packets periodically. If the remote host does not respond to the packet, the NPort IA5450A assumes that the connection was closed unintentionally. NPort IA5450A will then force the existing TCP connection to close.



ATTENTION

Inactivity time is ONLY active when **TCP connect on** is set to **Any character**.

Ignore jammed IP

Setting	Factory Default	Necessity
No or Yes	No	Optional

By default, when **Max connection** is greater than 1, and the serial device is transmitting data, if any one of the connected hosts is not responding, it will wait until the data has been transmitted successfully before transmitting the second group of data to all hosts. If you select **Yes** for **Ignore jammed IP**, the host that is not responding will be ignored, but the data will still be transmitted to the other hosts.

Packing length

Setting	Factory Default	Necessity
0 to 1024	0	Optional

Default = 0, The Delimiter Process will be followed, regardless of the length of the data packet. If the data length (in bytes) matches the configured value, the data will be forced out. The data length can be configured for 0 to 1024 bytes. Set to 0 if you do not need to limit the length.

Delimiter 1

Setting	Factory Default	Necessity
00 to FF (hex)	None	Optional

Delimiter 2

Setting	Factory Default	Necessity
00 to FF (hex)	None	Optional

Once the NPort IA5450A receives both delimiters through its serial port, it immediately packs all data currently in its buffer and sends it to the NPort IA5450A's Ethernet port.



ATTENTION

Delimiter 2 is optional. If left blank, then Delimiter 1 alone trips clearing of the buffer. If the size of the serial data received is greater than 1 KB, the NPort IA5450A will automatically pack the data and send it to the Ethernet. However, to use the delimiter function, you must at least enable Delimiter 1. If Delimiter 1 is left blank and Delimiter 2 is enabled, the delimiter function will not work properly.

Delimiter process

Setting	Factory Default	Necessity
Do Nothing, Delimiter + 1, Delimiter + 2, Strip Delimiter	Do Nothing	Optional

Delimiter + 1 or **Delimiter + 2**: The data will be transmitted when an additional byte (for Delimiter +1), or an additional 2 bytes (for Delimiter +2) of data is received after receiving the Delimiter.

Strip Delimiter: When the Delimiter is received, the Delimiter is deleted (i.e., stripped), and the remaining data is transmitted.

Do Nothing: The data will be transmitted when the Delimiter is received.

Force transmit

Setting	Factory Default	Necessity
0 to 65535 ms	0 ms	Optional

0: Disable the force transmit timeout.

1 to 65535: Forces the NPort IA5450A's TCP/IP protocol software to try to pack serial data received during the specified time into the same data frame.

This parameter defines the time interval during which the NPort IA5450A fetches the serial data from its internal buffer. If data is incoming through the serial port, the NPort IA5450A stores the data in the internal buffer. The NPort IA5450A transmits data stored in the buffer via TCP/IP, but only if the internal buffer is full or if the Force transmit time interval reaches the time specified under Force transmit timeout.

The optimal Force transmit timeout depends on your application, but it must be at least larger than one character interval within the specified baudrate. For example, assume that the serial port is set to 1200 bps, 8 data bits, 1 stop bit, and no parity. In this case, the total number of bits needed to send a character is 10 bits, and the time required to transfer one character is

$$(10 \text{ (bits)} / 1200 \text{ (bits/s)}) * 1000 \text{ (ms/s)} = 8.3 \text{ ms.}$$

Therefore, you should set Force transmit timeout to be larger than 8.3 ms, so in this case, it must be greater than or equal to 10 ms.

If the user wants to send a series of characters in the same packet, the serial device attached to the NPort IA5450A should send that series of characters during a time interval less than the Force transmit timeout for the NPort IA5450A, and the total length of data must be less than or equal to the NPort IA5450A's internal buffer size. The serial communication buffer size for the NPort IA5450A is 1 KB per port.

Destination IP address Function Name

Setting	Description	Factory Default
Setting	Description	Default

1/2/3/4

Setting	Factory Default	Necessity
IP address or Domain Name (E.g., 192.168.1.1)	None	Required

Allows the NPort IA5450A to connect actively to the remote host whose IP address is set by this parameter.



ATTENTION

Up to 4 connections can be established between the NPort IA5450A and hosts. The connection speed or throughput may be low if one of the four connections is slow, since one slow connection will slow down the other connections.



ATTENTION

The **Destination IP address** parameter can use both IP address and Domain Name. For some applications, the user may need to send the data actively to the remote destination domain name.

Designated Local Port 1/2/3/4

Setting	Factory Default	Necessity
TCP Port No.	5011 (Port 1) 5012 (Port 2) 5013 (Port 3) 5014 (Port 4)	Required

Connection control

Setting	Factory Default	Necessity
Startup/None, Any Character/None, Any Character/Inactivity Time, DSR ON/DSR OFF, DSR ON/None, DCD ON/DCD OFF, DCD ON/None	Startup/None	Required

The meaning of each of the above settings is given in the table below. In general, both the Connect condition and Disconnect condition are given.

Connect/Disconnect	Description
Startup/None (default)	A TCP connection will be established on startup, and will remain active indefinitely.
Any Character/None	A TCP connection will be established when any character is received from the serial interface, and will remain active indefinitely.
Any Character/ Inactivity Time	A TCP connection will be established when any character is received from the serial interface, and will be disconnected when the Inactivity time out is reached.
DSR On/DSR Off	A TCP connection will be established when a DSR "On" signal is received, and will be disconnected when a DSR "Off" signal is received.
DSR On/None	A TCP connection will be established when a DSR "On" signal is received, and will remain active indefinitely.
DCD On/DCD Off	A TCP connection will be established when a DCD "On" signal is received, and will be disconnected when a DCD "Off" signal is received.
DCD On/None	A TCP connection will be established when a DCD "On" signal is received, and will remain active indefinitely.

UDP Mode

Packing length

Setting	Factory Default	Necessity
0 to 1024	0	Optional

Default = 0, The Delimiter Process will be followed, regardless of the length of the data packet. If the data length (in bytes) matches the configured value, the data will be forced out. The data length can be configured for 0 to 1024 bytes. Set to 0 if you do not need to limit the length.

Delimiter 1

Setting	Factory Default	Necessity
00 to FF	None	Optional

Delimiter 2

Setting	Factory Default	Necessity
00 to FF	None	Optional

Once the NPort IA5450A receives both delimiters through its serial port, it immediately packs all data currently in its buffer and sends it out the NPort IA5450A's Ethernet port.



ATTENTION

Delimiter 2 is optional. If left blank, then Delimiter 1 alone trips clearing of the buffer. If the size of the serial data received is greater than 1 KB, the NPort IA5450A will automatically pack the data and send it to the Ethernet. However, to use the delimiter function, you must at least enable Delimiter 1. If Delimiter 1 is left blank and Delimiter 2 is enabled, the delimiter function will not work properly.

Delimiter process

Setting	Factory Default	Necessity
Do Nothing, Delimiter + 1, Delimiter + 2, Strip Delimiter	Do Nothing	Optional

Delimiter + 1 or Delimiter + 2: The data will be transmitted when an additional byte (for Delimiter +1), or an additional 2 bytes (for Delimiter +2) of data is received after receiving the Delimiter.

Strip Delimiter: When the Delimiter is received, the Delimiter is deleted (i.e., stripped), and the remaining data is transmitted.

Do Nothing: The data will be transmitted when the Delimiter is received.

Force transmit

Setting	Factory Default	Necessity
0 to 65535 ms	0 ms	Optional

0: Disable the force transmit timeout.

1 to 65535: Forces the NPort IA5450A's TCP/IP protocol software to try to pack serial data received during the specified time into the same data frame.

This parameter defines the time interval during which the NPort IA5450A fetches the serial data from its internal buffer. If data is incoming through the serial port, the NPort IA5450A stores the data in the internal buffer. The NPort IA5450A transmits data stored in the buffer via TCP/IP, but only if the internal buffer is full or if the Force transmit time interval reaches the time specified under Force transmit timeout.

The optimal Force transmit timeout depends on your application, but it must be at least larger than one character interval within the specified baudrate. For example, assume that the serial port is set to 1200 bps, 8 data bits, 1 stop bit, and no parity. In this case, the total number of bits needed to send a character is 10 bits, and the time required to transfer one character is

$$(10 \text{ (bits)} / 1200 \text{ (bits/s)}) * 1000 \text{ (ms/s)} = 8.3 \text{ ms.}$$

Therefore, you should set Force transmit timeout to a value larger than 8.3 ms, so in this case, it must be greater than or equal to 10 ms.

If the user wants to send a series of characters in the same packet, the serial device attached to the NPort IA5450A should send that series of characters during a time interval less than the Force transmit timeout for the NPort IA5450A, and the total length of data must be less than or equal to the NPort IA5450A's internal buffer size. The serial communication buffer size for the NPort IA5450A is 1 KB per port.

Destination IP address 1

Setting	Factory Default	Necessity
IP address range E.g., Begin: 192.168.1.1 End: 192.168.1.10	Begin: Empty End: Empty Port: 4001	Required

Destination IP address 2/3/4

Setting	Factory Default	Necessity
IP address range E.g., Begin: 192.168.1.11 End: 192.168.1.20	Begin: Empty End: Empty Port: 4001	Optional

Local listen port

Setting	Factory Default	Necessity
1 to 65535	4001	Required

To avoid conflicts with well known UDP ports, the UDP port that the NPort IA5450A listens to, and that other devices must use to contact the NPort IA5450A, should be set to the default value of 4001.

UDP Multicast

A multicast packet is a packet sent by one host to multiple hosts. In multicast mode, hosts that belong to a specific multicast group will receive multicast packets sent to that group. When configuring a host as a multicast receiver over the Internet, routers on the host's LAN must be informed. The Internet Group

Management Protocol (IGMP) is used to communicate group membership information between hosts and routers on a LAN. The NPort IA5450A supports IGMP version 2.

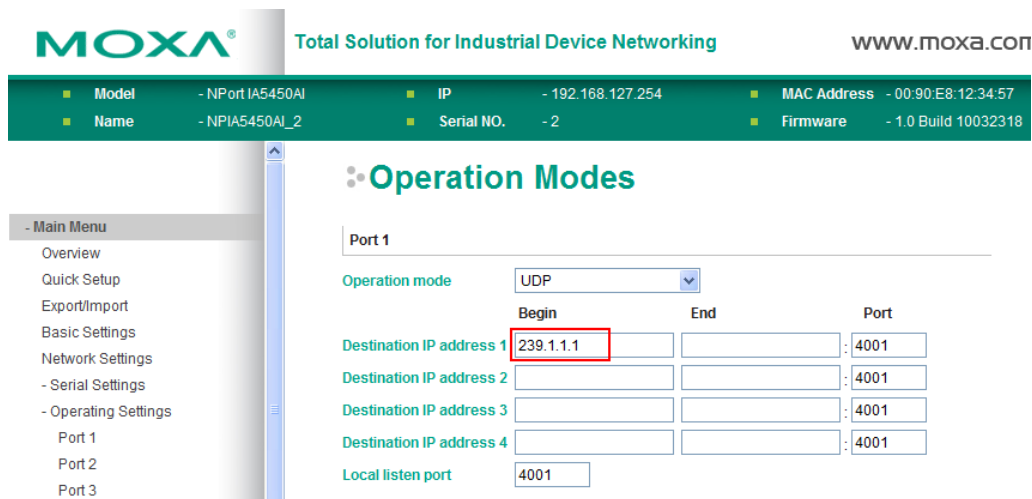

To add a network host to the multicast group, input the host's IP address (e.g., 239.1.1.1) in one of the **Destination IP address** input boxes, as illustrated above. The NPort will automatically add this host to the multicast group, and the host will start receiving all packets sent by the NPort to this group.

Pair Connection Mode

Pair Connection Mode employs two NPort IA5450A device servers in tandem, and can be used to remove the 15-meter distance limitation imposed by the RS-232/422/485 interface. One NPort IA5450A is connected from its RS-232/422/485 port to the COM port of a PC or other type of computer, such as hand-held PDAs that have a serial port, and the serial device is connected to the RS-232/422/485 port of the other NPort IA5450A. The two NPort IA5450A device servers are then connected to each other with a cross-over Ethernet cable, both are connected to the same LAN, or in a more advanced setup, they communicate with each other over a WAN (i.e., through one or more routers). Pair Connection Mode transparently transfers both data and modem control signals (although it cannot transmit the DCD signal) between the two NPorts.

Pair Connection Master Mode

When you select **Pair Connection Master Mode** for the Operation mode of one of the NPort IA5450A device servers this NPort IA5450A will be acting as a TCP client.

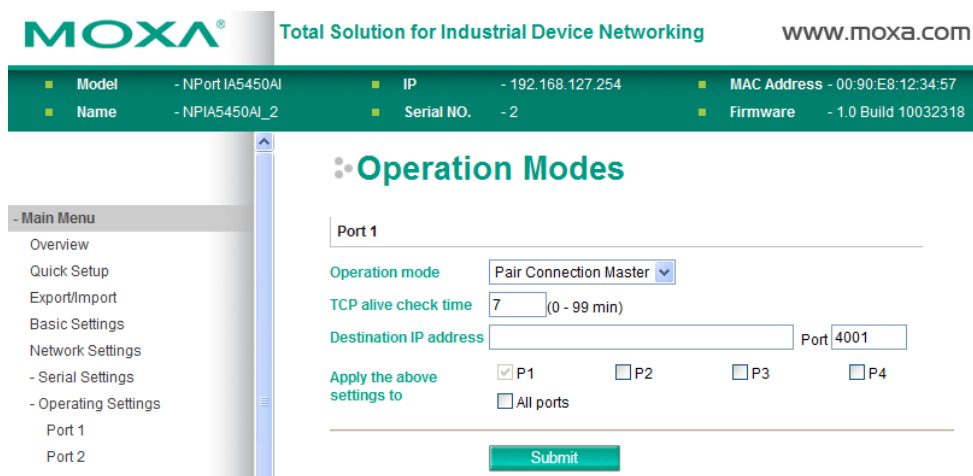

TCP alive check time

Setting	Factory Default	Necessity
0 to 99 min	7 min	Required

0 min: TCP connection is not closed due to an idle TCP connection.

1 to 99 min: The NPort IA5450A closes the TCP connection automatically if there is no TCP activity for the given time.

Destination IP address

Setting	Factory Default	Necessity
IP address or Domain Name (E.g., 192.168.1.1)	blank	Optional
TCP port No.	4001	Required

The Pair Connection "Master" will contact the network host that has this IP address. Data will be transmitted through the port No. (4001 by default). Note that you must configure the same TCP port No. for the device server acting as the Pair Connection "Slave."

Pair Connection Slave Mode

When you select **Pair Connection Slave Mode** for the Operation mode of one of the NPort IA5450A device servers this NPort IA5450A will be acting as a TCP server.

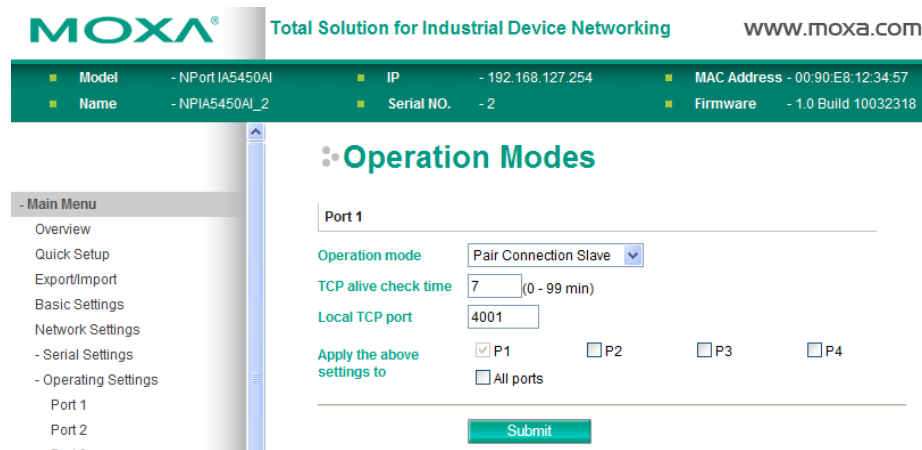

TCP alive check time

Setting	Factory Default	Necessity
0 to 99 min	7 min	Required

0 min: TCP connection is not closed due to an idle TCP connection.

1 to 99 min: The NPort IA5450A closes the TCP connection automatically if there is no TCP activity for the given time.

Local TCP port

Setting	Factory Default	Necessity
TCP port No. (e.g., 4001)	4001	Required

This Port No. must be the same port No. that you set up for the Pair Connection "Master" device server

Ethernet Modem Mode

MOXA Total Solution for Industrial Device Networking www.moxa.com

Model	- NPort IA5450A1	IP	- 192.168.127.254	MAC Address	- 00:90:E8:12:34:57
Name	- NP1A5450A1_2	Serial NO.	- 2	Firmware	- 1.0 Build 10032318

Operation Modes

Port 1

Operation mode:

TCP alive check time: (0 - 99 min)

Local TCP port:

Apply the above settings to: P1 P2 P3 P4 All ports

Dial-in

The NPort IA5450A listens for a TCP/IP connection request from the remote Ethernet modem or host. The NPort IA5450A's response depends on the ATSO value, as outlined below.

ATSO=0 (default):

The NPort IA5450A will temporarily accept the TCP connection and then send the "RING" signal out through the serial port. The serial controller must reply with "ATA" within 2.5 seconds to accept the connection request, after which the NPort IA5450A enters data mode. If no "ATA" command is received, the NPort IA5450A will disconnect after sending three "RING" signals.

ATSO≥1:

The NPort IA5450A will accept the TCP connection immediately and then send the "CONNECT <baud>" command to the serial port, in which <baud> represents the baudrate of the NPort IA5450A's serial port. After that, the NPort IA5450A immediately enters data mode.

Dial-out

The NPort IA5450A accepts the AT command "ATD <IP>: <TCP port>" from the serial port and then requests a TCP connection from the remote Ethernet Modem or PC. This is where <IP> is the IP address of the remote Ethernet modem or PC, and <TCP port> is the TCP port number of the remote Ethernet modem or PC. Once the remote unit accepts this TCP connection, the NPort IA5450A will send out the "CONNECT <baud>" signal via the serial port and then enter data mode.

Disconnection request from local site

When the NPort IA5450As is in data mode, the user can drive the DTR signal to OFF, or send "+++" from the local serial port to the NPort IA5450A. The NPort IA5450A will enter command mode and return "NO CARRIER" via the serial port, and then input "ATH" to shut down the TCP connection after 1 second.

NOTE The "+++" command cannot be divided. The "+" character can be changed in register S2, and the guard time, which prefixes and suffixes the "+++" in order to protect the raw data, can be changed in register S12.

After the TCP connection has been shut down by the remote Ethernet modem or PC, the NPort IA5450A will send the "NO CARRIER" signal via the serial port and then return to command mode.

AT Commands

The NPort IA5450A supports the following common AT commands used with a typical modem:

No.	AT command	Description	Remarks
1	ATA	Answer manually	
2	ATD <IP>: <Port>	Dial up the IP address: Port No.	
3	ATE	ATE0=Echo OFF ATE1=Echo ON (default)	
4	ATH	ATH0=On-hook (default) ATH1=Off-hook	
5	ATI, ATIO, ATI1, ATI2	Modem version	reply "OK" only
6	ATL	Speaker volume option	reply "OK" only
7	ATM	Speaker control option	reply "OK" only
8	ATO	On line command	
9	ATP, ATT	Set Pulse/Tone Dialing mode	reply "OK" only
10	ATQ0, ATQ1	Quiet command (default=ATQ0)	
11	ATSr=n	Change the contents of S register	See "S registers"
12	ATSr?	Read the contents of S register	See "S registers"
13	ATV	Result code type ATV0 for digit code ATV1 for text code 0=OK 1=connect (default) 2=ring 3=No carrier 4=error	
14	ATZ	Reset (disconnect, enter command mode and restore the flash settings)	
15	AT&C	Serial port DCD control AT&C0=DCD always on AT&C1=DTE detects connection by DCD on/off (default)	
16	AT&D	Serial port DTR control AT&D0=recognize DTE always ready AT&D1, AT&D2=reply DTE when DTR On (default)	
17	AT&F	Restore manufacturer's settings	
18	AT&G	Select guard time	reply "OK" only
19	AT&R	Serial port RTS option command	reply "OK" only
20	AT&S	Serial port DSR control	reply "OK" only
21	AT&V	View settings	
22	AT&W	Write current settings to flash for next boot up	

S Registers

No.	S Register	Description & default value	Remarks
1	S0	Ring to auto-answer (default=0)	
2	S1	Ring counter (always=0)	no action applied
3	S2	Escape code character (default=43 ASCII "+")	
4	S3	Return character (default=13 ASCII)	
5	S4	Line feed character (default=10 ASCII)	
6	S5	Backspace character (default= 8 ASCII)	
7	S6	Wait time for dial tone (always=2, unit=sec)	no action applied
8	S7	Wait time for carrier (default=3, unit=sec)	

9	S8	Pause time for dial delay (always=2, unit=sec)	no action applied
10	S9	Carrier detect response time (always=6, unit 1/10 sec)	no action applied
11	S10	Delay for hang up after carrier (always=14, unit 1/10 sec)	no action applied
12	S11	DTMF duration and spacing (always=100 ms)	no action applied
13	S12	Escape code guard time (default=50, unit 1/50 sec) to control the idle time for "+++"	

TCP alive check time

Setting	Factory Default	Necessity
0 to 99 min	7 min	Required

0 min: TCP connection is not closed due to an idle TCP connection.

1 to 99 min: The NPort IA5450A closes the TCP connection automatically if there is no TCP activity for the given time.

Local TCP port

Setting	Factory Default	Necessity
1 to 65535	4001	Required

The TCP port that other devices must use to contact this device. To avoid conflicts with standard TCP ports, the default is set to 4001.

Reverse Telnet Mode

The screenshot shows the MOXA web console interface. At the top, it says 'MOXA Total Solution for Industrial Device Networking' and 'www.moxa.com'. Below that is a status bar with fields for Model, Name, IP, Serial NO., MAC Address, and Firmware. The main content area is titled 'Operation Modes' and shows settings for 'Port 1'. The 'Operation mode' is set to 'Reverse Telnet'. The 'TCP alive check time' is 7 (0-99 min), 'Inactivity time' is 0 (0-65535 ms), and 'Local TCP port' is 4001. The 'Map <CR-LF>' is set to 'CR-LF'. There are checkboxes for 'Apply the above settings to' P1, P2, P3, P4, and 'All ports'. A 'Submit' button is at the bottom.

TCP alive check time

Setting	Factory Default	Necessity
0 to 99 min	7 min	Optional

0 min: TCP connection is not closed due to an idle TCP connection.

1 to 99 min: The NPort IA5450A automatically closes the TCP connection if there is no TCP activity for the given time.

Inactivity time

Setting	Factory Default	Necessity
0 to 65535 ms	0	Optional

Idle time setting for auto-disconnection. 0 min. means it will never disconnect.

Local TCP port

Setting	Factory Default	Necessity
1 to 65535	4001	Required

Each of the NPort IA5450A's serial ports is mapped to a TCP port. To avoid conflicts with common TCP port numbers, set port numbers to 4001 for port 1, 4002 for port 2, etc.

Map <CR-LF>

Setting	Factory Default	Necessity
CR, LF, or CR-LF	CR-LF	Required

If data received through the NPort IA5450A's Ethernet port is sent using the "enter" command, the data will be transmitted out the serial port with an added

"carriage return + line feed" if you select the <CR-LF> option
(i.e., the cursor will jump to the next line, and return to the first character of the line)

"carriage return" if you select the <CR> option
(i.e., the cursor will return to the first character of the line)

"line feed" if you select the <LF> option.
(i.e., the cursor will jump to the next line, but not move horizontally)

Disabled Mode

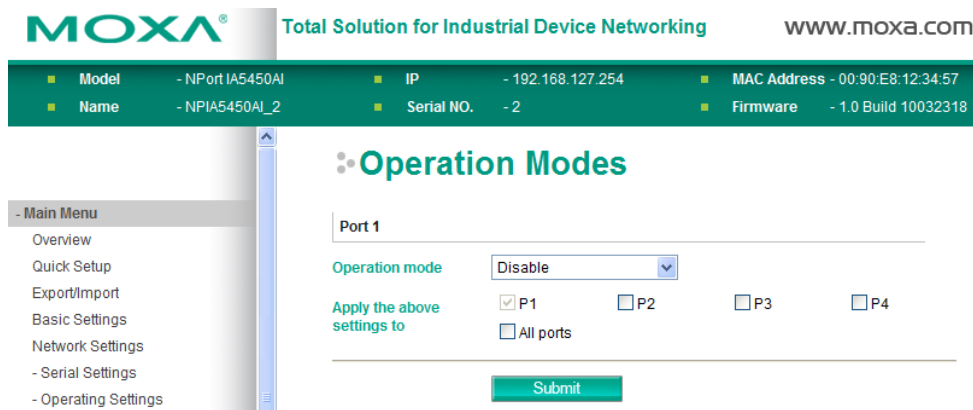

When Operation mode is set to Disabled, that particular port will be disabled. Check the "Apply the above settings to all serial ports" to apply this setting to the other port.

Accessible IP Settings

Total Solution for Industrial Device Networking
WWW.MOXA.COM

Model - NPort IA5450AI
IP - 192.168.127.253
MAC Address - 00:90:E8:19:28:88
Name - NPIA5450AI_10
Serial NO. - 10
Firmware - 1.0 Build 10050609

Accessible IP List

Enable the accessible IP list (Not checking "Enable" will allow all IPs to connect.)

No.	Activate the rule	IP Address	Netmask
1	<input type="checkbox"/>	<input type="text"/>	<input type="text"/>
2	<input type="checkbox"/>	<input type="text"/>	<input type="text"/>
3	<input type="checkbox"/>	<input type="text"/>	<input type="text"/>
4	<input type="checkbox"/>	<input type="text"/>	<input type="text"/>
5	<input type="checkbox"/>	<input type="text"/>	<input type="text"/>
6	<input type="checkbox"/>	<input type="text"/>	<input type="text"/>
7	<input type="checkbox"/>	<input type="text"/>	<input type="text"/>
8	<input type="checkbox"/>	<input type="text"/>	<input type="text"/>
9	<input type="checkbox"/>	<input type="text"/>	<input type="text"/>
10	<input type="checkbox"/>	<input type="text"/>	<input type="text"/>
11	<input type="checkbox"/>	<input type="text"/>	<input type="text"/>
12	<input type="checkbox"/>	<input type="text"/>	<input type="text"/>
13	<input type="checkbox"/>	<input type="text"/>	<input type="text"/>
14	<input type="checkbox"/>	<input type="text"/>	<input type="text"/>
15	<input type="checkbox"/>	<input type="text"/>	<input type="text"/>
16	<input type="checkbox"/>	<input type="text"/>	<input type="text"/>

- Main Menu

- Overview
- Quick Setup
- Export/Import
- Basic Settings
- Network Settings
- Serial Settings
- Operating Settings
- Accessible IP Settings
- Auto Warning Settings
- Upgrade Firmware
- Monitor
- Change Password
- Load Factory Default
- Save/Restart

The NPort IA5450A uses an IP address based filtering method to control access to itself.

Accessible IP Settings allows you to add or block remote host IP addresses to prevent unauthorized access. Access to the NPort IA5450A is controlled by IP address. That is, if a host's IP address is in the accessible IP table, then the host will be allowed to access the NPort IA5450A. You can allow one of the following cases by setting the parameter.

Only one host with a specific IP address can access the NPort IA5450A

Enter "IP address/255.255.255.255" (e.g., "192.168.1.1/255.255.255.255").

Hosts on a specific subnet can access the NPort IA5450A

Enter "IP address/255.255.255.0" (e.g., "192.168.1.0/255.255.255.0").

Any host can access the NPort IA5450A

Disable this function by un-checking the "Enable the accessible IP list" checkbox. Refer to the following table for more configuration examples.

Allowable Hosts	Input format
Any host	Disable
192.168.1.120	192.168.1.120 / 255.255.255.255
192.168.1.1 to 192.168.1.254	192.168.1.0 / 255.255.255.0
192.168.0.1 to 192.168.255.254	192.168.0.0 / 255.255.0.0
192.168.1.1 to 192.168.1.126	192.168.1.0 / 255.255.255.128
192.168.1.129 to 192.168.1.254	192.168.1.128 / 255.255.255.128

Auto Warning Settings

Auto warning: Email and SNMP trap

MOXA Total Solution for Industrial Device Networking www.moxa.com

Model - NPort IA5450AI IP - 192.168.127.253 MAC Address - 00:90:E8:19:28:88
 Name - NPIA5450AI_10 Serial NO. - 10 Firmware - 1.0 Build 10050609

E-mail and SNMP Trap Settings

Mail Server

Mail server

My server requires authentication

User name

Password

From E-mail address

E-mail address 1

E-mail address 2

E-mail address 3

E-mail address 4

SNMP Trap Server

SNMP trap server IP or domain name

Mail Server

Mail server

Setting	Factory Default	Necessity
IP Address or Domain Name	None	Optional

User name

Setting	Factory Default	Necessity
1 to 15 characters	None	Optional

Password

Setting	Factory Default	Necessity
1 to 15 characters	None	Optional

From E-mail address

Setting	Factory Default	Necessity
1 to 63 characters	None	Optional

E-mail address 1/2/3/4

Setting	Factory Default	Necessity
1 to 63 characters	None	Optional



ATTENTION

Consult your Network Administrator or ISP for the proper mail server settings. The Auto warning function may not work properly if it is not configured correctly. the NPort IA5450A SMTP AUTH supports LOGIN, PLAIN, CRAM-MD5 (RFC 2554).

SNMP Trap Server

SNMP trap server IP or domain name

Setting	Factory Default	Necessity
IP address or Domain Name	None	Optional

Event Type

Total Solution for Industrial Device Networking
WWW.MOXA.COM

■ Model - NPort IA5450AI ■ IP - 192.168.127.253 ■ MAC Address - 00:90:E8:19:28:88
 ■ Name - NPIA5450AJ_10 ■ Serial NO. - 10 ■ Firmware - 1.0 Build 10050609

- Main Menu

- Overview
- Quick Setup
- Export/Import
- Basic Settings
- Network Settings
- Serial Settings
- Operating Settings
- Accessible IP Settings
- Auto Warning Settings
- E-mail and SNMP Trap
- Event Type
- Upgrade Firmware
- Monitor
- Change Password
- Load Factory Default
- Save/Restart

Event Settings

System Event

Cold start Mail Trap

Warm start Mail Trap

Config Event

Authentication failure Mail Trap

IP changed Mail

Password changed Mail

Power failure Mail Relay output

Ethernet1 link down Mail Trap Relay output

Ethernet2 link down Mail Trap Relay output

DCD Changed

Port 1 Mail Trap Relay output

Port 2 Mail Trap Relay output

Port 3 Mail Trap Relay output

Port 4 Mail Trap Relay output

DSR Changed

Port 1 Mail Trap Relay output

Port 2 Mail Trap Relay output

Port 3 Mail Trap Relay output

Port 4 Mail Trap Relay output

Cold start

This refers to starting the system from power off (contrast this with warm start). When performing a cold start, the NPort IA5450A will automatically issue an Auto warning message by e-mail, or send an SNMP trap after booting up.

Warm start

This refers to restarting the computer without turning the power off. When performing a warm start, the NPort IA5450A will automatically send an e-mail, or send an SNMP trap after rebooting.

5-34

Authentication failure

The user inputs a wrong password from the Console or Administrator. When authentication failure occurs, the NPort will immediately send an e-mail or send an SNMP trap.

IP address changed

The user has changed the NPort IA5450A's IP address. When the IP address changes, the NPort IA5450A will send an e-mail with the new IP address before the NPort IA5450A reboots. If the NPort IA5450A is unable to send an e-mail message to the mail server within 15 seconds, the NPort IA5450A will reboot anyway, and abort the e-mail auto warning.

Password changed

The user has changed the NPort IA5450A's password. When the password changes, the NPort IA5450A will send an e-mail with the password changed notice before the NPort IA5450A reboots. If the NPort IA5450A is unable to send an e-mail message to the mail server within 15 seconds, the NPort IA5450A will reboot anyway, and abort the e-mail auto warning.

Power failure

We provide two DC power inputs for redundancy. the NPort IA5450A Series supports different approaches to warn engineers automatically, such as by email or relay output. Users can connect to "Monitor -> Relay Output" from the web console to check what event causes the warning. The relay output will be canceled after the power recovers, or by selecting "acknowledge event" using the web console or Telnet. When the Relay Output is sending a warning, the Ready LED will flash red until the warning event ceases.

Ethernet link down

NPort IA5450A Series provides system maintainers with real-time alarm messages for Ethernet link down. Even when control engineers are out of the control room for an extended period of time, they can still be informed of the status of devices almost instantaneously when exceptions occur. the NPort IA5450A Series supports different methods for warning engineers automatically, such as by email, SNMP trap, and relay output. Users can connect to "Monitor -> Relay" Output from the web console to check which Ethernet port is causing the warning. The relay output will be canceled if the failed Ethernet link is restored, or by selecting **Acknowledge Event** from the web console or Telnet. When the Relay Output is issuing a warning, the Ready LED will flash in red until the warning event ceases.

DCD changed

The DCD (Data Carrier Detect) signal has changed, also indicating that the modem connection status has changed. For example, a DCD change to high also means "Connected" between local modem and remote modem. If the DCD signal changes to low, it also means that the connection line is down.

When the DCD changes, the NPort IA5450A will immediately send an e-mail, send an SNMP trap, or trigger the relay output.

DSR changed

The DSR (Data Set Ready) signal has changed, also indicating that the data communication equipment's power is off. For example, a DSR change to high also means that the DCE is powered ON. If the DSR signal changes to low, it also means that the DCE is powered off.

When the DSR changes, the NPort IA5450A will immediately send an e-mail, send an SNMP trap, or trigger the relay output.

Mail

Setting	Factory Default	Necessity
Enable, Disable	Disable	Optional

This feature helps the administrator manage how the NPort IA5450A sends e-mail to pre-defined e-mail boxes when the enabled events—such as Cold start, Warm start, Authentication failure, etc.—occur. To configure this feature, click the Event Type Mail checkbox.

Trap

Setting	Factory Default	Necessity
Enable, Disable	Disable	Optional

This feature helps the administrator manage how the NPort IA5450A sends SNMP Trap to a pre-defined SNMP Trap server when the enabled events—such as Cold start, Warm start, Authentication failure, etc.—occur. To configure this feature, click the Event Type Trap checkbox.

Upgrade Firmware

Keep your NPort IA5450A up to date with the latest firmware from Moxa. Occasionally, compare your NPort firmware to the version currently available at the Moxa website (www.moxa.com). If there is a new firmware version, you can download it and click Import to upgrade your firmware.

Monitor

Monitor Line

Click **Line** under **Monitor** to show the operation mode and status of each TCP/IP connection (IPx) for the serial ports.

Port	Operation Mode	Connections
1	RealCOM	[192.168.127.100] [] [] []
2	RealCOM	[Listen] [] [] []
3	RealCOM	[Listen] [] [] []
4	RealCOM	[Listen] [] [] []

Monitor Async

Click **Async** under **Monitor** to show the current status of the serial port.

MOXA Total Solution for Industrial Device Networking www.moxa.com

Model	- NPort IA5450AI	IP	- 192.168.127.254	MAC Address	- 00:90:E8:12:34:57
Name	- NPIA5450AI_2	Serial NO.	- 2	Firmware	- 1.0 Build 10032318

Monitor Async

Port	TxCnt	RxCnt	TxTotalCnt	RxTotalCnt	DSR	DTR	RTS	CTS	DCD
1	0	0	0	0	<input type="radio"/>	<input checked="" type="radio"/>	<input checked="" type="radio"/>	<input type="radio"/>	<input type="radio"/>
2	0	0	0	0	<input type="radio"/>	<input type="radio"/>	<input checked="" type="radio"/>	<input type="radio"/>	<input type="radio"/>
3	0	0	0	0	<input type="radio"/>	<input type="radio"/>	<input checked="" type="radio"/>	<input type="radio"/>	<input type="radio"/>
4	0	0	0	0	<input type="radio"/>	<input type="radio"/>	<input checked="" type="radio"/>	<input type="radio"/>	<input type="radio"/>

- Overview
- Quick Setup
- Export/Import
- Basic Settings
- Network Settings
- Serial Settings
- Operating Settings
- Accessible IP Settings
- Auto Warning Settings
- Upgrade Firmware
- Monitor
- Line
- Async
- Async-Settings
- Relay Output

Monitor Async-Settings

Click **Async Setting** under **Monitor** to show the run-time settings for the serial port.

MOXA Total Solution for Industrial Device Networking www.moxa.com

Model	- NPort IA5450AI	IP	- 192.168.127.254	MAC Address	- 00:90:E8:12:34:57
Name	- NPIA5450AI_2	Serial NO.	- 2	Firmware	- 1.0 Build 10032318

Monitor Async-Settings

Port	Baud Rate	Data Bits	Stop Bits	Parity	Flow Control			FIFO	Interface
					RTS/CTS	XON/XOFF	DTR/DSR		
1	115200	8	1	None	ON	OFF	OFF	Enable	RS-232
2	115200	8	1	None	ON	OFF	OFF	Enable	RS-232
3	115200	8	1	None	ON	OFF	OFF	Enable	RS-232
4	115200	8	1	None	ON	OFF	OFF	Enable	RS-232

- Overview
- Quick Setup
- Export/Import
- Basic Settings
- Network Settings
- Serial Settings
- Operating Settings
- Accessible IP Settings
- Auto Warning Settings
- Upgrade Firmware
- Monitor
- Line
- Async
- Async-Settings
- Relay Output

Monitor Relay Output

Click **Relay Output** under **Monitor** to show the current status of the relay output. To cease the Relay Output warning, click on the **Acknowledge Event** button.

MOXA Total Solution for Industrial Device Networking www.moxa.com

Model	- NPort IA5450AI	IP	- 192.168.127.254	MAC Address	- 00:90:E8:12:34:57
Name	- NP1A5450AI_2	Serial NO.	- 2	Firmware	- 1.0 Build 10032318

Dout State

Dout Status		
Power failure	---	<input type="button" value="Acknowledge Event"/>
Ethernet1 link down	---	<input type="button" value="Acknowledge Event"/>
Ethernet2 link down	---	<input type="button" value="Acknowledge Event"/>
DCD changed (Port 1)	---	<input type="button" value="Acknowledge Event"/>
DSR changed (Port 1)	---	<input type="button" value="Acknowledge Event"/>
DCD changed (Port 2)	---	<input type="button" value="Acknowledge Event"/>
DSR changed (Port 2)	---	<input type="button" value="Acknowledge Event"/>
DCD changed (Port 3)	---	<input type="button" value="Acknowledge Event"/>
DSR changed (Port 3)	---	<input type="button" value="Acknowledge Event"/>
DCD changed (Port 4)	---	<input type="button" value="Acknowledge Event"/>
DSR changed (Port 4)	---	<input type="button" value="Acknowledge Event"/>

Change Password

MOXA Total Solution for Industrial Device Networking www.moxa.com

Model	- NPort IA5450AI	IP	- 192.168.127.254	MAC Address	- 00:90:E8:12:34:57
Name	- NP1A5450AI_2	Serial NO.	- 2	Firmware	- 1.0 Build 10032318

Change Password

Old password
New password
Retype password

Input the "Old password" and "New password" to change the password. Leave the password boxes blank to erase the password. If the password is erased, then the NPort IA5450A will not have password protection.



ATTENTION

If you forget the password, the ONLY way to configure the NPort IA5450A is by using the "Reset to default" button on the NPort IA5450A's top side to "Load Factory Default."
 Remember to export the configuration file when you finish the configuration. By using the Import function your configuration can be re-loaded into the NPort IA5450A after using "Load Factory Default."

Load Factory Default

MOXA Total Solution for Industrial Device Networking www.moxa.com

Model	- NPort IA5450AI	IP	- 192.168.127.254	MAC Address	- 00:90:E8:12:34:57
Name	- NPIA5450AI_2	Serial NO.	- 2	Firmware	- 1.0 Build 10032318

- Main Menu

- Overview
- Quick Setup
- Export/Import
- Basic Settings
- Network Settings
- Serial Settings
- Operating Settings
- Accessible IP Settings
- Auto Warning Settings
- Upgrade Firmware
- Monitor
- Change Password
- Load Factory Default

Load Factory Default

This function will reset all MOXA NPort Server settings to their factory default values. Be aware that previous settings will be lost.

[Submit](#)

This function will reset all of the NPort IA5450A's settings to the factory default values. Be aware that previous settings will be lost.

Save/Restart

Click **Save/Restart** will save the current configured settings and restart the NPort IA5450A to take effect.

MOXA Total Solution for Industrial Device Networking www.moxa.com

Model	- NPort IA5450AI	IP	- 192.168.127.254	MAC Address	- 00:90:E8:12:34:57
Name	- NPIA5450AI_2	Serial NO.	- 2	Firmware	- 1.0 Build 10032318

- Main Menu

- Overview
- Quick Setup
- Export/Import
- Basic Settings
- Network Settings
- Serial Settings
- Operating Settings
- Accessible IP Settings
- Auto Warning Settings
- Upgrade Firmware
- Monitor
- Change Password
- Load Factory Default
- Save/Restart

Save/Restart

The configuration has been changed. Please click to reboot with new configuration.

Warning!! Reboot will disconnect both serial and Ethernet connections and data maybe lost.

[Submit](#)

Configuring NPort Administrator

The following topics are covered in this chapter:

- **Overview**
- **Installing NPort Administrator**
- **Configuration**
 - Broadcast Search
 - Unlock Password Protection
 - Configuring the NPort IA5450A
 - Upgrading the Firmware
 - Export Configuration
 - Import Configuration
- **Monitor**
- **Port Monitor**
- **COM Mapping**
 - On-line COM Mapping
 - Off-line COM Mapping
- **COM Grouping**
- **IP Address Report**

Overview

NPort Administrator lets you install and configure your NPort IA5450A Series products easily over the network. Five function groups are provided to ease the installation process, allow off-line COM mapping, and provide monitoring and IP location server functions.

NPort Administrator is an integrated software suite that bundles NPort Administrator and the IP Serial Library, and provides everything you need to manage, monitor, and modify your NPort IA5450A from a remote location.

In this chapter, all the figures are captured by the NPort IA5450A Series for demonstration.

Installing NPort Administrator

1. Once the Setup program starts running, click **Next** when the **Welcome** window opens to proceed with the installation.

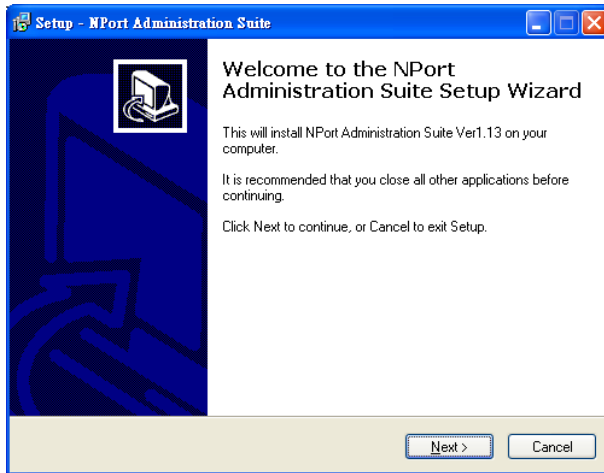

2. Click **Next** to install program files in the default directory, or select an alternative location.

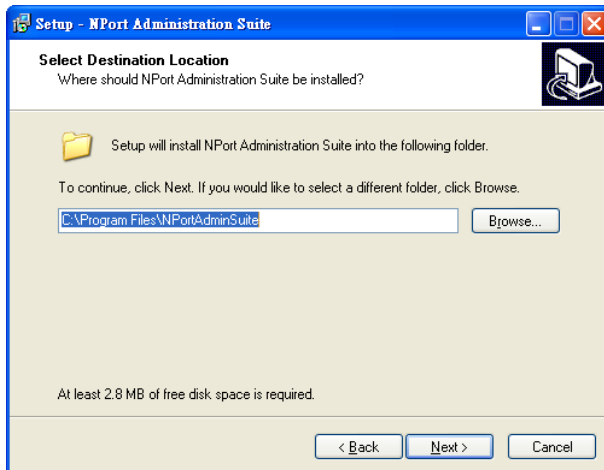

3. Click **Next** to install the program using the default program name, or select a different name.

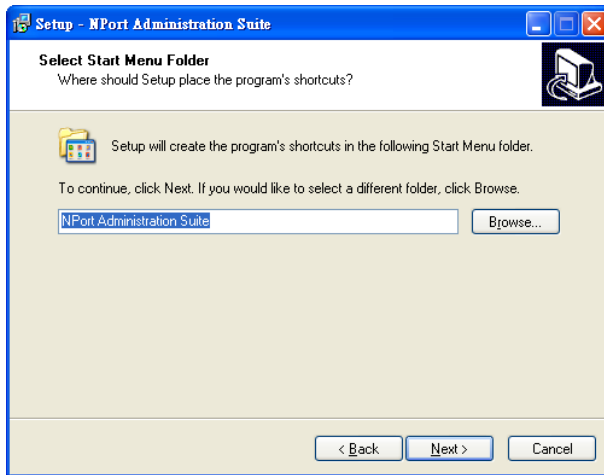

4. Click **Install** to proceed with the installation.

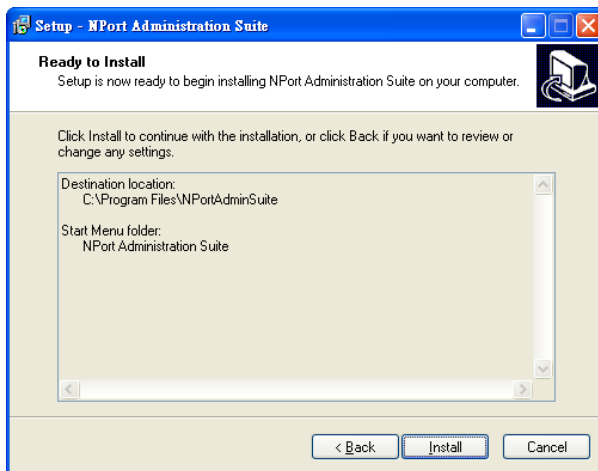

5. The **Installing** window reports the progress of the installation.

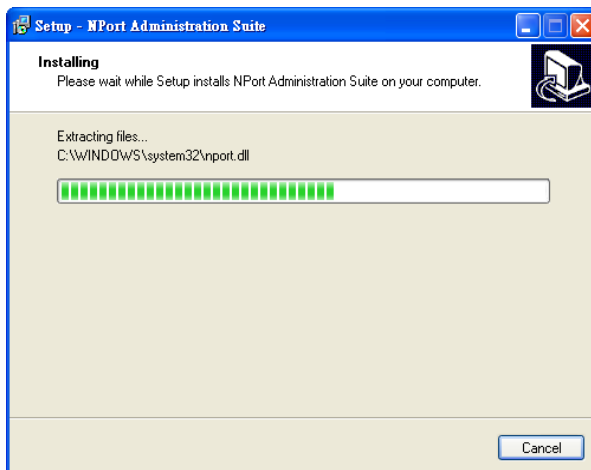

6. Click **Next** to proceed with the installation.

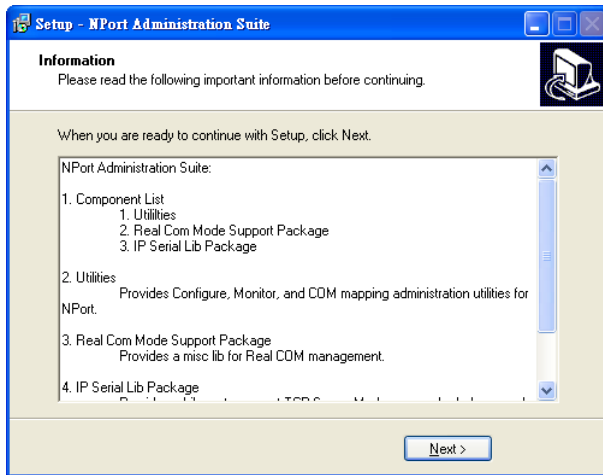

7. Click **Finish** to complete the installation of NPort Administration Suite.

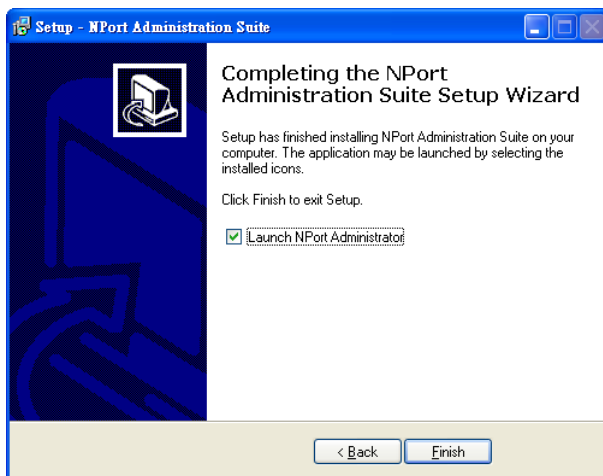

Configuration

The Administrator-Configuration window is divided into four parts.

- The top section contains the function list and online help area. (Windows NT does not support this .chm file format.)
- The five Administrator function groups are listed in the left section.
- A list of NPort IA5450A serial device servers, each of which can be selected to process user requirements, is displayed in the right section.
- The activity Log, which displays messages that record the user's processing history, is shown in the bottom section.

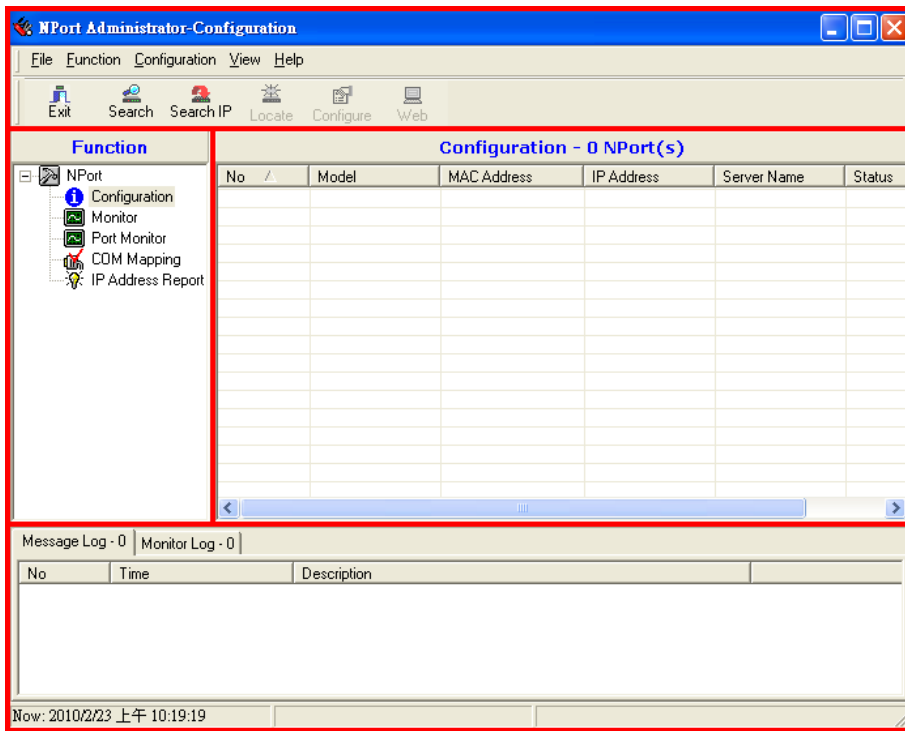

Broadcast Search

The **Broadcast Search** function is used to locate all NPort IA5450As that are connected to the same LAN as your computer. Since the Broadcast Search function searches by MAC address and not IP address, all NPort IA5450As connected to the LAN will be located, regardless of whether or not they are part of the same subnet as the host.

1. Position the cursor in the right middle section of the Administrator window and then click the right mouse button.

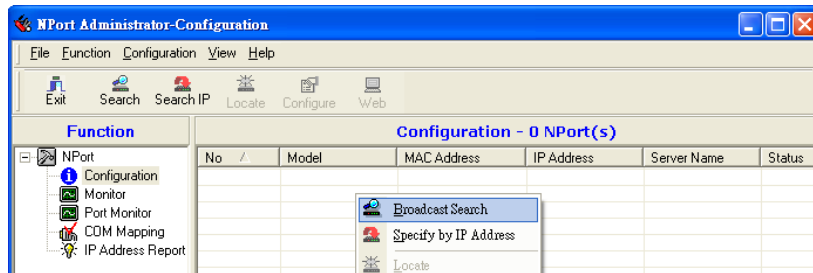

2. The **Broadcast Search** window will open and display the Model, IP Address, MAC Address, and Progress of the search for that particular device.

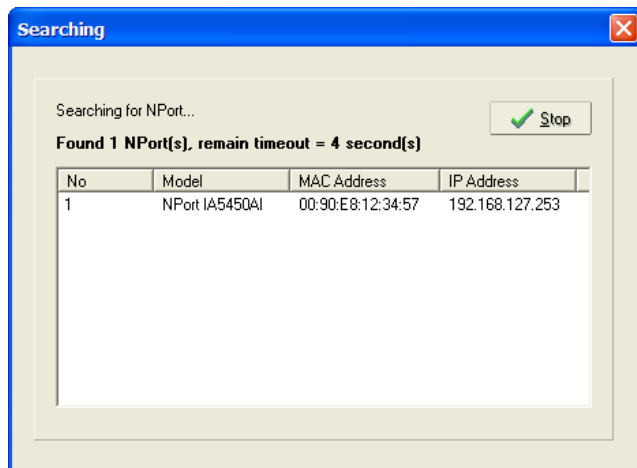

- When the search is complete, the Broadcast Search window will close, and the NPort IA5450As that were located will be displayed in the right pane of the Administrator window. If you found more than one server connected to this network, refer to the MAC address sticker on your server(s) to determine which server(s) are the ones you wish to configure. To configure an NPort IA5450A, place the cursor over the row displaying that NPort IA5450A's information, and then double click the left mouse button.

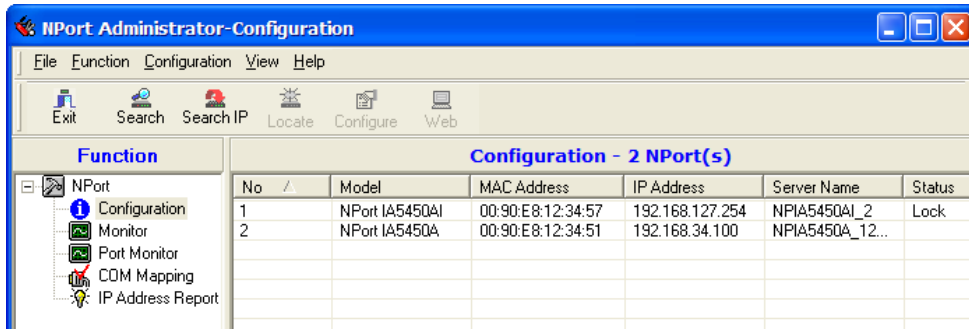

ATTENTION

Before modifying the NPort IA5450A's configuration, use **Broadcast Search** to locate all NPort IA5450As connected to the LAN, or use **Specify by IP Address** to locate a particular NPort IA5450A.

Unlock Password Protection

If the NPort IA5450A is password protected (indicated by "Lock" for Status), you will receive the following error, and you will not be able to use the right click method to open the configuration page.

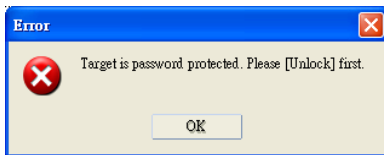

In this case, proceed as follows to "Unlock" the device server.

- Select the NPort IA5450A with "Lock" status, click the right mouse button, and then select **Unlock**.

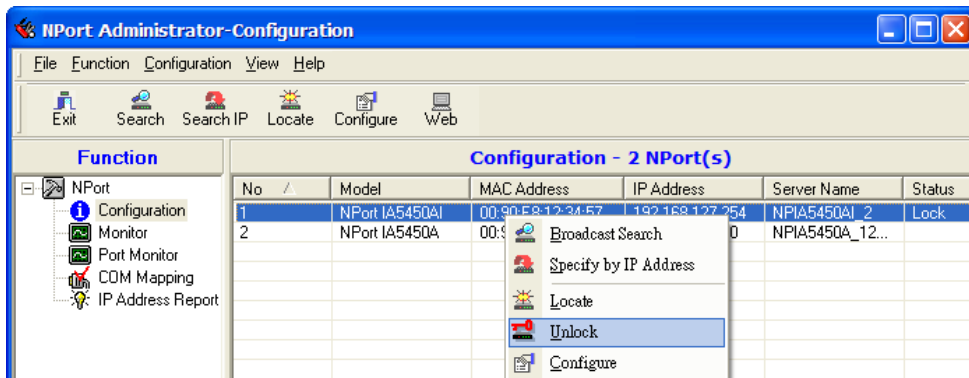

- After inputting the correct password, the Administrator will display an "Unlock ok" message.

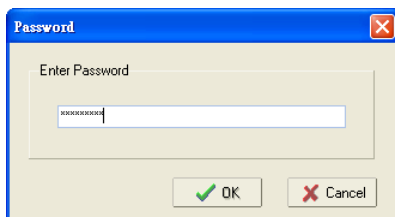

- The "Lock" status will change to "Unlock," and the Administrator utility will keep this NPort IA5450A in the Unlock status throughout this Administrator session.

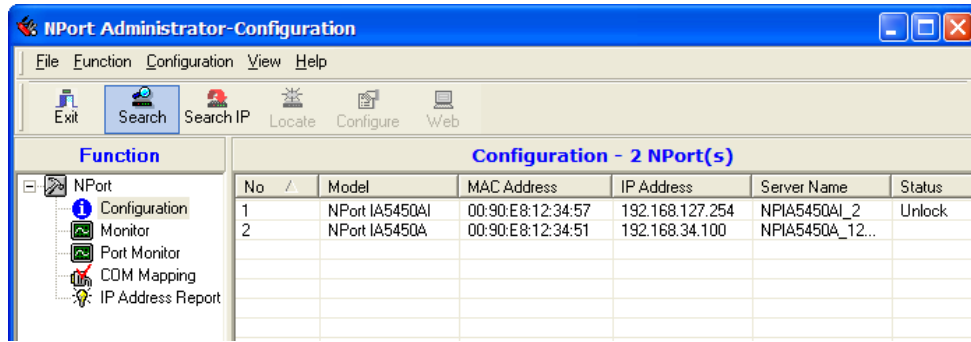

The meanings of the six "Status" states are given below (note that the term Fixed is borrowed from the standard fixed IP address networking terminology):

Lock

The NPort IA5450A is password protected, "Broadcast Search" was used to locate it, and the password has not yet been entered from within the current Administrator session.

Unlock

The NPort IA5450A is password protected, "Broadcast Search" was used to locate it, and the password has been entered from within the current Administrator session. Henceforth during this Administrator session, activating various utilities for this NPort IA5450A will not require re-entering the server password.

Blank

The NPort IA5450A is not password protected, and "Broadcast Search" was used to locate it.

Fixed

The NPort IA5450A is not password protected, and "Search by IP address" was used to locate it.

Lock Fixed

The NPort IA5450A is password protected, "Specify by IP address" was used to locate it, and the password has not yet been entered from within the current Administrator session.

Unlock Fixed

The NPort IA5450A is password protected, "Specify by IP address" was used to locate it, and the password has been entered from within the current Administrator session. Henceforth during this Administrator session, activating various utilities for this NPort IA5450A will not require re-entering the server password.

Configuring the NPort IA5450A

In this section, we illustrate how to access the NPort IA5450A's configuration utility. You should first make sure that you can connect over the network from your computer to the NPort IA5450A.

- To start NPort Administrator, click **Start → NPort Administration Suite → NPort Administrator**.

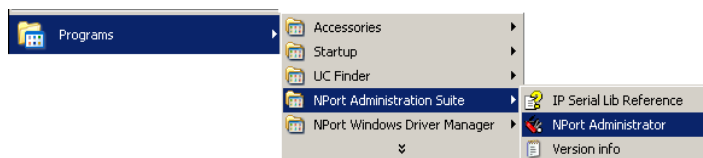

2. Unlock the NPort IA5450A you wish to configure if it is password protected. Right click the NPort IA5450A and select Configure to start the configuration.

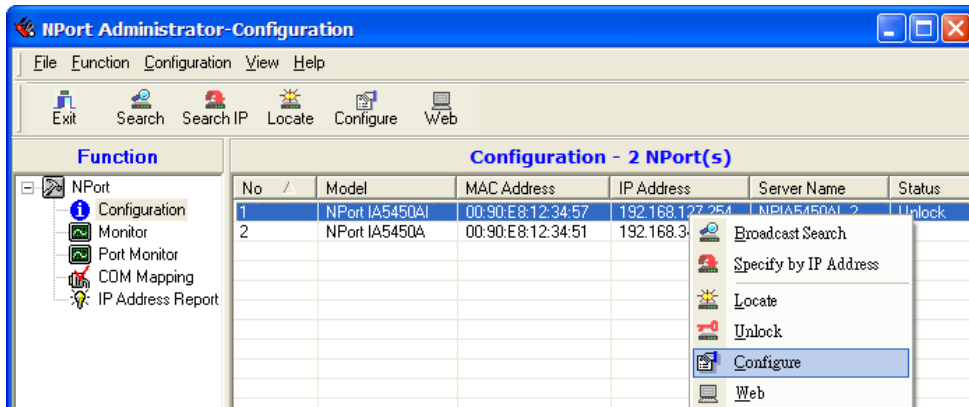

3. The progress bar shows that Administrator is retrieving configuration information from the specific NPort IA5450A.

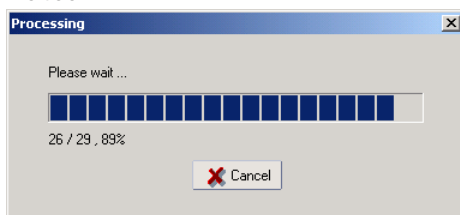

4. Refer to Chapter 5 for each parameter's function definition. To modify the configuration, you must first click in the modify box to activate the parameter setting box.

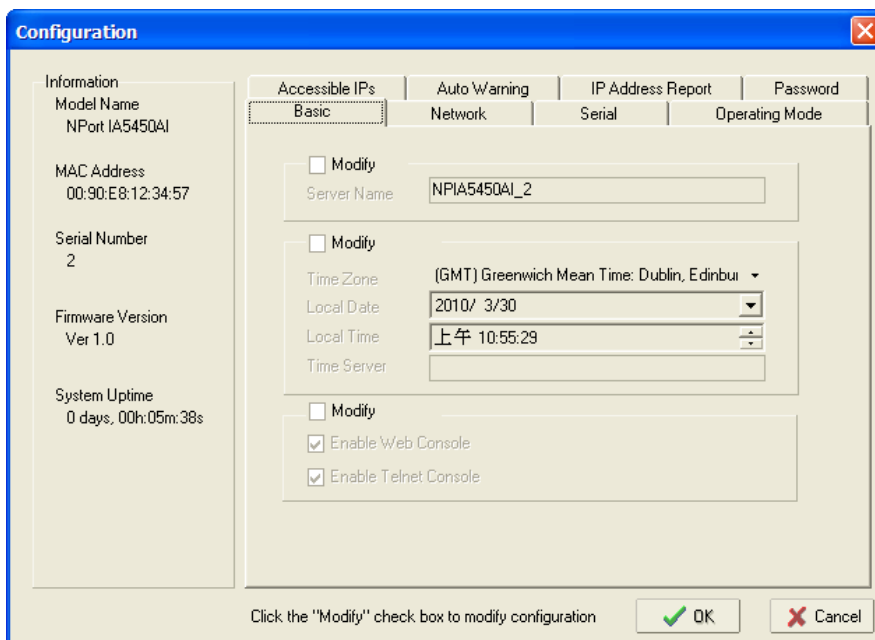

ATTENTION

You can simultaneously modify the configurations of multiple NPort IA5450As that are of the same model. To select multiple NPort IA5450As, hold down the Ctrl key when selecting additional NPort IA5450As, or hold down the Shift key to select a group of NPort IA5450As.

Upgrading the Firmware

Follow these steps to upgrade the firmware of an NPort IA5450A.

1. To start NPort Administrator, click **Start → NPort Administration Suite → NPort Administrator**.

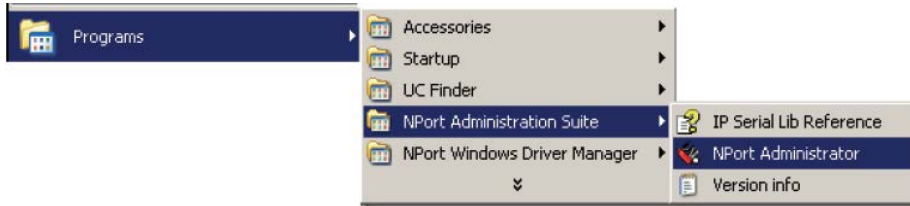

2. Unlock the NPort IA5450A you wish to configure if it is password protected. Right click a specific NPort IA5450A and select the **Upgrade Firmware** function to start upgrading the firmware.

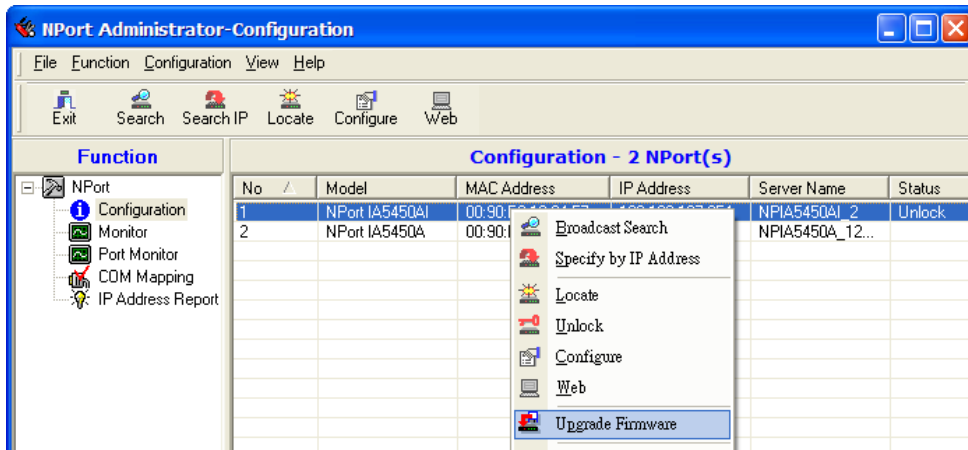

3. Select the correct ROM file to download.

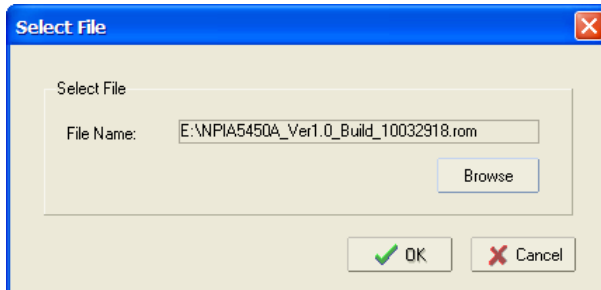

4. Wait while the Upgrade Firmware action is processed.

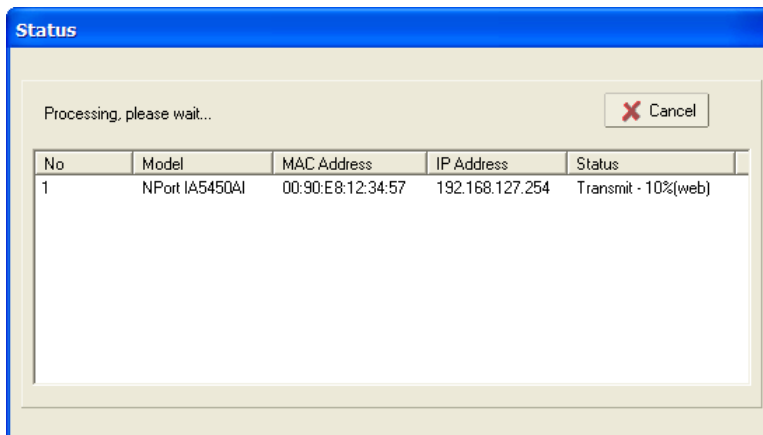



ATTENTION

You can simultaneously upgrade the firmware of multiple NPort IA5450As that are of the same model. To select multiple NPort IA5450As, hold down the Ctrl key when selecting an additional NPort IA5450A, or hold down the Shift key to select a block of NPort IA5450As.

Export Configuration

To export the configuration of an NPort IA5450A, right click the NPort IA5450A, select **Export Configuration**, and then follow the onscreen instructions. The Export Configuration function is a handy tool that can be used to produce a text file containing the current configuration of a particular NPort IA5450A.

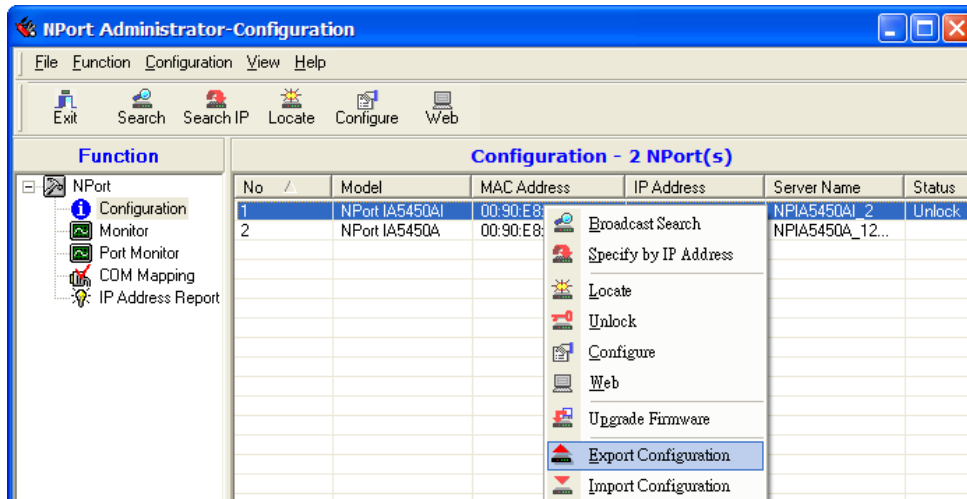

Import Configuration

The Import Configuration function is used to import an NPort IA5450A configuration from a file into one or more of the same model NPort IA5450A. To import a configuration, first select the target servers, click the right mouse button, and then select **Import Configuration**. Follow the onscreen instructions to locate the configuration file and start downloading the file.

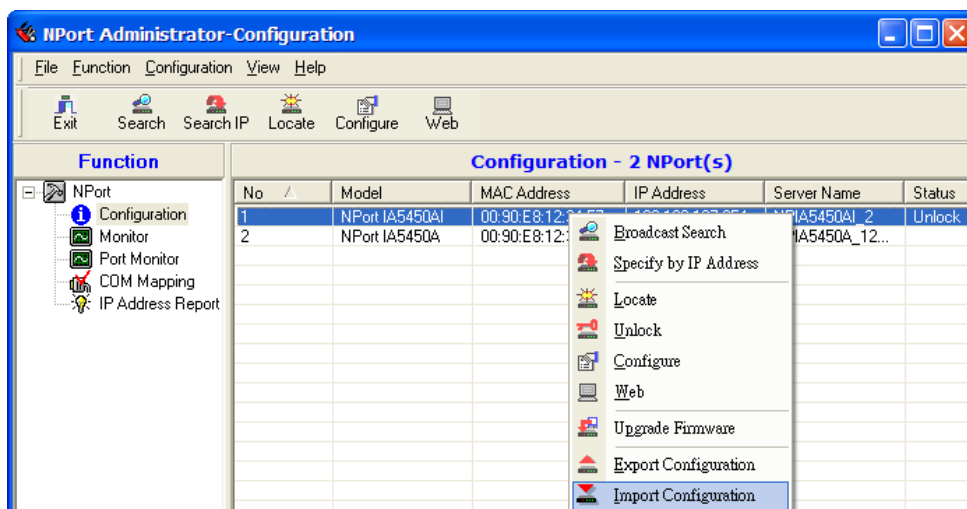



ATTENTION

You can simultaneously import the same configuration file into multiple NPort IA5450As that are of the same model.
 To select multiple NPort IA5450As, hold down the Ctrl key when selecting an additional NPort IA5450A, or hold down the Shift key to select a block of NPort IA5450As.

Monitor

Use following method to start the Monitor function.

Broadcast Search → Monitor → Add Target

1. With Configuration selected under Function, use Broadcast Search to locate all NPorts on your LAN.

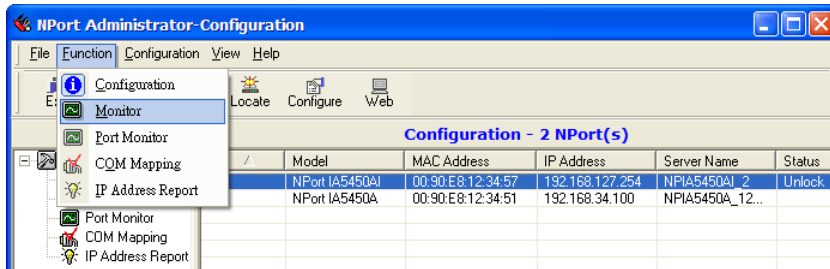

2. Next, click **Monitor → Add Target** and select your targets from the list, and then click **OK**.

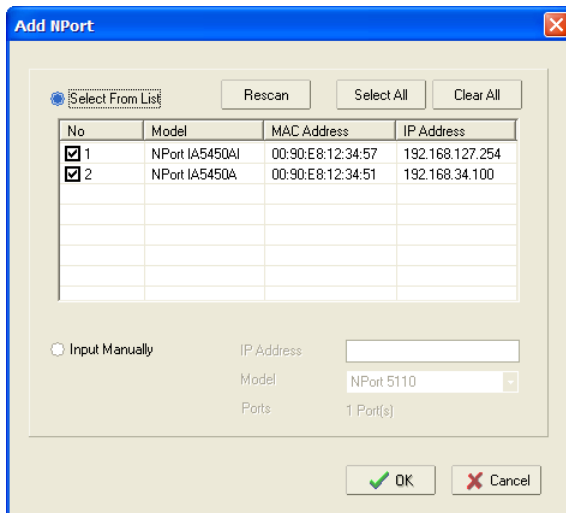
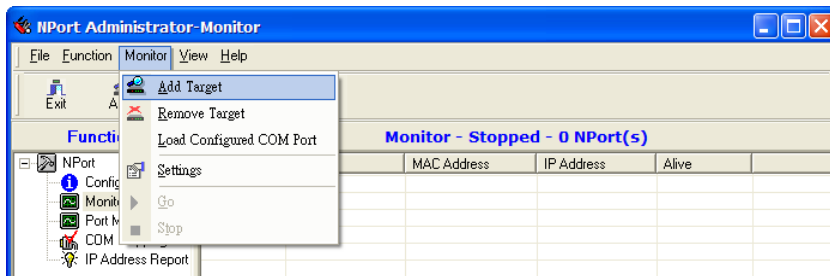

Once the Monitor function is running:

- The NPort IA5450A list will appear on the Monitor screen.

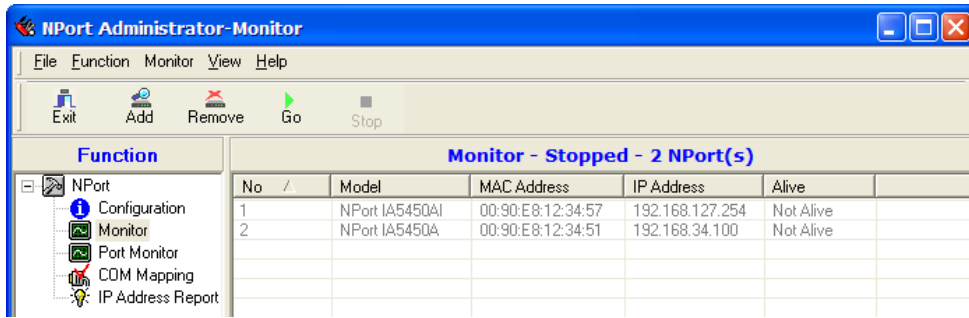

- Right click the panel and select **Settings**.

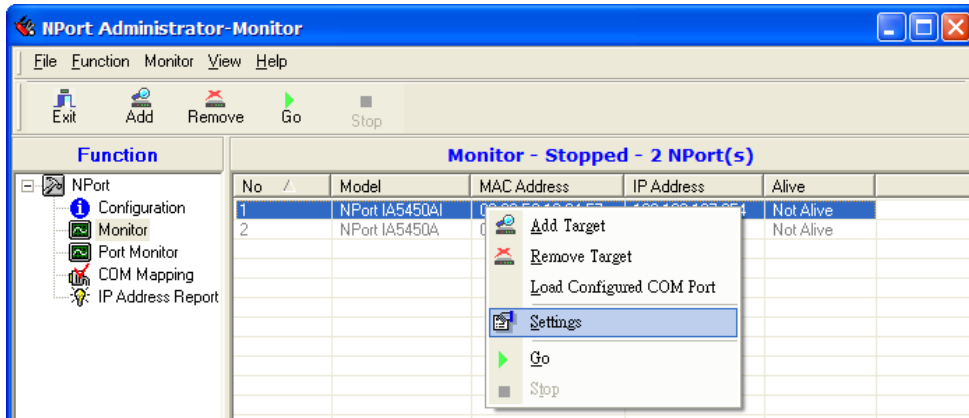

- Select or de-select **Monitor Items**. Use the single arrowhead buttons to move highlighted items from one box to the other. Use the double arrowhead buttons to move all items in one box to the other.

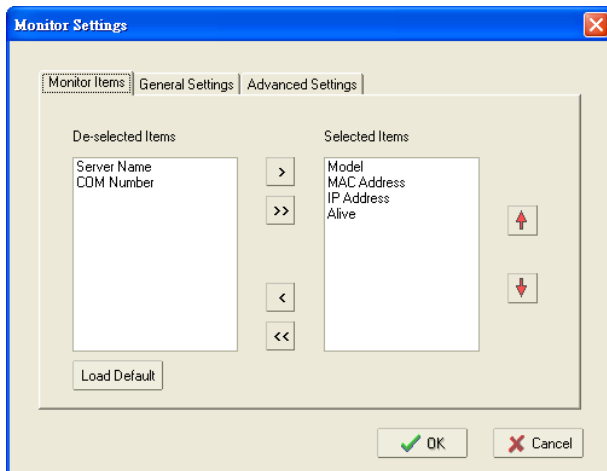

- Select a **Refresh Rate** (the default is 3 seconds) on the General Settings page.

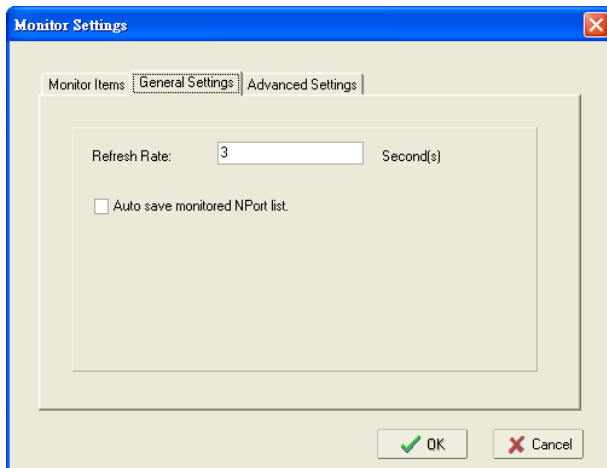

- On the **Advanced Settings** page, select **Display warning message for new event** and/or **Play warning music for new event**. In the second case, you must enter the path to the WAV file that you want to be played. "New event" means that one of the NPort IA5450As in the monitor is "Alive" or "Not Alive," or has lost connection with the Monitor program.

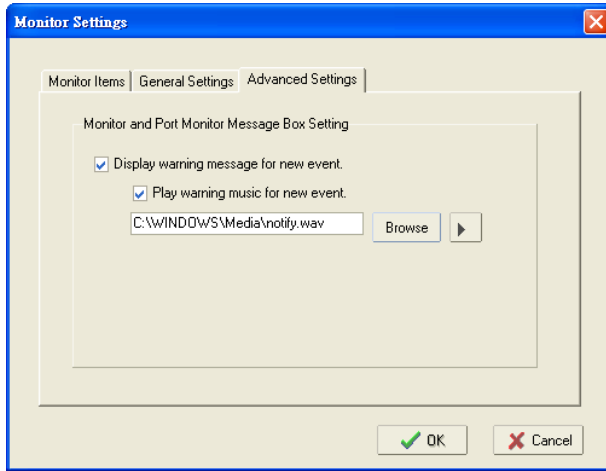

- Right click in the NPort IA5450A list section and select **Go** to start Monitoring the NPort IA5450A.

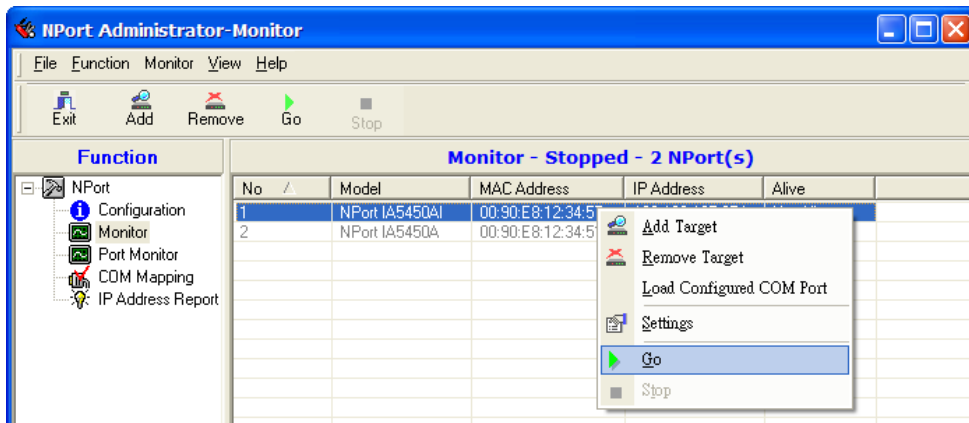

- For this example, the NPort IA5450As shown in the list will be monitored.

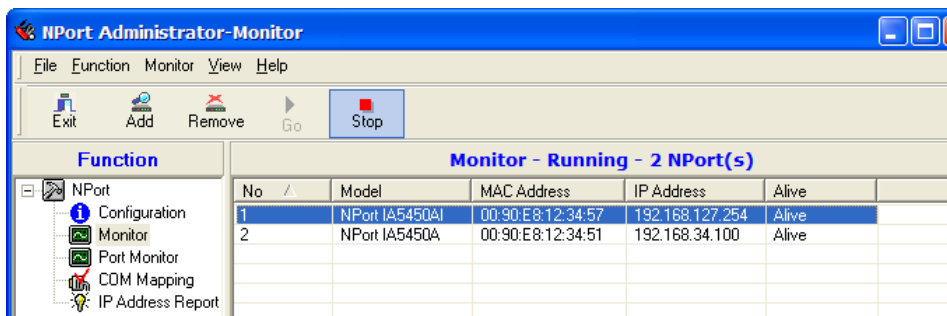

- When one of the NPort IA5450As loses connection with the Monitor program, a warning alert will display automatically. The warning music will be played at the same time.

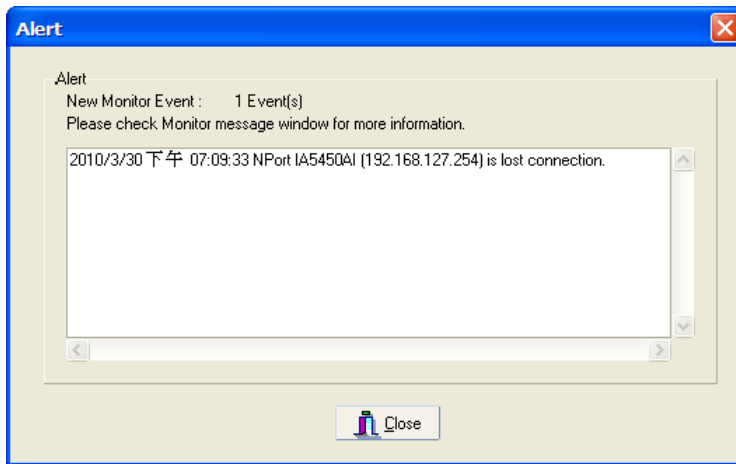

- In the Monitor screen, you can see that the NPort IA5450As that are "Not Alive" are shown in red color.

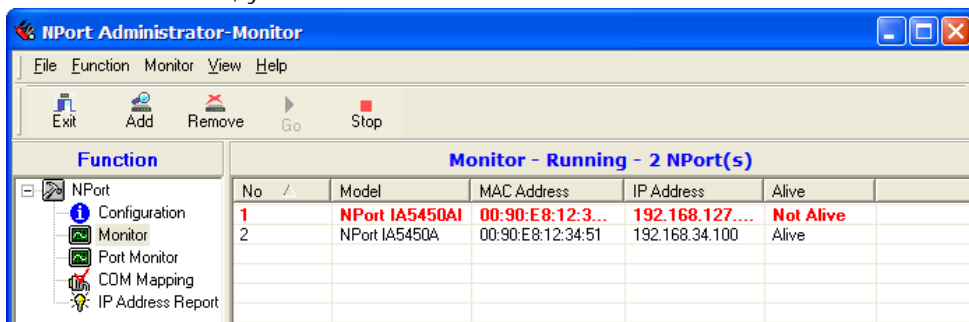

- If the NPort IA5450A gets reconnected, a warning will be displayed to remind the user that the NPort IA5450A is now "Alive."

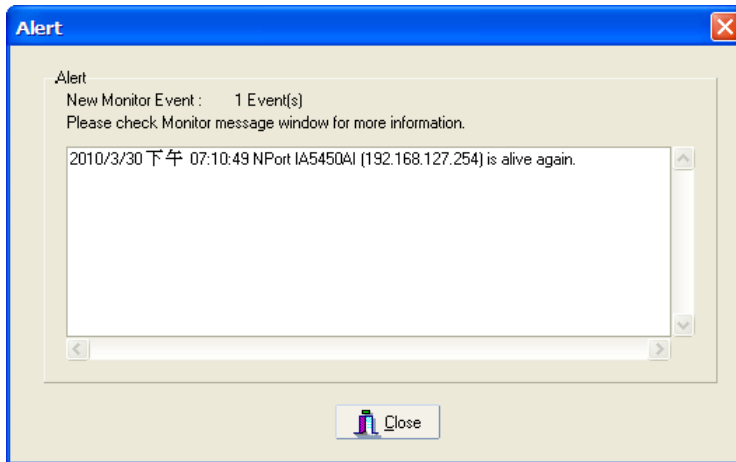

- The NPort IA5450As that were reconnected, and are now "Alive," will be shown in black color.

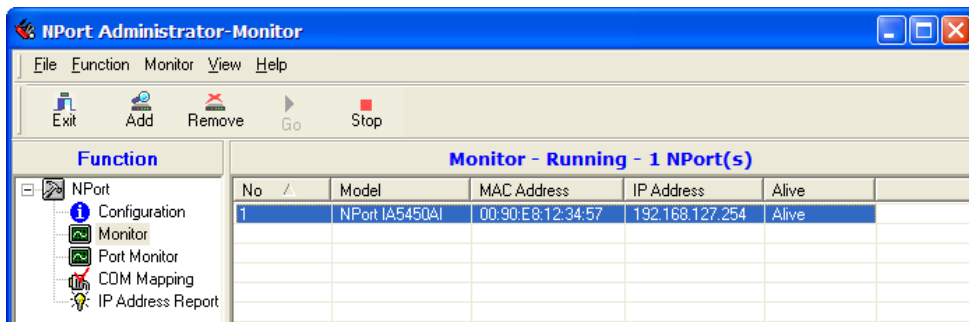

Port Monitor

The process described here is the same as in the previous “Monitor” section. The only difference is that you can select more items under Port Monitor than under Monitor.

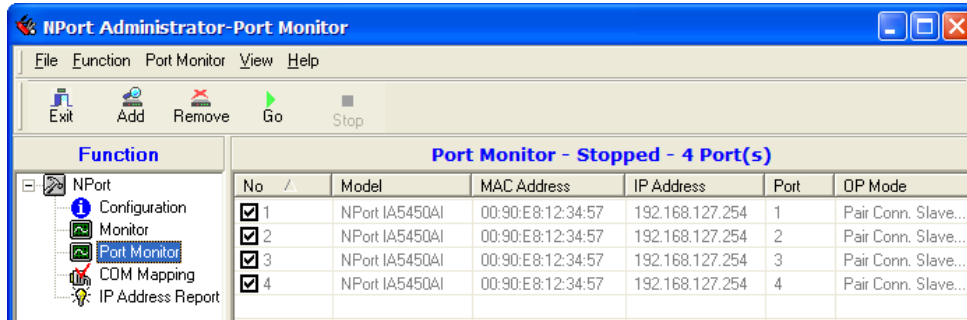

Select or de-select **Monitor Items**. Use the single arrowhead buttons to move highlighted items from one box to the other. Use the double arrowhead buttons to move all items in one box to the other.

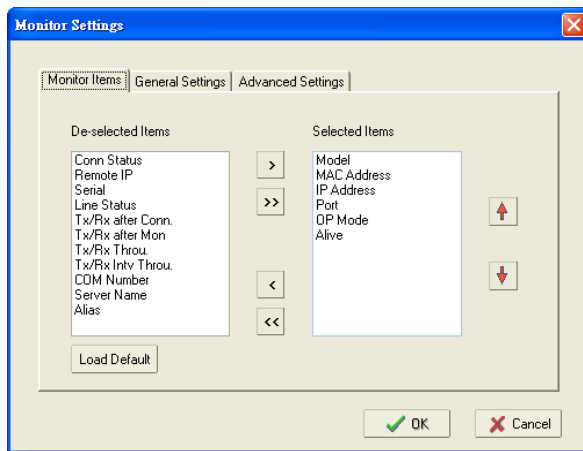

COM Mapping

Windows Administration Suite comes with Windows 95/98/ME/NT/2000/XP/7 Real COM drivers. After you install NPort Administration Suite, there are two ways to set up the NPort IA5450A serial port as your host’s remote COM port.

The first way is with **On-line COM Mapping**. On-line COM Mapping will check to make sure that the NPort IA5450A is connected correctly to the network and then install the driver on the host computer.

The second way is with **Off-line COM Installation**, without first connecting the NPort IA5450A to the network. Off-line COM Mapping can decrease the system integrator’s effort by solving different field problems. Via off-line installation, users can first process software installation for the host, and then install the NPort IA5450A to different fields.

Use the following procedure to map COM ports:

1. On-line COM Mapping:
Connect the NPort IA5450A to the network → Set the NPort IA5450A to the proper IP address → Map COMs to your host → Apply Change.
2. Off-line COM Mapping:
Map COMs to your host → Apply Change → Connect the NPort IA5450A to the network → Configure the NPort IA5450A’s IP address.

On-line COM Mapping

1. Broadcast Search for NPort IA5450As on the network.

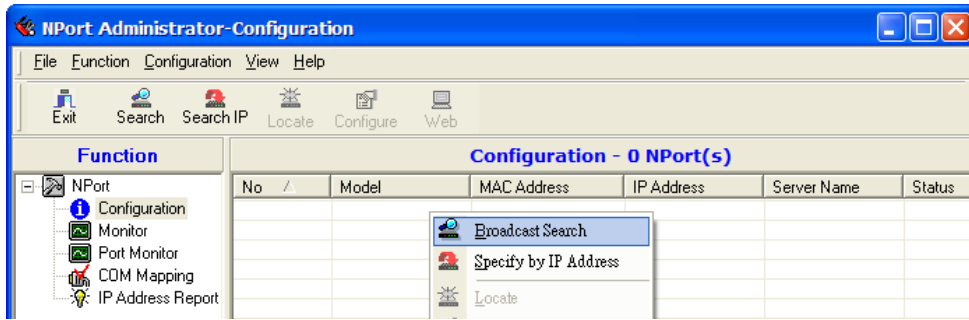

2. Select the COM Mapping function group.

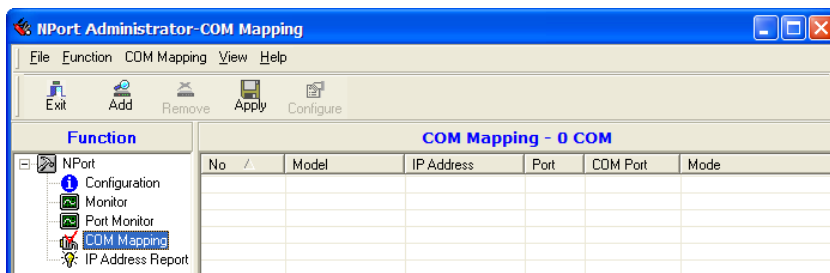

3. Add the target to which you would like to map COM ports.

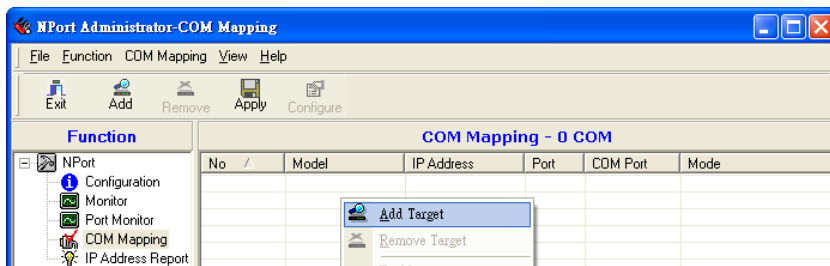

4. The NPort IA5450A list that appears is the list generated by the previous Broadcast Search. Select the NPort IA5450A to which you would like to map COM ports.

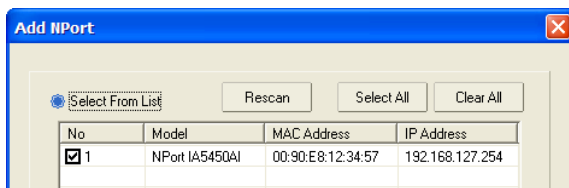

5. Select COM Settings to modify COM No., default setting, etc.

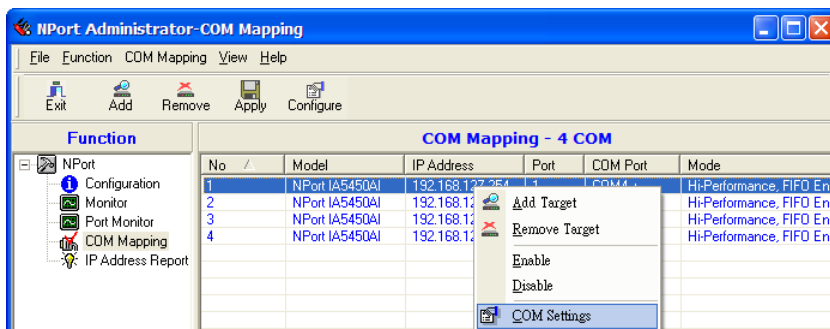

6. Select the **COM Number**.

COM ports that are "In use" or "Assigned" will also be indicated in this drop-down list. If you select multiple serial ports or multiple NPort IA5450As, remember to check the "Auto Enumerating" function to use the COM No. you select as the first COM No.

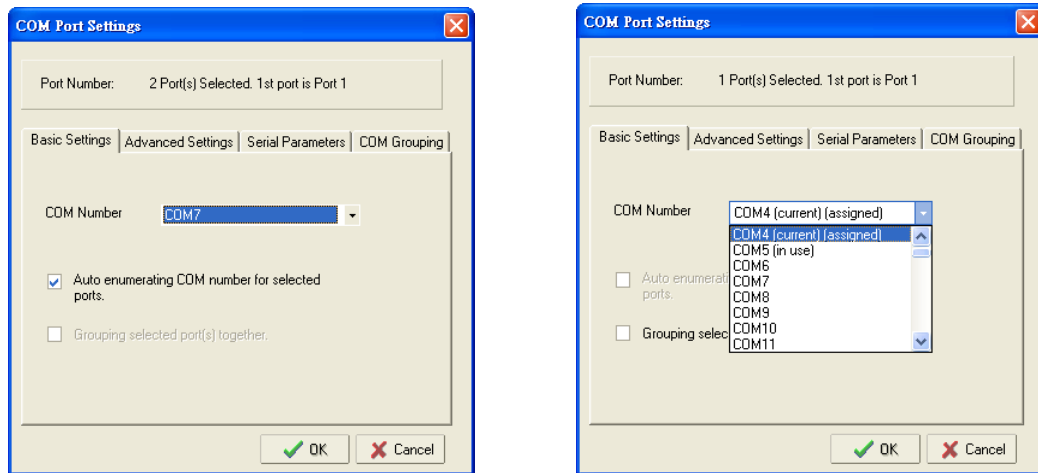
7. **Hi-performance** mode is the default for Tx mode. If the driver completes sending data out to the NPort IA5450A, the driver will respond "Tx Empty" to the program.

Under **classical mode**, the driver will not notify the user's program that Tx is completed until all Tx data has been sent out from the NPort IA5450A; this mode will cause lower throughput. If you want to ensure that all data is sent out before further processing, classical mode is recommended.

Enable/Disable Tx/Rx FIFO. If disabled, the NPort IA5450A will send one byte each time the Tx FIFO becomes empty; and an Rx interrupt will be generated for each incoming byte. This will result in a faster response and lower throughput. If you want to use XON/XOFF flow control, we recommend setting FIFO to Disable.

Fast Flush (only flush local buffer)

- For some applications, the user's program will use the Win32 "PurgeComm()" function before it reads or writes data. With our design, after the program uses this Purge Comm() function, the NPort driver will keep querying the NPort's firmware several times to make sure there is really no data queued in the NPort firmware buffer, rather than just flushing the local buffer. This kind of design is used because of some special considerations. However, it might take more time (on the order of several hundred milliseconds) than a native COM1, because it needs to work via Ethernet. That's why the native COM ports on the motherboard can work fast with this function call, but the NPort requires much more time. In order to accommodate other applications that require a faster response time, the new NPort driver implements a new "Fast Flush" option. Note that by default, this function is disabled.
- To begin with, make sure there are some "PurgeComm()" functions being used in your application program. In this kind of situation, you might find that your NPort exhibits a much poorer operation performance than when using the native COM1 port. Once you have enabled the "Fast Flush" function, you can check to see if there has been an improvement in performance.
- By default, the optional "Fast Flush" function is disabled. If you would like to enable this function, from the "NPort Administrator," double click the COM ports that are mapped to the NPort, and then select the "Fast Flush" checkbox. You should find that when "Fast Flush" is enabled, the NPort driver will work faster with "PurgeComm()."

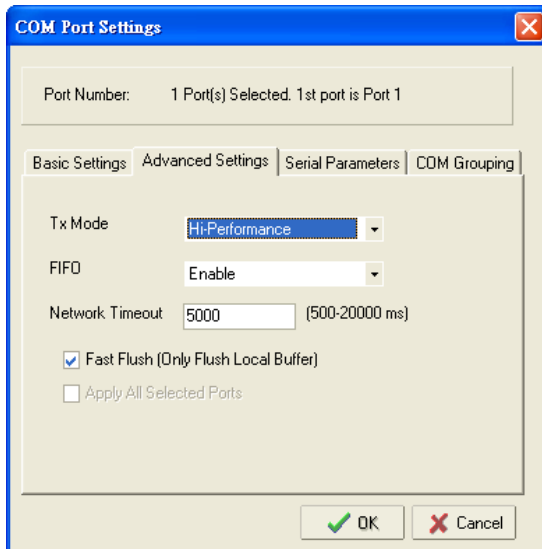

- The Serial Parameter settings shown here are the default settings when the NPort IA5450A is powered on. However, the program can redefine the serial parameters to different values after the program opens the port via Win32 API.

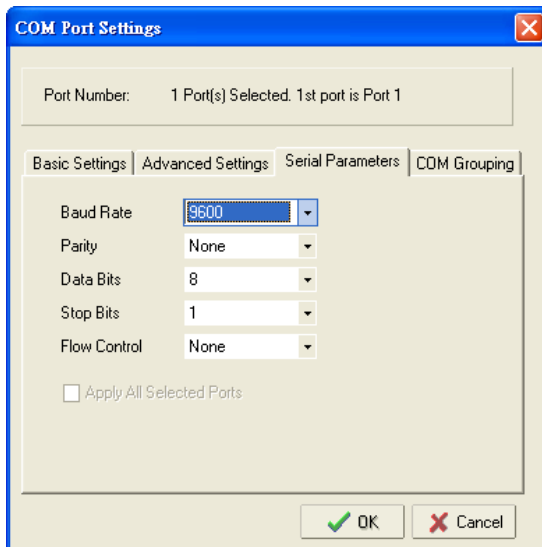

- After setting the COM Mapping, remember to select **Apply Change** to save the information in the host system registry. The host computer will not have the ability to use the COM port until after **Apply Change** is selected.

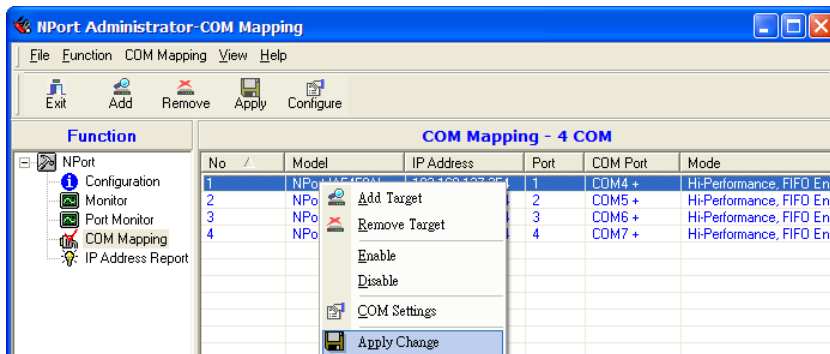

10. Select **Discard Change** to tell Administrator NOT to save the COM Mapping information to the host.

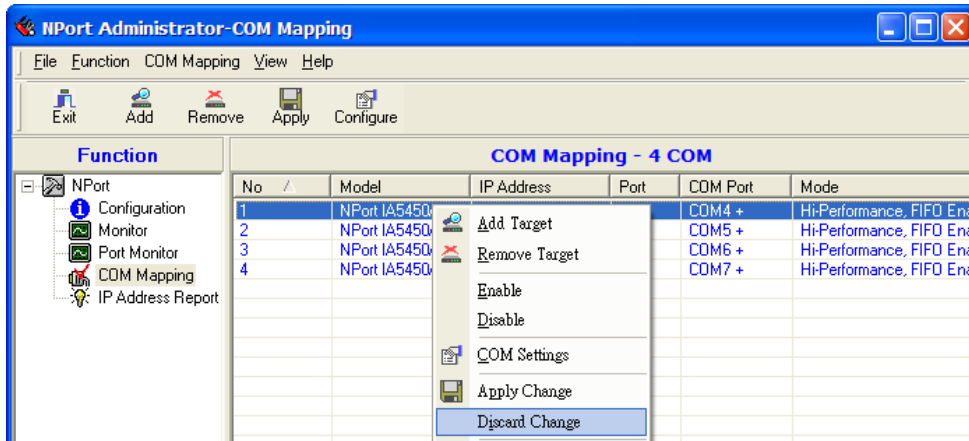

11. To save the configuration to a text file, select **Export COM Mapping**. You will then be able to import this configuration file to another host and use the same COM Mapping settings in the other host.

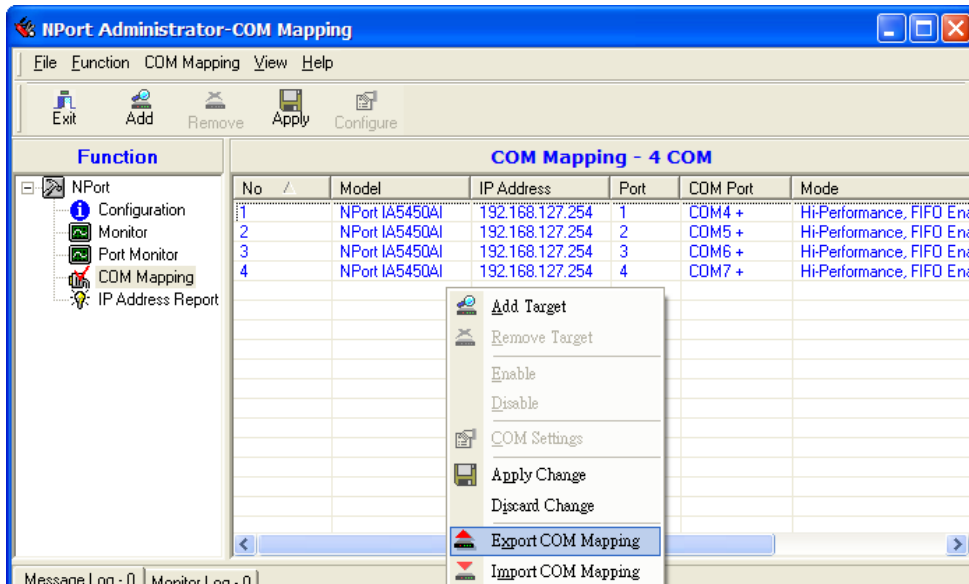

Off-line COM Mapping

1. Add a target by inputting the IP address and selecting the Model Name without physically connecting the NPort IA5450A to the network.

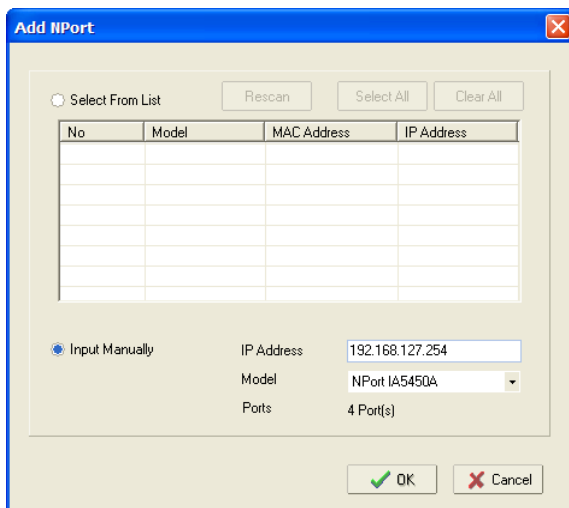

2. Modify the port settings as needed.

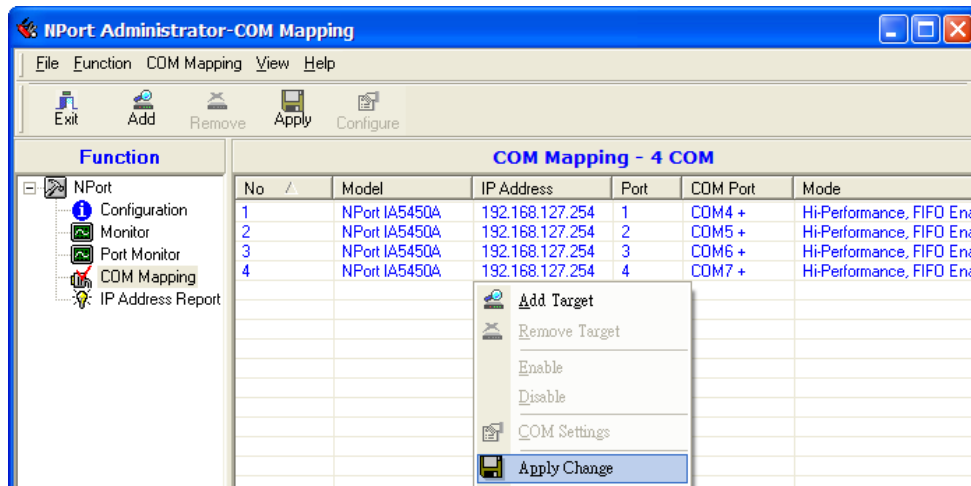

3. Right click in the NPort list section and select **Apply Change**.

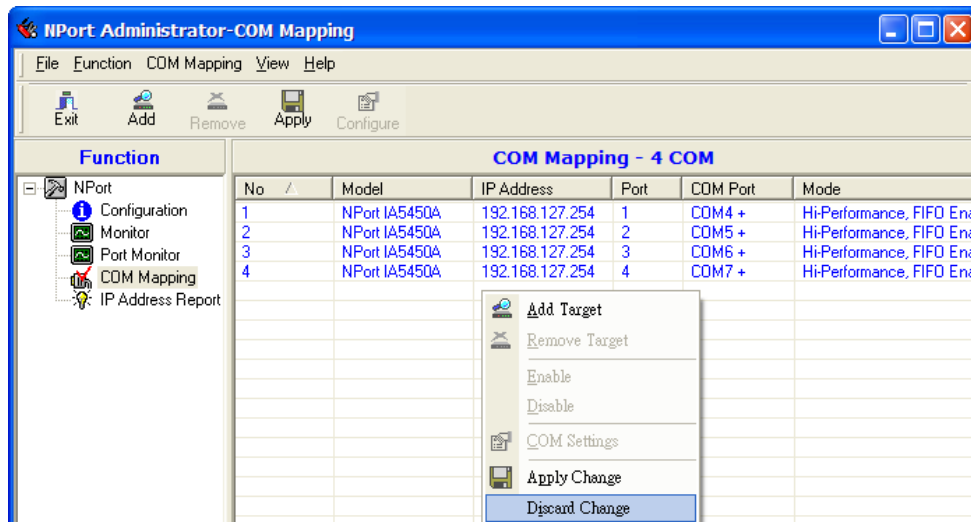

COM Grouping

The “COM Grouping” function is designed to simulate the multi-drop behavior of serial communication over an Ethernet network. COM Grouping allows you to create a COM Group and redirect data from it to several physical COM ports on NPort device servers. With COM Grouping, you will be able to control multiple physical serial ports simultaneously by operating only one COM port.

Creating a COM Group

Follow the steps below to add multiple COM ports into one group:

1. Select serial port(s) for the group that you are going to create, and right-click to select **COM Settings**.

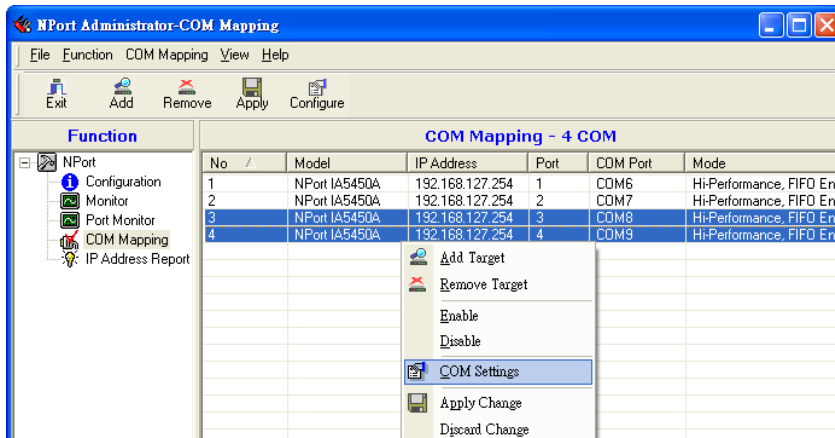

2. Select a COM number for this COM group. You may select one of the ports already assigned to a member of the COM Group. However, once the COM Group is configured, all of the original COM number(s) within the group will be released simultaneously.

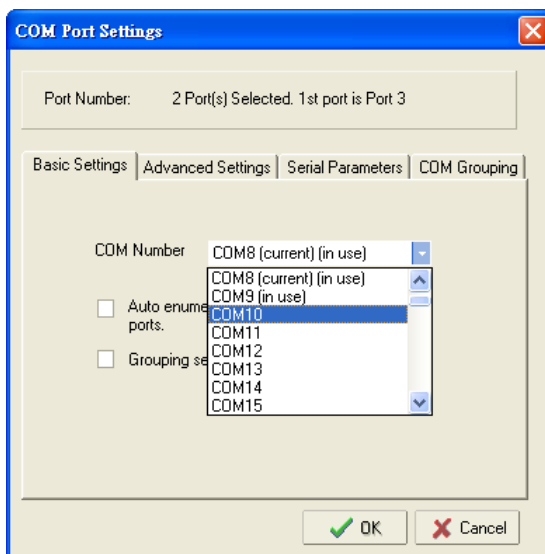

ATTENTION

The COM Grouping function only supports Windows NT, 2000, and later. The maximum number of ports for each group is 32.

3. Select the **Grouping selected port(s) together** checkbox.

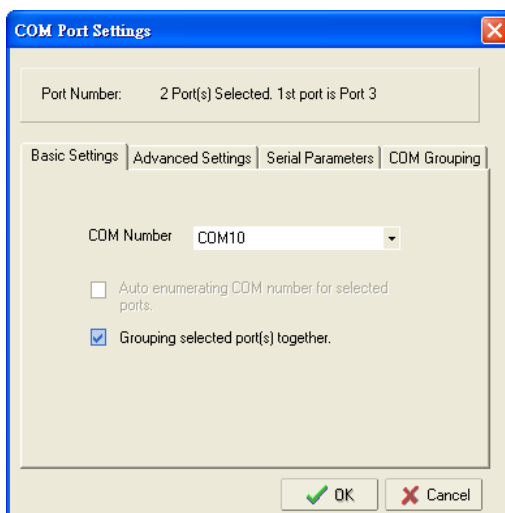

- On the **COM Grouping** page, you can set “Read” and “Write” permissions for every serial port. It is necessary to set **Signal Status** in order to control the data transmission with specified control signals (e.g., DTR/RTS). You can assign one serial port whose signals will be taken into account by the COM Group.

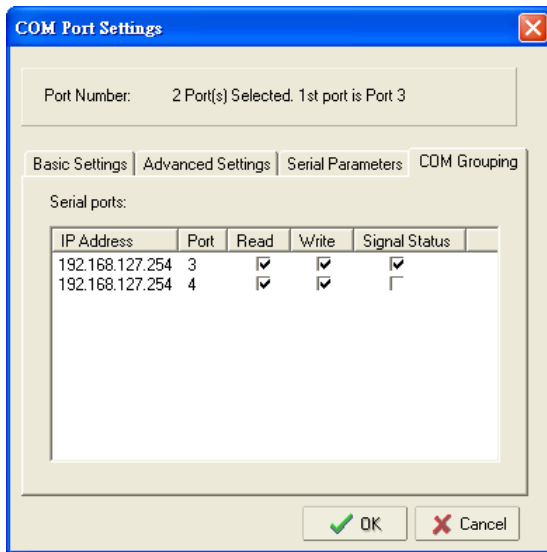

- Click OK, and confirm that the serial ports that were assigned. The COM Port column confirms that your selected ports are labeled as part of a “Group.” You will be able to view the serial ports that were assigned to and removed from the Group. Click **Apply** to apply the settings.

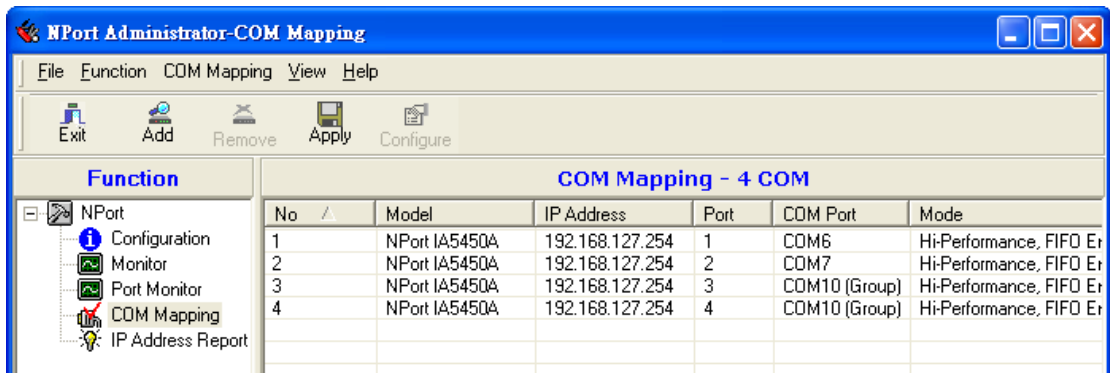

- Finally, click Yes to confirm.

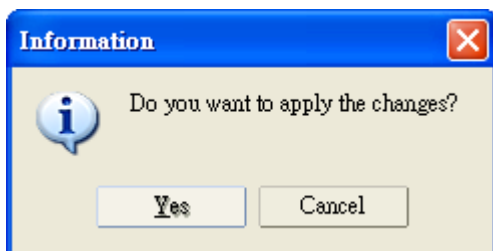

Deleting a COM Group

Follow the steps below to delete a COM Group and then auto-assign COM numbers for each port in the Group:

- Select all serial ports in the Group you are deleting and then right-click to select **COM Settings**.

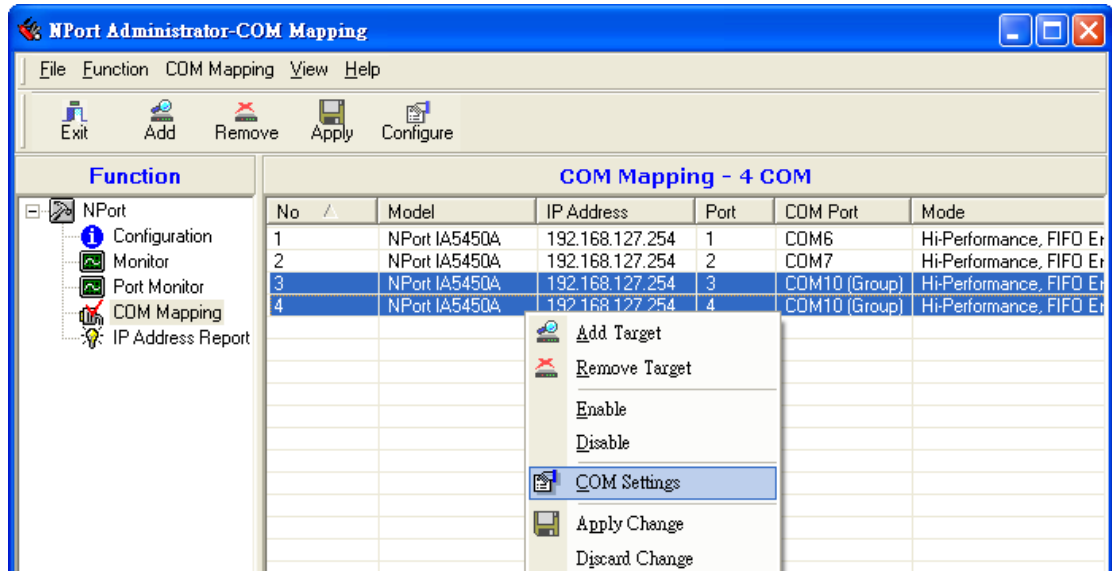

2. Select a COM number for this COM group and check the **Auto enumerating COM number for selected ports** to use the COM number you select as the first starting COM number, and then click OK.

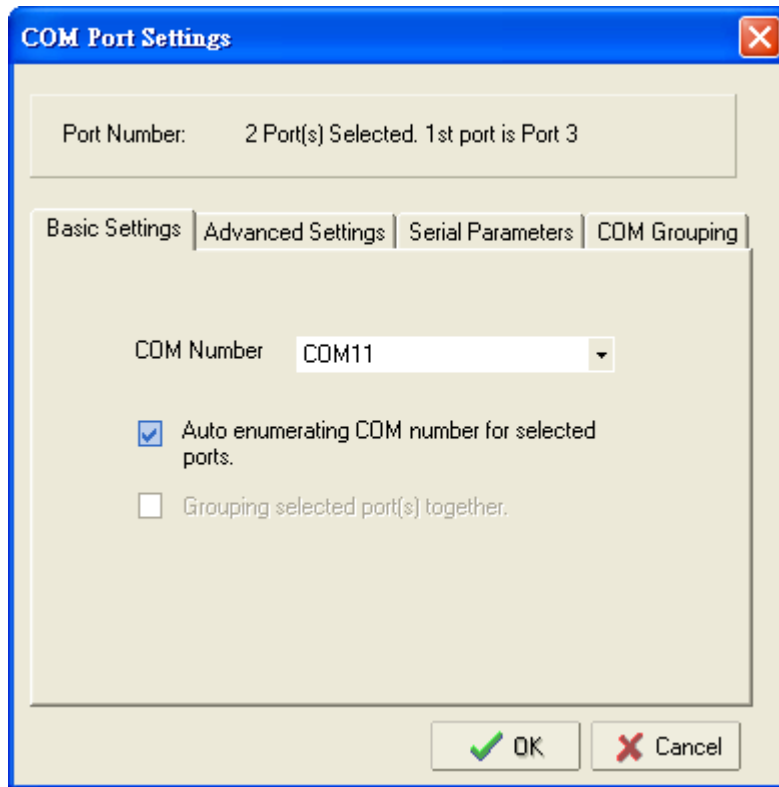

3. You will be able to view the serial ports that were assigned to and removed from the Group. Click **Apply** to apply the settings.

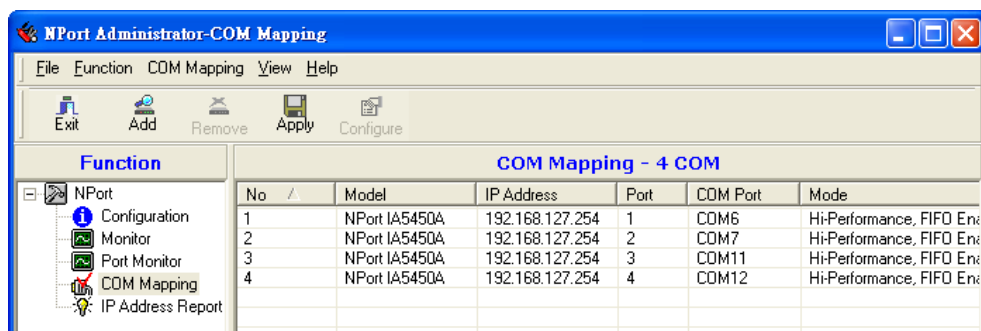

4. Finally, click Yes to confirm.

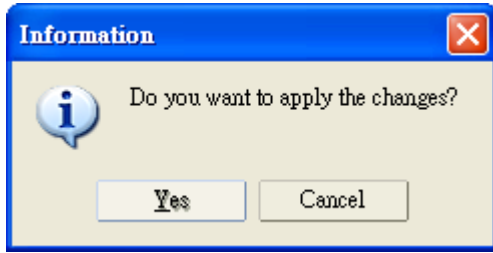

Adding a Port to a COM Group

Follow the steps below to add a serial port into an existing COM Group:

1. Select the serial port that you are adding and right-click to select **COM Settings**.

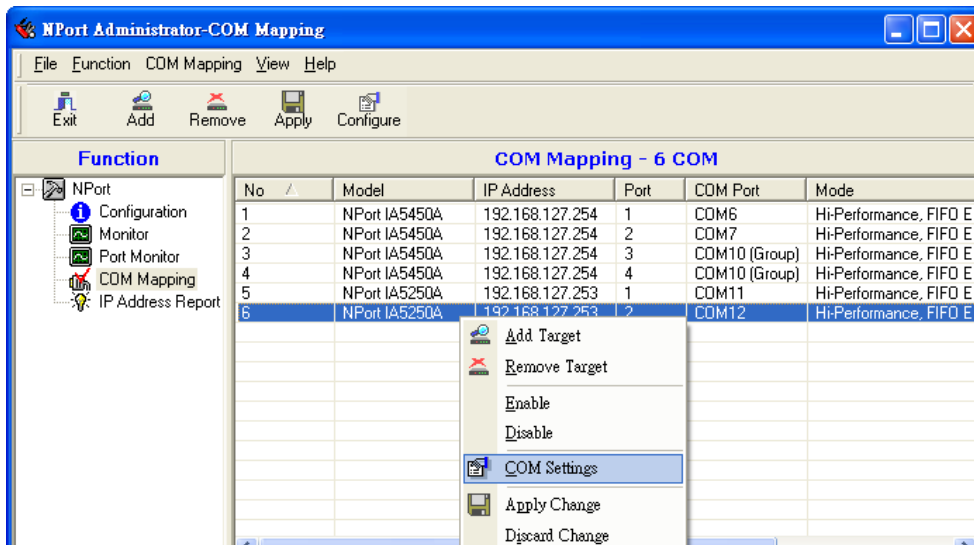

2. Select the COM number of the COM Group you are adding and check mark the **Grouping selected port(s) together** check box and then click OK.

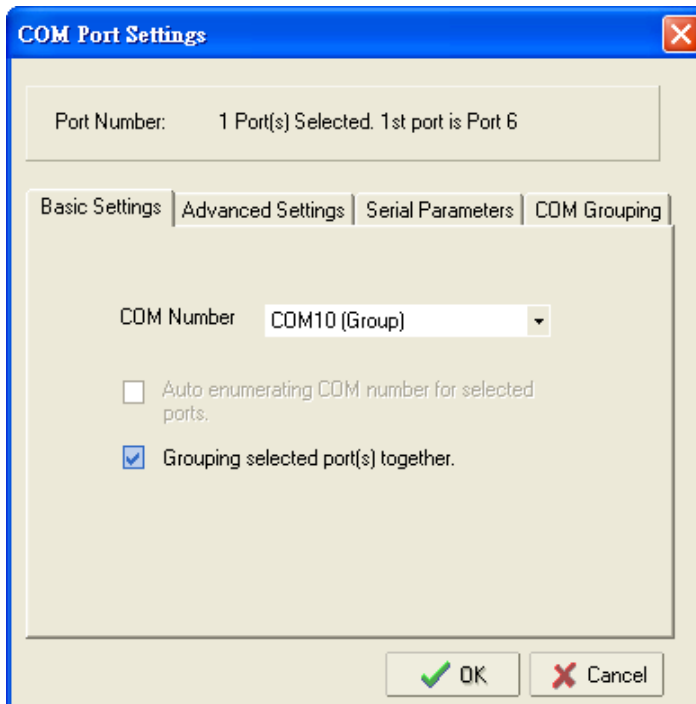

- You will be able to view the serial ports that were assigned to and removed from the Group. Click **Apply** to apply the settings.

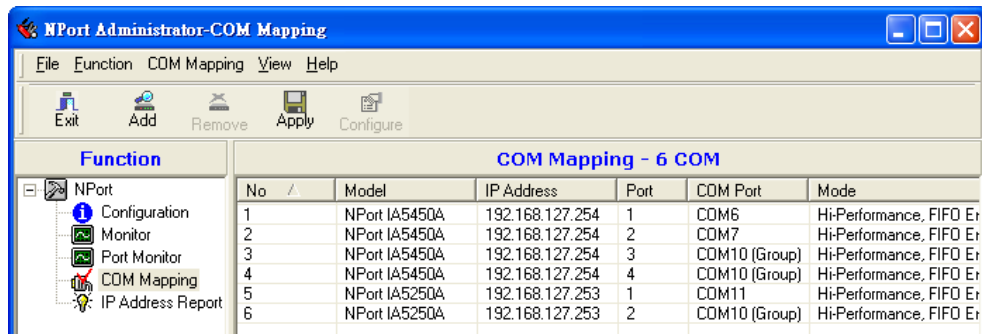

- Finally, click Yes to confirm.

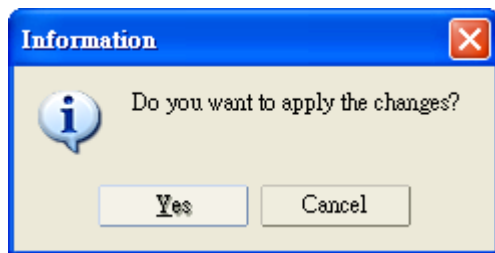

Removing a Port from a COM Group

Follow the steps below to remove a serial port from a COM Group:

- Select a serial port in the Group and right-click to select **COM Settings**.

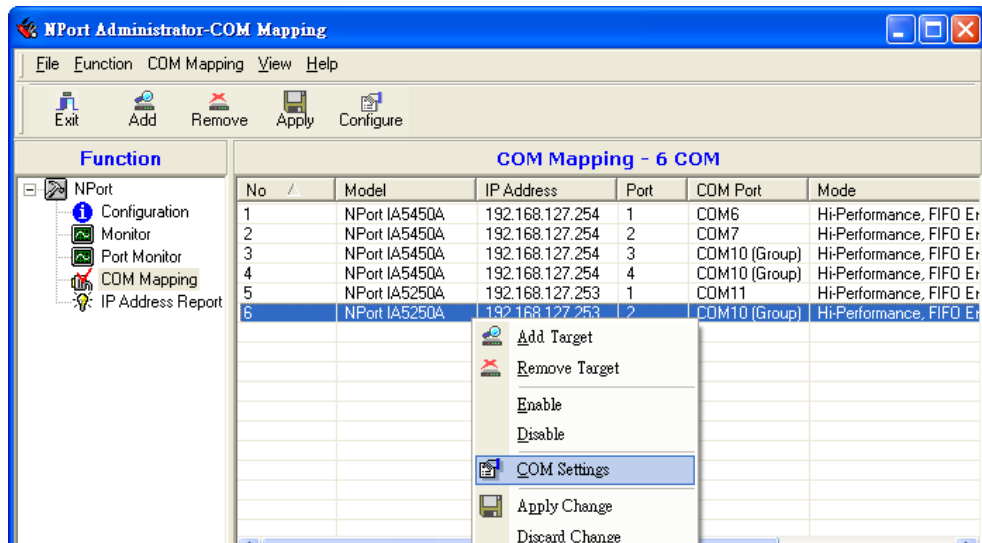

2. Select a COM number that is not in use or assigned to a Group and click OK.

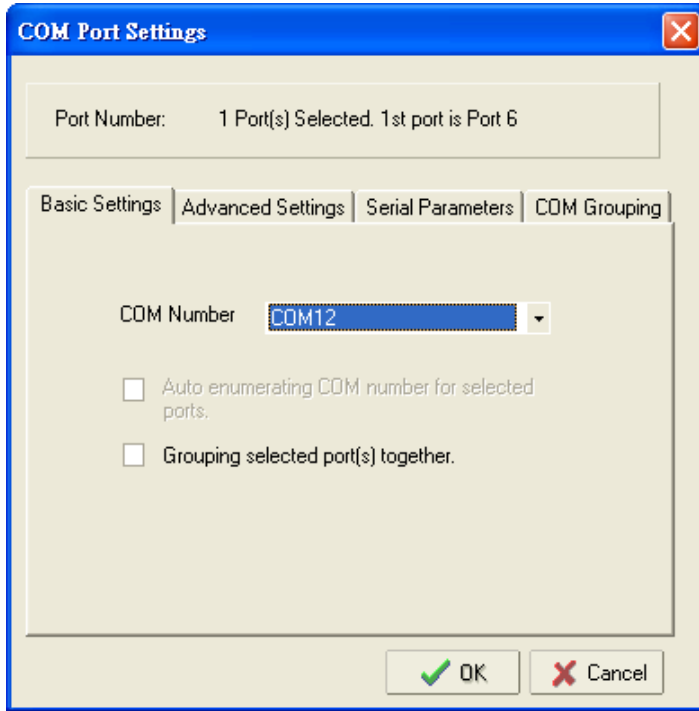

3. You will be able to view the serial ports that were assigned to and removed from the Group. Click **Apply** to apply the settings.

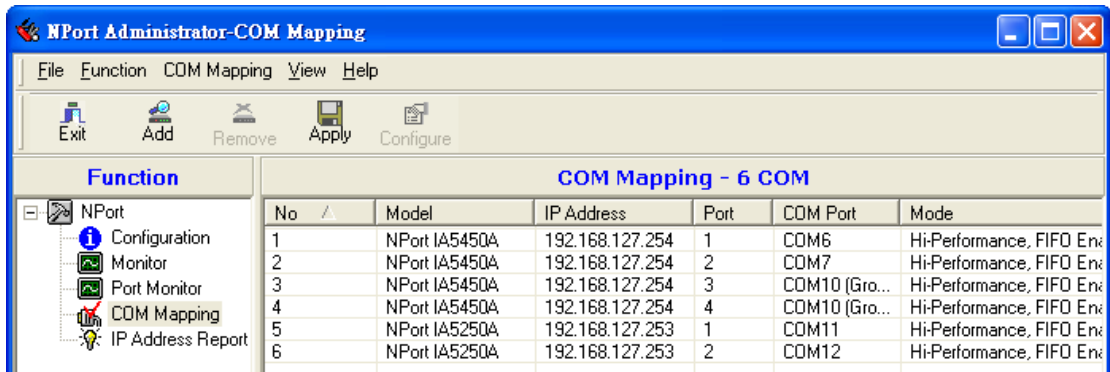

4. Finally, click Yes to confirm.

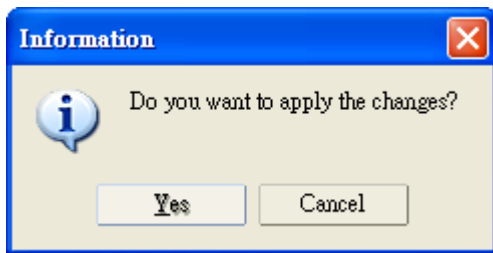

Modify Ports in a COM Group

In the following subsections we examine three ways in which the serial ports in a COM Group can be modified:

Changing the COM Number of a COM Group

1. Select all serial ports in the Group and right-click to select **COM Settings**.

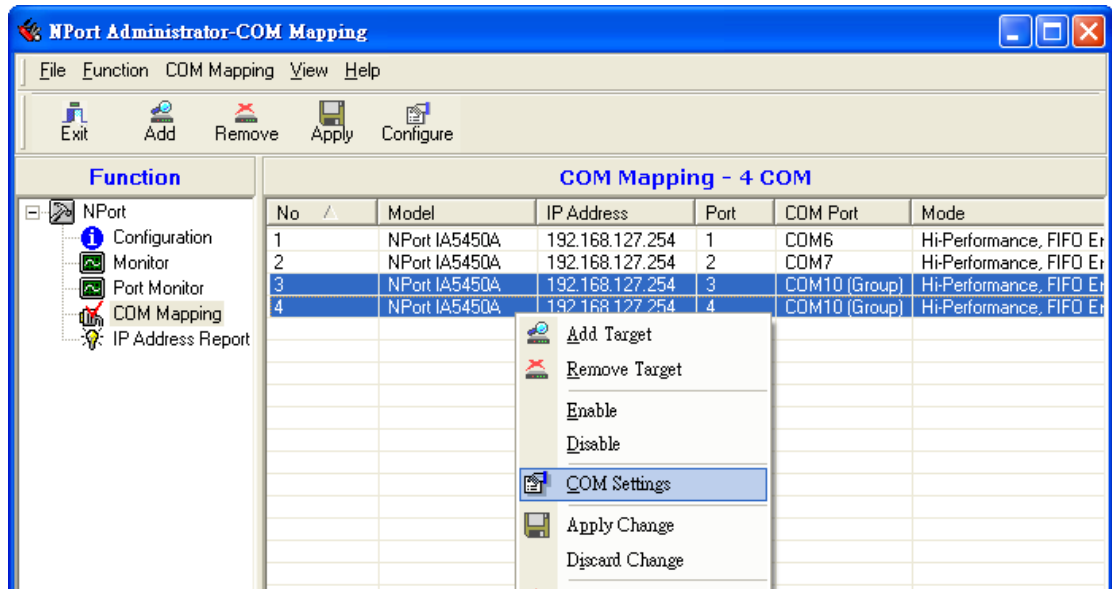

2. Select a COM number that is not in use or assigned to a Group.

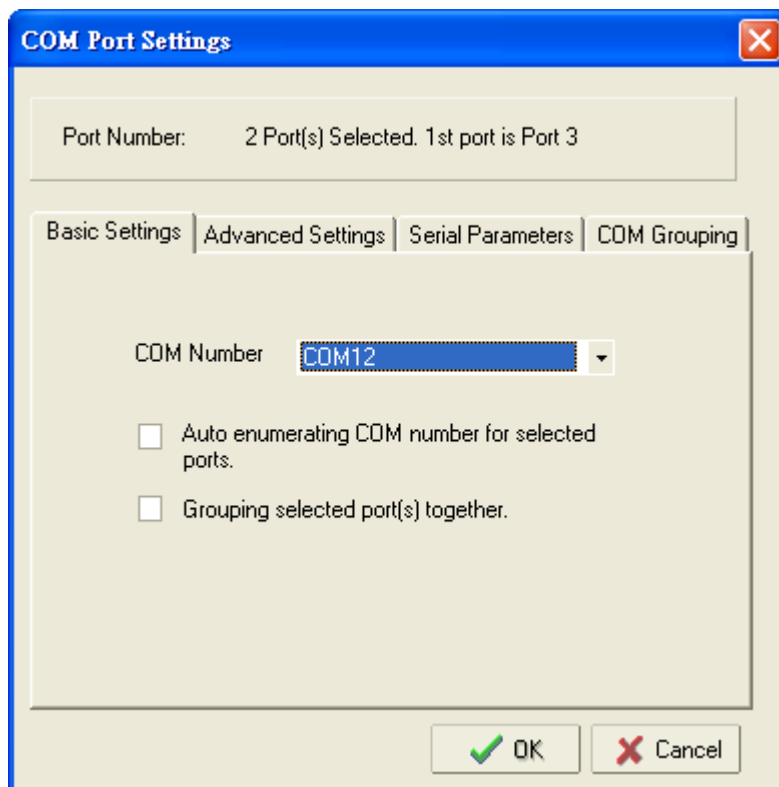

3. Select the **Grouping selected port(s) together** checkbox and then click **OK**.

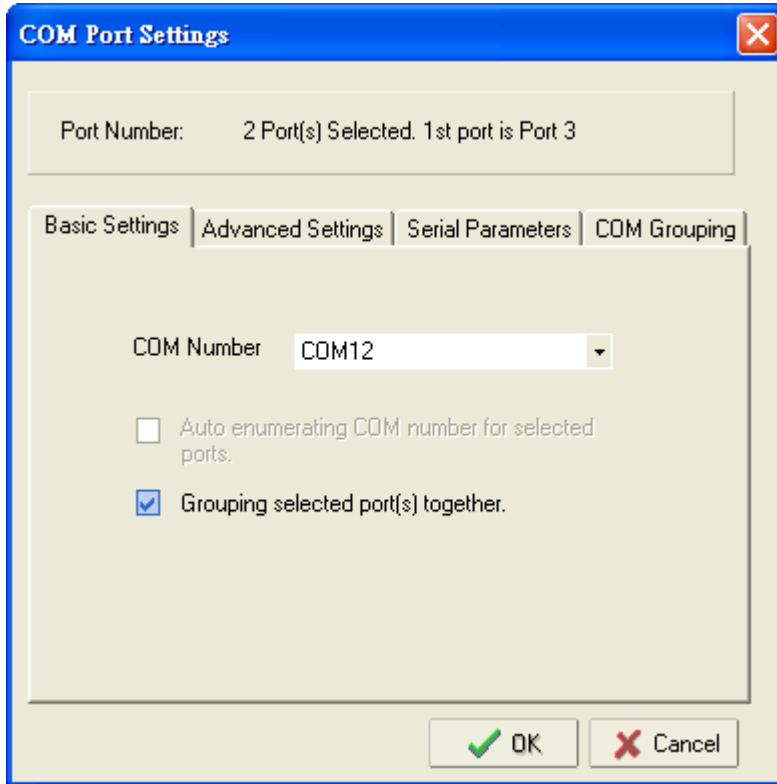

4. You will be able to view the serial ports that were assigned to and removed from the Group. Click **Apply** to apply the settings.

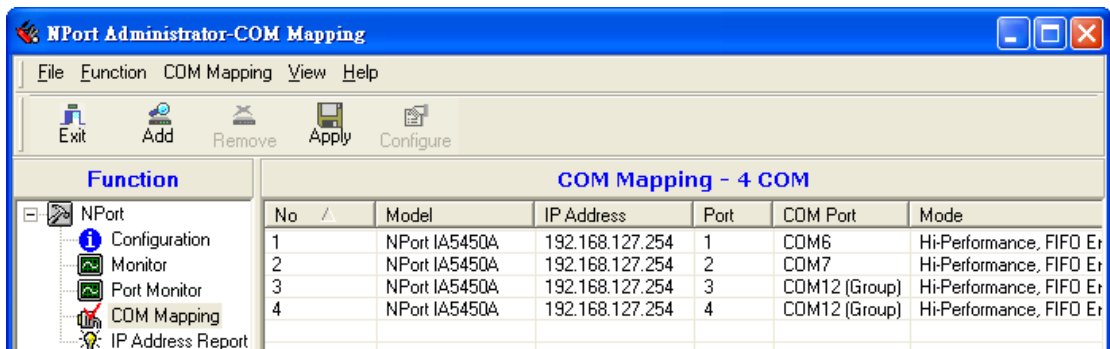

5. Finally, click Yes to confirm.

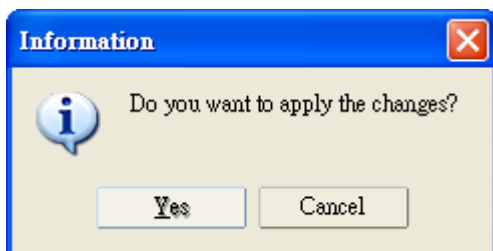

Changing Advanced Settings and Serial Parameters of the COM Group

1. Check the port specified on the **COM Grouping** page as the signal port.

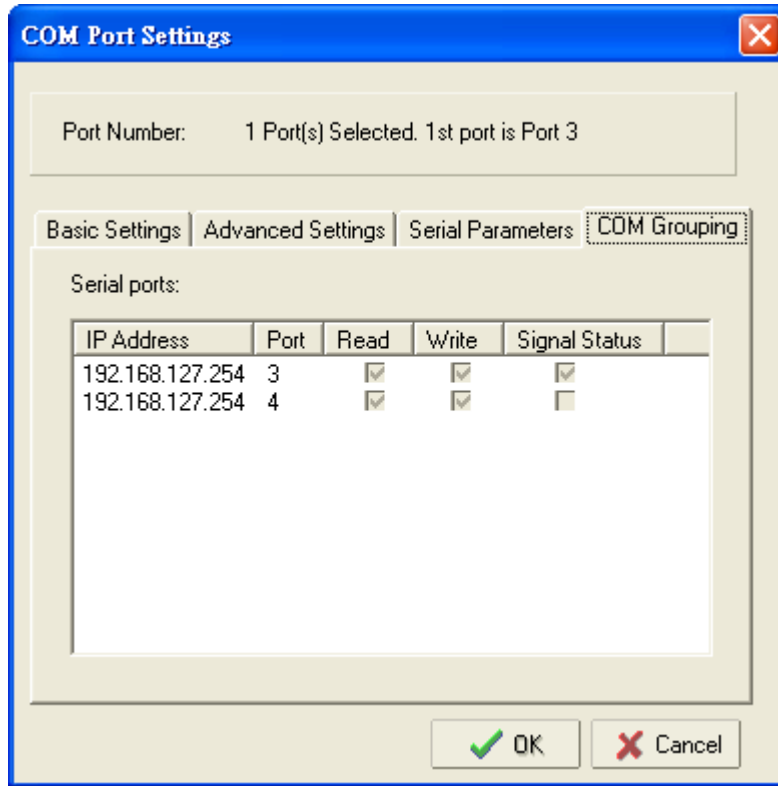

2. Select the "Signal Status" controlled port and then right-click and select **COM Settings**.

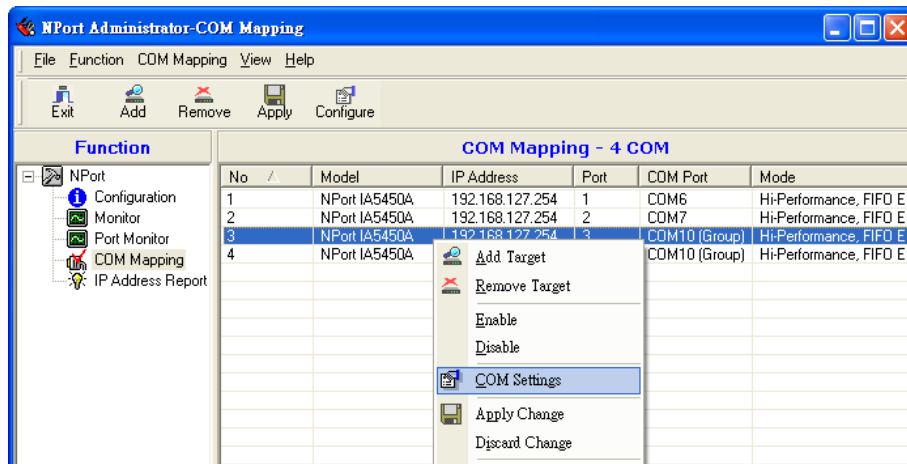

- The **Advanced Settings** and **Serial Parameters** pages will be available for modification.

The screenshot shows the 'COM Port Settings' dialog box with the 'Advanced Settings' tab selected. The 'Port Number' field shows '1 Port(s) Selected. 1st port is Port 3'. The 'Tx Mode' dropdown is set to 'Hi-Performance', 'FIFO' is 'Enable', and 'Network Timeout' is '5000 (500-20000 ms)'. There are two unchecked checkboxes: 'Fast flush (only flush local buffer)' and 'Apply all selected ports'. 'OK' and 'Cancel' buttons are at the bottom.

The screenshot shows the 'COM Port Settings' dialog box with the 'Serial Parameters' tab selected. The 'Port Number' field shows '1 Port(s) Selected. 1st port is Port 3'. The 'Baud Rate' dropdown is '9600', 'Parity' is 'None', 'Data Bits' is '8', 'Stop Bits' is '1', and 'Flow Control' is 'None'. There is one unchecked checkbox: 'Apply all selected ports'. 'OK' and 'Cancel' buttons are at the bottom.

Changing the Serial Port Specified as Signal Port for the COM Group

1. Select a serial port in the Group and then right-click and select **COM Settings**.

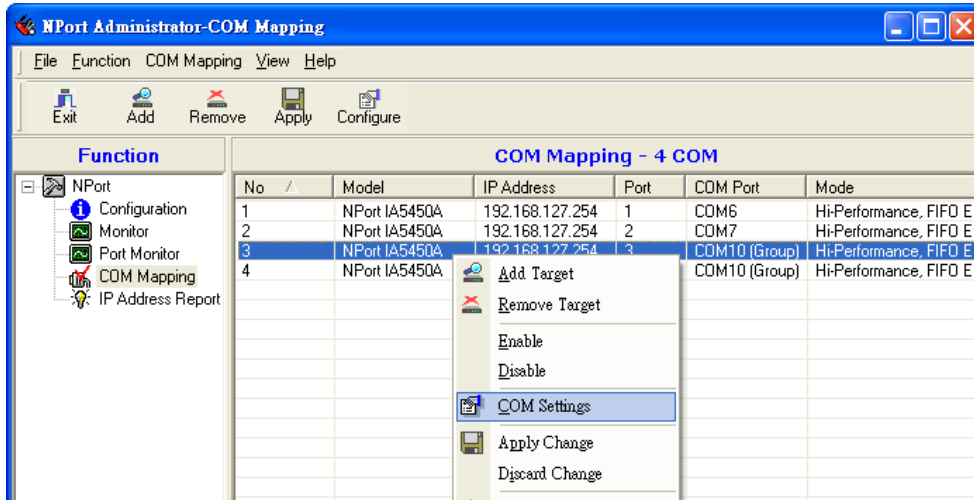

2. Check the **Grouping selected port(s) together** check box.

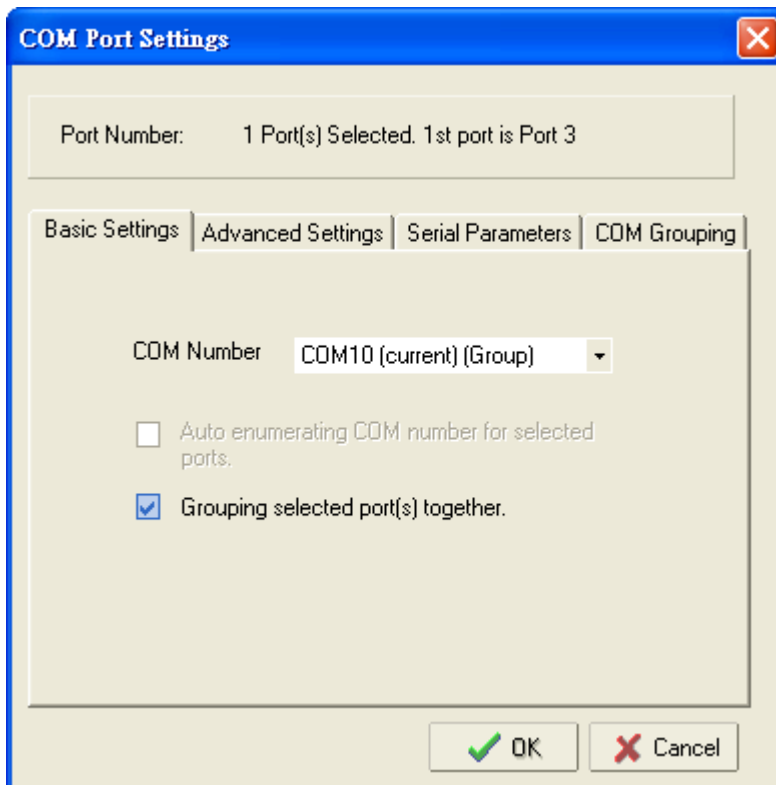

3. On **COM Grouping** page, you can specify one serial port whose signals will be taken into account by the COM Group and change the Read/Write status for each serial port.

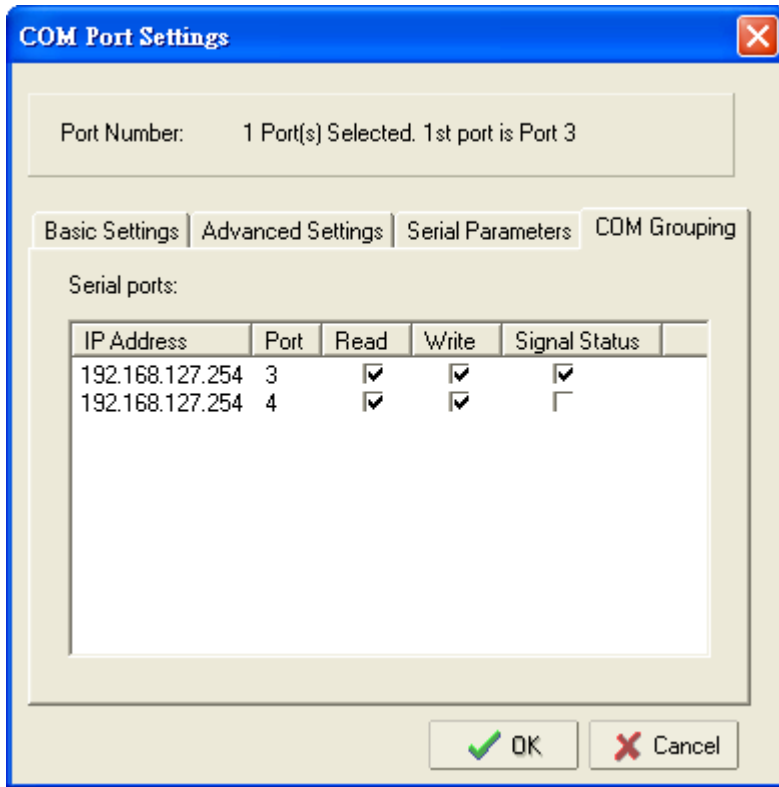

IP Address Report

When the NPort IA5450A is used in a dynamic IP environment, users must spend more time with IP management tasks. NPort IA5450A Series products help out by periodically reporting their IP address to the IP location server, in case the dynamic IP has changed.

1. Configure the NPort IA5450A with Dynamic IP settings (DHCP, BOOTP, or DHCP/BOOTP). Assign the remote Auto IP report server's IP address and UDP port.

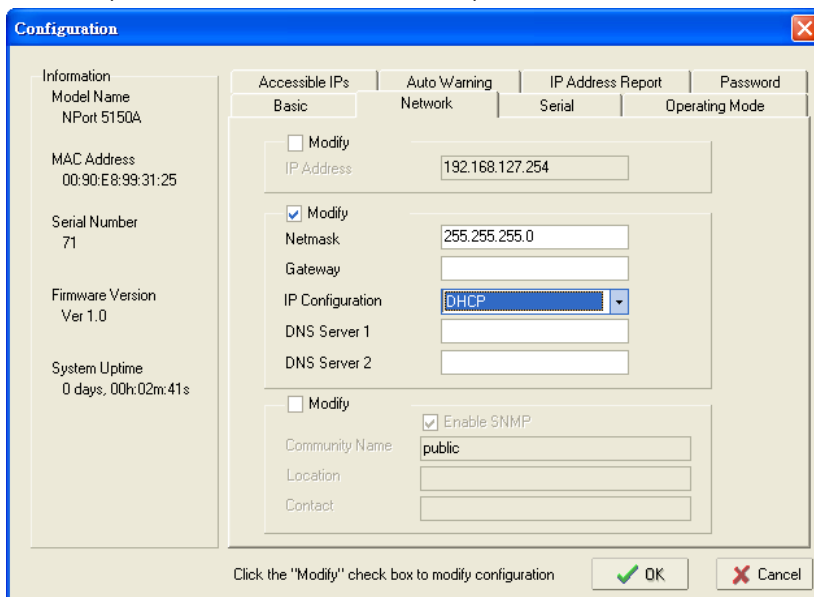

- 2. Select the **IP Address Report**, and click the right mouse button to select Settings.

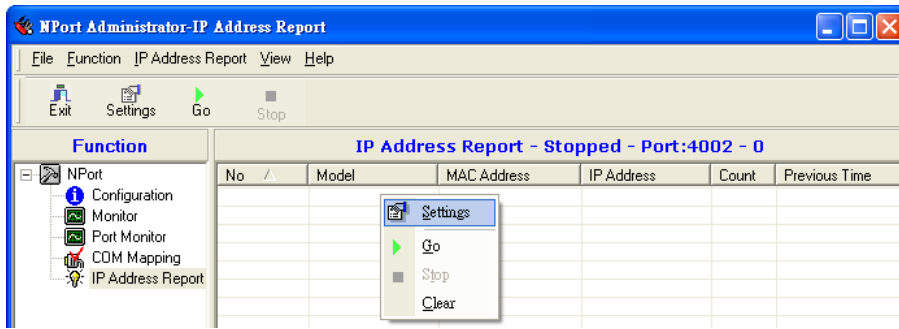

- 3. Configure the Local Listen Port to be the same as the NPort IA5450A's "Auto report to UDP port" setting.



- 4. Click **Go** to start receiving the Auto IP address report from the NPort IA5450A.

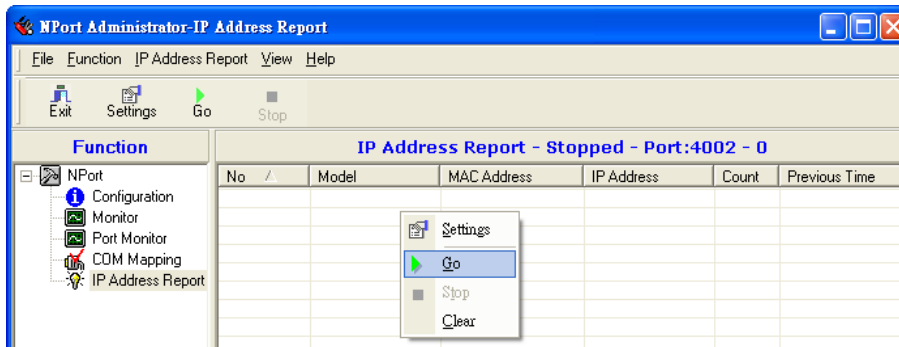

The following topics are covered in this chapter:

- **Overview**
- **IP Serial LIB Function Groups**
- **Example Program**

Overview

What is IP Serial Library?

IP Serial Library is a Windows library with frequently used serial command sets and subroutines. IP Serial Library is designed to reduce the complexity and poor efficiency of serial communication over TCP/IP. For example, Telnet can only transfer data, but it can't monitor or configure the serial line's parameters.

Why Use IP Serial Library?

For programmers who are familiar with serial communication, IP Serial Library provides well-designed function calls that have the same style as Moxa's PComm Library.

IP Serial Library is amazingly simple and easy to understand. By including it in your VB, C, or Delphi programming environment, you can program your own TCP/IP application with the ability to control serial communication parameters.

NPort IA5450A serial device servers use 2 TCP ports for communication between the NPort IA5450A and host computer's Real COM driver. The NPort IA5450A uses a data port and command port to provide pure data transfer without decode and encode. Compared to using only one TCP port to control serial communication (such as RFC2217), IP Serial Library uses a command port to communicate with the NPort IA5450A in user's program. IP Serial Library not only runs with excellent efficiency but also runs without any decode or encode problems.

How do I install IP Serial Library?

IP Serial Lib comes with the NPort IA5450A Administration Suite. Refer to the IP Serial directory for more detail about the function definitions.

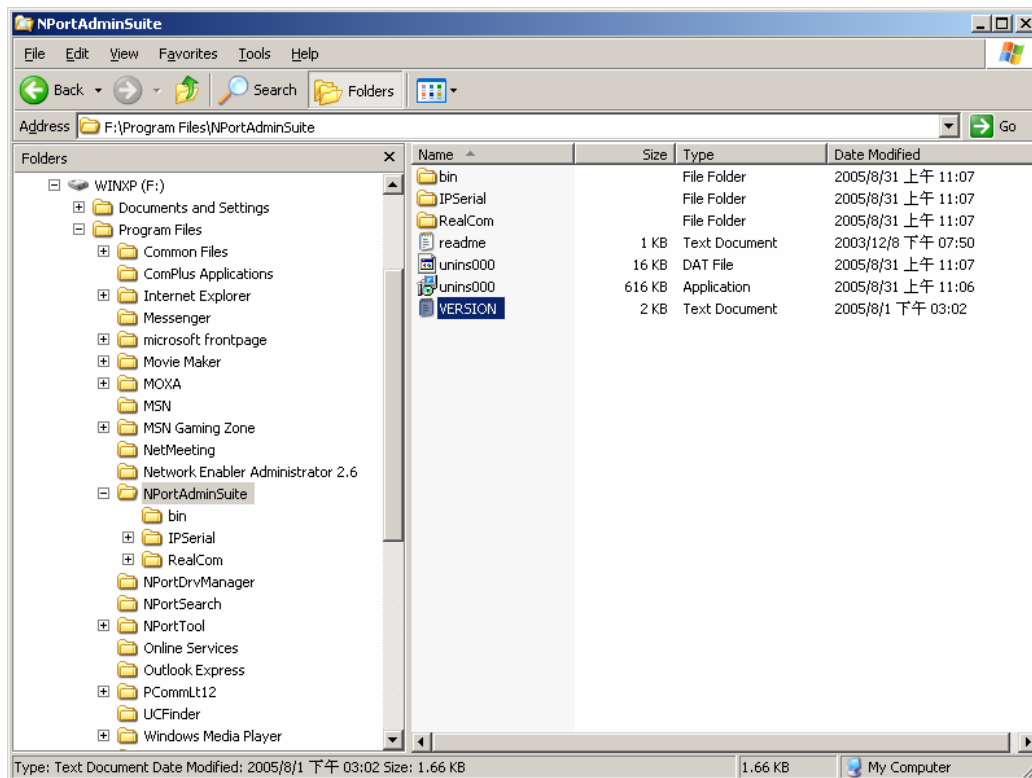

IP Serial LIB Function Groups

Server Control	Port Control	Input/Output Data	Port Status Inquiry	Miscellaneous
nsio_init nsio_end nsio_resetserver nsio_checkalive	nsio_open nsio_close nsio_ioctl nsio_flowctrl nsio_DTR nsio_RTS nsio_lctrl nsio_baud nsio_resetport	nsio_read nsio_SetReadTimeouts nsio_write nsio_SetWriteTimeouts	nsio_lstatus nsio_data_status	nsio_break nsio_break_on nsio_break_off nsio_breakcount

Example Program

```

char NPortip="192.168.1.10";
char buffer[255];
int port = 1;
int portid;
nsio_init();
portid = nsio_open(NPortip, port);
nsio_ioctl(portid, B9600, (BIT_8 | STOP_1 | P_NONE ));
sleep(1000);
nsio_read(port, buffer, 200);
nsio_close(portid);
nsio_end();
/*data buffer, 255 chars */
/*1st port */
/* port handle */
/*initial IP Serial Library */
/*1st port, NPort IP=192.168.1.10 */
/*set 9600, N81 */
/* wait for 1000 ms for data */
/* read 200 bytes from port 1 */
/* close this serial port */
/* close IP Serial Library */
    
```

A

Pinouts and Cable Wiring

The following topics are covered in this appendix:

▣ Port Pinout Diagrams

- Ethernet Port Pinouts
- RS-232/422/485 (male DB9) Pinouts
- Power Input and Relay Output Pinouts

▣ Serial Cable Wiring Diagrams

- Female DB9 to Male DB9
- Female DB9 to Male DB25

Port Pinout Diagrams

Ethernet Port Pinouts

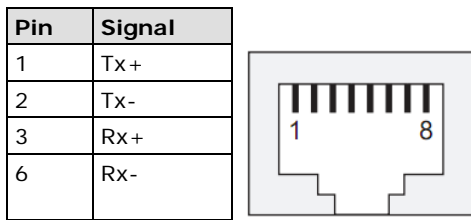

RS-232/422/485 (male DB9) Pinouts

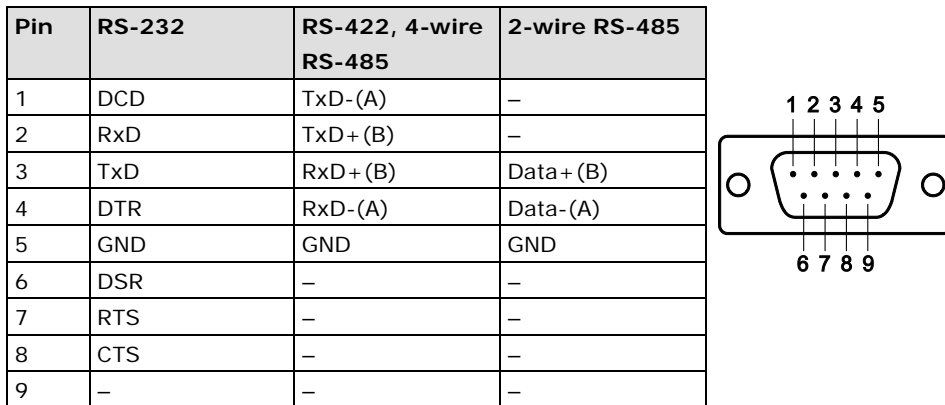

Power Input and Relay Output Pinouts

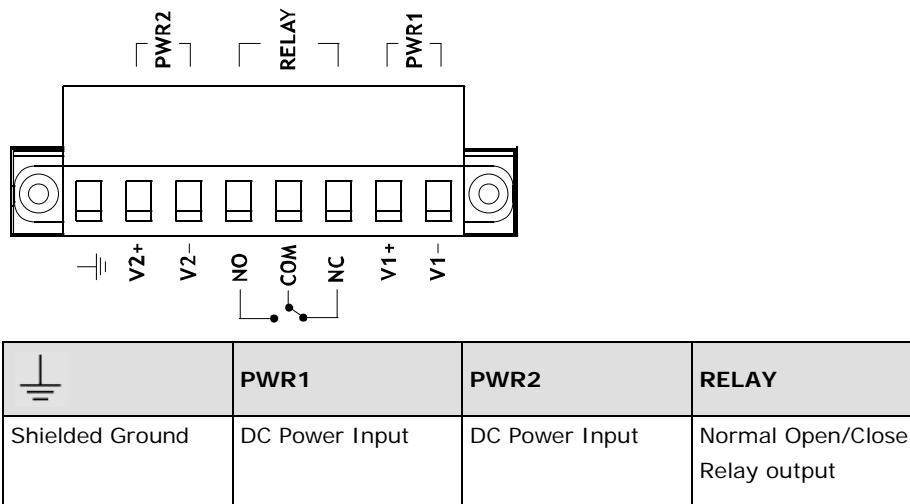

Serial Cable Wiring Diagrams

Female DB9 to Male DB9

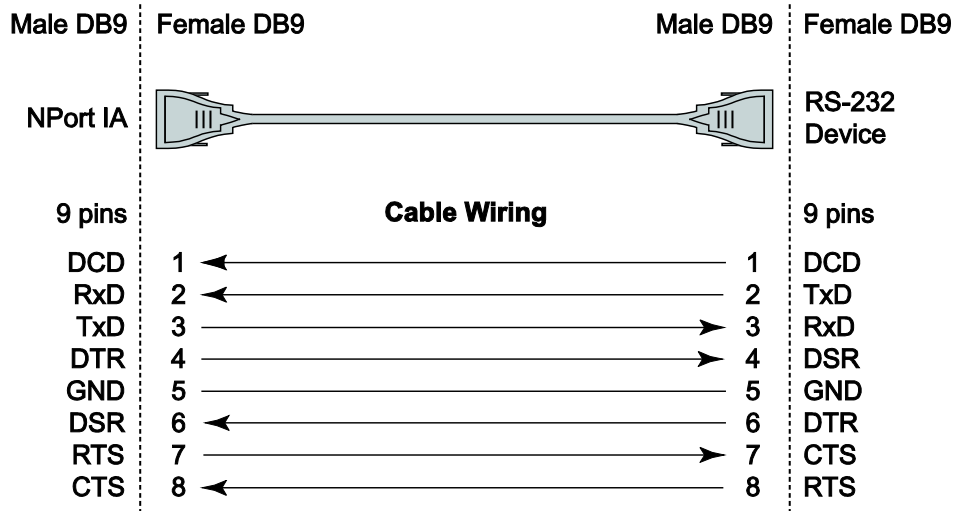

Female DB9 to Male DB25

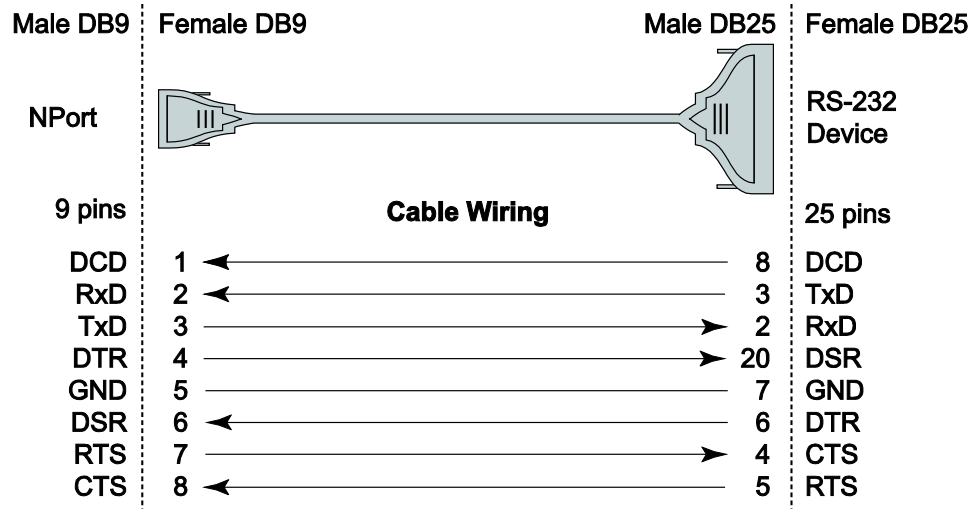

Ethernet Cables

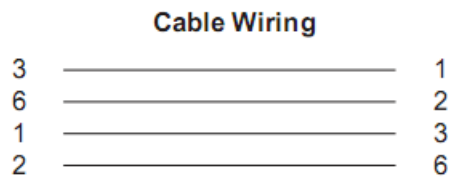
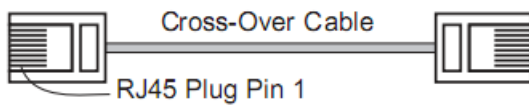
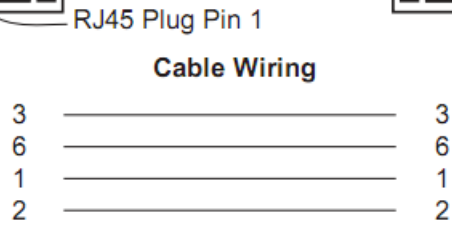
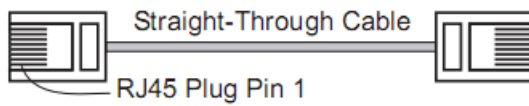

B

Well Known Port Numbers

In this appendix, which is included for your reference, we provide a list of Well Known port numbers that may cause network problems if you set the NPort IA5450A to one of these ports. Refer to RFC 1700 for Well Known port numbers, or refer to the following introduction from the IANA.

The port numbers are divided into three ranges: the Well Known Ports, the Registered Ports, and the Dynamic and/or Private Ports.

The Well Known Ports are those from 0 through 1023.

The Registered Ports are those from 1024 through 49151.

The Dynamic and/or Private Ports are those from 49152 through 65535.

The Well Known Ports are assigned by the IANA, and on most systems, can only be used by system processes or by programs executed by privileged users. The following table shows famous port numbers among the well-known port numbers. For more details, please visit the IANA website:

<http://www.iana.org/assignments/port-numbers>

TCP Socket	Application Service
0	reserved
1	TCP Port Service Multiplexor
2	Management Utility
7	Echo
9	Discard
11	Active Users (sysstat)
13	Daytime
15	Netstat
20	FTP data port
21	FTP CONTROL port
23	Telnet
25	SMTP (Simple Mail Transfer Protocol)
37	Time (Time Server)
42	Host name server (names server)
43	Whois (nickname)
49	(Login Host Protocol) (Login)
53	Domain Name Server (domain)
79	Finger protocol (Finger)
80	World Wide Web HTTP
119	Network News Transfer Protocol (NNTP)
123	Network Time Protocol
213	IPX
160 to 223	Reserved for future use

UDP Socket	Application Service
0	reserved
2	Management Utility
7	Echo
9	Discard
11	Active Users (systat)
13	Daytime
35	Any private printer server
39	Resource Location Protocol
42	Host name server (names server)
43	Whois (nickname)
49	(Login Host Protocol) (Login)
53	Domain Name Server (domain)
69	Trivial Transfer Protocol (TFTP)
70	Gopher Protocol
79	Finger Protocol
80	World Wide Web HTTP
107	Remote Telnet Service
111	Sun Remote Procedure Call (Sunrpc)
119	Network News Transfer Protocol (NNTP)
123	Network Time Protocol (ntp)
161	SNMP (Simple Network Mail Protocol)
162	SNMP Traps
213	IPX (Used for IP Tunneling)

SNMP Agents with MIB II & RS-232 Like Groups

NPort IA5450A has built-in SNMP (Simple Network Management Protocol) agent software. It supports SNMP Trap, RFC1317 RS-232 like group and RFC 1213 MIB-II. The following table lists the standard MIB-II group, as well as the variable implementation for the NPort IA5450A.

RFC1213 MIB-II supported SNMP variables:

System MIB	Interfaces MIB	IP MIB	ICMP MIB
SysDescr	ifNumber	ipForwarding	IcmpInMsgs
SysObjectID	ifIndex	ipDefaultTTL	IcmpInErrors
SysUpTime	ifDescr	ipInreceives	IcmpInDestUnreachs
SysContact	ifType	ipInHdrErrors	IcmpInTimeExcds
SysName	ifMtu	ipInAddrErrors	IcmpInParmProbs
SysLocation	ifSpeed	ipForwDatagrams	IcmpInSrcQuenchs
SysServices	ifPhysAddress	ipInUnknownProtos	IcmpInRedirects
	ifAdminStatus	ipInDiscards	IcmpInEchos
	ifOperStatus	ipInDelivers	IcmpInEchoReps
	ifLastChange	ipOutRequests	IcmpInTimestamps
	ifInOctets	ipOutDiscards	IcmpTimestampReps
	ifInUcastPkts	ipOutNoRoutes	IcmpInAddrMasks
	ifInNUcastPkts	ipReasmTimeout	IcmpOutMsgs
	ifInDiscards	ipReasmReqds	IcmpOutErrors
	ifInErrors	ipReasmOKs	IcmpOutDestUnreachs
	ifInUnknownProtos	ipReasmFails	IcmpOutTimeExcds
	ifOutOctets	ipFragOKs	IcmpOutParmProbs
	ifOutUcastPkts	ipFragFails	IcmpOutSrcQuenchs
	ifOutNUcastPkts	ipFragCreates	IcmpOutRedirects
	ifOutDiscards	ipAdEntAddr	IcmpOutEchos
	ifOutErrors	ipAdEntIfIndex	IcmpOutEchoReps
System MIB	Interfaces MIB	IP MIB	ICMP MIB
SysServices	ifOutQLen	ipAdEntNetMask	IcmpOutTimestamps
	ifSpecific	ipAdEntBcastAddr	IcmpOutTimestampReps
		ipAdEntReasmMaxSize	IcmpOutAddrMasks
		IpNetToMediaIfIndex	IcmpOutAddrMaskReps
		IpNetToMediaPhysAddress	
		IpNetToMediaNetAddress	

		IpNetToMediaType	
		IpRoutingDiscards	

UDP MIB	TCP MIB	SNMP MIB
UdpInDatagrams	tcpRtoAlgorithm	snmpInPkts
UdpNoPorts	tcpRtoMin	snmpOutPkts
UdpInErrors	tcpRtoMax	snmpInBadVersions
UdpOutDatagrams	tcpMaxConn	snmpInBadCommunityNames
UdpLocalAddress	tcpActiveOpens	snmpInASNParseErrs
UdpLocalPort	tcpPassiveOpens	snmpInTooBigs
	tcpAttemptFails	snmpInNoSuchNames
Address Translation MIB	tcpEstabResets	snmpInBadValues
AtIfIndex	tcpCurrEstab	snmpInReadOnlyls
AtPhysAddress	tcpInSegs	snmpInGenErrs
AtNetAddress	tcpOutSegs	snmpInTotalReqVars
Address Translation MIB	TCP MIB	SNMP MIB
AtNetAddress	tcpRetransSegs	snmpInTotalSetVars
	tcpConnState	snmpInGetRequests
	tcpConnLocalAddress	snmpInGetNexts
	tcpConnLocalPort	snmpInSetRequests
	tcpConnRemAddress	snmpInGetResponses
	tcpConnRemPort	snmpInTraps
	tcpInErrs	snmpOutTooBigs
	tcpOutRsts	snmpOutNoSuchNames
		snmpOutBadValues
		snmpOutGenErrs
		snmpOutGetRequests
		snmpOutGetNexts
		snmpOutSetRequests

Address Translation MIB	TCP MIB	SNMP MIB
		snmpOutGetResponses
		snmpOutTraps
		snmpEnableAuthenTraps

RFC1317: RS-232 MIB objects

Generic RS-232-like Group	RS-232-like General Port Table	RS-232-like Asynchronous Port Group
rs232Number	rs232PortTable	rs232AsyncPortTable
	rs232PortEntry	rs232AsyncPortEntry
	rs232PortIndex	rs232AsyncPortIndex
	rs232PortType	rs232AsyncPortBits
	rs232PortInSigNumber	rs232AsyncPortStopBits
	rs232PortOutSigNumber	rs232AsyncPortParity

	rs232PortInSpeed	
	rs232PortOutSpeed	

The Input Signal Table	The Output Signal Table
rs232InSigTable	rs232OutSigTable
rs232InSigEntry	rs232OutSigEntry
rs232InSigPortIndex	rs232OutSigPortIndex
rs232InSigName	rs232OutSigName
rs232InSigState	rs232OutSigState

Auto IP Report Protocol

NPort device servers provide several ways to configure Ethernet IP addresses. One of them is DHCP Client. When you set up the NPort to use DHCP Client to configure Ethernet IP addresses, it will automatically send a DHCP request over the Ethernet to find the DHCP Server. And then the DHCP Server will send an available IP address to the NPort. The NPort will use this IP address for a period of time after receiving it. But the NPort will send a DHCP request again to the DHCP Server. Once the DHCP Server realizes that this IP address is to be released to other DHCP Client, the NPort then will receive a different IP address. For this reason, users sometimes find that the NPort will use different IP addresses, not a fixed IP address.

In order to know what IP address the NPort is using, you need to set up parameters in Network Settings via Web browser. The figure below is the NPort Web console configuration window. Enter the IP address and the Port number of the PC that you want to send this information to.

And then you can develop your own programs to receive this information from the NPort. Here is NPort's Auto IP Report Protocol. We provide an example for you to easily develop your own programs. You can find this example on Moxa's website.

Auto IP Report Format

"Moxa", 4 bytes	Info[0]	Info[1]	...	Info[n]
-----------------	---------	---------	-----	---------

Info [n]

Field	ID	Length	Data
Length	1	1	Variable, Length is "Length Field"

ID List

ID Value	Description	Length	Note
1	Server Name	Variable	ASCII char
2	Hardware ID	2	Little-endian
3	MAC Address	6	6 bytes MAC address. If the MAC address is "00-90-E8-01-02-03", the MAC [0] is 0, MAC[1] is 0x90(hex), MAC[2] is 0xE8(hex), and so on.
4	Serial Number	4, DWORD	Little-endian
5	IP Address	4, DWORD	Little-endian
6	Netmask	4, DWORD	Little-endian
7	Default Gateway	4, DWORD	Little-endian
8	Firmware Version	4, DWORD	Little-endian Ver1.3.4 = 0x0103040
9	AP ID	4, DWORD	Little-endian

AP ID & Hardware ID Mapping Table

AP ID	Hardware ID	Product
0x80015400	0x540A	NPort IA5450A
0x80015400	0x541A	NPort IA5450AI

Compliance Notice



CE Warning

This is a Class A product. In a domestic environment, this product may cause radio interference in which case the user may be required to take appropriate measures.

Federal Communications Commission Statement

FCC - This device complies with part 15 of the FCC Rules. Operation is subject to the following two conditions: (1) This device may not cause harmful interference, and (2) this device must accept any interference received, including interference that may cause undesired operation.



FCC Warning

This equipment has been tested and found to comply with the limits for a Class A digital device, pursuant to part 15 of the FCC Rules. These limits are designed to provide reasonable protection against harmful interference when the equipment is operated in a commercial environment. This equipment generates, uses, and can radiate radio frequency energy and, if not installed and used in accordance with the instruction manual, may cause harmful interference to radio communications. Operation of this equipment in a residential area is likely to cause harmful interference in which case the user will be required to correct the interference at his own expense.