

NPort W2150A/W2250A Series User's Manual

First Edition, April 2012

www.moxa.com/product

MOXA[®]

© 2012 Moxa Inc. All rights reserved.

NPort W2150A/W2250A Series User's Manual

The software described in this manual is furnished under a license agreement and may be used only in accordance with the terms of that agreement.

Copyright Notice

© 2012 Moxa Inc. All rights reserved.

Trademarks

The MOXA logo is a registered trademark of Moxa Inc.
All other trademarks or registered marks in this manual belong to their respective manufacturers.

Disclaimer

Information in this document is subject to change without notice and does not represent a commitment on the part of Moxa.

Moxa provides this document as is, without warranty of any kind, either expressed or implied, including, but not limited to, its particular purpose. Moxa reserves the right to make improvements and/or changes to this manual, or to the products and/or the programs described in this manual, at any time.

Information provided in this manual is intended to be accurate and reliable. However, Moxa assumes no responsibility for its use, or for any infringements on the rights of third parties that may result from its use.

This product might include unintentional technical or typographical errors. Changes are periodically made to the information herein to correct such errors, and these changes are incorporated into new editions of the publication.

Technical Support Contact Information

www.moxa.com/support

Moxa Americas

Toll-free: 1-888-669-2872
Tel: +1-714-528-6777
Fax: +1-714-528-6778

Moxa Europe

Tel: +49-89-3 70 03 99-0
Fax: +49-89-3 70 03 99-99

Moxa China (Shanghai office)

Toll-free: 800-820-5036
Tel: +86-21-5258-9955
Fax: +86-21-5258-5505

Moxa Asia-Pacific

Tel: +886-2-8919-1230
Fax: +886-2-8919-1231

Table of Contents

1. Introduction	1-1
Overview	1-2
Package Checklist	1-2
Product Features	1-2
Product Specifications	1-3
Serial Port Pin Assignments	1-4
2. Getting Started	2-1
Overview	2-2
Panel Layout	2-2
LED Indicators	2-3
Top Panel LED Indicators	2-3
End Panel LED Indicators	2-3
Pull High/Low Resistors for RS-422/485	2-4
Placement Options	2-5
Connecting the Hardware	2-5
Connecting to the Network	2-6
Connecting the Power	2-6
Connecting to a Serial Device	2-6
3. Initial IP Configuration	3-1
Overview	3-2
Factory Default IP Settings	3-2
Using ARP to Assign IP Address	3-2
Using the Telnet Console to Assign IP Address	3-3
Using the Serial Console to Assign IP Address	3-6
4. Introduction to Operation Modes	4-1
Overview	4-2
RealCOM Mode	4-2
RFC2217 Mode	4-3
TCP Server Mode	4-3
TCP Client Mode	4-3
UDP Mode	4-4
Pair Connection Modes	4-4
Ethernet Modem Mode	4-4
5. Web Console: Basic Settings	5-1
Overview	5-2
Basic Settings	5-4
6. Web Console: Network Settings	6-1
Overview	6-2
Network Settings	6-2
General Settings	6-2
Ethernet Settings	6-3
WLAN Settings	6-4
Advanced Settings	6-21
7. Web Console: Serial Port Settings	7-1
Overview	7-2
Serial Port Settings	7-2
Communication Parameters	7-22
Data Buffering/Log	7-24
8. Web Console: System Management	8-1
Overview	8-2
System Management	8-2
Misc. Network Settings	8-2
Auto Warning Settings	8-6
Maintenance	8-10
Maintenance	8-11
Certificate	8-14
9. Web Console: System Monitoring	9-1
Overview	9-2
System Monitoring	9-2
Serial Status	9-2
System Status	9-4
10. Web Console: Restart	10-1
Overview	10-2
Restart	10-2

Restart System	10-2
Restart Ports.....	10-3
11. Installing and Configuring the Software	11-1
Overview	11-2
NPort Windows Driver Manager	11-2
Installing NPort Windows Driver Manager	11-2
Adding Mapped Serial Ports	11-5
Configuring Mapped Serial Ports.....	11-8
NPort Search Utility.....	11-13
Installing NPort Search Utility	11-13
Finding NPort Device Servers on Network.....	11-15
Modifying NPort IP Addresses.....	11-16
Upgrading NPort Firmware.....	11-17
Linux Real TTY Drivers	11-18
Basic Steps.....	11-18
Installing Linux Real TTY Driver Files	11-18
Mapping TTY Ports.....	11-19
Removing Mapped TTY Ports.....	11-19
Removing Linux Driver Files.....	11-20
UNIX Fixed TTY Drivers	11-20
Installing the UNIX Driver.....	11-21
Configuring the UNIX Driver	11-21
A. SNMP Agents with MIB II & RS-232-Like Groups	A-1
RFC1213 MIB-II Supported SNMP Variables	A-1
System MIB.....	A-1
Interfaces MIB	A-1
IP MIB	A-1
ICMP MIB	A-2
UDP MIB	A-2
Address Translation	A-2
TCP MIB.....	A-2
SNMP MIB	A-2
RFC1317: RS-232 MIB Objects	A-3
Generic RS-232-like Group	A-3
RS-232-like General Port Table	A-3
RS-232-like Asynchronous Port Group.....	A-3
The Input Signal Table	A-3
The Output Signal Table.....	A-3
B. Well Known Port Numbers	B-1
C. Ethernet Modem Commands.....	C-1
Dial-in Operation	C-1
Dial-out	C-1
Disconnection Request from Local Site	C-1
Disconnection Request from Remote Site.....	C-1
AT Commands.....	C-2
S Registers	C-3
D. Federal Communication Commission Interference Statement	D-1
E. FCC Warning Statement	E-1

The following topics are covered in this chapter:

- ❑ **Overview**
- ❑ **Package Checklist**
- ❑ **Product Features**
- ❑ **Product Specifications**
- ❑ **Serial Port Pin Assignments**
- ❑ **Overview**
- ❑ **Panel Layout**
- ❑ **LED Indicators**
 - Top Panel LED Indicators
 - End Panel LED Indicators
- ❑ **Pull High/Low Resistors for RS-422/485**
- ❑ **Placement Options**
- ❑ **Connecting the Hardware**
 - Connecting to the Network
 - Connecting the Power
 - Connecting to a Serial Device

Overview

In this chapter we introduce the basic features and specifications of the NPort W2150A/W2250A and NPort W2150A/W2250A-T, referred to collectively as the NPort W2150A/W2250A Series.

The NPort W2150A/W2250A Series of wireless device servers are used to connect RS-232/422/485 serial devices such as PLCs, meters, and sensors, to a wired Ethernet LAN or wireless LAN. Your communications software will be able to access the serial devices from anywhere over a local LAN, WLAN, or the Internet. Moreover, the WLAN environment offers an excellent solution for applications in which the serial devices are moved frequently from place to place.

The NPort W2150A/W2250A supports both automatic IP configuration protocols (DHCP, BOOTP) and manual configuration using a standard web browser. Both IP configuration methods ensure quick and effective installation. In addition, a utility called "NPort Windows Driver Manager" makes port mapping easy.

The external antenna can be adjusted for maximum signal strength. You can also choose to use your own antenna for additional flexibility and scalability. A signal strength indicator on the front panel makes it easier for you to troubleshoot any connection problems.

The NPort W2150A/W2250A Series offers different operation modes to ensure compatibility with standard network APIs, including TCP Server Mode, TCP Client Mode, and UDP Mode. RealCOM/TTY drivers are provided to allow legacy serial-based software to communicate over an IP network instantly. This preserves your software investment while providing all the advantages of networking your serial devices.

For easier management, the NPort W2150A/W2250A include features such as password authentication, IP filtering, 64-bit and 128-bit WEP encryption, and SNMP support.

Package Checklist

Standard Accessories

- NPort W2150A, NPort W2150A-T, NPort W2250A, or NPort W2250A-T.
- Document & Software CD
- RJ45 to RJ45 Ethernet cross-over cable
- Warranty statement
- Quick Installation Guide

Optional Accessories

- DK-35A: DIN-rail mounting kit (35 mm)
- Power jack to terminal block power cable (P/N: 919900000900)

NOTE: Please notify your sales representative if any of the above items are missing or damaged

Product Features

- Instant connection of any serial device to IEEE 802.11a/b/g network
- RS-232/422/485 ports supporting baudrates up to 921.6 Kbps
- Web-based configuration over Ethernet or WLAN
- Enhanced remote configuration with HTTPS, SSH
- Secure data access with WEP, WPA, WPA2
- Built-in WLAN site survey Tool
- Fast roaming when signal strength is weak
- Per-port offline port buffering and serial data log
- Dual power inputs via power jack and terminal block

Product Specifications

Ethernet Interface

Number of Ports: 1

Speed: 10/100 Mbps, auto MDI/MDIX

Connector: RJ45

Magnetic Isolation Protection: 1.5 KV built-in

WLAN Interface

Standard Compliance: 802.11a/b/g

Network Modes: Infrastructure, Ad-Hoc

Transmit Power:

802.11a: 14 dBm (typical)

802.11b: 17 dBm (typical)

802.11g: 15 dBm (typical)

Receive Sensitivity: -80 dBm

Radio Frequency Type: DSSS/OFDM

Transmission Rate:

802.11a: 54 Mbps

802.11b: 11 Mbps

802.11g: 54 Mbps (max.) with auto fallback (54, 48, 36, 24, 18, 12, 11, 9, 6, 5.5, 2, 1 Mbps)

Transmission Distance: Up to 100 meters (in open areas)

Wireless Security:

- WEP: 64-bit/128-bit data encryption
- WPA, WPA2, 802.11i: Enterprise mode and Pre-Share Key (PSK) mode
- Encryption: 128-bit TKIP/AES-CCMP EAP-TLS, PEAP/GTC, PEAP/MD5, PEAP/MSCHAPV2, EAP-TTLS/PAP, EAP-TTLS/CHAP, EAP-TTLS/MSCHAP, EAP-TTLS/MSCHAPV2, EAP-TTLS/EAP-MSCHAPV2, EAP-TTLS/EAP-GTC, EAP-TTLS/EAP-MD5, LEAP

Antenna Connector: Reverse SMA

Serial Interface

Number of Ports:

NPort W2150A: 1

NPort W2250A: 2

Serial Standards: RS-232/422/485 (DB9 male connector)

Off-line Port Buffering:

NPort W2150A: 20 MB

NPort W2250A: 10 MB

Serial Line Surge Protection: 1KV (level 2)

Serial Communication Parameters

Data Bits: 5, 6, 7, 8

Stop Bits: 1, 1.5, 2

Parity: None, Even, Odd, Space, Mark

Flow Control: RTS/CTS, XON/XOFF

Baudrate: 50 bps to 921.6 Kbps

Serial Data Log: 64 KB

Serial Signals

RS-232: TxD, RxD, RTS, CTS, DTR, DSR, DCD, GND

RS-422: TxD+, TxD-, RxD+, RxD-, GND

RS-485-4w: TxD+, TxD-, RxD+, RxD-, GND

RS-485-2w: Data+, Data-, GND

Software

Network Protocols: ICMP, IP, TCP, UDP, DHCP, Telnet, DNS, SNMP V1/V2c/V3, HTTP, SMTP, SNTP, SSH, HTTPS

Configuration Options: Web Console, Serial Console, Telnet Console

Secure Configuration Options: HTTPS, SSH

Windows RealCOM Drivers: Windows 95/98/ME/NT/2000, Windows XP/2003/Vista/2008/7 x86/x64, Embedded CE 5.0/6.0, XP Embedded

Fixed TTY Drivers: SCO Unix, SCO OpenServer, UnixWare 7, UnixWare 2.1, SVR 4.2, QNX 4.25, QNX 6, Solaris 10, FreeBSD, AIX 5.x, HP-UX 11i

Linux Real TTY Drivers: 2.4.x, 2.6.x, 3.x

Utilities: NPort Search Utility and NPort Windows Driver manager

Management: SNMP MIB-II

Physical Characteristics

Housing: Aluminum sheet metal (1 mm)

Weight: 780 g

Dimensions:

Without ears or antenna: 77 x 111 x 26 mm (3.03 x 4.37 x 1.02 in)

With ears, without antenna: 100 x 111 x 26 mm (3.94 x 4.37 x 1.02 in)

Antenna Length: 109.79 mm (4.32 in)

Environmental Limits

Operating Temperature:

Standard Models: 0 to 55°C (32 to 131°F)

Wide Temp. Models: -40 to 75°C (-40 to 167°F)

Storage Temperature: -40 to 85°C (-40 to 185°F)

Ambient Relative Humidity: 5 to 95% (non-condensing)

Power Requirements

Input Voltage: 12 to 48 VDC

Power Consumption:

237 mA @ 12 V, 125 mA @ 24 V, 50 mA @ 48 V

Standards and Certifications

Safety: UL 60950-1, EN 60950-1

EMC: CE, FCC

EMI: FCC Part 15 Subpart B Class A, FCC Subpart C/E, VCCI

EMS: EN 55022 Class A

Radio: CE (ETSI EN 301 893, ETSI EN 300 328), ARIB RCR STD-33, ARIB STD-66

Power Line Surge Protection: 2 KV (level 3)

Reliability

Alert Tool: RTC (real-time clock)

Automatic Reboot Trigger: Built-in WDT (watchdog timer)

Warranty

Warranty Period: 5 years

Details: See www.moxa.com/warranty

Serial Port Pin Assignments

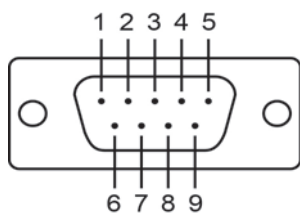

Pin	RS-232	RS-422/ RS-485 (4W)	RS-485 (2W)
1	DCD	TxD-(A)	---
2	RXD	TxD+(B)	---
3	TXD	RxD+(B)	Data+(B)
4	DTR	RxD-(A)	Data-(A)
5	GND	GND	GND
6	DSR	---	---
7	RTS	---	---
8	CTS	---	---
9	---	---	---

2

Getting Started

The following topics are covered in this chapter:

- **Overview**
- **Panel Layout**
- **LED Indicators**
 - Top Panel LED Indicators
 - End Panel LED Indicators
- **Pull High/Low Resistors for RS-422/485**
- **Placement Options**
- **Connecting the Hardware**
 - Connecting to the Network
 - Connecting the Power
 - Connecting to a Serial Device

Overview

This chapter presents the hardware features of the NPort W2150/W2250A Series and explains how to connect the hardware.

Panel Layout

NPort W2150A/W2150A-T

NPort W2250A/W2250A-T

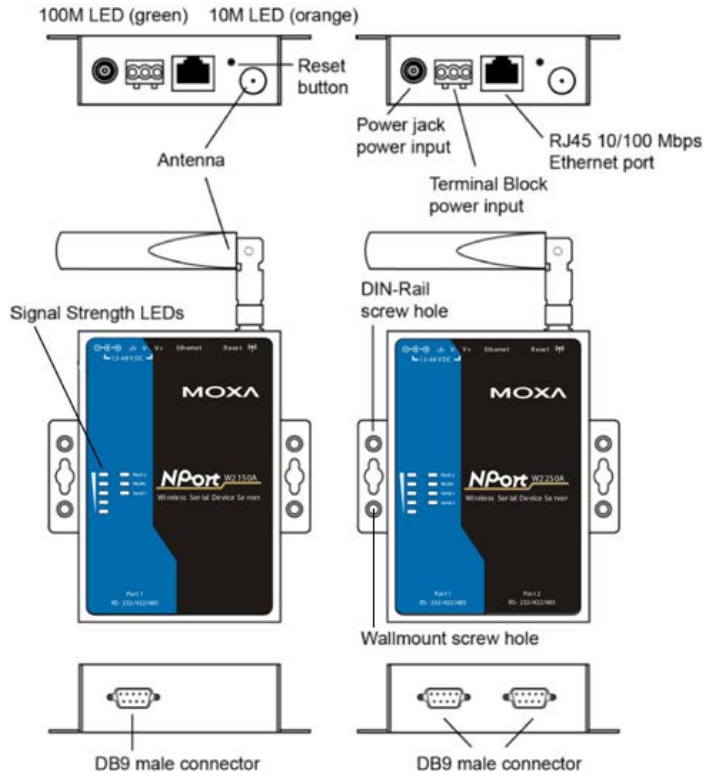

LED Indicators

Top Panel LED Indicators

Name	Color	Function
Ready	Red	Steady on: Power is on and NPort is booting up. Blinking: IP conflict or DHCP/ BOOTP server did not respond properly.
	Green	Steady on: NPort is functioning normally. Blinking: Unit is responding to Locate function.
	Off	Power is off or a power error condition exists.
WLAN	Green	Steady on: Wireless enabled Blinking: NPort can't establish WLAN connection with AP (Infrastructure) or station (Ad-Hoc)
	Off	Wireless not enabled.
Serial 1 Serial 2	Orange	Serial port is receiving data.
	Green	Serial port is transmitting data.
	Off	No data is flowing to or from the serial port.
Signal Strength (5 LEDS)	Red	1 Red - the signal strength is between 0% and 20% 2 Red - the signal strength is between 21% and 40%
	Green	3 Green - the signal strength is between 41% and 60% 4 Green - the signal strength is between 61% and 80% 5 Green - the signal strength is between 81% and 100%

End Panel LED Indicators

Name	Color	Function
Ethernet	Orange	10 Mbps Ethernet connection
	Green	100 Mbps Ethernet connection
	Off	Ethernet cable is disconnected

Pull High/Low Resistors for RS-422/485

You may need to set the pull high/low resistors when termination resistors are used for certain RS-422 or RS-485 environments.

S2 (Serial 1) S3 (Serial 2)	DIP 1	DIP 2	DIP 3	DIP 4
ON	Pull high resistor 1 K Ω	Pull low resistor 1 K Ω	Terminal resistor 120 Ω	Reserved -----
OFF	*150 K Ω	*150 K Ω	*N/A	-----

*Default

S3 is for NPort W2250A only

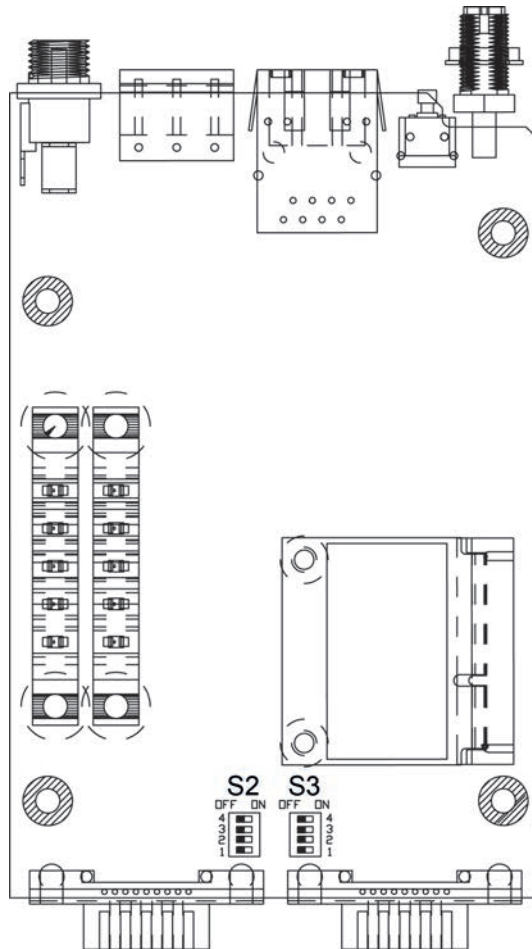

ATTENTION

Do not use the 1 K Ω setting while in RS-232 mode. Doing so will degrade the RS-232 signals and reduce the effective communication distance.

Placement Options

The NPort can be placed on a desktop or other horizontal surface. You can also install the NPort on a DIN-rail or on the wall.

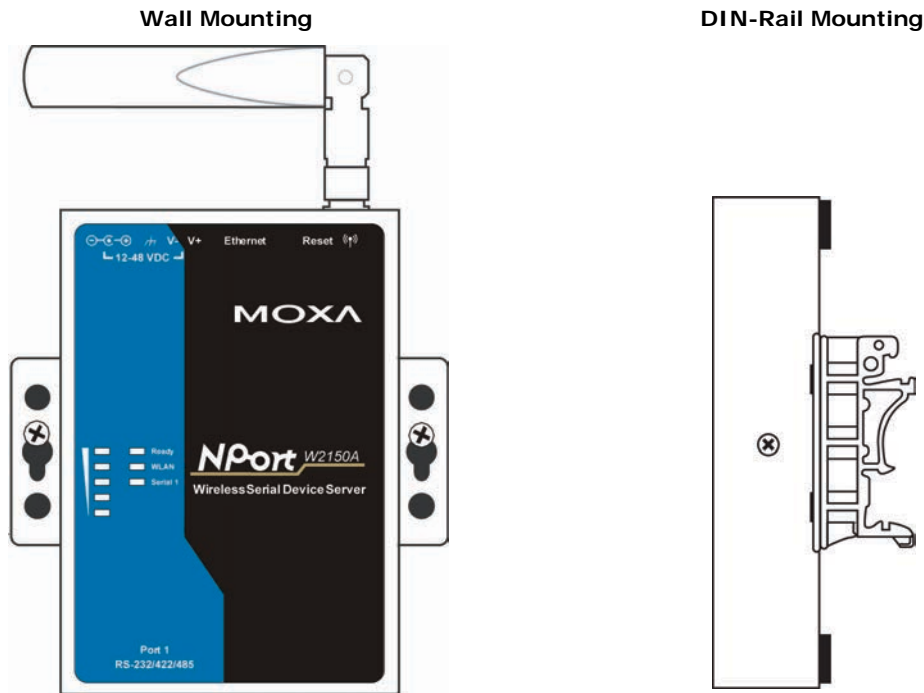

Connecting the Hardware



ATTENTION

Before connecting the hardware, follow these important wiring safety precautions:

Disconnect power source

Do not install or wire this unit or any attached devices with the power connected. Disconnect the power before installation by removing the power cord before installing and/or wiring your unit.

Follow maximum current ratings

Calculate the maximum possible current in each power wire and common wire. Observe all electrical codes dictating the maximum current allowable for each wire size.

If the current goes above the maximum ratings, the wiring could overheat, causing serious damage to your equipment.

Use caution - unit may get hot

The unit will generate heat during operation, and the casing may feel hot to the touch. Take care when handling unit. Be sure to leave adequate space for ventilation.

The following guidelines will help ensure trouble-free signal communication with the NPort.

- Use separate paths to route wiring for power and devices to avoid interference. Do not run signal or communication wiring and power wiring in the same wire conduit. The rule of thumb is that wiring that shares similar electrical characteristics can be bundled together.
- If power wiring and device wiring paths must cross, make sure the wires are perpendicular at the intersection point.
- Keep input wiring and output wiring separate.
- Label all wiring to each device in the system for easier testing and troubleshooting

Connecting to the Network

Use the supplied Ethernet cable to connect the NPort to your Ethernet network. If the cable is properly connected, the NPort will indicate a valid connection to the Ethernet as follows:

- A green Ethernet LED indicates a valid connection to a 100 Mbps Ethernet network.
- An orange Ethernet LED indicates a valid connection to a 10 Mbps Ethernet network.
- A flashing Ethernet LED indicates that Ethernet packets are being transmitted or received.

Connecting the Power

Connect the VDC power line (12 to 48 V) to the NPort's power jack or terminal block. If power is properly connected, the "Ready" LED will initially glow red. When the system is ready, the "Ready" LED will turn green.

Connecting to a Serial Device

Use a serial cable to connect your serial device to a serial port on the NPort.

Initial IP Configuration

The following topics are covered in this chapter:

- ❑ **Overview**
- ❑ **Factory Default IP Settings**
- ❑ **Using ARP to Assign IP Address**
- ❑ **Using the Telnet Console to Assign IP Address**
- ❑ **Using the Serial Console to Assign IP Address**

Overview

This chapter presents several ways to assign the NPort's IP address for the first time. Please refer to Chapter 2 for instructions on connecting to the network.

The web console is the recommended method for configuring the NPort. Please refer to Chapter 5 and 6 for details on using the web console for configuration.



ATTENTION

The LAN and WLAN interfaces cannot be used at the same time. If the Ethernet link is active, then WLAN connections will be disabled. If the WLAN connection is active, then the Ethernet link will be disabled.



ATTENTION

Make sure that the Ethernet cable is connected before powering up the NPort.

Factory Default IP Settings

Network Interface	IP Configuration	IP Address	Netmask
LAN	Static	192.168.126.254	255.255.255.0
WLAN	Static	192.168.127.254	255.255.255.0

If your NPort is configured to obtain its IP settings from a DHCP or BOOTP server but is unable to get a response, it will use the factory default IP address and netmask.



ATTENTION

If you forget the IP address of your NPort, you can look it up using the NPort Search Utility. After NPort Search Utility has found all NPorts on the network, each unit will be listed with its IP address. Please refer to Chapter 11 for additional information on using NPort Search Utility.

Using ARP to Assign IP Address

The ARP (Address Resolution Protocol) command can be used to assign an IP address to the NPort. The ARP command tells your computer to associate the NPort's MAC address with the specified IP address. You must then use Telnet to access the NPort, at which point the device server's IP address will be reconfigured. This method only works when the NPort is configured with default IP settings.

1. Select a valid IP address for your NPort. Consult with your network administrator if necessary.
2. Obtain the NPort's MAC address from the label on its bottom panel.
3. From the DOS prompt, execute the **arp -s** command with the desired IP address and the NPort's MAC address, as in the following example:

```
arp -s 192.168.200.100 00-90-E8-xx-xx-xx
```

In this example 192.168.200.100 is the new IP address that will be assigned to the NPort, and 00-90-E8-xx-xx-xx is the NPort's MAC address.

4. From the DOS prompt, execute a special Telnet command using port 6000, as in the following example:

```
telnet 192.168.200.100 6000
```

In this example, 192.168.200.100 is the new IP address that will be assigned to the NPort.

5. You will see a message indicating that the connection failed.

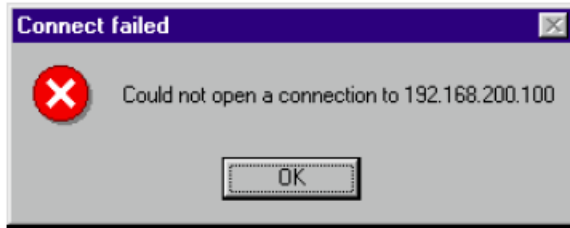

The NPort will automatically reboot with the new IP address. You can verify that the configuration was successful by connecting to the new IP address with Telnet, ping, the web console, or NPort Search Utility.

Using the Telnet Console to Assign IP Address

1. Select **Run...** from the Windows Start menu.
2. Enter **telnet 192.168.126.254** (the NPort's default IP address) and click **[OK]**.

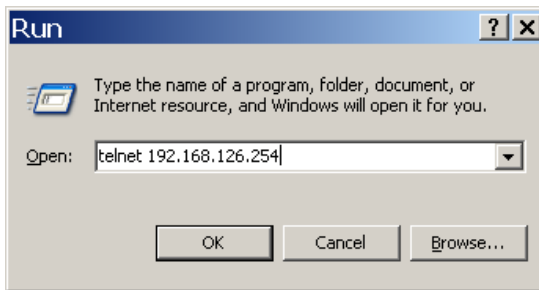

3. Enter your login account and password, then press **ENTER**.

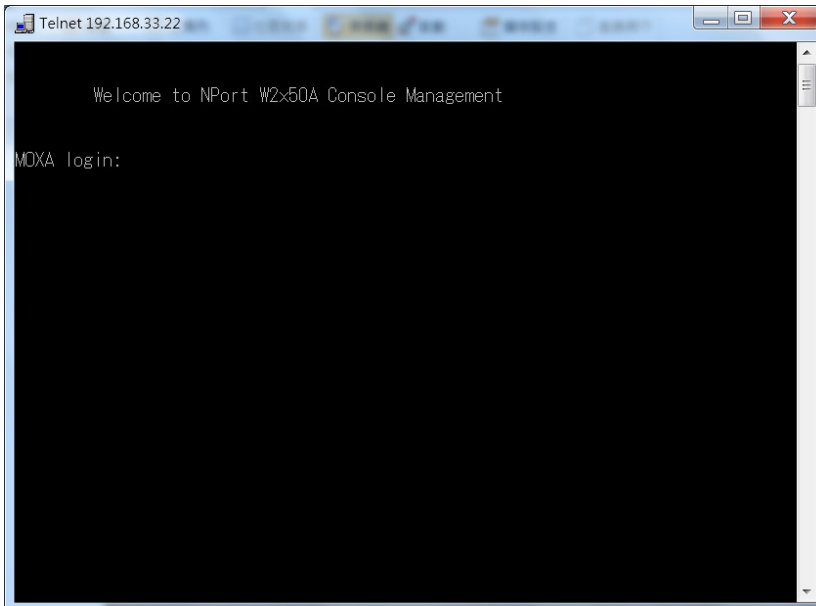

4. You will login to the **Overview** page.

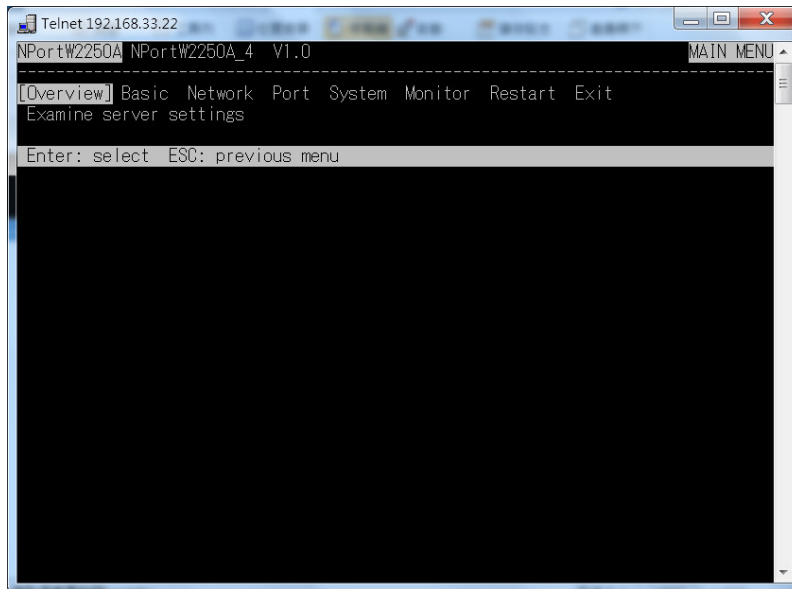

5. Press **N** or use the cursor keys to select **Network** and press **ENTER**.

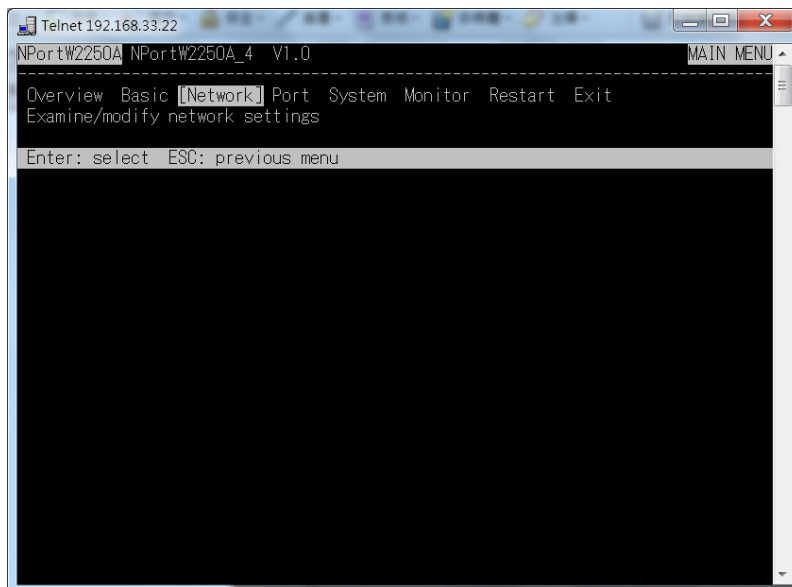

6. Press **E** or use the cursor keys to select **Ethernet** and press **ENTER**.

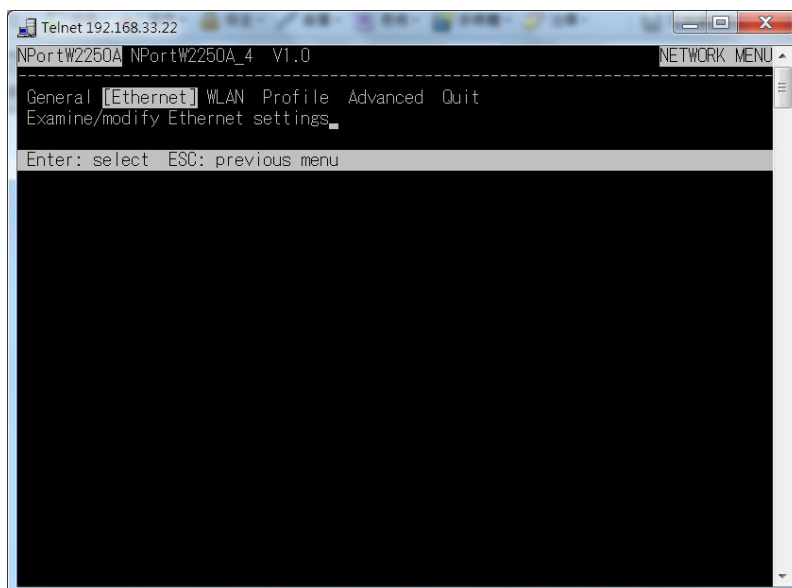

- Use the cursor keys to navigate between the different fields. For **IP address**, **Netmask**, and **Gateway**, enter the desired values directly. For **IP configuration** and **LAN speed**, press **ENTER** to open a submenu and select between the available options.

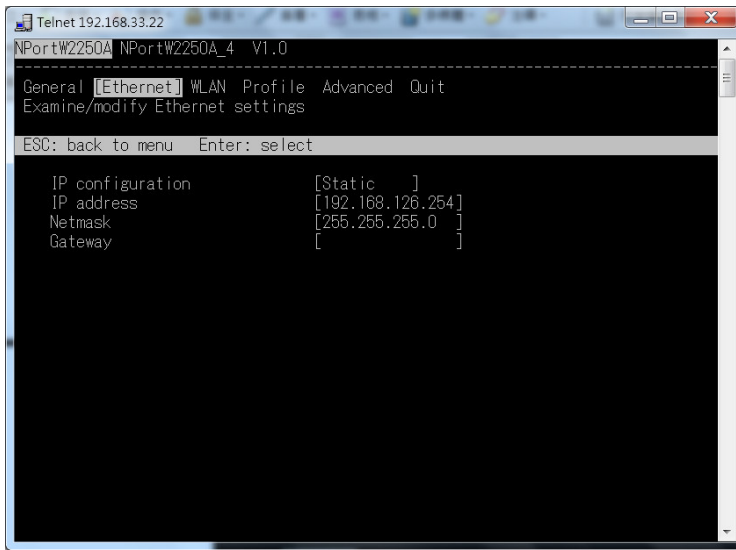

- Press **ESC** to return to the menu. When prompted, press **Y** to save the configuration changes.

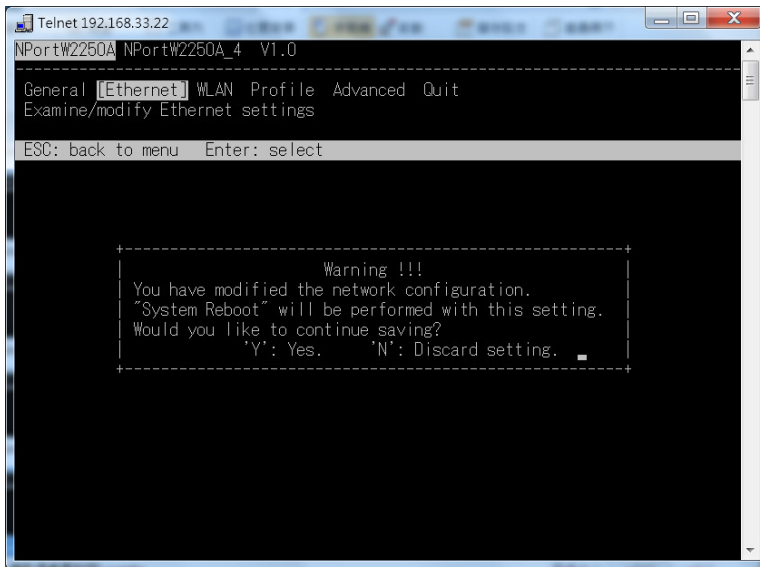

The NPort will reboot with the new IP settings. You can telnet to the new IP to login again.

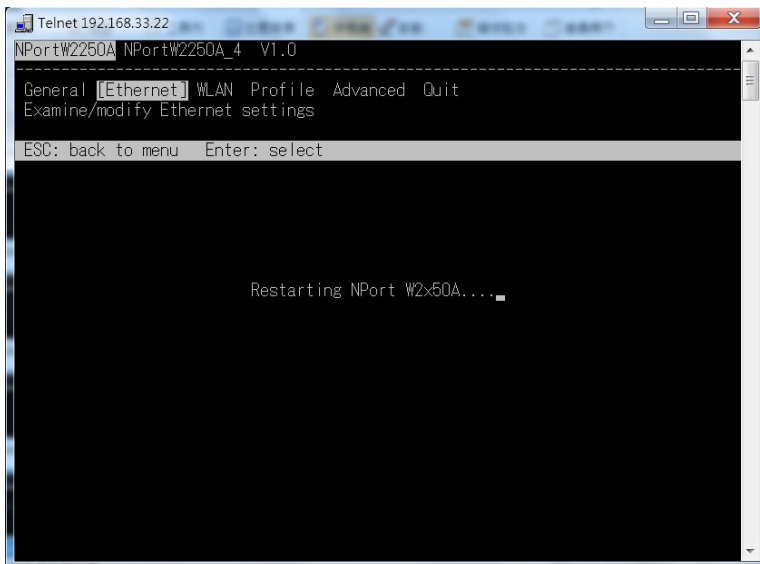

Using the Serial Console to Assign IP Address

Before using the NPort's serial console, turn off the power and use a serial cable to connect the NPort console port to your computer's serial port. Port 1 on the NPort serves as the console port. Use Port 1 connecting to the console port with a serial-based terminal or terminal emulator program, such as Windows HyperTerminal. You may also download PComm Lite at www.moxa.com. The terminal type should be set as ANSI or VT100, and the serial communication parameters should be set as 19200, 8, N, 1 (19200 for baud rate, 8 for data bits, None for parity, and 1 for stop bits). As soon as the connection is open, you will be presented with a text menu displaying the NPort W2150A/W2250A Series general settings. Please refer to Chapter 4 for a description of the available settings. The following instructions, we recommend using PComm Terminal Emulator, which can be downloaded free of charge from www.moxa.com, to carry out the configuration procedure.

1. Connect your PC's serial port to the NPort's console port.
2. Open your terminal emulator program, such as Windows HyperTerminal. We recommend using PComm Terminal Emulator, which can be downloaded for free at www.moxa.com.
3. In your terminal emulator program, configure the communication parameters for the serial port on the PC. The parameters should be set to **19200** for baud rate, **8** for data bits, **None** for parity, and **1** for stop bits.

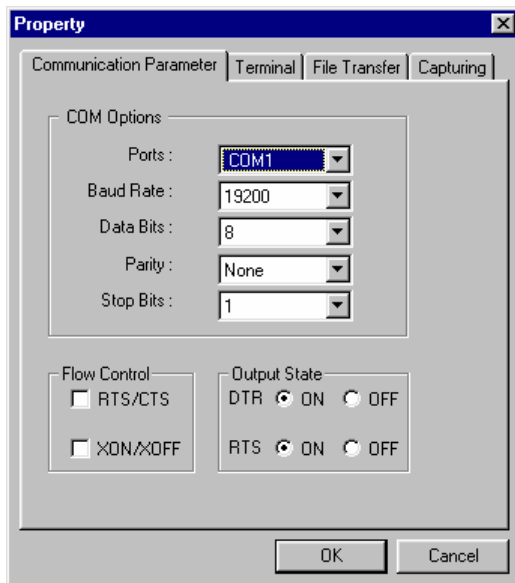

4. In your terminal emulator program, set the terminal type to **ANSI** or **VT100**. If you select **Dumb Terminal** as the terminal type, some of the console functions—especially the “Monitor” function—may not work properly.

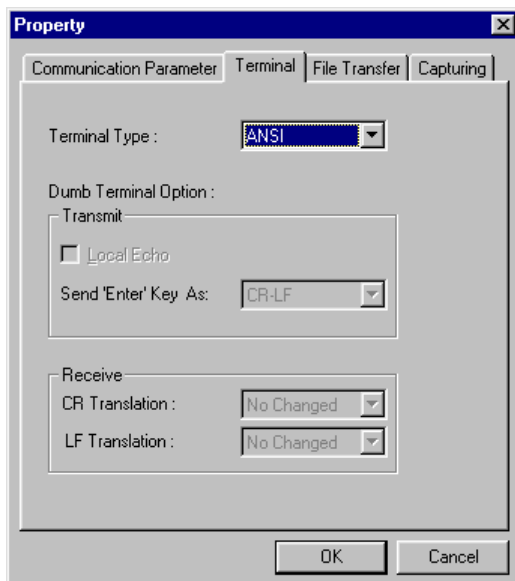

5. Hold the **grave accent** key (`) down and power up the NPort.



The continuous string of grave accent characters triggers the NPort to switch from data mode to console mode.

6. The serial console will open and will be functionally identical to the Telnet console. Please refer to the Telnet console section for instructions on how to navigate the console and configure the IP settings.

Introduction to Operation Modes

The following topics are covered in this chapter:

- **Overview**
- **RealCOM Mode**
- **RFC2217 Mode**
- **TCP Server Mode**
- **TCP Client Mode**
- **UDP Mode**
- **Pair Master and Pair Connection Modes**
- **Ethernet Modem Mode**

Overview

This chapter introduces the different serial port operation modes that are available on the NPort W2150A/W2250A Series. Each serial port on the NPort is configured independently of the other ports, with its own serial communication parameters and operation mode. The serial port's operation mode determines how it interacts with the network, and different modes are available to encompass a wide variety of applications and devices.

RealCOM and **RFC2217** modes allow serial-based software to access the NPort serial port as if it were a local serial port on a PC. These modes are appropriate when your application relies on Windows or Linux software that was originally designed for locally attached COM or TTY devices. With these modes, you can access your devices from the network using your existing COM/TTY-based software, without investing in additional software.

Three different socket modes are available for user-developed socket programs: **TCP Server**, **TCP Client**, and **UDP Server/Client**. For TCP applications, the appropriate mode depends on whether the connection will be hosted or initiated from the NPort serial port or from the network. The main difference between the TCP and UDP protocols is that TCP guarantees delivery of data by requiring the recipient to send an acknowledgement to the sender. UDP does not require this type of verification, making it possible to offer speedier delivery. UDP also allows multicasting of data to groups of IP addresses and would be suitable for streaming media or non-critical messaging applications such as LED message boards.

Pair Connection Slave and **Master** modes are designed for serial-to-serial communication over Ethernet, in order to overcome traditional limitations with serial transmission distance.

In **Ethernet Modem** mode, the NPort acts as an Ethernet modem, providing a network connection to a host through the serial port.

RealCOM Mode

RealCOM mode is designed to work with NPort drivers that are installed on a network host. COM drivers are provided for Windows systems, and TTY drivers are provided for Linux and UNIX systems. The driver establishes a transparent connection to the attached serial device by mapping a local serial port to the NPort serial port. RealCOM mode supports up to four simultaneous connections, so multiple hosts can collect data from the attached device at the same time.

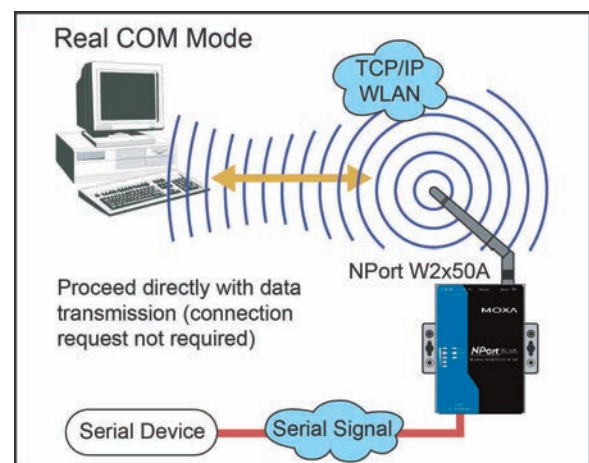

ATTENTION

RealCOM drivers are installed and configured through NPort Windows Driver Manager.

RealCOM mode allows you to continue using your serial communications software to access devices that are now attached to your NPort device server. On the host, the NPort RealCOM driver automatically intercepts data sent to the COM port, packs it into a TCP/IP packet, and redirects it to the network. At the other end of the connection, the NPort device server accepts the Ethernet frame, unpacks the TCP/IP packet, and sends the serial data to the appropriate device.



ATTENTION

In RealCOM mode, several hosts can have simultaneous access control over the NPort serial port. If necessary, you can limit access by using the NPort’s Accessible IP settings. Please refer to Chapter 8 for additional information on Accessible IP settings.

RFC2217 Mode

RFC-2217 mode is similar to RealCOM mode, since it relies on a driver to transparently map a virtual COM port on a host computer to a serial port on the NPort. The RFC2217 standard defines general COM port control options based on the Telnet protocol and supports one connection at a time. Third party drivers supporting RFC-2217 are widely available on the Internet and can be used to implement virtual COM mapping.

TCP Server Mode

In TCP Server mode, the NPort serial port is assigned an IP:port address that is unique on your TCP/IP network. It waits for the host computer to establish a connection to the attached serial device. This operation mode also supports up to eight simultaneous connections, so multiple hosts can collect data from the attached device at the same time.

Data transmission proceeds as follows:
 A host requests a connection to the NPort serial port. Once the connection is established, data can be transmitted in both directions—from the host to the device, and from the device to the host.

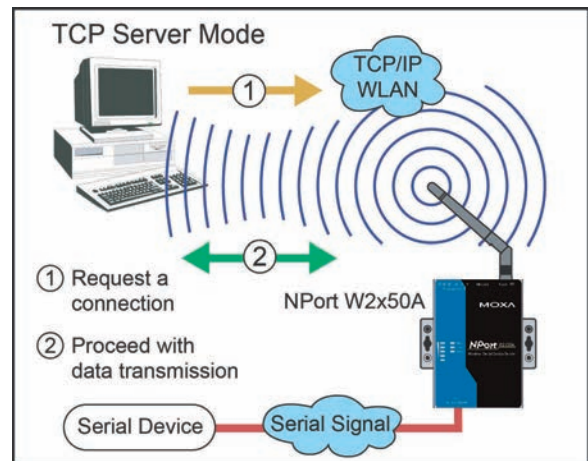

TCP Client Mode

In TCP Client mode, the NPort actively establishes a TCP connection to a specific network host when data is received from the attached serial device. After the data has been transferred, the NPort can automatically disconnect from the host computer through the Inactivity time settings. Please refer to Chapter 7 for details on these parameters.

Data transmission proceeds as follows:
 The NPort requests a connection from the host. The connection is established and data can be transmitted in both directions between the host and device.

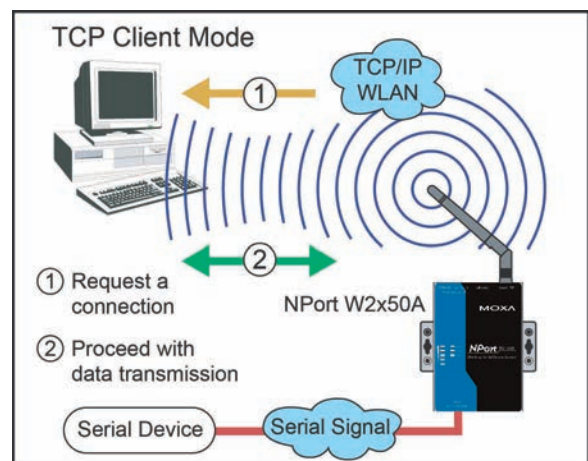

UDP Mode

UDP is similar to TCP but is faster and more efficient. Data can be broadcast to or received from multiple network hosts. However, UDP does not support verification of data and would not be suitable for applications where data integrity is critical. It is ideal for message display applications.

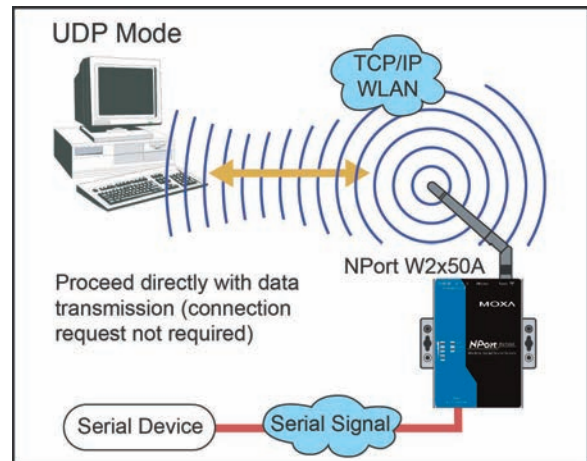

Pair Connection Modes

Pair Connection Master and Slave modes connect two NPort device servers over a network for serial-to-serial communication. A device attached to one NPort can then communicate transparently to a device attached to the other NPort, as if the two devices were connected by a serial cable. Both data and modem control signals are exchanged, except for DCD signals. This can be used to overcome traditional limitations with serial communication distance and introduces many new possibilities for serial-based device control.

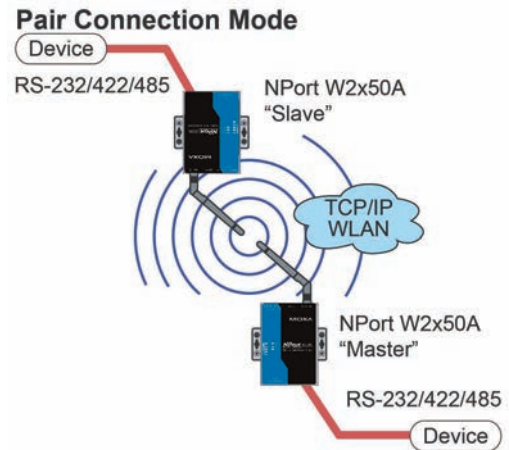

Ethernet Modem Mode

Ethernet Modem mode is designed for use with legacy operating systems, such as MS-DOS, that do not support TCP/IP Ethernet. By connecting the properly configured NPort serial port to the MS-DOS computer's serial port, it is possible to use legacy software to transmit data over the Ethernet when the software was originally designed to transmit data over a modem.

Ethernet Modem Mode

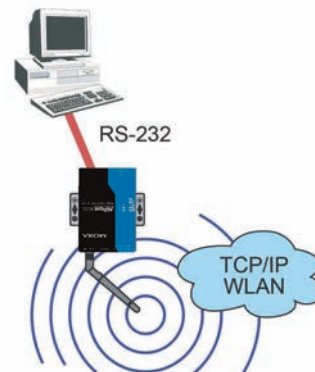

Web Console: Basic Settings

The following topics are covered in this chapter:

- **Overview**
- **Basic Settings**

Overview

This chapter introduces the NPort web console and explains how to configure the basic settings.

The NPort can be configured from anywhere on the network through its web console. Simply point the browser to the device server's IP address to open the web console. Network settings, operation mode, and other items can all be configured through the browser.

Web Browser Settings

In order to use the web console, you will need to have cookies enabled for your browser. Please note that the web console uses cookies only for password transmission. For Internet Explorer, cookies can be enabled by right-clicking the Internet Explorer icon on your desktop and selecting Properties from the context menu.

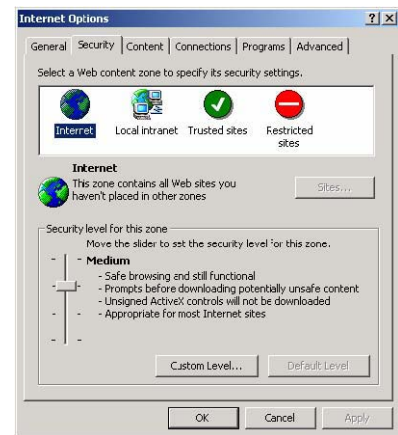

On the Security tab, click "Custom Level..." and enable these two items:
 Allow cookies that are stored on your computer.
 Allow per-session cookies (not stored).

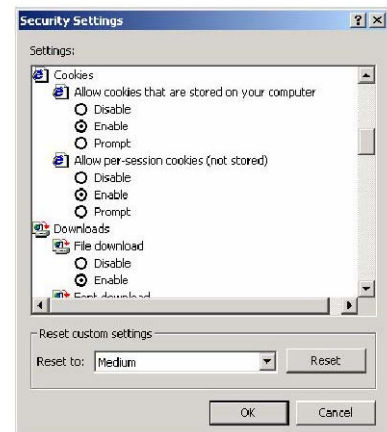

ATTENTION

If you are not using Internet Explorer, cookies are usually enabled through a web browser setting such as "allow cookies that are stored on your computer" or "allow per-session cookies."

Navigating the Web Console

To open the web console, enter your device server's IP address in the website address line. If you are configuring the NPort for the first time over an Ethernet cable, you will use the default IP address, **192.168.126.254**.

There are two account types: **admin** and **user**. If you enter the system with **admin** account, you will have the right to read and write. If you enter the system with **user** account, you will only have the right to read.

If prompted, enter the console password. You will only be prompted for a password if you have enabled password protection on the device server. The password will be transmitted with MD5 encryption over the Ethernet.

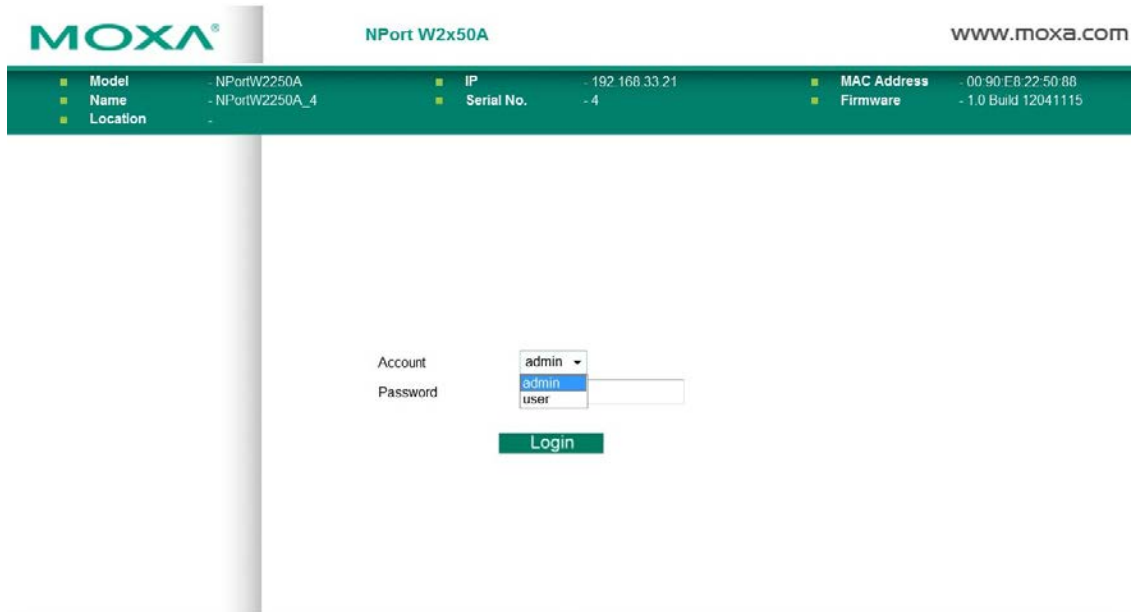

ATTENTION

If you have forgotten the password, you can use the reset button to load factory defaults, but this will erase all previous configuration information.

The web console will appear as shown below.

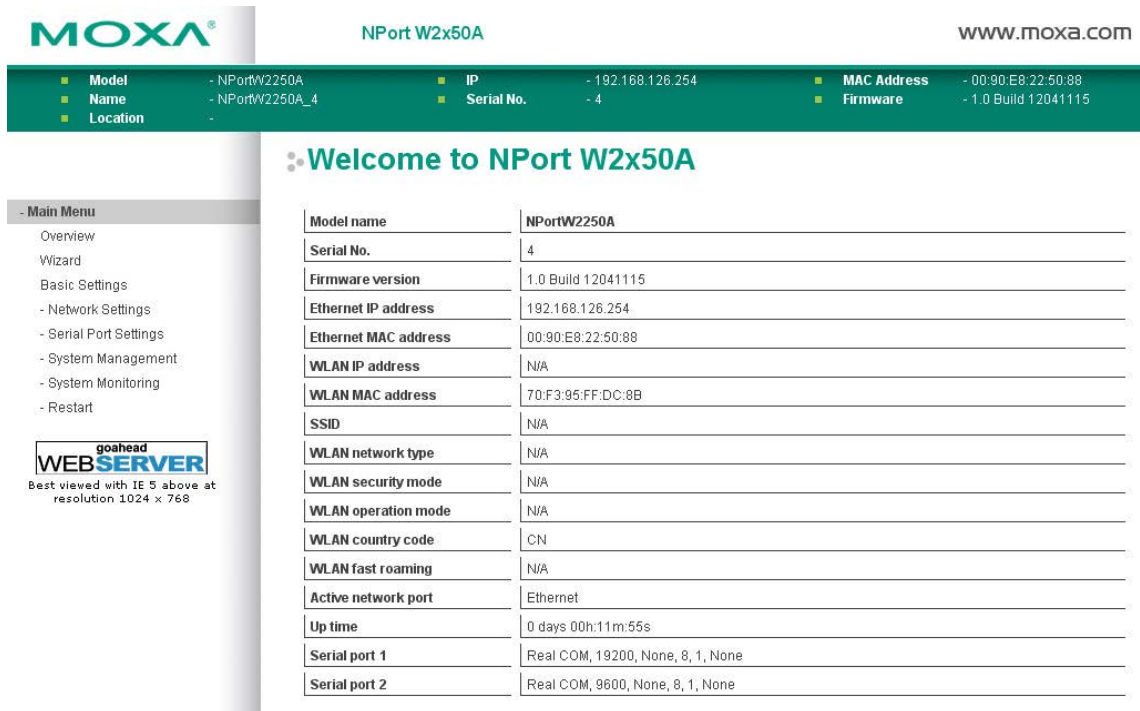

Settings are presented on pages that are organized by folder. Select the desired folder in the left navigation panel to open that page. The page will be displayed in the main window on the right. Certain folders can be expanded by clicking the adjacent “-” symbol.

For example, if you click **Basic Settings** in the navigation panel, the main window will show a page of basic settings that you can configure.

After you have made changes on a page, you must click **[Submit]** in the main window before jumping to another page. Your changes will be lost if you do not click **[Submit]**.

Once you click [Submit] button, the device server will reboot and with a beep alarm.

Basic Settings

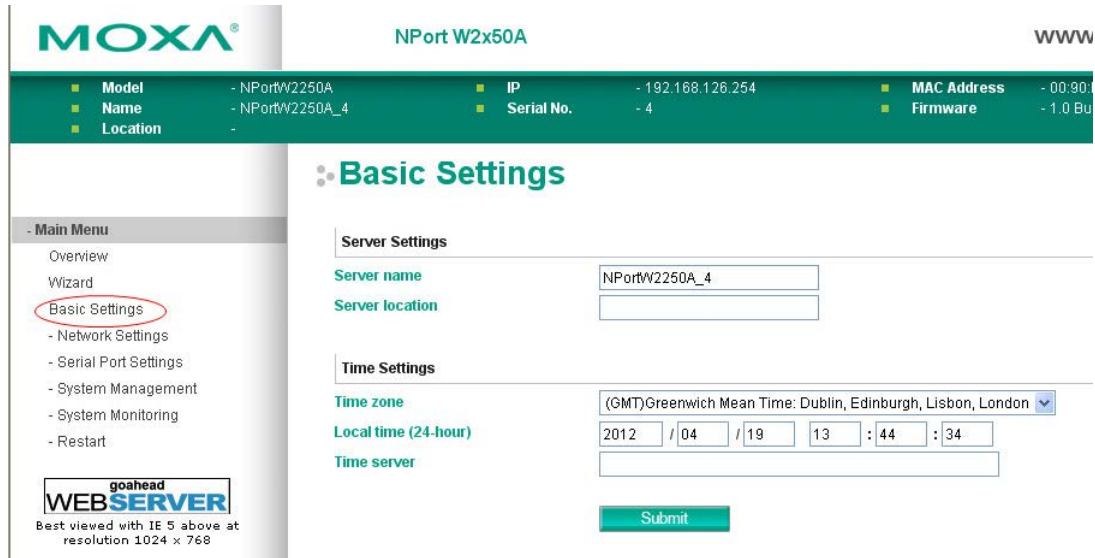

On the **Basic Settings** page, you can configure **Server name**, **Server location**, **Time zone (24-hour)**, **Local time**, and **Time server**.

Server Name

Default	NPortW2150A_<serial no.> or NPortW2250A_<serial no.>
Options	free text (e.g., "Server 1")
Description	This is an optional free text field to help you differentiate one device server from another. It does not affect operation of the NPort device server.

Server Location

Default	
Options	free text (e.g., "Bldg 1, 2nd Floor")
Description	This is an optional free text field to help you differentiate one device server from another. It does not affect operation of the NPort device server.

Time Zone

Default	(GMT)Greenwich Mean Time
Options	(GMT)Greenwich Mean Time (GMT-01:00)Azores, Cape Verde Is. (GMT-02:00)Mid-Atlantic etc.
Description	This field shows the currently selected time zone and allows you to select a different time zone.

Local Time

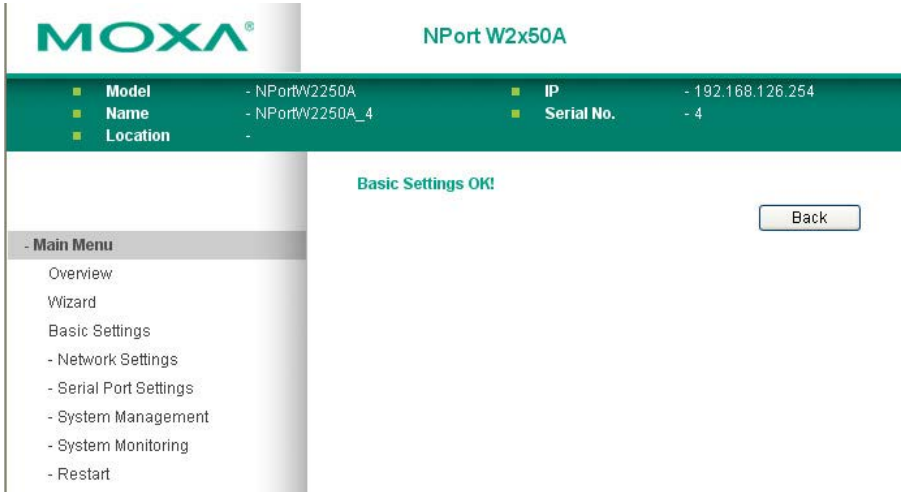
Default	
Options	Date (yy:mm:dd), Time (hh:mm:ss)
Description	<p>The NPort has a built-in real-time clock that allows you to add time information to functions such as the automatic warning e-mail or SNMP trap. This field shows the current time according to the NPort's built-in real-time clock. This is not a live field, so you will need to refresh the browser to get an updated reading.</p> <p>Change the correct date or time, and click [Submit]. The change will take effect directly, and shows Basic Setting OK!.</p>  <p>The screenshot shows the Moxa NPort W2x50A web console interface. At the top, there is a green header with the Moxa logo and the device name 'NPort W2x50A'. Below this is a green status bar displaying system information: Model (NPortW2250A), Name (NPortW2250A_4), Location (-), IP (192.168.126.254), and Serial No. (4). A central message box displays 'Basic Settings OK!' with a 'Back' button. On the left side, there is a 'Main Menu' with the following items: Overview, Wizard, Basic Settings (highlighted), Network Settings, Serial Port Settings, System Management, System Monitoring, and Restart.</p>



ATTENTION

There is a risk of explosion if the real-time clock battery is replaced incorrectly! The real time clock is powered by a lithium battery. We strongly recommend that you obtain assistance from a Moxa support engineer before replacing the battery. Please contact the Moxa RMA service team if you need to change the battery.

Time Server

Default	
Options	IP address or domain name (e.g., "192.168.1.1" or "time.nist.gov")
Description	<p>This optional field specifies your time server's IP address or domain name, if a time server is used in your network. The NPort supports SNTP (RFC-1769) for automatic time calibration. The device server will request time information from the specified time server every 10 minutes.</p>

Web Console: Network Settings

The following topics are covered in this chapter:

- **Overview**

- **Network Settings**

- General Settings
- Ethernet Settings
- WLAN Settings
- Advanced Settings

Overview

This chapter explains how to configure all settings located under the **Network Settings** folder in the NPort web console.

Network Settings

General Settings

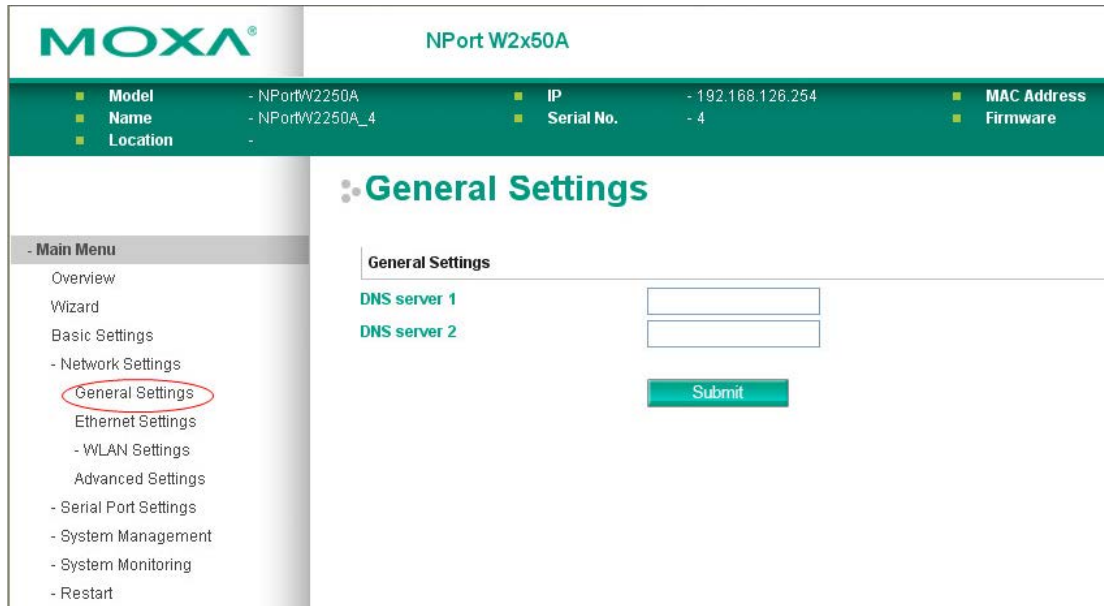

On the **General Settings** page in the **Network Settings** folder, you can modify **DNS server 1 and 2**.

DNS Server 1 and 2

Default	
Options	IP address (e.g., "192.168.1.1")
Description	<p>This field is for the DNS server's IP address, if applicable. With the DNS server configured, the NPort device server can use domain names instead of IP addresses to access hosts.</p> <p>Domain Name System (DNS) is how Internet domain names are identified and translated into IP addresses. A domain name is an alphanumeric name, such as www.moxa.com, that it is usually easier to remember than the numeric IP address. A DNS server is a host that translates a text-based domain name into an IP address in order to establish a TCP/IP connection. When the user wants to visit a particular website, the user's computer sends the domain name (e.g., www.moxa.com) to a DNS server to request that website's numeric IP address. When the IP address is received from the DNS server, the user's computer uses that information to connect to the website's web server.</p> <p>The NPort will play the role of a DNS client, actively querying the DNS server for the IP address associated with a particular domain name.</p>

Ethernet Settings

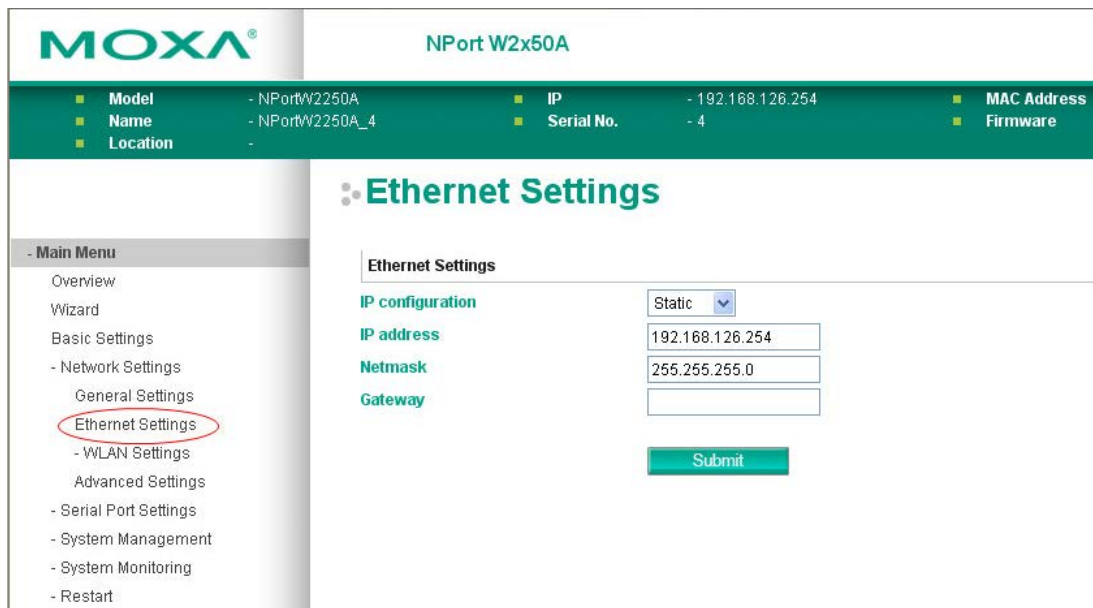

On the **Ethernet Settings** page in the **Network Settings** folder, you can modify **IP configuration**, **IP address**, **Netmask**, and **Gateway**.

You must assign a valid IP address to the NPort before it will work in your network environment. Your network system administrator should provide you with an IP address and related settings for your network. The IP address must be unique within the network; otherwise the NPort will not have a valid connection to the network. First-time users should refer to Chapter 3, "Initial IP Address Configuration," for more information.

IP Configuration

Default	Static
Options	Static, DHCP, DHCP/BOOTP, BOOTP
Description	This field determines how the NPort's IP address will be assigned. Static: IP address, netmask, and gateway are user-defined. DHCP: IP address, netmask, gateway, DNS, and time server are assigned by DHCP server. DHCP/BOOTP: IP address, netmask, gateway, DNS, and time server are assigned by DHCP server. IP address is assigned by BOOTP server if DHCP server does not respond. BOOTP: IP address is assigned by BOOTP server.

IP Address

Default	192.168.126.254
Options	IP address (e.g., "192.168.1.1")
Description	This field is for the IP address that will be assigned to your NPort device server. An IP address is a number assigned to a network device (such as a computer) as a permanent address on the network. Computers use the IP address to identify and talk to each other over the network. Choose a proper IP address that is unique and valid in your network environment. If your device server will be assigned a dynamic IP address, set the "IP configuration" parameter appropriately.

Netmask

Default	255.255.255.0
Options	Netmask setting (e.g., "255.255.0.0")
Description	This field is for the subnet mask. A subnet mask represents all of the network hosts at one geographic location, in one building, or on the same local area network. When a packet is sent out over the network, the NPort device server will use the subnet mask to check whether the desired TCP/IP host specified in the packet is on the local network segment. If the address is on the same network segment as the device server, a connection is established directly from the device server. Otherwise, the connection is established through the gateway as specified in the "Gateway" parameter.

Gateway

Default	
Options	IP address (e.g., "192.168.1.1")
Description	This field is for the IP address of the gateway, if applicable. A gateway is a network computer that acts as an entrance to another network. Usually, the computers that control traffic within the network or at the local Internet service provider are gateway nodes. The NPort device server needs to know the IP address of the default gateway computer in order to communicate with the hosts outside the local network environment. Consult your network administrator if you do not know how to set this parameter.



ATTENTION

In dynamic IP environments, the NPort will send 3 requests every 30 seconds to the DHCP or BOOTP server until the network settings have successfully been assigned. The first request will time out after one second; the second request will time out after three seconds, and the third request will timeout after five second. If the DHCP or BOOTP server is unavailable, the NPort will use the factory default network settings.

WLAN Settings

WLAN

The screenshot shows the MOXA NPort W2x50A web console. At the top, the MOXA logo and device model 'NPort W2x50A' are displayed. Below this is a green status bar containing system information: Model (NPortW2250A), Name (NPortW2250A_4), Location (-), IP (192.168.126.254), Serial No. (- 4), MAC Address, and Firmware. The left-hand navigation menu includes 'Main Menu', 'Overview', 'Wizard', 'Basic Settings', 'Network Settings', 'WLAN Settings' (with 'WLAN Profile' circled in red), 'Advanced Settings', 'Serial Port Settings', 'System Management', 'System Monitoring', and 'Restart'. The main content area is titled 'WLAN Settings' and features a 'WLAN Settings' section with a 'Static' dropdown for IP configuration. Below this are input fields for 'IP address' (192.168.127.254), 'Netmask' (255.255.255.0), and 'Gateway'. A green 'Submit' button is located at the bottom of the configuration area.

The **WLAN** page is located under **WLAN Settings** in the **Network Settings** folder. You can modify **IP configuration**, **IP address**, **Netmask**, and **Gateway** for your WLAN.

The NPort W2150A/W2250A Series supports IEEE 802.11a/b/g wireless network interfaces. The supported IP configurations are static and dynamic (BOOTP, DHCP, or BOOTP+DHCP). Users can set up the IP configuration with the serial console, or the Web/Telnet consoles through the NPort's Ethernet interface. For detailed information about configuring **IP configuration**, **IP address**, **Netmask**, and **Gateway**, see the previous section, Ethernet Configuration.

IP Configuration

Default	Static
Options	Static, DHCP, DHCP/BOOTP, BOOTP
Description	This field determines how the NPort's IP address will be assigned. Static: IP address, netmask, and gateway are user-defined. DHCP: IP address, netmask, gateway, DNS, and time server are assigned by DHCP server. DHCP/BOOTP: IP address, netmask, gateway, DNS, and time server are assigned by DHCP server. IP address is assigned by BOOTP server if DHCP server does not respond. BOOTP: IP address is assigned by BOOTP server.

IP Address

Default	192.168.127.254
Options	IP address (e.g., "192.168.1.1")
Description	This field is for the IP address that will be assigned to your NPort device server. An IP address is a number assigned to a network device (such as a computer) as a permanent address on the network. Computers use the IP address to identify and talk to each other over the network. Choose a proper IP address that is unique and valid in your WLAN environment. If your device server will be assigned a dynamic IP address, set the "IP configuration" parameter appropriately.

Netmask

Default	255.255.255.0
Options	Netmask setting (e.g., "255.255.0.0")
Description	This field is for the subnet mask. A subnet mask represents all of the network hosts at one geographic location, in one building, or on the same local area network. When a packet is sent out over the network, the NPort device server will use the subnet mask to check whether the desired TCP/IP host specified in the packet is on the local network segment. If the address is on the same network segment as the device server, a connection is established directly from the device server. Otherwise, the connection is established through the gateway as specified in the "Gateway" parameter.

Gateway

Default	
Options	IP address (e.g., "192.168.1.1")
Description	This field is for the IP address of the gateway, if applicable. A gateway is a network computer that acts as an entrance to another network. Usually, the computers that control traffic within the network or at the local Internet service provider are gateway nodes. The NPort device server needs to know the IP address of the default gateway computer in order to communicate with the hosts outside the local network environment. Consult your network administrator if you do not know how to set this parameter.

Profile

MOXA NPort W2x50A

Model	- NPortW2250A	IP	- 192.168.126.254	MAC Address	
Name	- NPortW2250A_4	Serial No.	- 4	Firmware	
Location	-				

Wireless LAN Profile Settings

Wireless LAN Profile

Network type: Infrastructure Mode (dropdown menu open showing Infrastructure Mode and Ad-hoc Mode)

Profile name: [text input]

Buttons: General, Security

Submit, Activate

Please remember to activate Profile service by pressing "Activate" button after configuring.

Main Menu

- Overview
- Wizard
- Basic Settings
- Network Settings
 - General Settings
 - Ethernet Settings
 - WLAN Settings
 - WLAN (circled)
 - Profile (circled)
 - Advanced Settings
 - Serial Port Settings
 - System Management
 - System Monitoring
 - Restart

MOXA NPort W2x50A

Model	- NPortW2250A	IP	- 192.168.126.254	MAC Address	
Name	- NPortW2250A_4	Serial No.	- 4	Firmware	
Location	-				

WLAN Profile Properties

General Properties

Profile name: Infrastructure

Operation mode: Auto (dropdown menu open showing Auto)

SSID: profile1

Fast roaming: Disable (dropdown menu open showing Disable)

Scan channels - 1: N/A (dropdown menu open showing N/A)

Scan channels - 2: N/A (dropdown menu open showing N/A)

Scan channels - 3: N/A (dropdown menu open showing N/A)

Submit

Main Menu

- Overview
- Wizard
- Basic Settings
- Network Settings
 - General Settings
 - Ethernet Settings
 - WLAN Settings
 - WLAN
 - Profile (circled)
 - Advanced Settings
 - Serial Port Settings
 - System Management
 - System Monitoring
 - Restart

The **Profile** page is located under **WLAN Settings** in the **Network Settings** folder. This is where you configure the NPort for Ad-hoc or Infrastructure operation. Different settings are available depending on whether you select Ad-hoc Mode or Infrastructure Mode.

Network Type

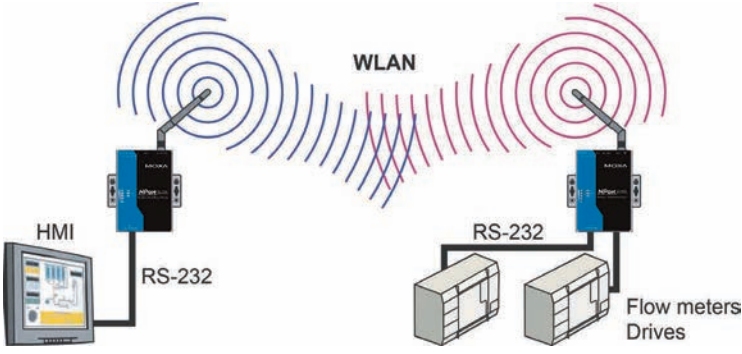
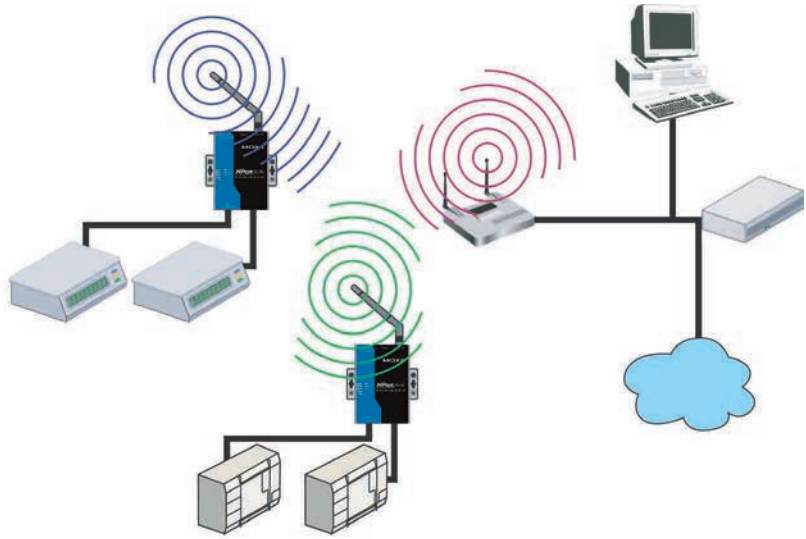
Default	Infrastructure Mode
Options	Infrastructure Mode, Ad-hoc Mode
Description	<p>This field specifies whether the NPort will operate in Ad-hoc or Infrastructure Mode. For all wireless networking devices, there are two possible modes for communication with another wireless device. Devices that are configured for Ad-hoc Mode automatically detect and communicate directly with each other and do not require a wireless access point (AP) or gateway. Wireless devices that are configured for Infrastructure Mode do not communicate directly with each other, but through a wireless access point (AP).</p> <p>Devices must be configured for the same mode in order to communicate with each other. Devices in Ad-Hoc Mode will only recognize other devices in Ad-Hoc Mode, and likewise for devices in Infrastructure Mode.</p> <p>Example of Ad-Hoc Mode</p>  <p>Example of Infrastructure Mode</p>  <p>After setting the Network type, you will need to adjust the General and Security settings for the profile. In Ad-hoc Mode, only one profile is available. In Infrastructure Mode, three profiles can be defined.</p>

General Settings for WLAN Profile

The **General** page is opened through the **Profile** page, under **WLAN Settings** in the **Network Settings** folder. You can type a profile name to help you differentiate one profile from another. It does not affect operation of the NPort. After selecting Ad-hoc or Infrastructure Mode, click **[General]** to open the General page for the selected profile. In Ad-hoc Mode and Infrastructure Mode, only one profile is available.

In Ad-hoc Mode

The screenshot shows the MOXA NPort W2x50A web console interface. At the top, there is a header with the MOXA logo and the device model 'NPort W2x50A'. Below this is a status bar with system information: Model (NPortW2250A), Name (NPortW2250A_4), Location (-), IP (192.168.126.254), Serial No. (- 4), MAC Address, and Firmware. The main content area is titled 'Wireless LAN Profile Settings'. On the left is a 'Main Menu' with options like Overview, Wizard, Basic Settings, Network Settings, WLAN Settings, Profile, and Advanced Settings. The 'Wireless LAN Profile' section shows 'Network type' set to 'Ad-hoc Mode' and 'Profile name' set to 'Adhoc'. There are two tabs: 'General' (circled in red) and 'Security'. Below the tabs are 'Submit' and 'Activate' buttons. A note says: 'Please remember to activate Profile service by pressing "Activate" button after configuring.' A red arrow points from the 'General' tab to the 'WLAN Profile Properties' page below.

WLAN Profile Properties

The second screenshot shows the 'WLAN Profile Properties' page. It has the same header and status bar as the first. The 'General Properties' section contains the following fields: 'Profile name' (Adhoc), 'Operation mode' (802.11b/g), 'SSID' (empty), and 'Channel' (1). A 'Submit' button is located at the bottom of the form.

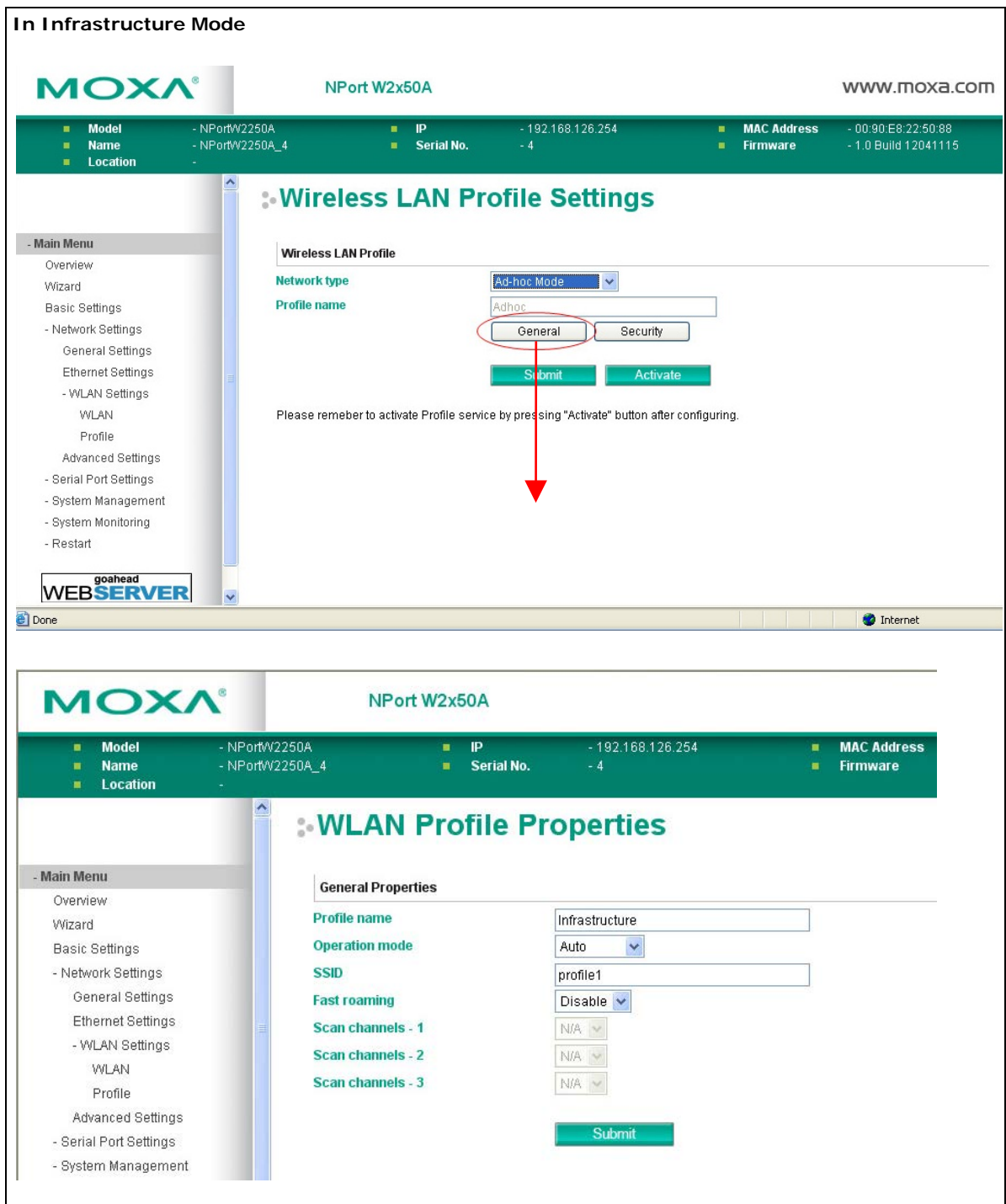

On the General page, you can configure **Profile name**, **Operation mode**, and **SSID**. Additional settings are also available depending on whether you select Ad-hoc Mode or Infrastructure Mode.

Profile Name

Default	Ad-hoc (in Ad-hoc Mode) Infrastructure (in Infrastructure Mode)
Options	free text (e.g., "Primary Connection")
Description	This is a free text field to help you differentiate one profile from another. It does not affect operation of the NPort.

Operation Mode

Default	802.11b/g for Ad-Hoc Mode. Auto, 802.11b/g, and 802.11a for Infrastructure Mode.
Options	Auto, 802.11a, 802.11b/g
Description	<p>This field determines which wireless standard will be used by the selected profile. 802.11a, 802.11b, and 802.11g are supported.</p> <p>Auto: In Ad-hoc Mode, the NPort will scan the 2.4G wireless band and will automatically select the appropriate wireless standard for communication with any other wireless devices that are detected. In Infrastructure Mode, the NPort will automatically select between 802.11a, 802.11b and 802.11g according to the settings of the AP.</p> <p>802.11a: This setting is only available in Infrastructure Mode. The Unlicensed National Information Infrastructure (UNII) 5 GHz band is used for communication, which is different from the RF band used by 802.11b and 802.11g. Consequently, 802.11a devices will not be able to communicate with 802.11b or 802.11g devices. (Multi-mode 802.11a/b/g APs or client adapters can be used to resolve this.) Transmission rates up to 54Mbps are supported.</p> <p>802.11b/g: This option means our device will support for 802.11b or 802.11g.</p> <p>802.11b: This is the well-known "Wi-Fi" standard, also referred to as "802.11 High-Rate (HR)". Wireless communication is in the 2.4 GHz ISM band, using the DSSS spread spectrum transmission scheme. 802.11b supports data rates of 1 Mbps, 2 Mbps, 5.5 Mbps, and 11 Mbps.</p> <p>802.11g: This is currently the most widely used standard for wireless LANS and is sometimes referred to as "54g™". Communication is in the 2.4 GHz ISM band and uses Orthogonal Frequency Division Multiplexing (OFDM). Data rates up to 54 Mbps are supported.</p>

SSID

Default	Default
Options	free text (e.g., "Coffeeshop WLAN")
Description	This field specifies the SSID, or name, of the wireless network (SSID) that will be used by the NPort. Wireless devices must use the same SSID in order to communicate with each other.

Channel (Ad-hoc mode only)

Default	1
Options	1, 2, 3, 4, 5, 6, 7, 8, 9, 10, 11
Description	This field is for Ad-Hoc Mode only and specifies the radio channel to use for the wireless network.

Fast Roaming (Infrastructure mode only)

Default	Disable
Options	Disable, Enable
Description	<p>This field is only available in Infrastructure Mode and is used to specify the W2150A/W2250A roaming behavior. Roaming is the ability to connect to different APs so wireless communication is not confined to one area or one particular AP. The W2150A/W2250A will only roam between APs, as specified by the SSID.</p> <p>Disable: Fast Roaming function will be disabled.</p> <p>W2150A/W2250A will scan all available channels and roam between APs as specified by the SSID. It scans the channel when booting up and will associate with the highest signal strength AP. Only when the associated AP is loses, then it will re-associate again.</p> <p>Enable: Fast Roaming function will be enabled.</p> <p>NPort W2150A/W2250A will only scan the pre-defined "Scan Channels - 1, Scan Channels - 2 & Scan Channels - 3" and roam between APs as specified by the SSID.</p> <p>It scans the channel and will associate with the highest signal strength AP. It also scans the channel regularly and will re-associate with the highest signal strength AP (if there is) by automatically.</p>

Scan channels – 1, Scan channels – 2, Scan channels – 3 (Infrastructure mode only)

Default	N/A
Options	1 through 14, 36, 40, 44, 48, 52, 56, 60, 64, 100, 104, 108, 112, 116, 120, 124, 128, 132, 136, 140, 149, 153, 157, 161
Description	This field is for fast roaming under Infrastructure Mode and specifies the radio channel to use for the wireless network. Choose the channel according to the factory setting of AP.

Security Settings for WLAN Profile

The **Security** page is opened through the **Profile** page, under **WLAN Settings** in the **Network Settings** folder. After selecting Ad-hoc or Infrastructure Mode, click **[Security]** to open the Security page for the selected profile. In Ad-hoc Mode, only one profile is available, whereas three profiles are available in Infrastructure Mode.

In Ad-hoc Mode

MOXA® NPort W2x50A

Model	- NPortW2250A	IP	- 192.168.126.254	MAC Address	
Name	- NPortW2250A_4	Serial No.	- 4	Firmware	
Location	-				

MOXA® NPort W2x50A

Model	- NPortW2250A	IP	- 192.168.126.254	MAC Address	
Name	- NPortW2250A_4	Serial No.	- 4	Firmware	
Location	-				

Wireless LAN Profile Settings

Wireless LAN Profile

Network type: Ad-hoc Mode

Profile name: Adhoc

General Security

Submit Activate

Please remember to activate Profile service by pressing "Activate" button after configuring.



In Infrastructure Mode

MOXA® NPort W2x50A

Model	- NPortW2250A	IP	- 192.168.126.254	MAC Address	
Name	- NPortW2250A_4	Serial No.	- 4	Firmware	
Location	-				

Wireless LAN Profile Settings

Wireless LAN Profile

Network type: Infrastructure Mode

Profile name: Infrastructure

General Security

Submit Activate

Please remember to activate Profile service by pressing "Activate" button after configuring.

MOXA® NPort W2x50A

Model	- NPortW2250A	IP	- 192.168.126.254	MAC Address	
Name	- NPortW2250A_4	Serial No.	- 4	Firmware	
Location	-				

WLAN Profile Properties

Security Properties

Profile name: Infrastructure

Authentication: Open System

Encryption: Disable

Submit

You will need to configure **Authentication** and **Encryption**. These settings must match the settings on the wireless device at the other end of the connection (such as the AP). Different settings and options are available depending on how **Authentication** and **Encryption** are configured.

Authentication

Default	Open System
Options	Open System, Shared Key, WPA, WPA-PSK, WPA2, WPA2-PSK
Description	<p>This field specifies how wireless devices will be authenticated. Only authenticated devices will be allowed to communicate with the NPort. If a RADIUS server is used, this setting must match the setting on the RADIUS server.</p> <p>Open System: The NPort will simply announce a desire to associate with another station or access point. No authentication is required. For Ad-hoc Mode, this is the only option for authentication, since Ad-hoc Mode was designed for open communication.</p> <p>Shared Key: This option is only available in Infrastructure Mode. Authentication involves a more rigorous exchange of frames to ensure that the requesting station is authentic. WEP encryption is required.</p> <p>WPA: This is a managed authentication option that is only available in Infrastructure Mode. WPA was created by the Wi-Fi Alliance, the industry trade group that owns the Wi-Fi trademark and certifies devices with the Wi-Fi name. It is based on Draft 3 of the IEEE 802.11i standard. Each user uses a unique key for authentication, distributed from an IEEE 802.1X authentication server, also known as a RADIUS server. This option is also referred to as WPA Enterprise Mode, since it is intended to meet rigorous enterprise security requirements. Tunneled authentication is supported, depending on the EAP method selected.</p> <p>WPA-PSK: This is an unmanaged authentication option that is only available in Infrastructure Mode. Instead of a unique key for each user, a pre-shared key (PSK) is manually entered on the access point to generate an encryption key that is shared among all users. Consequently, this method does not scale well for enterprise. A PSK that uses a mix of letters, numbers and non-alphanumeric characters is recommended. This option is also referred to as WPA Personal Mode, since it is designed for the needs and capabilities of small home and office WLANs.</p> <p>WPA2: This is a managed authentication option that is only available in Infrastructure Mode. WPA2 implements the mandatory elements of 802.11i. Supported encryption algorithms include TKIP, Michael, and AES-based CCMP, which is considered fully secure. Since March 13, 2006, WPA2 has been mandatory for all Wi-Fi-certified devices. This option may also be referred to as WPA Enterprise Mode. Tunneled authentication is supported, depending on the EAP method selected.</p> <p>WPA2-PSK: This is an unmanaged authentication option that is only available in Infrastructure Mode. It employs WPA2 encryption algorithms but relies on a PSK for authentication. A PSK that uses a mix of letters, numbers and non-alphanumeric characters is recommended. This option can also be referred to as WPA Personal Mode.</p>

Encryption

Default	Disable
Options	Disable, WEP, TKIP, AES-CCMP
Description	<p>This field specifies the type of encryption to use during wireless communication. Different encryption methods are available depending on the Authentication setting. Also, each encryption method has its own set of parameters that may also require configuration.</p> <p>Disable: No encryption is applied to the data during wireless communication. This option is only available if Authentication is set to Open System.</p> <p>WEP: Wired Equivalent Privacy (WEP) is only available for Open System and Shared Key authentication methods. Data is encrypted according to a key. The NPort supports both 64 and 128-bit keys. This method may deter casual snooping but is not considered very secure.</p> <p>TKIP: Temporal Key Integrity Protocol (TKIP) is only available for WPA, WPA2, WPA-PSK, and WPA2-PSK authentication methods. TKIP is part of a draft standard from the IEEE 802.11i working group and utilizes the RC4 stream cipher with 128-bit keys for encryption and 64-bit keys for authentication. TKIP improves on WEP by adding a per-packet key mixing function to de-correlate the public initialization vectors (IVs) from weak keys.</p> <p>AES-CCMP: This is a powerful encryption method that is only available for WPA, WPA2, WPA-PSK, and WPA2-PSK authentication methods. Advanced Encryption Standard (AES) is the block cipher system used by the Robust Secure Network (RSN) protocol and is equivalent to the RC4 algorithm used by WPA. CCMP is the security protocol used by AES, equivalent to TKIP for WPA. Data undergoes a Message Integrity Check (MIC) using a well-known and proven technique called Cipher Block Chaining Message Authentication Code (CBC-MAC). The technique ensures that even a one-bit alteration in a message produces a dramatically different result. Master keys are not used directly but are used to derive other keys, each of which expire after a certain amount of time. Messages are encrypted using a secret 128-bit key and a 128-bit block of data. The encryption process is complex, but the administrator does not need to be aware of the intricacies of the computations. The end result is encryption that is much harder to break than even WPA.</p>

PSK Passphrase

Default	
Options	free text (e.g., "This is the WLAN passphrase")
Description	<p>This field is only available for WPA-PSK and WPA2-PSK authentication methods. If the NPort's passphrase does not match the AP's passphrase, the connection will be denied. A PSK of sufficient strength—one that uses a mix of letters, numbers and non-alphanumeric characters—is recommended.</p>

Security Settings for WEP Encryption

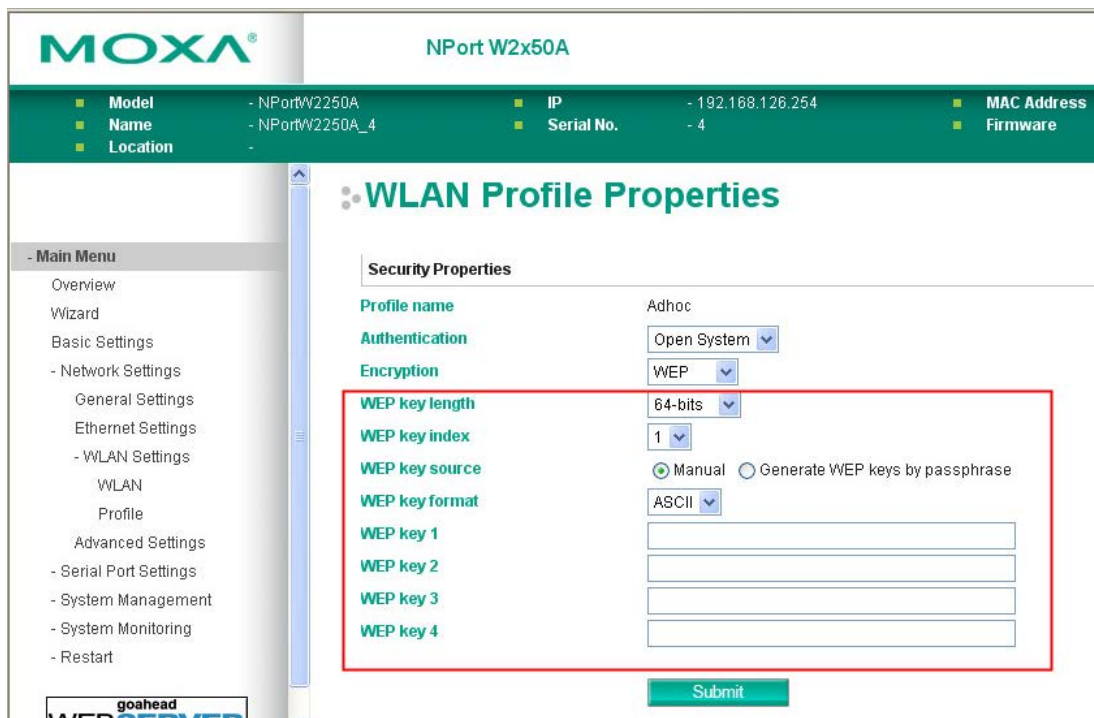
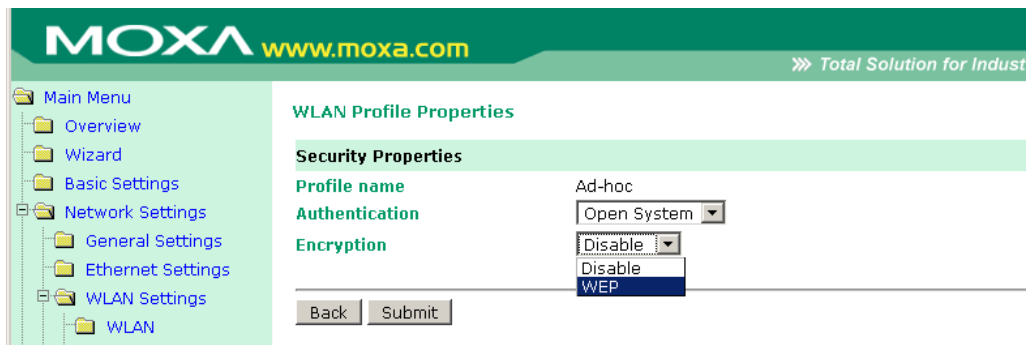

When Encryption is set to WEP on the **Security** page for the WLAN profile, you will be able to configure **WEP key length**, **WEP key index**, and **WEP key source**. Other settings will be displayed depending on how **WEP key source** is configured.

WEP Key Length

Default	64bits
Options	64bits, 128bits
Description	This field specifies the length of the WEP key. 64bits is the industry standard for WEP, but 128bits provides better protection.

WEP Key Index

Default	1
Options	1 through 4
Description	This field specifies the primary WEP key to use for the WLAN.

WEP Key Source

Default	Manual
Options	Manual, Generate WEP keys by passphrase
Description	This field specifies whether the WEP key will be generated manually or through a user-specified passphrase. A passphrase is equivalent to a free-text password that will be used to generate the WEP key. A passphrase is typically easier to remember and enter than a long and complicated WEP key.

WEP Passphrase

Default	
Options	free text (e.g., "This is the WEP passphrase")
Description	This field is only available if WEP key source is set to "Generate WEP keys by passphrase". A standard hexadecimal password will be generated using the supplied passphrase. For example, if "404tech" is entered, the WEP key will be "DB971608E942FC39BD89FC4ADB".

WEP Key Format

Default	ASCII
Options	ASCII, HEX
Description	This field is only available if WEP key source is set to "Manual". It specifies the format you will use to enter the WEP key.

WEP Key 1 Through 4

Default														
Options	free text in ASCII or HEX													
Description	<p>These fields are only available if WEP key source is set to "Manual". Enter each WEP key in ASCII or HEX as specified in WEP key format. The number of characters required for each key depends on WEP key length and WEP key format.</p> <table border="1"> <thead> <tr> <th>WEP Key Length</th> <th>WEP Key Format</th> <th>Key Length</th> </tr> </thead> <tbody> <tr> <td rowspan="2">64bits</td> <td>ASCII</td> <td>5 characters</td> </tr> <tr> <td>HEX</td> <td>10 characters</td> </tr> <tr> <td rowspan="2">128bits</td> <td>ASCII</td> <td>13 characters</td> </tr> <tr> <td>HEX</td> <td>26 characters</td> </tr> </tbody> </table>	WEP Key Length	WEP Key Format	Key Length	64bits	ASCII	5 characters	HEX	10 characters	128bits	ASCII	13 characters	HEX	26 characters
WEP Key Length	WEP Key Format	Key Length												
64bits	ASCII	5 characters												
	HEX	10 characters												
128bits	ASCII	13 characters												
	HEX	26 characters												

Security Settings for WPA, WPA2

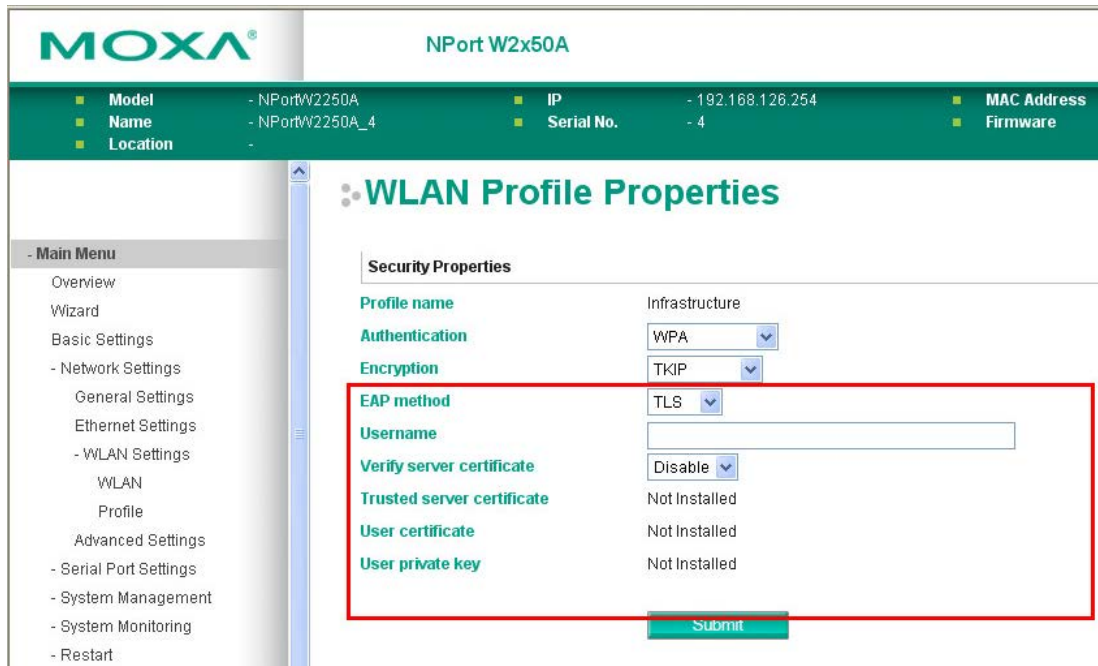
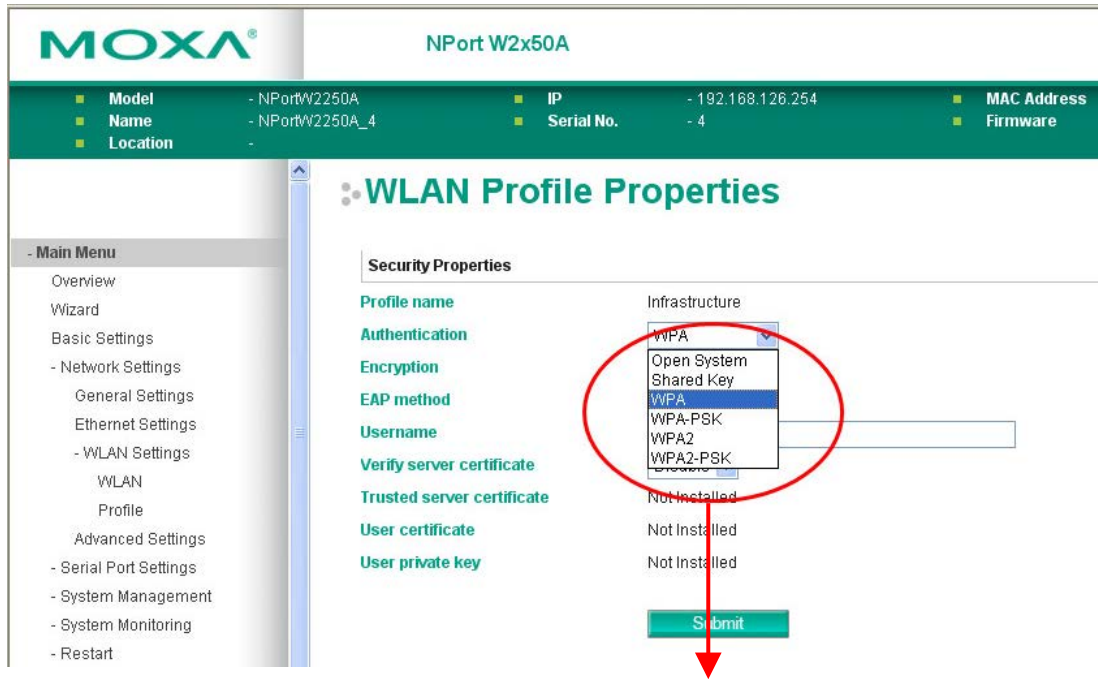

When WPA or WPA2 is used for authentication, you will also need to configure **EAP method** in the **Security** settings for the WLAN profile. Other settings will also be displayed depending on how **EAP method** is configured.

There are two parts to WPA and WPA2 security, authentication and data encryption.

- Authentication occurs before access is granted to a WLAN. Wireless clients such as the NPort W2150A/W2250A Series are first authenticated by the AP according to the authentication protocol used by the RADIUS server. Depending on the WLAN security settings, an EAP tunnel can be used to scramble the username and password that is submitted for authentication purposes.

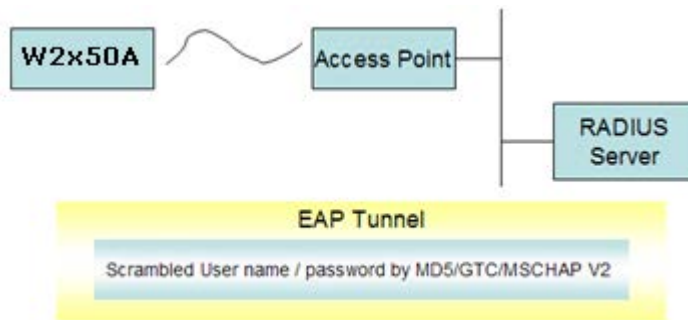

- Encryption occurs after WLAN access has been granted. For all wireless devices, data is first encrypted before wireless transmission, using mutually agreed-upon encryption protocol.

EAP Method

Default	PEAP
Options	TLS, PEAP, TTLS, LEAP
Description	<p>This field specifies the EAP method to use for authentication. Four methods are supported.</p> <p>TLS: Transport Layer Security (TLS) was created by Microsoft and accepted by the IETF as RFC 2716: PPP EAP TLS Authentication Protocol. Passwords and tunneled authentication are not used. A user certificate and user private key are used to identify the NPort. The NPort's user certificate and user private key must already be installed on the RADIUS server.</p> <p>PEAP: Protected Extensible Authentication Protocol (PEAP) is a proprietary protocol which was developed by Microsoft, Cisco and RSA Security.</p> <p>TTLS: Tunneled Transport Layer Security (TTLS) is a proprietary protocol which was developed by Funk Software and Certicom, and is supported by Agere Systems, Proxim, and Avaya. TTLS is being considered by the IETF as a new standard. For more information on TTLS, read the draft RFC EAP Tunneled TLS Authentication Protocol.</p> <p>LEAP: Lightweight Extensible Authentication Protocol (LEAP) is a proprietary protocol which was developed by Cisco. LEAP doesn't check certificate during the authentication process.</p>

Tunneled Authentication

Default	PAP (when using TTLS) GTC (when using PEAP)
Options	GTC, MD5, MSCHAP V2 (when using PEAP) PAP, CHAP, MSCHAP, MSCHAP V2, EAP-MSCHAP V2, EAP-GTC, EAP-MD5 (when using TTLS)
Description	This field specifies the encryption method to use during the authentication process. Different methods are available depending on the EAP Method setting.

Username

Default	
Options	free text (e.g., "Smith_John")
Description	This field specifies the username that will be used to gain access to the WLAN. The correct username and password must be provided for access to be granted.

Password

Default	
Options	free text (e.g., "Password123")
Description	This field specifies the password that will be used to gain access to the WLAN. The correct username and password must be provided for access to be granted.

Anonymous Username

Default	
Options	free text (e.g., "Anyuser")
Description	This field specifies the anonymous username to use when initiating authentication. After the RADIUS Server has been verified by certificate, the true username and password will be used to complete the authentication process.

Verify Server Certificate

Default	Disable
Options	Disable, Enable
Description	<p>Disable: The certificate from the RADIUS server will be ignored.</p> <p>Enable: The certificate from the RADIUS server will be used to authenticate access to the WLAN. The RADIUS server's trusted server certificate must already be installed on the NPort. To install a trusted server certificate, visit the corresponding page in the System Management > Certificate folder.</p>

Trusted Server Certificate

This field is available for PEAP, TLS, and TTLS EAP methods only. It displays information on the trusted server certificate that is installed on the NPort. To install a trusted server certificate, visit the corresponding page in the **System Management > Certificate** folder.

User Certificate

This field is available only when EAP method has been set to TLS. It displays information on the user certificate that is installed on the NPort. To install a user certificate, visit the corresponding page in the **System Management > Certificate** folder.

User Private Key

This field is available only when EAP method has been set to TLS. It displays information on the user private key on the NPort.

Advanced Settings

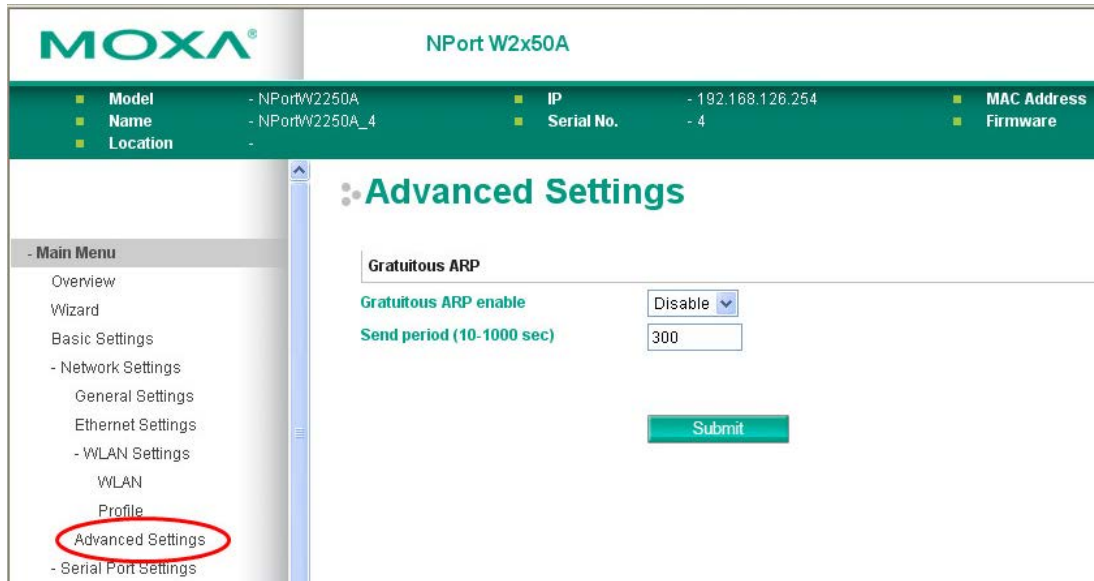

On the **Advanced Settings** page in the **Network Settings** folder, you can modify **Gratuitous ARP**.

Gratuitous ARP

Default	Disabled
Options	Disabled, Enabled, 10 to 1000 sec
Description	<p>This field specifies how often the NPort sends broadcast packets to update the ARP table. This may be required for certain applications.</p> <p>Disabled: The NPort will not send broadcast packets to update the ARP table.</p> <p>Enabled: The NPort will send periodically send broadcast packets at the time interval as specified by Send period.</p>

Web Console: Serial Port Settings

The following topics are covered in this chapter:

▣ **Overview**

- Serial Port Settings
- Communication Parameters
- Data Buffering/Log

Overview

This chapter explains how to configure all settings located under the **Serial Port Settings** folder in the NPort web console.

Serial Port Settings

Operation Modes

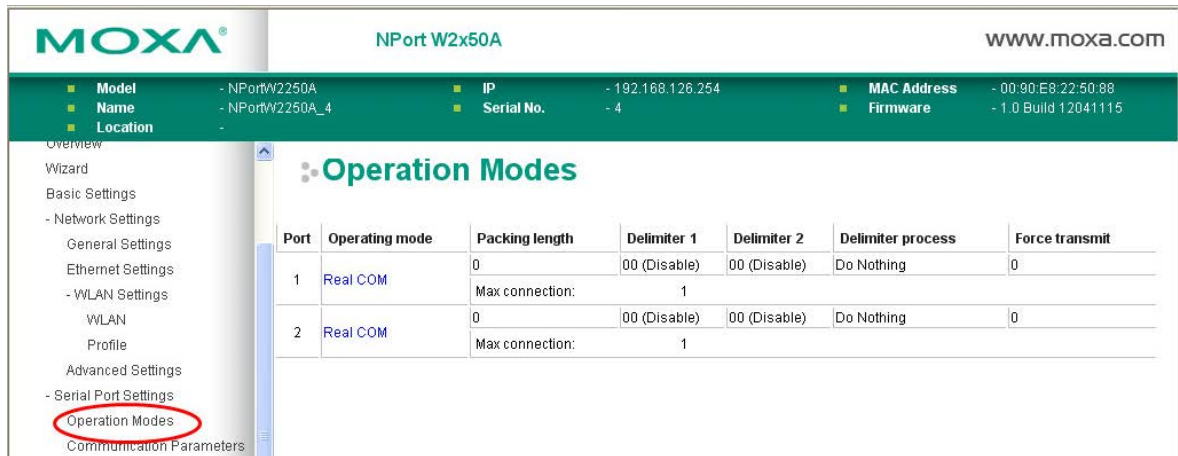

Each serial port on the NPort is configured through the hyperlink below the column of **Operating mode**.

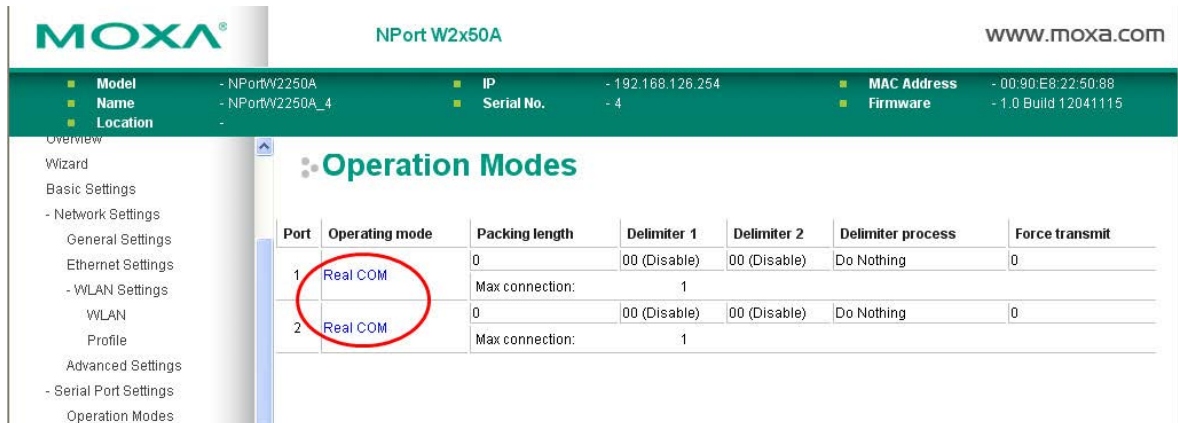

Click the link of **RealCOM**, it will show the Port settings page. The Operation Modes page for each serial port is where you configure the serial port's operation mode and related settings. For an introduction to the different operation modes, please refer to Chapter 4.

NPort W2x50A

■ Model - NPortW2250A	■ IP - 192.168.126.254	■ MAC Address
■ Name - NPortW2250A_4	■ Serial No. - 4	■ Firmware
■ Location -		

Operation Modes

Port Settings

Port 1

Operation mode Real COM

TCP alive check time (0 - 99 min)

Max connection 1

Ignore jammed IP Disable

Allow driver control Disable

Connection goes down RTS always low always high
 DTR always low always high

Data Packing

Packet length (0 - 1024)

Delimiter 1 (HEX) Enable

Delimiter 2 (HEX) Enable

Delimiter process Do Nothing (Processed only when Packing length is 0)

Force transmit (0 - 65535 ms)

Apply the above settings to all serial ports

Submit

goahead
WEB SERVER

Best viewed with IE 5 above at resolution 1024 x 768

Operation Mode

Default	RealCOM
Options	RealCOM, RFC2217, TCP Server, TCP Client, UDP, Pair_Master, Pair_Slave, EModem
Description	<p>Along with Application, this field specifies the serial port's operation mode, or how it will interact with network devices. Depending on how Application is configured, different options are available for Mode. Depending on how Mode is configured, additional settings will be available for configuration. For an introduction to the different operation modes, please refer to Chapter 4.</p> <p>RealCOM: This serial port will operate in RealCOM mode.</p> <p>RFC2217: This serial port will operate in RFC2217 mode.</p> <p>TCP Server: This serial port will operate in TCP Server mode.</p> <p>TCP Client: This serial port will operate in TCP Client mode.</p> <p>UDP: This serial port will operate in UDP mode.</p> <p>Pair_Master: This serial port will operate in Pair Connection Master mode.</p> <p>Pair_Slave: This serial port will operate in Pair Connection Slave mode.</p> <p>EModem: This serial port will operate in Ethernet Modem mode.</p>

Settings for RealCOM Mode

MOXA NPort W2x50A

- Model: - NPortW2250A
- Name: - NPortW2250A_4
- Location: -
- IP: - 192.168.126.254
- Serial No.: - 4
- MAC Address
- Firmware

Operation Modes

Port Settings

Port: 1

Operation mode: **Real COM**

TCP alive check time: 7 (0 - 99 min)

Max connection: 1

Ignore jammed IP: Disable

Allow driver control: Disable

Connection goes down: RTS always low always high
DTR always low always high

Data Packing

Packet length: 0 (0 - 1024)

Delimiter 1: 00 (HEX) Enable

Delimiter 2: 00 (HEX) Enable

Delimiter process: Do Nothing (Processed only when Packing length is 0)

Force transmit: 0 (0 - 65535 ms)

Apply the above settings to all serial ports

Submit

When **Operation Mode** is set to RealCOM on a serial port's **Operation Modes** page, you will be able to configure additional settings including **TCP alive check time**, **Max connection**, **Ignore jammed IP**, **Allow driver Control**, **Connection goes down**, **Packet length**, **Delimiter 1**, **Delimiter 2**, **Delimiter process**, and **Force transmit**.

TCP Alive Check Time

Default	7 min
Options	0 to 99 min
Description	<p>This field specifies how long the NPort will wait for a response to “keep alive” packets before closing the TCP connection. The NPort checks connection status by sending periodic “keep alive” packets.</p> <p>0: The TCP connection will remain open even if there is no response to the “keep alive” packets.</p> <p>1 to 99: If the remote host does not respond to the packet within the specified time, the NPort will force the existing TCP connection to close.</p>

Max connection

Default	1
Options	1 to 8
Description	<p>This field specifies the maximum number of connections that will be accepted by the serial port.</p> <p>1: Only one specific host can access this serial port, and the RealCOM driver on that host will have full control over the port.</p> <p>2 to 8: This serial port will allow the specified number of connections to be opened simultaneously. With simultaneous connections, the RealCOM driver will only provide a pure data tunnel with no control ability. The serial communication will be determined by the NPort rather than by your application program. Application software that is based on the RealCOM driver will receive a driver response of "success" when using any of the Win32 API functions. The NPort will send data only to the RealCOM driver on the host. Data received from hosts will be sent to the attached serial device on a first-in-first-out basis.</p>

**ATTENTION**

When Max connection is 2 or greater, the serial port's communication settings (i.e., baudrate, parity, data bits, etc.) will be determined by the NPort. Any host that opens the COM port connection must use identical serial communication settings.

Ignore jammed IP

Default	Disable
Options	Disable, Enable
Description	<p>This field specifies how an unresponsive IP address is handled when there are simultaneous connections to the serial port.</p> <p>Disable: All transmission will be suspended if one IP address becomes unresponsive. Transmission will only resume when all hosts have responded.</p> <p>Enable: Data transmission to the other hosts will not be suspended if one IP address becomes unresponsive.</p>

Allow driver control

Default	Disable
Options	Disable, Enable
Description	<p>This field specifies how the port will proceed if driver control commands are received from multiple hosts that are connected to the port.</p> <p>Disable: Driver control commands will be ignored.</p> <p>Enable: Control commands will be accepted, with the most recent command received taking precedence.</p>

Connection goes down

Default	always high
Options	always low, always high
Description	<p>This field specifies what happens to the RTS and DTR signals when the Ethernet connection goes down. For some applications, serial devices need to know the Ethernet link status through RTS or DTR signals sent through the serial port.</p> <p>Always low: The selected signal will change to low when the Ethernet connection goes down.</p> <p>Always high The selected signal will remain high when the Ethernet connection goes down.</p>

Packet length

Default	0
Options	0 to 1024
Description	<p>This field specifies the maximum amount of data that is allowed to accumulate in the serial port buffer before sending.</p> <p>0: Packet length is disregarded and data in the buffer will be sent as specified by the delimiter settings or when the buffer is full.</p> <p>1 to 1024: Data in the buffer will be sent as soon it reaches the specified length.</p>

Delimiter 1 and 2

Default	Disabled
Options	Disabled, Enabled, 00 to FF
Description	<p>These fields are used to define special delimiter character(s) for data packing. Enable Delimiter 1 to control data packing with a single character; enable both Delimiter 1 and 2 to control data packing with two characters received in sequence.</p> <p>When these fields are enabled, serial data will accumulate in the serial port's buffer until the buffer is full or until the specified delimiter character(s) are received. For example, the carriage return character could be used as a delimiter in order to transmit each sentence or paragraph in a separate packet. Data will be packed according to Delimiter process.</p> <p>Delimiters must be incorporated into the data stream at the software or device level.</p>

**ATTENTION**

When **Delimiter 1** is enabled, **Packet length** must be set to 0.

Delimiter process

Default	Do Nothing
Options	Do Nothing, Delimiter + 1, Delimiter + 2, Strip Delimiter
Description	<p>This field specifies how data is packed when delimiter characters are received. This field has no effect if Delimiter 1 is not enabled.</p> <p>Do nothing: Data accumulated in the serial port's buffer will be packed, including delimiters.</p> <p>Delimiter + 1: One additional character must be received before the data in the serial port's buffer is packed.</p> <p>Delimiter + 2: Two additional characters must be received before the data in the serial port's buffer is packed.</p> <p>Strip Delimiter: Data accumulated in the serial port's buffer will be packed, but the delimiter character(s) will be stripped from the data.</p>

Force transmit

Default	0 ms
Options	0 to 65535
Description	<p>This field controls data packing by the amount of time that elapses between bits of data. When using this field, make sure that Inactivity time is disabled or set to a larger value. Otherwise the connection may be closed before the data in the buffer can be transmitted.</p> <p>0: If serial data is not received, the NPort will wait indefinitely for additional data.</p> <p>1 to 65535: If serial data is not received for the specified amount of time, the data that is currently in the buffer will be packed for network transmission. The optimal force transmit time depends on your application, but it must be at least larger than one character interval within the specified baudrate. For example, assume that the serial port is set to 1200 bps, 8 data bits, 1 stop bit, and no parity. In this case, the total number of bits needed to send a character is 10 bits, and the time required to transfer one character is 8.3 ms, so the force transmit time to be larger than 8.3 ms.</p>

Settings for RFC2217 Mode

The screenshot shows the MOXA NPort W2x50A web console interface. At the top, there is a header with the MOXA logo and the device name 'NPort W2x50A'. Below this is a green navigation bar with several menu items: Model, Name, Location, IP, Serial No., MAC Address, and Firmware. The main content area is titled 'Operation Modes' and contains a 'Port Settings' section. The 'Port' is set to '1'. The 'Operation mode' dropdown menu is highlighted with a red circle and is set to 'RFC2217'. Other settings include 'TCP alive check time' set to '7' (0 - 99 min), 'TCP port' set to '4001', 'Data Packing' section with 'Packet length' set to '0' (0 - 1024), 'Delimiter 1' and 'Delimiter 2' both set to '00' (HEX) with 'Enable' checkboxes, 'Delimiter process' set to 'Do Nothing' (Processed only when Packing length is 0), and 'Force transmit' set to '0' (0 - 65535 ms). There is an 'Apply the above settings to all serial ports' checkbox and a 'Submit' button at the bottom right.

When **Operation Mode** is set to **RFC2217** on a serial port's **Operation Modes** page, you will be able to configure additional settings, including **TCP alive check time**, **TCP port**, **Packet length**, **Delimiter 1**, **Delimiter 2**, **Delimiter process**, and **Force transmit**.

TCP alive check time

Default	7 min
Options	0 to 99 min
Description	<p>This field specifies how long the NPort will wait for a response to “keep alive” packets before closing the TCP connection. The NPort checks connection status by sending periodic “keep alive” packets.</p> <p>0: The TCP connection will remain open even if there is no response to the “keep alive” packets.</p> <p>1 to 99: If the remote host does not respond to the packet within the specified time, the NPort will force the existing TCP connection to close.</p>

TCP port

Default	4001
Options	
Description	This field specifies the TCP port number that the serial port will use to listen to connections, and that other devices must use to contact the serial port.

Packet length

Default	0
Options	0 to 1024
Description	<p>This field specifies the maximum amount of data that is allowed to accumulate in the serial port buffer before sending.</p> <p>0: Packet length is disregarded and data in the buffer will be sent as specified by the delimiter settings or when the buffer is full.</p> <p>1 to 1024: Data in the buffer will be sent as soon it reaches the specified length.</p>

Delimiter 1 and 2

Default	Disabled
Options	Disabled, Enabled, 00 to FF
Description	<p>These fields are used to define special delimiter character(s) for data packing. Enable Delimiter 1 to control data packing with a single character; enable both Delimiter 1 and 2 to control data packing with two characters received in sequence.</p> <p>When these fields are enabled, serial data will accumulate in the serial port's buffer until the buffer is full or until the specified delimiter character(s) are received. For example, the carriage return character could be used as a delimiter in order to transmit each sentence or paragraph in a separate packet. Data will be packed according to Delimiter process.</p> <p>Delimiters must be incorporated into the data stream at the software or device level.</p>

Delimiter process

Default	Do Nothing
Options	Do Nothing, Delimiter + 1, Delimiter + 2, Strip Delimiter
Description	<p>This field specifies how data is packed when delimiter characters are received. This field has no effect if Delimiter 1 is not enabled.</p> <p>Do nothing: Data accumulated in the serial port's buffer will be packed, including delimiters.</p> <p>Delimiter + 1: One additional character must be received before the data in the serial port's buffer is packed.</p> <p>Delimiter + 2: Two additional characters must be received before the data in the serial port's buffer is packed.</p> <p>Strip Delimiter: Data accumulated in the serial port's buffer will be packed, but the delimiter character(s) will be stripped from the data.</p>

Force transmit

Default	0 ms
Options	0 to 65535
Description	<p>This field controls data packing by the amount of time that elapses between bits of data. When using this field, make sure that Inactivity time is disabled or set to a larger value. Otherwise the connection may be closed before the data in the buffer can be transmitted.</p> <p>0: If serial data is not received, the NPort will wait indefinitely for additional data.</p> <p>1 to 65535: If serial data is not received for the specified amount of time, the data that is currently in the buffer will be packed for network transmission. The optimal force transmit time depends on your application, but it must be at least larger than one character interval within the specified baudrate. For example, assume that the serial port is set to 1200 bps, 8 data bits, 1 stop bit, and no parity. In this case, the total number of bits needed to send a character is 10 bits, and the time required to transfer one character is 8.3 ms, so the force transmit time to be larger than 8.3 ms.</p>

Settings for TCP Server Mode

The screenshot shows the MOXA NPort W2x50A web console interface. At the top, the model and name are listed as NPortW2250A and NPortW2250A_4. The IP address is 192.168.126.254 and the serial number is 4. The MAC address and firmware are also listed.

The main menu on the left includes: Overview, Wizard, Basic Settings, Network Settings, Serial Port Settings, Operation Modes, Communication Parameters, Data Buffering/Log, System Management, System Monitoring, and Restart.

The 'Operation Modes' section is active, showing 'Port Settings' for port 1. The 'Operation mode' is set to 'TCP Server' (highlighted with a red circle). Other settings include:

- TCP alive check time: 7 (0-99 min)
- Inactivity time: 0 (0-65535 ms)
- Max connection: 1
- Ignore jammed IP: Disable
- Allow driver control: Disable
- TCP port: 4001
- Cmd port: 966
- Connection goes down: RTS (always low), always high; DTR (always low), always high

The 'Data Packing' section includes:

- Packet length: 0 (0-1024)
- Delimiter 1: 00 (HEX), Enable
- Delimiter 2: 00 (HEX), Enable
- Delimiter process: Do Nothing (Processed only when Packing length is 0)
- Force transmit: 0 (0-65535 ms)

 There is a checkbox for 'Apply the above settings to all serial ports' and a 'Submit' button at the bottom.

When **Operation Mode** is set to **TCP Server** on a serial port's **Operation Modes** page, you will be able to configure additional settings such as **TCP alive check time**, **Inactivity time**, **Max connection**, **Ignore jammed IP**, **Allow driver control**, **TCP port**, **Cmd port**, **Connection goes down**, **Packet length**, **Delimiter 1**, **Delimiter 2**, **Delimiter process**, and **Force transmit**.

TCP alive check time

Default	7 min
Options	0 to 99 min
Description	<p>This field specifies how long the NPort will wait for a response to “keep alive” packets before closing the TCP connection. The NPort checks connection status by sending periodic “keep alive” packets.</p> <p>0: The TCP connection will remain open even if there is no response to the “keep alive” packets.</p> <p>1 to 99: If the remote host does not respond to the packet within the specified time, the NPort will force the existing TCP connection to close.</p>

Inactivity time

Default	0 ms
Options	0 to 65535 ms
Description	<p>This field specifies the time limit for keeping the connection open if no data flows to or from the serial device.</p> <p>0: The connection will remain open even if data is never received. For many applications, the serial device may be idle for long periods of time, so 0 is an appropriate setting.</p> <p>1 to 65535: If there is no activity for the specified time, the connection will be closed. When adjusting this field, make sure that it is greater than the Force transmit time. Otherwise, the TCP connection may be closed before data in the buffer can be transmitted.</p>

Max connection

Default	1
Options	1 to 8
Description	<p>This field specifies the maximum number of connections that will be accepted by the serial port.</p> <p>1: Only one specific host can access this serial port, and the RealCOM driver on that host will have full control over the port.</p> <p>2 to 8: This serial port will allow the specified number of connections to be opened simultaneously. With simultaneous connections, the RealCOM driver will only provide a pure data tunnel with no control ability. The serial communication will be determined by the NPort rather than by your application program. Application software that is based on the RealCOM driver will receive a driver response of “success” when using any of the Win32 API functions. The NPort will send data only to the RealCOM driver on the host. Data received from hosts will be sent to the attached serial device on a first-in-first-out basis.</p>

**ATTENTION**

When Max connection is 2 or greater, the serial port’s communication settings (i.e., baudrate, parity, data bits, etc.) will be determined by the NPort. Any host that opens the COM port connection must use identical serial communication settings.

Ignore jammed IP

Default	Disable
Options	Disable, Enable
Description	<p>This field specifies how an unresponsive IP address is handled when there are simultaneous connections to the serial port.</p> <p>Disable: All transmission will be suspended if one IP address becomes unresponsive. Transmission will only resume when all hosts have responded.</p> <p>Enable: Data transmission to the other hosts will not be suspended if one IP address becomes unresponsive.</p>

Allow driver control

Default	Disable
Options	Disable, Enable
Description	<p>This field specifies how the port will proceed if driver control commands are received from multiple hosts that are connected to the port.</p> <p>Disable: Driver control commands will be ignored.</p> <p>Enable: Control commands will be accepted, with the most recent command received taking precedence.</p>

TCP port

Default	4001
Options	0 to 9999
Description	This field specifies the TCP port number that the serial port will use to listen to connections, and that other devices must use to contact the serial port.

Cmd port

Default	996
Options	
Description	This field specifies the TCP port number for listening to SSDK commands from the host.

The usage of other functions can be found in the subsection of **RealCOM** mode in page 7-4.

Connection goes down

Default	always high
Options	always low, always high
Description	<p>This field specifies what happens to the RTS and DTR signals when the Ethernet connection goes down. For some applications, serial devices need to know the Ethernet link status through RTS or DTR signals sent through the serial port.</p> <p>Always low: The selected signal will change to low when the Ethernet connection goes down.</p> <p>Always high: The selected signal will remain high when the Ethernet connection goes down.</p>

Packet length

Default	0
Options	0 to 1024
Description	<p>This field specifies the maximum amount of data that is allowed to accumulate in the serial port buffer before sending.</p> <p>0: Packet length is disregarded and data in the buffer will be sent as specified by the delimiter settings or when the buffer is full.</p> <p>1 to 1024: Data in the buffer will be sent as soon it reaches the specified length.</p>

Delimiter 1 and 2

Default	Disabled
Options	Disabled, Enabled, 00 to FF
Description	<p>These fields are used to define special delimiter character(s) for data packing. Enable Delimiter 1 to control data packing with a single character; enable both Delimiter 1 and 2 to control data packing with two characters received in sequence.</p> <p>When these fields are enabled, serial data will accumulate in the serial port's buffer until the buffer is full or until the specified delimiter character(s) are received. For example, the carriage return character could be used as a delimiter in order to transmit each sentence or paragraph in a separate packet. Data will be packed according to Delimiter process.</p> <p>Delimiters must be incorporated into the data stream at the software or device level.</p>

**ATTENTION**

When **Delimiter 1** is enabled, **Packet length** must be set to 0.

Delimiter process

Default	Do Nothing
Options	Do Nothing, Delimiter + 1, Delimiter + 2, Strip Delimiter
Description	<p>This field specifies how data is packed when delimiter characters are received. This field has no effect if Delimiter 1 is not enabled.</p> <p>Do nothing: Data accumulated in the serial port's buffer will be packed, including delimiters.</p> <p>Delimiter + 1: One additional character must be received before the data in the serial port's buffer is packed.</p> <p>Delimiter + 2: Two additional characters must be received before the data in the serial port's buffer is packed.</p> <p>Strip Delimiter: Data accumulated in the serial port's buffer will be packed, but the delimiter character(s) will be stripped from the data.</p>

Force transmit

Default	0 ms
Options	0 to 65535
Description	<p>This field controls data packing by the amount of time that elapses between bits of data. When using this field, make sure that Inactivity time is disabled or set to a larger value. Otherwise the connection may be closed before the data in the buffer can be transmitted.</p> <p>0: If serial data is not received, the NPort will wait indefinitely for additional data.</p> <p>1 to 65535: If serial data is not received for the specified amount of time, the data that is currently in the buffer will be packed for network transmission. The optimal force transmit time depends on your application, but it must be at least larger than one character interval within the specified baudrate. For example, assume that the serial port is set to 1200 bps, 8 data bits, 1 stop bit, and no parity. In this case, the total number of bits needed to send a character is 10 bits, and the time required to transfer one character is 8.3 ms, so the force transmit time to be larger than 8.3 ms.</p>

Settings for TCP Client Mode

The screenshot shows the MOXA NPort W2x50A web console interface. At the top, the model is identified as NPortW2250A with IP 192.168.128.254 and MAC address 00:90:E8:22:50. The left sidebar contains a 'Main Menu' with options like Overview, Wizard, Basic Settings, Network Settings, Serial Port Settings, Operation Modes, Communication Parameters, Data Buffering/Log, System Management, System Monitoring, and Restart. The 'Serial Port Settings' page is active, showing 'Port Settings' for Port 1. The 'Operation mode' dropdown is highlighted with a red circle and set to 'TCP Client'. Below it, various settings are visible: 'TCP alive check time' (7 min), 'Inactivity time' (0 ms), 'Ignore jammed IP' (Disable), 'Destination address 1-4' (all 4001), 'Designated local port 1-4' (5010-5013), 'Connection control' (Startup/None), 'Data Packing' section with 'Packet length' (0), 'Delimiter 1 & 2' (00), 'Delimiter process' (Do Nothing), and 'Force transmit' (0 ms). A 'Submit' button is located at the bottom of the settings area.

When **Operation Mode** is set to **TCP Client** on a serial port's **Operation Modes** page, you will be able to configure additional settings such as **TCP alive check time**, **Inactivity time**, **Ignore jammed IP**, **Destination address 1-4**, **Designated local port 1-4**, **Connection control**, and **Packet length**, **Delimiter 1**, **Delimiter 2**, **Delimiter process**, and **Force transmit**.

TCP Alive Check Time

Default	7 min
Options	0 to 99 min
Description	<p>This field specifies how long the NPort will wait for a response to “keep alive” packets before closing the TCP connection. The NPort checks connection status by sending periodic “keep alive” packets.</p> <p>0: The TCP connection will remain open even if there is no response to the “keep alive” packets.</p> <p>1 to 99: If the remote host does not respond to the packet within the specified time, the NPort will force the existing TCP connection to close.</p>

Inactivity time

Default	0 ms
Options	0 to 65535 ms
Description	<p>This field specifies the time limit for keeping the connection open if no data flows to or from the serial device.</p> <p>0: The connection will remain open even if data is never received. For many applications, the serial device may be idle for long periods of time, so 0 is an appropriate setting.</p> <p>1 to 65535: If there is no activity for the specified time, the connection will be closed. When adjusting this field, make sure that it is greater than the Force transmit time. Otherwise, the TCP connection may be closed before data in the buffer can be transmitted.</p>

Ignore jammed IP

Default	Disable
Options	Disable, Enable
Description	<p>This field specifies how an unresponsive IP address is handled when there are simultaneous connections to the serial port.</p> <p>Disable: All transmission will be suspended if one IP address becomes unresponsive. Transmission will only resume when all hosts have responded.</p> <p>Enable: Data transmission to the other hosts will not be suspended if one IP address becomes unresponsive.</p>

Destination address 1 to 4

Default	
Options	IP address and port (e.g., “192.168.1.1” and “4001”)
Description	This field specifies the remote host(s) that will access the attached device. At least one destination must be provided. This field supports the use of domain names and names defined in the host table.

**ATTENTION**

In TCP Client mode, up to 4 connections can be established between the serial port and TCP hosts. The connection speed or throughput may be low if any one of the four connections is slow, since the one slow connection will slow down the other 3 connections.

Designated local port 1 to 4

Default	
Options	1 to 65535
Description	This field specifies the TCP port number that will be used for data transmission with the serial port.

Connection control

Default	Startup/None
Options	Startup/None, Any Character/None, Any Character/Inactivity Time, DSR On/DSR Off, DSR On/None, DCD On/DCD Off, DCD On/None
Description	<p>This field specifies how connections to the device are established and closed.</p> <p>Startup/None: The connection will be opened as the NPort starts up. The connection will only be closed manually.</p> <p>Any Character/None: The connection will be opened as soon as a character is received from the attached device. The connection will only be closed manually.</p> <p>Any Character/Inactivity Time: The connection will be opened as soon as a character is received from the attached device. The connection will be closed if no data is received for the time specified in Inactivity time.</p> <p>DSR On/DSR Off: The TCP connection is opened when the DSR signal is on, and closed when the DSR signal is off.</p> <p>DSR On/None: The TCP connection is opened when the DSR signal is on. The connection will only be closed manually.</p> <p>DCD On/DCD Off: The TCP connection is opened when the DCD signal is on, and closed when the DCD signal is off.</p> <p>DCD On/None: The TCP connection is opened when the DCD signal is on. The connection will only be closed manually.</p>

Packet length

Default	0
Options	0 to 1024
Description	<p>This field specifies the maximum amount of data that is allowed to accumulate in the serial port buffer before sending.</p> <p>0: Packet length is disregarded and data in the buffer will be sent as specified by the delimiter settings or when the buffer is full.</p> <p>1 to 1024: Data in the buffer will be sent as soon it reaches the specified length.</p>

Delimiter 1 and 2

Default	Disabled
Options	Disabled, Enabled, 00 to FF
Description	<p>These fields are used to define special delimiter character(s) for data packing. Enable Delimiter 1 to control data packing with a single character; enable both Delimiter 1 and 2 to control data packing with two characters received in sequence.</p> <p>When these fields are enabled, serial data will accumulate in the serial port's buffer until the buffer is full or until the specified delimiter character(s) are received. For example, the carriage return character could be used as a delimiter in order to transmit each sentence or paragraph in a separate packet. Data will be packed according to Delimiter process.</p> <p>Delimiters must be incorporated into the data stream at the software or device level.</p>

**ATTENTION**

When **Delimiter 1** is enabled, **Packet length** must be set to 0.

Delimiter process

Default	Do Nothing
Options	Do Nothing, Delimiter + 1, Delimiter + 2, Strip Delimiter
Description	<p>This field specifies how data is packed when delimiter characters are received. This field has no effect if Delimiter 1 is not enabled.</p> <p>Do nothing: Data accumulated in the serial port's buffer will be packed, including delimiters.</p> <p>Delimiter + 1: One additional character must be received before the data in the serial port's buffer is packed.</p> <p>Delimiter + 2: Two additional characters must be received before the data in the serial port's buffer is packed.</p> <p>Strip Delimiter: Data accumulated in the serial port's buffer will be packed, but the delimiter character(s) will be stripped from the data.</p>

Force transmit

Default	0 ms
Options	0 to 65535
Description	<p>This field controls data packing by the amount of time that elapses between bits of data. When using this field, make sure that Inactivity time is disabled or set to a larger value. Otherwise the connection may be closed before the data in the buffer can be transmitted.</p> <p>0: If serial data is not received, the NPort will wait indefinitely for additional data.</p> <p>1 to 65535: If serial data is not received for the specified amount of time, the data that is currently in the buffer will be packed for network transmission. The optimal force transmit time depends on your application, but it must be at least larger than one character interval within the specified baudrate. For example, assume that the serial port is set to 1200 bps, 8 data bits, 1 stop bit, and no parity. In this case, the total number of bits needed to send a character is 10 bits, and the time required to transfer one character is 8.3 ms, so the force transmit time to be larger than 8.3 ms.</p>

Settings for UDP Mode

The screenshot shows the Moxa NPort W2x50A Web Console interface. At the top, there is a header with the Moxa logo and the device model. Below the header, a status bar displays key information: Model (NPortW2250A), Name (NPortW2250A_4), Location, IP (192.168.126.254), Serial No. (4), MAC Address (00:90:E8:22), and Firmware (1.0 Build 12). The main content area is titled 'Operation Modes' and contains a 'Port Settings' section for port 1. The 'Operation mode' dropdown menu is highlighted with a red circle and is set to 'UDP'. Below this, there are four 'Destination address' fields (1-4), each with 'Begin', 'End', and 'Port' sub-fields. The 'Local listen port' is set to 4001. The 'Data Packing' section includes 'Packet length' (0), 'Delimiter 1' and '2' (00 (HEX) with 'Enable' checkboxes), 'Delimiter process' (Do Nothing), and 'Force transmit' (0). A checkbox at the bottom allows applying these settings to all serial ports.

When **Operation Mode** is set to **UDP** on a serial port's **Operation Modes** page, you will be able to configure additional settings such as **Destination address 1** through **4**, **Local listen port**, **Packet length**, **Delimiter 1**, **Delimiter 2**, **Delimiter process**, and **Force transmit**.

Destination address 1 to 4

Default	
Options	IP address range and port (e.g., "192.168.1.1" to "192.168.1.64" and "4001")
Description	In UDP mode, you may specify up to 4 ranges of IP addresses for the serial port to connect to. At least one destination range must be provided. The maximum selectable IP address range is 64 addresses. However, you can enter multicast addresses in the Begin field, in the form xxx.xxx.xxx.255. For example, enter "192.127.168.255" to allow the NPort to broadcast UDP packets to all hosts with IP addresses between 192.127.168.1 and 192.127.168.254.

Local listen port

Default	4001
Options	
Description	This field specifies the UDP port that the NPort listens to and that other devices must use to contact the attached serial device.

Packet length

Default	0
Options	0 to 1024
Description	This field specifies the maximum amount of data that is allowed to accumulate in the serial port buffer before sending. 0: Packet length is disregarded and data in the buffer will be sent as specified by the delimiter settings or when the buffer is full. 1 to 1024: Data in the buffer will be sent as soon it reaches the specified length.

Delimiter 1 and 2

Default	Disabled
Options	Disabled, Enabled, 00 to FF
Description	<p>These fields are used to define special delimiter character(s) for data packing. Enable Delimiter 1 to control data packing with a single character; enable both Delimiter 1 and 2 to control data packing with two characters received in sequence.</p> <p>When these fields are enabled, serial data will accumulate in the serial port's buffer until the buffer is full or until the specified delimiter character(s) are received. For example, the carriage return character could be used as a delimiter in order to transmit each sentence or paragraph in a separate packet. Data will be packed according to Delimiter process.</p> <p>Delimiters must be incorporated into the data stream at the software or device level.</p>

**ATTENTION**

When **Delimiter 1** is enabled, **Packet length** must be set to 0.

Delimiter process

Default	Do Nothing
Options	Do Nothing, Delimiter + 1, Delimiter + 2, Strip Delimiter
Description	<p>This field specifies how data is packed when delimiter characters are received. This field has no effect if Delimiter 1 is not enabled.</p> <p>Do nothing: Data accumulated in the serial port's buffer will be packed, including delimiters.</p> <p>Delimiter + 1: One additional character must be received before the data in the serial port's buffer is packed.</p> <p>Delimiter + 2: Two additional characters must be received before the data in the serial port's buffer is packed.</p> <p>Strip Delimiter: Data accumulated in the serial port's buffer will be packed, but the delimiter character(s) will be stripped from the data.</p>

Force transmit

Default	0 ms
Options	0 to 65535
Description	<p>This field controls data packing by the amount of time that elapses between bits of data. When using this field, make sure that Inactivity time is disabled or set to a larger value. Otherwise the connection may be closed before the data in the buffer can be transmitted.</p> <p>0: If serial data is not received, the NPort will wait indefinitely for additional data.</p> <p>1 to 65535: If serial data is not received for the specified amount of time, the data that is currently in the buffer will be packed for network transmission. The optimal force transmit time depends on your application, but it must be at least larger than one character interval within the specified baudrate. For example, assume that the serial port is set to 1200 bps, 8 data bits, 1 stop bit, and no parity. In this case, the total number of bits needed to send a character is 10 bits, and the time required to transfer one character is 8.3 ms, so the force transmit time to be larger than 8.3 ms.</p>

Settings for Pair Connection Master Mode and Pair Connection Slave Mode

The screenshot shows the MOXA NPort W2x50A web console interface. At the top, the MOXA logo is on the left, 'NPort W2x50A' is in the center, and 'www.mox' is on the right. Below this is a status bar with fields for Model, Name, Location, IP, Serial No., MAC Address, and Firmware. The 'Operation Modes' section is active, showing 'Port Settings' for Port 1. The 'Operation mode' dropdown is set to 'Pair_Master'. The 'TCP alive check time' is set to 7 minutes. The 'Destination address' field is empty, with a 'Port' dropdown set to 4001. A 'Submit' button is at the bottom right. A 'Main Menu' sidebar is on the left, and a 'goahead' logo is at the bottom left.

The screenshot shows the MOXA NPort W2x50A web console interface, similar to the previous one. The 'Operation mode' dropdown is now set to 'Pair_Slave'. The 'TCP port' field is set to 4001. The 'Submit' button is at the bottom right. The rest of the interface, including the status bar, sidebar, and logos, remains the same.

When **Operation Mode** is set to **Pair Connection Master** or **Pair Connection Slave** on a serial port's **Operation Modes** page, you will be able to configure additional settings such as **TCP alive check time**, **Destination address** and **TCP port**. A Pair Connection application involves one serial port communicating over an IP network to another serial port as if the two serial ports were connected by a serial cable. Pair Connection modes can be used to extend RS-232 transmission to unlimited distances.

An NPort device server is needed at both ends of the connection. The serial port at one end must be set to Pair Connection Master mode, and the serial port at the other end must be set to Pair Connection Slave mode. It does not matter which serial port is master and which serial port is slave.

TCP alive check time

Default	7 min
Options	0 to 99 min
Description	<p>This field specifies how long the NPort will wait for a response to “keep alive” packets before closing the TCP connection. The NPort checks connection status by sending periodic “keep alive” packets.</p> <p>0: The TCP connection will remain open even if there is no response to the “keep alive” packets.</p> <p>1 to 99: If the remote host does not respond to the packet within the specified time, the NPort will force the existing TCP connection to close.</p>

Destination address

Default	
Options	IP address and port (e.g., “192.168.1.1” and “4001”)
Description	This field specifies the IP address for the NPort at the opposite end of the Pair Connection, and the TCP port number for communication with the serial port. The port number must match with that serial port’s TCP port setting.

TCP port

Default	4001
Options	
Description	This field specifies the TCP port to use for communication with the attached serial device. The serial port at the opposite end of the Pair Connection must use this port number to establish the connection.

Settings for Ethernet Modem Mode

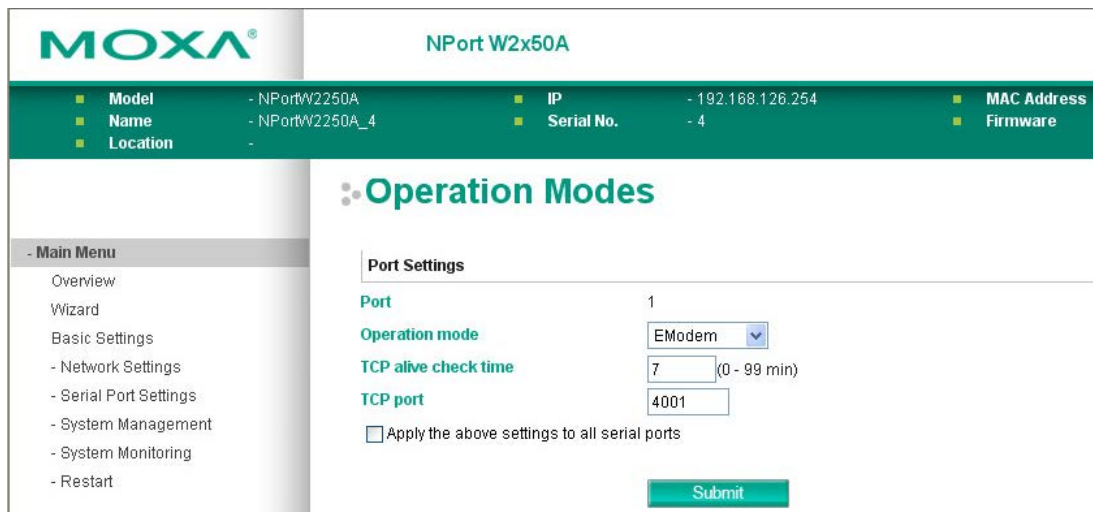

When **Application** is set to **Ethernet Modem Mode**, the NPort will accept AT commands such as “ATD 192.127.168.1:4001” from the serial port. A TCP connection will then be requested from the specified remote Ethernet Modem or PC. When the remote unit accepts this TCP connection, the NPort will return the “**CONNECT {baudrate}**” signal to the serial port and will then enter data mode. Please refer to Appendix C for details on Ethernet modem commands.

TCP alive check time

Default	7 min
Options	0 to 99 min
Description	<p>This field specifies how long the NPort will wait for a response to “keep alive” packets before closing the TCP connection. The NPort checks connection status by sending periodic “keep alive” packets.</p> <p>0: The TCP connection will remain open even if there is no response to the “keep alive” packets.</p> <p>1 to 99: If the remote host does not respond to the packet within the specified time, the NPort will force the existing TCP connection to close.</p>

TCP port

Default	4001
Options	
Description	This field specifies the TCP port to use for communication with the attached serial device.

Communication Parameters

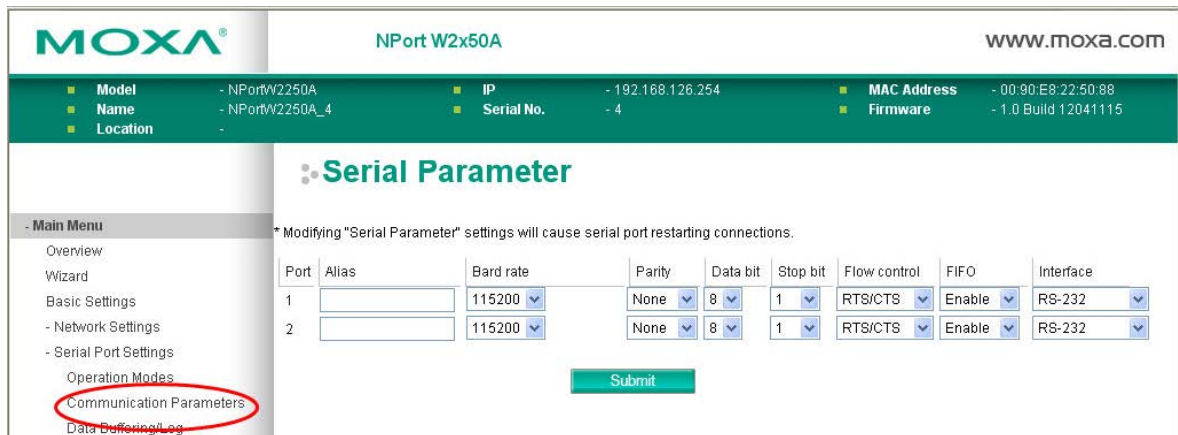

The **Communication Parameters** page for each serial port is where serial communication settings are specified, such as **Baud rate**, **Data bits**, and **Stop bits**.

Alias

Default	
Options	free text (e.g., “Secondary console connection”)
Description	This is an optional free text field to help you differentiate one serial port from another. It does not affect operation of the NPort device server.



ATTENTION

Serial communication settings should match the attached serial device. Check the communication settings in the user’s manual for your serial device.

Baud rate

Default	115200
Options	50, 75, 110, 134, 150, 300, 600, 1200, 1800, 2400, 4800, 9600, 19200, 38400, 57600, 115200, 230400, 460800, 921600, Other
Description	<p>This field specifies the baudrate for the serial port. Nonstandard baudrates are supported through the "Other" setting. When set to "Other", you may manually enter a baudrate of your choice, up to 921600.</p> <p>50 to 921600: The serial port will operate at the specified baudrate</p> <p>Other: The serial port will operate at a baudrate that is manually entered by the user.</p>

Parity

Default	None
Options	None, Odd, Even, Space, Mark
Description	This field specifies the type of parity bit used for each character frame.

Data bit

Default	8
Options	5, 6, 7, 8
Description	This field specifies the number of data bits used to encode each character of data.

Stop bit

Default	1
Options	1, 1.5, 2
Description	This field specifies the number of stop bits used for each character frame.

Flow control

Default	RTS/CTS
Options	None, RTS/CTS, XON/XOFF, DTR/DSR
Description	This field specifies the type of flow control used by the serial port.

FIFO

Default	Enable
Options	Enable, Disable
Description	This field specifies whether the serial port will use the built-in FIFO. A 128-byte FIFO is provided to each serial port for both Tx and Rx directions. To prevent data loss during serial communication, this should be set to Disabled if the attached serial device does not have a FIFO.

Interface

Default	RS-232
Options	RS-232, RS-422, RS-485 2-wire, RS-485 4-wire
Description	This field specifies the type of interface the serial port will use.

Data Buffering/Log

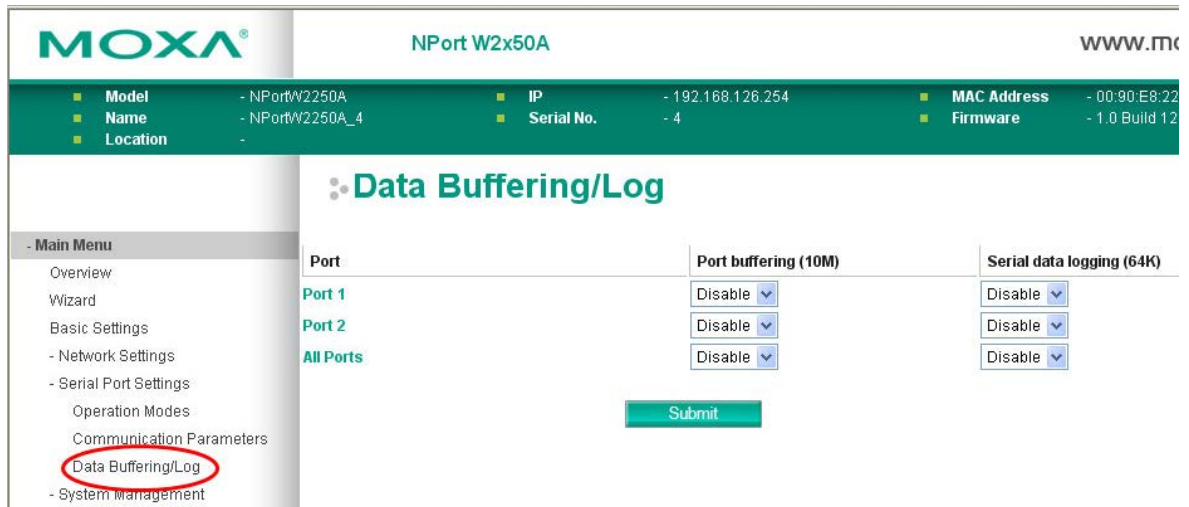

On the serial port's **Data Buffering/Log** page, you can enable or disable **Port buffering** and **Serial data logging**.

Port buffering

Default	Disable
Options	Enable, Disable
Description	This field specifies whether the serial port will use port buffering when the network connection (Ethernet or WLAN) is down. Port buffering can be used in RealCOM mode, TCP Server mode, TCP Client mode, and Pair Connection mode. For other modes, the port buffering settings will have no effect.

Serial data logging(64K)

Default	Disable
Options	Enable, Disable
Description	This field specifies whether data logs for the serial port will be stored on system RAM. Each serial port is allotted 64 KB for data logging. The data log is not saved when the NPort is powered off.

Web Console: System Management

The following topics are covered in this chapter:

- **Overview**

- **System Management**

- Misc. Network Settings
- Auto Warning Settings
- Maintenance
- Maintenance
- Certificate

Overview

This chapter explains how to configure all settings located under the **System Management** folder in the NPort web console.

System Management

Misc. Network Settings

Accessible IP List

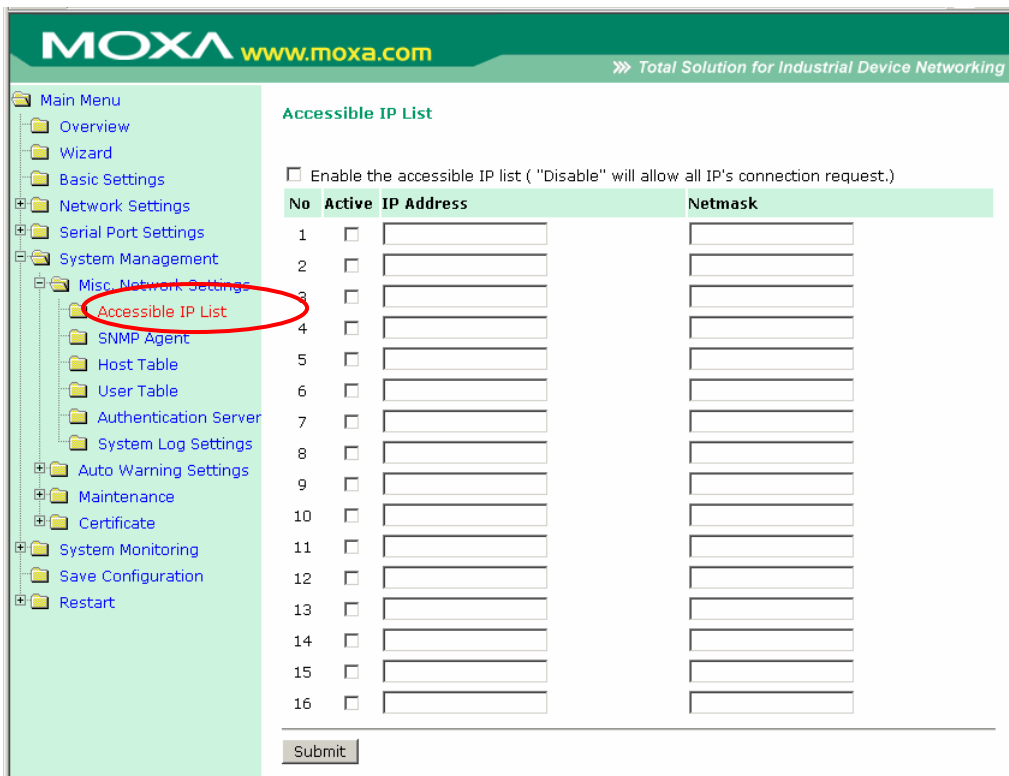

The **Accessible IP List** page is located under **Misc. Network Settings** in the **System Management** folder. This page is used to restrict access to the NPort by IP address. Only IP addresses on the list will be allowed access to the NPort. You may add a specific address or range of addresses by using a combination of IP address and netmask, as follows:

To allow access to a specific IP address

Enter the IP address in the corresponding field; enter 255.255.255.255 for the netmask.

To allow access to hosts on a specific subnet

For both the IP address and netmask, use 0 for the last digit (e.g., "192.168.1.0" and "255.255.255.0").

To allow access to all IP addresses

Make sure that **Enable the accessible IP list** is not checked.

Refer to the following table for more configuration examples.

Desired IP Range	IP Address Field	Netmask Field
Any host	Disable	Disable
192.168.1.120	192.168.1.120	255.255.255.255
192.168.1.1 to 192.168.1.254	192.168.1.0	255.255.255.0
192.168.0.1 to 192.168.255.254	192.168.0.0	255.255.0.0
192.168.1.1 to 192.168.1.126	192.168.1.0	255.255.255.128
192.168.1.129 to 192.168.1.254	192.168.1.128	255.255.255.128

SNMP Agent Settings

The screenshot shows the Moxa NPort W2x50A web console interface. At the top, there is a header with the Moxa logo and the device model. Below the header is a configuration table with the following data:

Model	- NPortW2250A	IP	- 192.168.126.254	MAC Address	
Name	- NPortW2250A_4	Serial No.	- 4	Firmware	
Location	-				

The main content area is titled "SNMP Agent Settings" and contains a "Configuration" section. The configuration options are as follows:

- SNMP:** Enable (dropdown menu)
- Contact name:** (text input field)
- Location:** (text input field)
- Read community string:** public (text input field)
- Write community string:** private (text input field)
- SNMP agent version:** V1, V2c, V3 (dropdown menu)
- Read only user name:** rouser (text input field)
- Read only authentication mode:** Disable (dropdown menu)
- Read only password:** (text input field)
- Read only privacy mode:** Disable (dropdown menu)
- Read only privacy:** (text input field)
- Read/write user name:** rwuser (text input field)
- Read/write authentication mode:** Disable (dropdown menu)
- Read/write password:** (text input field)
- Read/write privacy mode:** Disable (dropdown menu)
- Read/write privacy:** (text input field)

A "Submit" button is located at the bottom right of the configuration form. On the left side, there is a "Main Menu" with various navigation options, including "SNMP Agent" which is circled in red. At the bottom left, there is a "goahead WEB SERVER" logo and a note: "Best viewed with IE 5 above at resolution 1024 x 768".

The **SNMP Agent** page is located under **Misc. Network Settings** in the **System Management** folder. This page is used to configure the SNMP Agent on the NPort.

SNMP

Default	Enable
Options	Enable, Disable
Description	This field enables or disables the SNMP Agent. If enabled, you will need to configure other SNMP Agent settings. You will need to enter a community name under Read community string.

Contact Name

Default	
Options	free text (e.g., "J Smith")
Description	This is an optional free text field that can be used to specify the SNMP emergency contact name, telephone, or pager number.

Location

Default	
Options	free text (e.g., "Building XYZ")
Description	This is an optional free text field that can be used to specify the location for SNMP agents such as the NPort.

Read Community String

Default	public
Options	free text (e.g., "public community")
Description	This field specifies the read community string used for the SNMP Agent. This is a text password mechanism that is used to weakly authenticate queries to agents of managed network devices.

Write Community String

Default	private
Options	free text (e.g., "private community")
Description	This field specifies the write community string used for the SNMP Agent. This is a text password mechanism that is used to weakly authenticate changes to agents of managed network devices.

SNMP Agent Version

Default	V1, V2c, V3
Options	V1, V2c, V3 / V1, V2c / V3 only
Description	This field specifies which version(s) of SNMP to support.

Read Only User Name

Default	rouser
Options	free text (e.g., "guest")
Description	This field specifies a user name to use for read only access.

Read Only Authentication Mode

Default	Disable
Options	Disable, MD5, SHA
Description	This field specifies the type of authentication to use for read-only access.

Read Only Password

Default	
Options	free text (e.g., "password123")
Description	This field specifies the password that users must enter for read-only access, if read only authentication is enabled.

Read Only Privacy mode

Default	Disable
Options	Disable, DES_CBC
Description	This field specifies whether DES_CBC data encryption will be used during read-only access.

Read Only Privacy

Default	
Options	free text (e.g., "read only key")
Description	This field specifies the encryption key for read-only access, if read-only privacy is enabled.

Read/Write User Name

Default	rwuser
Options	free text (e.g., "admin")
Description	This field specifies a user name to use for read/write access.

Read/Write Authentication Mode

Default	Disable
Options	Disable, MD5, SHA
Description	This field specifies the type of authentication to use for read/write access.

Read/Write Password

Default	
Options	free text (e.g., "password123")
Description	This field specifies the password that users must enter for read/write access, if read only authentication is enabled.

Read/Write Privacy mode

Default	Disable
Options	Disable, DES_CBC
Description	This field specifies whether DES_CBC data encryption will be used during read/write access.

Read/Write Privacy

Default	
Options	free text (e.g., "read write key")
Description	This field specifies the encryption key for read/write access, if read-/write privacy is enabled.

System Log Settings

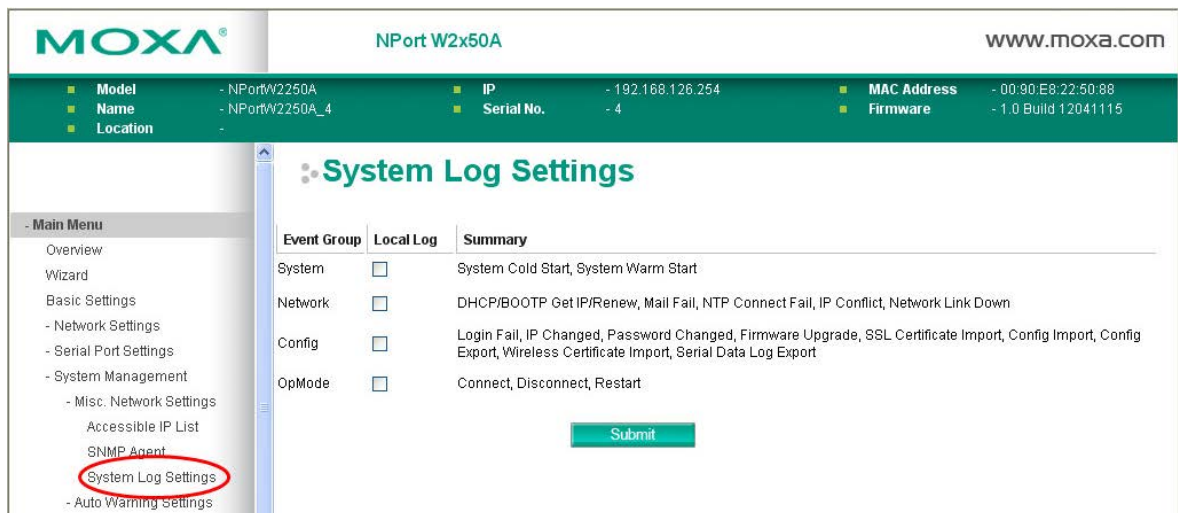

The **System Log** page is located under **Misc. Network Settings** in the **System Management** folder. This is where you select the type of events that will be logged by the NPort.

Group	Event
System	System Cold Start, System Warm Start
Network	DHCP/BOOTP, Get IP/Renew, Mail Fail, NTP Connect Fail, IP Conflict, Network Link Down
Config	Login Fail, IP Changed, Password Changed, Firmware Upgrade, SSL Certificate Import, Config Import, Config Export, Wireless Certificate Import, Serial Data Log Export
Op Mode	Connect, Disconnect, Restart

Auto Warning Settings

Event Settings

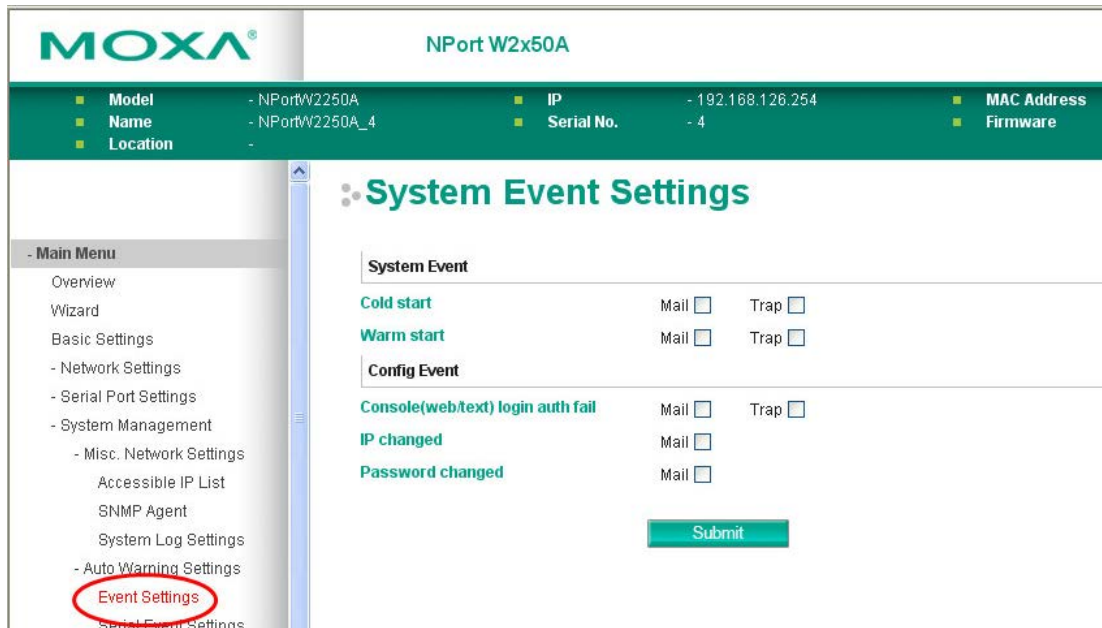

The **Event Settings** page is located under **Auto Warning Settings** in the **System Management** folder. This is where you specify how the NPort will notify you of system and configuration events. Depending on the event, different options for notification are available, as shown above. **Mail** refers to sending an e-mail to a specified address. **Trap** refers to sending an SNMP trap.

Event	Description
Cold start	The NPort was powered on, or was restarted after a firmware upgrade.
Warm start	The NPort restarted without powering off.
Console login auth fail	An attempt has been made to open the web, Telnet, or serial console, but the password was incorrect.
IP changed	The IP address has been changed.
Password changed	The password to the console has been changed.

Serial Event Settings

The screenshot shows the MOXA NPort W2x50A web console interface. At the top, there is a status bar with the following information:

- Model: NPortW2250A
- Name: NPortW2250A_4
- Location: -
- IP: 192.168.126.254
- Serial No.: - 4
- MAC Address: - 00:90:E8:22:50:88
- Firmware: - 1.0 Build 120411

The main content area is titled "Serial Event Settings". It features a table with the following structure:

Serial Port Event	DCD changed		DSR changed	
Port 1	Mail <input type="checkbox"/>	Trap <input type="checkbox"/>	Mail <input type="checkbox"/>	Trap <input type="checkbox"/>
Port 2	Mail <input type="checkbox"/>	Trap <input type="checkbox"/>	Mail <input type="checkbox"/>	Trap <input type="checkbox"/>
All Ports	Mail <input type="checkbox"/>	Trap <input type="checkbox"/>	Mail <input type="checkbox"/>	Trap <input type="checkbox"/>

Below the table is a "Submit" button. On the left side, there is a "Main Menu" with the following items:

- Overview
- Wizard
- Basic Settings
- Network Settings
- Serial Port Settings
- System Management
 - Misc. Network Settings
 - Accessible IP List
 - SNMP Agent
 - System Log Settings
 - Auto Warning Settings
 - Event Settings
 - Serial Event Settings** (circled in red)

The **Serial Event Settings** page is located under **Auto Warning Settings** in the **System Management** folder. This is where you specify how the NPort will notify you of DCD and DSR events for each serial port. **Mail** refers to sending an e-mail to a specified address. **Trap** refers to sending an SNMP trap.

A change in the DCD (Data Carrier Detect) signal indicates that the modem connection status has changed. If the DCD signal changes to low, it indicates that the connection line is down. A change in the DSR (Data Set Ready) signal indicates that the data communication equipment is powered off. If the DSR signal changes to low, it indicates that the data communication equipment is powered down.



ATTENTION

SNMP indicates a change in DCD or DSR signals but does not differentiate between the two. A change in either signal from “-” to “+” is indicated by “link up” and a change in either signal from “+” to “-” is indicated by “link down.”

E-mail Alert

The **E-mail Alert** page is located under **Auto Warning Settings** in the **System Management** folder. This is where you specify how and where e-mail is sent when e-mail is used for automatic notification of system and serial port events.



ATTENTION

Consult your network administrator or ISP for the mail server settings to use for your network. If these settings are not configured correctly, e-mail notification may not work properly.

Mail Server (SMTP)

Default	
Options	free text (e.g., "192.168.3.3")
Description	This field specifies the IP address of the mail server that will be used when sending automatic warning e-mails. If the mail server requires authentication, select "My server requires authentication" and enter the username and password.

From e-mail address

Default	
Options	free text (e.g., "jsmith@xyz.com")
Description	This field specifies the e-mail address that will be listed in the e-mail's "From" field.

To e-mail address 1 to 4

Default	
Options	free text (e.g., "admin@abc.com")
Description	These fields specify the destination e-mail address(es) for the automatic e-mail warnings.

SNMP Trap

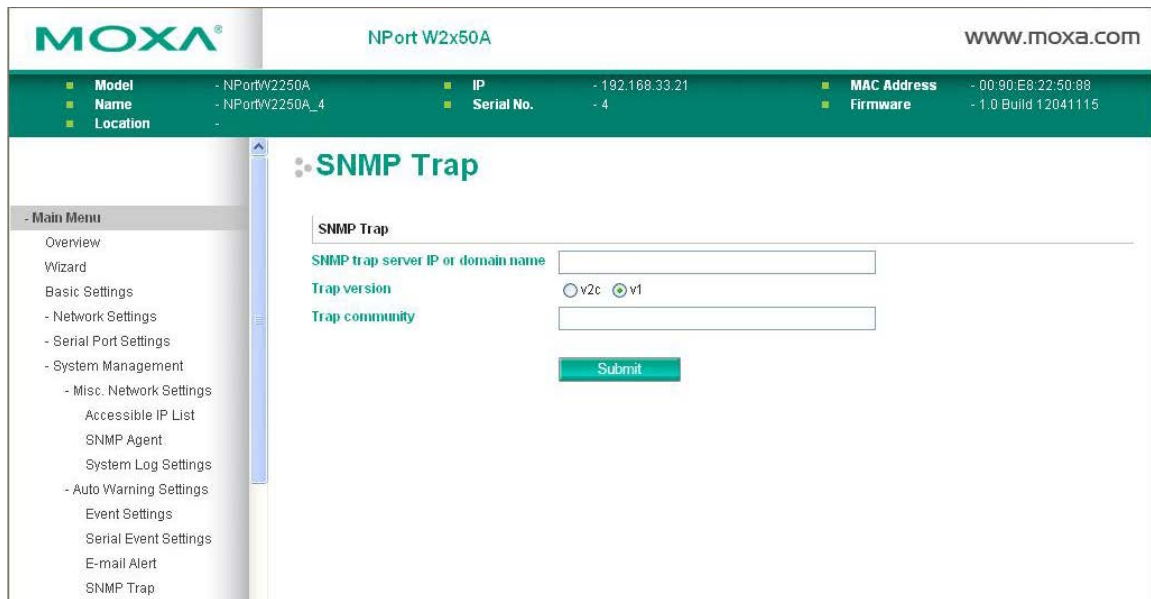

The **SNMP Trap** page is located under **Auto Warning Settings** in the **System Management** folder. This is where you specify the SNMP trap settings to use for automatic notification of system and serial port events.

SNMP Trap Server IP

Default	
Options	IP address (e.g., "192.168.5.5")
Description	This field specifies the IP address of the SNMP trap server that will receive SNMP traps.

Trap Version

Default	v1
Options	v1, v2c
Description	This field specifies the SNMP trap version to use.

Trap Community

Default	
Options	free text (e.g., "public access")
Description	This field specifies the SNMP trap community.

Maintenance

Console Settings

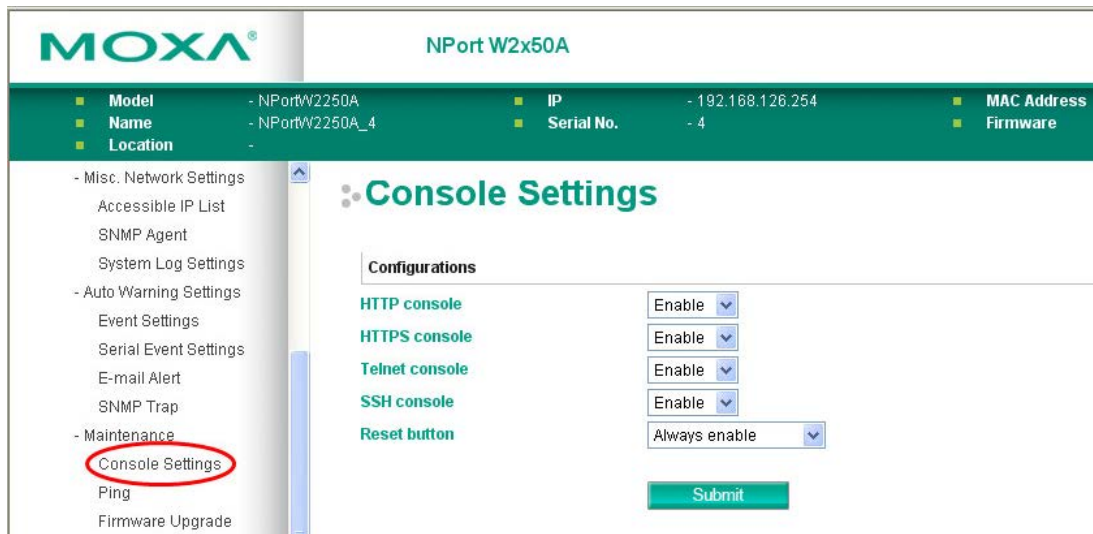

The **Console Settings** page is located under **Maintenance** in the **System Management** folder. This is where you enable or disable access to the various NPort configuration consoles, as well as the behavior of the reset button. You may modify **HTTP console**, **HTTPS console**, **Telnet console**, **SSH console**, and **Reset button**.

HTTP Console

Default	Enable
Options	Enable, Disable
Description	This field enables or disables access to the HTTP (web) console.

HTTPS Console

Default	Enable
Options	Enable, Disable
Description	This field enables or disables access to the HTTPS (web) console.

Telnet Console

Default	Enable
Options	Enable, Disable
Description	This field enables or disables access to the Telnet console.

SSH Console

Default	Enable
Options	Enable, Disable
Description	This field enables or disables access to the SSH console.

Reset Button

Default	Always Enable
Options	Always Enable, Disable after 60 sec
Description	<p>This field specifies the behavior of the hardware reset button.</p> <p>Always Enable: The reset button will be operate as usual.</p> <p>Disable after 60 sec: The reset button will only be effective for the first 60 seconds that the NPort is powered on.</p>

Maintenance

Ping

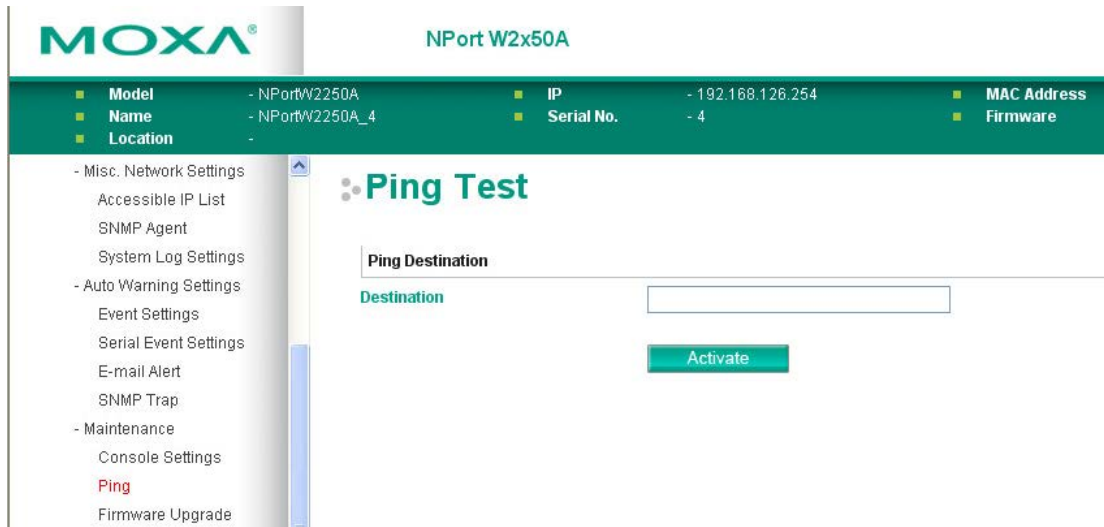

The **Ping** page is located under **Maintenance** in the **System Management** folder. It provides a convenient way to test an Ethernet connection or verify an IP address. Enter the IP address or domain name in the Destination field and click **[Activate]**. The results will be displayed immediately.

Firmware Upgrade

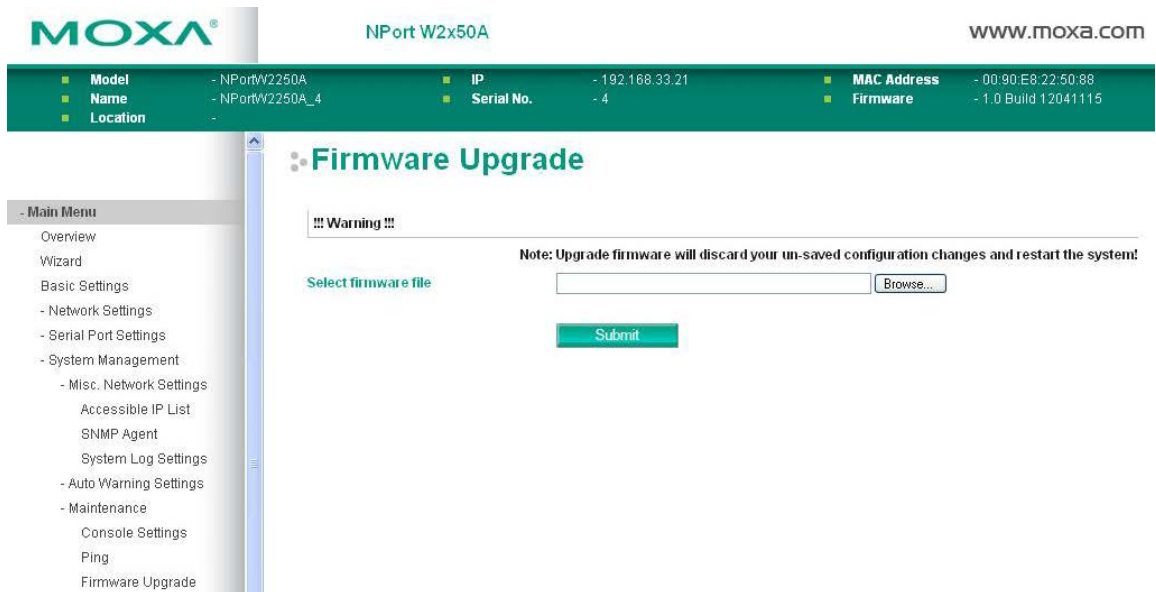

The **Firmware Upgrade** page is located under **Maintenance** in the **System Management** folder. This is where you can update the NPort firmware. After obtaining the latest firmware from www.moxa.com, select or browse for the firmware file in the **Select firmware file** field. Before clicking **[Submit]**, it is a good idea to save the NPort configuration using the **Configuration Export** page, since the firmware upgrade process may cause all settings to revert to factory defaults.

Configuration Import

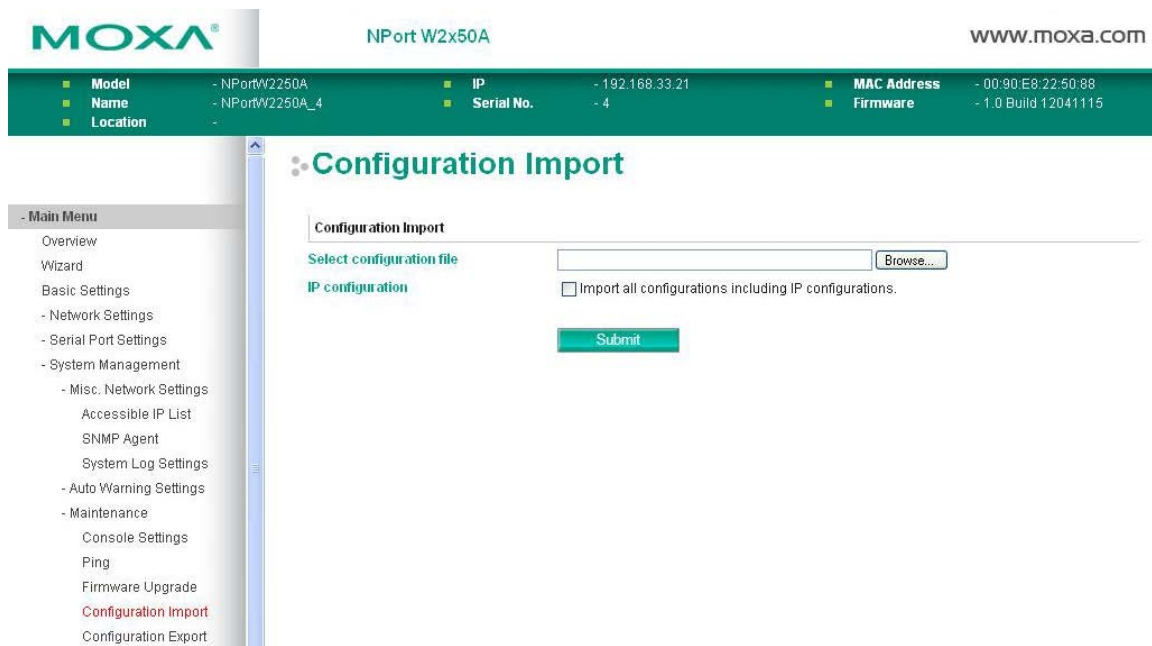

The **Configuration Import** page is located under **Maintenance** in the **System Management** folder. This is where you can load a previously saved or exported configuration. Select or browse for the configuration file in the **Select configuration file** field. If you also wish to import the IP configuration (i.e., IP address, netmask, and gateway), make sure that **Import all configurations including IP configurations** is checked.

Configuration Export

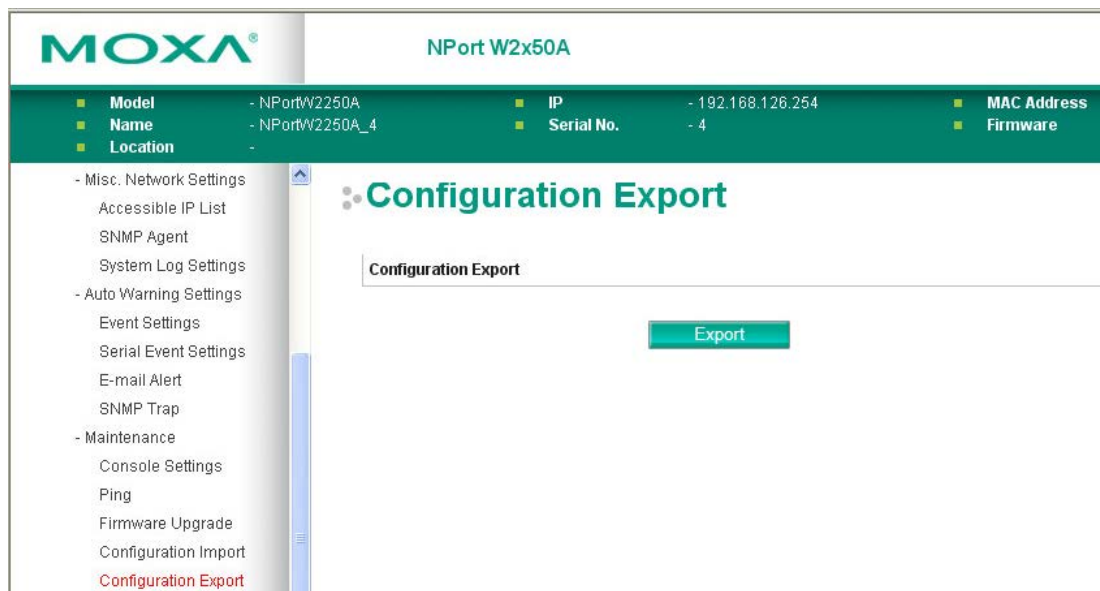

The **Configuration Export** page is located under **Maintenance** in the **System Management** folder. This is where you can save the NPort's current configuration to a file on the local host. Click **[Download]** to begin the process. A window should appear asking you to open or save the configuration text file.

Load Factory Default

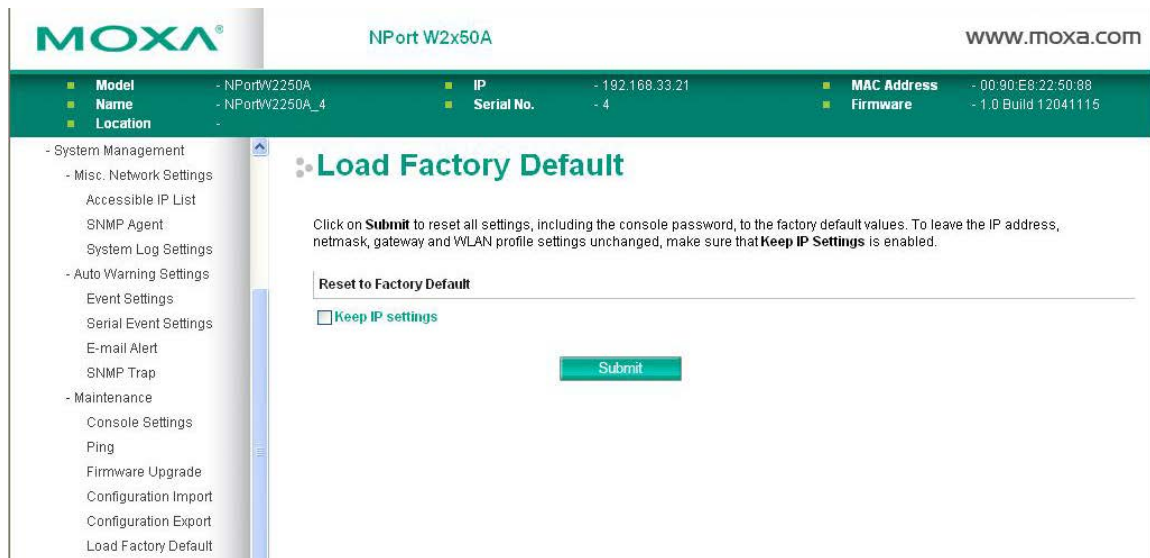

The **Load Factory Default** page is located under **Maintenance** in the **System Management** folder. Click **[Submit]** to reset all settings to the factory defaults. You can preserve the NPort’s existing IP settings (i.e., IP address, netmask, gateway, WLAN profile, and all certificates) by making sure **Keep IP settings** is checked before clicking **[Submit]**.

Change Password

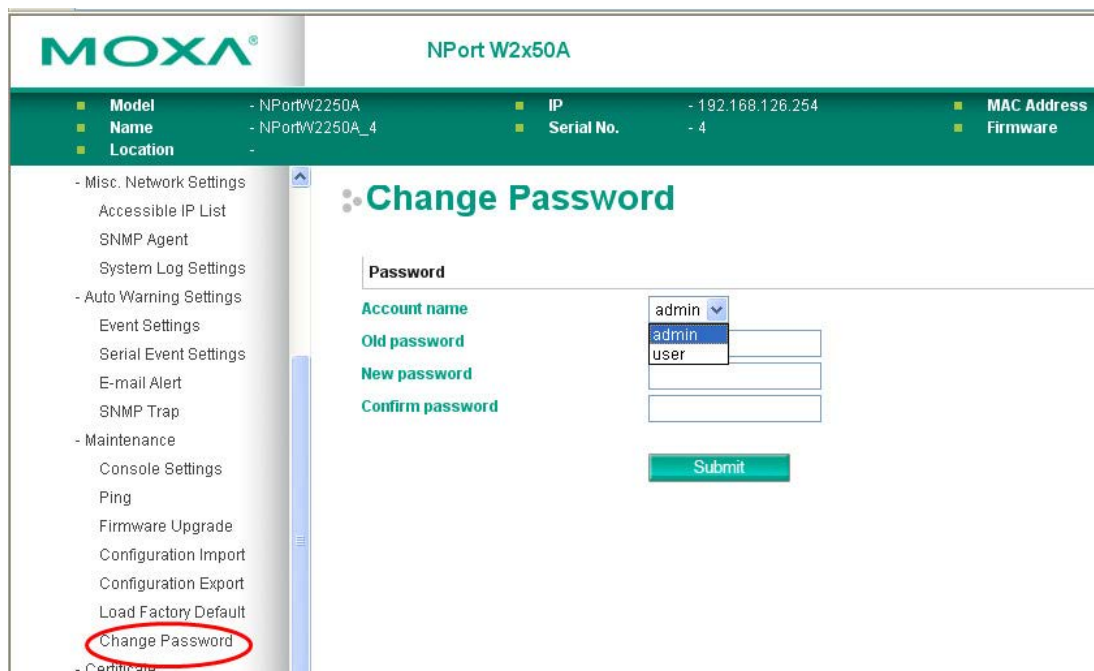

The **Change Password** page is located under **Maintenance** in the **System Management** folder. To change the password, choose the account name first, and then enter the old password in the **Old password** field. Leave this blank if the NPort is not currently password-protected. Enter the new password twice, once in the **New password** field and once in the **Confirm password**. Leave these fields blank to remove password protection.



ATTENTION

If you forget the password, the ONLY way to configure the NPort is by loading the factory defaults with the reset button. All settings will be lost.
Before setting the password, you may want to first export the configuration to a file. Your configuration can then be easily imported back into the NPort if necessary.

Certificate

Ethernet SSL Certificate Import

The screenshot shows the Moxa web console interface for an NPort W2x50A. The top navigation bar includes the Moxa logo and the device name. Below this is a status bar with fields for Model, Name, Location, IP, Serial No., MAC Address, and Firmware. The left sidebar contains a menu with various system management options, and 'Ethernet SSL Certificate Imp' is highlighted with a red circle. The main content area is titled 'Ethernet SSL Certificate Import' and contains the following information:

Installed Certificate	
Issued to	192.168.126.254
Issued by	192.168.126.254
Valid	from 2012/4/19 to 2017/4/4
Select SSL certificate/key file	<input type="text"/> <input type="button" value="Browse..."/>
<input type="button" value="Submit"/>	

The **Ethernet SSL Certificate Import** page is located under **Certificate** in the **System Management** folder. This is where you can load the Ethernet SSL certificate. Select or browse for the certificate file in the **Select SSL certificate/key file** field.

WLAN SSL Certificate Import

The screenshot shows the Moxa web console interface for an NPort W2x50A. The top navigation bar includes the Moxa logo and the device name. Below this is a status bar with fields for Model, Name, Location, IP, Serial No., MAC Address, and Firmware. The left sidebar contains a menu with various system management options, and 'WLAN SSL Certificate Imp' is highlighted in red. The main content area is titled 'WLAN SSL Certificate Import' and contains the following information:

Installed Certificate	
Issued to	Not installed
Issued by	Not installed
Valid	from Not installed to Not installed
Select SSL certificate/key file	<input type="text"/> <input type="button" value="Browse..."/>
<input type="button" value="Submit"/>	

The **WLAN SSL Certificate Import** page is located under **Certificate** in the **System Management** folder. By default, the WLAN SSL certificate is automatically generated by the NPort based on the IP address of the wireless interface. You can also import a certificate. Select or browse for the certificate file in the **Select SSL certificate/key file** field.

WPA Server Certificate Import



The **WPA Server Certificate Import** page is located under **Certificate** in the **System Management** folder. This is where you can load the WPA server certificate. Select or browse for the certificate file in the **Select WPA server certificate file** field.

You must install the trusted server certificate from the RADIUS server in order to enable **Verify server certificate** in the **WLAN Security** settings. This certificate will then be used by the NPort to authenticate the RADIUS server.

WPA User Certificate Import

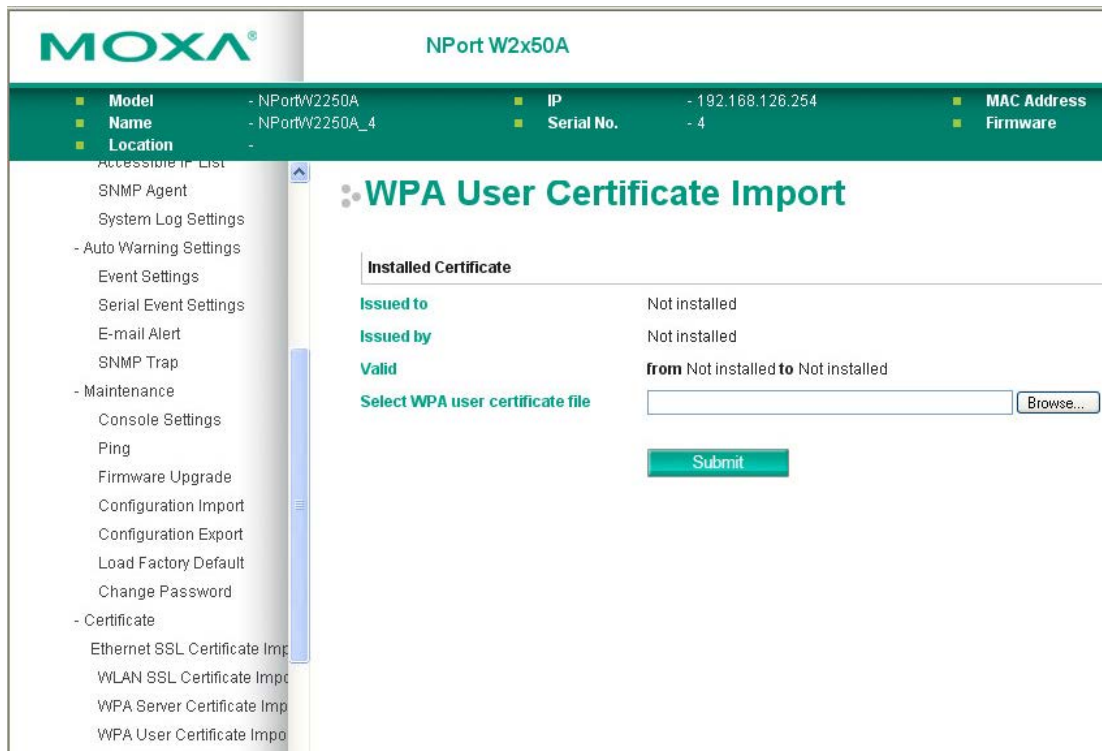

The **WPA User Certificate Import** page is located under **Certificate** in the **System Management** folder. This is where you can load the WPA user certificate. Select or browse for the certificate file in the **Select WPA user certificate file** field.

The user certificate of the NPort must be installed in the RADIUS server when the NPort uses WPA (WPA2)/TLS. The trusted server certificate of the RADIUS server must also be installed in the NPort.

WPA User Key Import

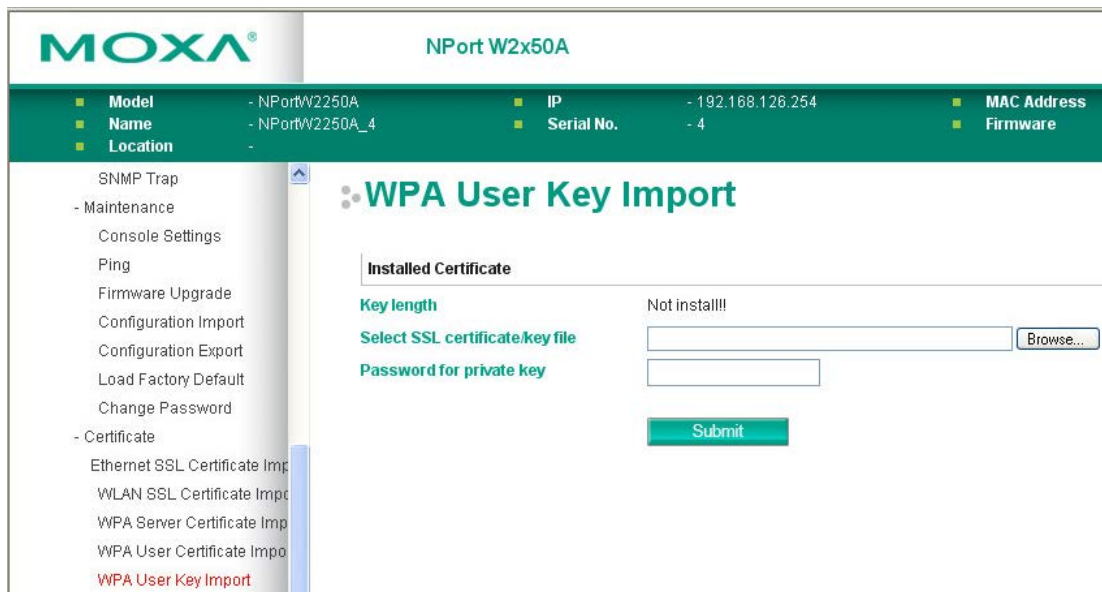

The **WPA User Key Import** page is located under **Certificate** in the **System Management** folder. This is where you can load the WPA user certificate. Select or browse for the user private key file in the **Select WPA user privacy key file** field and enter the **Password for the private key**.

The user private key of the NPort must be installed in the RADIUS server when the NPort uses WPA(WPA2)//TLS. The trusted server certificate of RADIUS server must also be installed on the NPort.

Certificate/Key Delete

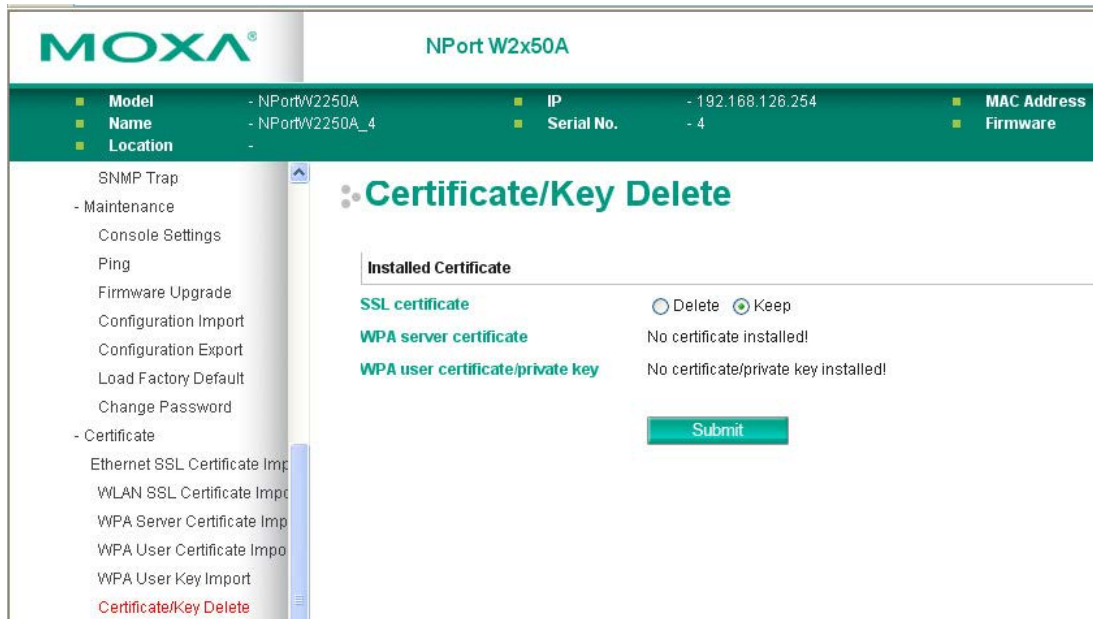

The **Certificate/Key Delete** page is located under **Certificate** in the **System Management** folder. This page is where you can delete certificates or WPA keys that have been installed on the model. When you click **[Submit]**, any certificate or key that has been set to “Delete” will be deleted from the NPort.

Web Console: System Monitoring

The following topics are covered in this chapter:

- **Overview**
- **System Monitoring**
 - Serial Status
 - System Status

Overview

This chapter explains how to use the **System Monitoring** functions on the NPort web console. These functions allow you to monitor many different aspects of operation.

System Monitoring

Serial Status

Serial to Network Connections

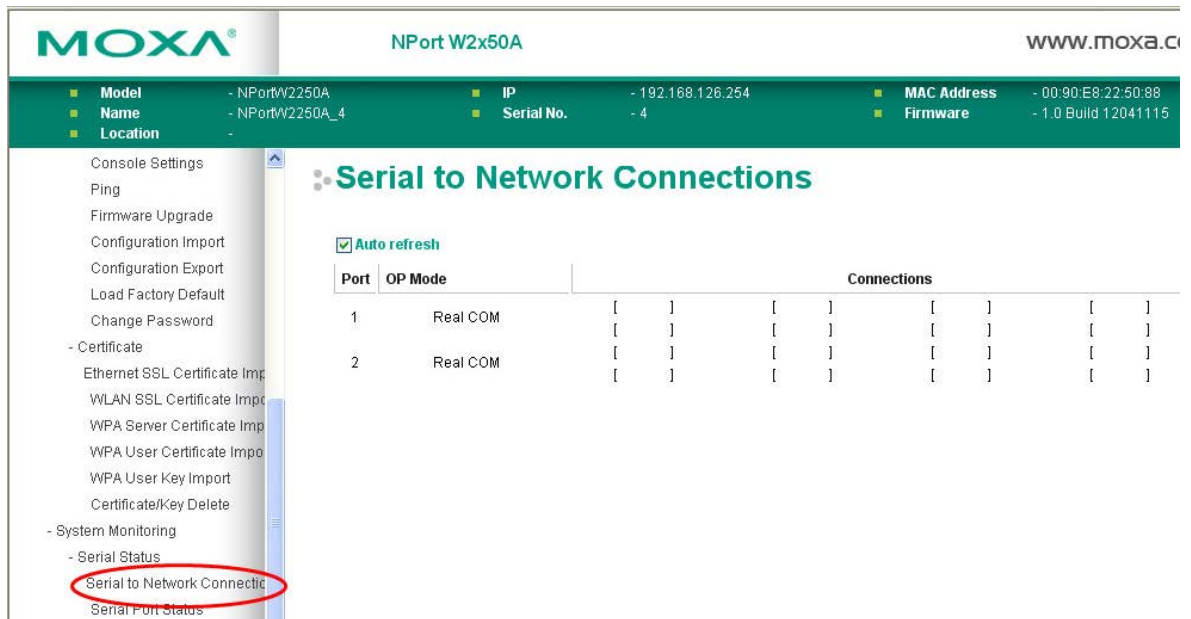

The **Serial to Network Connections** page is located under **Serial Status** in the **System Monitoring** folder. On this page, you can monitor the current operation mode and host connection status for each serial port.

Serial Port Status

The screenshot shows the Moxa NPort W2x50A web console interface. At the top, there is a header with the Moxa logo, the device name 'NPort W2x50A', and the website 'www.moxa.com'. Below the header, there is a navigation menu on the left and a main content area. The main content area is titled 'Serial Port Status' and includes a table with the following data:

Port	TxCnt	RxCnt	TxTotalCnt	RxTotalCnt	DSR	DTR	RTS	CTS	DCD
1	0	0	0	0	●	●	●	●	●
2	0	0	0	0	●	●	●	●	●

The **Serial Port Status** page is located under **Serial Status** in the **System Monitoring** folder. On this page, you can monitor the signal and data transmission status for each serial port.

TxCnt: number of Tx packets (to device) for the current connection

RxCnt: number of Rx packets (from device) for the current connection

TxTotalCnt: number of Tx packets since the NPort was powered on

RxTotalCnt: number of Rx packets since the NPort was powered on

Serial Port Error Count

The screenshot shows the Moxa NPort W2x50A web console interface. At the top, there is a header with the Moxa logo, the device name 'NPort W2x50A', and the website 'www.moxa.com'. Below the header, there is a navigation menu on the left and a main content area. The main content area is titled 'Serial Port Error Count' and includes a table with the following data:

Port	ErrCnt			
	Frame	Parity	Overrun	Break
1	0	0	0	0
2	0	0	0	0

The **Serial Port Error Count** page is located under **Serial Status** in the **System Monitoring** folder. On this page, you can view the current number of frame, parity, overrun and break errors for each serial port.

Serial Port Settings

The screenshot shows the MOXA NPort W2x50A web console interface. At the top, there is a header with the MOXA logo, the device name 'NPort W2x50A', and the website 'www.moxa.com'. Below the header is a status bar with fields for Model, Name, Location, IP, Serial No., MAC Address, and Firmware. The main content area is titled 'Serial Port Settings' and features an 'Auto refresh' checkbox. A table displays the configuration for two serial ports:

Port	Baud Rate	Data Bits	Stop Bits	Parity	Flow Control		FIFO	Interface
					RTS/CTS	XON/XOFF		
1	19200	8	1	None	OFF	OFF	Enable	RS-232
2	9600	8	1	None	OFF	OFF	Enable	RS-232

The **Serial Port Settings** page is located under **Serial Status** in the **System Monitoring** folder. On this page, you can view the current communication settings for each serial port.

System Status

Network Connections

The screenshot shows the MOXA NPort W2x50A web console interface. At the top, there is a header with the MOXA logo, the device name 'NPort W2x50A', and the website 'www.moxa.com'. Below the header is a status bar with fields for Model, Name, Location, IP, Serial No., MAC Address, and Firmware. The main content area is titled 'Network Connections' and features an 'Auto refresh' checkbox. A table displays the active network connections:

Protocol	Recv-Q	Send-Q	Local Address	Foreign Address	State
TCP	0	0	*:4900	*:0	LISTEN
TCP	0	0	*:966	*:0	LISTEN
TCP	0	0	*:967	*:0	LISTEN
TCP	0	0	*:80	*:0	LISTEN
TCP	0	0	*:950	*:0	LISTEN
TCP	0	0	*:22	*:0	LISTEN
TCP	0	0	*:951	*:0	LISTEN
TCP	0	0	*:23	*:0	LISTEN
TCP	0	0	*:443	*:0	LISTEN
TCP	0	0	192.168.126.254:80	192.168.126.11:3891	TIME_WAIT
TCP	0	0	192.168.126.254:80	192.168.126.11:3892	TIME_WAIT
TCP	0	0	192.168.126.254:80	192.168.126.11:3898	TIME_WAIT
TCP	0	0	192.168.126.254:80	192.168.126.11:3868	TIME_WAIT
TCP	0	0	192.168.126.254:80	192.168.126.11:3878	TIME_WAIT
TCP	0	0	192.168.126.254:80	192.168.126.11:3884	TIME_WAIT
TCP	0	0	192.168.126.254:80	192.168.126.11:3863	TIME_WAIT
TCP	0	1275	192.168.126.254:80	192.168.126.11:3908	ESTABLISHED
TCP	0	0	192.168.126.254:80	192.168.126.11:3873	TIME_WAIT
TCP	0	0	192.168.126.254:80	192.168.126.11:3883	TIME_WAIT
TCP	0	0	192.168.126.254:80	192.168.126.11:3897	TIME_WAIT

The **Network Connections** page is located under **System Status** in the **System Monitoring** folder. On this page, you can view the current status of any network connection to the NPort.

Serial Data Log

Data logs for each serial port can be viewed in ASCII or HEX format. After selecting the serial port and format, you may click **Select** all to select the entire log if you wish to copy and paste the contents into a text file. The **Clear log** and **Refresh** buttons allow you to clear or refresh the log contents.

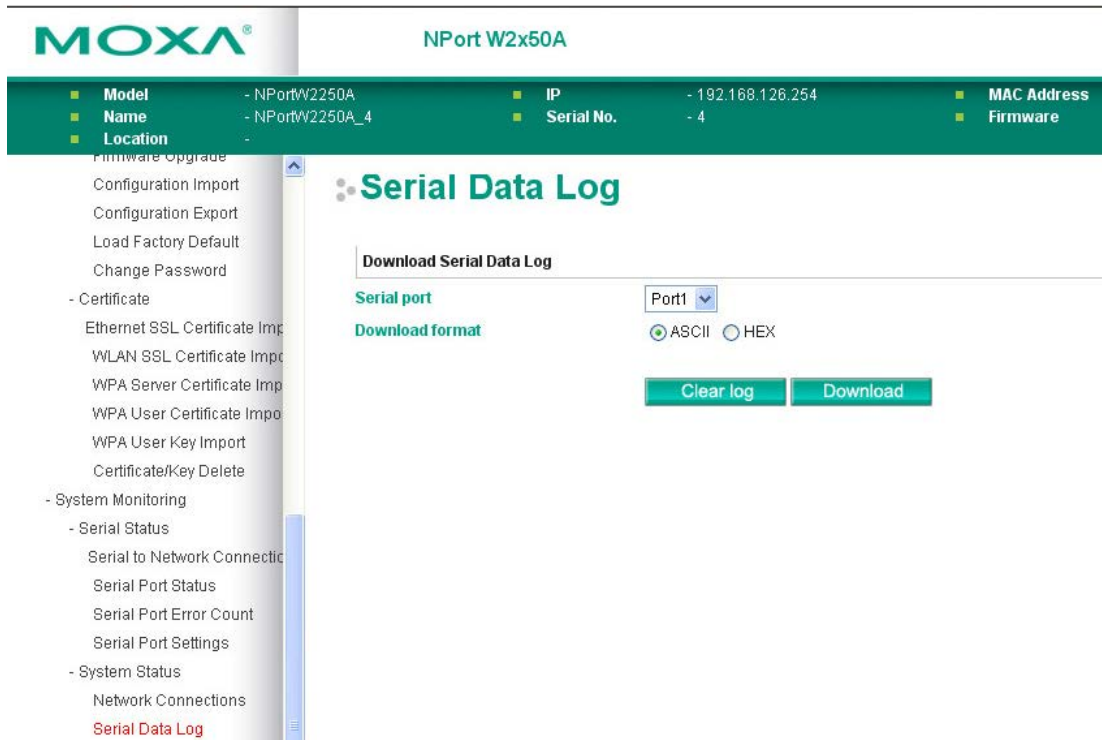

The **Serial Data Log** page is located under **System Status** in the **System Monitoring** folder. This is where you can download the current data log for a serial port. Select the desired serial port in the **Select port** field. Select the desired data format in the **Download format** field. Click **[Clear log]** to clear the log contents.

The data log includes all data sent or received by the specified serial port since the NPort was powered on. The maximum size of the log is 64 KB.

System Log

The screenshot shows the MOXA NPort W2x50A web console interface. At the top, the MOXA logo and device name 'NPort W2x50A' are visible. Below this is a green header bar containing device details: Model (NPortW2250A), Name (NPortW2250A_4), Location (-), IP (192.168.126.254), Serial No. (-4), MAC Address, and Firmware. A navigation menu on the left lists various system management options, with 'System Log' highlighted. The main content area features a 'System Log' section with a large empty box for log entries. Below the log box are two buttons: 'Clear log' and 'Refresh'.

The **System Log** page is located under **System Status** in the **System Monitoring** folder. This is where you can view the log of NPort system events. Click **[Clear log]** to clear the log contents. Click **[Refresh]** to refresh the log contents.

WLAN Status

The screenshot shows the MOXA NPort W2x50A web console interface. At the top, the MOXA logo and device name 'NPort W2x50A' are visible. Below this is a green header bar containing device details: Model (NPortW2250A), Name (NPortW2250A_4), Location (-), IP (192.168.126.254), Serial No. (-4), MAC Address, and Firmware. A navigation menu on the left lists various system management options, with 'WLAN Status' highlighted. The main content area features a 'WLAN Status' section with a checkbox for 'Auto refresh' checked. Below this is an 'Information' section containing a table of WLAN settings:

Information	
Active profile name	N/A
IP configuration	static
IP address	N/A
Netmask	N/A
Gateway	N/A
Network type	N/A
Operation mode	N/A
SSID	N/A
Channel	N/A
Authentication	N/A
Encryption	N/A
Region	CN
Signal strength	N/A
Connection speed	N/A

The **WLAN Status** page is located under **System Status** in the **System Monitoring** folder. This is where you can view the current WLAN settings and status.

WLAN Site Survey

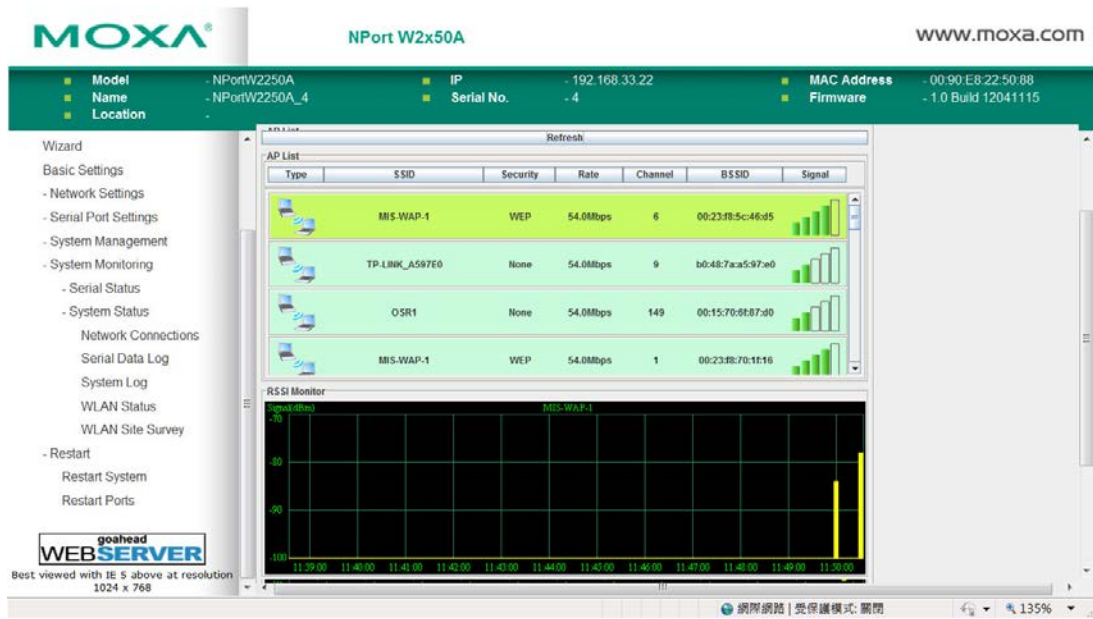

The **WLAN Site Survey** page is located under **System Status** in the **System Monitoring** folder. This is where you can view live data on wireless signal strength and characteristics. It is useful tool to help you complete a wireless site survey without installing additional software.

The goal of a WLAN site survey is to determine the number and placement of access points to provide enough coverage to the facility. For most implementations, "enough coverage" means that the data rate at all locations does not fall below a certain threshold. For most wireless sites, it is necessary to perform a WLAN site survey before access point installation in order to determine the behavior of radio waves at the site.

Typical WLAN Site Survey

Procedure

1. Download/install site survey software.
2. Run software on laptop.
3. Measure AP signal strength using software on laptop.

Weakness

- Signal strength is read from the laptop NIC rather than from NPort

WLAN Site Survey with NPort W2150/W2250A Series



The diagram illustrates a WLAN site survey setup. A ceiling-mounted Access Point (AP) is shown with signal waves emanating from it. Below the AP, a laptop is connected to a server rack via a network switch. A monitor displays a web console interface, likely used for monitoring and configuring the AP. The setup is connected to a server rack, which is part of the NPort W2150/W2250A Series.

Procedure

1. Open web browser
2. Measure AP signal from NPort web console.

Advantages

- Signal strength is read from NPort
- Additional software not required

Please note that Java must be enabled in your web browser for the **WLAN Site Survey** page to display properly.

10

Web Console: Restart

The following topics are covered in this chapter:

- **Overview**
- **Restart**
 - Restart System
 - Restart Ports

Overview

This chapter explains how to use save your configuration changes and restart the NPort using the NPort web console. Configuration changes will not be effective until they are saved and the NPort is rebooted.

Restart

Restart System

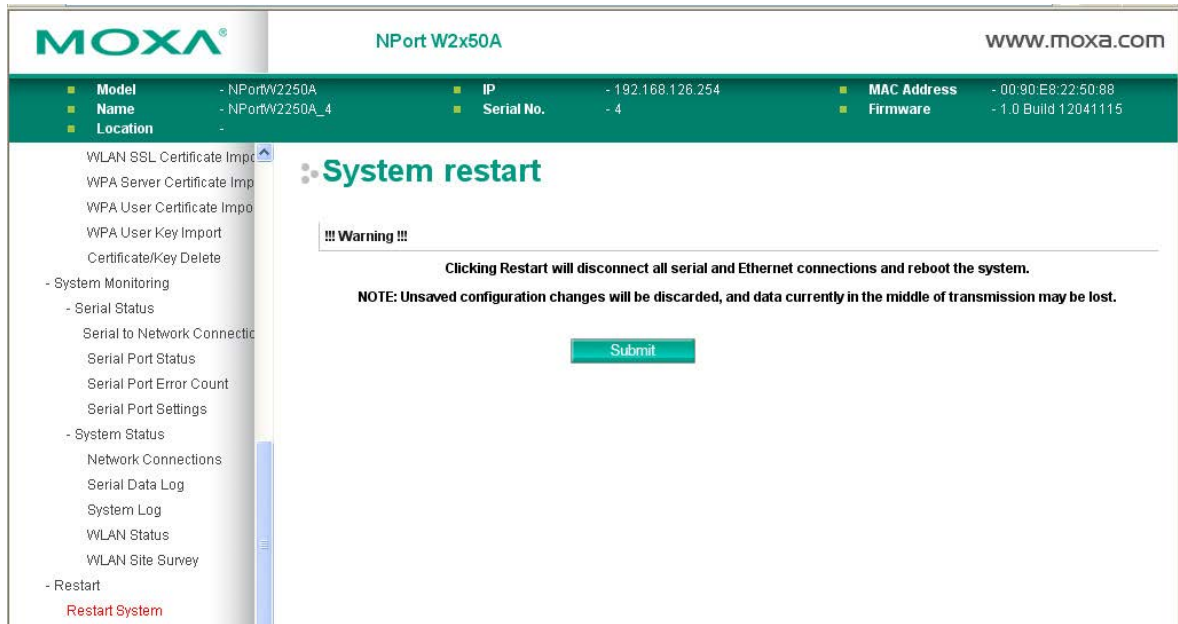

The **Restart System** page is located in the **Restart** folder. Click **[Restart]** to restart the NPort, and the new settings will take effect upon restart.

Restart Ports

The screenshot shows the MOXA NPort W2x50A web console interface. At the top, there is a header with the MOXA logo and the device model 'NPort W2x50A'. Below the header is a table with device information:

Model	- NPortW2250A	IP	- 192.168.126.254	MAC Address	
Name	- NPortW2250A_4	Serial No.	- 4	Firmware	
Location	-				

Below the table is a sidebar menu with various system management options. The 'Restart' folder is expanded, and 'Restart Ports' is highlighted with a red circle. The main content area displays the 'Restart Ports' page, which includes a 'Select Ports' section with two checkboxes: 'Port 1' and 'Port 2'. A green 'Submit' button is located below the checkboxes.

The **Restart Ports** page is located in the **Restart** folder. Select the desired serial and click **[Select All]** to select all serial ports. Click **[Submit]** to restart the selected serial ports.

Installing and Configuring the Software

The following topics are covered in this chapter:

□ Overview

□ NPort Windows Driver Manager

- Installing NPort Windows Driver Manager
- Adding Mapped Serial Ports
- Configuring Mapped Serial Ports

□ NPort Search Utility

- Installing NPort Search Utility
- Finding NPort Device Servers on Network
- Modifying NPort IP Addresses
- Upgrading NPort Firmware

□ Linux Real TTY Drivers

- Basic Steps
- Installing Linux Real TTY Driver Files
- Mapping TTY Ports
- Removing Mapped TTY Ports
- Removing Linux Driver Files

□ UNIX Fixed TTY Drivers

- Installing the UNIX Driver
- Configuring the UNIX Driver

Overview

This chapter describes how to install and use NPort Windows Driver Manager, NPort Search Utility, and NPort Linux and UNIX drivers. These items are located on the Document & Software CD that is provided with the NPort W2150A/W2250A Series.

NPort Windows Driver Manager is a utility that installs and manages NPort COM drivers for COM mapping.

NPort Search Utility is a utility for the management of NPort device servers over the network. You may also use NPort Search Utility to upgrade the firmware.

NPort Windows Driver Manager

NPort Windows Driver Manager installs remote NPort serial ports as new COM ports on your Windows PC. When the drivers are installed and configured, devices that are attached to serial ports on the NPort will be treated as if they were attached to your PC's own COM ports. The NPort serial port must be configured for RealCOM mode when being mapped to a COM port.

Installing NPort Windows Driver Manager

1. The main installation window will open when you insert the Document & Software CD. Click **[INSTALL COM Driver]** to proceed. Once the installation program starts running, click **[Yes]** to proceed.
2. The installation wizard will open. Click **[Next]** to proceed.

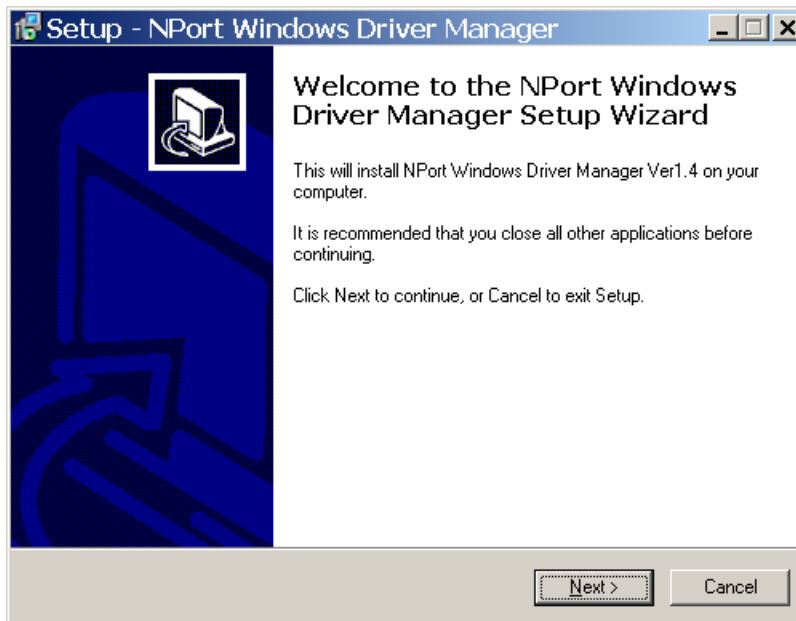

3. Select a destination directory and click **[Next]** to proceed.

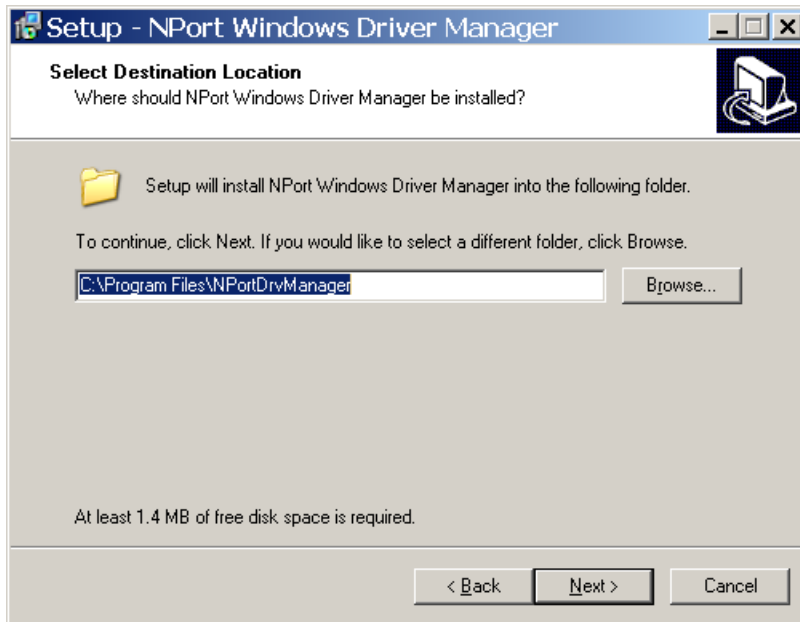

4. Select a folder for the program shortcuts and click **[Next]** to proceed.

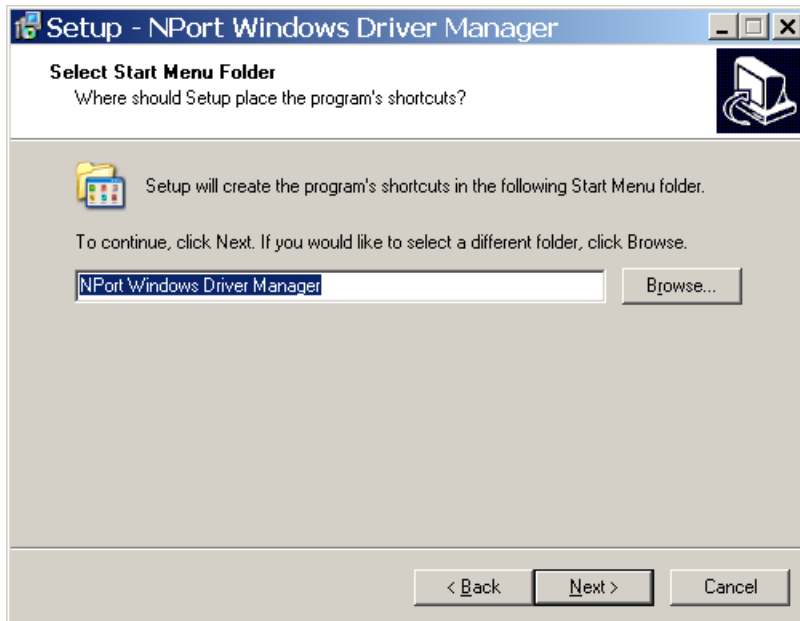

5. Verify the installation parameters and click **Install** to proceed.

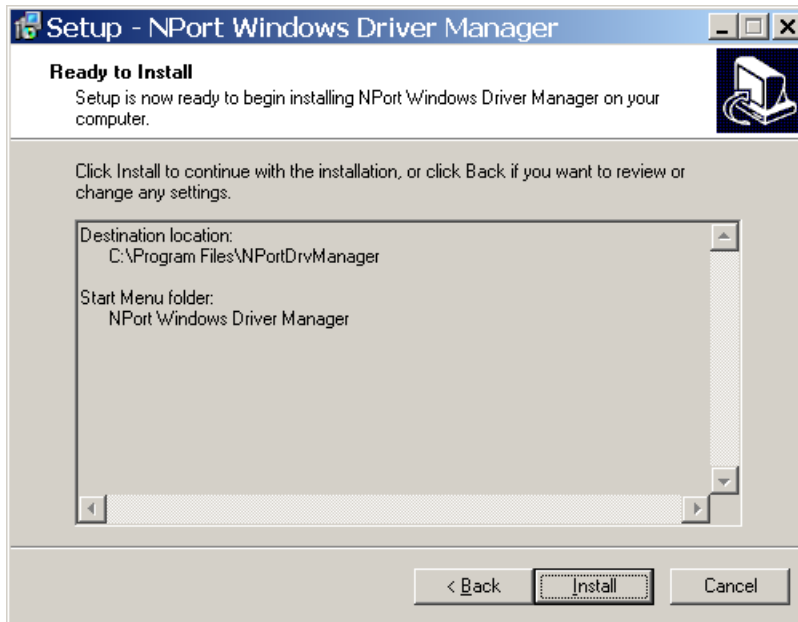

6. If you see a warning that the software has not passed Windows Logo testing, click **[Continue Anyway]** to proceed.



7. The wizard will begin installing the files. When the files have been installed, click **[Finish]** to complete the installation.

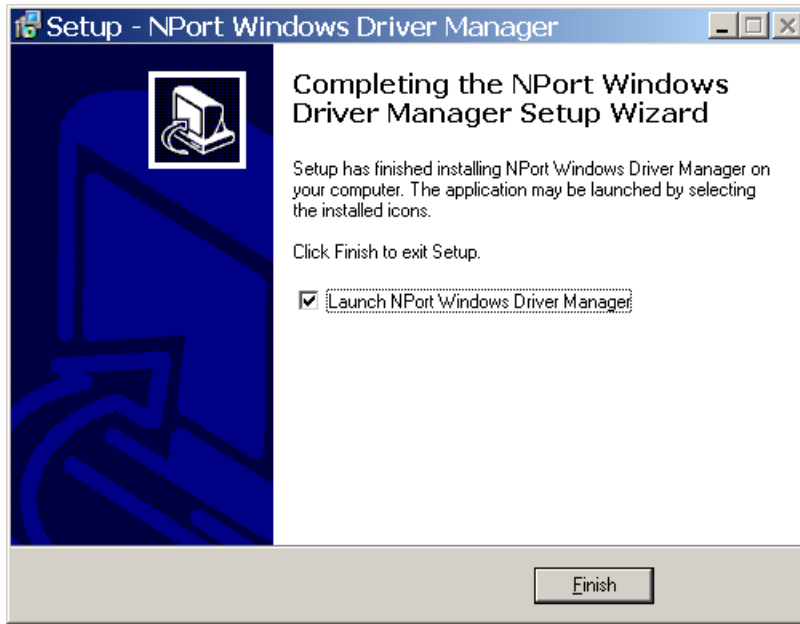

Adding Mapped Serial Ports

NPort Windows Driver Manager adds a COM port to your PC that is mapped to an NPort serial port. The destination NPort serial port must be set to RealCOM mode.

1. In **NPort Windows Driver Manager**, click **[Add]** on the main toolbar.

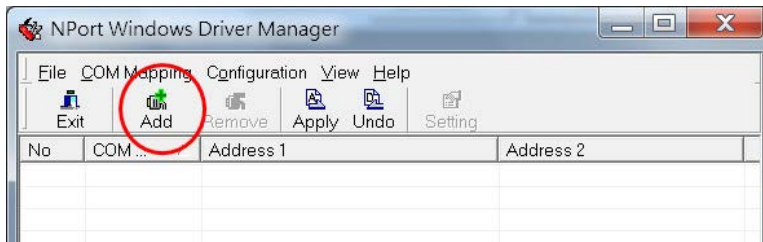

2. Click **[Rescan]** to search the network for NPort device servers. In the list of NPort device servers that are found, select the unit(s) that you will use for COM mapping and click **[OK]**.

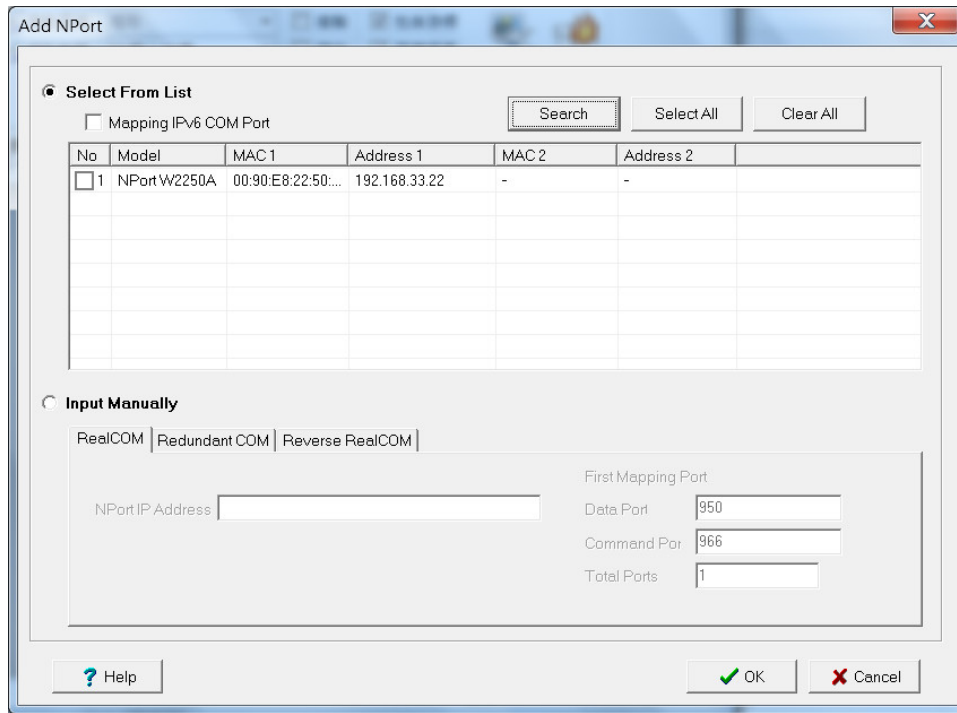

Alternatively, you can select **Input Manually** and manually enter the **NPort IP Address**, **1st Data Port**, **1st Command Port**, and **Total Ports** for the desired NPort unit. Click **[OK]** to proceed.

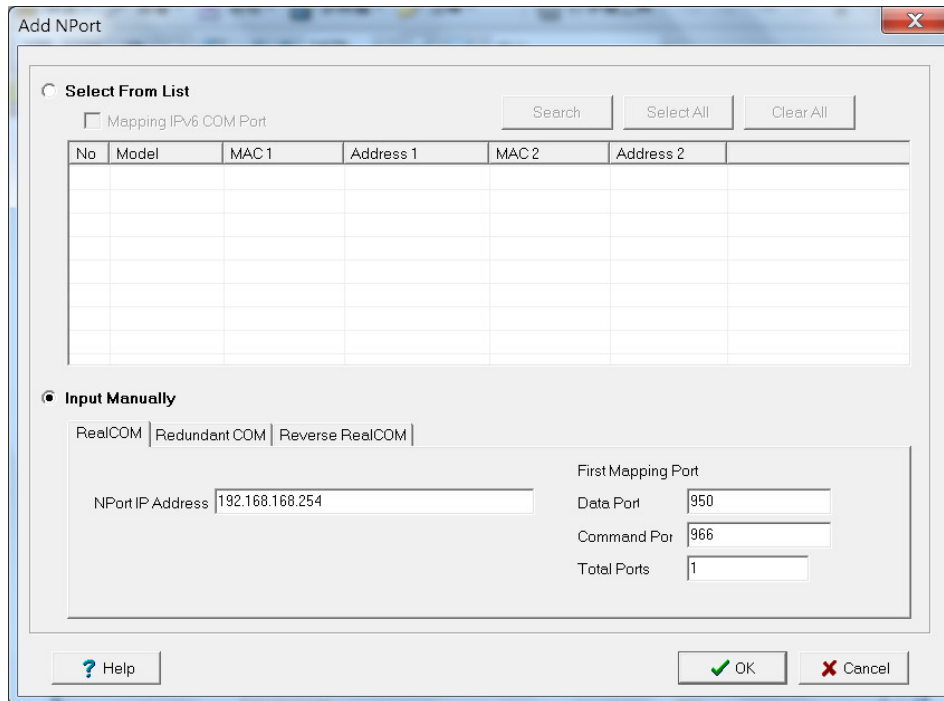

- NPort Windows Driver Manager will list each available serial port and will automatically assign a new COM port to each one. The new COM port will not be accessible by the host system until it has been activated in NPort Windows Driver Manager. Activating a mapped COM port saves the information in the host system registry and makes the COM port available for use. Click **[Yes]** to activate the COM port(s) at this time; click **[No]** to activate the COM port(s) later.

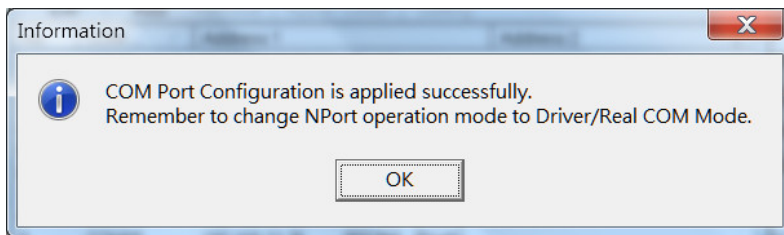
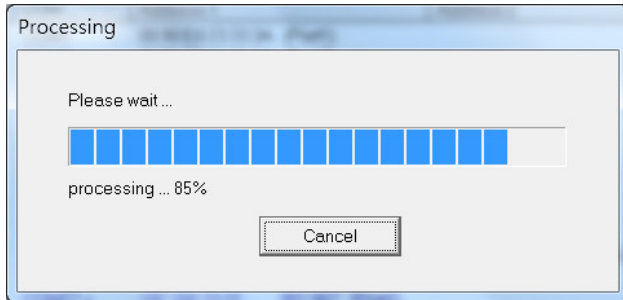
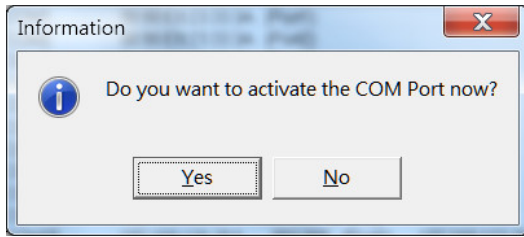

- Activated COM ports will be listed in black; COM ports that have not been activated will be listed in blue. Once a COM port has been activated, the host computer will be able to communicate with the new COM port as if it were physically attached. Since the COM mappings are stored in the host system registry, they will still be in effect if the PC is restarted or if Windows Driver Manager is closed.

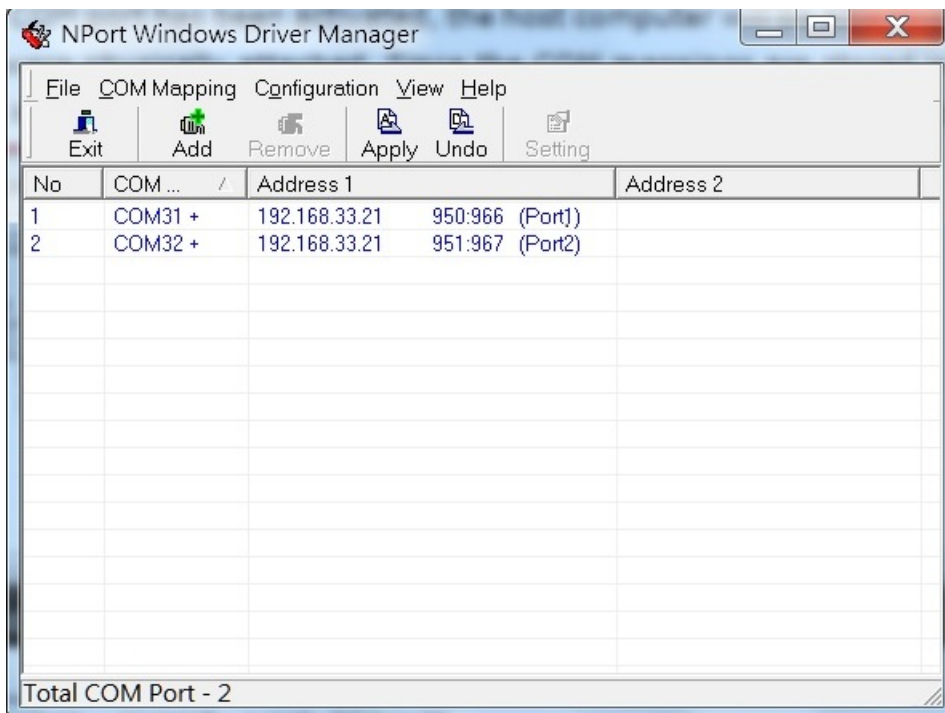

Configuring Mapped Serial Ports

1. To modify the settings of a mapped serial port, select the desired port(s) and click **[Setting]** on the main toolbar.

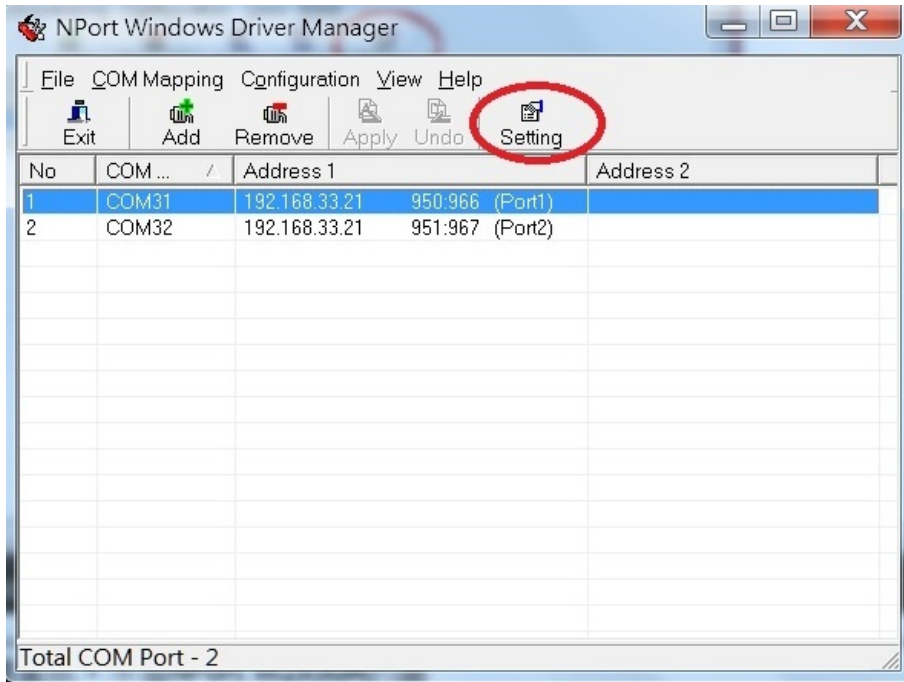

2. On the **Basic Setting** tab, select the **COM Number** that will be assigned to the serial port. If you have selected multiple ports, you can assign COM numbers automatically in sequential order by selecting the "Auto Enumerating COM Number for Selected Ports" function.

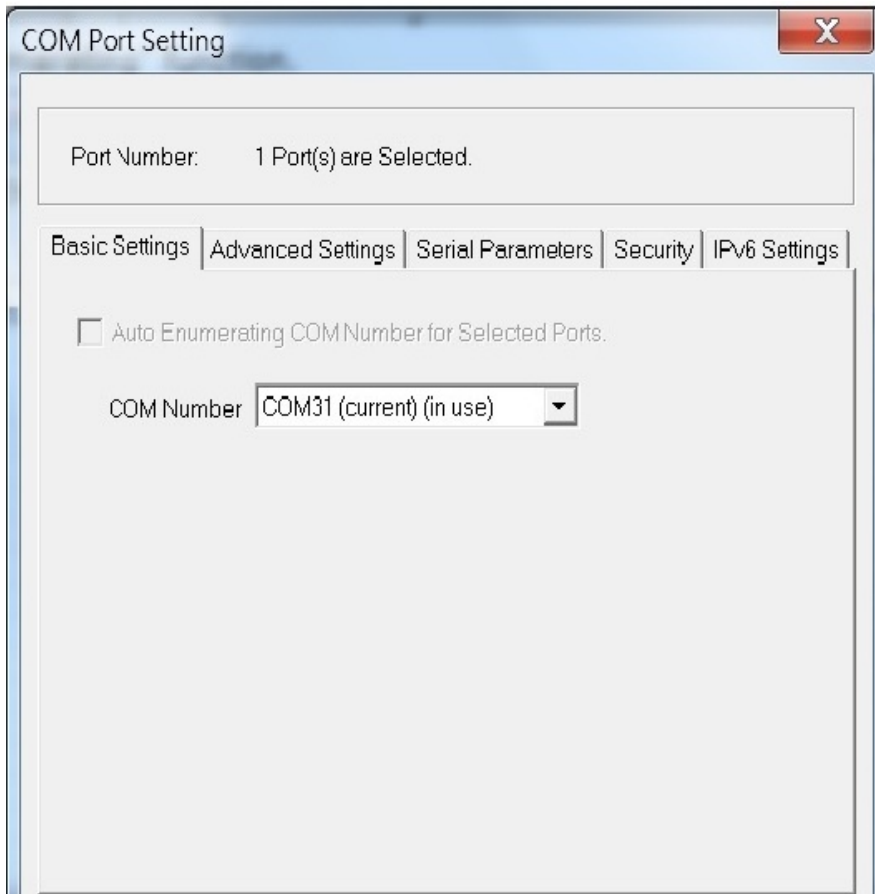

3. On the **Advanced Setting** tab, configure **Tx Mode**, **FIFO**, and **Fast Flush**.

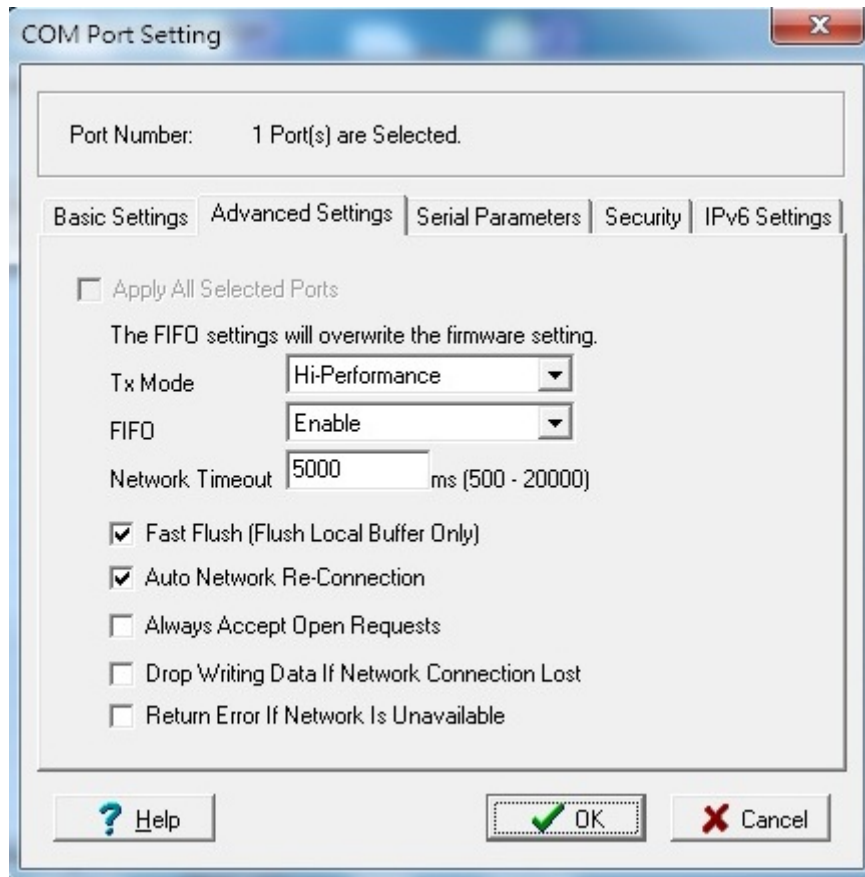

Tx Mode: In Hi-Performance mode, the driver immediately issues a “Tx Empty” response to the program after sending data to the NPort. In Classical mode, the driver sends the “Tx Empty” response after confirmation is received from the NPort. Classical mode is recommended if you want to ensure that all data is sent out before further processing.

FIFO: This tells the driver whether or not to use the FIFO.

Network Timeout: You can use this option to prevent blocking if the target NPort is unavailable.

Fast Flush: When enabled, the driver flushes only the local buffer on the host for a Win32 PurgeComm() function call. When disabled, both the local and remote buffers are flushed. If your application uses PurgeComm() and performance seems sluggish, try enabling Fast Flush.

Auto Network Re-Connection: With this option enabled, the driver will repeatedly attempt to re-establish the TCP connection if the NPort does not respond to background “check alive” packets

Always Accept Open Requests: When enabled, the NPort driver will always accept requests to open a virtual COM port, even if communications with the device can not be established. With this option, the NPort driver will agree to open a virtual COM port on the system even if the port is blocked or the Ethernet connection is disabled. If this is the case, the connected device will not receive and transmit data even though the system has opened a virtual COM port.

Drop Writing Data if Network Connection is Lost: This function will assure the data to be kept in the buffer or dropped when network connection is lost. The buffer size is 4 KBytes.

Return error if network is unavailable: If this option is disabled, the driver will not return any error even when a connection cannot be established to the NPort. With this option enabled, calling the Win32 Comm function will result in the error return code “STATUS_NETWORK_UNREACHABLE” when a connection cannot be established to the NPort. This usually means that your host’s network connection is down, perhaps due to a cable being disconnected. However, if you can reach other network devices, it may be that

the NPort is not powered on or is disconnected. Not that **Auto Network Re-Connection** must be enabled in order to use this function.

- On the **Serial Parameters** tab, specify the communication settings that the host will use when opening the COM port.

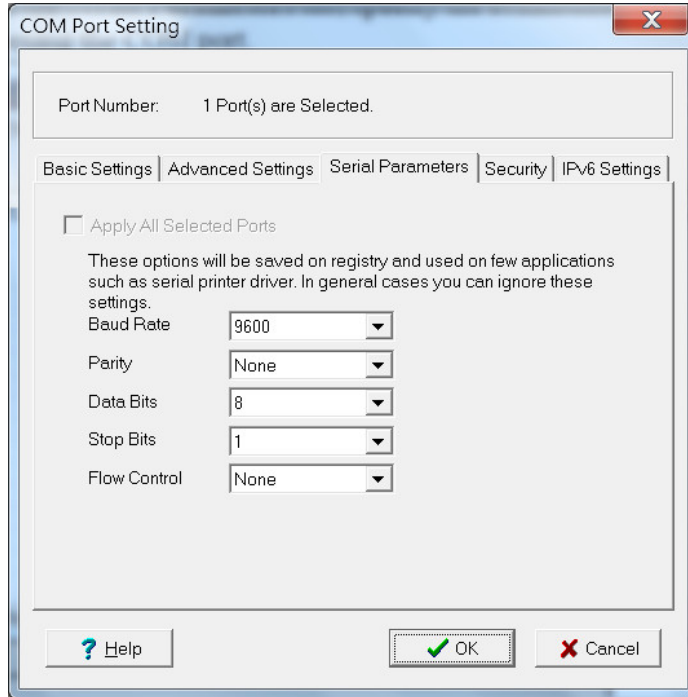

- On the **Security** tab, select the **Enable Data Encryption** option to enable data to be encrypted when transmitted over the COM ports. After selecting the encryption option, select the **Keep connection** option to start encrypting COM port communications immediately without restarting the COM ports. This may speed up opening and closing of the COM port for your host, but it also causes your host to tie up the NPort serial port so other hosts cannot use it.

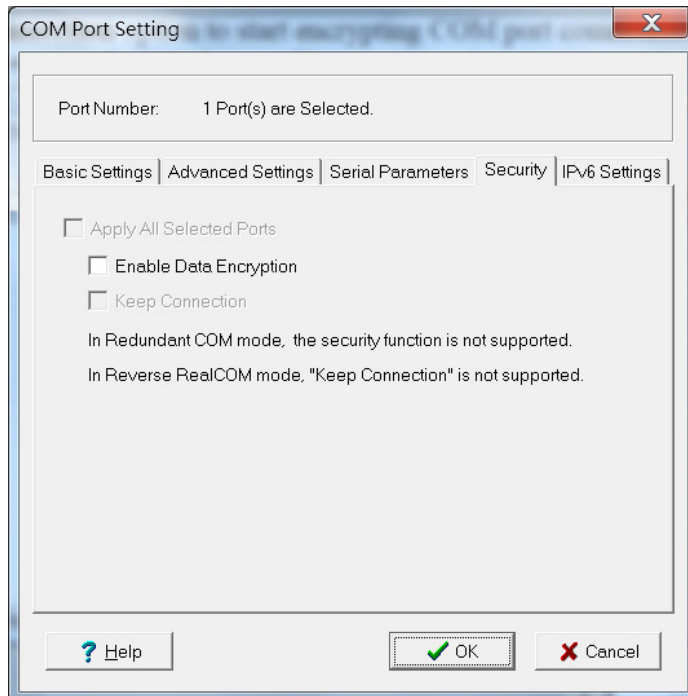

- 6. On the IPv6 Setting tab, interface 1 and 2 are able to change.

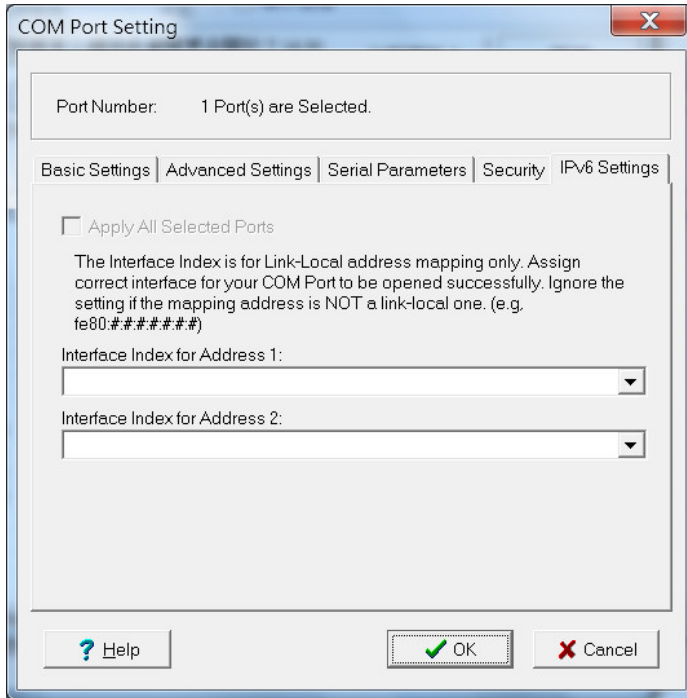

- 7. Click **[OK]** when you have finished configuring the COM port
- 8. To save all COM mapping settings to a text file, right-click a COM port and select **Export** in the context menu. After the settings have been exported to a file, they can be imported on another host.

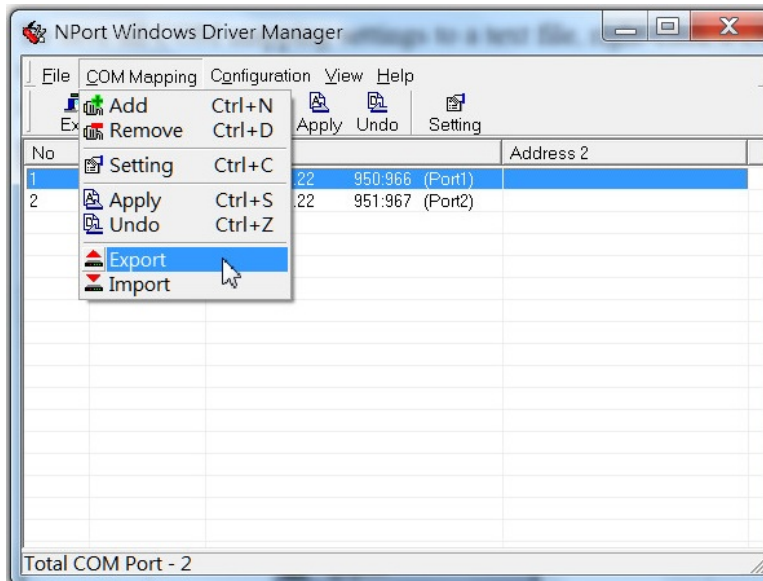

NPort Search Utility

Installing NPort Search Utility

1. The main installation window will open when you insert the Document & Software CD. Click **[INSTALL UTILITY]** to proceed. Once the program starts running, click **[Yes]** to proceed.
2. The installation wizard will open. Click **[Next]** to proceed.

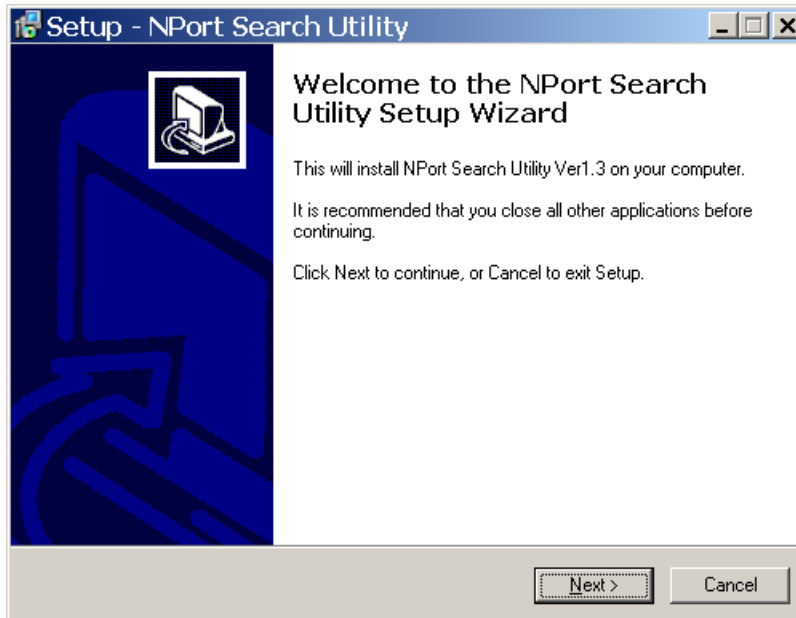

3. Select a destination directory and click **[Next]** to proceed.

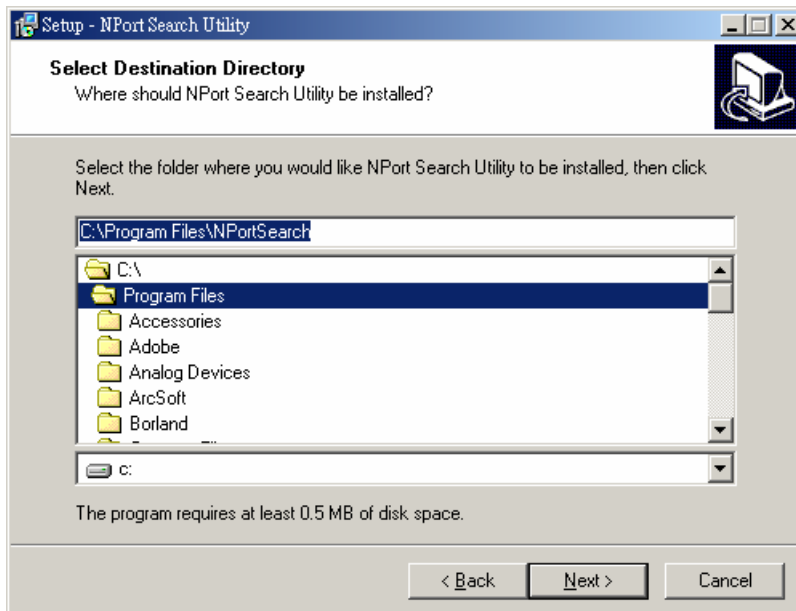

- Indicate if you wish to create a desktop icon and click **[Next]** to proceed.

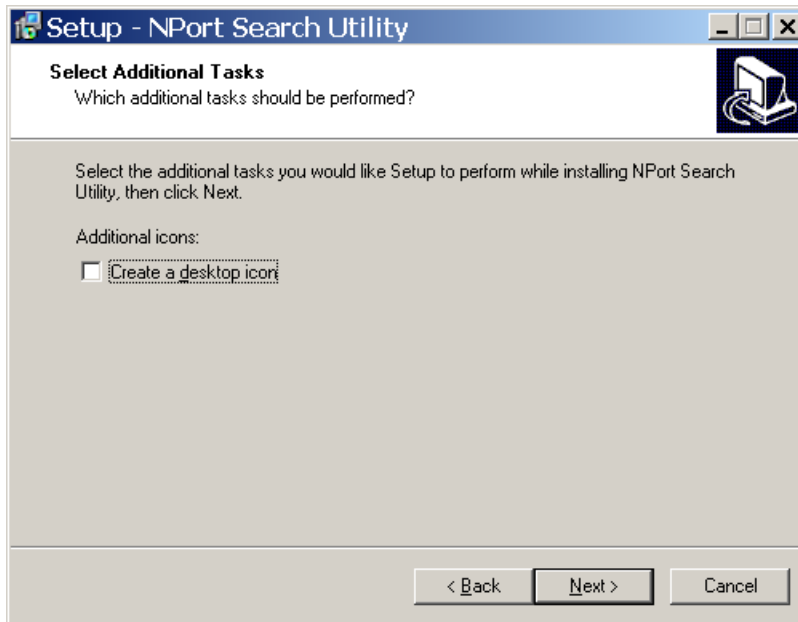

- Verify the installation parameters and click **Install** to proceed.

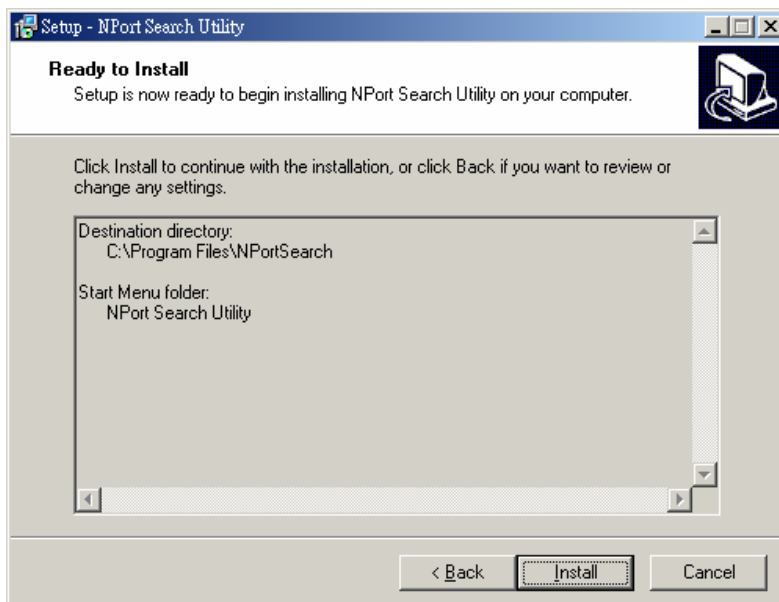

- The wizard will begin installing the files. After the files have been installed, click **[Finish]** to complete the installation.

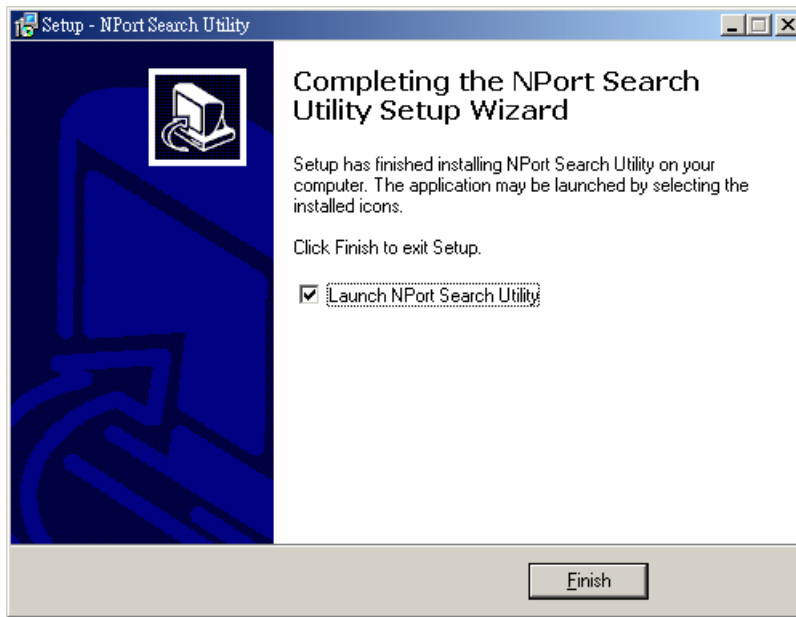

Finding NPort Device Servers on Network

You can use **NPort Search Utility** to look up or change the IP address of any NPort device servers on the network. Since the utility searches by MAC address rather than IP address, all NPort units that connect to the LAN will be located, regardless of whether or not they are part of the same subnet as the host.

- In **NPort Search Utility**, click **[Search]** on the main toolbar.

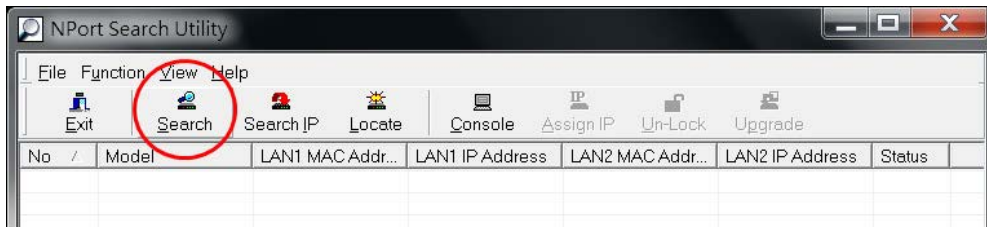

- The utility will be searching for NPort device servers.

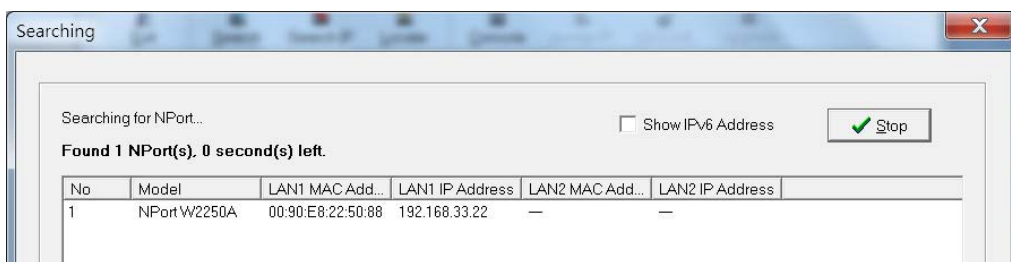

When the search is complete, NPort units that were found will be listed in the main window.

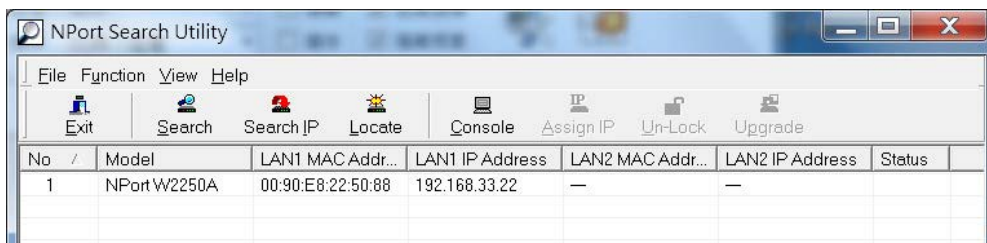

Modifying NPort IP Addresses

- Once NPort Search Utility has found NPort device servers on the LAN, you can modify any unit's IP address. Select the desired NPort in the main window and click **[Assign IP]** on the main toolbar. This will modify the IP address for the active network connection (LAN or WLAN).

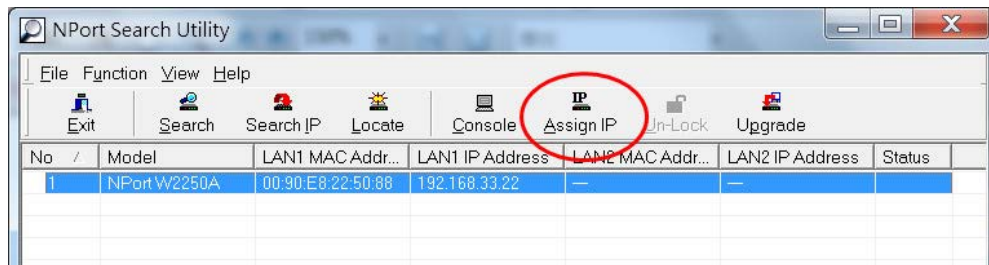

- Enter the new IP address and netmask. If multiple units were selected, you may assign addresses sequentially by clicking **[Assign IP Sequentially]**. Click **[OK]** to proceed.

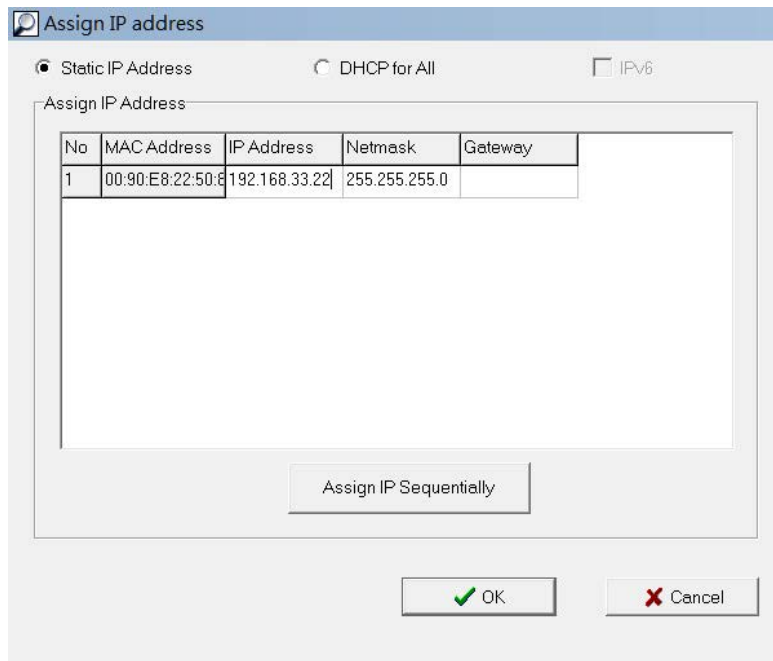

- The selected NPort will be restarted by NPort Search Utility with the new IP address.

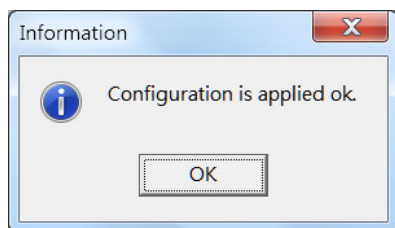

Upgrading NPort Firmware

- Once NPort Search Utility has found NPort device servers on the LAN, you can upgrade any unit's firmware. Right-click the desired NPort in the main window and select **Upgrade**.

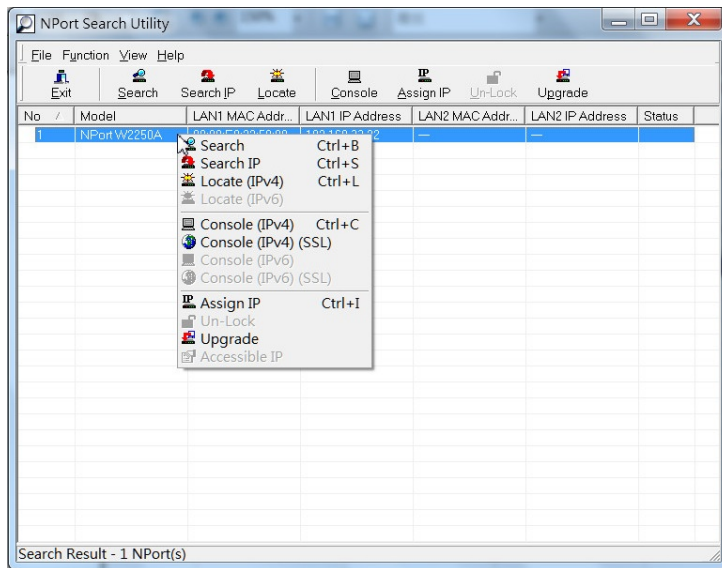

- Select the new firmware file and click **[OK]** to proceed. To obtain the latest firmware for the NPort W2150A/W2250A, visit www.moxa.com.

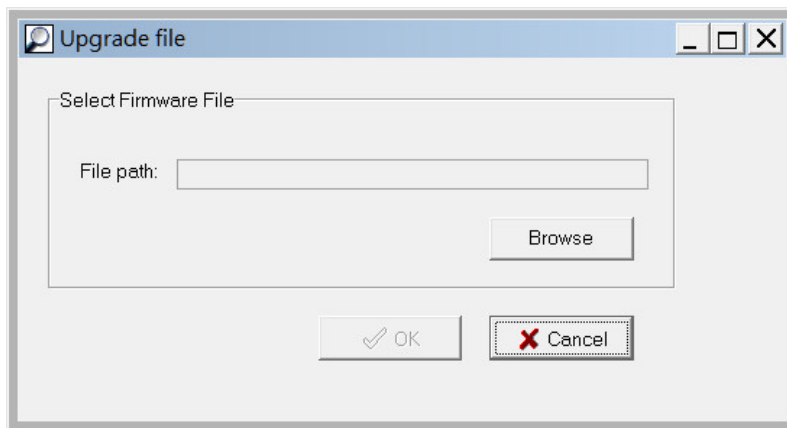

- The utility will begin upgrading the firmware for the selected unit. Do not disconnect or power off the unit while the firmware is being upgraded.

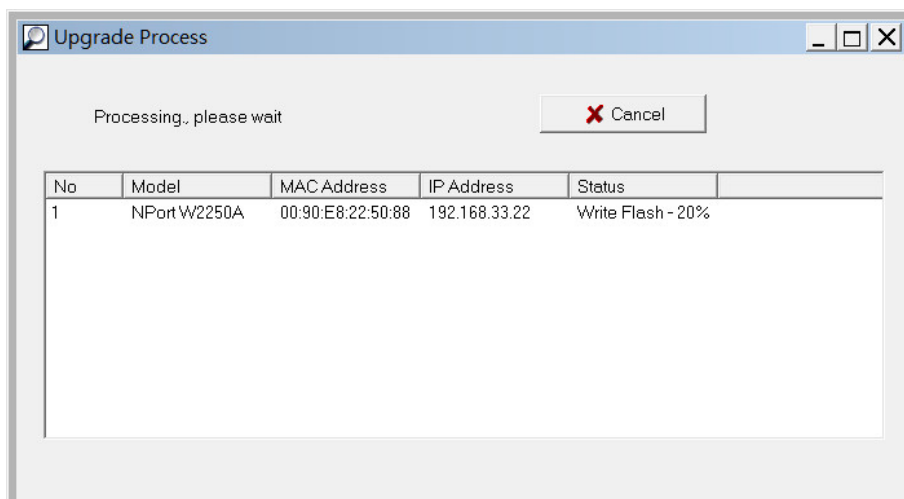

4. When the displayed status is "OK", click [Close] to complete the process.

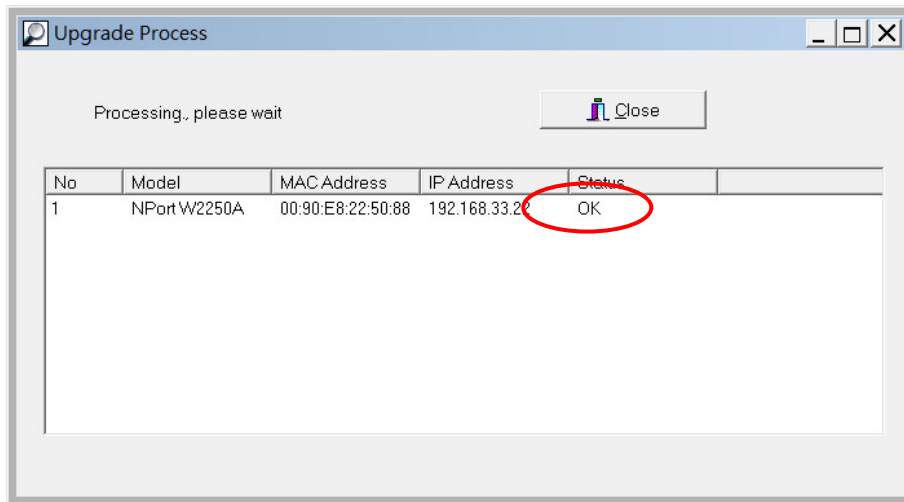

ATTENTION

NPort Search Utility supports upgrading the firmware of multiple units simultaneously, if each unit is the same model. Hold down the CTRL to add additional units to your selection; hold down the SHIFT key to select a block of units.

Linux Real TTY Drivers

Real TTY driver are provided that will map Linux host TTY ports to NPort serial ports. Once the mapping has been set up, Linux users and applications can connect to a serial port as if it were a local TTY port. These drivers have been designed and tested for the majority of Linux distributions, including Linux kernel version 2.4.x, 2.6.x, and 3.x. Please check <http://www.moxa.com> for the latest Linux kernel supported.

Basic Steps

Follow these instructions to map a TTY port to a NPort serial port:

1. Install the NPort device server and set the target device port to RealCOM mode.
2. Install the Real TTY driver files on the Linux host.
3. Map the host's TTY port to the target device port on the NPort.

Installing Linux Real TTY Driver Files

Before proceeding with the software installation, make sure you have completed the NPort device server has been installed and configured correctly. Note that the default LAN IP address for the NPort is **192.168.126.254**, whereas the default WLAN IP address is **192.168.127.254**.



ATTENTION

The target serial port must be operating in RealCOM mode in order to map TTY ports.

1. Obtain the driver file from the Document and Software CD, or from <http://www.moxa.com>.
2. Log in to the console as a super user (root).
3. Execute `cd /` to go to the root directory.
4. Copy the driver file `npreal2xx.tgz` to the / directory.

5. Execute **tar xvfz npreal2xx.tgz** to extract all files into the system.
6. Execute **/tmp/moxa/mxinst**. (For RedHat AS/ES/WS and Fedora Core1, execute **"# /tmp/moxa/mxinst SP1"**.) The shell script will install the driver files automatically.
7. After installing the driver, you will be able to see several files in the **/usr/lib/npreal2/driver** folder:
 - mxaddsvr** (add server, map TTY port)
 - mxdelsvr** (delete server, undo TTY port mapping)
 - mxloadsvr** (reload server)
 - mxmknod** (create device node/tty port)
 - mxrmnod** (remove device node/tty port)
 - mxuninst** (remove TTYport and driver files)

At this point, you may map the TTY port to the NPort serial port.

Mapping TTY Ports

Make sure that you set the operation mode of the desired NPort serial port to RealCOM mode. After logging in as a super user, enter the directory **/usr/lib/npreal2/driver** and then execute **mxaddsvr** to map the target NPort serial port to the host TTY ports. The syntax of **mxaddsvr** is as follows:

```
mxaddsvr [NPort IP Address] [Total Ports] ([Data port] [Cmd port])
```

The **mxaddsvr** command performs the following actions:

1. Modify npreal2d.cf.
2. Create TTY ports in directory /dev with major and minor number configured in npreal2d.cf.
3. Restart the driver.

Mapping TTY ports automatically

To map TTY ports automatically, you may execute **mxaddsvr** with just the IP address and number of ports, as in the following example:

```
# cd /usr/lib/npreal2/driver  
# ./mxaddsvr 192.168.3.4 16
```

In this example, 16 TTY ports will be added, all with IP 192.168.3.4, with data ports from 950 to 965 and command ports from 966 to 981.

Mapping TTY ports manually

To map TTY ports manually, you may execute **mxaddsvr** and manually specify the data and command ports, as in the following example:

```
# cd /usr/lib/npreal2/driver  
# ./mxaddsvr 192.168.3.4 16 4001 966
```

In this example, 16 TTY ports will be added, all with IP 192.168.3.4, with data ports from 4001 to 4016 and command ports from 966 to 981.

Removing Mapped TTY Ports

After logging in as root, enter the directory **/usr/lib/npreal2/driver** and then execute **mxdelsvr** to delete a server. The syntax of **mxdelsvr** is:

```
mxdelsvr [IP Address]
```

Example:

```
# cd /usr/lib/npreal2/driver  
# ./mxdelsvr 192.168.3.4
```

The following actions are performed when executing **mxdelsvr**:

1. Modify npreal2d.cf.
2. Remove the relevant TTY ports in directory /dev.
3. Restart the driver.

If the IP address is not provided in the command line, the program will list the installed servers and total ports on the screen. You will need to choose a server from the list for deletion.

Removing Linux Driver Files

A utility is included that will remove all driver files, mapped TTY ports, and unload the driver. Enter the directory **/usr/lib/npreal2/driver** and execute **mxuninst** to uninstall the driver. This program will perform the following actions:

1. Unload the driver.
2. Delete all files and directories in /usr/lib/npreal2.
3. Delete directory /usr/lib/npreal2.
4. Modify the system initializing script file.

UNIX Fixed TTY Drivers

A fixed TTY driver is provided that will map UNIX host TTY ports to NPort serial ports. Once the mapping has been set up, UNIX users and applications can connect to an NPort serial port as if it were a local TTY port. This driver has been designed and tested for the majority of UNIX systems. Please check <http://www.moxa.com> for the latest UNIX systems support.

Installing the UNIX Driver

1. Log in to UNIX and create a directory for the MOXA TTY. To create a directory named **/usr/etc**, execute the command:

```
# mkdir -p /usr/etc
```

2. Copy **moxattyd.tar** to the directory you created. For the **/usr/etc** directory, you would execute the following commands:

```
# cp moxattyd.tar /usr/etc
```

```
# cd /usr/etc
```

3. Extract the source files from the tar file by executing the command:

```
# tar xvf moxattyd.tar
```

The following files will be extracted:

README.TXT

moxattyd.c --- source code

moxattyd.cf --- an empty configuration file

Makefile --- makefile

VERSION.TXT --- fixed TTY driver version

FAQ.TXT

4. Compile and link.

For SCO UNIX:

```
# make sco
```

For UnixWare 7:

```
# make svr5
```

For UnixWare 2.1.x, SVR4.2:

```
# make svr42
```

Configuring the UNIX Driver

Modify the configuration:

The configuration used by **moxattyd** is defined in the text file **moxattyd.cf**, which is in the same directory. You may use vi or any text editor to modify the file, as follows:

```
ttyp1 192.168.1.1 950
```

You can refer to **moxattyd.cf** for detailed descriptions of the various configuration parameters. Please note that "Device Name" depends on the OS. See the Device Naming Rule section in README.TXT for more information.

To start the **moxattyd** daemon after system bootup, add an entry into **/etc/inittab** using the TTY name you defined in **moxattyd.cf**, as in the following example:

```
ts:2:respawn:/usr/etc/moxattyd/moxattyd -t 1
```

Device naming rule

For UnixWare 7, UnixWare 2.1.x, and SVR4.2, use:

```
pts/[n]
```

For all other UNIX operating systems, use:

```
ttyp[n]
```

The value of [n] should be equal or larger than 11 in order to prevent conflicts with the device names of functional keys in some UNIX systems.

Starting moxattyd

Execute the command **init q** or reboot your UNIX operating system.

Adding an additional server

Modify the text file **moxattyd.cf** to add an additional server. User may use vi or any text editor to modify the file. For more configuration information, refer to **moxattyd.cf**, which contains detailed descriptions of the various configuration parameters.

Find the process ID (PID) of the **moxattyd**.

```
# ps -ef | grep moxattyd
```

Update the configuration of **moxattyd**.

```
# kill -USR1 [PID]
```

(e.g., if moxattyd PID = 404, **kill -USR1 404**)

This completes the process of adding an additional server.

SNMP Agents with MIB II & RS-232-Like Groups

The NPort has built-in SNMP (Simple Network Management Protocol) agent software that supports SNMP Trap, RFC1317 RS-232 like groups and RFC 1213 MIB-II. The following table lists the standard MIB-II groups, as well as the variable implementation for the NPort.

RFC1213 MIB-II Supported SNMP Variables

System MIB

SysDescr	SysContact	SysServices
SysObjectID	SysName	
SysUpTime	SysLocation	

Interfaces MIB

ifNumber	ifOperStatus	ifOutOctets
ifIndex	ifLastChange	ifOutUcastPkts
ifDescr	ifInOctets	ifOutNUcastPkts
ifType	ifInUcastPkts	ifOutDiscards
ifMtu	ifInNUcastPkts	ifOutErrors
ifSpeed	ifInDiscards	ifOutQLen
ifPhysAddress	ifInErrors	ifSpecific
ifAdminStatus	ifInUnknownProtos	

IP MIB

ipForwarding	ipOutDiscards	ipAdEntIfIndex
ipDefaultTTL	ipOutNoRoutes	ipAdEntNetMask
ipInreceives	ipReasmTimeout	ipAdEntBcastAddr
ipInHdrErrors	ipReasmReqds	ipAdEntReasmMaxSize
ipInAddrErrors	ipReasmOKs	IpNetToMediaIfIndex
ipForwDatagrams	ipReasmFails	IpNetToMediaPhysAddress
ipInUnknownProtos	ipFragOKs	IpNetToMediaNetAddress
ipInDiscards	ipFragFails	IpNetToMediaType
ipInDelivers	ipFragCreates	IpRoutingDiscards
ipOutRequests	ipAdEntAddr	

ICMP MIB

IcmpInMsgs	IcmpInTimestamps	IcmpOutRedirects
IcmpInErrors	IcmpTimest ampReps	IcmpOutEchos
IcmpInDestUnreachs	IcmpInAddrMasks	IcmpOutEchoReps
IcmpInTimeExcds	IcmpOutMsgs	IcmpOutTimestamps
IcmpInParmProbs	IcmpOutErrors	IcmpOutTimestampReps
IcmpInSrcQuenchs	IcmpOutDestUnreachs	IcmpOutAddrMasks
IcmpInRedirects	IcmpOutTimeExcds	IcmpOutAddrMaskReps
IcmpInEchos	IcmpOutParmProbs	
IcmpInEchoReps	IcmpOutSrcQuenchs	

UDP MIB

UdpInDatagrams	UdpOutDatagrams
UdpNoPorts	UdpLocalAddress
UdpInErrors	UdpLocalPort

Address Translation

AtIfIndex	AtNetAddress
AtPhysAddress	

TCP MIB

tcpRtoAlgorithm	tcpEstabResets	tcpConnLocalPort
tcpRtoMin	tcpCurrEstab	tcpConnRemAddress
tcpRtoMax	tcpInSegs	tcpConnRemPort
tcpMaxConn	tcpOutSegs	tcpInErrs
tcpActiveOpens	tcpRetransSegs	tcpOutRsts
tcpPassiveOpens	tcpConnState	
tcpAttemptFails	tcpConnLocalAddress	

SNMP MIB

snmpInPkts	snmpInTotalReqVars	snmpOutGenErrs
snmpOutPkts	snmpInTotalSetVars	snmpOutGetRequests
snmpInBadVersions	snmpInGetRequests	snmpOutGetNexts
snmpInBadCommunityNames	snmpInGetNexts	snmpOutSetRequests
snmpInASNParseErrs	snmpInSetRequests	snmpOutGetResponses
snmpInTooBig	snmpInGetResponses	snmpOutTraps
snmpInNoSuchNames	snmpInTraps	snmpEnableAuthenTraps
snmpInBadValues	snmpOutTooBig	
snmpInReadOnly	snmpOutNoSuchNames	
snmpInGenErrs	snmpOutBadValues	

RFC1317: RS-232 MIB Objects

Generic RS-232-like Group

rs232Number

RS-232-like General Port Table

rs232PortTable
rs232PortEntry
rs232PortIndex
rs232PortType
rs232PortInSigNumber
rs232PortOutSigNumber
rs232PortInSpeed
rs232PortOutSpeed

RS-232-like Asynchronous Port Group

rs232AsyncPortTable	rs232AsyncPortIndex	rs232AsyncPortStopBits
rs232AsyncPortEntry	rs232AsyncPortBits	rs232AsyncPortParity

The Input Signal Table

rs232InSigTable	rs232InSigPortIndex	rs232InSigState
rs232InSigEntry	rs232InSigName	

The Output Signal Table

rs232OutSigTable	rs232OutSigPortIndex	rs232OutSigState
rs232OutSigEntry	rs232OutSigName	

B

Well Known Port Numbers

Listed below are Well Known Port Numbers that may cause network problems if they are assigned to an NPort serial port. Refer to RFC 1700 for Well Known Port Numbers or refer to the following introduction from IANA.

The port numbers are divided into three ranges: Well Known Ports, Registered Ports, and Dynamic and/or Private Ports.

- **Well Known Ports** range from 0 through 1023.
- **Registered Ports** range from 1024 through 49151.
- **Dynamic and/or Private Ports** range from 49152 through 65535.

The Well Known Ports are assigned by IANA, and on most systems, can only be used by system processes or by programs executed by privileged users. The following table shows famous port numbers among the well-known port numbers. For more details, please visit the IANA website at <http://www.iana.org/assignments/port-numbers>.

TCP Socket	Application Service
0	reserved
1	TCP Port Service Multiplexor
2	Management Utility
7	Echo
9	Discard
11	Active Users (sysstat)
13	Daytime
15	Netstat
20	FTP data port
21	FTP CONTROL port
23	Telnet
25	Simple Mail Transfer Protocol (SMTP)
37	Time (Time Server)
42	Host name server (names server)
43	Whois (nickname)
49	Login Host Protocol (Login)
53	Domain Name Server (domain)
79	Finger protocol (Finger)
80	World Wide Web HTTP
119	Network News Transfer Protocol (NNTP)
123	Network Time Protocol
213	IPX
160 to 223	Reserved for future use

UDP Socket	Application Service
0	reserved
2	Management Utility
7	Echo
9	Discard
11	Active Users (sysstat)
13	Daytime
35	Any private printer server
39	Resource Location Protocol
42	Host name server (names server)
43	Whois (nickname)
49	Login Host Protocol (Login)
53	Domain Name Server (domain)
69	Trivial Transfer Protocol (TFTP)
70	Gopher Protocol
79	Finger Protocol
80	World Wide Web HTTP
107	Remote Telnet Service
111	Sun Remote Procedure Call (Sunrpc)
119	Network News Transfer Protocol (NNTP)
123	Network Time Protocol (NTP)
161	(Simple Network Mail Protocol (SNMP)
162	SNMP Traps
213	IPX (Used for IP Tunneling)

Ethernet Modem Commands

A serial port on the NPort can be set to Ethernet Modem mode, allowing a PC or device to connect to the NPort as if it was an Ethernet modem. This section provides additional detail about how the NPort operates in Ethernet Modem mode.

Dial-in Operation

The NPort can listen for a TCP/IP connection request from a remote Ethernet modem or host. The NPort's response depends on the ATSO value, as follows.

ATSO=0: The NPort will temporarily accept the TCP connection and then send the **"RING"** signal out through the serial port. The serial controller must reply with **"ATA"** within 2.5 seconds to accept the connection request, after which the NPort enters data mode. If no **"ATA"** command is received, the NPort will disconnect after sending three **"RING"** signals.

ATSO≥1: The NPort will accept the TCP connection immediately. It will send the **"CONNECT {baudrate}"** command to the serial port and will immediately enter data mode.

Dial-out

The NPort accepts ATD commands such as **"ATD 192.168.1.1:4001"** from the serial port. It will then request a TCP connection from the specified remote Ethernet modem or PC. Once the remote unit accepts this TCP connection, the NPort will send the **"CONNECT {baudrate}"** command to the serial port and will immediately enter data mode.

Disconnection Request from Local Site

When the NPort is in data mode, you can initiate disconnection by sending **"+++"**. Some applications allow you to directly set the DTR signal to off, which will also initiate disconnection. The NPort will enter command mode, and you can then enter **"ATH"** to close the TCP connection **"NO CARRIER"** will be returned to the serial port.



ATTENTION

When entering **"+++"** to disconnect, the three **"+"** characters must be sent in quick succession, and the sequence must be prefaced and followed by a guard time to protect the raw data. You can change the disconnect character using register S2. You can set the guard time using register S12.

Disconnection Request from Remote Site

After the TCP connection has been closed by the remote Ethernet modem or PC, the NPort will send **"NO CARRIER"** to the serial port and will return to command mode.

AT Commands

Ethernet Modem mode supports the following common AT commands, as used with a typical modem:

No.	Command	Description	Remarks
1	ATA	Answer manually	
2	ATD	Dial up specified IP address and port number ATD 192.168.1.1:950 (example)	
3	ATE	ATE0=Echo OFF ATE1=Echo ON (default)	
4	ATH	ATH0=On-hook (default) ATH1=Off-hook	
5	ATI, ATIO, ATI1, ATI2	Modem version	reply "OK" only
6	ATL	Speaker volume option	reply "OK" only
7	ATM	Speaker control option	reply "OK" only
8	ATO	On line command	
9	ATP, ATT	Set Pulse/Tone Dialing mode	reply "OK" only
10	ATQ0, ATQ1	Quiet command (default=ATQ0)	
11	ATSr=n	Change the contents of S register	see "S registers"
12	ATSr?	Read the contents of S register	see "S registers"
13	ATV	Result code type ATV0 for digit code, ATV1 for text code (default) 0=OK 1=connect 2=ring 3=No carrier 4=error	
14	ATZ	Reset (disconnect, enter command mode and restore the flash settings)	
15	AT&C	Serial port DCD control AT&C0=DCD always on AT&C1=DTE detects connection by DCD on/off (default)	
16	AT&F	Restore manufacturer's settings	
17	AT&G	Select guard time	reply "OK" only
18	AT&R	Serial port RTS option command	reply "OK" only
19	AT&S	Serial port DSR control	reply "OK" only
20	AT&V	View settings	
21	AT&W	Write current settings to flash for next boot up	

S Registers

No.	Register	Description	Remarks
1	S0	Ring to auto-answer (default=0)	
2	S1	Ring counter (always=0)	no action applied
3	S2	Escape code character (default=43 ASCII "+")	
4	S3	Return character (default=13 ASCII)	
5	S4	Line feed character (default=10 ASCII)	
6	S5	Backspace character (default= 8 ASCII)	
7	S6	Wait time for dial tone (always=2, unit=sec)	no action applied
8	S7	Wait time for carrier (default=3, unit=sec)	
9	S8	Pause time for dial delay (always=2, unit=sec)	no action applied
10	S9	Carrier detect response time (always=6, unit 1/10 sec)	no action applied
11	S10	Delay for hang up after carrier (always=14, unit 1/10 sec)	no action applied
12	S11	DTMF duration and spacing (always=100 ms)	no action applied
13	S12	Escape code guard time (default=50, unit 1/50 sec) to control the idle time for "+++"	

Federal Communication Commission Interference Statement

This equipment has been tested and found to comply with the limits for a Class B digital device, pursuant to Part 15 of the FCC Rules. These limits are designed to provide reasonable protection against harmful interference in a residential installation. This equipment generates, uses and can radiate radio frequency energy and, if not installed and used in accordance with the instructions, may cause harmful interference to radio communications. However, there is no guarantee that interference will not occur in a particular installation. If this equipment does cause harmful interference to radio or television reception, which can be determined by turning the equipment off and on, the user is encouraged to try to correct the interference by one or more of the following measures:

- Reorient or relocate the receiving antenna.
- Increase the separation between the equipment and receiver.
- Connect the equipment into an outlet on a circuit different from that to which the receiver is connected.
- Consult the dealer or an experienced radio/TV technician for help.

CAUTION:

Any changes or modifications not expressly approved by the grantee of this device could void the user's authority to operate the equipment.

FCC RF Radiation Exposure Statement

This equipment complies with FCC RF radiation exposure limits set forth for an uncontrolled environment. This equipment should be installed and operated with a minimum distance of 20cm between the radiator and your body.

This device complies with Part 15 of the FCC Rules. Operation is subject to the following two conditions:

1. This device may not cause harmful interference and
2. This device must accept any interference received, including interference that may cause undesired operation.

Labeling requirements

This device complies with Part 15 of the FCC Rules. Operation is subject to the following two conditions: (1) this device may not cause harmful interference, and (2) this device must accept any interference received, including interference that may cause undesired operation.

RF exposure warning

This equipment must be installed and operated in accordance with provided instructions and the antenna(s) used for this transmitter must be installed to provide a separation distance of at least 20 cm from all persons and must not be co-located or operating in conjunction with any other antenna or transmitter. End-users and installers must be provide with antenna installation instructions and transmitter operating conditions for satisfying RF exposure compliance.

End Product Labeling

This transmitter module is authorized only for use in device where the antenna may be installed such that 20cm may be maintained between the antenna and users. The final end product must be labeled in a visible area with the following: "Contains FCC ID: SLE-W2X50A "

Information for the OEMs and Integrators

The following statement must be included with all versions of this document supplied to an OEM or integrator, but should not be distributed to the end user.

1. This device is intended for OEM integrators only.
2. Please see the full Grant of Equipment document for other restrictions.

This radio transmitter FCCID: SLE-W2X50A has been approved by FCC to operate with the antenna types listed below with the maximum permissible gain and required antenna impedance for each antenna type indicated. Antenna types not included in this list, having a gain greater than the maximum gain indicated for that type, are strictly prohibited for use with this device.

Antenna List

No.	Manufacturer	Model No.	Antenna Type	Peak Gain
1	KINSUN	ANT-WDB-ARM-02	Dipole Antenna	1.21 dBi for 2.4GHz 1.73 dBi for 5GHz

Note: The antenna connector is Reverse SMA type.

FCC Warning Statement

This device complies with Part 15 of the FCC Rules. Operation is subject to the following two conditions:

1. This device may not cause harmful interference, and
2. This device must accept any interference received, including interference that may cause undesired operation.

This equipment has been tested and found to comply with the limits for a class B digital device, pursuant to part 15 of the FCC Rules. These limits are designed to provide reasonable protection against harmful interference in a residential installation.

This equipment generates, uses, and can radiate radio frequency energy, and if not installed and used in accordance with the instructions, may cause harmful interference to radio communications. However, there is no guarantee that interference will not occur in a particular installation. If this equipment does cause harmful interference to radio or television reception, which can be determined by turning the equipment off and on, the user is encouraged to try to correct the interference by one or more of the following measures:

- Reorient or relocate the receiving antenna.
- Increase the separation between the equipment and receiver.
- Connect the equipment into an outlet on a circuit different from that to which the receiver is connected.
- Consult the dealer or an experienced radio/TV technician for help.

CAUTION:

Any changes or modifications not expressly approved by the party responsible for compliance could void the user's authority to operate the equipment. The operation frequency of the device is in the 5150-5250 MHz band and is for indoor use only.

Prohibition of Co-location

This device and its antenna(s) must not be co-located or operating in conjunction with any other antenna or transmitter.

Safety Information

To maintain compliance with FCC's RF exposure guidelines, when installing and/or operating this equipment, you should maintain a minimum distance of 20 cm between the transmitter and your body. Use only the supplied antenna. Unauthorized antennae, modifications, or attachments could damage the transmitter and may violate FCC regulations.