

V2406/2422/2426 Hardware User's Manual

Second Edition, March 2011

www.moxa.com/product

MOXA[®]

© 2011 Moxa Inc., All rights reserved.

V2406/2422/2426 Hardware User's Manual

The software described in this manual is furnished under a license agreement and may be used only in accordance with the terms of that agreement.

Copyright Notice

© 2011 Moxa Inc., All rights reserved.

Trademarks

The MOXA logo is a registered trademark of Moxa Inc.
All other trademarks or registered marks in this manual belong to their respective manufacturers.

Disclaimer

Information in this document is subject to change without notice and does not represent a commitment on the part of Moxa.

Moxa provides this document as is, without warranty of any kind, either expressed or implied, including, but not limited to, its particular purpose. Moxa reserves the right to make improvements and/or changes to this manual, or to the products and/or the programs described in this manual, at any time.

Information provided in this manual is intended to be accurate and reliable. However, Moxa assumes no responsibility for its use, or for any infringements on the rights of third parties that may result from its use.

This product might include unintentional technical or typographical errors. Changes are periodically made to the information herein to correct such errors, and these changes are incorporated into new editions of the publication.

Technical Support Contact Information

www.moxa.com/support

Moxa Americas

Toll-free: 1-888-669-2872

Tel: +1-714-528-6777

Fax: +1-714-528-6778

Moxa Europe

Tel: +49-89-3 70 03 99-0

Fax: +49-89-3 70 03 99-99

Moxa China (Shanghai office)

Toll-free: 800-820-5036

Tel: +86-21-5258-9955

Fax: +86-10-6872-3958

Moxa Asia-Pacific

Tel: +886-2-8919-1230

Fax: +886-2-8919-1231

Table of Contents

1. Introduction	1-1
Overview	1-2
Package Checklist	1-2
Product Features	1-2
V2406/2422/2426 Hardware Specifications	1-3
Hardware Block Diagram	1-5
2. Hardware Introduction	2-1
Appearance.....	2-2
V2406.....	2-2
V2422.....	2-2
V2426.....	2-3
Dimensions.....	2-3
V2406.....	2-3
V2422.....	2-4
V2426.....	2-4
LED Indicators.....	2-4
Reset Button	2-5
Real Time Clock.....	2-5
3. Hardware Connection Description	3-1
Installing the V2406/2422/2426	3-2
Wiring Requirements.....	3-4
Connecting the Power	3-4
Grounding the Unit	3-4
Connecting Data Transmission Cables	3-4
Connecting to the Network	3-5
Connecting to a Serial Device	3-5
Installing a CompactFlash Card	3-6
Connecting a PS/2 Keyboard and Mouse.....	3-7
Connecting to a USB Device.....	3-7
V2406.....	3-8
V2426.....	3-8
V2422.....	3-9
DI/DO	3-9
V2406/2426	3-9
V2422.....	3-10
Connecting to a VGA Monitor.....	3-10
Connecting to a DVI-I Monitor	3-11
Connecting to a Speaker or a Headphone	3-11
Inserting Expansion Modules	3-12
Upgrading the Memory Module	3-13
Upgrading the DOM Module.....	3-15
Installing a SATA Hard Disk	3-15
Adjusting COM1 PIN 9 Voltage.....	3-18
4. BIOS Setup	4-1
Entering the BIOS Setup Utility	4-2
Modifying the BIOS Main Settings	4-2
Basic Configuration.....	4-2
System Security.....	4-3
Advanced Settings	4-3
Hard Disk Boot Priority.....	4-4
Advanced BIOS Features	4-4
CPU Features	4-4
C1E Function	4-4
EIST Function.....	4-4
Hyper-Threading Technology	4-4
Quick Power On Self Test	4-5
Summary Screen Show.....	4-5
Advanced Chipset Settings	4-5
On-chip Frame Buffer Size	4-5
DVMT Mode.....	4-5
DVMT/FIXED Memory Size	4-5
Boot Display.....	4-6
LVDS Function	4-6
Peripherals.....	4-6
OnChip IDE Device	4-6
On-Chip Channel 0 PCI IDE.....	4-6
IDE Channel 0 Master UDMA	4-7

IDE Channel 0 Slave UDMA	4-7
On-Chip Channel 1 PCI IDE	4-7
IDE Channel 1 Master UDMA	4-7
IDE Channel 1 Slave UDMA	4-7
Onboard Device	4-7
Onboard Audio	4-7
Onboard LAN Boot ROM	4-8
Super I/O Device	4-8
Debug Port	4-8
Power on After Power Fail	4-8
Power	4-8
ACPI Suspend Type	4-9
Soft-Off by PWR-BTTN	4-9
Hardware Monitor	4-9
CPU Warning Temperature	4-9
Warning Beep	4-9
Load Defaults	4-10
Load System Default Settings	4-10
Load System Turbo Settings	4-10
Load CMOS from BIOS	4-10
Save CMOS to BIOS	4-10
Exiting the BIOS Setup	4-10
Save & Exit Setup	4-11
Exit Without Saving	4-11
Upgrading the BIOS	4-11
A. Regulatory Approval Statement	A-1

Introduction

The V2406/2422/2426 embedded computers are based on the Intel Atom N270 x86 processor, and feature four RS-232/422/485 serial ports, dual 10/100 Mbps (10/100/1000 Mbps for V2422) LAN ports, 3 USB 2.0 hosts (6 for V2422), and a CompactFlash socket. The V2406/2422/2426 computers provide VGA, DVI-I outputs, and digital input/output channels, making them particularly well-suited for industrial applications such as SCADA and manufacturing automation.

In addition, the CompactFlash and USB sockets provide the V2406/2422/2426 computers with the reliability needed for industrial applications that require data buffering and storage expansion.

The V2422 and V2426 computers come with 2 peripheral expansion slots for inserting different communication modules, such as a 2-port CAN module, an HSDPA, GPS, WLAN module, an 8+8 port digital input/output module, a 2-port serial module, a mini PCI expansion module, and a PCI Express module, providing greater flexibility for setting up different industrial applications at field sites.

Pre-installed with Linux or Windows Embedded Standard 2009, the V2406/2422/2426 computers provides programmers with a friendly environment for developing sophisticated, bug-free application software at a low cost.

The following topics are covered in this chapter:

- **Overview**
- **Package Checklist**
- **Product Features**
- **V2406/2422/2426 Hardware Specifications**
- **Hardware Block Diagram**

Overview

The V2406/2422/2426 computers come with 4 RS-232/422/485 serial ports, making them ideal for connecting a wide range of serial devices, and the dual 10/100 Mbps Ethernet ports offer a reliable solution for network redundancy, promising continuous operation for data communication and management. As an added convenience, the V2406/2422/2426 computers have 6 DIs, and 2 DOs for connecting digital input/output devices.

In addition, the CompactFlash and USB sockets provide the V2406/2422/2426 computers with the reliability needed for industrial applications that require data buffering and storage expansion.

Pre-installed with Linux or Windows Embedded Standard 2009, the V2406/2422/2426 computers provide programmers with a friendly environment for developing sophisticated, bug-free application software at a low cost.

Package Checklist

Each model is shipped with the following items:

- 1 V2406/2422/2426 embedded computer
- Terminal block to power jack converter (V2422 only)
- PS2 to KB/MS Y-type cable
- Documentation and software CD or DVD
- Quick installation guide (printed)
- Warranty card

NOTE: Please notify your sales representative if any of the above items are missing or damaged.

Product Features

V2406/2422/2426 embedded computers have the following features:

- DDR2 SODIMM socket, supporting DDR2 533 up to 2 GB (max.)
- Dual independent display (VGA, DVI-I selectable)
- 2 10/100 Mbps Ethernet ports with M12 connector (V2406/2426)
- 2 10/100/1000 Mbps Ethernet ports with RJ45 connector (V2422)
- 4 RS-232/422/485 serial ports, supporting non-standard baudrates
- 3 USB 2.0 ports (6 for V2422) for high speed peripherals
- 6 DIs, 2 DOs (V2406/2426)
- 4 DIs, 4 DOs (V2422)
- CompactFlash socket for storage expansion
- Ready-to-run Linux or Windows Embedded Standard 2009 platform

V2406/2422/2426 Hardware Specifications

Computer

CPU: Intel Atom N270 1.6 GHz processor

OS (pre-installed): Linux or Windows Embedded Standard 2009

System Chipset: Intel 945GSE + ICH7-M

BIOS: 8 Mbit Flash BIOS, PLCC type, ACPI function supported

FSB: 533 MHz

System Memory: 1 x 200-pin DDR2 SODIMM socket, supporting DDR2 533 up to 2 GB with 1 GB built in

USB: USB 2.0 compliant hosts

V2406/2426:

- 2 w/ type A connectors, supporting system boot up
- 1 w/ M12 connector

V2422: 6 w/ type A connector, supporting system boot up

Storage

Built-in: 2 GB onboard industrial DOM to store OS

Storage Expansion: CompactFlash socket for CF card expansion, supporting CF Type-I/II

HDD Support: 1 SATA-150 connector for HDD expansion

Other Peripherals

KB/MS: 1 PS/2 interface supporting standard PS/2 keyboard and mouse through Y-type cable

Audio: Line-in, line-out interface

Display

Graphics Controller: Intel Gen 3.5 Integrated Graphics Engine, 250 MHz core render clock and 200 MHz core display clock at 1.05-V core voltage

VGA Interface: DB15 female connector, up to 2048 x 1536 resolution

DVI Interface: DVI-I connector (chrontel CH7307 SDVO to DVI transmitter), up to 1600 x 1200 resolution

Ethernet Interface

LAN:

V2406/V2426: 2 auto-sensing 10/100 Mbps ports (M12)

V2422: 2 auto-sensing 10/100/1000 Mbps ports (RJ45)

Serial Interface

Serial Standards:

4 RS-232/422/485 ports*, software selectable (DB9 male)

* COM1 pin 9 signal can be selected as N/C (default), +5 V, or +12 V by jumper

ESD Protection: 8 KV for all signals

Serial Communication Parameters

Data Bits: 5, 6, 7, 8

Stop Bits: 1, 1.5, 2

Parity: None, Even, Odd, Space, Mark

Flow Control: RTS/CTS, XON/XOFF, ADDC® (automatic data direction control) for RS-485

Baudrate: 50 bps to 921.6 Kbps (non-standard baudrates supported; see user's manual for details)

Serial Signals

RS-232: TxD, RxD, DTR, DSR, RTS, CTS, DCD, GND

RS-422: TxD+, TxD-, RxD+, RxD-, GND

RS-485-4w: TxD+, TxD-, RxD+, RxD-, GND

RS-485-2w: Data+, Data-, GND

Digital Input

Input Channels: 6 (V2406/V2426) or 4 (V2422), source type

Input Voltage: 0 to 30 VDC at 25 KHz

Digital Input Levels for Dry Contacts:

- Logic level 0: Close to GND
- Logic level 1: Open

Digital Input Levels for Wet Contacts:

- Logic level 0: +3 V max.
- Logic level 1: +10 V to +30 V (Source to DI)

Isolation: 3 KV optical isolation

Digital Output

Output Channels: 2 (V2406/V2426) or 4 (V2422), sink type

Output Current: Max. 200 mA per channel

On-state Voltage: 24 VDC nominal, open collector to 30 VDC

Connector Type: 10-pin screw terminal block

V2406/2426: 6 DI points, 2 DO points, DI Source, GND

V2422: 4 DI points, 4 DO points, DI Source, GND

Isolation: 3 KV optical isolation

LEDs

System: Power, Storage

LAN: 10M/Link x 2, 100M/Link x 2, 1000M?Link x 2 (V2422)

Serial: TX x 4, RX x 4

Switches and Buttons

Power Switch: on/off (front panel)

Reset Button: For warm reboot (front panel)

Physical Characteristics

Housing: Aluminum

Weight:

V2406: 2 kg

V2422/V2426: 4 kg

Dimensions:

V2406:

Without ears: 250 x 57 x 154 mm (9.84 x 2.24 x 6.06 in)

With ears: 275 x 63 x 154 mm (10.83 x 2.48 x 6.06 in)

V2422/2426:

Without ears: 250 x 86 x 154 mm (9.84 x 3.39 x 6.06 in)

With ears: 275 x 92 x 154 mm (10.83 x 3.62 x 6.06 in)

Mounting: DIN-Rail, wall, VESA

Environmental Limits

Operating Temperature:

Standard models: -10 to 60°C (14 to 140°F)

Wide temp. models: -40 to 70°C (-40 to 158°F)

Storage Temperature:

Standard models: -20 to 80°C (-4 to 176°F)

Wide temp. models: -40 to 85°C (-40 to 185°F)

Ambient Relative Humidity: 5 to 95% (non-condensing)

Anti-vibration: EN50155 standard

Anti-shock: EN50155 standard

Power Requirements

Input Voltage:

V2406/2426: 12 to 48 VDC (M12 connector)

V2422: 9 to 36 VDC (3-pin terminal block for V+, V-, SG)

Power Consumption: 48 W

- V2406: 26 W
 - 2.16 A @ 12 VDC
 - 1.08 A @ 24 VDC
 - 542 mA @ 48 VDC
- V2422/2426: 48 W
 - 4 A @ 12 VDC
 - 2 A @ 24 VDC
 - 1.3 A @ 36 VDC
 - 1 A @ 48 VDC

Standards and Certifications

Safety: UL 508, UL 60950-1, CSA C22.2 No. 60950-1-07, EN 60950-1, CCC (GB9254, GB17625.1)
EMC: EN 55022 Class A, EN 61000-3-2 Class D, EN 61000-3-3, EN 55024, FCC Part 15 Subpart B Class A
Wheeled Vehicles: e Mark (V2422 only)
Rail Traffic: EN 50155
Green Product: RoHS, CRoHS, WEEE

Reliability

Automatic Reboot Trigger: Built-in WDT (watchdog timer) supporting 1-255 level time interval system reset, software programmable

Warranty

Warranty Period: 3 years
Details: See www.moxa.com/warranty

Hardware Block Diagram

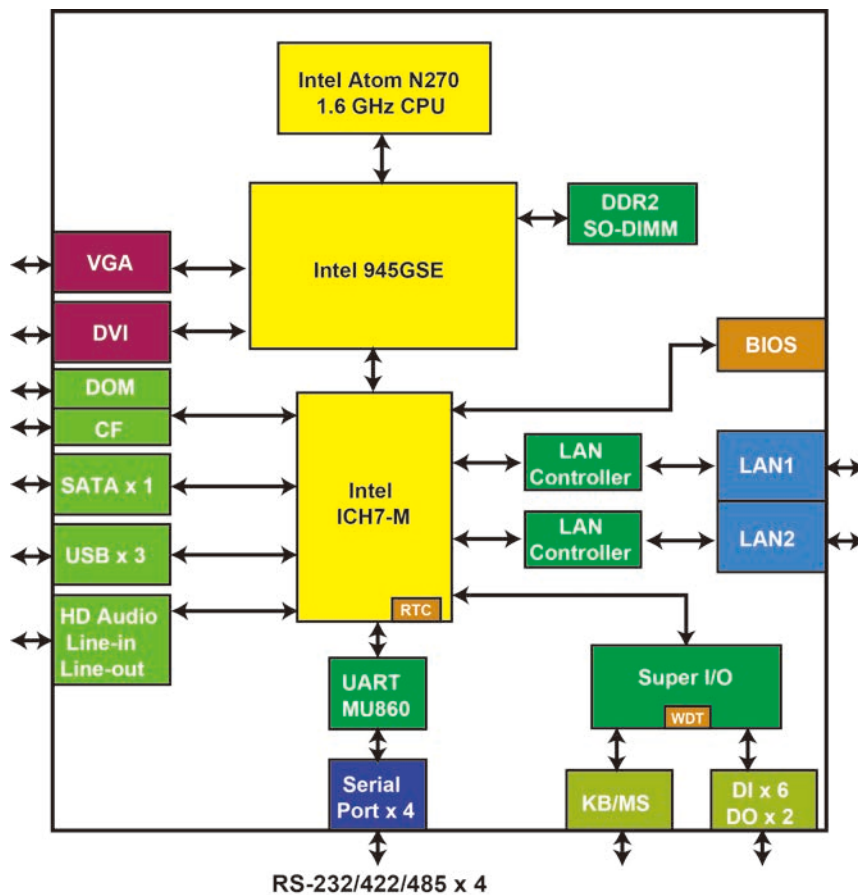

Hardware Introduction

The V2406/2422/2426 series embedded computers are compact, well-designed, and built rugged enough for industrial applications. LED indicators help you monitor performance and identify trouble spots, multiple serial ports allow you to connect different devices for wireless operation, and the reliable and stable hardware platform lets you devote your attention to developing your applications.

The following topics are covered in this chapter:

▣ **Appearance**

- V2406
- V2422
- V2426

▣ **Dimensions**

- V2406
- V2422
- V2426

▣ **LED Indicators**

▣ **Reset Button**

▣ **Real Time Clock**

Appearance

V2406

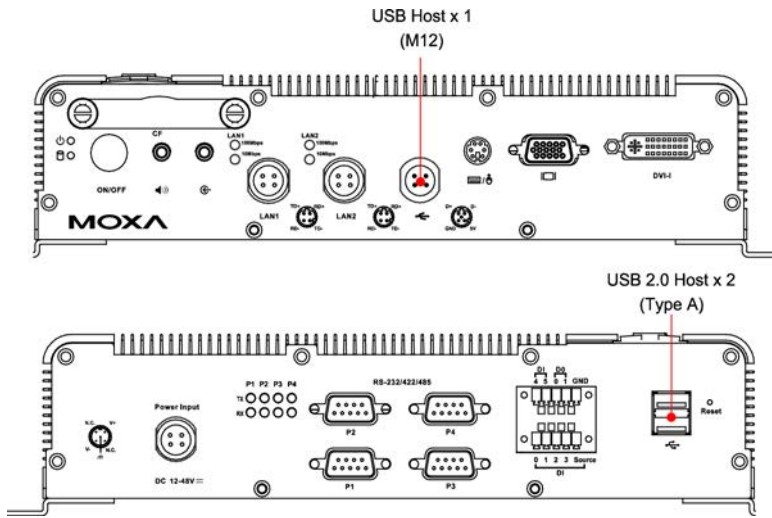

V2422

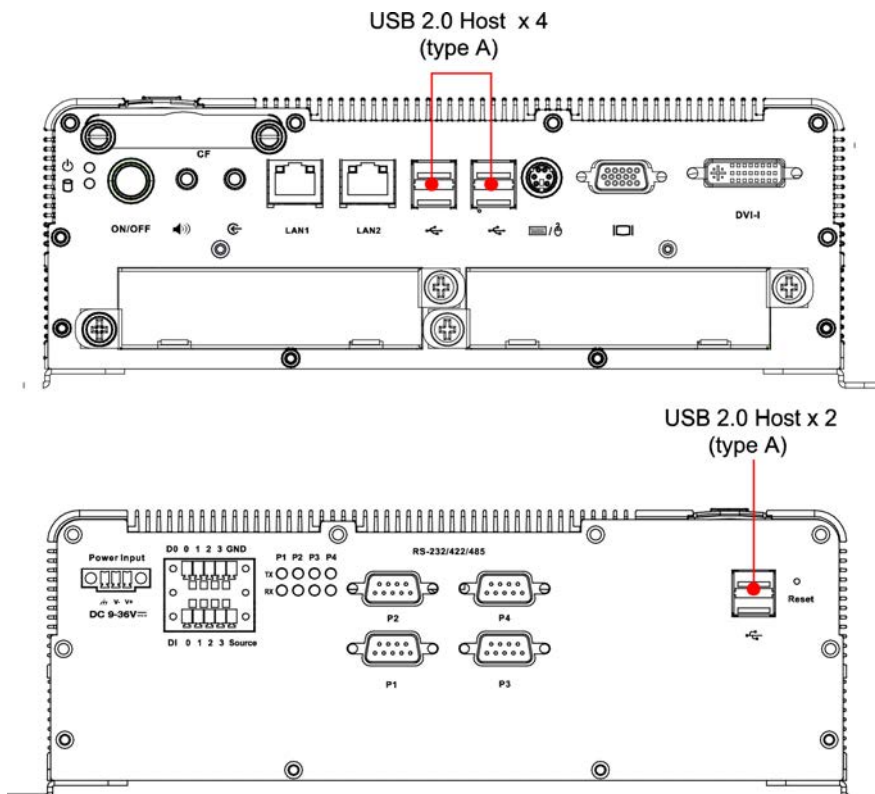

V2426

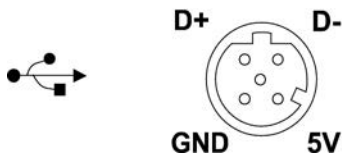
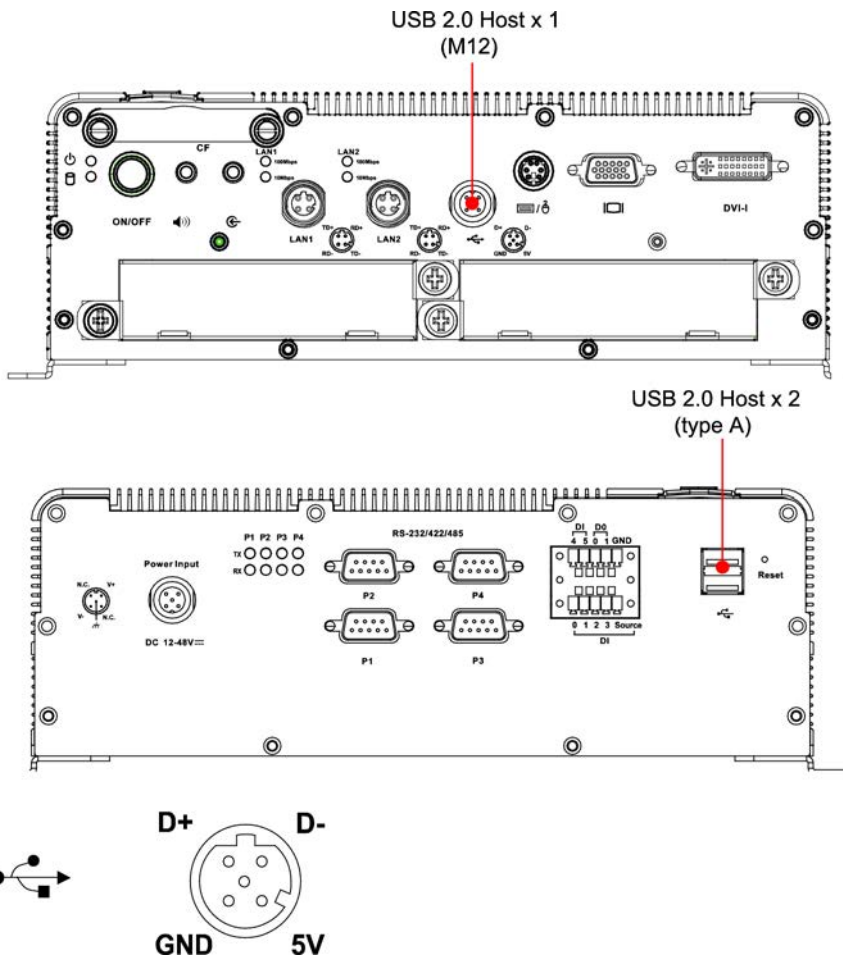

Dimensions

V2406

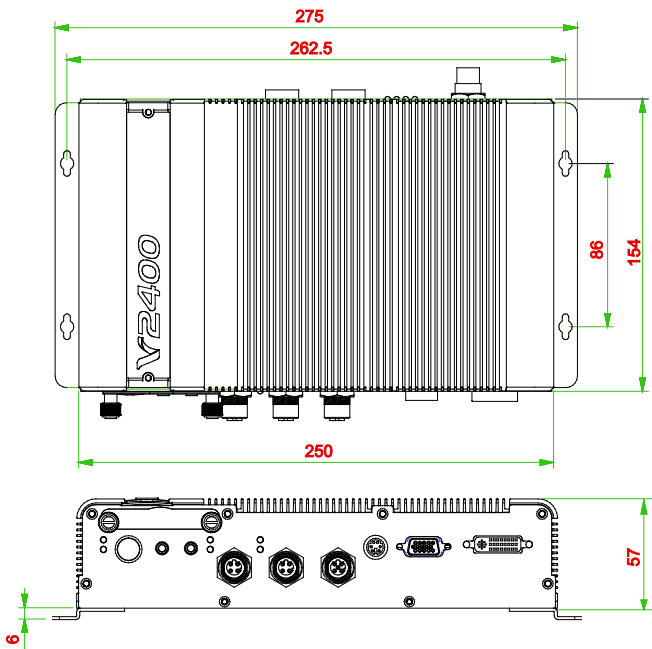

V2422

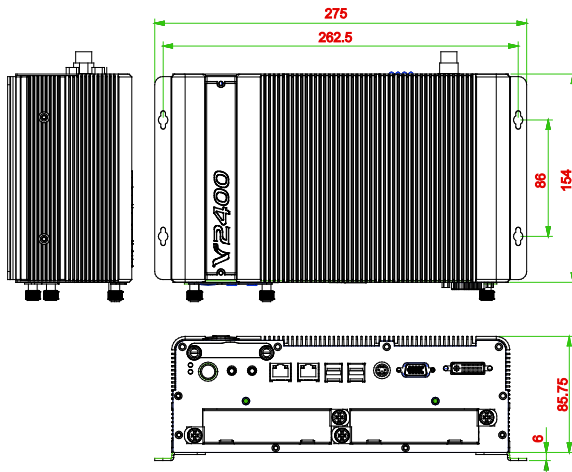

V2426

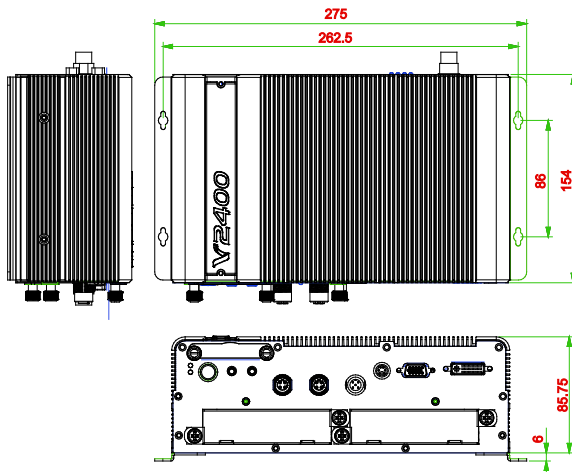

LED Indicators

LED Name	LED Color	LED Function
Power	Green	Power is on and functioning normally
	Off	Power is off or a power error exists
Storage	Yellow	CF card is detected
	Off	CF card is not detected
LAN (1, 2)	Green	10 Mbps Ethernet mode (100 Mbps for V2422)
	Yellow	100 Mbps Ethernet mode (1000 Mbps for V2422)
	Off	No activity
Tx1 to Tx4 (P1-P4)	Green	Serial ports P1-P4 transmitting data
	Off	Serial ports P1-P4 not transmitting data
Rx1 to Rx4 (P1-P4)	Yellow	Serial ports P1-P4 receiving data
	Off	Serial ports P1-P4 not receiving data

Reset Button

Press the **Reset Button** on the rear panel of the V2406/2422/2426 to reboot the system automatically. The Ready LED will blink on and off for the first 5 seconds, and then maintain a steady glow once the system has rebooted.

The V2406/2422/2426 does not support a "Reset to Default" function.

Real Time Clock

The embedded computer's real-time clock is powered by a lithium battery. We strongly recommend that you **NOT** replace the lithium battery on your own. If the battery needs to be changed, please contact the Moxa RMA service team.



ATTENTION

There is a risk of explosion if the wrong type of battery is used. To avoid this potential danger, always be sure to use the correct type of battery. Contact the Moxa RMA service team if you need to replace your battery.

Caution

There is a risk of explosion if the battery is replaced by an incorrect type. Dispose of used batteries according to the instructions on the battery.

Hardware Connection Description

In this chapter, we show how to connect the embedded computers to the network and to various devices.

The following topics are covered in this chapter:

- ❑ **Installing the V2406/2422/2426**
- ❑ **Wiring Requirements**
 - Connecting the Power
 - Grounding the Unit
- ❑ **Connecting Data Transmission Cables**
 - Connecting to the Network
 - Connecting to a Serial Device
- ❑ **Installing a CompactFlash Card**
- ❑ **Connecting a PS/2 Keyboard and Mouse**
- ❑ **Connecting to a USB Device**
 - V2406
 - V2426
 - V2422
- ❑ **DI/DO**
 - V2406/2426
 - V2422
- ❑ **Connecting to a VGA Monitor**
- ❑ **Connecting to a DVI-I Monitor**
- ❑ **Connecting to a Speaker or a Headphone**
- ❑ **Inserting Expansion Modules**
- ❑ **Upgrading the Memory Module**
- ❑ **Upgrading the DOM Module**
- ❑ **Installing a SATA Hard Disk**
- ❑ **Adjusting COM1 PIN 9 Voltage**

Installing the V2406/2422/2426

Wall or Cabinet Mounting

The V2406/2422/2426 comes with two metal brackets for attaching it to a wall or the inside of a cabinet.

Step 1: Use two screws for each bracket and attach the bracket to the rear of the V2406/2422/2426.

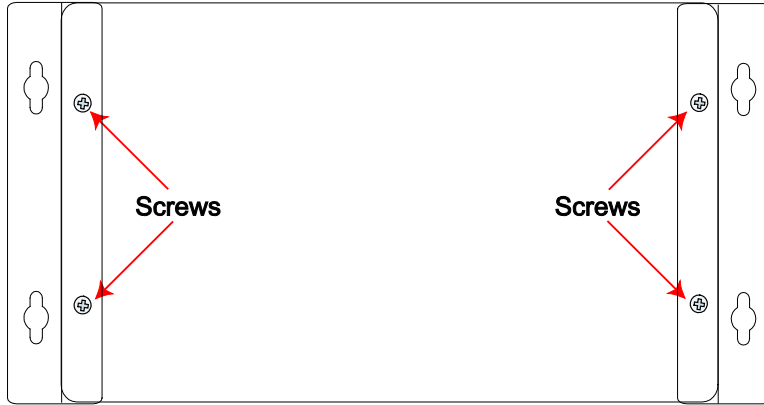

Step 2: Use two screws per side to attach the V2406/2422/2426 to a wall or cabinet.

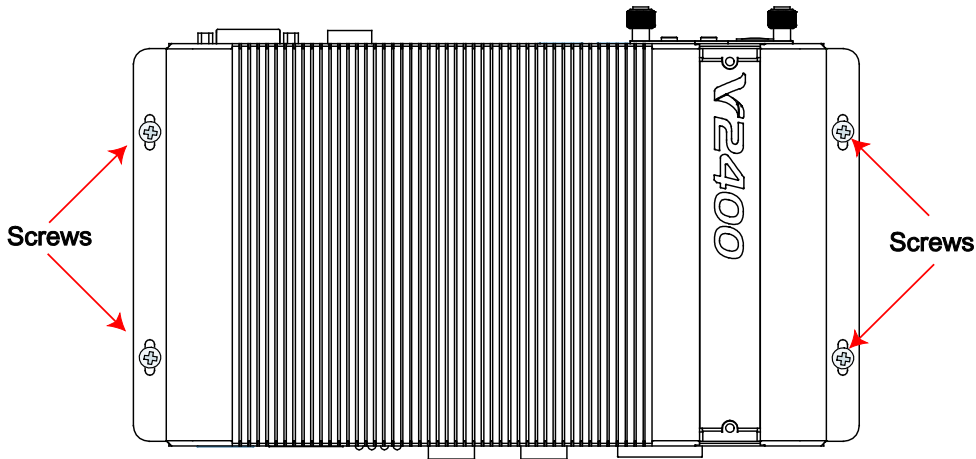

Din-Rail Mounting

The V2406/2422/2426 can be installed on a DIN-rail with the optional DIN-rail kit. This DIN-rail kit must be purchased separately. It includes two DIN-rail brackets and eight screws.



To attach the DIN-rail kit, turn the V2406/2422/2426 over to the bottom cover. Find the locations for the screws and place the brackets on the cover. Please note that all eight screws must be firmly attached so that the computer can be securely installed on the DIN-rail.

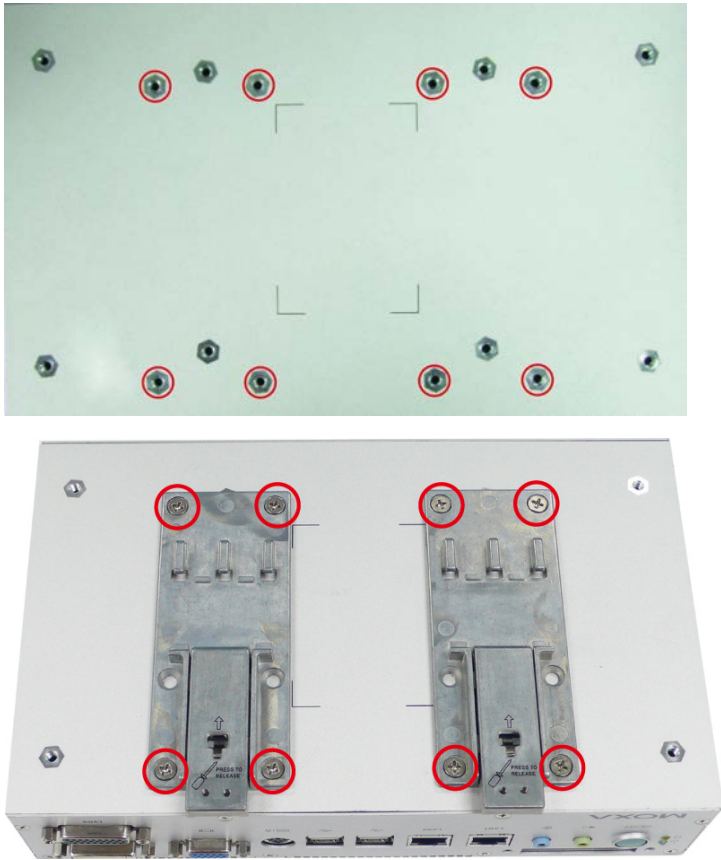

When the brackets are firmly attached with the screws, it can be installed on a DIN-rail

To release the DIN-rail kit, simply use a screwdriver to push down the lower part. Please use at least two persons to do this step as once the DIN-rail kit is pushed down, the computer will be detached immediately from the DIN-rail.

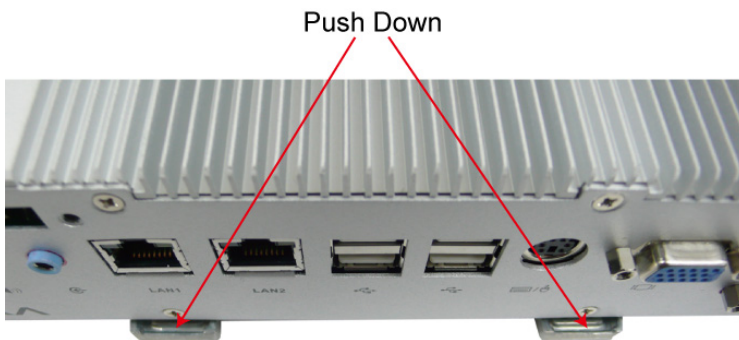

To re-install the computer on the DIN-rail, use a screwdriver to press the buckle so that it can be released. Now, it can be re-installed on the DIN-rail.



Wiring Requirements

This section describes how to connect serial devices to the embedded computer.

You should read and follow these common safety precautions before proceeding with the installation of any electronic device:

- Use separate paths to route wiring for power and devices. If power wiring and device wiring paths must cross, make sure the wires are perpendicular at the intersection point.

NOTE: Do not run signal or communication wiring together with power wiring in the same wire conduit. To avoid interference, wires with different signal characteristics should be routed separately.

- Use the type of signal transmitted through a wire to determine which wires should be kept separate. The rule of thumb is that wiring that shares similar electrical characteristics can be bundled together.
- Keep input wiring and output wiring separate.
- It is advisable to label the wiring to all devices in the system.



ATTENTION

Safety First!

Be sure to disconnect the power cord before installing and/or wiring your V2406/2422/2426.

Wiring Caution!

Calculate the maximum possible current in each power wire and common wire. Observe all electrical codes dictating the maximum current allowable for each wire size.

If the current goes above the maximum ratings, the wiring could overheat, causing serious damage to your equipment.

Temperature Caution!

Be careful when handling the unit. When the unit is plugged in, the internal components generate heat, and consequently the outer casing may feel hot to the touch.

Connecting the Power

The PC's power source should be provided by a UL listed class 2 or "Limited Power Source" (LPS), with external adaptor output rated 12 to 48 VDC (9 to 36 VDC for V2422) , . If the power is supplied properly, the "Ready" LED will glow a solid green after a 25 to 30 second delay.

Grounding the Unit

Grounding and wire routing help limit the effects of noise due to electromagnetic interference (EMI). Before connecting any devices, run a ground wire from the ground screw to the grounding surface.

Connecting Data Transmission Cables

This section describes how to connect the V2406/2422/2426 embedded computers to the network and serial devices.

Connecting to the Network

V2406/2426

Plug your network cable into the embedded computer's Ethernet port. The other end of the cable should be plugged into your Ethernet network. When the cable is properly connected, the LEDs on the embedded computer's Ethernet port will glow to indicate a valid connection.

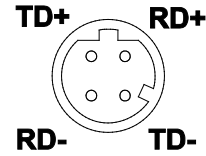

Two 10/100 Mbps Ethernet ports using M12 connectors are located on the front panel. See the figure at the right for pin assignments.

V2422

Two 10/100/1000 Mbps Ethernet ports using RJ45 connectors are located on the front panel. See the table at the right for pin assignments.

PIN	10/100 Mbps	10/100/1000 Mbps
1	ETx+	TRD(0)+
2	ETx-	TRD(0)-
3	ERx+	TRD(1)+
4		TRD(2)+
5		TRD(2)-
6	ERx-	TRD(1)-
7		TRD(3)-
8		TRD(3)+

Connecting to a Serial Device

Use a serial cable to plug your serial device into the embedded computer's serial port. Serial ports P1 to P4 have male DB9 connectors and can be configured for RS-232, RS-422, or RS-485 communication by software. The pin assignments are shown in the following table:

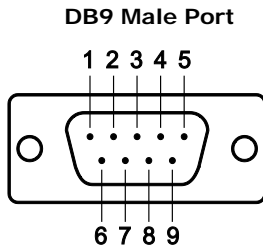

RS-232/422/485 Pinouts

Pin	RS-232	RS-422	RS-485-4W	RS-485-2W
1	DCD	TxDA(-)	TxDA(-)	-
2	RxD	TxDB(+)	TxDB(+)	-
3	TxD	RxDB(+)	RxDB(+)	DataB(+)
4	DTR	RxDA(-)	RxDA(-)	DataA(-)
5	GND	GND	GND	GND
6	DSR	-	-	-
7	RTS	-	-	-
8	CTS	-	-	-

Installing a CompactFlash Card

The V2406/2422/2426 embedded computers come with a CompactFlash socket. To insert a CompactFlash card, follow these instructions:

1. Disconnect the V2406/2422/2426 from its power source.
2. The CompactFlash socket is located on the left side of the front panel. Unscrew the CompactFlash socket cover.



Screws

3. There is a tenon/hook on the cover of the CF socket. Turn the CompactFlash card over and then insert the CompactFlash card into the tenon/hook of the CF socket cover.



Put CF Card into tenon/hook of CF socket



ATTENTION

Be careful of how you orient the CompactFlash card. You should turn the CF card bottom side up, in order to hook CF card into the CF socket cover.

4. Gently insert the CompactFlash card into the CF socket, making sure that the card is oriented correctly.



ATTENTION

The V2406/2422/2426 embedded computer does not support the CompactFlash hot swap and PnP (Plug and Play) functions. It is necessary to remove power source first before inserting or removing the CompactFlash card.

Connecting a PS/2 Keyboard and Mouse

Your V2406/2422/2426 embedded computers come with a PS/2 mini-DIN connector to connect to a PS/2 keyboard and PS/2 mouse. This 6-pin mini-DIN connector has the pin assignments shown below.

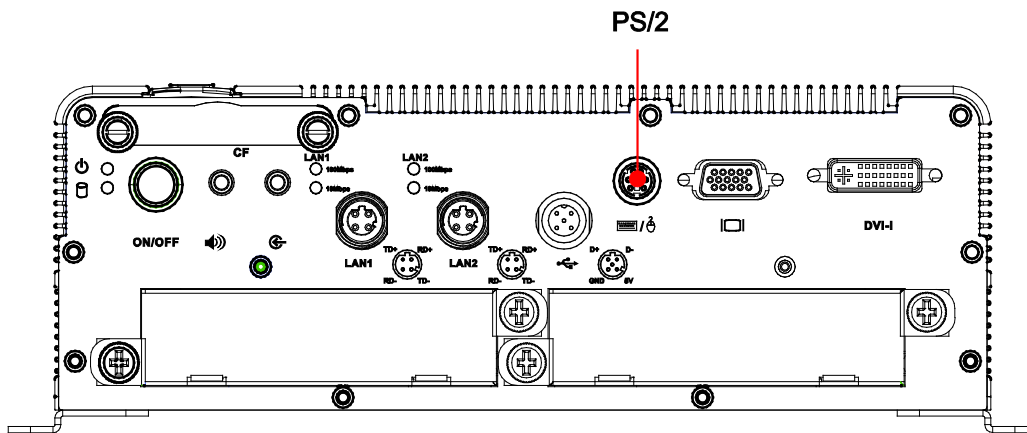

PS/2 Connector

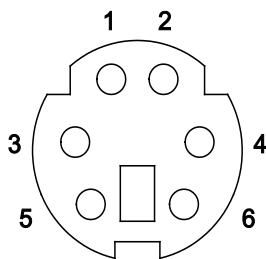

Pin No.	Signal Definition
1	PS/2 Keyboard Data
2	PS/2 Mouse Data
3	GND
4	VCC
5	PS/2 Keyboard Clock
6	PS/2 Mouse Clock

Use the Y-type cable to convert the mini-DIN connector into two 6-pin mini-DIN connectors to connect both a PS/2 keyboard and PS/2 mouse at the same time. You may also use the USB ports to connect your USB-based keyboard and mouse.



ATTENTION

Without a Y-type cable, the PS/2 connector on the V2406/2422/2426 can only work with a PS/2 keyboard. A PS/2 mouse will not function when directly connected to the PS/2 connector on the V2406/2422/2426 embedded computers.

Connecting to a USB Device

The V2406/2426 comes with 1 USB 2.0 host with M12 connectors on the front panel, and 2 USB 2.0 host with type A connector on the rear panel; the V2422 comes with 4 USB 2.0 hosts on the front panel and 2 USB 2.0 hosts on the rear panel, all with type A connector. The hosts can be used for an external flash disk or hard drive for storing large amounts of data. You can also use these USB hosts to connect to a keyboard or a mouse. See the following figures for the locations of the USB ports and the M12 connector pin assignment.

V2406

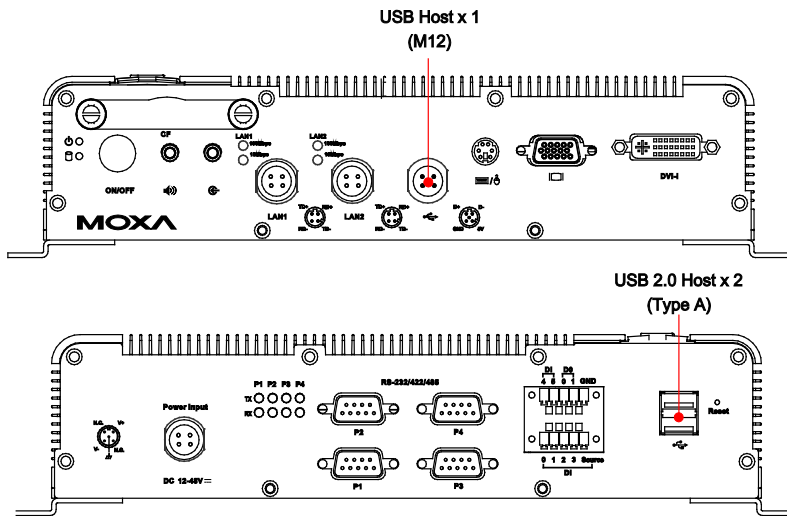

V2426

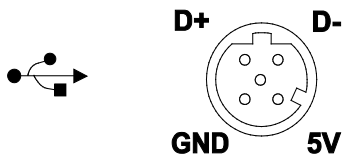
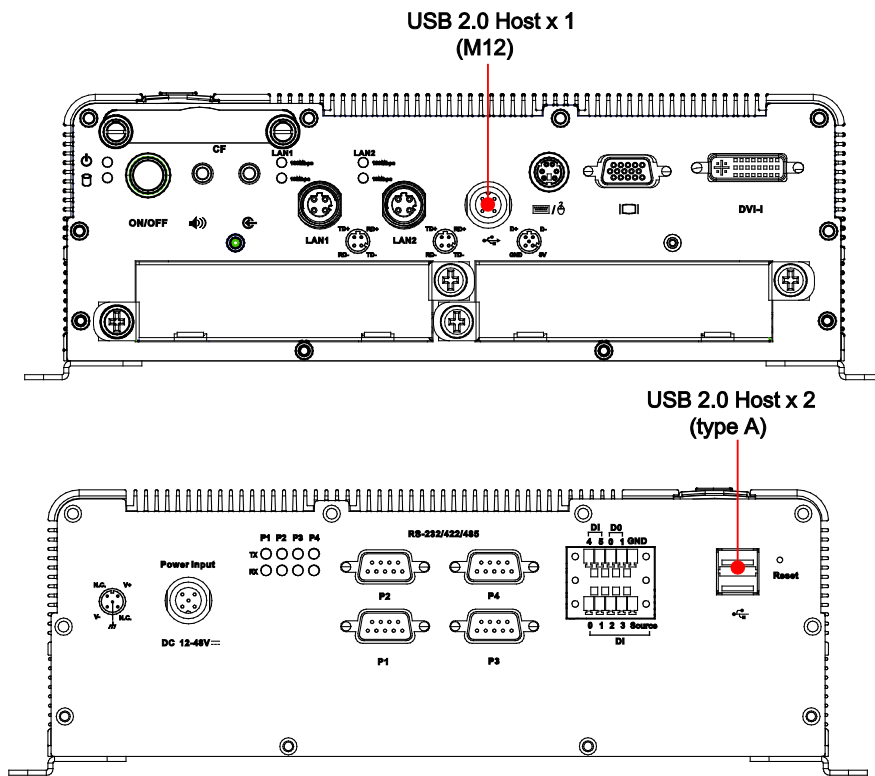

V2422

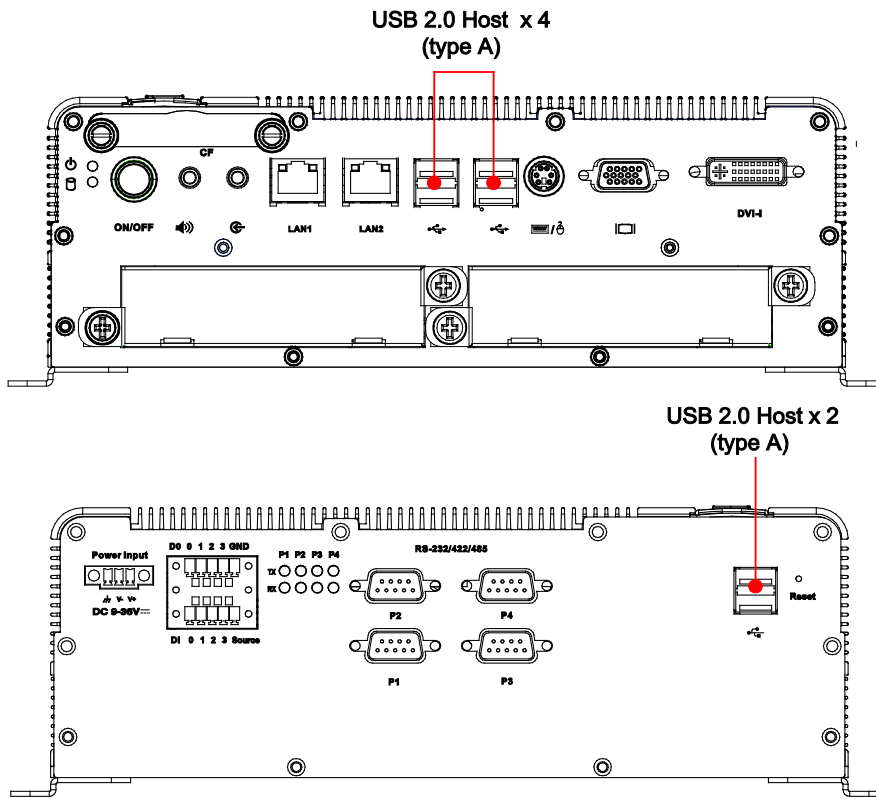

DI/DO

The V2406/2426 comes with a 6-ch digital input and a 2-ch digital output through a terminal block connector, and the V2422 comes with a 4-ch digital input and a 4-ch digital output through a terminal block connector. The pin assignments and the wiring methods are shown below.

V2406/2426

DI Dry Contact Wiring

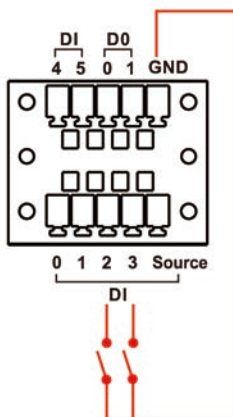

DI Wet Contact Wiring

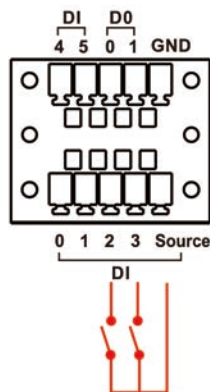

DO Wiring

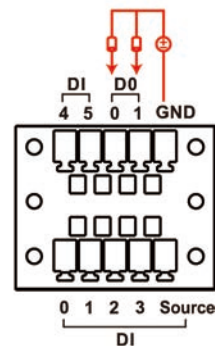

V2422

DI Dry Contact Wiring

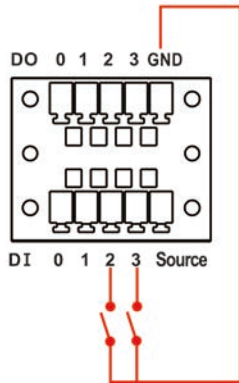

DI Wet Contact Wiring

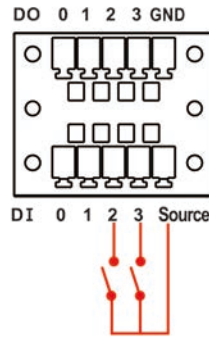

DO Wiring

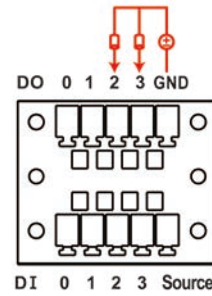

Connecting to a VGA Monitor

The V2406/2422/2426 comes with a D-Sub 15-pin female connector on the front panel to connect a VGA CRT monitor. To ensure that the monitor image remains clear, be sure to tighten the monitor cable after connecting it to the V2406/2422/2426. The pin assignments of the VGA connector are shown below.

DB15 Female Connector

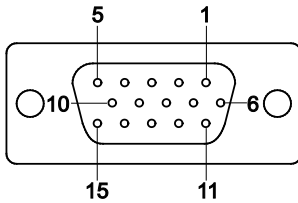

Pin No.	Signal Definition	Pin No.	Signal Definition
1	Red	9	VCC
2	Green	10	GND
3	Blue	11	NC
4	NC	12	DDC2B Data
5	GND	13	HSYNC
6	GND	14	VSYNC
7	GND	15	DDC2B Clock
8	GND		

Connecting to a DVI-I Monitor

The V2406/2422/2426 computers also come with a DVI-I connector that can connect to a DVI monitor. Use the cable to connect one end to the DVI-I connector and the other end to the monitor. See the following table for DVI-I connector pin assignments.

DVI Connector

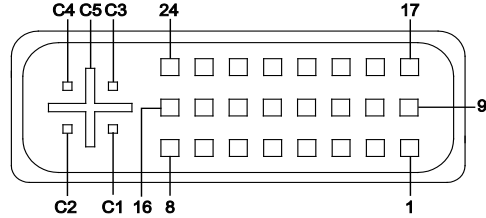

Pin No.	Signal Definition	Pin No.	Signal Definition
1	T.M.D.S. Data2-	16	Hot Plug Detect
2	T.M.D.S. Data2+	17	T.M.D.S. Data0-
3	T.M.D.S. Data2/4 Shield	18	T.M.D.S. Data0+
4	T.M.D.S. Data4-	19	T.M.D.S. Data0/5 Shield
5	T.M.D.S. Data4-	20	T.M.D.S. Data5-
6	DDC Clock	21	T.M.D.S. Data5+
7	DDC Data	22	T.M.D.S. Clock Shield
8	Analog Vertical Sync	23	T.M.D.S. Clock +
9	T.M.D.S. Data1-	24	T.M.D.S. Clock-
10	T.M.D.S. Data1+	C1	Analog Red
11	T.M.D.S. Data1/3 Shield	C2	Analog Green
12	T.M.D.S. Data3-	C3	Analog Blue
13	T.M.D.S. Data3+	C4	Analog Horizontal Sync
14	+5V Power	C5	Analog Ground (analog R, G, B return)
15	Ground (return for +5V, HSync, and VSync)		

Connecting to a Speaker or a Headphone

The V2406/2422/2426 comes with audio input and output interfaces for connecting a microphone and speaker or headphones. See the following figure for details.

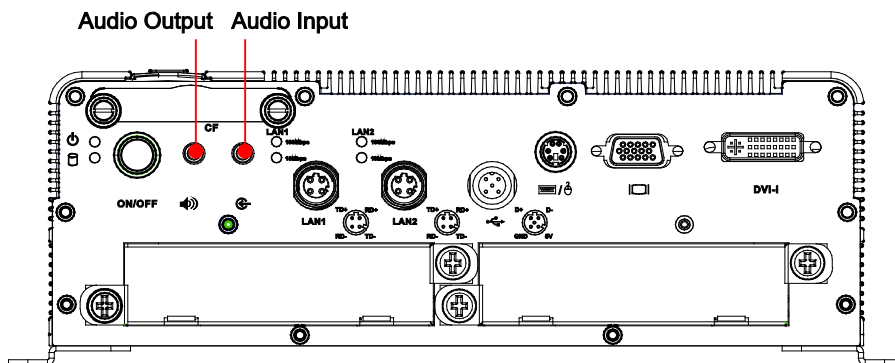

Inserting Expansion Modules

The V2422 and V2426 computers come with 2 peripheral expansion slots for inserting different communication modules, such as a 2-port CAN module, an HSDPA, GPS, WLAN module, an 8+8 port digital input/output module, a 2-port serial module, a mini PCI expansion module, or a PCI Express module, providing greater flexibility for setting up different industrial applications at field sites.

To insert the modules into the slot, follow these steps.

1. Remove the screws on the module cover.

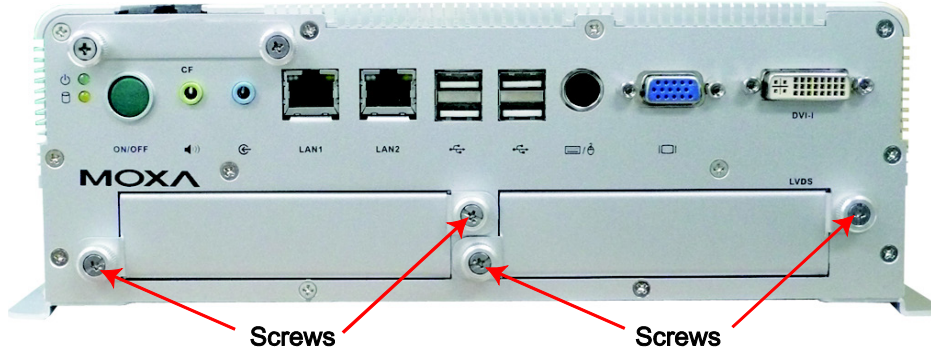

2. Take out the cover from the slot.



3. Gently insert the module into the slot.



4. When finished, fasten the screws.

Upgrading the Memory Module

The V2406/2422/2426 embedded computers support one 200-pin DDR2 533 SODIMM module with up to 2 GB of memory. One DDR2 SDRAM memory module is installed at the factory. To upgrade the DDR2 SDRAM memory module, follow these instructions:

1. Disconnect the V2406/2422/2426 from the power source.
2. We suggest placing the V2406/2422/2426 upside down. For the V2422 and V2426, remove all the screws on the front and rear panels. Remember to remove all screws from the DB9 connectors and the terminal blocks for digital input/output and the power. The screws for the CF card socket also need to be removed. See the following figures for details.

V2422/V2426

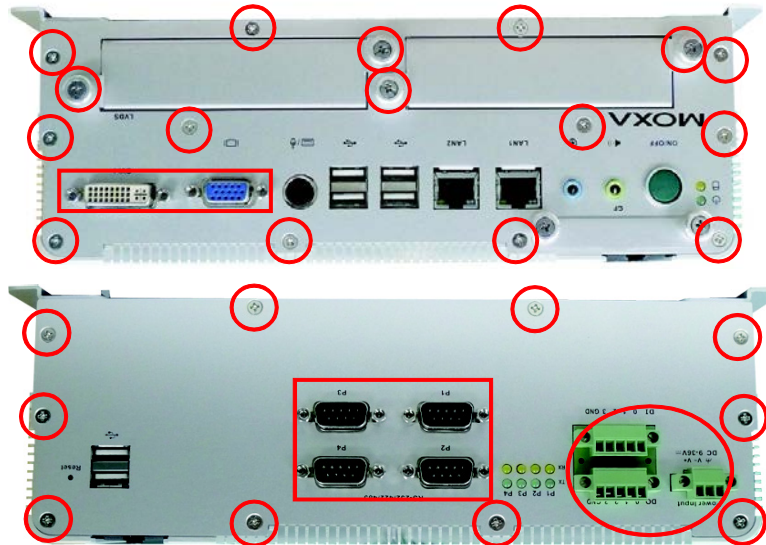

V2406

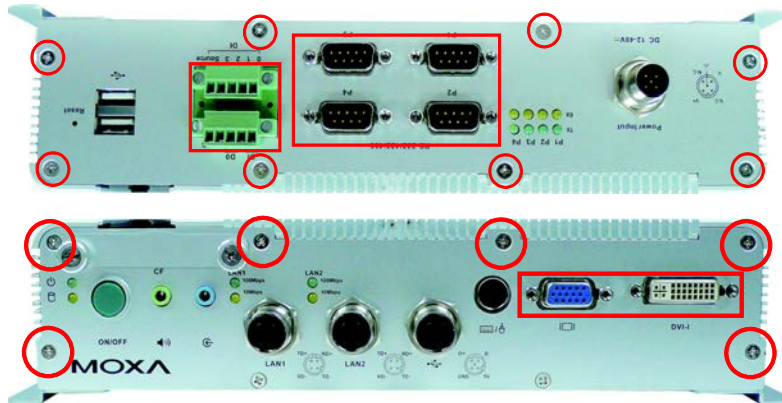

3. With the V2422 and V2426, when you remove the rear cover, you also need to remove the four screws on the riser board.

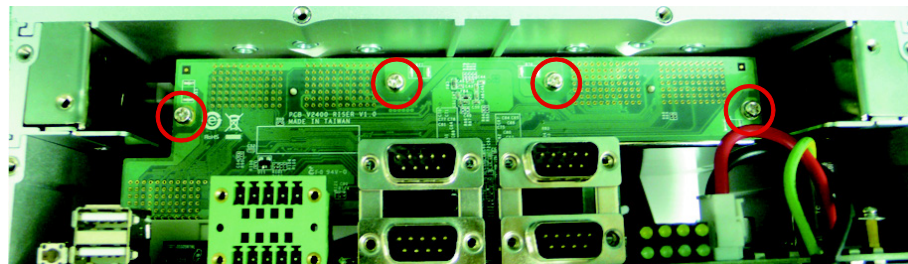

4. Pull up the back cover of the computer; you will be able to see the memory module socket on the main board. With the V2422 and V2426

5. After removing the back cover of the computer, simply pull up the riser board.

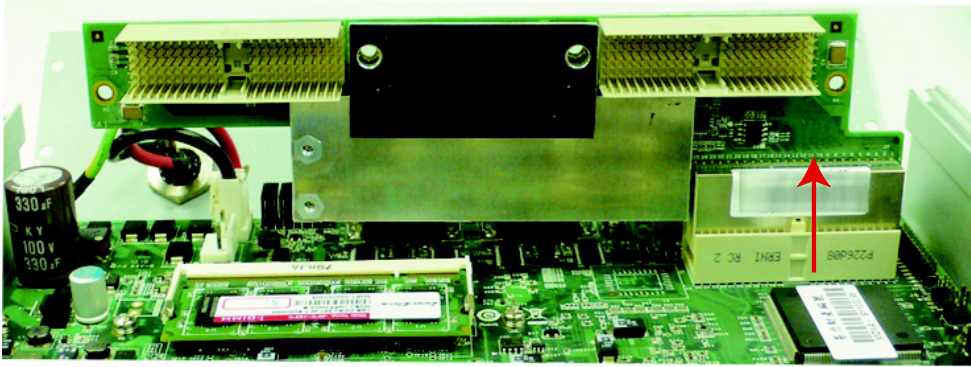

6. Carefully remove the module by pushing the latches on both sides of the module, and then replace the new module. Be sure to orient the module correctly.



7. Push down the module and make sure the latches are firmly in place.

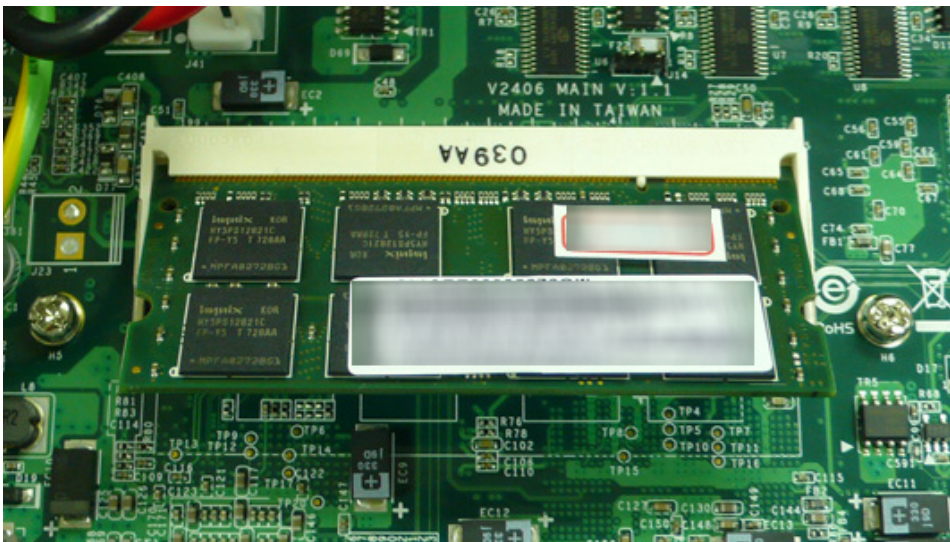

8. When finished, replace the back cover of the V2406/2422/2426 computer.

Upgrading the DOM Module

The V2406/2422/2426 computers have been pre-installed with a DOM to store the OS. To upgrade the DOM module, take the following steps.

1. After taking off the back cover of the V2406/2422/2426, find the location of the DOM module socket.

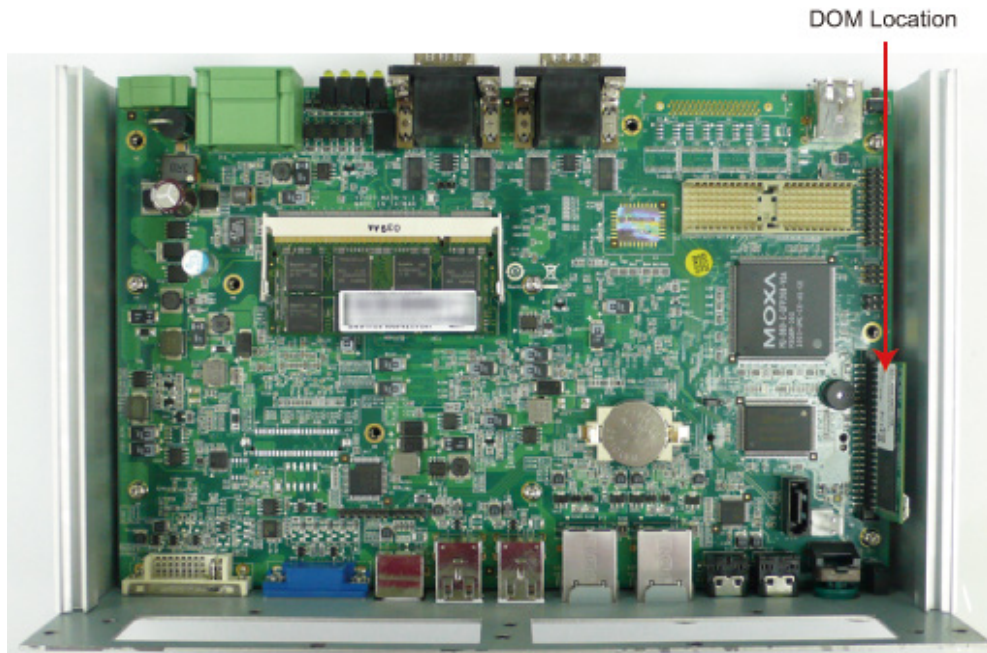

2. Pull up and take off the DOM module, and then place the new DOM module into the slot.

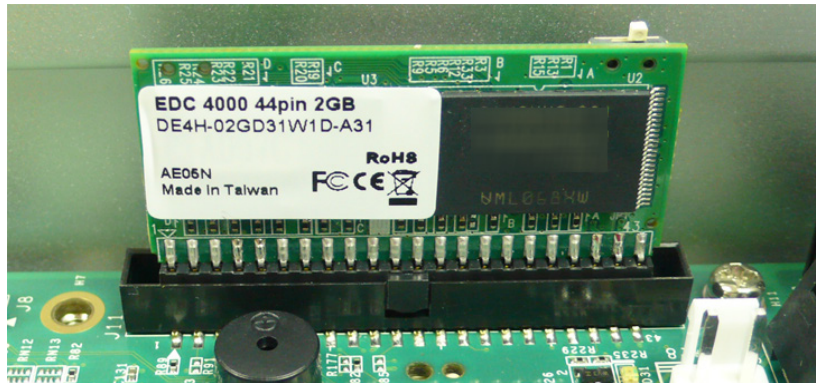

Installing a SATA Hard Disk

The V2406/2422/2426 embedded computer has one SATA connector for installing one SATA hard disk. To install a 2.5-inch SATA hard disk, follow these instructions:

1. Disconnect the V2406/2422/2426 from its power source.
2. Remove all the screws and pull up the back cover of the computer. Refer to "Upgrading the Module Memory" section for details.

- Unpack the HDD bracket package. This package is not included in the product, and should be purchased separately. Check the items in the following figure:

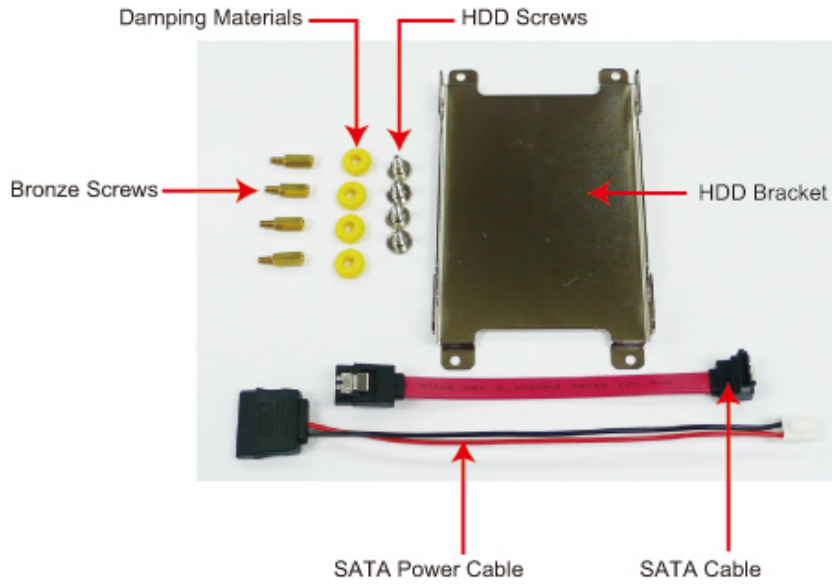

The HDD package includes an HDD bracket, four HDD screws, for damping materials, four bronze screws, one SATA power cable and one SATA cable.

- Place the four yellow damping materials into the slide of the bracket. Each side needs two damping materials.

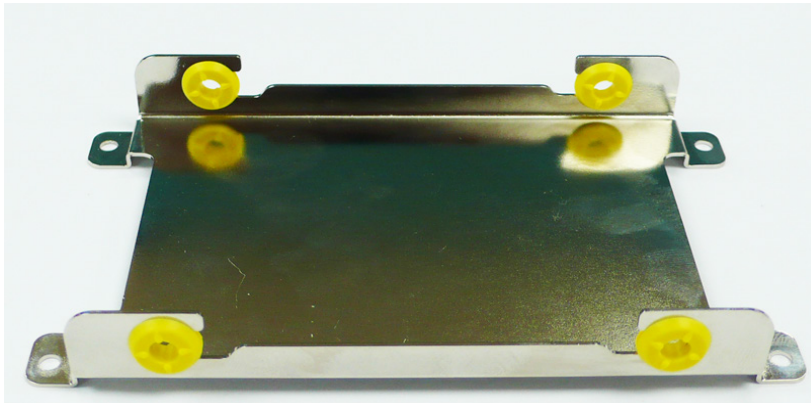

- Place the hard drive disk on the bracket, and then use the screws to fasten.



- The hard disk socket is located on the mainboard of the computer. Remove four screws on the board, and then fasten the four bronze screws instead.

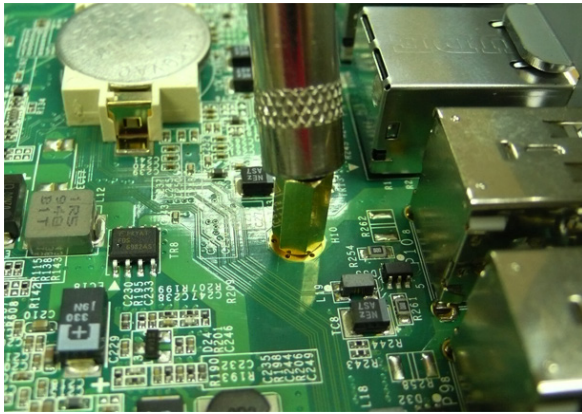
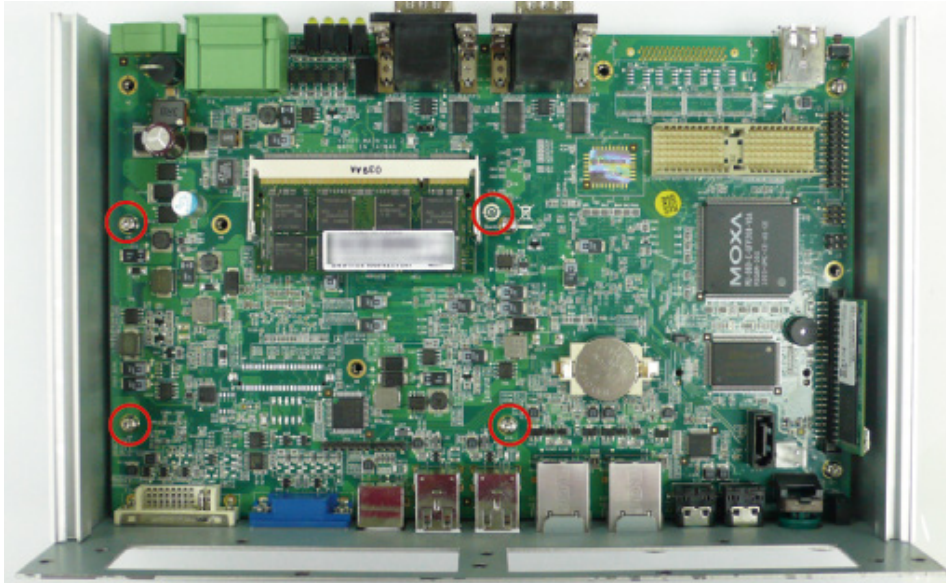

- Place the HDD bracket onto the mainboard of the computer, and then fasten the bracket with the screws.

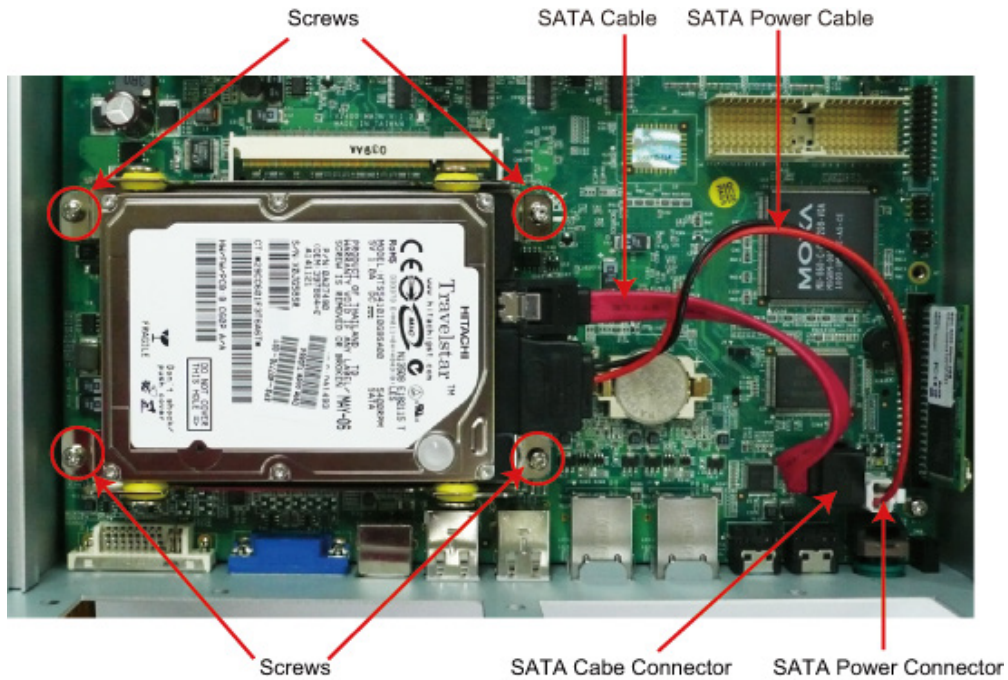

- Connect the SATA power cable and the SATA cable to the connectors.
- Replace the back cover of the V2406/2422/2426 computer to finish the installation.

Adjusting COM1 PIN 9 Voltage

PIN 9 of the V2406/2422/2426's serial port 1 can be set to 0 V, +5 V, or +12 V by jumper. The jumper is located between the serial port and the memory module on the mainboard.

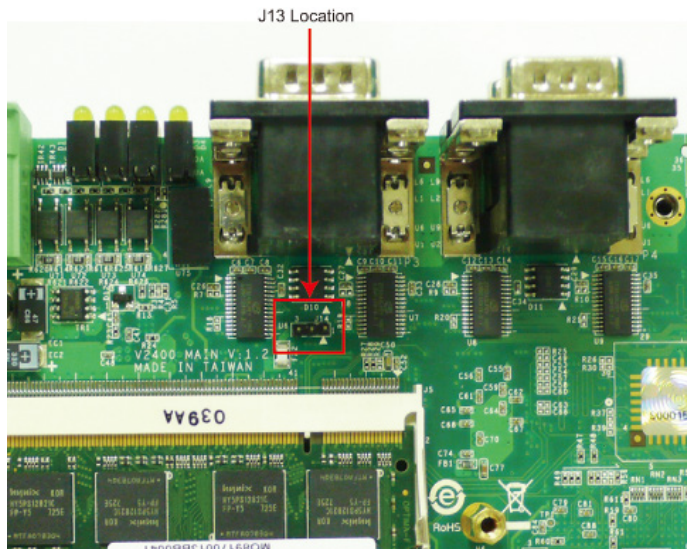

Use the jumper to select the voltage for PIN 9 of the Serial Port 1. Refer to the following table for jumper settings.

Jumper	Voltage Settings
1-2	5 V
2-3	12 V
N/C	0 V (N/C)

This chapter describes the BIOS settings of the V2406/2422/2426 embedded computers. The BIOS is a set of input/output control routines for peripherals. The BIOS is used to initialize basic peripherals and helps boot the operating system before the operating system is loaded. The BIOS setup allows the user to modify the system configurations of these basic input/output peripherals. All of the configurations will be stored in the battery backed up CMOS RAM, which retains the system information after system reboots or the power is removed.

The following topics are covered in this chapter:

❑ **Entering the BIOS Setup Utility**

❑ **Modifying the BIOS Main Settings**

- Basic Configuration
- System Security

❑ **Advanced Settings**

- Hard Disk Boot Priority
- Advanced BIOS Features
- CPU Features
- Advanced Chipset Settings

❑ **Peripherals**

- OnChip IDE Device
- Onboard Device
- Super I/O Device

❑ **Power**

- ACPI Suspend Type
- Soft-Off by PWR-BTTN

❑ **Hardware Monitor**

- CPU Warning Temperature
- Warning Beep

❑ **Load Defaults**

- Load System Default Settings
- Load System Turbo Settings
- Load CMOS from BIOS
- Save CMOS to BIOS

❑ **Exiting the BIOS Setup**

- Save & Exit Setup
- Exit Without Saving

❑ **Upgrading the BIOS**

Entering the BIOS Setup Utility

To enter the BIOS setup utility, press the “Del” key while the system is booting up. The main BIOS Setup screen will appear.

A basic description of each function key is listed at the bottom of the screen. Refer to these descriptions to learn how to scroll about the screen, how to select by pressing “Enter,” and how to use the other hot keys listed below.

F1: General Help

F5: Previous Value

F6: Default Settings

F7: Turbo Settings

F10: Save

ESC: Exit

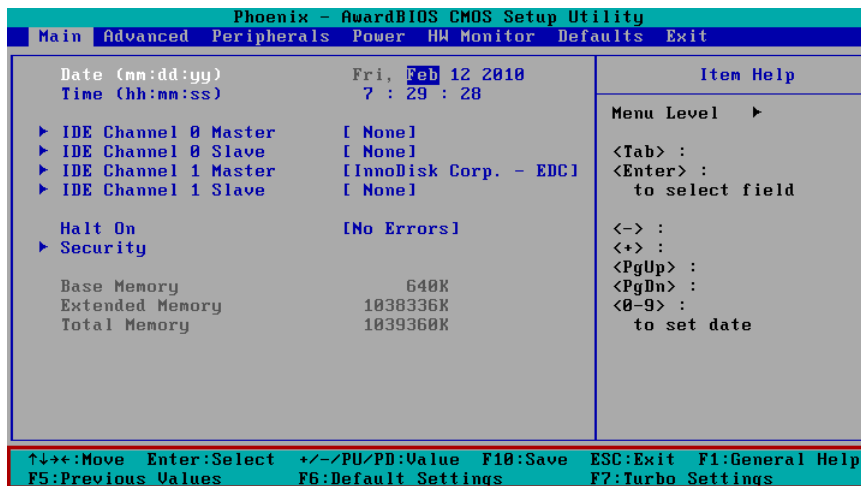

Modifying the BIOS Main Settings

Basic Configuration

After entering the BIOS Setup, or choosing the “Main” option, the BIOS main menu will be displayed. Use this menu to check the basic system information such as memory and IDE hard drive. You can also use the menu for configuring basic system parameters, such as date, time, hard drive, display, and system security.

System Security

To set up system security, select the "Security" option under "Main" to bring up the following screen.

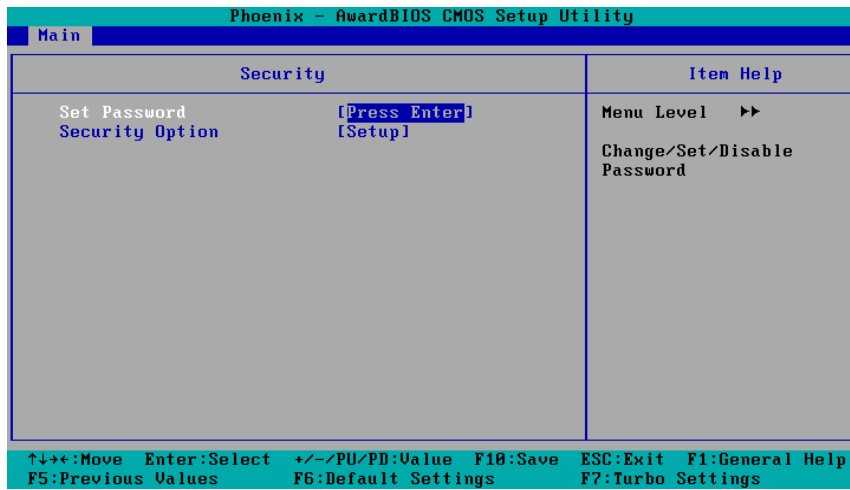

This menu includes two options: "Set Password" and "Security Option."

When you select the Set Password option, a pop-up "Enter Password:" window will appear on the screen. The password that you type will replace the password stored in the CMOS memory. You will be required to confirm the new password. Just re-type the password and then press <Enter>. You may also press <Enter> to abort the selection and not enter a password.

To clear an existing password, just press <Enter> when you are prompted to enter the password. A message will show up confirming that the password will be disabled. Once the password is disabled, the system will boot and you can enter the "BIOS Setup Menu" without entering a password.

Once a password has been set, you will be prompted to enter the password each time you enter Setup. This prevents unauthorized persons from changing any part of your system configuration. In addition, when a password setting is enabled, you can set up the BIOS to request a password each time the system is booted up. The "Security Option" setting determines when a password prompt is required. If the "Security Option" is set to "System," the password must be entered both at boot up and when entering the BIOS Setup Menu. If the password is set for "Setup," the password prompt only occurs when you enter the "BIOS Setup Menu."

Advanced Settings

The "Advanced Features" screen will appear when choosing the "Advanced" item from the main menu.

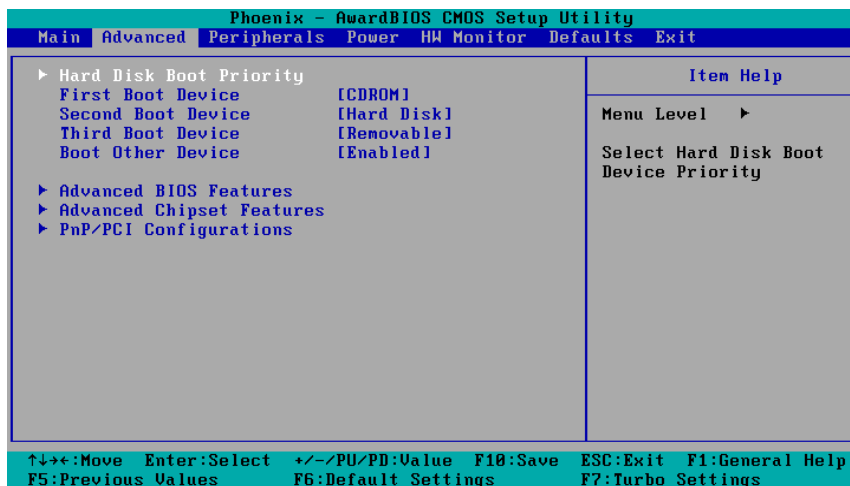

Hard Disk Boot Priority

First/Second/Third Boot Device

This option allows users to select or change the device boot priority. You may set 3 levels of priority to determine the boot up sequence for different bootable devices, such as a hard drive, CD-ROM, and removable devices. Select the order in which devices will be searched in order to find a boot device. The available options are "CDROM (default for first boot device)," "Removable" (default for third boot device), "Hard Disk" (default for second boot device) and "Disabled."

Advanced BIOS Features

When you select the "Advanced BIOS Features" option under the "Advanced" menu, the following configuration menu will appear.

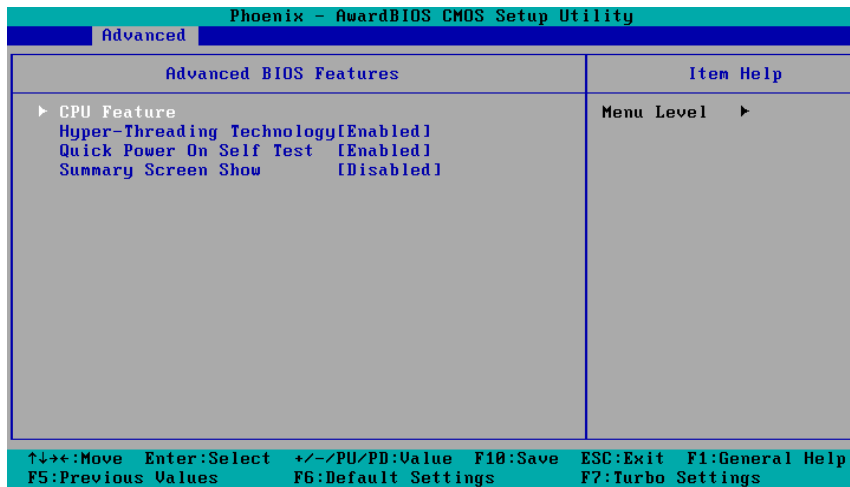

CPU Features

C1E Function

This item allows you to configure the power-saving mode when the CPU is in C1 status.

Options: Auto (default), Disabled

EIST Function

This item allows you to configure the power saving mode with the Enhanced Intel SpeedStep Technology. This helps the system reduce the workload frequency and power consumption.

Options: Disabled (default), Enabled

Hyper-Threading Technology

This item allows you to enable or disable the hyper-threading function, which allows the system to handle more than one thread at the same time.

Options: Enabled (default), Disabled

Quick Power On Self Test

This setting allows the system to skip certain tests while the system boots up. Enable this feature to speed up the boot up process.

Options: Enabled (default), Disabled

Summary Screen Show

The summary screen displays system information, including CPU, memory, disk drive, and PCI devices. The default value is disabled. You may choose “Enabled” to display this screen when the system is booting up.

Options: Disabled (default), Enabled

Advanced Chipset Settings

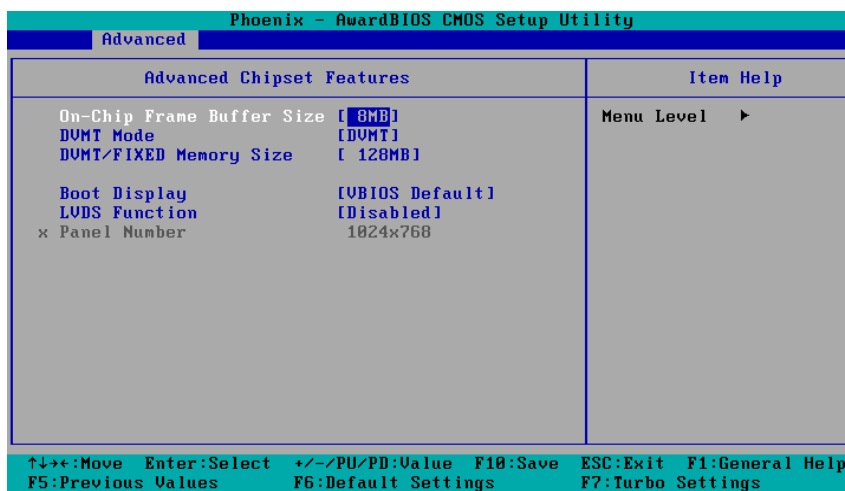

On-chip Frame Buffer Size

This item determines the frame buffer size for the VGA function, and will share the system memory.

Options: 1 MB, 4 MB, 8 MB (default),

DVMT Mode

Sets the Dynamic Video Memory Technology operating mode. When set to “Fixed,” the graphics driver will reserve a fixed portion of the system memory as graphics memory. When set to “DVMT,” the graphics driver will dynamically allocate system memory as graphics memory, according to system and graphics requirements. When set to “BOTH,” the graphics driver will allocate a fixed amount of memory as dedicated graphics memory, as well as allow more system memory to be dynamically allocated between the graphics processor and the operating system.

Options: FIXED, DVMT (default), BOTH

DVMT/FIXED Memory Size

Sets the maximum amount of system memory that can be allocated as graphics memory.

Options: 64 MB, 128 MB (default).

Boot Display

This item allows you to choose which display interface will be shown when system is booting up. Due to the display limitation, two displays at most can be shown when booting up. If you select the default option, "VBIOS Default", the displays that have been connected will be used as the default displays.

Options: VBIOS Default (default), VGA+DVI, VGA, DVI

LVDS Function

This item allows to enable or disable the LVDS function.

Options: Disabled (default), Enabled

Peripherals

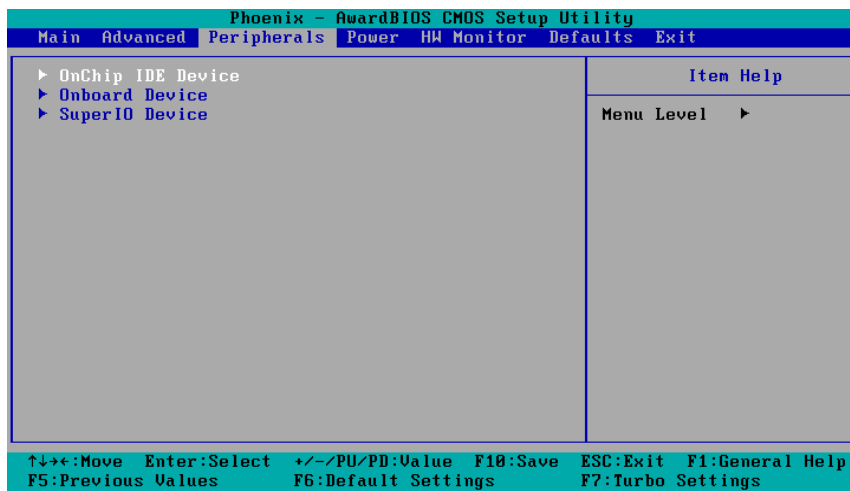

OnChip IDE Device

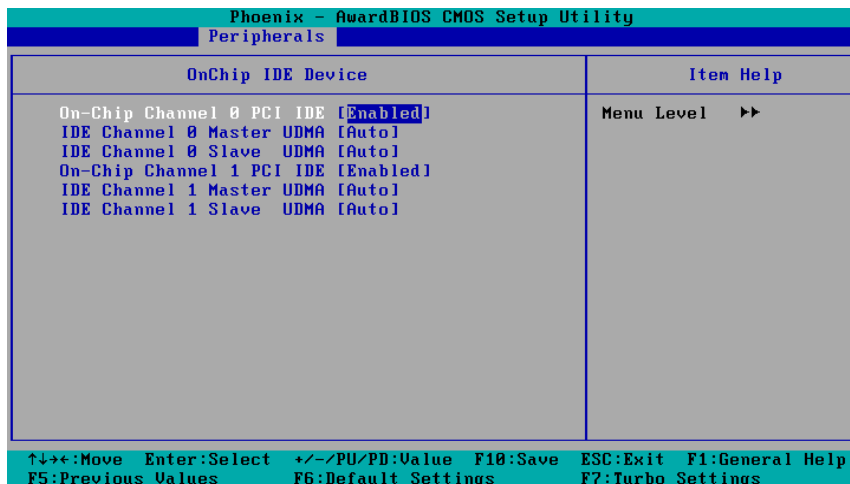

On-Chip Channel 0 PCI IDE

This item allows you to enable or disable the Channel 0 onboard PCI device.

Options: Enabled (default), Disabled

IDE Channel 0 Master UDMA

This item allows you to configure UDMA mode for the device on IDE channel 0 Master.

Options: Disabled, Auto (default), UDMA33, UDMA66, UDMA100

IDE Channel 0 Slave UDMA

This item allows you to configure UDMA mode for the device on IDE channel 0 Slave..

Options: Disabled, Auto (default), UDMA33, UDMA66, UDMA100

On-Chip Channel 1 PCI IDE

This item allows you to enable or disable the Channel 1 onboard PCI device.

Options: Enabled (default), Disabled

IDE Channel 1 Master UDMA

This item allows you to configure UDMA mode for the device on IDE channel 1 Master.

Options: Disabled, Auto (default), UDMA33, UDMA66, UDMA100

IDE Channel 1 Slave UDMA

This item allows you to configure UDMA mode for the device on IDE channel 1 Slave..

Options: Disabled, Auto (default), UDMA33, UDMA66, UDMA100

Onboard Device

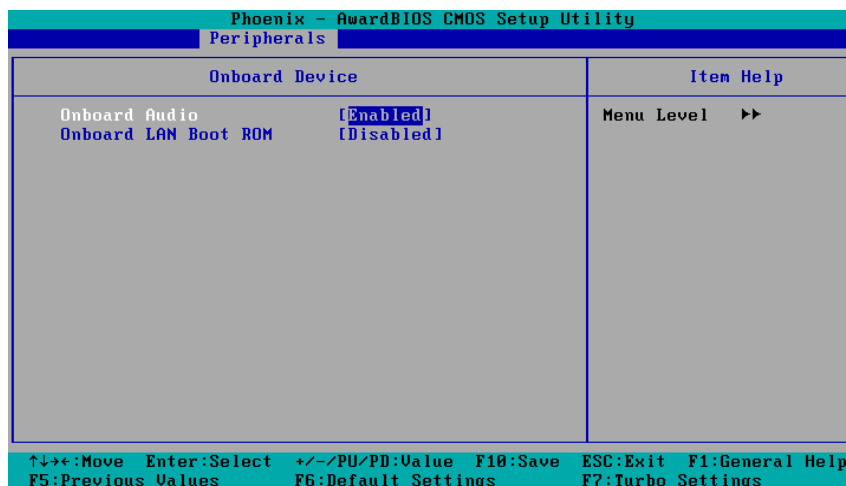

Onboard Audio

This feature allows you to enable/disable the audio controller.

Options: Enabled (default), Disabled

Onboard LAN Boot ROM

Decide whether to invoke the boot ROM of the onboard LAN chip.

Options: Enabled, Disabled (default)

Super I/O Device

Debug Port

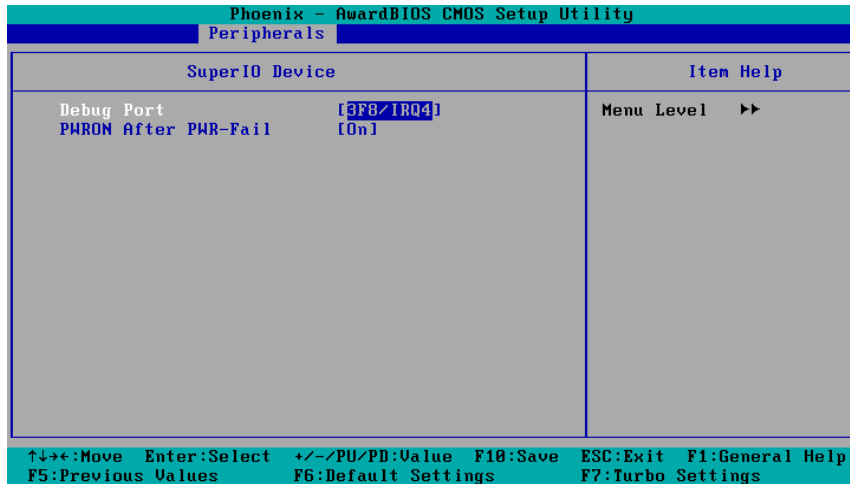

This function allows you to enable/disable the debug port communication. The V2406/2422/2426 computer will automatically distribute the IRQ value for the debug port as the default value. If you wish to disable, select **Disabled**. This port is only for engineers who are debugging programs.

Power on After Power Fail

This item allows you to configure the power on after power fail function.

Options: Off, On (default), Former-Sts

Power

The Power Setup Menu allows you to configure your system power-up/ power-down options.

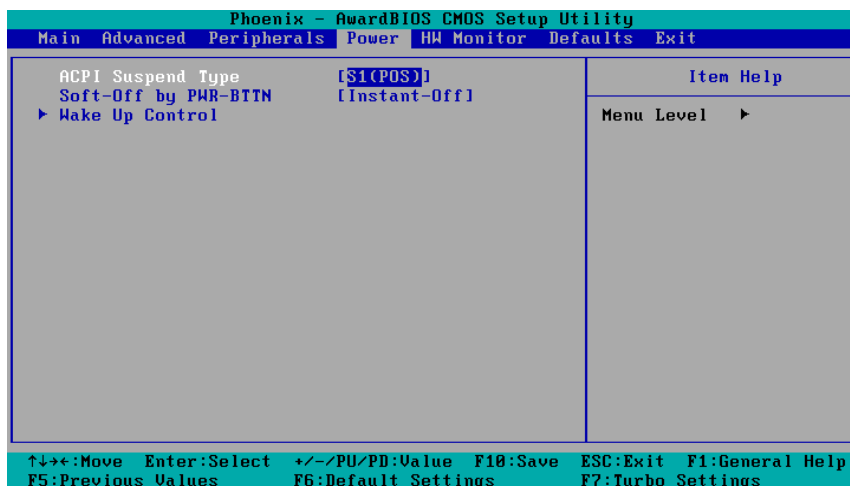

ACPI Suspend Type

This item allows you to set up the ACPI suspend type for power management function.

Option: S1 (POS), (default), S3 (STR)

Soft-Off by PWR-BTTN

This item determines the delay to stop the software when pushing the power button.

Options: Instant-Off (default), Delay 4 Sec.

Hardware Monitor

Phoenix - AwardBIOS CMOS Setup Utility						
Main	Advanced	Peripherals	Power	HW Monitor	Defaults	Exit
CPU Warning Temperature	[90°C/194°F]	Item Help				
Warning Beep	[Disabled]	Menu Level ▶				
Current System Temp	37°C / 98°F					
Current CPU Temperature	21°C / 69°F					
CPU Vcore	1.23V					
+1.05 (V)	1.04V					
+1.5 (V)	1.52V					
DDR2 Vcore	1.84V					
+5.0 (V)	5.13V					
+3.3 (V)	3.34V					
AVCC (V)	3.32V					
VBAT (V)	3.29V					
3USB (V)	3.34V					
↑↓→+:Move Enter:Select +/-:PU/PD:Value F10:Save ESC:Exit F1:General Help F5:Previous Values F6:Default Settings F7:Turbo Settings						

This item helps monitor the status of the system, including CPU temperature and the voltage of the CPU, SDRAM and battery.

CPU Warning Temperature

This item allows you to configure what temperature will trigger a high temperature warning.

Options: 80°C/176°F, 90°C/194°F (default), 100°C/212°F, Disabled

Warning Beep

This item allows you to enable/disable the warning beep.

Options: Disabled (default), Enabled

Load Defaults

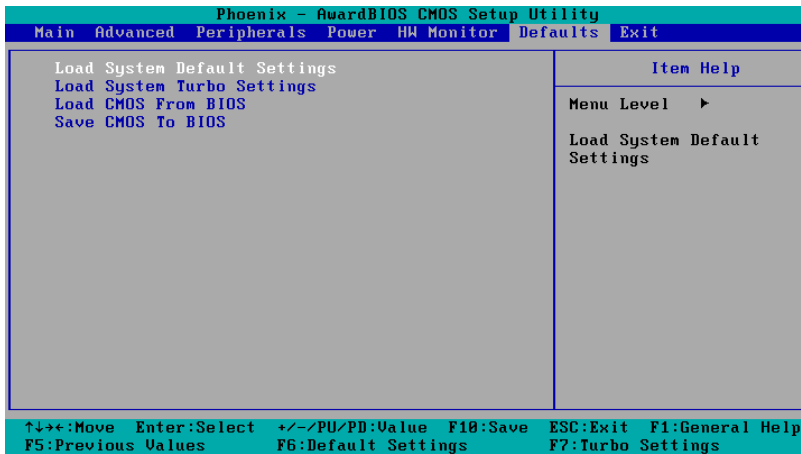

Load System Default Settings

Use this option to load system factory default settings instead of the current BIOS settings. This option is useful for when the system is unstable. Users do not need to remember what settings were active before the system fails.

Load System Turbo Settings

Use this option to load system optimized settings. If the system is not stable, please load the system default settings.

Load CMOS from BIOS

Use this option to load BIOS settings from flash ROM to CMOS.

Save CMOS to BIOS

Use this option to save the BIOS settings from the CMOS to flash ROM.

Exiting the BIOS Setup

To exit the BIOS setup utility, choose "Exit." Pressing <ESC> will achieve the same result.

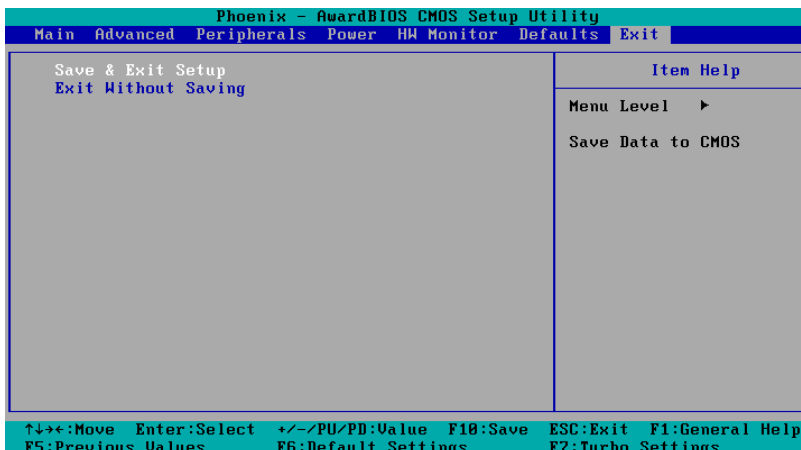

Save & Exit Setup

Save all configuration changes to CMOS (memory) and exit setup. A confirmation message will be displayed before proceeding.

Exit Without Saving

Abandon all changes made during the current session and exit setup. A confirmation message will be displayed before proceeding.

Upgrading the BIOS

This section describes how to upgrade the BIOS. However, please note that upgrading the BIOS involves high risk of damage to your computer. We strongly recommend that you contact Moxa's TS staff for assistance and obtain all necessary tools and files before attempting to upgrade.

Step 1: Create a Bootable USB Disk.

We suggest you use the HP USB Disk Format Tool to create a bootable USB disk. You may download this tool from the Internet. Search the Internet using the phrase "HP USB Disk Storage Format Tool", and then download the tool from one of the listed websites.

You will also need to download the FreeDos system files **kernel.sys** and **command.com** from <http://www.freedos.org/kernel/>.

1. Copy DOS system files **kernel.sys** and **command.com** to a specified directory (**C:\FreeDOS** in this example).
2. Start the HP USB Disk Storage Format Tool and select the USB device that you want to use as a bootable disk in the **Device** drop down box.
3. Select **FAT** in the **File system** drop down box.
4. Type the disk name in the **Volume label** field.
5. Check the option **Create a DOS startup disk** under format options.
6. Specify the directory of the system files (for example, **C:\FreeDOS**).
7. Click **Start** to format and create the USB disk.

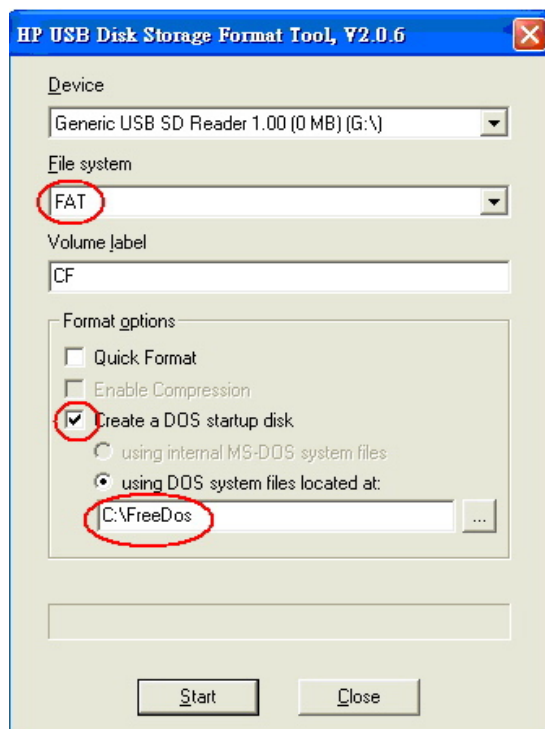



ATTENTION

We suggest you use a USB drive with under 2 GB in disk space, as larger USB drives may not support FAT file format and consequently fail to boot.

Step 2: Prepare the Upgrade Tool and BIOS Binary File.

You must use the BIOS upgrade installation file to upgrade the BIOS. You can send your request to Moxa's technical support team at support@moxa.com to get an updated version of the BIOS.

1. Get the BIOS upgrade installation file. The file name should have following format: **V24001X.SXX**.
2. Copy the file to the Bootable USB Disk.
3. Double click to extract the BIOS update installation file. The file includes a binary file in the form **V24001X.SXX** and the upgrade utility named **awdf flash.exe**.

Step 3: Set up the BIOS to Boot from the USB Disk.

1. Insert the USB disk.
2. Power on and press **DEL** to enter the BIOS Setup menu.
3. Select **Advanced** → **Hard Disk Boot Priority** and then press **Enter**.
4. From the Setup menu, use “↑” or “↓” to select the USB device.

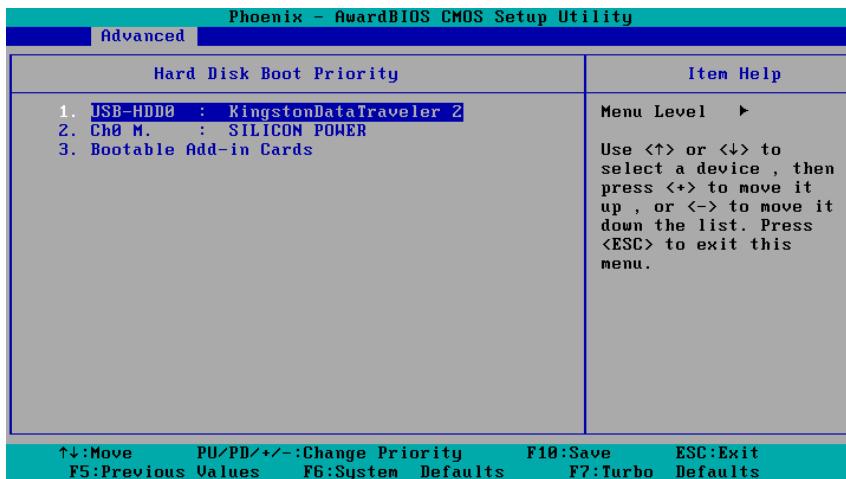

5. Press “+” to move it up to the first priority, and press “Esc” to exit the setup menu.
6. Make sure the first boot device is **Hard Disk**. If isn't, press **Enter** to change it.

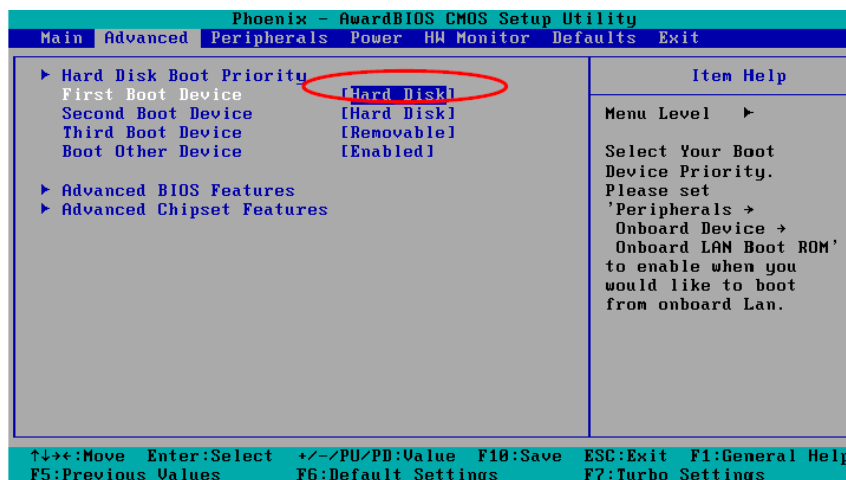

7. Select **Exit** → **Save & Exit Setup** and then press **Enter**.
8. Choose **Y** to save to the CMOS and then exit.

Step 4: Run awdf flash.exe to upgrade the BIOS.

While in the BIOS Setup menu and before upgrading the BIOS, you may choose to save the old BIOS files to a specific location. Type **Y** to do so, or **N** to begin the upgrade.

1. If the BIOS Setup is correct, it will restart and boot from the USB disk.
2. Run **awdf flash V24001X.SXX** from the command line to upgrade the BIOS. Replace xxxxxxx.Sxx with the BIOS binary file name discussed in Step 2.
3. Press **F1** to reset the system after the bios update is complete. The system should reboot at this time.

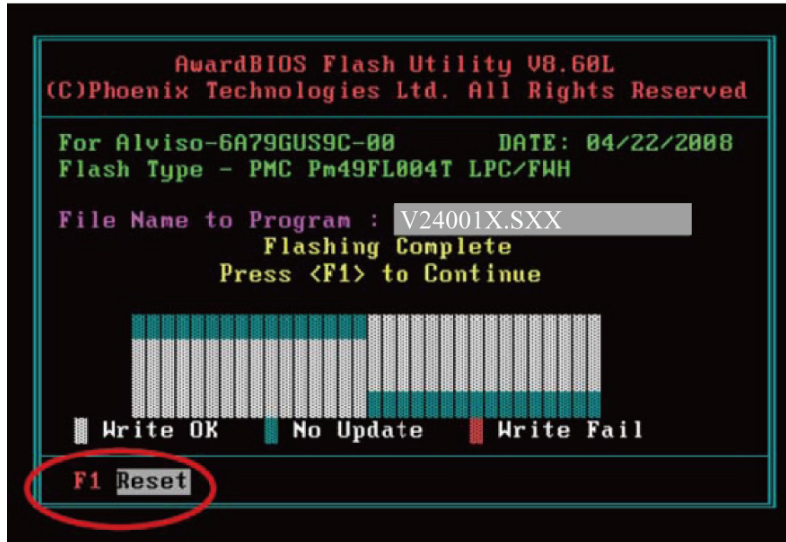

Note that once the BIOS is successfully upgraded, the default BIOS values will be automatically loaded. However, if you wish to re-configure the BIOS settings, press **DEL** while booting.

**ATTENTION**

Do **NOT** switch off the power supply during the BIOS upgrade, since doing so may cause the system to crash.

A

Regulatory Approval Statement



This device complies with part 15 of the FCC Rules. Operation is subject to the following two conditions: (1) This device may not cause harmful interference, and (2) this device must accept any interference received, including interference that may cause undesired operation.

Class A: FCC Warning! This equipment has been tested and found to comply with the limits for a Class A digital device, pursuant to part 15 of the FCC Rules. These limits are designed to provide reasonable protection against harmful interference when the equipment is operated in a commercial environment. This equipment generates, uses, and can radiate radio frequency energy and, if not installed and used in accordance with the instruction manual, may cause harmful interference to radio communications. Operation of this equipment in a residential area is likely to cause harmful interference in which case the user will be required to correct the interference at his own expense.



European Community

Warning:

This is a class A product. In a domestic environment this product may cause radio interference in which case the user may be required to take adequate measures.