

VPort 25 Series

IP66, day-and-night vandal-proof fixed dome IP camera for outdoors



- > -40 to 50°C operating temperature; heater or fan not required
- > IP66-rated for protection from rain and dust
- > Direct-wired power input and PoE for power redundancy
- > Up to 30 frames/sec at 720 x 480 resolution
- > One camera lens for both day and night use



Introduction

The VPort 25 is a vandal-proof, IP66-rated, fixed dome IP camera for use in harsh, outdoor environments. With a maximum resolution of 520 TVL and day-and-night CCD camera lens, the VPort 25 is especially well-suited for high performance video surveillance applications. The VPort 25's IP66-rating provides protection against

dust and rain, and the vandal-proof form factor design prevents damage from unexpected external forces. In addition, the case-open sensor sends an alarm message when the VPort 25's outer case is opened.

Heater and Fan not Required; Supports Direct-wired Power Input and PoE for Power Redundancy

The VPort 25's no-heater/fan-less embedded system provides greater reliability for outdoor use. In addition, the camera comes with

redundant power inputs: (1) direct power connection (12/24 VDC and 24 VAC), and (2) PoE (IEEE 802.3af) power input.

High Performance Video with Full Motion MJPEG/MPEG4 Video Stream

The VPort 25 uses the ASIC compression chip, which provides video performance up to full D1 (720 x 480) @ 30 FPS. To meet a wider

range of customer requirements, the VPort 25 supports dual-codecs, including the MJPEG and MPEG4 algorithms.

Specifications

Camera

Sensor: 1/3" Sony Super HAD or 1/3" Sony ExView

Lens:

Wide-end: F1.4, diagonal 115.4°, horizontal 90.3°

Tele-end: F2.4, diagonal 39.8°, horizontal 31.9°

Focal Length: F= 3.7-12 mm

Modulation: NTSC or PAL

Camera Angle: Pan: ±180°; tilt: ±85°, rotation: ±170° (camera angles controlled manually)

Illumination:

Color: 0.2 Lux at F1.2

Black and white: 0.03 Lux at F1.2

Synchronization: Internal

Gamma Correction: 0.45

White Balance: Auto tracking white balance

Electronic Shutter Speed: 1/60 (50) second to 1/100,000 second, automatic

S/N Ratio: More than 50 dB (AGC off)

AGC Control: On/Off

Flickerless Control: On/Off

Backlight Compensation: On/Off

Mirror: On/Off

Auto Exposure, Auto Iris:

On: Auto exposure

Off: Auto iris

Horizontal Resolution: 420/520 TVL

Effective Pixels:

NTSC: 510 x 492 (middle resolution), 768 x 494 (high resolution)

PAL: 500 x 582 (middle resolution), 752 x 582 (high resolution)

Video

Video Compression: MJPEG or MPEG4 (ISO/IEC 14496-2)

Video Resolution and FPS (frames per second):

	NTSC		PAL	
	Size	Max. FPS	Size	Max. FPS
QVGA	320 x 240	30	320 x 288	25
CIF	352 x 240	30	352 x 288	25
VGA	640 x 480	30	640 x 576	25
4CIF	704 x 480	30	704 x 576	25
Full D1	720 x 480	30	720 x 576	25

Video Viewing:

- Adjustable image size and quality
- Timestamp and text overlay

Video Output: Via Ethernet port or BNC connector (1.0 Vpp, 75 ohms)

Audio

Audio Inputs: 1 Line-in or MIC-in with 2-pin terminal block connector

Audio Outputs: 1 Line-out with 2-pin terminal block connector

Network

Protocols: TCP, UDP, HTTP, SMTP, FTP, Telnet, NTP, DNS, DHCP, UPnP, RTP, RTSP, ICMP, IGMPv3, QoS, SNMPv1/v2c/v3, DDNS
Ethernet: 1 10/100BaseT(X) auto negotiating RJ45 port

GPIO

Digital Inputs: 1, max. 8 mA
 High: +13 to +30 V; Low: -30 to +3 V
Relay Outputs: 1, max. 24 VDC @ 1A

LED Indicators

STAT: Indicates if the system booted properly
Network: 1 LED for 10 Mbps, 1 LED for 100 Mbps
System: Power On/Off
DIP Switch: To turn the LED light On/Off

Power Requirements

Input Voltage: Redundant power inputs
 • 12/24 VDC or 24 VAC with 2-pin terminal block connector
 • Power-over-Ethernet (IEEE 802.3af)

Power Consumption: Max. 9.5 W

Physical Characteristics

Housing: IP66-rated for rain and dust protection, vandal-proof supports
Diameter: 142 mm (5.59 in)
Height: 118.9 mm (4.68 in)
Weight: 1700 g
Installation: Surface mounting, wall mounting

Alarms

Video Motion Detection: Includes sensitivity tuning
Video Loss: Video loss alarm
Case-open Sensor: Built in case-open sensor alarm
Scheduling: Daily repeat timing schedule
Imaging: JPEG snapshots for pre/trigger/post alarm images
Custom Alarms: HTTP event servers for setting customized alarm actions

Security

Password: User level password protection
Filtering: By IP address

Environmental Limits

Operating Temperature: -40 to 50°C (-40 to 122°F)
Storage Temperature: -40 to 85°C (-40 to 185°F)
Ambient Relative Humidity: 5 to 95% (non-condensing)

Regulatory Approvals

EMS:
 EN61000-4-2 (ESD), level 2
 EN61000-4-3 (RS), level 3
 EN61000-4-4 (EFT), level 3
 EN61000-4-5 (Surge), level 3
 EN61000-4-6 (CS), level 3
 EN61000-4-8
 EN61000-4-11
EMI: FCC Part 15, CISPR (EN55022) class A
Shock: IEC 60068-2-27
Freefall: IEC 60068-2-32
Vibration: IEC 60068-2-6

Note: Please check Moxa's website for the most up-to-date certification status.

MTBF (mean time between failures)

Time: 74,155 hrs
Database: Telcordia (Bellcore), GB 25°C

Warranty

Warranty Period: 3 years
Details: See www.moxa.com/warranty

Software Bundled Free

SoftDVR Lite: 1 to 4-ch IP surveillance software for viewing and recording
VPort SDK PLUS: Includes CGI commands, ActiveX Control, and API library for customized applications or system integration for third-party developers (the latest version of SDK is available for download from Moxa's website).

Dimensions

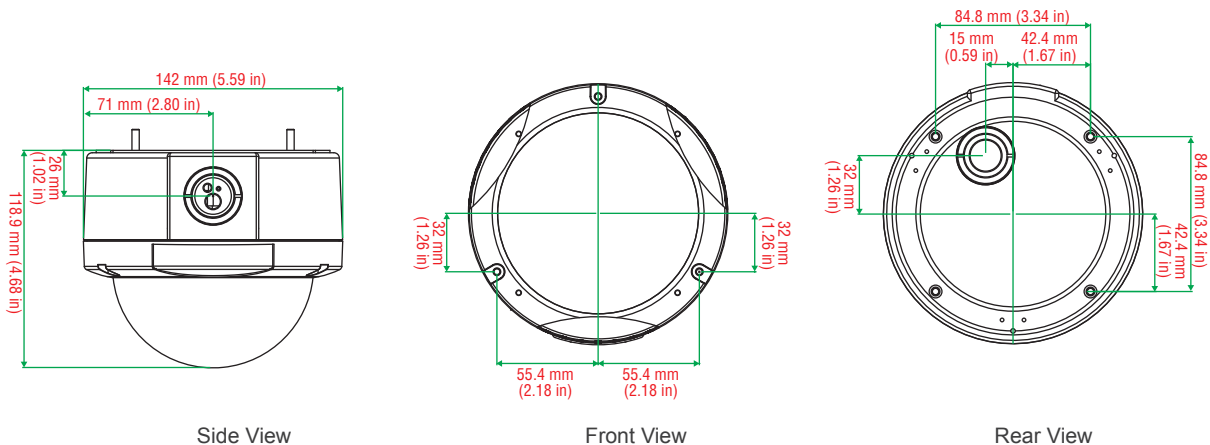

Ordering Information

Available Models	Camera Sensor		Modulation	
	SuperHAD	Exview	NTSC	PAL
VPort 25-CAM3S52N	✓	–	✓	–
VPort 25-CAM3S52P	✓	–	–	✓
VPort 25-CAM3E52N	–	✓	✓	–
VPort 25-CAM3E52P	–	✓	–	✓

: IP Camera Mounting Accessories



Mounting Kit

For mounting dome camera onto straight tube, gooseneck tube, or mini pendant

VP-MK

Height: 71 mm (2.8 in)
Diameter: 132.4 mm (5.21 in)
Weight: 300 g (0.7 lbs)



Units: (mm)

Straight Tube

VP-ST1 or VP-ST2

Height: 250 mm (9.84 in) or 500 mm (19.69 in)
Diameter: 50 mm (1.97 in)
Weight: 1000 g (2.2 lbs)/1800 g (4 lbs)

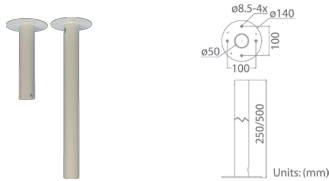

Units: (mm)

Standard Pendant

VP-SP

Dimensions: 348 x 104 x 138.6 mm (13.7 x 4.1 x 5.5 inches)
Diameter: 45 mm (1.8 inches)
Weight: 1500 g (3.3 lbs)

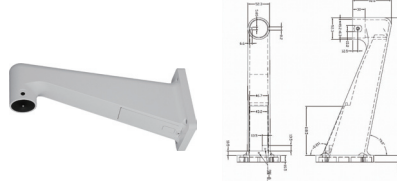

Mini Pendant

VP-MP

Dimensions: 184 x 104 x 115.2 mm (7.24 x 4.09 x 4.54 in)
Diameter: 44.5 mm (1.75 in)
Weight: 600 g (1.3 lbs)

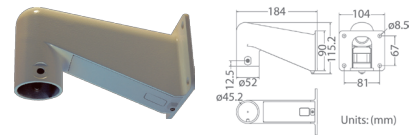

Units: (mm)

Wall Box Mounting

For mounting gooseneck and mini pendants on a wall

VP-WBM

Dimensions: 270 x 166 x 95 mm (10.63 x 6.54 x 3.74 in)
Weight: 2200 g (4.8 lbs)

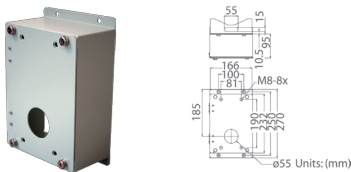

Units: (mm)

Standard Corner Mounting Plate

For mounting gooseneck and mini pendants in a corner

VP-CST

Dimensions: 222 x 204 x 117 mm (8.74 x 8.03 x 4.61 in)
Weight: 2000 g (4.4 lbs)

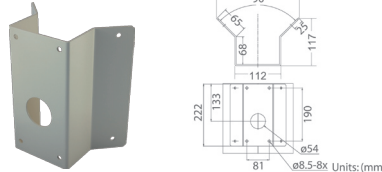

Units: (mm)

Mini Corner Plate

For mounting gooseneck and mini pendants in a corner

VP-CSTM

Dimensions: 270 x 166 x 95 mm (10.63 x 6.54 x 3.74 in)
Weight: 800 g (1.8 lbs)

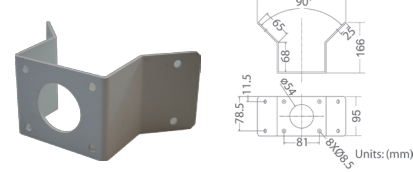

Units: (mm)

Outdoor Thin Pole Direct Mounting

For mounting gooseneck and mini pendants on a pole

VP-PTD

Dimensions: 232 x 136 x 50 mm (9.13 x 5.35 x 1.97 in)
Recommended Pole Diameter: 112 to 130 mm (4.4 to 5.1 in)
Weight: 700 g (1.6 lbs)

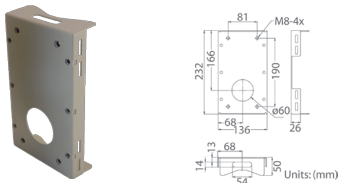

Units: (mm)

Outdoor Wide Pole Direct Mounting

For mounting gooseneck and mini pendants on a pole

VP-PWD

Dimensions: 270 x 170 x 60 mm (10.63 x 6.69 x 2.36 in)
Recommended Pole Diameter: 112 to 140 mm (4.4 to 5.5 in)
Weight: 1000 g (2.2 lbs)

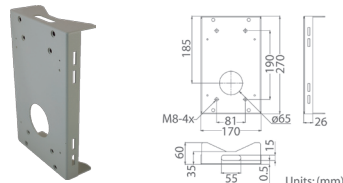

Units: (mm)

Stainless Steel Straps

For direct pole mounting or mounting a pole box on a pole

VP-SS1

Length: 700 mm (27.56 in)
Width: 16 mm (0.63 in)
Weight: 20 g (0.04 lbs)
Note: Four straps are shipped with each order

