

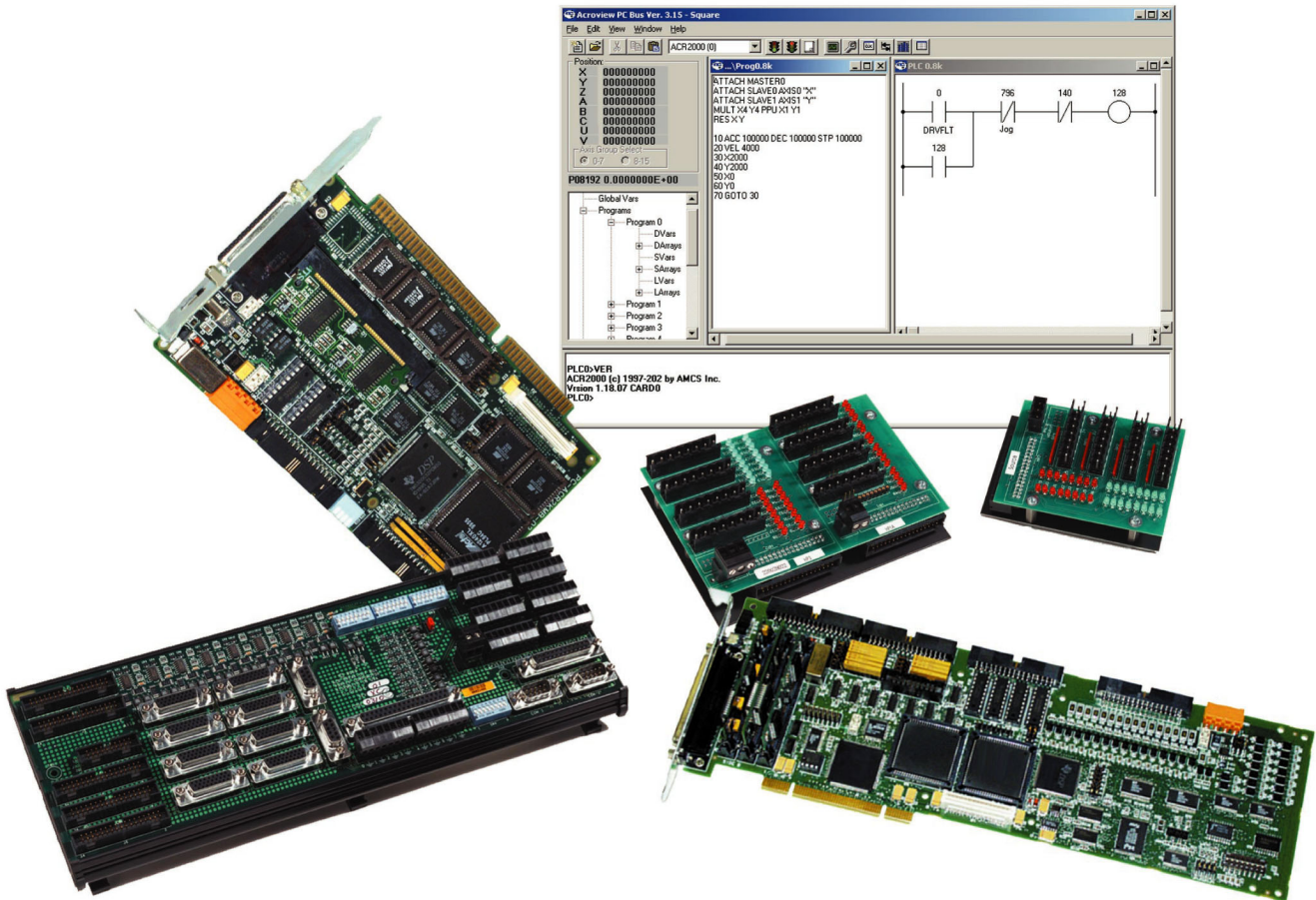

p/n 88-023735-01A

ACRCOMM & ACREXPAXIS Hardware Installation

Effective: February 2004



IMPORTANT

User Information



Warning!



ACR Series products are used to control electrical and mechanical components of motion control systems. You should test your motion system for safety under all potential conditions. Failure to do so can result in damage to equipment and/or serious injury to personnel.

ACR Series products and the information in this user guide are the proprietary property of Parker Hannifin Corporation or its licensors, and may not be copied, disclosed, or used for any purpose not expressly authorized by the owner thereof.

Since Parker Hannifin constantly strives to improve all of its products, we reserve the right to change this user guide and software and hardware mentioned therein at any time without notice.

In no event will the provider of the equipment be liable for any incidental, consequential, or special damages of any kind or nature whatsoever, including but not limited to lost profits arising from or in any way connected with the use of the equipment or this user guide.

© 2004 Parker Hannifin Corporation
All Rights Reserved

Technical Assistance: Contact your local automation technology center (ATC) or distributor, or ...

North America and Asia

Parker Hannifin
5500 Business Park Drive
Rohnert Park, CA 94928
Telephone: (800) 358-9070 or (707) 584-7558
Fax: (707) 584-3793
E-mail: cmr_help@parker.com
Internet: www.parkermotion.com

Germany, Austria, Switzerland

Parker Hannifin
Postfach: 77607-1720
Robert-Bosch-Str. 22
D-77656 Offenburg
Telephone: +49 (0) 781 509-0
Fax: +49 (0) 781 509-176

Europe (non-German speaking)

Parker Hannifin
5500 Business Park Drive
Rohnert Park, CA 94928
Telephone: (800) 358-9070 or (707) 584-7558
Fax: (707) 584-3793
E-mail: emn_support@parker.com
Internet: www.parkermotion.com

Italy

Parker Hannifin
20092 Cinisello Balsamo
Milan, Italy via Gounod, 1
Telephone: +49 (0) 781 509-0
Fax: +49 (0) 781 509-176



Technical Support E-mail

emn_support@parker.com

Table of Contents

| | |
|---|-----------|
| Important Information for Users | iv |
| Chapter 1 – ACRCOMM..... | 2 |
| ACRCOMM Overview | 3 |
| Serial Communications..... | 3 |
| ACRCOMM Hardware Setup..... | 5 |
| Jumpers | 5 |
| Communications—P5 Connector | 8 |
| Chapter 2 – EXPAXIS | 9 |
| EXPAXIS Overview | 10 |
| Cables..... | 10 |
| Encoder Inputs—XP1A, XP1B, and XP1C..... | 12 |
| Hardware Wiring | 16 |
| Module Encoder Pull-ups (Optional)..... | 18 |
| Module Software | 18 |
| Chapter 3 – Additional Specifications..... | 19 |
| Suggested Stacking of Modules..... | 20 |
| Environment and Cooling | 21 |

Table of Tables

| | |
|---|----|
| Figure 1 ACRCOMM RS-422 Interface Schematic..... | 4 |
| Figure 2 ACRCOMM Module—PCI version | 5 |
| Figure 3 EXPAXIS (9-16) Axis Expansion Board for the ACR1505..... | 11 |
| Figure 4 XP1A and XP1B ENCODER connector diagram..... | 13 |
| Figure 5 XP1C ENCODER connector diagram | 14 |
| Figure 6 XP2 ANALOG I/O connector diagram..... | 17 |
| Figure 7 Recommended Stacking for ACR1505 Add-on Modules..... | 20 |

Table of Figures

| | |
|---|----|
| Table 1 COM1: MUX Flags and COM Functions..... | 3 |
| Table 2 Receive/Transmit Flags and COM Functions | 4 |
| Table 3 ACRCOMM Jumper Functions..... | 6 |
| Table 4 ACRCOMM RS-422 Termination Jumpers | 6 |
| Table 5 ACRCOMM Autobaud Detect Jumper | 7 |
| Table 6 ACRCOMM P5 Communications Connector | 8 |
| Table 7 EXPAXIS Feedback devices..... | 12 |
| Table 8 EXPAXIS Encoder Input Connectors XP1A and XP1B | 13 |
| Table 9 EXPAXIS Encoder Input Connector XP1C | 14 |
| Table 10 EXPAXIS XP1C to two 9 Pin D-Sub Connector Pinout | 15 |
| Table 11 EXPAXIS XP9 Connector Pinout | 15 |
| Table 12 EXPAXIS XP10 Connector Pinout | 16 |
| Table 13 EXPAXIS Analog I/O Cable Connector DXP2 | 17 |
| Table 14 EXPAXIS Module Encoder Pull-Up Jumpers..... | 18 |

Important Information for Users

It is important that motion control equipment is installed and operated in such a way that all applicable safety requirements are met. It is your responsibility as an installer to ensure that you identify the relevant safety standards and comply with them; failure to do so may result in damage to equipment and personal injury. In particular, you should study the contents of this user guide carefully before installing or operating the equipment.

The installation, set up, test, and maintenance procedures given in this User Guide should only be carried out by competent personnel trained in the installation of electronic equipment. Such personnel should be aware of the potential electrical and mechanical hazards associated with mains-powered motion control equipment—please see the safety warnings below. The individual or group having overall responsibility for this equipment must ensure that operators are adequately trained.

Under no circumstances will the suppliers of the equipment be liable for any incidental, consequential or special damages of any kind whatsoever, including but not limited to lost profits arising from or in any way connected with the use of the equipment or this guide.



Safety Warning!



High-performance motion control equipment is capable of producing rapid movement and very high forces. Unexpected motion may occur especially during the development of controller programs. **KEEP WELL CLEAR** of any machinery driven by stepper or servo motors. Never touch any part of the equipment while it is in operation.

This product is sold as a motion control component to be installed in a complete system using good engineering practice. Care must be taken to ensure that the product is installed and used in a safe manner according to local safety laws and regulations. In particular, the product must be positioned such that no part is accessible while power may be applied.

This and other information from Parker Hannifin Corporation, its subsidiaries, and authorized distributors provides product or system options for further investigation by users having technical expertise. Before you select or use any product or system, it is important that you analyze all aspects of your application and review the information concerning the product in the current product catalog. The user, through its own analysis and testing, is solely responsible for making the final selection of the system and components and assuring that all performance, safety, and warning requirements of the application are met.

If the equipment is used in any manner that does not conform to the instructions given in this user guide, then the protection provided by the equipment may be impaired.

The information in this user guide, including any apparatus, methods, techniques, and concepts described herein, are the proprietary property of Parker Hannifin or its licensors, and may not be copied, disclosed, or used for any purpose not expressly authorized by the owner thereof.

Since Parker Hannifin constantly strives to improve all of its products, we reserve the right to modify equipment and user guides without prior notice. No part of this user guide may be reproduced in any form without the prior consent of Parker Hannifin.

CHAPTER ONE

ACRCOMM

IN THIS CHAPTER

| | |
|------------------------------------|---|
| • ACRCOMM Overview | 3 |
| • Serial Communications | 3 |
| • ACRCOMM Hardware Setup | 5 |
| • Jumpers..... | 5 |
| • Communications—P5 Connector..... | 8 |

ACRCOMM Overview

The ACRCOMM Plug-In Module provides serial communication ports (2 serial, 1 parallel) capability for the ACR1505 motherboard. ACRCOMM external power input and User-SRAM battery back-up functions are not used with the ACR1505 motherboard. These circuits are not populated on the ACR1505 COMM Board.

This section contains diagrams of the jumpers and switches on the ACRCOMM module.

Serial Communications

The ACR1505 serial communication interface is software configurable. At power-up, the default COM1/COM2 communications mode is RS-232. For ACR1505 boards with the communications option, the serial ports can be configured by a serial port, or at power-up (or any time) via the PCI bus communications port.

Table 1 and Table 2 show the configuration schemes for the ACR1505 board with the serial communication ACRCOMM module option.

Factory Default..... RS-232

MUX Flags

You can set the communications mode for each COM port. Table 1 shows how to set up COM1 and COM2.

| MUX0 | MUX1 | COM Function |
|---------|---------|--------------|
| CLR (0) | CLR (0) | Not Used |
| SET (1) | CLR (0) | RS-232 |
| CLR (0) | SET (1) | RS-422 |
| SET (1) | SET (1) | Not Used |

Note: For bit and flag numbers, see “COM1 Stream Flags” and “COM2 Stream Flags” in “Appendix B” of the “ACR Motion Controller User’s Guide, Part 2.”

Table 1 COM1: MUX Flags and COM Functions

Receive/Transmit Flags

You can set the flow control flags for RS-422 communications mode for each COM port. Table 2 shows how to set up COM1 and COM2.

| Receive Flag | Transmit Flag | COM Function |
|--------------|---------------|---|
| CLR (0) | CLR (0) | Not Used (Default) |
| CLR (0) | SET (1) | Use for RS-422 Operation: Full Duplex Receiver Enabled Transmitter Enabled |
| SET (1) | CLR (0) | Not Used |
| SET (1) | SET (1) | Not Used |

Note: For bit and flag numbers, see “COM1 Stream Flags” and “COM2 Stream Flags” in “Appendix B” of the “ACR Motion Controller User’s Guide, Part 2.”

Table 2 Receive/Transmit Flags and COM Functions

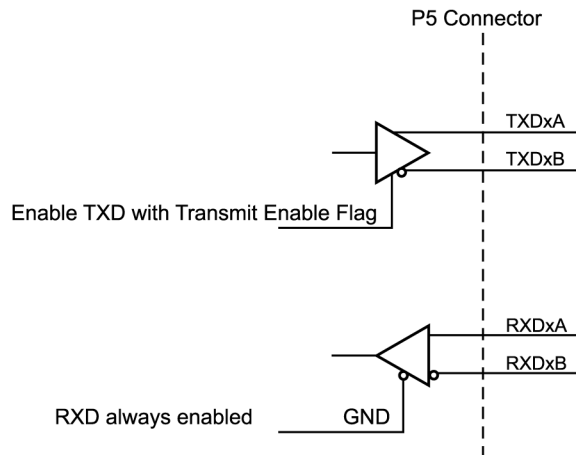

Figure 1 ACRCOMM RS-422 Interface Schematic

ACRCOMM Hardware Setup

The PCI version of the ACRCOMM module (part number SBD12550) does not require an external power source.

Note: In Figure 2, the black square on the jumpers indicates pin 1.

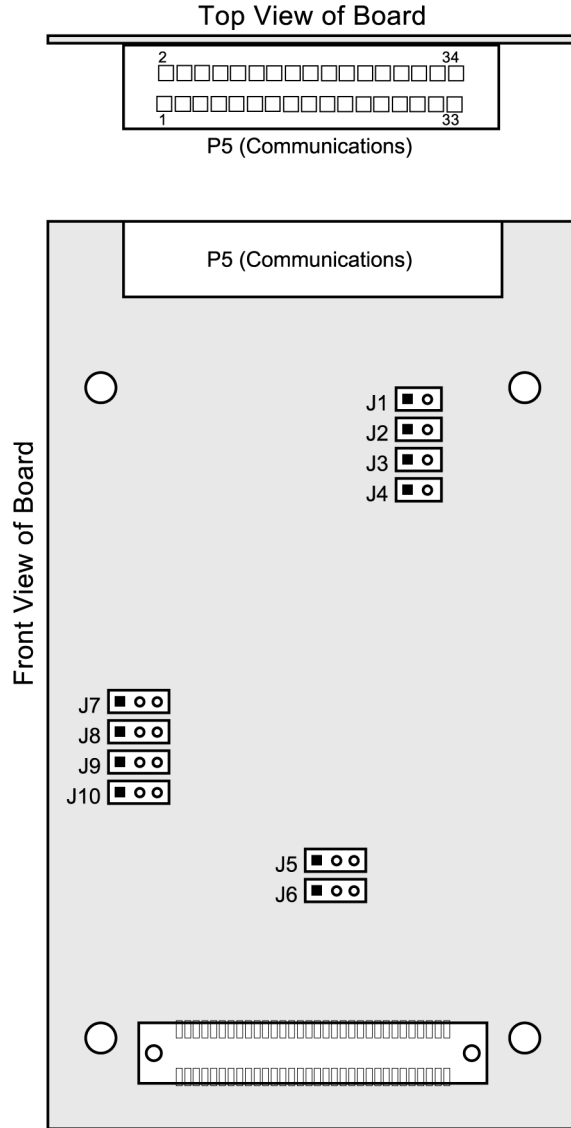



Figure 2 ACRCOMM Module—PCI version



Warning!



The PCI version of the ACRCOMM module is not populated with the following components: F1 through F3, D1 through D3, and PWR2.

If your ACRCOMM module is populated with the above components, you have an ISA version of the ACRCOMM module, which is incompatible with the ACR1505.

Jumpers

The following is a list of the jumper functions on the ACRCOMM module:

| Jumper | Description |
|--------|---|
| J1 | COM1 RS-422 Termination Resistor Select (see Table 4, on page 6) |
| J2 | COM1 RS-422 Termination Resistor Select (see Table 4, on page 6) |
| J3 | COM2 RS-422 Termination Resistor Select (see Table 4, on page 6) |
| J4 | COM2 RS-422 Termination Resistor Select (see Table 4, on page 6) |
| J5 | Not used with the ACR1505 |
| J6 | Not used with the ACR1505 |
| J7 | COM1 and COM2 Autobaud Detect Enable (see Table 4, on page 6) |
| J8 | Reserved |
| J9 | Reserved |
| J10 | Reserved |

Table 3 ACRCOMM Jumper Functions

RS-422 Communication Ports Line Terminator Jumpers (J1 thru J4)

These jumpers provide termination resistors for the RS-422 signals. For jumper locations, see Figure 2 on page 5.

Factory Default..... Jumpers in

| Communication Ports Termination Jumpers | | | |
|---|--------|-------------|----------------|
| Signal | Jumper | Termination | No Termination |
| RXD1A/RXD1B | J1 | Jumper In | Jumper Out |
| TXD1A/TXD1B | J2 | Jumper In | Jumper Out |
| RXD2A/RXD2B | J3 | Jumper In | Jumper Out |
| TXD2A/TXD2B | J4 | Jumper In | Jumper Out |

Table 4 ACRCOMM RS-422 Termination Jumpers

Battery Enable Jumpers (J5 and J6)

These jumpers are not used with the ACR1505 Controller.

Autobaud Detect Jumper (J7)

This jumper enables or disables the Autobaud detect feature of the serial communications channels on the ACRCOMM module. This jumper works in conjunction with the COM1 Startup Mode (P7013) and COM2 Startup Mode (P7029) parameters. For more information, see “Miscellaneous Parameters P6912-P7029” in the “ACR Motion Controller’s User’s Guide Part 2”.

When the COM1/2 Startup Mode parameters (bit 15) are set to zero (factory default-0), the Autobaud detect is enabled and the Autobaud Detect Jumper (J7) is ignored.

When the COM1/2 Startup Mode parameters (bit 15) are set to one, the Autobaud Detect Jumper (J7) defines the autobaud detect function (see Table 5). For jumper locations, see Figure 2 on page 5.

Factory Default..... Autobaud Detect Enabled

| Autobaud Detect Jumper | |
|--------------------------|-----|
| Function | J7 |
| Autobaud Detect Enabled | ON |
| Autobaud Detect Disabled | OFF |

Table 5 ACRCOMM Autobaud Detect Jumper

Communications—P5 Connector

There is one 34 pin header provided on the ACRCOMM module for the 2 serial and 1 parallel communications ports. The two serial ports, COM1 and COM2, can be individually configured as RS-232 or RS-422 interfaces. Configuration of the COM ports is software selectable by the user.

The following diagram shows the connections for the 3 communications ports. For jumper locations, see Figure 2 on page 5.

Note: P5 is a 34-pin shrouded male header.

| Signal | Pin | Signal | Pin |
|--------|-----|--------|-----|
| RXD1 | 1 | TXD1 | 2 |
| GND | 3 | MUX1 | 4 |
| TXD1A | 5 | TXD1B | 6 |
| RXD1A | 7 | RXD1B | 8 |
| RXD2 | 9 | TXD2 | 10 |
| GND | 11 | MUX2 | 12 |
| TXD2A | 13 | TXD2B | 14 |
| RXD2A | 15 | RXD2B | 16 |
| STB | 17 | AFD | 18 |
| ERR | 19 | INIT | 20 |
| SLIN | 21 | GND | 22 |
| PD0 | 23 | PD1 | 24 |
| PD2 | 25 | PD3 | 26 |
| PD4 | 27 | PD5 | 28 |
| PD6 | 29 | PD7 | 30 |
| ACK | 31 | BUSY | 32 |
| PE | 33 | SLCT | 34 |

Table 6 ACRCOMM P5 Communications Connector

CHAPTER TWO

EXPAXIS

IN THIS CHAPTER

| | |
|---|----|
| • EXPAXIS Overview | 10 |
| • Cables | 10 |
| • Encoder Inputs—XP1A, XP1B, and XP1C | 12 |
| • Hardware Wiring..... | 16 |
| • Module Encoder Pull-ups (Optional) | 18 |
| • Module Software | 18 |

EXPAXIS Overview

The EXPAXIS Plug-In Module provides additional axes support to the base ACR1505. A maximum of 8 Axes (Stepper or Servo) and up to 10 Encoders are available. Additionally, either of the 12 Bit or the 16 Bit ADC option can be added to this board.

With the fully loaded EXPAXIS option, an ACR1505 can have up to 12 Servo/Stepper Outputs, 14 Incremental Encoders, and 16 Single Ended (8 Differential) ADC Channels.

Plugs on the EXPAXIS module for ENCODERS, DAC/STEPPER and ADC are different from the base ACR1505 board and caution should be used when wiring.

Cables

The EXPAXIS module has the following cables:

- XP1A—For ENC10,11,12, and 13
- XP1B—For ENC14,15,16, and 17
- XP1C—For ENC18 and19
- XP9—For Stepper power and ground.
- XP10—For High speed interrupt (INTCAP) inputs. EXP-IN0...EXP-IN7 are TTL logic only.
- XP2—For DAC/STEPPER/ADC I/O. (Corresponds to P2 connector on the ACR1505 Controller board.

The P2 connector on the ACR1505 Controller board is a D-Subminiature connector; whereas XP2 on the EXPAXIS module is a 0.1 inch Center Header ribbon cable. To convert the XP2 connector (EXPAXIS module) for use with the P2 connector (ACR1505), use the DXP2 cable assembly (part number PWH80500) supplied with the EXPAXIS module.

Note: There is no watchdog relay on the EXPAXIS module, so the watchdog signals are not wired on the DXP2 cable assembly. Therefore, you must use the watchdog safety contacts from the ACR1505 Controller P2 connector for safeguarding the machine.

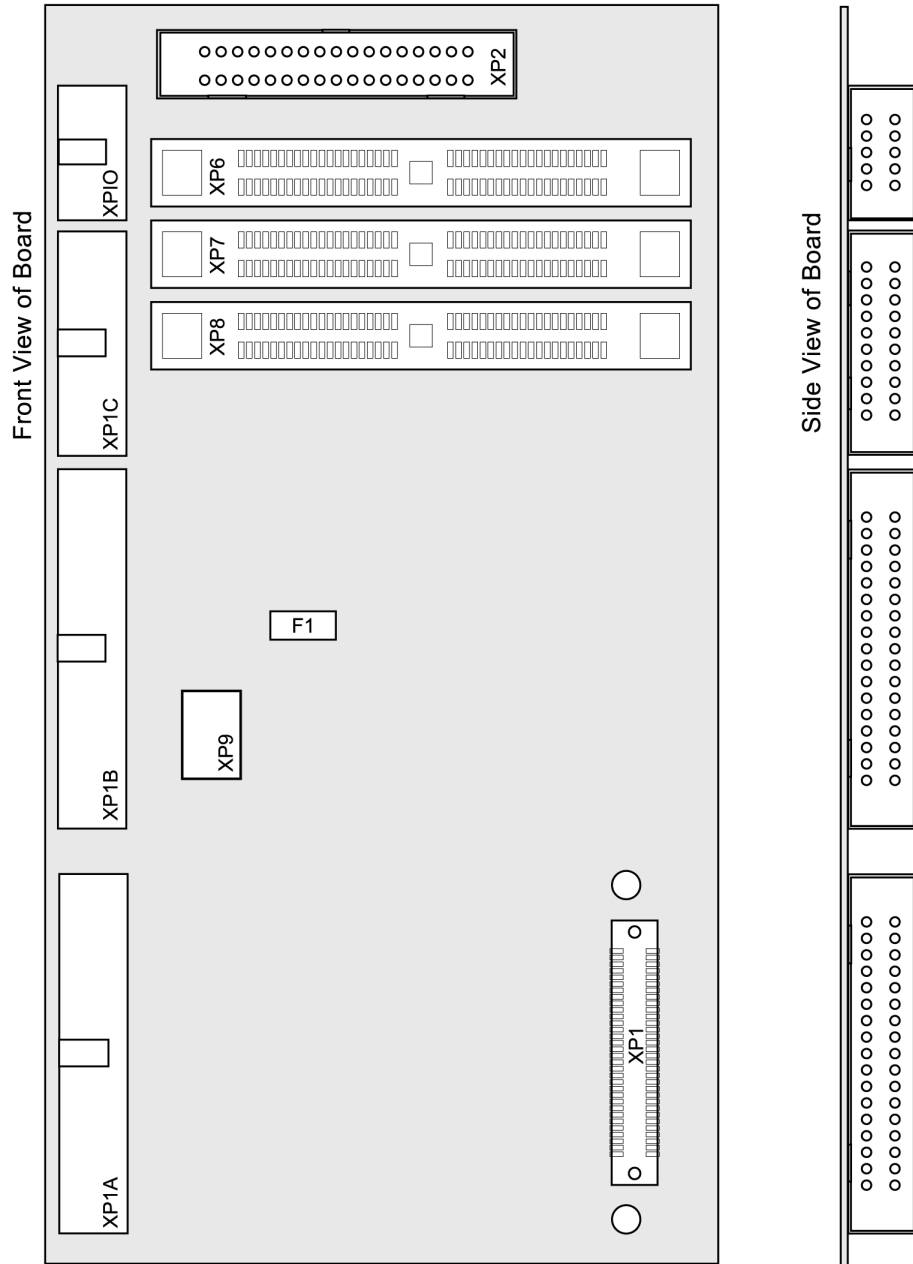

Figure 3 EXPAXIS (9-16) Axis Expansion Board for the ACR1505

Encoder Inputs—XP1A, XP1B, and XP1C

The EXPAXIS module accepts any feedback device that supplies either a +5 VDC or +12 VDC differential signal. The most common type of device is a differential encoder. For common encoder setups, see Table 7. For connector locations, see Figure 3 on page 11.

There are two 34 pin headers and one 20 pin header provided on the EXPAXIS module for encoder feedback. The two 34 pin header provide up to eight (8) axes of encoder feedback (Encoders 10 thru 17). The 20 pin header provides 2 axes of encoder feedback (Encoder 18 and 19). For connector locations, see Figure 3 on page 11.

| EXPAXIS | | |
|---|--|---|
| Encoder | Pull-up Jumper Setting | Length of Cable/Type |
| Differential Line Driver | Remove Pull-ups | 100 ft. (Beldon 9330 Shielded Twisted Pair) |
| Open Collector Driver (No Pull-ups on Encoder) | Install Pull-ups and Jumper to +12 VDC | 75 ft. (Beldon 9330 Shielded Twisted Pair) |
| Open Collector Driver (With Pull-ups to +5 VDC on Encoder) | Install Pull-ups and Jumper to +5 VDC (factory Default) | 50 ft. (Beldon 9330 Shielded Twisted Pair) |
| TTL Driver (+5 VDC Outputs) | Remove Pull-ups | 50 ft. (Beldon 9330 Shielded Twisted Pair) |

Table 7 EXPAXIS Feedback devices

Note: The EXPAXIS module default settings for the encoder input resistor types and configuration are not the same as the base ACR1505 board. The EXPAXIS board is set-up for open-collector drivers with pull-ups to +5V on the encoder inputs.

When using a single-ended encoder (an encoder without the A-, B-, or Z- outputs), additional pull-ups and pull-down resistors must be added externally to the EXPAXIS module in order for the EXPAXIS module to read the encoder signals.

XP1A and XP1B Connector

The XP1A connector provides access to encoders ENC10, ENC11, ENC12, and ENC13, which use jumpers J1, J2, J3, and J4 respectively.

The XP1B connector provides access to encoders ENC14, ENC15, ENC16, and ENC17, which use jumpers J6, J7, J8, and J9 respectively.

XP1A and XP1B are 34-pin shrouded male headers.

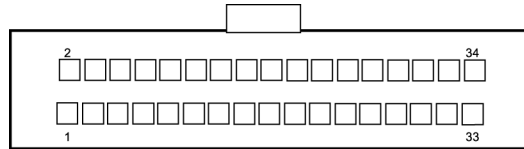

Figure 4 XP1A and XP1B ENCODER connector diagram

| XP1A Pinout | | | | XP1B Pinout | | | |
|---|-----|-----|--------|---|-----|-----|--------|
| Signal | Pin | Pin | Signal | Signal | Pin | Pin | Signal |
| CHA10 | 1 | 2 | CHA10' | CHA14 | 1 | 2 | CHA14' |
| CHB10 | 3 | 4 | CHB10' | CHB14 | 3 | 4 | CHB14' |
| MRK10 | 5 | 6 | MRK10' | MRK14 | 5 | 6 | MRK14' |
| +5 VDC (100 mA, max) | 7 | 8 | GND | +5 VDC (100 mA, max) | 7 | 8 | GND |
| CHA11 | 9 | 10 | CHA11' | CHA15 | 9 | 10 | CHA15' |
| CHB11 | 11 | 12 | CHB11' | CHB15 | 11 | 12 | CHB15' |
| MRK11 | 13 | 14 | MRK11' | MRK15 | 13 | 14 | MRK15' |
| +5 VDC (100 mA, max) | 15 | 16 | GND | +5 VDC (100 mA, max) | 15 | 16 | GND |
| CHA12 | 17 | 18 | CHA12' | CHA16 | 17 | 18 | CHA16' |
| CHB12 | 19 | 20 | CHB12' | CHB16 | 19 | 20 | CHB16' |
| MRK12 | 21 | 22 | MRK12' | MRK16 | 21 | 22 | MRK16' |
| +5 VDC (100 mA, max) | 23 | 24 | GND | +5 VDC (100 mA, max) | 23 | 24 | GND |
| CHA13 | 25 | 26 | CHA13' | CHA17 | 25 | 26 | CHA17' |
| CHB13 | 27 | 28 | CHB13' | CHB17 | 27 | 28 | CHB17' |
| MRK13 | 29 | 30 | MRK13' | MRK17 | 29 | 30 | MRK17' |
| +5 VDC (100 mA, max) | 31 | 32 | GND | +5 VDC (100 mA, max) | 31 | 32 | GND |
| n/c | 33 | 34 | n/c | n/c | 33 | 34 | n/c |
| Note: 100 mA maximum, per encoder. | | | | Note: 100 mA maximum, per encoder. | | | |

Table 8 EXPAXIS Encoder Input Connectors XP1A and XP1B

XP1C Connector

The XP1C connector provides access to encoders ENC18, and ENC19, which use jumpers J5 and J10 respectively.

XP1C is a 20-pin shrouded male header.

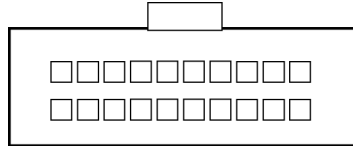

Figure 5 XP1C ENCODER connector diagram

| XP1C Pinout | | | |
|-------------|-----|-------------------------|-----|
| Signal | Pin | Signal | Pin |
| CHA18 | 1 | MRK18' | 2 |
| CHA18' | 3 | +5 VDC (100 mA, max) | 4 |
| CHB18 | 5 | GND | 6 |
| CHB18' | 7 | n/c | 8 |
| MRK18 | 9 | KEY* | 10 |
| CHA19 | 11 | MRK19' | 12 |
| CHA19' | 13 | +5 VDC (100 mA, max) | 14 |
| CHB19 | 15 | GND | 16 |
| CHB19' | 17 | n/c | 18 |
| MRK19 | 19 | n/c | 20 |

* P1C pin 10 is used as a key pin.

Table 9 EXPAXIS Encoder Input Connector XP1C

XP1C is designed to work in conjunction with a 20 pin ribbon cable terminated to two (2) standard 9-pin female D-sub type connectors. This 12 inch cable, AMCS part number PWH015, is supplied with the Encoder 18/19 Option.

Ribbon cable conductors 1 thru 9 connect to D-Subminiature Number 1 (conductor 10 is a No Connect). Ribbon cable conductors 11 thru 19 connect to D-Subminiature Number 2 (conductor 20 is a No Connect). When used in this manner, the D-sub pinouts are as follows:

| XP1C Y-Cable Pinout | | | |
|---------------------|-------------|--------|-------------|
| Signal | D-Sub No. 1 | Signal | D-Sub No. 2 |
| CHA18 | 1 | CHA19 | 1 |
| CHA18' | 2 | CHA19' | 2 |
| CHB18 | 3 | CHB19 | 3 |
| CHB18' | 4 | CHB19' | 4 |
| MRK18 | 5 | MRK19 | 5 |
| MRK18' | 6 | MRK19' | 6 |
| +5 VDC | 7 | +5 VDC | 7 |
| GND | 8 | GND | 8 |
| n/c | 9 | n/c | 9 |

Table 10 EXPAXIS XP1C to two 9 Pin D-Sub Connector Pinout

XP9 Connector

The XP9 connector provides fused, +5 VDC power for open collector stepper outputs. or connector locations, see Figure 3 on page 11.

| XP9 Pinout | | | |
|----------------------|-----|----------------------|-----|
| Definition | Pin | Definition | Pin |
| +5 VDC (250 mA, max) | 1 | +5 VDC (250 mA, max) | 2 |
| +5 VDC (250 mA, max) | 3 | +5 VDC (250 mA, max) | 4 |
| GND | 5 | GND | 6 |
| RESERVED | 7 | RESERVED | 8 |
| RESERVED | 9 | RESERVED | 10 |
| GND | 11 | GND | 12 |
| RESERVED | 13 | RESERVED | 14 |
| RESERVED | 15 | RESERVED | 16 |

Table 11 EXPAXIS XP9 Connector Pinout

XP10 Connector

The XP10 connector provides +5 VDC TTL I/O for `INTCAP` and other special functions. For connector locations, see Figure 3 on page 11.

Voltage +5 VDC

Current Rating 0.100A maximum

| XP10 Pinout | | | |
|-------------|-----|------------|-----|
| Definition | Pin | Definition | Pin |
| EXP_IN0 | 1 | EXP_IN1 | 2 |
| EXP_IN2 | 3 | EXP_IN3 | 4 |
| EXP_IN4 | 5 | EXP_IN5 | 6 |
| EXP_IN6 | 7 | EXP_IN7 | 8 |
| EXP_OUT0 | 9 | EXP_OUT1 | 10 |
| RESERVED | 11 | RESERVED | 12 |
| RESERVED | 13 | RESERVED | 14 |

Table 12 EXPAXIS XP10 Connector Pinout

F1 Fuse

When replacing fuses for the EXPAXIS module, use the following tables to determine the correct part numbers for different vendors.

For fuse location, see Figure 3 on page 11.

Voltage +5 VDC

Current Rating 0.250A

Type Littelfuse 454.500
Time Delay Fuse

Hardware Wiring

Analog I/O—XP2

The Analog I/O connections on the EXPAXIS module is a 40 Pin Header. To convert the XP2 connector (EXPAXIS module) for use with the P2 connector (ACR1505), use the DXP2 cable assembly (part number PWH80500) supplied with the EXPAXIS module.

The XP2 connector is not pin compatible with the P2 connector on the ACR1505. This is because the ACR1505 has differential stepper outputs and the watchdog relay.

Important!: Single-ended encoders are not recommended mode of operation. Noise immunity is significantly reduced.

Note: DXP2 is a standard 40-pin female D-plug.

XP2 is a 40-pin shrouded male header.

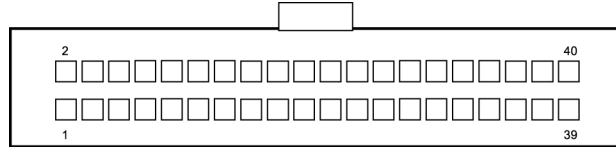

Figure 6 XP2 ANALOG I/O connector diagram

| DXP2 Pinout | | | | Module |
|---------------------|-----|-----|--------------------|----------|
| Definition | Pin | Pin | Definition | |
| ASIG-8 (STEP-8) | 1 | 20 | AGND-8 (DIR-8) | |
| ASIG-9 (STEP-9) | 2 | 21 | AGND-9 (DIR-9) | Module 0 |
| ASIG-10 (STEP-10) | 3 | 22 | AGND-10 (DIR-10) | |
| ASIG-11 (STEP-11) | 4 | 23 | AGND-11 (DIR-11) | |
| ASIG-12 (STEP-12) | 5 | 24 | AGND-12 (DIR-12) | |
| ASIG-13 (STEP-13) | 6 | 25 | AGND-13 (DIR-13) | Module 1 |
| ASIG-14 (STEP-14) | 7 | 26 | AGND-14 (DIR-14) | |
| ASIG-15 (STEP-15) | 8 | 27 | AGND-15 (DIR-15) | |
| AIN-8 | 9 | 28 | AIN-9 | |
| AIN-10 | 10 | 29 | AIN-11 | Module 2 |
| AIN-12 | 11 | 30 | AIN-13 | |
| AIN-14 | 12 | 31 | AIN-15 | |
| (LCUR-8) | 13 | 32 | (LCUR-9) | Module 0 |
| (LCUR-10) | 14 | 33 | (LCUR-11) | |
| (LCUR-12) | 15 | 34 | (LCUR-13) | Module 1 |
| (LCUR-14) | 16 | 35 | (LCUR-15) | |
| RESERVED | 17 | 36 | RESERVED | None |
| RESERVED | 18 | 37 | RESERVED | None |
| AGND | 19 | | RESERVED | Module 2 |

Note: Pin definitions in parentheses are for stepper modules.

Table 13 EXPAXIS Analog I/O Cable Connector DXP2

Module Encoder Pull-ups (Optional)

The ACR1505 can supply +5 VDC or +12 VDC pull-up resistors to each encoder. Use Table 14 to determine the correct jumper configurations. For jumper locations, see Figure 3 on page 11.

Factory Default..... Configured for +5 VDC for standard Parker encoders

| Encoder Pull-Up Jumpers | | | | |
|-------------------------|----------|--------|------------|------------|
| Encoder | Resistor | Jumper | +5 VDC | +12 VDC |
| 10 | RP1 | JP1 | Pins 1 & 2 | Pins 2 & 3 |
| 11 | RP2 | JP2 | Pins 1 & 2 | Pins 2 & 3 |
| 12 | RP3 | JP3 | Pins 1 & 2 | Pins 2 & 3 |
| 13 | RP4 | JP4 | Pins 1 & 2 | Pins 2 & 3 |
| 14 | RP6 | JP6 | Pins 1 & 2 | Pins 2 & 3 |
| 15 | RP7 | JP7 | Pins 1 & 2 | Pins 2 & 3 |
| 16 | RP8 | JP8 | Pins 1 & 2 | Pins 2 & 3 |
| 17 | RP9 | JP9 | Pins 1 & 2 | Pins 2 & 3 |
| 18 | RP5 | JP5 | Pins 1 & 2 | Pins 2 & 3 |
| 19 | RP10 | JP10 | Pins 1 & 2 | Pins 2 & 3 |

Table 14 EXPAXIS Module Encoder Pull-Up Jumpers

Module Software

To access axes 9 through 16, refer to the software manual for the commands. In addition, AcroView Version 3.11 and higher can display the extra parameters, and show and program axes 9 through 16.

CHAPTER THREE

Additional Specifications

IN THIS CHAPTER

- Suggested Stacking of Modules 20
- Environment and Cooling..... 21

Suggested Stacking of Modules

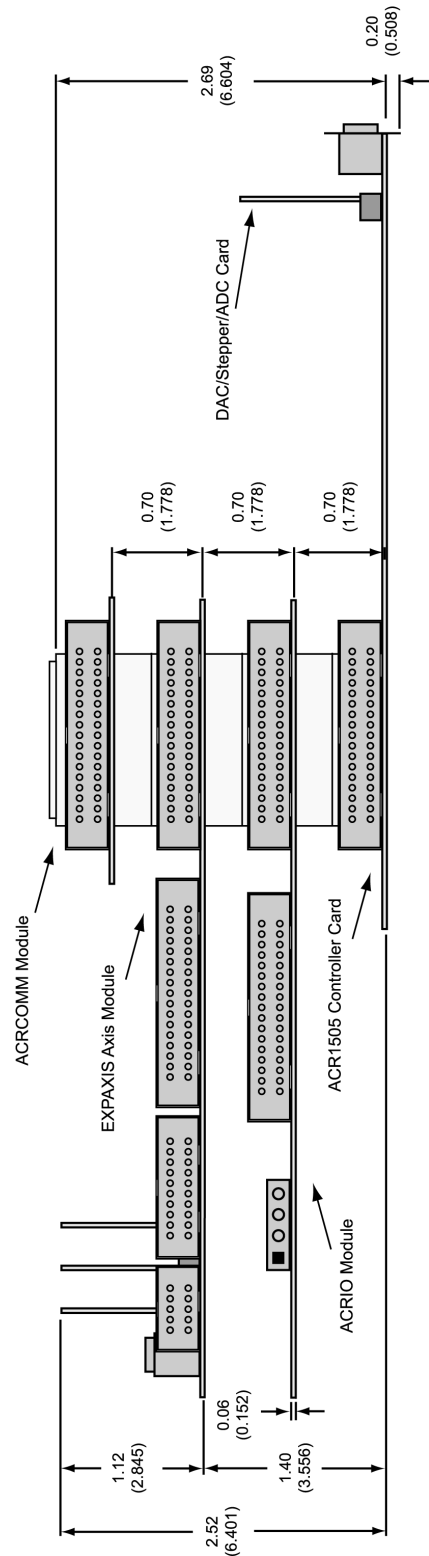

Figure 7 Recommended Stacking for ACR1505 Add-on Modules.

Environment and Cooling

The Add-on modules operates in an ambient temperature range of 0°C (32°F) to 45°C (113°F). The modules can tolerate atmospheric pollution degree 2—only dry, non-conductive pollution is acceptable. Therefore, it is recommended that the cards be mounted in a suitable enclosure.

As you add modules, you must ensure that there are no hot spots created in the board stack due to airflow impairment.

Airflow impairment might result from cables coming in the way or lack of fan direction towards the stack. Record the temperature in several places (especially around I/O and DSP locations) to ensure even heat flow. Impaired heat flow might cause malfunctions and eventually lead to permanent loss of function.

Ambient Operating Temperature 0°C (32°F) to 45°C (113°F)

Storage Temperature –40°C to 85°C (–40°F to 185°F)

Humidity 0–95%, non-condensing

Pollution Degree..... 2 (per IEC 61010)

Installation Category 2 (per IEC 61010)

Index

| | | | |
|------------------------------|----|-------------------------------|------------|
| ACRCOMM module..... | 3 | XP9..... | 15 |
| autobaud detect..... | 7 | fuse | 16 |
| connector, P5..... | 8 | jumper | |
| hardware setup..... | 5 | resistor packs | 12, 18 |
| jumpers..... | 6 | voltage configuration | 12, 18 |
| autobaud..... | 7 | watchdog | 10 |
| battery enable | 7 | feedback | |
| termination..... | 6 | encoder input | 12 |
| serial communications | | fuses | |
| MUX flags | 3 | EXPAXIS module..... | 16 |
| receive/transmit flags | 4 | locations | 11 |
| add-on modules | | inputs | |
| cooling | 21 | encoder..... | 12 |
| environment | 21 | installation category | 21 |
| stacking..... | 20 | jumpers | |
| autobaud detect..... | 7 | ACRCOMM module..... | 6 |
| environment..... | 21 | pollution degree..... | 21 |
| EXPAXIS module | | RS-232 | 3 |
| axes 9-16 | 18 | RS-422 | 3, 4, 6, 8 |
| cables..... | 10 | specifications | |
| connector | | cooling | 21 |
| XP10 | 16 | environmental | 21 |
| XP1A | 13 | technical support | ii |
| XP1B | 13 | temperature, environment..... | 21 |
| XP1C | 14 | watchdog signal..... | 10 |
| XP2 | 16 | | |