

Visualisation; Diagnostics

Easy to Configure

Programming IEC



Control technology

PILZ
THE SPIRIT OF SAFETY

- ▶ Relays: Electronic monitoring relays PMDsigma and PMDsigma, safety relay PNOZsigma, PNOZ X, PNOZcompact, PNOZelog and PNOZpower
- ▶ Configurable small controllers PNOZmulti 2, PNOZmulti Mini, PNOZmulti
- ▶ Controllers and I/O systems PSSuniversal, PSSuniversal 2
- ▶ Automation system PSS 4000





Pilz control technology –
for safety and automation.

► Control technology

Pilz offers the right solution for every control technology situation. From stand-alone applications to networked and distributed systems – for safety and automation. Meet your automation requirements cost-effectively, reliably and from a single source with optimally matched components and systems: from the simple monitoring relays PMD to safety relays PNOZ, the configurable small controllers PNOZmulti and the programmable controllers PSSuniversal PLC. They will allow you to implement a multitude of applications in compliance with the relevant standards. Our software tools enable simple operation and make commissioning easier. Combine that with network components and software and you get complete automation architectures. Benefit from short downtimes and high plant availability due to extensive diagnostic options.

Contents

Pilz automation solutions	6	Decentralized modules PDP67	110
		► Cable navigator	112
Control technology	8	Controllers and I/O systems	114
Relays	10	► Controllers and I/O systems PSSuniversal	116
► Electronic monitoring relays PMDsigma	12	► Automation system PSS 4000	118
► Electronic monitoring relays PMDsrangle	14	► Visualization software PASvisu	122
► Safety relays PNOZ	18	► Visualization terminal PMLvisu	123
- Safety relays PNOZsigma	22	► Decentralized I/O system PSSuniversal	124
- Safety relays PNOZ X	36	► Remote I/O system PSSuniversal 2	144
- Safety relays PNOZcompact	44	Index	150
- Safety relays PNOZelog	46	Services	152
- Safe line inspection device PLIDdys	54		
- Safety relays PNOZpower	56		
► Safety Device Diagnostics	62		
Configurable small controllers	66		
► Configurable small controllers PNOZmulti	68		
► Configurable control systems PNOZmulti 2	74		
► Configurable compact controllers			
PNOZmulti Mini	84		
► Configurable safety systems PNOZmulti	92		
► Software tools PNOZmulti	106		
► Accessories PNOZmulti	108		



Pilz is your solution supplier for all automation tasks. Including standard control functions. Pilz developments protect man, machine and the environment.

Pilz has a tradition as a family-run company stretching back over 60 years. Real proximity to customers is visible in all areas, instilling confidence through individual consultation, total flexibility and reliable service. Worldwide, round the clock, in 42 subsidiaries and branches, as well as 27 sales partners on every continent.

More than 2200 staff, each one of them an ambassador for safety, make sure that your staff – your company's most valuable asset – can work safely and free from injury.

SERVICES

Consulting, engineering
and training

Economical

PILZ
THE SPIRIT OF SAFETY



Automation
solutions from Pilz –
at home in every
industry.



Visualisation; Diagnostics

Easy to Configure

Pilz automation solutions

Pilz offers everything that you need for the automation of your plant and machinery: Innovative components and systems in which safety and automation are merged within hardware and software.

From sensor and control technology to drive technology, the ease of commissioning, operation and

diagnostics plays an important role for all components and systems from Pilz.

You benefit from flexible solutions for machines with an elementary function range through to large interlinked plants. With us you can standardize your safety, implement safety and automation in one periphery or find solutions for complete automation.

Pilz solutions are embedded into the relevant system environment – whether a new structure or a retrofit – and are open for a variety of interfaces and functionalities.

The perfect combination:

Control technology from Pilz offers numerous application options, including monitoring of electrical



Pilz automation solutions

- ▶ Simple configuration, programming and visualization through innovative software solutions
- ▶ High flexibility due to individually expandable solutions
- ▶ Openness of communication
- ▶ High availability thanks to extensive diagnostic options
- ▶ One system for safety and automation

and functional safety, through to complete machine control.

Safe sensors and decentralized modules from Pilz guarantee the efficient, compliant use of plant and machinery in combination with various control systems. Our turnkey systems and universally compatible solutions offer a high savings potential.

Drive technology from Pilz is characterized by drive-integrated safety functions, safe logic functions and the connection of visualization, sensor and actuator technology.

Operator and visualization systems from Pilz complete your plant and machinery.

Automation software from Pilz allows you to quickly and easily implement your planning, programming, configuration, commissioning, diagnostics and visualization.

Pilz offers you automation solutions for the safety of man, machine and the environment.

► Pilz control technology – for safety and automation

The optimum solution for every requirement – with these control systems and components you can implement each application in compliance with the standards. User-friendly software assists you in implementing your automation projects. From a stand-alone machine to networked plants – with us your automation can be complete and simple.

Small machines or interlinked plants: the optimum solution for your specific automation task!

Relays

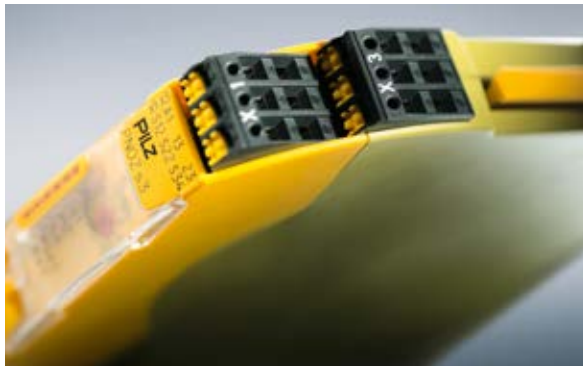

Easy to configure!

- Reliability of one of the leading brands in automation technology
- Optimum cost/performance ratio
- Maximum safety with minimum space requirement
- Certified safety, because international standards and regulations are met
- Fast commissioning thanks to units with plug-in connection terminals

Page 10

Webcode: web150079

Configurable small control systems



Configuration made simple!

- Cost-effective and long-lasting: worldwide safety standard for many automation environments and communication systems
- Flexible: configuration using certified software blocks, simple adjustment and adaptation
- Just one system from planning to maintenance
- Exact adaptation to the application using expansion modules
- Optimum visualization using the web-based visualization software PASvisu

Page 66

Webcode: web150495

Control systems



I/O systems



Simple programming of large plants!

- ▶ Processing of safety and automation functions
- ▶ Can be used as a stand-alone controller or as part of a network
- ▶ Intuitive programming of complex functions
- ▶ High level of flexibility thanks to modular system structure
- ▶ Extensive selection of modules to meet your specific requirements

Page 118

Webcode: web150509

System for third-party controllers

- ▶ Communication with the controller takes place via common fieldbus protocols
- ▶ Functions for safety and automation are processed decentrally at field level
- ▶ Fast commissioning and simple configuration thanks to the independent periphery test
- ▶ High level of flexibility thanks to modular system structure

PSSuniversal: page 124

Webcode: web150509

PSSuniversal 2: page 144

Webcode: web150509

▶ Relays

Electrical or functional safety – our relays provide the perfect solution for any application at an optimum cost/performance ratio. Choose one of the leading brands in automation technology – a brand with many years of experience and outstanding service.

Product range monitoring relays PMD

- | | |
|---|----|
| ▶ Electronic monitoring relays PMDsigma | 12 |
| ▶ Electronic monitoring relays PMDsrage | 14 |

Product range safety relays PNOZ

- | | |
|---------------------------------------|----|
| ▶ Safety relays PNOZsigma | 18 |
| ▶ Safety relays PNOZ X | 22 |
| ▶ Safety relays PNOZcompact | 36 |
| ▶ Safety relays PNOZelog | 44 |
| ▶ Safe line inspection device PLIDdys | 46 |
| ▶ Safety relays PNOZpower | 54 |
| | 56 |

Product group

- | | |
|----------------------------------|----|
| Safety Device Diagnostics | 62 |
|----------------------------------|----|





▶ Electronic monitoring relays PMDsigma

With electronic monitoring relays, the focus is on electrical safety. Monitoring relays reduce the number of hazardous situations for man and machine and increase the service life of plant and machinery. Save costs and be sure of an efficient production cycle.



PMD s10

Applications PMD s10

Using the measured true power, it is possible to derive variables such as fill level, volume, torque or air pressure. The following example applications illustrate potential areas of use:

- ▶ Contamination of sieves or filters on ventilation systems
- ▶ To check for dry running or pump blockage
- ▶ Viscosity of fluids on mixers
- ▶ Wear and tear on tools
- ▶ To control the brush pressure on car washes
- ▶ To monitor conveyors for blockages or wear and tear



Technical details – Electronic monitoring relays PMDsigma



PMD s20

Type	Application area	Features
PMD s10	Monitoring and conversion of true power for single/three-phase AC/DC supplies, monitoring of overload and underload. Suitable for use with frequency-controlled motors and current transformers.	<ul style="list-style-type: none"> ▶ Menu-driven stepless adjustment of function parameters via display and rotary knob ▶ Display for measurements, diagnostics and menu navigation ▶ Measuring range is set automatically for current and voltage
PMD s20	Monitors the insulation resistance of unearthed AC/DC power supplies (IT networks), e.g. on ships, in areas used for medical applications, as a trigger when impermissible insulation resistances occur. Meets the requirements of DIN EN 61557-8, IEC 60364-7-710 and DIN VDE 0100-710.	<ul style="list-style-type: none"> ▶ Response value R_{on}: selectable from 10 ... 200 kΩ ▶ Rated mains voltage: 0 ... 400 V AC/DC ▶ Rated mains voltage U_L: 0 ... 300 V AC/DC

Applications PMD s20

The PMD s20 can be used to monitor the insulation resistance of unearthed AC/DC systems. Thanks to the separate supply voltage, monitoring of the de-energized system is possible. Typical application areas include:

- ▶ Clinical operating theatres
- ▶ Offshore installations such as wind turbines, sewage treatment plants and shiplifts
- ▶ Electroplating and surface finishing systems

Your benefits at a glance

- ▶ Quick and easy settings using the rotary knob (push and turn) to reduce set-up and commissioning times
- ▶ Error-proof: menu-guided configuration with device-internal cross-comparison
- ▶ Simple handling when replacing devices thanks to exchangeable program memory for porting data
- ▶ Minimal downtimes thanks to extended diagnostics and measurement indication via display



	Approvals	Order number
<ul style="list-style-type: none"> ▶ Analog output for current and voltage: voltage output 0 ... 10 V, current output convertible from 0 ... 20 mA to 4 ... 20 mA ▶ 2 relay outputs (auxiliary contacts (C/O)) for monitoring underload and overload ▶ Measuring voltage (3 AC), U_M (AC/DC): 100 ... 550 V ▶ Measuring current (I_M): 1 ... 12 A AC/DC ▶ Dimensions (H x W x D) in mm: 100/98¹⁾ x 45 x 120 	CE, cULus Listed	<ul style="list-style-type: none"> ▶ Spring-loaded terminals PMD s10 C _____ 761 100 ▶ Plug-in screw terminals PMD s10 _____ 760 100
<ul style="list-style-type: none"> ▶ Supply voltage U_B AC/DC: 24 ... 240 V AC/DC ▶ Frequency range AC: 50 ... 60 Hz ▶ Start suppression/reaction time: selectable from 0 ... 30 s ▶ Hysteresis: selectable from 0 ... 50 % ▶ Dimensions (H x W x D) in mm: 100/98¹⁾ x 45 x 120 	CE, cULus Listed	<ul style="list-style-type: none"> ▶ Spring-loaded terminals PMD s20 C _____ 761 120 ▶ Plug-in screw terminals PMD s20 _____ 760 120

Keep up-to-date on PMDsigma:

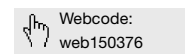

Online information at www.pilz.com

¹⁾ Height incl. spring-loaded terminals/plug-in screw terminals

▶ Electronic monitoring relays PMDsrange

With monitoring relays, the focus is on the protection of persons and machinery against insulation faults, residual voltages, overvoltage, overcurrent, overload, temperature overload as well as monitoring standstill and true power. Significantly reduce hazardous situations for human and machine, while at the same time increasing the service life of your plant.



S3UM



S1IM



S1WP

Taking control of every situation

Reliable electronic monitoring and control of your plant or machinery is always the priority. Save costs and guarantee an efficient production cycle. Simply by using monitoring relays! You'll find the right device for every monitoring task.

User-friendly features

PMDsrange units in 22.5 mm slimline housing cover the widest range of functions. Selectable measuring ranges and a high number of operating voltages enable flexible use. Quick and easy installation, practical terminals, a variety of operator elements as well as luminous displays all help to make commissioning easier and ensure the units are perfectly tailored to your specific application.



Many applications

You can use the PMDsrage devices in a multitude of applications: for monitoring the temperature of motors, for monitoring voltage at bottle conveyor systems, to monitor blockages at pumps, and many other applications.

Your benefits at a glance

- ▶ Parameters can be set on the front, thereby reducing commissioning times
- ▶ Save space in the control cabinet: widths of just 22.5 mm
- ▶ Rapid diagnostics via LED status display

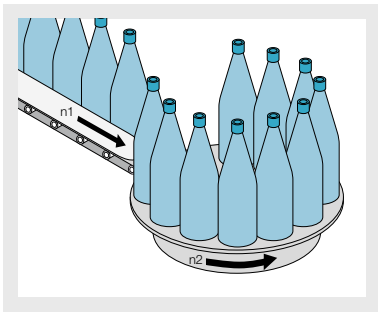

Bottling plant with voltage monitoring

Use voltage monitors, for example, to monitor voltage supplies on bottling plants. The monitoring relay ensures that the plant is shut down in a controlled manner. It also protects against an uncontrolled restart.

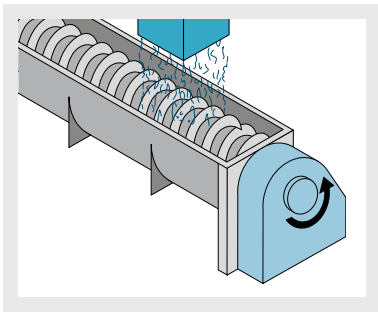

Screw conveyor with current monitoring

You need to monitor current, e.g. at a screw conveyor? It can provide protection against blockage and wear and tear, thereby helping with preventive maintenance.

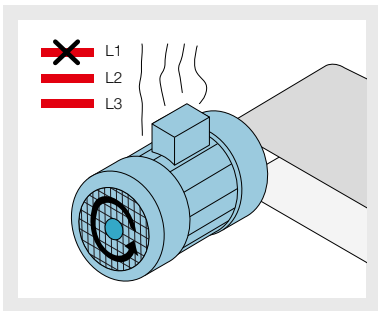

Motor with thermistor monitoring

Use thermistor monitoring to protect your motors from overheating. Also prevent automatic start-up. This is particularly important for adverse cooling and where frequent start-up or braking of the motor is required. Thermistor monitoring relays such as S1MS are also available with ATEX approval.

Keep up-to-date on PMDsrage:

Webcode: web150375

Online information at www.pilz.com

► Technical details – PMDsrage

Selection guide – Electronic monitoring relays PMDsrage



S3UM



S1PN



S1IM



S1EN



S1WP



S1MS

Type	Application area
S3UM	<p>Monitoring of overvoltage and undervoltage as well as the phase sequence in three-phase supplies</p> <ul style="list-style-type: none"> ▶ Monitoring of supplies with and without neutral conductors ▶ Trip device for undervoltage and overvoltage ▶ Evaluates phase sequence ▶ Detects asymmetry and phase failure
S1PN	<p>Monitoring of phase sequence and phase failure on three-phase supplies</p> <ul style="list-style-type: none"> ▶ Measuring voltage up to 690 V AC ▶ Monitoring of rotary field direction = phase sequence, rotation direction on drives
S1IM	<p>Monitors AC/DC currents for max. current values, single-phase</p> <ul style="list-style-type: none"> ▶ 12 measuring ranges from 0.002 ... 15 A, selectable ▶ Reaction time can be set to up to 10 seconds ▶ Operates to either normally energized or normally de-energized mode ▶ Galvanic isolation between measuring and supply voltage ▶ UP version: measuring inputs are not polarity-sensitive
S1EN	<p>Monitoring of insulation and earth faults on galvanically isolated AC/DC supplies (IT networks), single and three-phase. Meets the requirements of DIN EN 61557-8</p> <ul style="list-style-type: none"> ▶ For DC and AC supplies ▶ Normally energized mode ▶ Fault latching or automatic reset ▶ Normal/test mode ▶ External reset button can be connected
S1WP	<p>Monitoring and conversion of true power, DC supplies and single-/three-phase AC supplies, monitoring of overload and underload</p> <ul style="list-style-type: none"> ▶ 9 different measuring ranges ▶ Large voltage measuring range ▶ Analog output can be switched for current and voltage ▶ Relay output for monitoring underload and overload ▶ Suitable for use with frequency-controlled motors ▶ Suitable for current transformers
S1MS	<p>Temperature monitoring circuits in accordance with DIN EN 44081 to protect motors, generators, storage areas, etc. from overheating</p> <ul style="list-style-type: none"> ▶ For DC and AC supplies ▶ Normally energized mode ▶ Measuring circuit for connecting a temperature sensor (PTC resistor) ▶ Automatic reset
S1MS Ex	<p>As for S1MS, potentially explosive areas: II (3) G [Ex ic] IIC Gc and II (3) D [Ex ic] IIIC Dc</p>

Common features

- ▶ Dimensions (H x W x D) in mm: 87 x 22.5 x 121
- ▶ Selectable measuring ranges available in many operating voltages
- ▶ With screw terminals

Technical features	Approvals	Order number ¹⁾
<ul style="list-style-type: none"> ▶ Supply voltage (U_B): AC: 120, 230 V; DC: 24 V ▶ Output contact: 1 auxiliary contact (C/O) ▶ Measuring voltage (3 AC) (U_M): AC: 42, 100/110, 230, 400/440, 440/480, 415/460, 500/550 V, selectable 	<ul style="list-style-type: none"> ▶ CE, cULus Listed, CCC ▶ CE, CCC ▶ CE, CCC 	<ul style="list-style-type: none"> ▶ 24 V DC (U_B), 230 V AC (U_M) _____ 837 260 ▶ 24 V DC (U_B), 400/440 V AC (U_M) ____ 837 270 ▶ 24 V DC (U_B), 415/460 V AC (U_M) ____ 837 280
<ul style="list-style-type: none"> ▶ Supply voltage (U_B): AC: 200 ... 240, 400 ... 500, 550 ... 690 V ▶ Output contacts: 2 auxiliary contacts (2 C/O) 	<ul style="list-style-type: none"> ▶ CE, cULus Listed, CCC ▶ CE, CCC ▶ CE, CCC 	<ul style="list-style-type: none"> ▶ 200 ... 240 V _____ 890 200 ▶ 400 ... 500 V _____ 890 210 ▶ 550 ... 690 V _____ 890 220
<ul style="list-style-type: none"> ▶ Supply voltage (U_B): AC: 24, 42 ... 48, 110 ... 127, 230 ... 240 V; DC: 24 V ▶ Output contact: 1 auxiliary contact (C/O) 	CE, cULus Listed, CCC	<ul style="list-style-type: none"> ▶ 110 ... 130 V AC (U_B), 15 A (I_M) _____ 828 040 ▶ 230 ... 240 V AC (U_B), 15 A (I_M) _____ 828 050 ▶ 24 V DC (U_B), 15 A (I_M) _____ 828 035
<ul style="list-style-type: none"> ▶ Supply voltage (U_B): AC/DC: 24 ... 240 V ▶ Output contact: 1 auxiliary contact (C/O) ▶ Rated mains voltage (monitored supply): <ul style="list-style-type: none"> - 50 kΩ version: AC/DC: 0 ... 240 V - 200 kΩ version: AC/DC: 0 ... 400 V ▶ Max. measuring current (DC): <ul style="list-style-type: none"> - 50 kΩ version: 2.4 mA - 200 kΩ version: 1.0 mA 	CE, cULus Listed, CCC	<ul style="list-style-type: none"> ▶ 24 ... 240 V AC/DC (U_B), 50 kΩ ____ 884 100 ▶ 24 ... 240 V AC/DC (U_B), 200 kΩ ____ 884 110
<ul style="list-style-type: none"> ▶ Supply voltage (U_B): DC: 24 V; AC/DC: 230 V ▶ Output contact: 1 auxiliary contact (C/O) ▶ Measuring voltage: <ul style="list-style-type: none"> 3 AC/DC: 0 ... 120, 0 ... 240, 0 ... 415, 0 ... 550 V 1 AC/DC: 0 ... 70, 0 ... 140, 0 ... 240, 0 ... 320 V 	CE, cULus Listed, UL/cUL, CCC	<ul style="list-style-type: none"> ▶ 24 V DC (U_B), 0 ... 240 V AC/DC (U_M), 9 A (I_M) _____ 890 010 ▶ 24 V DC (U_B), 0 ... 415 V AC/DC (U_M), 9 A (I_M) _____ 890 020 ▶ 24 V DC (U_B), 0 ... 550 V AC/DC (U_M), 9 A (I_M) _____ 890 030
<ul style="list-style-type: none"> ▶ Supply voltage (U_B): AC: 48, 110, 230, 240, 400 V; AC/DC: 24 V ▶ Output contacts: 2 auxiliary contacts (2 C/O) 	<ul style="list-style-type: none"> ▶ CE, cULus Listed, CCC ▶ CE, cULus Listed, CCC ▶ CE, CCC 	<ul style="list-style-type: none"> ▶ 24 V AC/DC (U_B) _____ 839 775 ▶ 230 V AC (U_B) _____ 839 760 ▶ 400 V AC (U_B) _____ 839 770
<ul style="list-style-type: none"> ▶ Supply voltage (U_B): AC: 48, 110, 230, 240 V; AC/DC: 24 V ▶ Dimensions (H x W x D) in mm: 112.5 x 26 x 135 	CE, cULus Listed, CCC	<ul style="list-style-type: none"> ▶ 24 V AC/DC _____ 839 775 ▶ 230 V AC _____ 839 760 ▶ 240 V AC _____ 839 765

¹⁾ Other versions on request

Order number features: U_B = Supply voltage;
U_M = Measuring voltage; I_M = Measuring current

Technical documentation for electronic monitoring relays PMDsrangle:

 Webcode: web150635









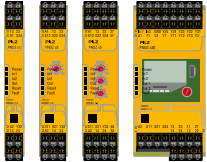

Online information at www.pilz.com

▶ Safety relays PNOZ®

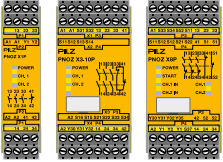
In 1987, Pilz patented the first E-STOP relay to protect man and machine. That was a milestone in safety technology. Today, the PNOZ safety relays are proven daily in millions of applications worldwide. In addition to the classic E-STOP function, our safety relays also monitor safety gates, light beam devices, two-hand controls, pressure-sensitive mats and many other safety functions.

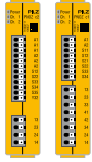
We can offer the optimum safety solution for each application. Our safety relays are distinguished by a variety of supply voltage ranges, the number of safety contacts, the number of terminals or the ability to plug in terminals. Unit types in push-in technology offer a

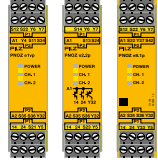
great advantage in terms of both economy and safety. They help you to reduce costs through short commissioning and service times. Based on their different features and functionalities, our products can be divided into the following product groups:

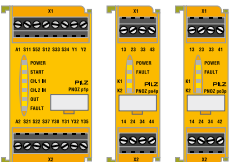
	<p>PNOZsigma</p>   <ul style="list-style-type: none"> ▶ Maximum functionality in minimum width ▶ Operating modes and times are selectable ▶ Scalability thanks to modular structure
	<p>PNOZ X</p>   <ul style="list-style-type: none"> ▶ Tailor-made safety for each function ▶ Electromechanical, potential-free ▶ With universal power supply
	<p>PNOZcompact</p>  <ul style="list-style-type: none"> ▶ Square, simple, yellow ▶ Ideal for high volume manufacturers of series machines ▶ Basic function of a safety application
	<p>PNOZelog</p>   <ul style="list-style-type: none"> ▶ Easy to link ▶ Non-wearing ▶ Extended diagnostics
	<p>PNOZpower</p>   <ul style="list-style-type: none"> ▶ High loads from 8 A to 16 A ▶ Switch motor loads directly ▶ Modular output contacts

Finding your PNOZ

This diagram will help you to choose. You have specific requirements, we have the right solution.



More than three safety functions/
configurable/web-based
visualization?

Yes

No

Breaking capacity > 8 A?

Yes

No

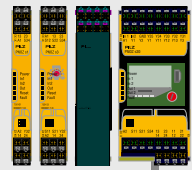

PNOZsigma
Further information from page 22

No

Ability to connect safety functions via AND/OR logic

Yes

Good scalability/
user-friendly diagnostics?

No

PNOZmulti 2
Further information from page 74

PNOZmulti Mini
Further information from page 84

PNOZmulti
Further information from page 92

Software tools PNOZmulti
Further information from page 70



PNOZelog
Further information from page 46

Yes

Plug-in terminals/
universal power supply?

Yes

No

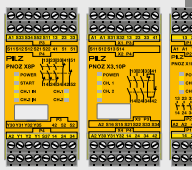

PNOZ X
Further information from page 36

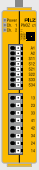

PNOZcompact
Further information from page 44

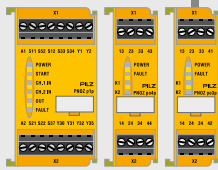

PNOZpower
Further information from page 56

► Protection of man and machine

It pays to use safety technology: The protection of man and machine through the targeted control of hazardous movements, cost savings thanks to fewer accidents, reduced downtimes and fewer production losses – these are real benefits that you can enjoy when you use safe control technology from Pilz.

Safety relays PNOZ – certified worldwide

When using the safety relays PNOZ, the aim is to keep the risk to man and machine as low as possible. Internationally coordinated statutory instruments were introduced to ensure that the same level of protection could be guaranteed in all countries. Our safety relays

comply with these international standards and regulations. The safety relay PNOZ has been approved by BG, TÜV and many other notified bodies and offers users considerable benefits. Long service life and high availability ensure it is cost-effective to use.

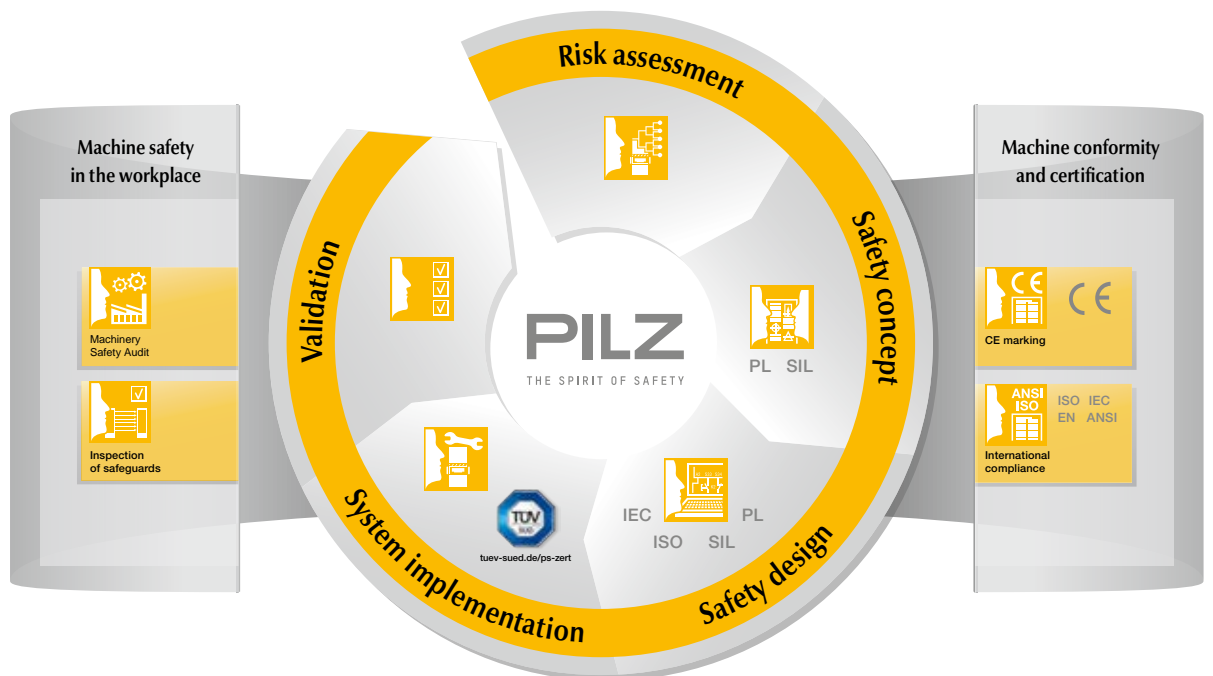

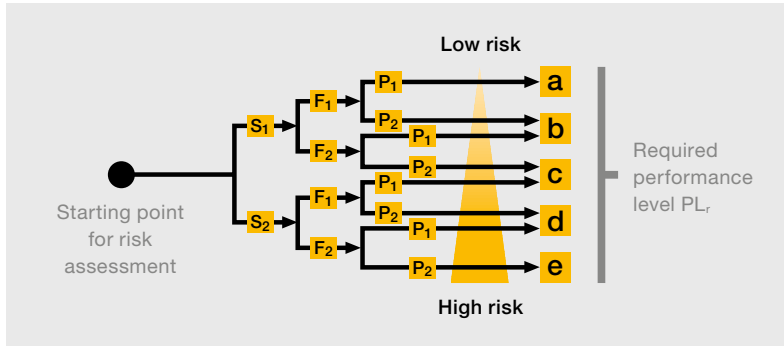

Risk analysis in accordance with EN ISO 13849-1

EN ISO 13849-1

As the successor standard to EN 954-1, EN ISO 13849-1 is based on the familiar categories. Equally, it examines complete safety functions, including all the components involved in their design. EN ISO 13849-1 goes beyond the qualitative approach of EN 954-1 to include a quantitative assessment of the safety functions. A performance level (PL) is used for this, based on the categories.

Consequences and severity	S	Class CL = Fr + Pr + Av				
		3 – 4	5 – 7	8 – 10	11 – 13	14 – 15
Death, losing an eye or arm	4	SIL 2	SIL 2	SIL 2	SIL 3	SIL 3
Permanent, losing fingers	3		OM	SIL 1	SIL 2	SIL 3
Reversible, medical treatment	2			OM	SIL 1	SIL 2
Reversible, first aid	1				OM	SIL 1

Risk assessment and definition of the required safety integrity level (SIL)

Safety assessment in accordance with EN/IEC 62061

According to the standard EN/IEC 62061, safety requirements in control technology can be divided into safety integrity levels. SIL 3 represents the highest risk reduction and protection level, where the safety function must always be maintained. The risk is estimated through consideration of the severity of injury (Se), the frequency and duration of exposure to the hazard (Fr), probability of occurrence of a hazardous event (Pr) and the possibility of avoiding or limiting the harm (Av).

Your benefits at a glance

The use of safety relays PNOZ offers you:

- ▶ The security and innovative strength of one of the leading brands in automation technology
- ▶ The appropriate solution for each application
- ▶ High plant availability thanks to user-friendly diagnostics
- ▶ Low downtimes for your plant or machinery
- ▶ Optimum cost/performance ratio
- ▶ Faster commissioning, for example, through units with plug-in terminals
- ▶ Maximum safety with minimum space requirement
- ▶ Simple wiring, fast commissioning
- ▶ A solid partner with expertise and outstanding service
- ▶ Certified safety, because our products comply with international standards and regulations and have been tested and approved worldwide
- ▶ Quality guarantee, we are certified to DIN ISO 9001
- ▶ Use of products that are geared towards the future, thanks to innovative developments
- ▶ Complete solution comprising evaluation devices, compatible sensor technology and control and signal devices

Keep up-to-date about the standards:

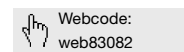

Online information at www.pilz.com

► Safety relays PNOZsigma

The compact safety relays PNOZsigma combine many years of experience with today's very latest safety technology: you can achieve maximum safety and cost-effectiveness with minimum effort. With particularly narrow housing widths and multifunctionality compressed into each unit, PNOZsigma provides maximum functionality in minimum width. So you can implement safety technology faster, with greater flexibility and therefore more efficiently, while saving space.



Small number of types – suitable for a variety of uses

- Selectable operating modes and timers enable each unit to be flexible in its application
- A single unit type monitors different safety functions
- Your stockholding can be reduced to a few unit types

Rapid installation:
With spring-loaded terminals

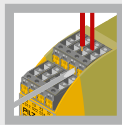

Wiring work is reduced by 20%:
Contact expansion via connectors

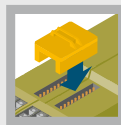

Simple configuration:
designation and position of the terminals is the same on all unit types



Maximum flexibility:
Operating modes and timer functions are selectable

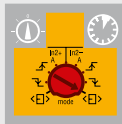

Rapid assembly
via spring clips:
No need for tools

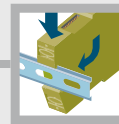

Diagnostics in seconds:
Via 6 LED displays – no external measuring devices required

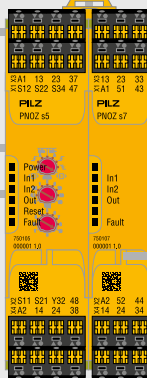

Safe from manipulation:
Setting elements have a lockable cover



Your benefits at a glance

- Narrower widths save space within the control cabinet, and therefore costs
- Reduction in wiring costs through push-in technology and contact expansion through the use of connectors
- Rapid commissioning and high availability
- Low logistics costs: few unit types covering many safety functions
- Opt for the complete solution from Pilz and add optimally matched and approved safety components to PNOZsigma: from the E-STOP button and safe sensors such as safety switches and light curtains to operator terminals for diagnostics and visualization

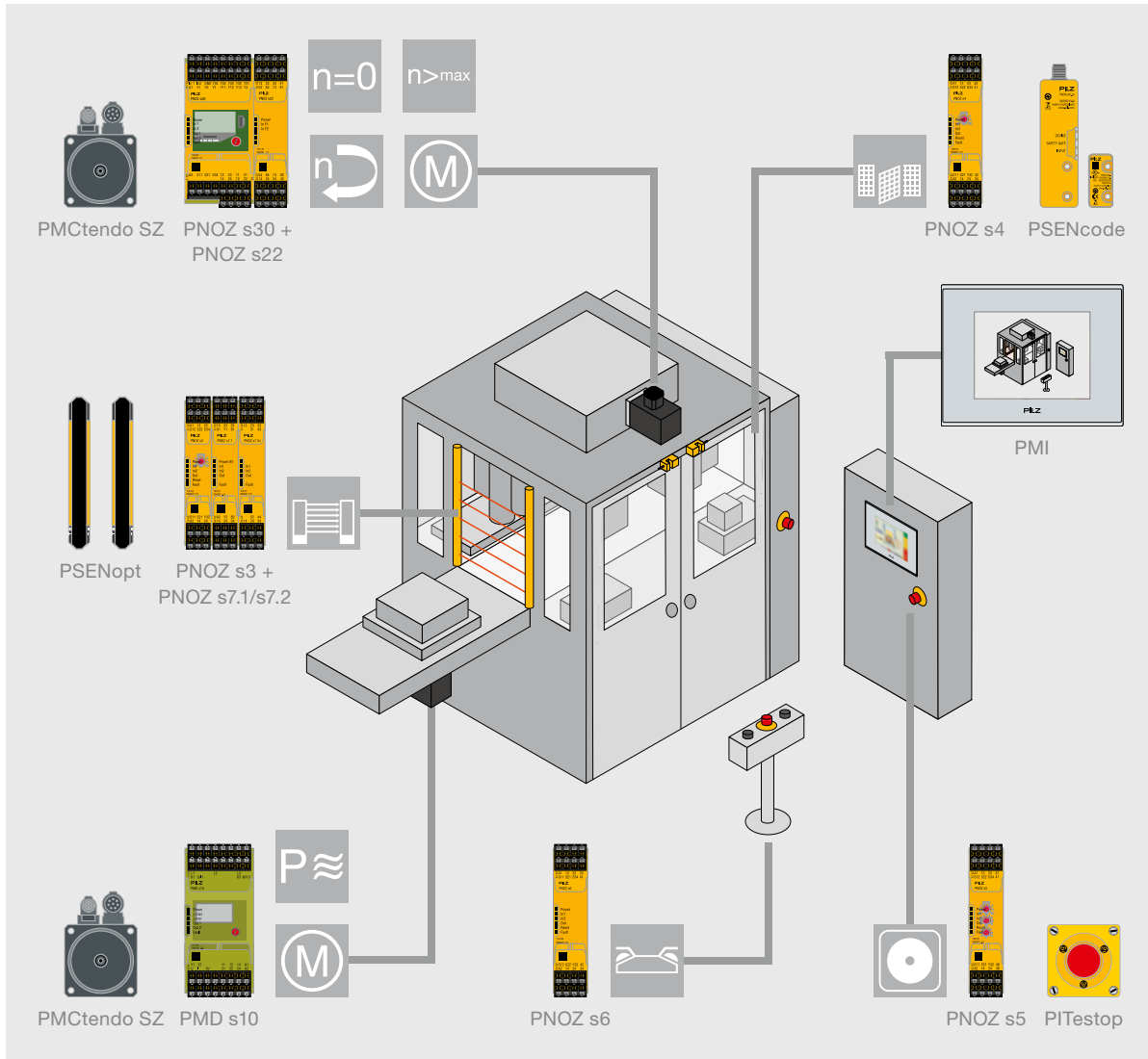

The appropriate solution for every safety application – e.g. use of the safety relays PNOZsigma on a packaging machine.

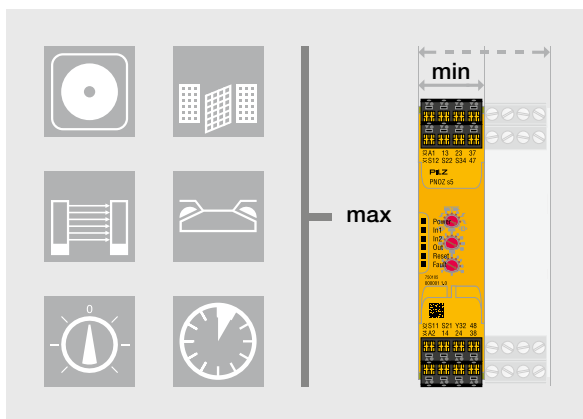

Up to 50% space saving

- ▶ Widths starting at 12.5 mm
- ▶ Housing is up to 50% narrower with the same functionality¹⁾
- ▶ Reduced space requirement in the control cabinet saves costs

¹⁾ Compared to standard electromechanical safety relays available on the market

Keep up-to-date on safety relays PNOZsigma:

Webcode: web150099

Online information at www.pilz.com

► Safety relay PNOZsigma – Tried and tested in special applications

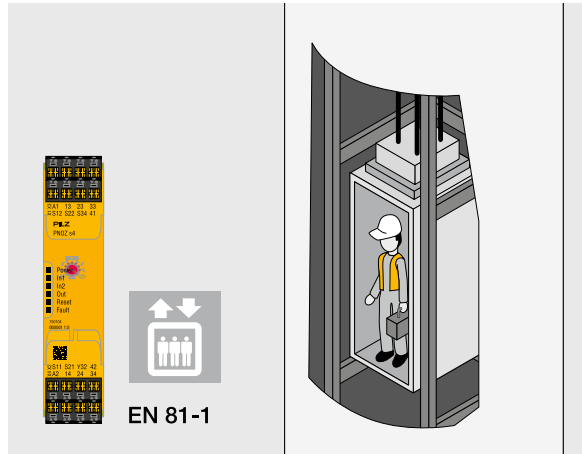

Safety relay PNOZ s4 with lift approval

The "Lifts standard" EN 81-1 defines the safety rules for the "construction and installation of lifts; Part 1: Electric lifts". The PNOZ s4 has this approval and guarantees lift operators and lift manufacturers maximum functionality in minimum width. With a width of 22.5 mm, the PNOZ s4 achieves PL e as defined in EN ISO 13849-1, and SIL CL 3. The areas of application of the PNOZ s4 range from passenger lifts, freight and goods lifts to all types of lifting devices which are subject to this standard.

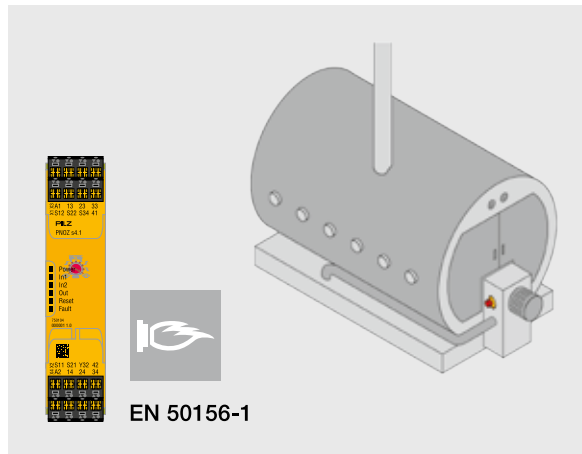

Safety relay PNOZ s4.1 – for use in burner controls

Thanks to three safe, diverse safety contacts, the PNOZ s4.1 is approved for use in burner controls. It is approved in accordance with the standard EN 50156-1 for electrical equipment on furnaces, in particular with regard to the requirements for application design and installation. Safety valves of furnaces can be monitored using PNOZ s4.1. The operating modes can be set easily and conveniently using a rotary switch.



► More contacts with PNOZsigma – Simply and quickly

Multiple expansion with PNOZ s7.1 and PNOZ s7.2

Using a base unit and a PNOZ s7.1, it is possible to expand the number of safety contacts almost without limit. A series of up to ten PNOZ s7.2 units can be connected to a PNOZ s7.1. If you need even more safety contacts, an additional PNOZ s7.1 can be added. No wiring is involved – just a connector and one simple hand movement.

At just 17.5 mm wide, the PNOZ s7.1 has three safety contacts, while the PNOZ s7.2 has four safety contacts plus one auxiliary contact. They can be combined with other PNOZsigma expansion units at any time.

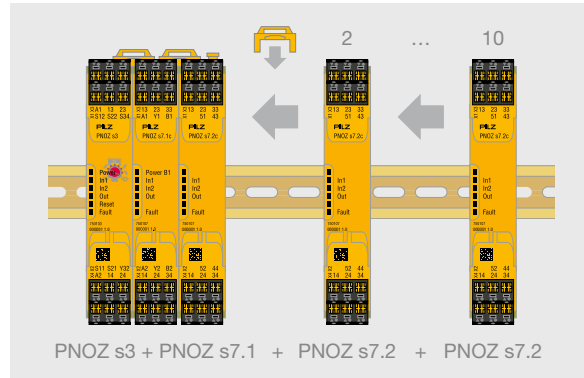

Fast contact expansion – it's easy with PNOZsigma!

Contact expansion module PNOZ s20 with safe semiconductor outputs

Apart from contact expansion with instantaneous safety contacts, contact expansion with safe semiconductor outputs is also available. If you need a maximum of ten semiconductor outputs, then connect the contact expansion module PNOZ s20 directly to a base unit. If you require even more safe semiconductor outputs, connect the contact expansion module PNOZ s7.1; with this module, you can then expand the number of semiconductor outputs to the desired number.

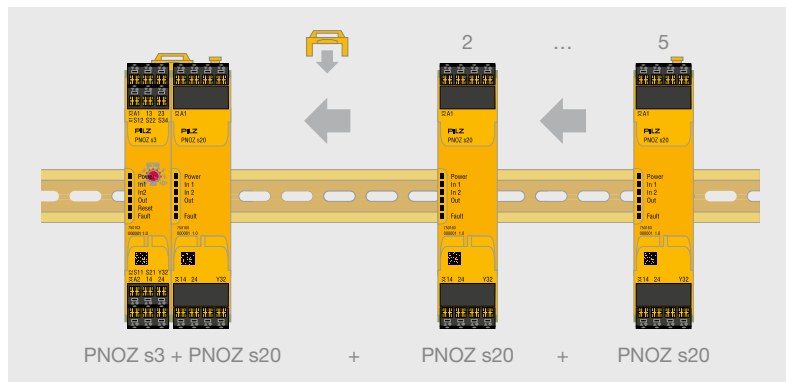

Fast contact expansion – with PNOZsigma also possible completely free of wear! Up to 5 contact expansion modules PNOZ s20 are possible at the base unit.

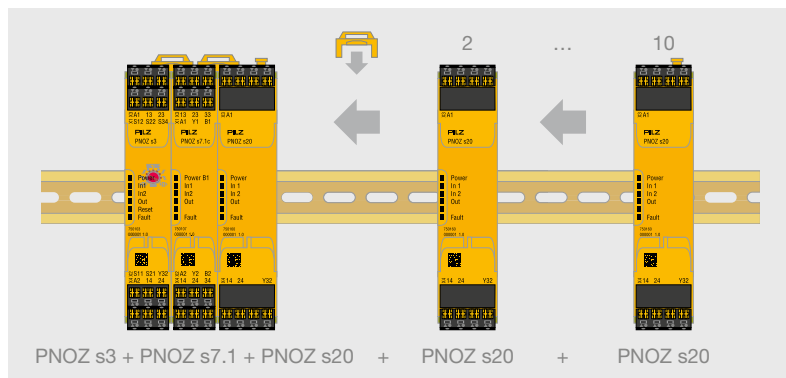

Expansion almost without limit – in conjunction with the contact expansion module PNOZ s7.1.

Your benefits at a glance

- Wiring work is reduced by 20 % by expanding the contacts via connectors
- Flexible application as the number of safety contacts and semiconductor outputs can be expanded through cascading

Keep up-to-date on safety relays PNOZsigma:

Webcode: web150099

Online information at www.pilz.com

► Safety relay PNOZ s30 – Convenient speed monitoring



SSR



SSM



SDI



SOS

The stand-alone safety relay PNOZ s30 ensures safe monitoring of your machines for standstill, speed, position, shear pin breakage, speed range and direction of rotation up to PL e of EN ISO 13849-1 and up to SIL CL 3 of EN/IEC 62061. Using the PNOZ s30 ensures compliance with the Machinery Directive with respect to drive monitoring, i.e. the requirement to safely monitor and maintain the operating status of the drive when the drive is shut down. With PNOZ s30, you save costs and protect your machine and personnel.



PNOZ s30

Increased safety of operating personnel

For example, movement at reduced speed during set-up mode increases operator safety and reduces set-up times. Safe working with the safety gate open and faster access to the machine once standstill is initiated, protect you and your products. Productivity is increased, as an unnecessary shutdown is prevented. PNOZ s30 with safe functions such as safe speed range (SSR), safe speed monitoring (SSM), safe direction (SDI) and safe operating stop (SOS) is the right solution for stand-alone drive monitoring.

Simple use

A display makes configuration and fault indication simple and convenient. The speed monitor PNOZ s30 is suitable for all common motor feedback systems and proximity switches.

Applications

Choose PNOZ s30 for applications such as wind turbines, machining centers, balancing machines, high rack storage systems, centrifuges, filling systems, amusement parks and many others.



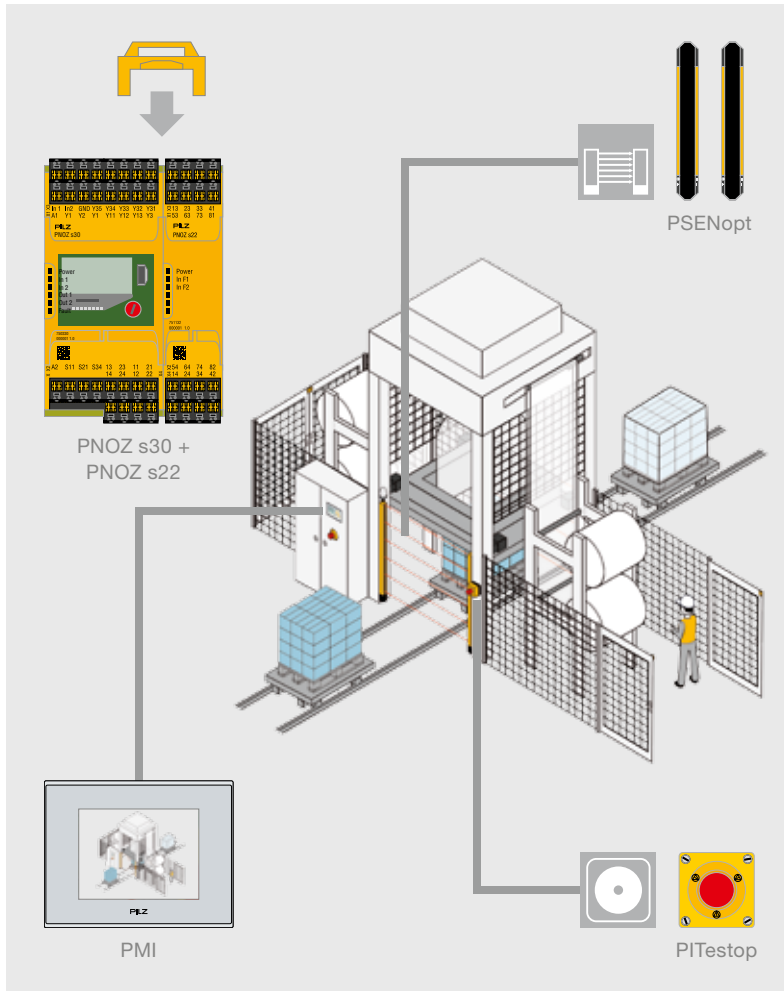

Your benefits at a glance

- ▶ Increased productivity and safety for operating personnel
- ▶ Productivity is increased by avoiding unnecessary shutdown processes: advance warning is given when a defined warning threshold is reached
- ▶ Save time during setup and when units are exchanged, thanks to convenient operation via rotary knob (push and turn)
- ▶ Suitable for all common motor feedback systems and proximity switches
- ▶ Contact expansion module PNOZ s22: duplication of the relay contacts enables the application's function range to be expanded

The number of relay contacts can be multiplied by combining PNOZ s30 and PNOZ s22.



PNOZ s22

Contact expansion module PNOZ s22 – twice as good

PNOZ s22 provides two relay functions which can be controlled separately and which comply with PL e of EN ISO 13849-1. Each relay function provides three N/O contacts and one N/C contact. These can be controlled separately so that the outputs can be assigned different functions, depending on the base unit. Safe separation between the two relay functions enables different potentials to be switched.

Keep up-to-date on safety relays PNOZ s30:

Webcode: web150619

Online information at www.pilz.com

► Safety relay PNOZ s50 for safe brake control

The stand-alone safety relay PNOZ s50 provides a cost-effective solution for controlling two brakes up to category PL e of EN ISO 13849-1. The contactless technology allows very short reaction times to be achieved, enhancing personal protection. You can take advantage of the full flexibility and the individual shutdown options for your application of this manufacturer-independent solution.

Relays



PNOZ s50

Safe, contactless braking – so it's non-wearing

PNOZ s50 helps to make your plant energy efficient: application cycle times are shortened because temporary overexcitation is followed by selectable voltage reduction (pulse width modulation PWM). The safety relay enables rapid switching in emergency situations and slow, low-wearing switching in normal operation, thereby helping to reduce maintenance costs.

As an addition to the PNOZsigma product range, PNOZ s50 also has a rotary knob for menu navigation and a display for showing set-up parameters and diagnostic messages.

Both motor brakes and safety brakes can be safely controlled and monitored with the safety relay PNOZ s50. Safety is significantly improved due to "wear monitoring", particularly on motor-integrated holding brakes.



Find out more in the animation for the safety relay PNOZ s50.

Safety relay PNOZ s50



PNOZ s50

Technical features

- ▶ Stand-alone unit
- ▶ 2 brakes up to PL e of EN ISO 13849-1 / SIL CL 3 of EN/IEC 62061
- ▶ 1 brake up to PL d of EN ISO 13849-1 / SIL CL 3 of EN/IEC 62061
- ▶ 2 x 2-pole safe electronic digital outputs for 24 V DC, each with 4.5 A
- ▶ Approvals: CE, cULus Listed, EAC (Eurasian), TÜV
- ▶ Temporary overexcitation with subsequent voltage reduction
- ▶ Ambient temperature: 0 ... 45 °C
- ▶ Number of inputs:
 - Failsafe: 4
 - Standard: 4
- ▶ Number of failsafe semiconductor outputs:
 - 1-pole: 3
 - 2-pole: 2

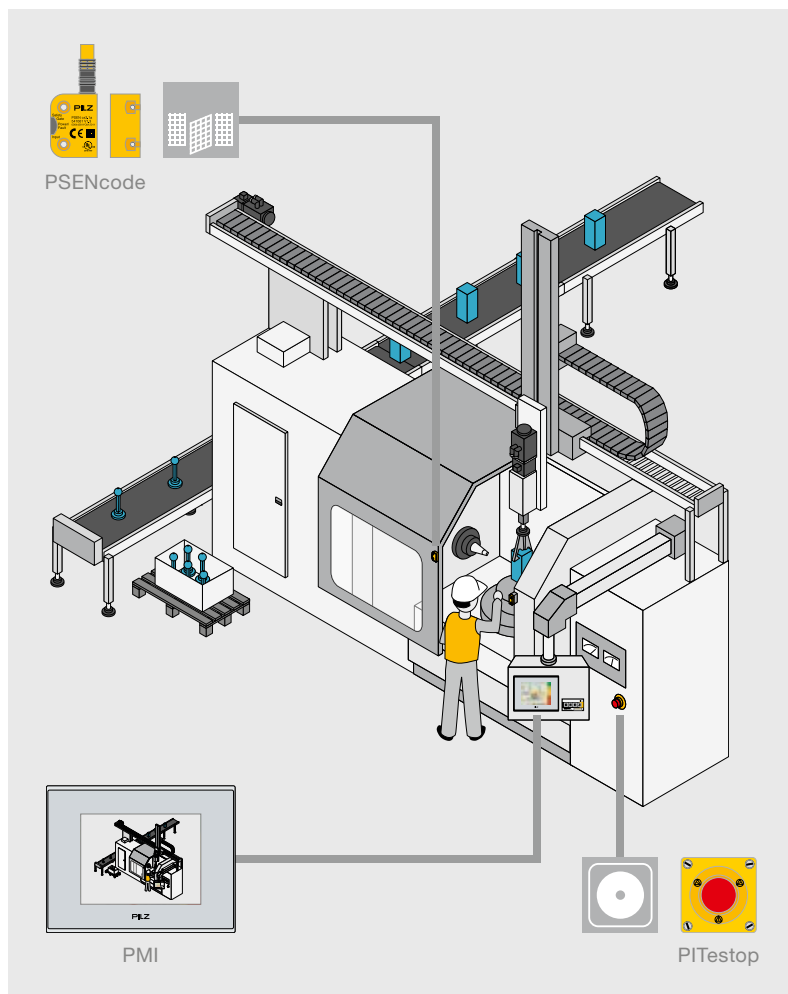

With the safety relay PNOZ s50, you can safely control braking in many application areas – e.g. in stage technology, on tooling machines and on packaging machines. If, in addition to the holding brake, you also need to safeguard a second brake, then PNOZ s50 provides you with the ideal solution.

Your benefits at a glance

- ▶ Highest level of safety up to PL e when controlling 2 brakes (holding brakes or safety brakes)
- ▶ Contactless technology up to 4.5 A per brake enables short reaction times, a long-lasting solution and high availability
- ▶ Reduced cycle times through temporary overexcitation with subsequent voltage reduction
- ▶ High safety and low wear on the brake thanks to fast and slow shutdown of the power circuits
- ▶ Rapid diagnostics by means of the display
- ▶ Manufacturer-independent brake control thanks to safe, digital inputs

- ▶ Supply voltage:
 - 1-pole: 24 V DC
 - 2-pole: 24 VDC, 48 VDC
- ▶ Voltage tolerance:
 - 1-pole: -15 % ... +20 %
 - 2-pole: -10 % ... +10 %
- ▶ Output current of semiconductor outputs (1-pole): 0.1 A
- ▶ Test pulse outputs of semiconductor outputs (1-pole): 2

- ▶ Reduced voltage of semiconductor outputs (2-pole): 6 V, 8 V, 12 V, 16 V, 24 V
- ▶ Output current of semiconductor outputs (2-pole):
 - 24 VDC supply voltage:
 - Continuous duty (1 output/2 outputs): 1 x 6.5 A/2 x 4.5 A
 - Overexcitation (1 output/2 outputs): 1 x 6.5 A/max. 10 A
 - 48 V DC supply voltage:
 - Continuous duty (1 output/2 outputs): 1 x 3.25 A/2 x 2.25 A
 - Overexcitation (1 output/2 outputs): 1 x 3.25 A/2 x 3.25 A

Order number

751 500
(with
spring-loaded
terminals)

Keep up-to-date
on the safety relay
PNOZ s50:

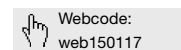





Online information
at www.pilz.com

► Selection guide – PNOZsigma



Safety relays PNOZsigma

Type	Application	Performance Level (PL) – EN ISO 13849-1	Safety Integrity Level (SIL) CL – claim limit in accordance with IEC 62061
	    		
PNOZ s1	◆ ◆	c	2
PNOZ s2	◆ ◆	e	3
PNOZ s3	◆ ◆ ◆	e	3
PNOZ s4	◆ ◆ ◆	e	3
PNOZ s4.1	◆ ◆ ◆	e	3
PNOZ s5	◆ ◆ ◆ ◆	e	3
PNOZ s6		EN 574, Type IIIC	e
PNOZ s6.1		EN 574, Type IIIA	c
PNOZ s7	Contact expansion	e	3
PNOZ s7.1	Contact expansion	e	3
PNOZ s7.2	Contact expansion	e	3
PNOZ s8	Contact expansion	c	2
PNOZ s9	Contact expansion or safe timer ◆	e	3
PNOZ s10	Contact expansion	e	3
PNOZ s11	Contact expansion	e	3
PNOZ s20	Contact expansion	e/d ²⁾	3/2 ²⁾
PNOZ s22	Contact expansion for PNOZ s30 and PNOZ mm0.1p/mm0.2p	e	3

Type	Application	Performance Level (PL) – EN ISO 13849-1	Safety Integrity Level (SIL) CL – claim limit in accordance with IEC 62061
	  		
PNOZ s30	Safe speed and standstill monitor ◆ ◆ ◆	e	3

Type	Application	Performance Level (PL) – EN ISO 13849-1	Safety Integrity Level (SIL) CL – claim limit in accordance with IEC 62061
			
PNOZ s50 ³⁾	Safe brake control ◆	e	3

Output contacts				Semiconductor outputs		Supply voltage (U _B)	Dimensions (H x W x D) in mm
Safe		Auxiliary contacts		Safe	Auxiliary outputs		
2	-	-	1	-	-	24 V DC	100/98 ¹⁾ x 12.5 x 120
3	-	1	1	-	-	24 V DC	100/98 ¹⁾ x 17.5 x 120
2	-	-	1	-	-	24 V DC	100/98 ¹⁾ x 17.5 x 120
3	-	1	1	-	-	24 V DC, 48 ... 240 V AC/DC	100/98 ¹⁾ x 22.5 x 120
3	-	1	1	-	-	24 V DC, 48 ... 240 V AC/DC	100/98 ¹⁾ x 22.5 x 120
2	2	-	1	-	-	24 V DC, 48 ... 240 V AC/DC	100/98 ¹⁾ x 22.5 x 120
3	-	1	1	-	-	24 V DC, 48 ... 240 V AC/DC	100/98 ¹⁾ x 22.5 x 120
3	-	1	1	-	-	24 V DC, 48 ... 240 V AC/DC	100/98 ¹⁾ x 22.5 x 120
4	-	1	-	-	-	24 V DC	100/98 ¹⁾ x 17.5 x 120
3	-	-	-	-	-	24 V DC	100/98 ¹⁾ x 17.5 x 120
4	-	1	-	-	-	24 V DC	100/98 ¹⁾ x 17.5 x 120
2	-	-	1	-	-	24 V DC	100/98 ¹⁾ x 12.5 x 120
-	3	1	-	-	-	24 V DC	100/98 ¹⁾ x 17.5 x 120
4	-	1	-	-	-	24 V DC	100/98 ¹⁾ x 45.0 x 120
8	-	1	-	-	-	24 V DC	100/98 ¹⁾ x 45.0 x 120
-	-	-	-	2	1	24 V DC	100/98 ¹⁾ x 22.5 x 120
2x3	-	2x1	-	-	-	24 V DC	100/98 ¹⁾ x 22.5 x 120

Output contacts				Semiconductor outputs		Supply voltage (U _B)	Dimensions (H x W x D) in mm
Safe		Auxiliary contacts		Safe	Auxiliary outputs		
2	-	2	4	-	-	24 ... 240 VAC/DC	100/98 ¹⁾ x 45.0 x 120

Semiconductor outputs		Semiconductor outputs		Supply voltage (U _B)	Dimensions (H x W x D) in mm
2-pin	1-pin	Safe	Auxiliary outputs		
2	3	-	-	24 VDC, 48 VDC	100/98 ¹⁾ x 45.0 x 120

Technical documentation on safety relays PNOZsigma:

Webcode: web150635

Online information at www.pilz.com

¹⁾ Height incl. spring-loaded terminals/plug-in screw terminals

²⁾ Depending on the application

³⁾ For technical details, see page 28

► Technical details – PNOZsigma



Safety relays PNOZsigma – Base units



PNOZ s1



PNOZ s2



PNOZ s3



PNOZ s4



PNOZ s4.1



PNOZ s5



PNOZ s6



PNOZ s6.1

Type	Features
PNOZ s1	<ul style="list-style-type: none"> ▶ Single-channel wiring ▶ Manual/automatic start
PNOZ s2	<ul style="list-style-type: none"> ▶ Single-channel wiring ▶ Monitored start ▶ Manual/automatic start ▶ Safe separation
PNOZ s3	<ul style="list-style-type: none"> ▶ Single- and dual-channel wiring ▶ Detection of shorts across contacts ▶ Monitored start ▶ Manual/automatic start ▶ Start-up testing
PNOZ s4	<ul style="list-style-type: none"> ▶ Single- and dual-channel wiring ▶ Detection of shorts across contacts ▶ Monitored start ▶ Manual/automatic start ▶ Start-up testing ▶ Approval to EN 81-1/A3 in accordance with the Lifts Directive
PNOZ s4.1	<ul style="list-style-type: none"> ▶ Single- and dual-channel wiring ▶ Detection of shorts across contacts ▶ Monitored start ▶ Manual/automatic start ▶ Start-up testing ▶ 3 safe, diverse safety contacts ▶ Approval in accordance with EN 50156-1 for electrical equipment for furnaces
PNOZ s5	<ul style="list-style-type: none"> ▶ Single- and dual-channel wiring ▶ Detection of shorts across contacts ▶ Monitored start ▶ Manual/automatic start ▶ Start-up testing ▶ Timer functions: delay-on de-energization ▶ Time range: 0 ... 300 s
PNOZ s6	<ul style="list-style-type: none"> ▶ Dual-channel wiring ▶ Detection of shorts across contacts
PNOZ s6.1	<ul style="list-style-type: none"> ▶ Dual-channel wiring ▶ Detection of shorts across contacts

Outputs: Voltage/current/ rating	Approvals	Order number	
		Spring-loaded terminals	Plug-in screw terminals
DC1: 24 V/3 A/72 W	CE, cULus Listed, EAC (Eurasian), TÜV, KOSHA, CCC	751 101	750 101
DC1: 24 V/6 A/150 W	CE, cULus Listed, EAC (Eurasian), TÜV, KOSHA, CCC	751 102	750 102
DC1: 24 V/6 A/150 W	CE, cULus Listed, EAC (Eurasian), TÜV, KOSHA, CCC	751 103	750 103
DC1: 24 V/6 A/150 W	CE, cULus Listed, EAC (Eurasian), TÜV, KOSHA, CCC	▶ 24 V DC _____ 751 104 ▶ 24 V DC, coated version _____ 751 184 ▶ 48 ... 240 V AC/DC _ 751 134	▶ 24 V DC _____ 750 104 ▶ 48 ... 240 V AC/DC _ 750 134
DC1: 24 V/6 A/150 W	CE, cULus Listed, EAC (Eurasian), TÜV, CCC	▶ 24 V DC _____ 751 124 ▶ 48 ... 240 V AC/DC _ 751 154	▶ 24 V DC _____ 750 124 ▶ 48 ... 240 V AC/DC _ 750 154
DC1: 24 V/6 A/150 W	CE, cULus Listed, EAC (Eurasian), TÜV, KOSHA, CCC	▶ 24 V DC _____ 751 105 ▶ 24 V DC, coated version _____ 751 185 ▶ 48 ... 240 V AC/DC _ 751 135	▶ 24 V DC _____ 750 105 ▶ 48 ... 240 V AC/DC _ 750 135
DC1: 24 V/6 A/150 W	CE, cULus Listed, EAC (Eurasian), TÜV, KOSHA, CCC	▶ 24 V DC _____ 751 106 ▶ 48 ... 240 V AC/DC _ 751 136	▶ 24 V DC _____ 750 106 ▶ 48 ... 240 V AC/DC _ 750 136
DC1: 24 V/6 A/150 W	CE, cULus Listed, EAC (Eurasian), TÜV, KOSHA, CCC	▶ 24 V DC _____ 751 126 ▶ 48 ... 240 V AC/DC _ 751 156	▶ 24 V DC _____ 750 126 ▶ 48 ... 240 V AC/DC _ 750 156

Technical documentation on safety relays PNOZsigma:

 Webcode: web150635

Online information at www.pilz.com

► Technical details – PNOZsigma



Safety relays PNOZsigma – Contact expansion modules



PNOZ s7



PNOZ s8



PNOZ s9



PNOZ s10



PNOZ s11



PNOZ s20



PNOZ s22

Type	Features
PNOZ s7	Safe separation
PNOZ s7.1	<ul style="list-style-type: none"> ▶ Cascading module for connection to PNOZ s7.2 ▶ Safe separation of safety contacts ▶ LEDs for input and switch status ▶ Can also be used with other safety control devices, without a PNOZsigma base unit: one input circuit affects the output relays
PNOZ s7.2	Contact expansion module in conjunction with PNOZ s7.1
PNOZ s8	Contact expansion
PNOZ s9	<ul style="list-style-type: none"> ▶ Safe separation ▶ Timer functions: delay-on energization, delay-on de-energization, pulsing, retriggerable ▶ Time range: 0 ... 300 s
PNOZ s10	Safe separation
PNOZ s11	Safe separation
PNOZ s20	<ul style="list-style-type: none"> ▶ Contact expansion with 2 instantaneous safety outputs and 1 auxiliary output, each in semiconductor technology ▶ Single- and dual-channel wiring
PNOZ s22	<ul style="list-style-type: none"> ▶ 2 safety contacts that can be controlled separately ▶ Contact expansion for speed monitor PNOZ s30 and base units PNOZ mm0.1p/mm0.2p of configurable compact controllers PNOZmulti Mini

Safety relays PNOZsigma – Speed monitoring



PNOZ s30

Type	Features
PNOZ s30	<ul style="list-style-type: none"> ▶ Safe monitoring of standstill, speed, direction of rotation and shear pin breakage ▶ Parameters for device functions can be freely set ▶ Parameters are entered via rotary knob (push and turn) in conjunction with a monochrome display ▶ Set parameters are saved on a chip card ▶ Integrated display shows the set limit values/parameters as well as the current speed ▶ Tolerances can be freely set for each limit value

Outputs: Voltage/current/ rating	Approvals	Order number	
		Spring-loaded terminals	Plug-in screw terminals
DC1: 24 V/6 A/150 W	CE, cULus Listed, EAC (Eurasian), TÜV, KOSHA, CCC	<ul style="list-style-type: none"> ▶ 24 V DC _____ 751 107 ▶ 24 V DC, coated version _____ 751 187 	750 107
DC1: 24 V/6 A/150 W	CE, cULus Listed, EAC (Eurasian), TÜV, CCC	751 167	750 167
DC1: 24 V/6 A/150 W	CE, cULus Listed, EAC (Eurasian), TÜV, CCC	751 177	750 177
DC1: 24 V/3 A/72 W	CE, cULus Listed, EAC (Eurasian), TÜV, KOSHA, CCC	751 108	750 108
DC1: 24 V/6 A/150 W	CE, cULus Listed, EAC (Eurasian), TÜV, KOSHA, CCC	<ul style="list-style-type: none"> ▶ 24 V DC _____ 751 109 ▶ 24 V DC, coated version _____ 751 189 	750 109
DC1: 24 V/12 A/300 W	CE, cULus Listed, EAC (Eurasian), TÜV, KOSHA, CCC	751 110	750 110
DC1: 24 V/6 A/150 W	CE, cULus Listed, EAC (Eurasian), TÜV, CCC	751 111	750 111
<ul style="list-style-type: none"> ▶ Total output of external load, semiconductor 93 W ▶ Switching capability: <ul style="list-style-type: none"> - 2 safety outputs with load: 1.5 A/40 W - 1 safety output with load: 2 A/50 W 	CE, cULus Listed, EAC (Eurasian), TÜV, CCC	751 160	750 160
DC1: 24 V/6 A/150 W	cULus Listed, EAC (Eurasian), TÜV, CCC	751 132	750 132

	Outputs: Voltage/current/rating	Approvals	Order number
<ul style="list-style-type: none"> ▶ Axis position monitoring is available as an option with the standstill function ▶ Advance warning of shutdown when a certain threshold is reached ▶ Accessories: <ul style="list-style-type: none"> - Chip card reader: 779230 - PNOZsigma chip card manager set (software incl. licence, SIM card adapter, chip card reader): 750030 - SmartCardCommander with SIM card adapter (software incl. licence, SIM card adapter): 750031 	DC1: 24 V/4 A/100 W	CE, cULus Listed, EAC (Eurasian), TÜV, CCC	<ul style="list-style-type: none"> ▶ 751 330 (spring-loaded terminals) ▶ 750 330 (plug-in screw terminals)

Technical documentation on safety relays PNOZsigma:

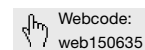
 Webcode:
web150635

 Online information at www.pilz.com

▶ Safety relays PNOZ X

Safety relays from the product group PNOZ X are proven through their reliability and robustness and have a wide application range in the most varied of safety applications. PNOZ is the most widely used safety relay in the world. One PNOZ is used per safety function.

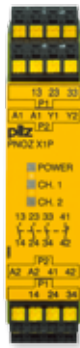

PNOZ X1P



PNOZ X3P

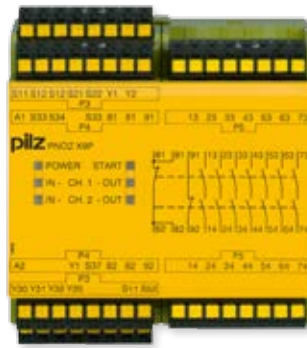

PNOZ X9P

Customized safety for each application

Technical features are the voltage-free, electromechanical contacts in 2-relay technology. The sizes vary from 22.5 to 90 mm, the number of contacts from two to eight. Whatever your safety requirement – PNOZ X has already proved itself a million times over in tough industrial environments. Why not take advantage!

Your benefits at a glance

- ▶ Technology proven over many years of use
- ▶ Huge selection of products
- ▶ For all safety functions such as monitoring E-STOP devices, safety gates, light beam devices, muting, pressure-sensitive mats and two-hand control and many more
- ▶ Delayed and instantaneous contact expansion modules, safe timers, safe monitoring relays for standstill, speed and other functions
- ▶ Excellent price/performance ratio
- ▶ Rapid commissioning thanks to plug-in terminals
- ▶ Maximum safety with minimum space requirement
- ▶ Complete solution comprising evaluation devices, compatible sensor technology, control and signal devices
- ▶ Low storage costs thanks to universal power supply and plug-in terminals



Keep up-to-date on safety relays PNOZ X:

Webcode:
web150097

Online information at www.pilz.com

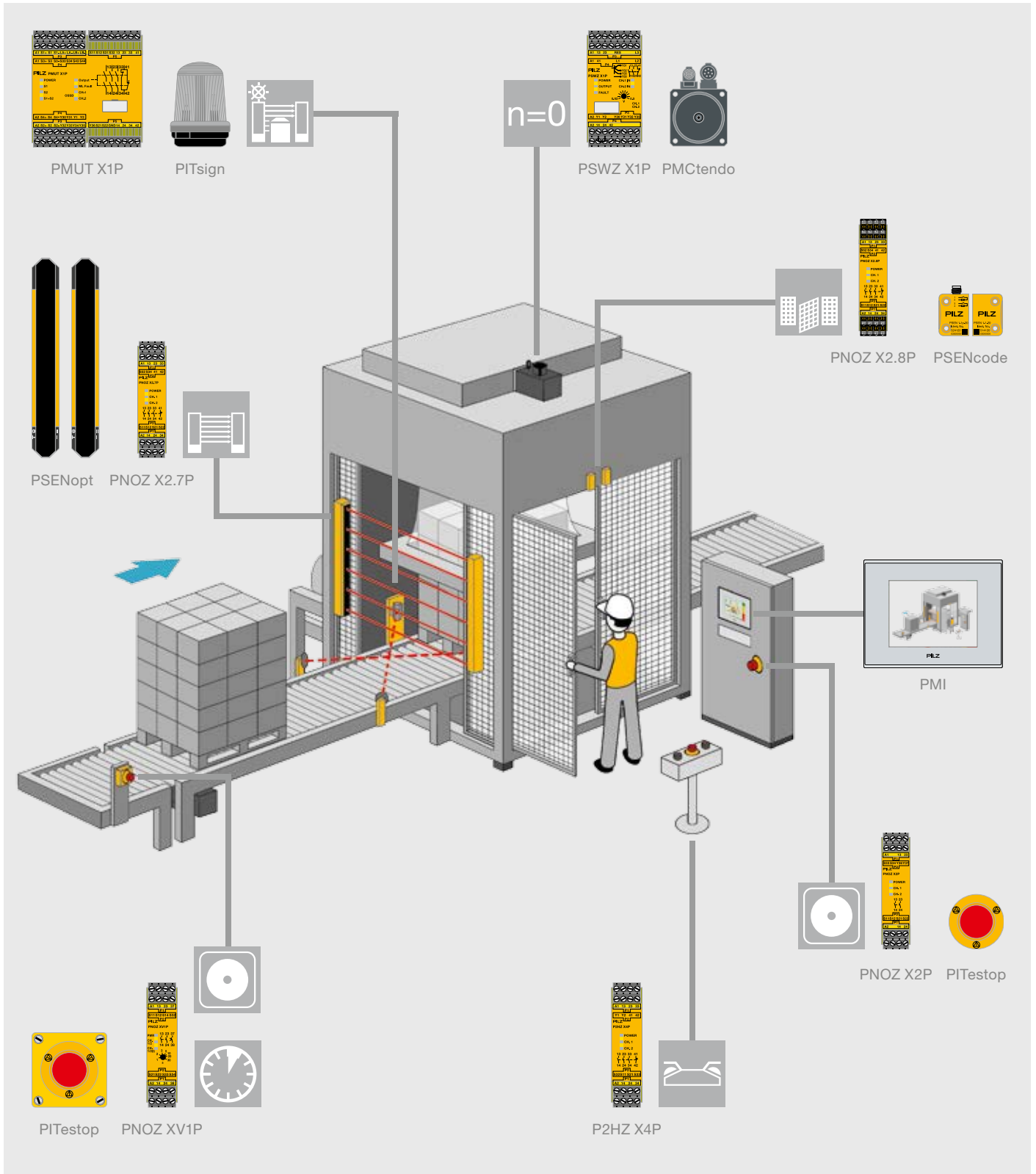





Example: using safety relays PNOZ X on a packaging machine.

► Selection guide – PNOZ X

Safety relays PNOZ X

Type	Application	Performance Level (PL) – EN ISO 13849-1
PNOZ X1P	◆ ◆	e
PNOZ X2P	◆ ◆	e
PNOZ X2.7P	◆ ◆ ◆	e
PNOZ X2.8P	◆ ◆ ◆	e
PNOZ X3P	◆ ◆ ◆	e
PNOZ X7P	◆ ◆	e
PNOZ X8P	◆ ◆ ◆	e
PNOZ X9P	◆ ◆ ◆	e
PNOZ X10.11P	◆ ◆ ◆	e
PNOZ X11P	◆ ◆ ◆	e
PNOZ XV1P	◆ ◆ ◆	e (d) ²⁾
PNOZ XV3P	◆ ◆ ◆	e (d) ²⁾
PNOZ XV3.1P	◆ ◆ ◆	e (d) ²⁾
PMUT X1P	◆ ◆ ◆	e
P2HZ X1P	◆	EN 574, Type IIIC e
P2HZ X4P	◆	EN 574, Type IIIC e
PSWZ X1P	◆	e
PZE X4P	Contact expansion	e

Safety Integrity Level (SIL) CL – claim limit in accordance with IEC 62061	Output contacts				Supply voltage (U _B)	Dimensions (H x W x D) in mm
	Safe		Non-safety-related			
						
3	3	-	1	-	24 V DC	101/94 ¹⁾ x 22.5 x 121
3	2	-	-	-	▶ 24 V AC/DC ▶ 48 ... 240 V AC/DC	101/94 ¹⁾ x 22.5 x 121
3	3	-	1	-	▶ 24 V AC/DC ▶ 24 ... 240 V AC/DC	101/94 ¹⁾ x 22.5 x 121
3	3	-	1	-	▶ 24 V AC/DC ▶ 24 ... 240 V AC/DC	101/94 ¹⁾ x 22.5 x 121
3	3	-	1	1	▶ 24 V AC/DC ▶ 24 ... 240 V AC/DC	101/94 ¹⁾ x 45 x 121
3	2	-	-	-	▶ 24 V AC/DC ▶ 110 ... 120, 230 ... 240 V AC	101/94 ¹⁾ x 22.5 x 121
3	3	-	2	2	▶ 24 V DC ▶ 24, 110, 230 V AC	101/94 ¹⁾ x 45 x 121
3	7	-	2	2	▶ 12 V DC ▶ 24 V DC, 100 ... 240 V AC	101/94 ¹⁾ x 90 x 121
3	6	-	4	-	24 V DC	101/94 ¹⁾ x 90 x 121
3	7	-	1	2	▶ 24 V DC, 24 V AC ▶ 110 ... 120, 230 ... 240 V AC	101/94 ¹⁾ x 90 x 121
3	2	1	-	-	24 V DC	101/94 ¹⁾ x 22.5 x 121
3	3	2	-	-	24 V DC	101/94 ¹⁾ x 45 x 121
3	3	2	1	-	▶ 24 V DC ▶ 24 ... 240 V AC/DC	101/94 ¹⁾ x 90 x 121
3	3	-	1	5	24 V DC	101/94 ¹⁾ x 90 x 121
3	3	-	1	2	▶ 24 V DC ▶ 24, 42, 110, 115, 230, 240 V AC	101/94 ¹⁾ x 45 x 121
3	3	-	1	-	24 V AC/DC	101/94 ¹⁾ x 22.5 x 121
3	2	-	1	1	24 ... 240 V AC/DC	101/94 ¹⁾ x 45 x 121
3	4	-	-	-	24 V DC	101/94 ¹⁾ x 22.5 x 121

¹⁾ Height incl. spring-loaded terminals/plug-in screw terminals

²⁾ Value applies to instantaneous (delayed) safety contacts

Technical documentation on safety relays PNOZ X:

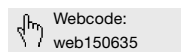

Online information at www.pilz.com

► Technical details – PNOZ X

Safety relays PNOZ X



PNOZ X1P



PNOZ X2P



PNOZ X2.7P



PNOZ X2.8P



PNOZ X3P



PNOZ X7P



PNOZ X8P

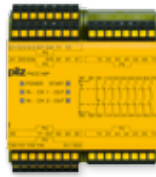

PNOZ X9P



PNOZ X10.11P

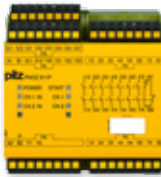

PNOZ X11P

Type	Features
PNOZ X1P	1-channel operation
PNOZ X2P	<ul style="list-style-type: none"> ▶ 2-channel operation with detection of shorts across contacts ▶ Automatic or monitored start can be selected
PNOZ X2.7P	<ul style="list-style-type: none"> ▶ 2-channel operation with or without detection of shorts across contacts ▶ Monitored start
PNOZ X2.8P	<ul style="list-style-type: none"> ▶ 2-channel operation with or without detection of shorts across contacts ▶ Automatic start
PNOZ X3P	<ul style="list-style-type: none"> ▶ Dual-channel wiring, with or without detection of shorts across contacts ▶ Monitored or automatic start can be selected ▶ 1 semiconductor output ▶ Safety gate function with N/C / N/O combination
PNOZ X7P	1-channel operation
PNOZ X8P	<ul style="list-style-type: none"> ▶ 2-channel operation with or without detection of shorts across contacts ▶ Monitored or automatic start can be selected ▶ 2 semiconductor outputs
PNOZ X9P	<ul style="list-style-type: none"> ▶ Dual-channel wiring, with or without detection of shorts across contacts ▶ Monitored or automatic start can be selected ▶ 2 semiconductor outputs
PNOZ X10.11P	<ul style="list-style-type: none"> ▶ Dual-channel wiring, with or without detection of shorts across contacts ▶ Monitored or automatic start can be selected
PNOZ X11P	<ul style="list-style-type: none"> ▶ Dual-channel wiring, with or without detection of shorts across contacts ▶ Monitored or automatic start can be selected ▶ 2 semiconductor outputs

Outputs: Voltage/current/ rating	Approvals	Order number	
		Spring-loaded terminals	Plug-in screw terminals
DC1: 24 V/6 A/150 W	CE, cULus Listed, EAC (Eurasian), TÜV, CCC	787 100	777 100
DC1: 24 V/6 A/150 W	CE, cULus Listed, EAC (Eurasian), TÜV, CCC	▶ 24 V AC/DC _____ 787 303 ▶ 48 ... 240 V AC/DC ____ 787 307	▶ 24 V AC/DC _____ 777 303 ▶ 48 ... 240 V AC/DC ____ 777 307
DC1: 24 V/6 A/150 W	CE, cULus Listed, EAC (Eurasian), TÜV, CCC	▶ 24 V AC/DC _____ 787 305 ▶ 24 ... 240 V AC/DC ____ 787 306	▶ 24 V AC/DC _____ 777 305 ▶ 24 ... 240 V AC/DC ____ 777 306
DC1: 24 V/6 A/150 W	CE, cULus Listed, EAC (Eurasian), TÜV, KOSHA, CCC	▶ 24 V AC/DC _____ 787 301 ▶ 24 ... 240 V AC/DC ____ 787 302	▶ 24 V AC/DC _____ 777 301 ▶ 24 ... 240 V AC/DC ____ 777 302
DC1: 24 V/8 A/200 W	CE, cULus Listed, EAC (Eurasian), TÜV, KOSHA, CCC	▶ 24 V AC/DC _____ 787 310 ▶ 24 ... 240 V AC/DC ____ 787 313	▶ 24 V AC/DC _____ 777 310 ▶ 24 ... 240 V AC/DC ____ 777 313
DC1: 24 V/6 A/150 W	CE, cULus Listed, EAC (Eurasian), TÜV, CCC	▶ 24 V AC/DC _____ 787 059 ▶ Others available on request	▶ 24 V AC/DC _____ 777 059 ▶ Others available on request
DC1: 24 V/8 A/200 W	CE, cULus Listed, EAC (Eurasian), TÜV, CCC	▶ 24 V AC _____ 787 770 ▶ 24 V DC _____ 787 760 ▶ Others available on request	▶ 24 V AC _____ 777 770 ▶ 24 V DC _____ 777 760 ▶ Others available on request
DC1: 24 V/8 A/200 W	CE, cULus Listed, EAC (Eurasian), TÜV, CCC	▶ 24 V DC _____ 787 609 ▶ 24 V DC, 100 ... 240 V AC ____ 787 606	▶ 12 V DC _____ 777 607 ▶ 24 V DC _____ 777 609 ▶ 24 V DC, 100 ... 240 V AC ____ 777 606
DC1: 24 V/8 A/200 W	CE, cULus Listed, EAC (Eurasian), TÜV, CCC	787 750	777 750
DC1: 24 V/8 A/200 W	CE, cULus Listed, EAC (Eurasian), TÜV, CCC	▶ 24 V DC, 24 V AC ____ 787 080 ▶ 110 ... 120 V AC ____ 787 083 ▶ 230 ... 240 V AC ____ 787 086	▶ 24 V DC, 24 V AC ____ 777 080 ▶ 110 ... 120 V AC, 24 V DC _____ 777 083 ▶ 230 ... 240 V AC, 24 V DC _____ 777 086

Technical documentation on safety relays PNOZ X:

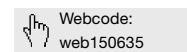

Online information at www.pilz.com

► Technical details – PNOZ X

Safety relays PNOZ X



PNOZ XV1P



PNOZ XV3P

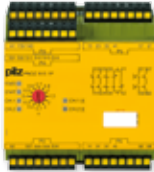

PNOZ XV3.1P



PMUT X1P



P2HZ X1P



P2HZ X4P



PSWZ X1P



PZE X4P

Type	Features
PNOZ XV1P	<ul style="list-style-type: none"> ▶ Dual-channel wiring, with or without detection of shorts across contacts ▶ Monitored or automatic start can be selected
PNOZ XV3P	<ul style="list-style-type: none"> ▶ Dual-channel wiring, with or without detection of shorts across contacts ▶ Monitored or automatic start can be selected
PNOZ XV3.1P	<ul style="list-style-type: none"> ▶ Dual-channel wiring, with or without detection of shorts across contacts ▶ Monitored or automatic start can be selected ▶ Universal power supply 24 ... 240 V AC/DC
PMUT X1P	<ul style="list-style-type: none"> ▶ Up to 4 muting sensors ▶ Monitoring and switching muting lamps ▶ Parallel and sequential muting ▶ Simultaneity monitoring ▶ 5 semiconductor outputs ▶ Reset input ▶ Override function via key switch in the case of a fault ▶ LED status indicators
P2HZ X1P	2 semiconductor outputs
P2HZ X4P	22.5 mm width
PSWZ X1P	<ul style="list-style-type: none"> ▶ Safe standstill monitoring ▶ 1 or 2-channel operation ▶ No external components required ▶ Fault signal if simultaneity time is exceeded ▶ Reset input ▶ Detects open circuits
PZE X4P	1-channel operation

Outputs: Voltage/current/ rating	Approvals	Order number	
		Spring-loaded terminals	Plug-in screw terminals
DC1: 24 V/5 A/125 W	CE, cULus Listed, EAC (Eurasian), TÜV, CCC	▶ 0.1 ... 3 s _____ 787 601 ▶ 1 ... 30 s _____ 787 602	▶ 0.1 ... 3 s _____ 777 601 ▶ 1 ... 30 s _____ 777 602
DC1: 24 V/8 A/200 W	CE, cULus Listed, EAC (Eurasian), TÜV, CCC	▶ 3 s _____ 787 512 ▶ 30 s _____ 787 510 ▶ Others available on request	▶ 3 s _____ 777 512 ▶ 30 s _____ 777 510 ▶ Others available on request
DC1: 24 V/8 A/200 W	CE, cULus Listed, EAC (Eurasian), TÜV, CCC	▶ 3 s selectable, 24 ... 240 V AC/DC _____ 787 532 ▶ 30 s selectable, 24 ... 240 V AC/DC _____ 787 530 ▶ Others available on request	▶ 3 s selectable, 24 ... 240 V AC/DC _____ 777 532 ▶ 30 s selectable, 24 ... 240 V AC/DC _____ 777 530 ▶ Others available on request
DC1: 24 V/8 A/200 W	CE, cULus Listed, EAC (Eurasian), TÜV, CCC	788 010	778 010
DC1: 24 V/5 A/125 W	CE, cULus Listed, EAC (Eurasian), BG, CCC	▶ 24 V DC _____ 787 340 ▶ Others available on request	▶ 24 V DC _____ 777 340 ▶ Others available on request
DC1: 24 V/5 A/125 W	CE, cULus Listed, EAC (Eurasian), BG, KOSHA, CCC	▶ 24 V AC _____ 787 354 ▶ 24 V DC _____ 787 355	▶ 24 V AC _____ 777 354 ▶ 24 V DC _____ 777 355
DC1: 24 V/6 A/150 W	CE, cULus Listed, EAC (Eurasian), TÜV, CCC	▶ U _M : 0.5 V _____ 787 949 ▶ U _M : 3 V _____ 787 950 ▶ U _M : 0.0075 ... 0.5 V _____ 787 951	▶ U _M : 0.5 V _____ 777 949 ▶ U _M : 0.5 V, coated version _____ 777 959 ▶ U _M : 3 V _____ 777 950 ▶ U _M : 0.0075 ... 0.5 V _____ 777 951
DC1: 24 V/6 A/150 W	CE, cULus Listed, EAC (Eurasian), TÜV, CCC	787 585	777 585

Technical
documentation
on safety relays
PNOZ X:

 Webcode:
web150635

Online information
at www.pilz.com

► Safety relay PNOZcompact

The safety relay is optimized for functionality and can be used in all areas of engineering. In series machine production in particular, the use of the PNOZcompact has many advantages thanks to its concentrated functionality: This allows high-volume projects with a high degree of standardization to be implemented economically. Choose a PNOZ safety relay – the original and a byword for safety relays.

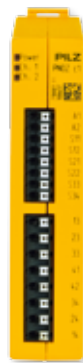

PNOZ c1

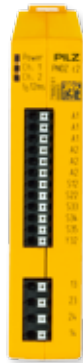

PNOZ c2

Square, simple, yellow

You want to safely monitor an E-STOP device, safety gate or light beam device? Is it important to you to save time through simple installation and maintenance? Then we have the right solution for you – the safety relay PNOZcompact.

PNOZ c1 is ideal for monitoring E-STOP devices or safety gates. A block diagram with connection example is printed on the side of the unit and is a great help. PNOZ c2 is predestined for the safe monitoring of type 4 light beam devices, e.g. PSENopt from Pilz, or sensors with OSSD outputs in accordance with EN 61496-1 with a guaranteed maximum reaction time of 12 ms. You save time through simple installation because the transmitter and receiver are supplied with voltage directly via the evaluation device.



Safety relay PNOZcompact

Common features

- PL e of EN ISO 13849-1, Safety Integrity Level (SIL) CL 3 of IEC 62061
- Supply voltage (U_B): 24 V DC
- LEDs to display operating voltage and switch status
- Spring-loaded terminals fixed on the device

Type	Application area	Dimensions (H x W x D) in mm
PNOZ c1	E-STOP relay and safety gate monitor	105 ¹⁾ x 22.5 x 100
PNOZ c2	For monitoring type 4 light beam devices or sensors with OSSD outputs in accordance with EN 61496-1	105 ¹⁾ x 22.5 x 100

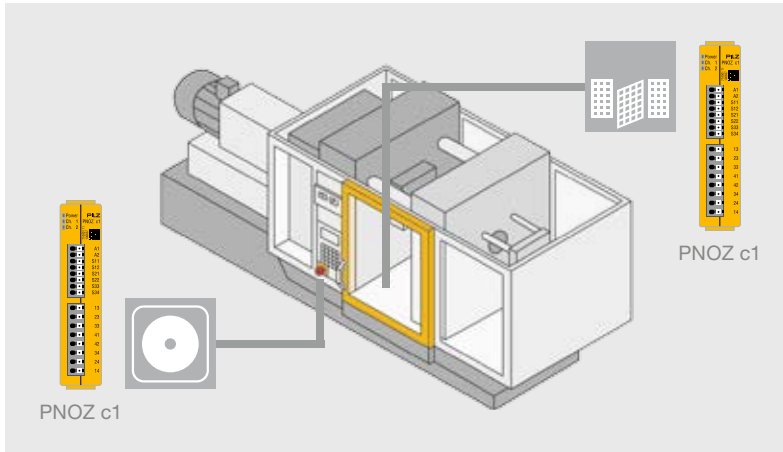

Monitor an E-STOP device or safety gate – in any application – safe, simple, compact. Use one safety relay per safety function.

Your benefits at a glance

- ▶ Save space in the control cabinet thanks to the compact design
- ▶ Simple installation and maintenance saves you time: push-in spring-loaded terminals fixed on the device, can be connected without the need for tools
- ▶ Tool-free assembly: simply attach the device to the top hat rail

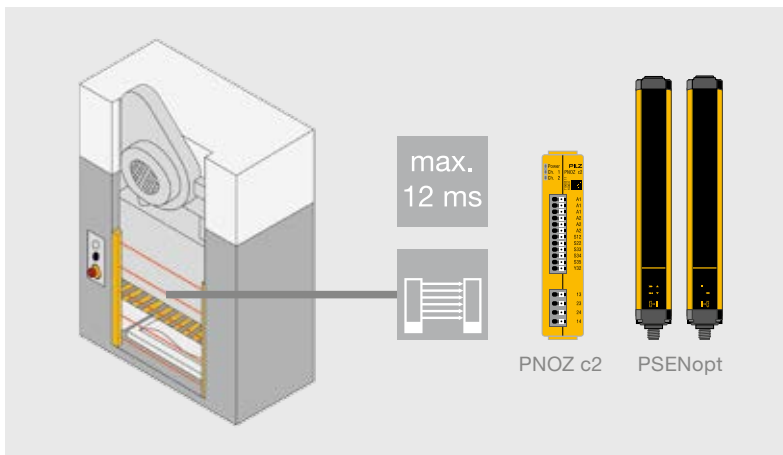

Monitor light beam devices, e.g. PSENopt from Pilz, or sensors with OSSD outputs safely, simply and in a compact form. All common light beam devices can also be connected.

Keep up-to-date on safety relays PNOZcompact:



Webcode: web150086

Online information at www.pilz.com

Features	Approvals	Order number
<ul style="list-style-type: none"> ▶ 3 safety contacts/1 auxiliary contact (3 N/O/1 N/C) ▶ 2-channel wiring with detection of shorts across contacts ▶ Manual or automatic start ▶ STOP category: 0 	CE, cULus Listed, EAC (Eurasian), TÜV, CCC	710001
<ul style="list-style-type: none"> ▶ 2 safety contacts (N/O)/1 semiconductor output ▶ 2-channel wiring without detection of shorts across contacts ▶ Monitored or automatic start ▶ Guaranteed maximum reaction time: 12 ms 	CE, cULus Listed, EAC (Eurasian), TÜV, CCC	710002

¹⁾ Height incl. spring clip

► Safety relay PNOZelog

You can use the product group PNOZelog to monitor up to four safety functions. PNOZelog combines the experience from electromechanical safety relays with the benefits of modern electronics and is 100% wear-free.



PNOZ e1.1p



PNOZ e6.1p

Extended diagnostics, easy to link

Wear-resistance, safety, long service life and high availability ensure it is cost-effective to use. What's more, the PNOZelog can be linked simply through logic AND/OR operations. Diagnostics on the PNOZelog have been extended. Power-up tests, self-checking and runtime tests guarantee maximum safety.

Complete safety functions through logic function operations

Units in the PNOZelog product range can be linked via logic operations to form complete safety functions. AND/OR operations are both available. The use of logic functions means that the output requires no additional wiring. As a result, both outputs on the PNOZelog units are freely available. As many units as necessary can be connected in series – ideal for monitoring up to four safety functions.



PNOZelog can be linked through logic AND/OR operations.

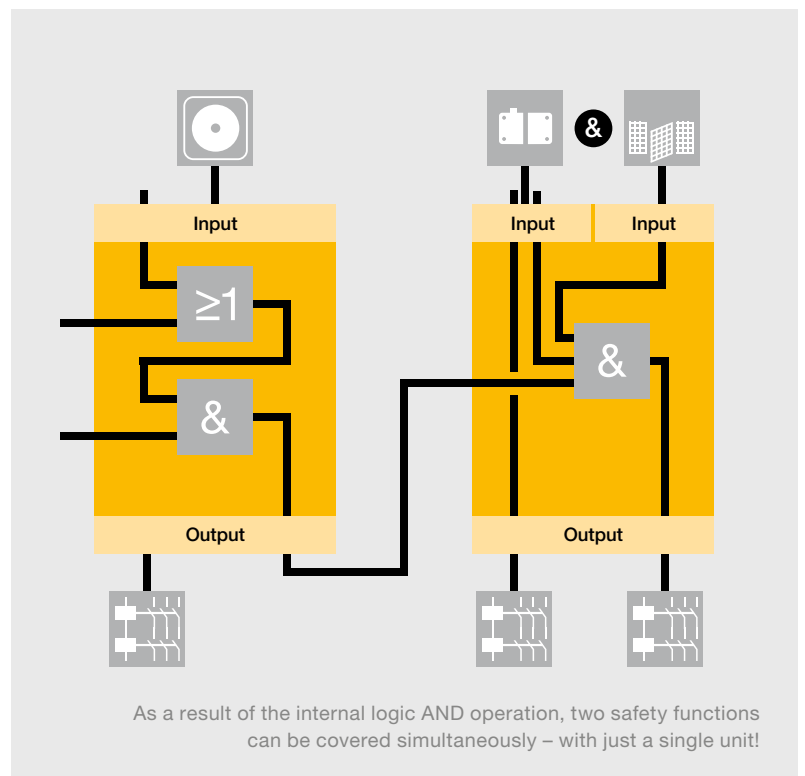

Less wiring due to linkable outputs.

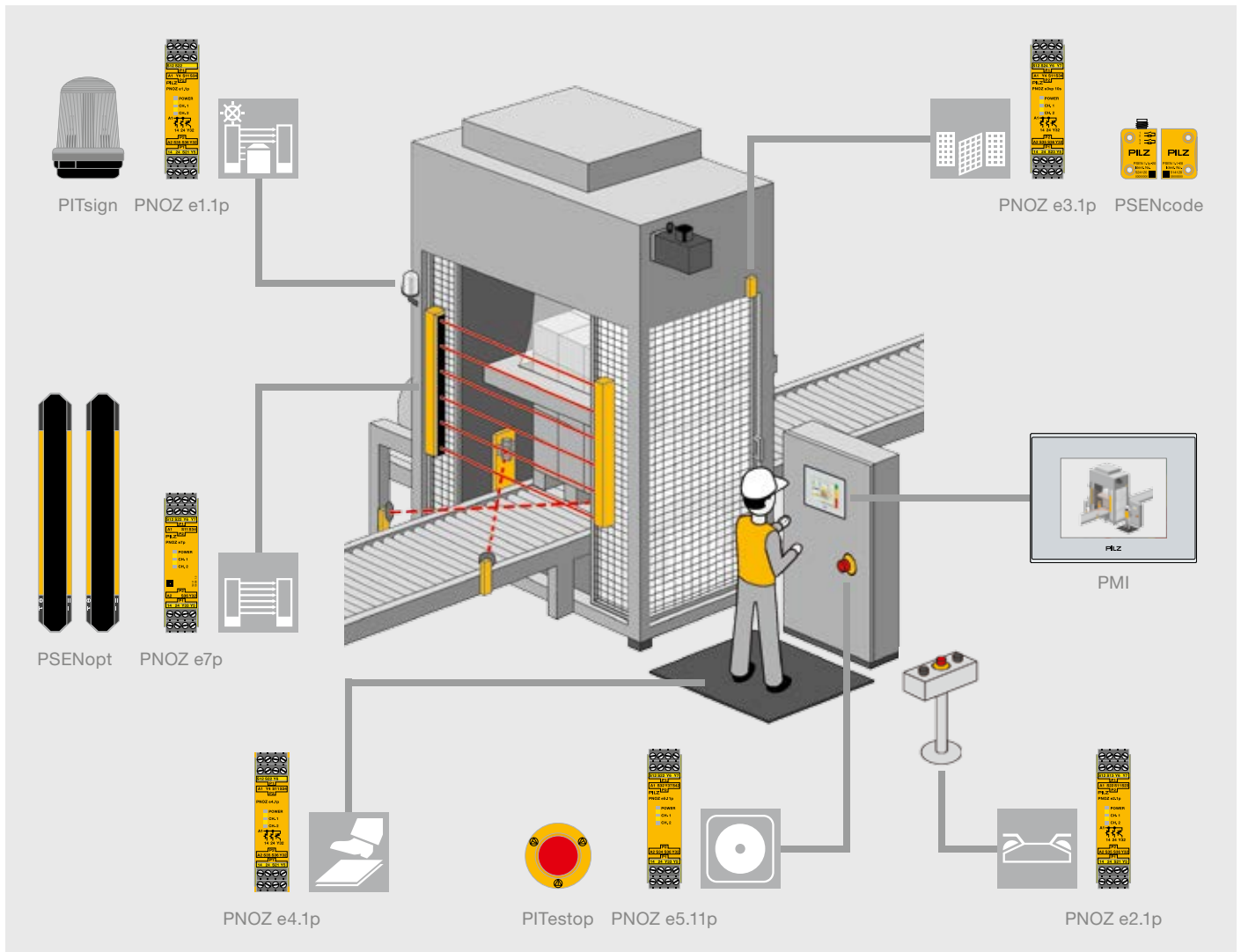

Your benefits at a glance

- ▶ Less wiring thanks to simple logic operations (AND/OR)
- ▶ High availability thanks to extended diagnostics
- ▶ Consistent use of semiconductor technology means no maintenance is necessary – there are no malfunctions due to contact welding, contamination, bounce or burning
- ▶ Continuous self-checks provide the highest level of safety – fault detection is not linked to the on/off cycle
- ▶ Long service life, even with frequent operations or cyclical functions
- ▶ Safe switching operations even on the smallest of loads
- ▶ Rapid commissioning thanks to plug-in terminals; no additional tools are required
- ▶ Complete solution comprising evaluation devices, compatible sensor technology and control and signal devices

Keep up-to-date
on safety relays
PNOZelog:

 Webcode:
web150101

Online information
at www.pilz.com

► Selection guide – PNOZelog

Safety relay PNOZelog



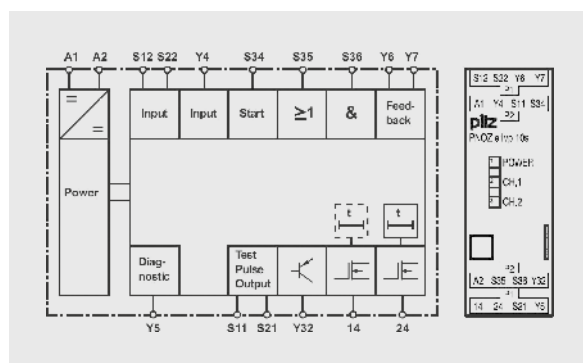



Type	Application					Performance Level (PL) – EN ISO 13849-1
PNOZ e1p	◆	◆	◆			e
PNOZ e1.1p	◆	◆	◆			e
PNOZ e1vp	◆	◆	◆			e
PNOZ e2.1p				◆	EN 574, Type IIIC	e
PNOZ e2.2p				◆	EN 574, Type IIIA	e
PNOZ e3.1p		◆				e
PNOZ e3vp		◆				e
PNOZ e4.1p					◆	d
PNOZ e4vp					◆	d
PNOZ e5.11p	◆	◆	◆			e
PNOZ e5.13p	◆	◆	◆			e
PNOZ e6.1p	◆	◆	◆			e
PNOZ e6vp	◆	◆	◆			e
PNOZ e7p				◆		e
PNOZ e8.1p with PLID d1	◆	◆	◆			d



Block diagram of PNOZ e1vp

Linking of multiple units using PNOZ e1vp as an example

The units of the PNOZelog product range can be logically linked to each other and to units of the PNOZmulti product range. On the PNOZelog, input S35 is intended for the logical OR operation and input S36 for the logical AND operation. Safety outputs 14 and 24 of the PNOZelog are suitable for logical operations.

Safety Integrity Level (SIL) CL – claim limit in accordance with IEC 62061	Semiconductor outputs		Relay outputs		Logic operations	
	Safe	Non-safety-related	Safe			
	 		 			
3	2	1	-	-		
3	2	1	-	-	◆	◆
3	2	1	-	-	◆	◆
3	2	1	-	-	◆	◆
1	2	1	-	-	◆	◆
3	2	1	-	-	◆	◆
3	2	1	-	-	◆	◆
2	2	1	-	-	◆	◆
2	2	1	-	-	◆	◆
3	2	2	-	-	◆ ¹⁾	
3	2	2	-	-	◆ ¹⁾	
3	2	1	4	-	◆	◆
3	2	1	4	-	◆	◆
3	2	1	-	-	◆	
2	2	2	-	-	◆	◆

¹⁾ Also AND-linked internally

Technical documentation on safety relays PNOZelog:

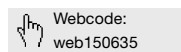

Online information at www.pilz.com

► Technical details – PNOZelog

Safety relay PNOZelog



PNOZ e1.1p



PNOZ e2.1p



PNOZ e3.1p



PNOZ e4.1p

Type	Application area	Outputs	Outputs: Voltage/ current/ rating
PNOZ e1p	Emergency stop, safety gate and light beam monitoring	Using semiconductor technology: ▶ 2 safety outputs ▶ 1 auxiliary output, can be switched to a diagnostic output ▶ 2 test pulse outputs	24 V DC/ 2 A/50 W
PNOZ e1.1p	Emergency stop, safety gate and light beam monitoring	Using semiconductor technology: ▶ 2 safety outputs ▶ 1 auxiliary output, can be switched to a diagnostic output ▶ 2 test pulse outputs	24 V DC/ 2 A/50 W
PNOZ e1vp	Emergency stop, safety gate and light beam monitoring	Using semiconductor technology: ▶ 2 safety outputs delayed/ instantaneous, delay-on de-energization selectable ▶ 1 auxiliary output, can be switched to a diagnostic output ▶ 2 test pulse outputs	24 V DC/ 2 A/50 W
PNOZ e2.1p PNOZ e2.2p	PNOZ e2.1p: in accordance with EN 574, requirement class IIIC; PNOZ e2.2p: in accordance with EN 574, requirement class IIIA: two-hand monitoring	Using semiconductor technology: ▶ 2 safety outputs ▶ 1 auxiliary output, can be switched to a diagnostic output ▶ 2 test pulse outputs	24 V DC/ 2 A/50 W
PNOZ e3.1p	Safety gate monitoring	Using semiconductor technology: ▶ 2 safety outputs ▶ 1 auxiliary output, can be switched to a diagnostic output ▶ 2 test pulse outputs	24 V DC/ 2 A/50 W
PNOZ e3vp	Safety gate monitoring	Using semiconductor technology: ▶ 2 safety outputs delayed/ instantaneous, delay-on de-energization selectable ▶ 1 auxiliary output, can be switched to a diagnostic output ▶ 2 test pulse outputs	24 V DC/ 2 A/50 W
PNOZ e4.1p	Evaluation device for safety mats	Using semiconductor technology: ▶ 2 safety outputs ▶ 1 auxiliary output, can be switched to a diagnostic output ▶ 2 test pulse outputs	24 V DC/ 2 A/50 W
PNOZ e4vp	Evaluation device for safety mats	Using semiconductor technology: ▶ 2 safety outputs delayed/ instantaneous, delay on de-energization selectable ▶ 1 auxiliary output, can be switched to a diagnostic output ▶ 2 test pulse outputs	24 V DC/ 1.5 A/40 W

Common features

- ▶ Supply voltage (U_B): 24 V DC
- ▶ Dimensions (H x W x D) in mm: 101/94¹⁾ x 22.5 x 121

Features	Approvals	Order number	
		Spring-loaded terminals	Plug-in screw terminals
<ul style="list-style-type: none"> ▶ Monitored or automatic start can be selected ▶ Selectable monitoring of shorts across contacts 	CE, cULus Listed, EAC (Eurasian), TÜV, CCC	784 130	774 130
<ul style="list-style-type: none"> ▶ Monitored or automatic start can be selected ▶ One AND and one OR input for logic AND/OR connections between several PNOZelog units ▶ Selectable monitoring of shorts across contacts 	CE, cULus Listed, EAC (Eurasian), TÜV, CCC	784 133	774 133
<ul style="list-style-type: none"> ▶ Delay time selectable ▶ Monitored or automatic start can be selected ▶ One AND and one OR input for logic AND/OR connections between several PNOZelog units ▶ Selectable monitoring of shorts across contacts 	CE, cULus Listed, EAC (Eurasian), TÜV, CCC	<ul style="list-style-type: none"> ▶ 10 s ____ 784 131 ▶ 300 s ____ 784 132 	<ul style="list-style-type: none"> ▶ 10 s ____ 774 131 ▶ 300 s ____ 774 132
<ul style="list-style-type: none"> ▶ One AND and one OR input for logic AND/OR connections between several PNOZelog units ▶ Shorts across contacts are monitored via two test pulse outputs ▶ Status indicator ▶ Feedback loop for monitoring external contactors 	CE, cULus Listed, EAC (Eurasian), TÜV, CCC	<ul style="list-style-type: none"> ▶ PNOZ e2.1p: 784 136 ▶ PNOZ e2.2p: 784 135 	<ul style="list-style-type: none"> ▶ PNOZ e2.1p: 774 136 ▶ PNOZ e2.2p: 774 135
<ul style="list-style-type: none"> ▶ Evaluation device for safety sensors PSEN 2.1p-10 and PSEN 2.1p-11 and position switch with N/C / N/O combination ▶ Monitored or automatic start can be selected ▶ One AND and one OR input for logic AND/OR connections between several PNOZelog units ▶ Selectable monitoring of shorts across contacts 	CE, cULus Listed, EAC (Eurasian), TÜV, CCC	784 139	774 139
<ul style="list-style-type: none"> ▶ Evaluation device for safety sensors PSEN 2.1p-10 and PSEN 2.1p-11 and position switch with N/C / N/O combination ▶ Delay time selectable, either monitored or automatic start possible ▶ One AND and one OR input for logic AND/OR connections between several PNOZelog units ▶ Selectable monitoring of shorts across contacts 	CE, cULus Listed, EAC (Eurasian), TÜV, CCC	<ul style="list-style-type: none"> ▶ 10 s ____ 784 137 ▶ 300 s ____ 784 138 	<ul style="list-style-type: none"> ▶ 10 s ____ 774 137 ▶ 300 s ____ 774 138
<ul style="list-style-type: none"> ▶ For connecting pressure-sensitive mats from Mayser (type SM/BK) and Bircher (type ESM5x) ▶ One AND and one OR input for logic AND/OR connections between several PNOZelog units 	CE, cULus Listed, EAC (Eurasian), TÜV, CCC	784 180	774 180
<ul style="list-style-type: none"> ▶ For connecting pressure-sensitive mats from Mayser (type SM/BK) and Bircher (type ESM5x) ▶ Delay time selectable ▶ One AND and one OR input for logic AND/OR connections between several PNOZelog units ▶ With or without reset function 	CE, cULus Listed, EAC (Eurasian), TÜV, CCC	10 s ____ 784 181	10 s ____ 774 181

Technical documentation on safety relays PNOZelog:

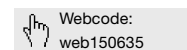

Online information at www.pilz.com

¹⁾ Height incl. spring-loaded terminals/plug-in screw terminals

► Technical details – PNOZelog

Safety relay PNOZelog



PNOZ e5.11p



PNOZ e5.13p



PNOZ e6.1p



PNOZ e7p

Type	Application area	Outputs	Outputs: Voltage/ current/rating
PNOZ e5.11p	Combination unit for monitoring 2 safety functions, AND-linked internally, AND input for logical connection of multiple units	Using semiconductor technology: ▶ 2 safety outputs ▶ 2 auxiliary outputs	24 V DC/ 1.5 A/40 W
PNOZ e5.13p	Combination unit for monitoring 2 safety functions, AND-linked internally, AND input for logical connection of multiple units	Using semiconductor technology: ▶ 2 safety outputs ▶ 2 auxiliary outputs	24 V DC/ 1.5 A/40 W
PNOZ e6.1p	Emergency stop, safety gate and light beam monitoring	Using semiconductor technology: ▶ 2 safety outputs ▶ 1 auxiliary output, can be switched to a diagnostic output ▶ 2 test pulse outputs Relay outputs: ▶ 4 safety contacts (N/O)	Outputs using semiconductor technology: 24 VDC/4 A/50 W Relay outputs: DC1: 24 V/6 A/150 W
PNOZ e6vp	Emergency stop, safety gate and light beam monitoring	Using semiconductor technology: ▶ 2 safety outputs delayed/instantaneous, delay on de-energization selectable ▶ 1 auxiliary output, can be switched to a diagnostic output ▶ 2 test pulse outputs Relay outputs: ▶ 4 safety contacts (N/O)	Outputs using semiconductor technology: 24 V/4 A/50 W Relay outputs: DC1: 24 V/6 A/150 W
PNOZ e7p	Safety light beam devices, start buttons	Using semiconductor technology: ▶ 2 safety outputs ▶ 2 test pulse outputs ▶ 1 auxiliary output	24 V DC/ 1.5 A/40 W
PNOZ e8.1p	Evaluation device for safe line monitoring with PLID d1	Using semiconductor technology: ▶ 2 safety outputs ▶ 2 auxiliary outputs	24 V DC/ 1.5 A/40 W

Common features

- ▶ Supply voltage (U_B): 24 V DC
- ▶ Dimensions (H x W x D) in mm: 101/94¹⁾ x 22.5 x 121, PNOZ e6.1p and PNOZ e6vp: 101/94¹⁾ x 45 x 121 mm

Features	Approvals	Order number	
		Spring-loaded terminals	Plug-in screw terminals
<ul style="list-style-type: none"> ▶ Connection possibilities for E-STOP pushbuttons, safety gate limit switches, start buttons, proximity switches, position switches with N/C / N/C combination ▶ For processing signals from output switching elements of light grids (OSSDs) ▶ Monitored or automatic start can be selected 	CE, cULus Listed, EAC (Eurasian), TÜV, CCC	784 190	774 190
<ul style="list-style-type: none"> ▶ Connection possibilities for E-STOP pushbuttons, safety gate limit switches, start buttons, proximity switches, PSEN 2.x safety sensors, position switches with N/C / N/C or N/C / N/O combination ▶ For processing signals from output switching elements of light grids (OSSDs) ▶ Monitored or automatic start can be selected 	CE, cULus Listed, EAC (Eurasian), TÜV, CCC	784 191	774 191
<ul style="list-style-type: none"> ▶ Connection possibilities for E-STOP pushbuttons, safety gate limit switches, start buttons, proximity switches ▶ For processing signals from output switching elements of light grids (OSSDs) ▶ Monitored or automatic start can be selected ▶ One AND and one OR input for logic AND/OR connections between several PNOZelog units ▶ Selectable monitoring of shorts across contacts 	CE, cULus Listed, EAC (Eurasian), TÜV, CCC	784 192	774 192
<ul style="list-style-type: none"> ▶ Connection possibilities for E-STOP pushbuttons, safety gate limit switches, start buttons, proximity switches ▶ For processing signals from output switching elements of light grids (OSSDs) ▶ Delay time selectable ▶ Monitored or automatic start can be selected ▶ One AND and one OR input for logic AND/OR connections between several PNOZelog units ▶ Selectable monitoring of shorts across contacts 	CE, cULus Listed, EAC (Eurasian), TÜV, CCC	784 193	774 193
<ul style="list-style-type: none"> ▶ Connection possibilities for safety light beam devices PSEN op2S-1-1, PSEN op4S-1-1, PSEN op4S-1-2, start buttons ▶ Two operating modes selectable ▶ Monitored or automatic start can be selected ▶ One linking input for logic AND connections between multiple units 	CE, cULus Listed, EAC (Eurasian), TÜV, CCC	784 197	774 197
<ul style="list-style-type: none"> ▶ Connection possibilities for PLID d1, E-STOP pushbuttons, safety gate limit switches, start buttons, proximity switches, position switches with N/C / N/C combination ▶ For processing signals from output switching elements of light grids (OSSDs) ▶ Monitored or automatic start can be selected ▶ Monitoring of shorts across contacts can be selected for E-STOP application 	TÜV, UL/cUL, CCC	784 198	774 198

¹⁾ Height incl. spring-loaded terminals/plug-in screw terminals

Technical documentation on safety relays PNOZelog:

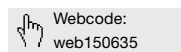

Online information at www.pilz.com

▶ Safe line inspection device PLIDDys – Safe power-

The safe line inspection device PLIDDys provides safe power-up on two-wire connections, ensuring maximum safety on long cable routes.



PLID d1 + PNOZ e8.1p

With PLIDDys, unintended power-up or plant start-up can be excluded in the event of an error. This is particularly beneficial on interlinked plants or on plant sections distributed over a wide area, which may not always be clearly visible. The extremely compact design means that PLIDDys can be easily retrofitted in an existing plant and incorporated in, for example, the sensor or switch. In combination with the evaluation device PNOZ e8.1p, the line inspection device PLIDDys is the optimum solution for safe cables/connections.



Selection guide – Safe line inspection device PLIDDys



PLID d1 C

Type	Application area
PLID d1	Line inspection device PLIDDys in combination with the evaluation device PNOZ e8.1p
PNOZ e8.1p	Evaluation device for safe line inspection with PLID d1

up in conjunction with PNOZ e8.1p

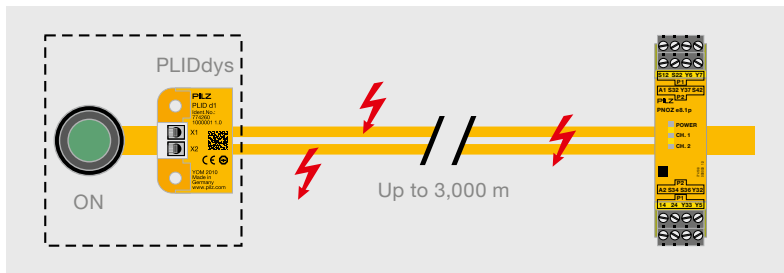

Monitoring for potential wiring errors and protection against power-up in the event of an error.

Example applications of the line inspection device PLIDdys

Safe inspection of long cable routes in critical environments

- ▶ Cable cars, lift systems
- ▶ Wind turbines
- ▶ Conveyor belts in open cast mining or underground
- ▶ Tunnel boring machinery
- ▶ Press lines
- ▶ Fairground rides
- ▶ Drag chain applications
- ▶ Interlinked/distributed plant sections

Your benefits at a glance

- ▶ All potential wiring errors are detected through constant line inspection by PLIDdys, no need for customized tests
- ▶ PLIDdys can be looped into the existing wiring, so few additional costs
- ▶ Easy to integrate into existing plants thanks to its small dimensions
- ▶ Saves costs, as the prevailing periphery can be retained
- ▶ Suitable for cable lengths up to 3,000 meters

Features

- ▶ Cable cross section 0.5 mm² ... 1.5 mm²
- ▶ Maximum cable length 3,000 m
- ▶ Cable resistance max. 220 Ω
- ▶ Power supply 24 V DC
- ▶ Weight 10 g
- ▶ Temperature range -30 °C ... +70 °C
- ▶ Dimensions (H x W x D) in mm: 36 x 26 x 12.1 ¹⁾

Approvals

TÜV, UL/cUL

Order number

- ▶ PLID d1 C with spring-loaded terminals _____ 784 260
- ▶ PLID d1 with plug-in screw terminals _____ 774 260

- ▶ Outputs using semiconductor technology:
 - 2 safety outputs
 - 2 auxiliary outputs
- ▶ Outputs: Voltage/current/rating: 24 VDC/1.5 A/40 W
- ▶ Monitored or automatic start can be selected
- ▶ Monitoring of shorts across contacts can be selected for E-STOP application
- ▶ Dimensions (H x W x D) in mm: 101/94 ²⁾ x 22.5 x 121

TÜV, UL/cUL, CCC

- ▶ PNOZ e8.1p C with spring-loaded terminals _____ 784 198
- ▶ PNOZ e8.1p with plug-in screw terminals _____ 774 198

Keep up-to-date on safe line inspection device PLIDdys:

Webcode:
web150901

Online information at www.pilz.com

¹⁾ Depth incl. spring-loaded terminals/plug-in screw terminals

²⁾ Height incl. spring-loaded terminals/plug-in screw terminals

► Safety relays PNOZpower

The safety relays PNOZpower are suitable for monitoring E-STOP devices, safety gates and light beam devices. PNOZpower can switch currents of up to 16 A AC/DC per contact. An overall breaking capacity of 40 A is available per module.



PNOZ p1p



PNOZ po3p

Switching high loads safely

External contactors and contactor combinations are no longer required. The control circuit and main circuit are switched with one safety relay. The EC type examination is valid for the whole safety circuit.

Modular and flexible

The base unit processes the inputs; the output modules are specifically matched to the respective load. The number and capacity of the required safety contacts can be scaled, depending on the application. A maximum of five modules can be connected to the base unit. Modules are wired to the base unit via an internal bus system.

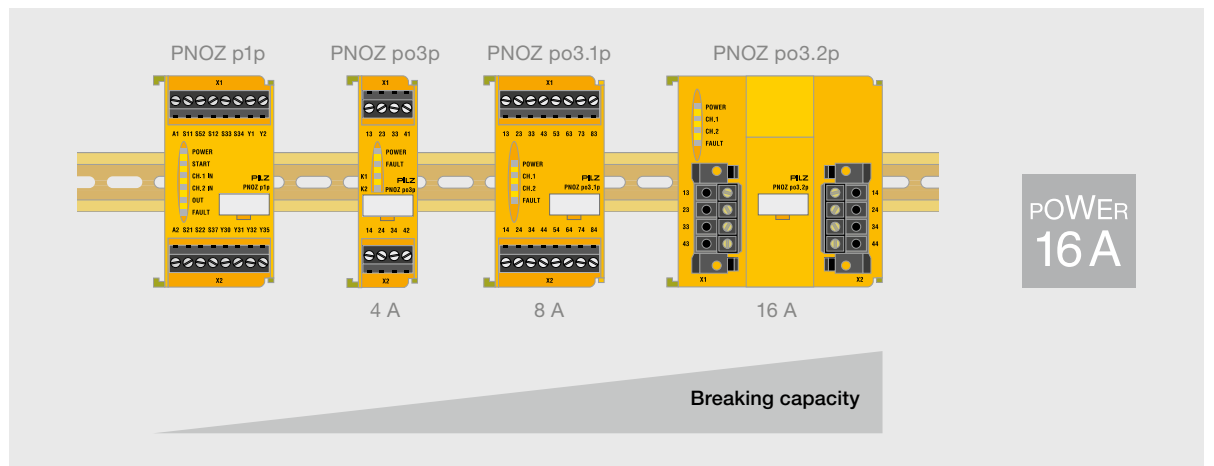

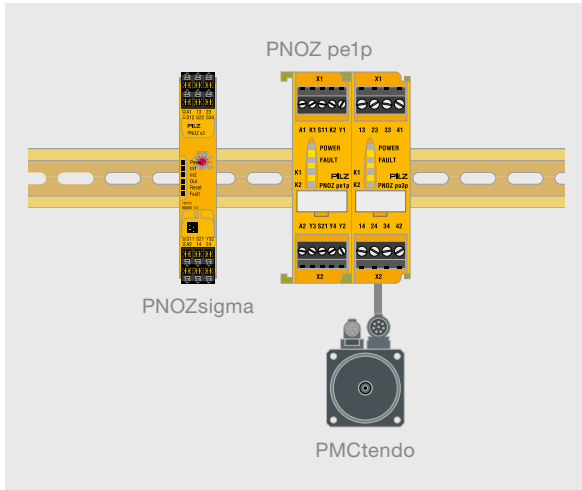

Volt-free switching with the PNOZ pe1p control module

In conjunction with at least one expansion module from the PNOZpower range, the PNOZ pe1p control module safely shuts down motors or supply voltages on valves and contactors.

The PNOZ pe1p can be controlled using the following evaluation devices:

- ▶ Safety relays PNOZsigma, PNOZ X and PNOZelog
- ▶ Configurable small controllers PNOZmulti

Benefit to you: Potential-free switching up to 16 A.

Your benefits at a glance

- ▶ External contactor combinations and their respective wiring are no longer required, saving costs, space and commissioning time
- ▶ Diagnostics via LED: operating and fault status is visible on each module, resulting in reduced downtimes
- ▶ Plug-in connection terminals: pre-wired and easy to exchange if there is a fault
- ▶ Redundant load switching
- ▶ Scalable and flexible by selecting compatible modules – you only pay for the functions that you actually use
- ▶ Complete solution comprising evaluation devices, compatible sensor technology and control and signal devices

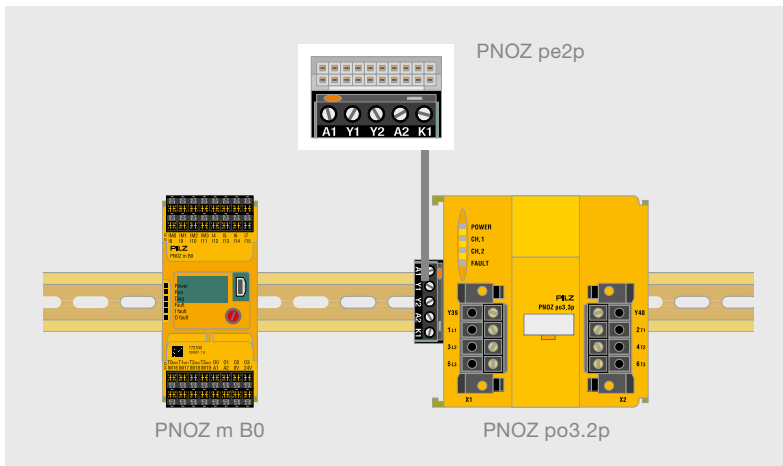

The PNOZpower safety relays and the PNOZmulti configurable small controllers can be combined simply using the coupling connector PNOZ pe2p.

Connection to PNOZmulti

Specially developed for connection to the PNOZmulti configurable small controllers, PNOZpower units can be docked via the coupling connector PNOZ pe2p.



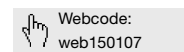

Keep up-to-date on safety relays PNOZpower:



Online information at www.pilz.com

► Selection guide – PNOZpower

Base units – Safety relays PNOZpower

Type	Application area	Application				Performance Level (PL) – EN ISO 13849-1
						
PNOZ p1p	Base unit	◆	◆	◆		e
PNOZ p1vp	Base unit, delayed	◆	◆	◆	◆	e (d) ¹⁾

Contact expansion modules – Safety relays PNOZpower

Type	Output contacts		Performance Level (PL) – EN ISO 13849-1
	Safe	Non-safety-related	
			
PNOZ po3p	3	1	e
PNOZ po3.1p	8	-	e
PNOZ po3.2p	4	-	e
PNOZ po3.3p	3	-	e
PNOZ po4p	4	-	e

Accessories – Safety relays PNOZpower

Type	Application area	Application	Performance Level (PL) – EN ISO 13849-1
PNOZ pe1p	Control module	For control via safety contacts or safe semiconductor outputs	e
PNOZ pe2p	Bus interface	Coupling connector for connecting PNOZpower expansion modules to a higher-level controller	e
PNOZ pps1p	Power supply	-	-

Safety Integrity Level (SIL) CL – claim limit in accordance with IEC 62061	Number of expansion modules	Supply voltage	Dimensions (H x W x D) in mm
3	Min. 1, max. 4 expansion modules	24 V DC	94 x 45 x 135
3	Min. 1, max. 8 expansion modules (max. 4 delayed and 4 instantaneous)	24 V DC	94 x 45 x 135

¹⁾ Value applies to instantaneous (delayed) safety contacts

Safety Integrity Level (SIL) CL – claim limit in accordance with IEC 62061	Number of expansion modules			Dimensions (H x W x D) in mm
	AC1	AC3	DC1	
3	240 V/4 A/960 VA	-	24 V/4 A/96 W	94 x 22.5 x 121
3	240 V/8 A/2000 VA	-	24 V/8 A/200 W	94 x 45 x 121
3	240 V/16 A/4000 VA	-	24 V/16 A/400 W	94 x 90 x 135
3	240 V/16 A/4000 VA 400 V/10 A/4000 VA 500 V/8 A/4000 VA	240 V/3.0 kW 400 V/5.5 kW 500 V/4.0 kW	24 V/16 A/400 W	94 x 90 x 135
3	240 V/4 A/960 VA	-	24 V/4 A/96 W	94 x 22.5 x 121

Safety Integrity Level (SIL) CL – claim limit in accordance with IEC 62061	Number of expansion modules	Supply voltage	Dimensions (H x W x D) in mm
3	Min. 1, max. 4 expansion modules	24 V DC	94 x 22.5 x 121
3	Min. 1, max. 6 expansion modules	24 V DC	29 x 23.5 x 22
-	-	100 ... 240 V AC	94 x 45 x 121

Keep up-to-date on safety relays PNOZpower:

 Webcode: web150107

Online information at www.pilz.com

► Technical details – PNOZpower

Safety relays PNOZpower



PNOZ p1p



PNOZ pe1p



PNOZ pe2p



PNOZ pps1p



PNOZ po3p



PNOZ po3.2p

Type	Application area	Inputs/outputs	Supply voltage
PNOZ p1p	Base unit	2 semiconductor outputs	24 V DC
PNOZ p1vp	Base unit, delayed	2 semiconductor outputs	24 V DC
PNOZ pe1p	Control module	Expansion module control output connected to the PNOZpower bus	24 V DC
PNOZ pe2p	Bus interface	Output connected to PNOZpower bus	24 V DC
PNOZ pps1p	Power supply	-	100 ... 240 V AC/DC
PNOZ po3p PNOZ po4p	Expansion modules	<ul style="list-style-type: none"> ► PNOZ po3p: <ul style="list-style-type: none"> - 3 safety contacts (N/O) - 1 auxiliary contact (N/C) ► PNOZ po4p: <ul style="list-style-type: none"> - 4 safety contacts (N/O) 	Via PNOZpower bus
PNOZ po3.1p	Expansion module	8 safety contacts (N/O)	Via PNOZpower bus
PNOZ po3.2p	Expansion module	4 safety contacts (N/O)	Via PNOZpower bus
PNOZ po3.3p	Expansion module	3 safety contacts (N/O)	Via PNOZpower bus

Features	Approvals	Order number Plug-in screw terminals
<ul style="list-style-type: none"> ▶ Dual-channel wiring, with or without detection of shorts across contacts ▶ Monitored or automatic start can be selected ▶ Connection between PNOZ p1p and expansion modules via PNOZpower bus, using jumpers on the back of the unit 	CE, cULus Listed, EAC (Eurasian), TÜV, CCC	773 300
<ul style="list-style-type: none"> ▶ Dual-channel wiring, with or without detection of shorts across contacts ▶ Monitored or automatic start can be selected ▶ Delay time can be selected via rotary switch and potentiometer ▶ Connection between PNOZ p1vp and expansion modules via PNOZpower bus, using jumpers on the back of the unit 	CE, cULus Listed, EAC (Eurasian), TÜV, CCC	<ul style="list-style-type: none"> ▶ 30 s ____ 773 950 ▶ 300 s ____ 773 951
<ul style="list-style-type: none"> ▶ 1-channel operation, without detection of shorts across contacts ▶ 2-channel operation, with or without detection of shorts across contacts ▶ Connection between PNOZ pe1p and expansion modules via PNOZpower bus, using jumpers on the back of the unit ▶ Status indicator for output relay, supply voltage and fault ▶ Connection for feedback loop 	CE, cULus Listed, EAC (Eurasian), TÜV, CCC	773 900
<ul style="list-style-type: none"> ▶ Control via safety contacts or safe semiconductor outputs ▶ 1-channel operation, without detection of shorts across contacts ▶ Connection between PNOZ pe2p and expansion modules via PNOZpower bus 	CE, cULus Listed, EAC (Eurasian), TÜV, CCC	779 125
<ul style="list-style-type: none"> ▶ Galvanic isolation ▶ Short-circuit-proof ▶ 24 V DC at plug-in connector on back of unit for PNOZpower bus and at terminals ▶ LEDs for supply voltage, output voltage and fault 	CE, cULus Listed, EAC (Eurasian), TÜV, CCC	773 200
<ul style="list-style-type: none"> ▶ 2-channel operation with the ability to detect short circuits via the base unit ▶ LEDs for switch status of channels 1/2, supply voltage and fault 	CE, cULus Listed, EAC (Eurasian), TÜV, CCC	<ul style="list-style-type: none"> ▶ PNOZ po3p: 773 634 ▶ PNOZ po4p: 773 635
	CE, cULus Listed, EAC (Eurasian), TÜV, CCC	773 630
	CE, cULus Listed, EAC (Eurasian), TÜV, CCC	773 631
<ul style="list-style-type: none"> ▶ 2-channel operation with the ability to detect short circuits via the base unit ▶ LEDs for switch status of channels 1/2, supply voltage and fault ▶ Suitable for safety-related switching of loads with utilisation category AC3 (e.g. motor) ▶ External start/stop input for non-safety-related load switching 	CE, cULus Listed, EAC (Eurasian), TÜV, CCC	773 632

Technical documentation on safety relays PNOZelog:

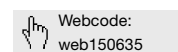
 Online information at www.pilz.com

► Safety Device Diagnostics

In combination with e.g. PNOZsigma or PNOZ X, Safety Device Diagnostics (SDD) provides simple and extensive diagnosis of safety devices. The signal I/Os of the safety devices, such as PSENcode, have their functions extended. Status information is interrogated, configuration parameters read and actions performed. Safety Device Diagnostics is the ideal solution for your application as it provides you with an overview of the safety devices at all times and from any location.



Fewer service calls, higher availability

The availability of plant and machinery is also determined by safety devices. The extended diagnostic possibilities of Pilz safety devices with Safety Device Diagnostics can reduce service calls to your customers. End users benefit from a higher machine availability thanks to faster error diagnostics. Safety Device Diagnostics can also provide an interface to the plant bus for all safety devices. Thanks to its expandability, Safety Device Diagnostics supports a modular machine structure within the framework of Industrie 4.0.

Complete solution for extended diagnostics

Safety Device Diagnostics consists of a fieldbus module plus junction box and safety devices (e.g. sensors) and, in combination with e.g. PNOZsigma or PNOZ X, offers a cost-effective complete solution. The safety devices are automatically activated by the fieldbus module so that the signal contacts for the Safety Device Diagnostics are enabled. For example, a simple series connection of sensors in the field and the remote maintenance via web server are possible. The solution using safety device diagnostics therefore provides many more advantages than a conventional wiring of signal contacts. You decide which solution is optimum for your needs: The sensor remains the same.

Type code for Safety Device Diagnostics

SDD ES ETH

Product area Pilz network components	Version
Product group SDD ES – Safety Device Diagnostics Electronic module Standard	ETH Communication module with ETH interface PROFIBUS Communication module with PROFIBUS interface PROFINET Communication module with PROFINET interface

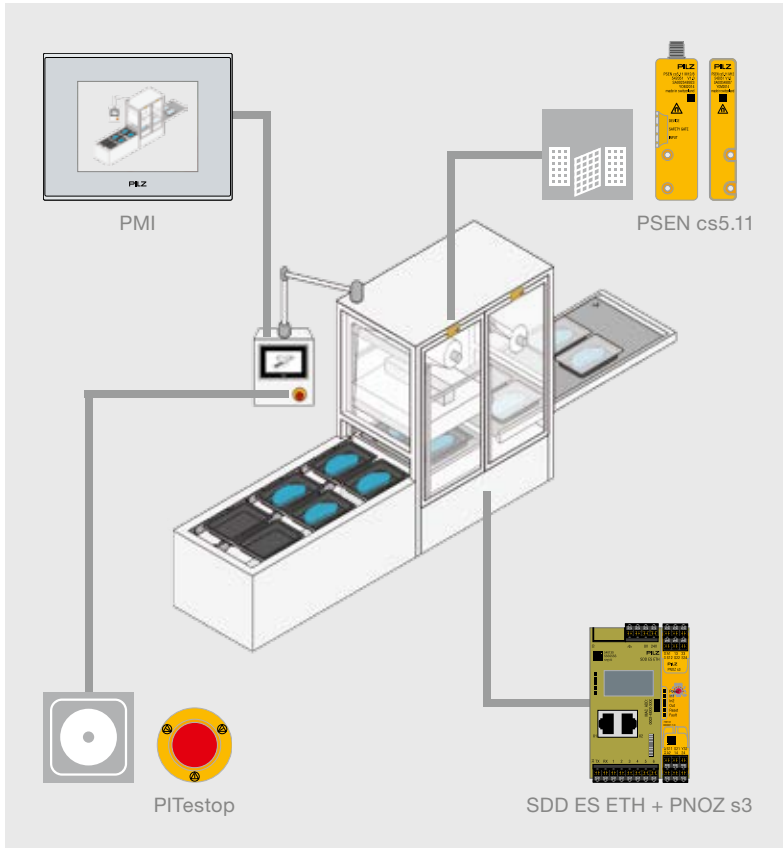

Your benefits at a glance

- ▶ Comprehensive diagnostics for reducing service calls and downtimes
- ▶ Simple diagnostics thanks to use of the same sensors and optional IP67 cabling
- ▶ Information is received directly via the display on the fieldbus module
- ▶ Quick and easy installation due to series connection in the field
- ▶ Third-party devices can be connected directly via the I/Os on the fieldbus module
- ▶ Cost-effective complete solution, e.g. with PNOZ X or PNOZsigma

Components for your safe solution	Order number
Sensor: PSEN cs6.11	542 111
Connection: PSEN cable, M12, 8-pin, 5 m distributor IP20	540 320 535 112
Evaluation device: PNOZ s3	751 103
Fieldbus module: SDD ES ETH	540 130
- spring-loaded terminals	540 121
- plug-in screw terminals	540 120

The coded safety switches PSENcode, which are often connected in series, are ideal here; see PSENcode slimline design.



Keep up-to-date on Safety Device Diagnostics:

 Webcode: web150456

Online information at www.pilz.com

▶ Technical details – Safety Device Diagnostics

Safety Device Diagnostics

Common features

- ▶ System consisting of fieldbus module, distributor and safety devices (e.g. PSENcode slimline design)
- ▶ Automatic activation of safety devices by the fieldbus module
- ▶ Suitable for 16 sensors wired in series or individually wired
- ▶ 6 additional configurable I/Os
- ▶ Cable lengths:
 - Overall max. 900 m
 - Device 1 to device 2: 50 m
 - Last device to communication module: 150 m
- ▶ Reaction times (not safety-related):
 - Diagnostic data: < 1 second
 - Safety-related data: see individual safety device



SDD ES ETH

Type

SDD ES ETH
SDD ES PROFIBUS
SDD ES PROFINET
PSEN Y junction M8-M12/M12 PIGTAIL
PSEN Y junction M12-M12/M12 PIGTAIL
PSEN Y junction M12 SENSOR
PSEN Y junction M12 cable
PSEN Y junction M8 SENSOR
PSEN Y junction M8 cable
PSEN ix2 F4 code
PSEN ix2 F8 code
SDD ES ETH starter set I

Features	Approvals	Order number
Communication module with ETH connection	CE, cULus Listed	540 130
Communication module with PROFIBUS connection	CE, cULus Listed	540 132
Communication module with PROFINET connection	CE, cULus Listed	540 138
Junction with pigtail IP67 for one sensor	-	540 337
Junction with pigtail IP67 for one sensor	-	540 338
Junction without pigtail IP67 for one sensor	-	540 315
Junction without pigtail IP67 for one sensor	-	540 316
Junction without pigtail IP67 for one sensor	-	540 317
Junction without pigtail IP67 for one sensor	-	540 318
Distributor IP20 for up to four sensors	UL/cUL	535 111
Distributor IP20 for up to eight sensors	UL/cUL	535 112
<ul style="list-style-type: none"> ▶ Communication module with ETH connection ▶ Two PSENcode sensors ▶ Junction box ▶ PSEN cable ▶ Ethernet cable ▶ Power supply ▶ Spring-loaded terminals 	-	540 110

Technical documents for Safety Device Diagnostics:

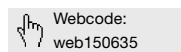

Online information at www.pilz.com

► Configurable small controllers

The configurable small controllers bridge the gap between classic safety relays and large programmable control systems. Use the configurable small controllers PNOZmulti to implement multiple safety functions. Functional safety to protect man and machine is thus achievable both simply and flexibly. On small machines, the small controllers PNOZmulti also perform automation tasks. Your plant and machinery is visualized optimally using the web-based visualization software PASvisu.

Product area

Configurable small controllers

► Configurable small controllers PNOZmulti	68
► Configurable control systems PNOZmulti 2	74
► Configurable compact controllers PNOZmulti Mini	84
► Configurable safety systems PNOZmulti	92
► Software tools for small controllers	106
► Accessories PNOZmulti	108
► Decentralized modules PDP67	110
► Cable navigator	112





► Configurable small controllers PNOZmulti – Many



With PNOZmulti, the pioneer among configurable safety technology, you can be sure you've made the right decision. Why? It's quite simple: Because with PNOZmulti you can rely on a system in use successfully worldwide, always at the forefront of technology. The configurable small controllers bridge the gap between classic safety relays and large programmable control systems. Use the configurable small controllers PNOZmulti mainly to implement multiple safety functions. Functional safety to protect man and machine is thus achievable both simply and flexibly.



PNOZ m B0



PNOZ m B1

Configurable control systems PNOZmulti 2

PNOZmulti 2 is the very latest generation. If you need to monitor more than four safety functions, PNOZmulti is the right solution for you. The full function range of the "classic" PNOZmulti base units is now available in a unit measuring 45 mm in width. The modular structure is as flexible as your application.



PNOZ mm0.1p

Configurable compact controllers PNOZmulti Mini

PNOZmulti Mini is worthwhile if you have three or more safety functions. You choose between four base units and a small number of expansion modules. Additional output contacts are possible using the contact expansion modules from the product group PNOZsigma.

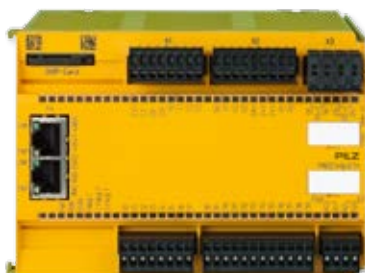

PNOZ m1p ETH

Configurable safety systems PNOZmulti

PNOZmulti is the classic safety system. The system is characterized by a diverse range of modules and communication options.

Your benefits at a glance

- Cost-effective and long-lasting: worldwide safety standard for many automation environments and communication systems
- Just one system from planning to maintenance
- Flexible: configuration using certified software blocks, simple adjustment and adaptation
- Customized costs: exact adaptation to your application using expansion modules
- Minimal machine downtimes and high plant availability through simple, user-friendly diagnostics
- Maximum safety – depending on the wiring, safety categories up to PL e and SIL CL 3
- Simple wiring means short commissioning times
- Potential for rationalization because safety components cover automation tasks
- Suitable for international use due to worldwide certification
- User-friendly thanks to technical support

functions, one solution!

All for one and one for all

The software tool PNOZmulti Configurator will convince you with its simple operation: install, open, work intuitively. Furthermore, you have several options for carrying out diagnostics – for high plant availability and minimal downtimes. The range of fieldbuses and communication possibilities are a major benefit of PNOZmulti. It allows the system to be used independently of the higher-level operation control system. A wide selection of expansion modules ensures maximum flexibility and safety for your application. Input and output modules, motion monitoring modules and link modules are available.

Potential for rationalization:

Safety components cover automation tasks

PNOZmulti is powerful enough to assume complete machine control on smaller machines. You can count on products of an extremely high quality. Moreover, as there is no need for an additional control system, PNOZmulti can make savings in a range of areas, from hardware costs and space in the control cabinet to procurement and stock holding costs.

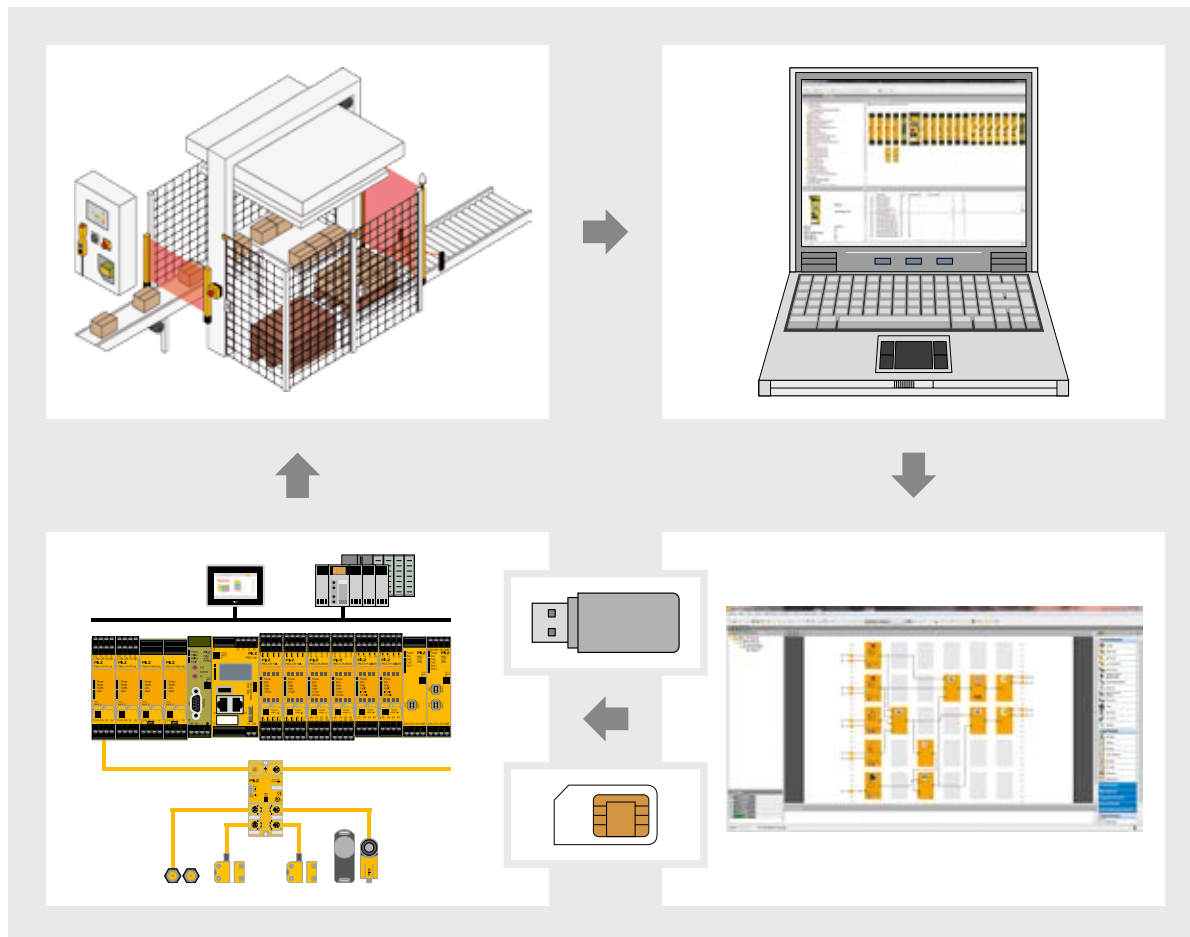

From your application to the solution with PNOZmulti. Configure the hardware and the safety circuit using the convenient software tool PNOZmulti Configurator. The configuration, which is stored on an exchangeable storage medium (chip card or USB stick), is inserted into the base unit and installed. This shortens your time-to-market and allows you to harness great cost-saving potential in all engineering phases – from planning all the way to maintenance!

Configurable small controllers

Keep up-to-date on configurable small controllers PNOZmulti:

 Webcode: web150495

Online information at www.pilz.com

► Software for the configurable small controllers

PNOZ



PNOZmulti small controllers make design, configuration, documentation and commissioning simple. Easy diagnostic solutions reduce standstill times on your plant or machine. Our user-friendly software tools are available to do this. With the PNOZmulti Configurator, you can create your safety circuit on the PC. The software has a broad function and command range so that even large-scale projects can be easily implemented. For user-friendly diagnostics, you can use the tools of the diagnostic solution PVIS. You can keep a close eye on your automation system using the web-based visualization software PASvisu.



Simple hardware configuration by means of drag&drop.



Simple application creation, linking using the mouse.

Flexible to use and child's play to operate

First select the necessary hardware by drag&drop. The hardware consists of a base unit and, if necessary, expansion modules. The number of available inputs and outputs is displayed in table form. The software tool provides support, for example, by listing the expansion modules available for the selected base unit. The tool can also help if the permitted number of expansion modules has been exceeded or if the modules have been positioned incorrectly. Online help with documentation is available throughout configuration.

Mouse used for wiring

The graphics-based user interface conforms to the Windows® standard; the elements of the safety circuit are available as icons or in selection menus. Simply drag them onto the user interface and link them using the mouse.

You protect the safety circuit against tampering with passwords and transfer it to the base unit. A chip card or, with the PNOZ m B1, a USB stick is used as the exchangeable storage medium.



PNOZmulti



A wide range of logic connections can be combined to form a macro.

Enter a new dimension with macro elements

The logic connections that are defined between inputs and outputs can be combined into macro elements. Once created, macro elements are stored in the macro library. They are then available for use in all further configurations. A simple import and export function and the ability to edit macros within the editor reduce your engineering time and save costs. Macros can also be read and write protected, so protecting your expertise.

Your benefits at a glance

- ▶ The PNOZmulti Configurator is a universal tool for all engineering phases – planning, project development, commissioning, operation and maintenance
- ▶ Short time-to-market thanks to time and cost saving
- ▶ PVIS minimizes machine downtimes through the fast, effective rectification of faults

The technical details for the PNOZmulti Configurator can be found on page 106.

Keep up-to-date on the software tool PNOZmulti Configurator:

 Webcode:
web150399

Online information at www.pilz.com



Reducing downtimes using the diagnostic solution PVIS

PVIS helps to visualize diagnostic information for PVIS-enabled control systems, such as small controllers PNOZmulti or drive technology PMC. Together with the PMI operator terminals, this provides you with a complete, fully integrated diagnostic solution. With the PVIS OPC and OPC UA tools, PVIS is available on the basis of standard software interfaces so that it can be integrated in almost any environment. The OPC UA standard is used for smart factory plants within the framework of Industrie 4.0. If a fault occurs, features such as plain text messages with precise information on the location, clearly defined responsibilities and integrated first fault display all ensure that production is quickly restarted. The PNOZmulti Configurator contains the PNOZmulti project, texts for diagnostics, proposed solutions and much more. The benefits are obvious: simpler project development, greater flexibility and reduction of downtimes.



Keep up-to-date on the software tool "Diagnostic solution PVIS":

 Webcode:
web150398

Online information at www.pilz.com

► Optimum visualization and simple diagnostics



Use perfectly matched software to visualize your plant and machinery that use the small controllers PNOZmulti. Using an OPC UA server connection, you can easily link PNOZmulti to the web-based visualization software PASvisu and import all variables of the small controller. So you can combine the control of your machine's safety functions with all the benefits on offer from the PASvisu. Thanks to a direct connection to the PNOZmulti small controllers, the full function range of the software (including diagnostic capability) is available with version 1.4 of the visualization software PASvisu.



PMIvisu with visualization software PASvisu



PNOZ m B1



PNOZ mm0p



PNOZ m1p ETH



Simple diagnostics

The configurable control systems PNOZmulti provide you with many options for performing diagnostics: for high plant availability and minimal downtimes. Use our PMI operator terminals and the Ethernet TCP/IP and Modbus TCP interfaces for status messages to the connected PLC controller or the higher-level fieldbus. Fieldbus modules which can be replaced without the program needing to be changed are available for the latter. PNOZmulti units can be connected to all common communication networks.



All your automation at a glance!

Your automation projects can be managed using the web-based visualization software PASvisu for simple configuration and optimum visualization. This provides you with a convenient, comprehensive overview of your plant – locally and via remote access; with sophisticated visualization thanks to the most diverse style sheets.

Your benefits at a glance

- ▶ Simple, intuitive handling and maximum suitability for use
- ▶ Fast, safe automation
- ▶ Future-proof and platform-independent
- ▶ Use of current web technologies: HTML5, CSS3 and JavaScript
- ▶ Accelerated projects: from engineering and runtime to maintenance
 - Linking between PAS4000 and PASvisu projects enables shorter project times
 - Faster engineering, as variables do not need to be entered and assigned manually
- ▶ Platform independence thanks to the use of web technology enables flexible application on a wide range of end devices
- ▶ Reduced downtimes thanks to remote access with true client/server functionality
- ▶ Uniform look-and-feel thanks to project-wide design templates (CSS3 style sheets)

Keep up-to-date on the web-based visualization software PASvisu:

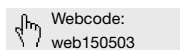

Online information at www.pilz.com

► Configurable control systems PNOZmulti 2 – The



Use the configurable control systems PNOZmulti 2 to implement multiple safety functions on your plant or machinery. The base units are just 45 mm wide, have an illuminated display and are modular and expandable so that they can grow with the requirements and size of your machine. In this way, you only pay for what you actually use.

You create the safety architecture just once, independently of the higher level plant control. This provides benefits in terms of time and cost savings. You can do this with the help of the intuitive PNOZmulti Configurator. The software tool impresses with its wide variety of certified blocks. They allow PNOZmulti to be used irrespective of machine type, plant type, country or branch of industry.



PNOZ m B1

Base unit PNOZ m B1 – for large-scale projects

- Fine granularity of the application – no inputs or outputs on the base unit, number controllable depending on the type of I/O modules used
- 2 integrated Ethernet interfaces
- Modbus TCP on board
- Can be used for large-scale projects
 - up to 1024 connection lines possible in the PNOZmulti Configurator (version 10 or higher)
 - max. 12 safe expansion modules can be connected on the right side as well as one output module for standard applications
 - max. 4 link modules and max. 1 fieldbus module can be connected on the left side
- USB stick as storage medium



PNOZ m B0

Base unit PNOZ m B0 – the universal option

- 20 safe inputs, up to 8 of which can be configured as standard outputs
- 4 safe semiconductor outputs
- 4 test pulse outputs, up to 4 of which can be configured as standard outputs
- Max. 6 expansion modules can be connected on the right side
- Max. 4 link modules and max. 1 fieldbus module and 1 communication module can be connected on the left side
- Up to 80% less energy consumption than comparable products
- Chip card as storage medium

future-proof solution

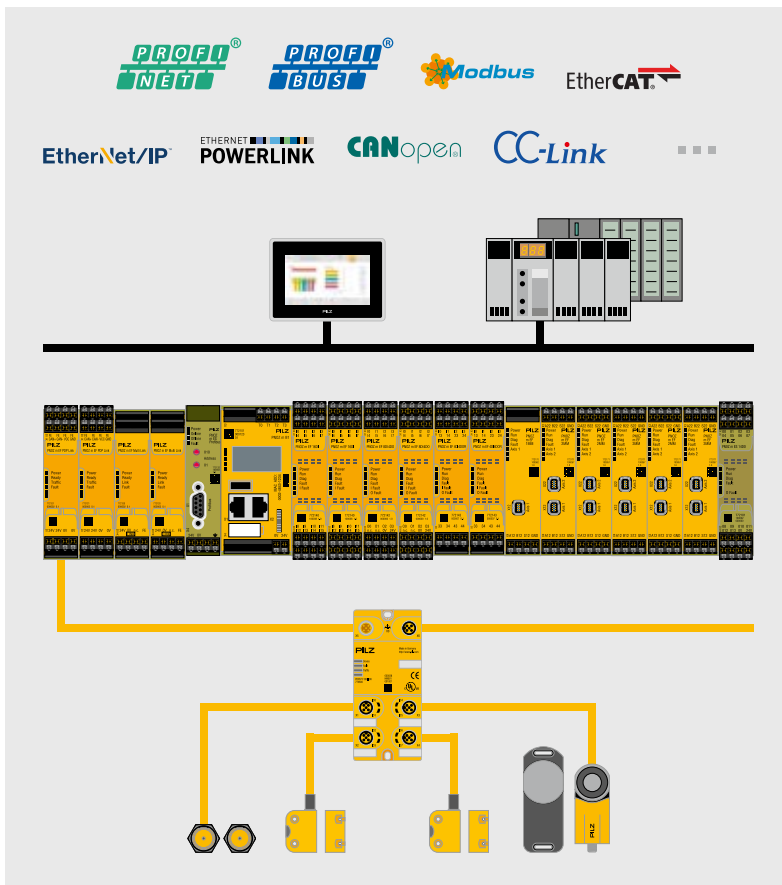

PNOZmulti 2 – for large-scale automation projects in conjunction with the web-based visualization software PASvisu, the operator terminals PMI, safe sensor technology PSEN and decentralized periphery PDP67.

High plant availability and minimal downtimes

The configurable control systems PNOZmulti 2 provide you with many options for performing diagnostics. Use our PMI operator terminals, the Ethernet TCP/IP and Modbus TCP interfaces, the status messages to the connected PLC controller or higher-level fieldbus. Fieldbus modules which can be replaced without the program needing to be changed are available for the latter. PNOZmulti 2 units can be connected to all common communication networks. The diagnostic solution PVIS is easy to install and can be selected in the PNOZmulti Configurator with just a few clicks. Your plant and machinery is visualized optimally using the web-based visualization software PASvisu.



Your benefits at a glance

- ▶ Certified hardware and software for reliable operation
- ▶ Easy to configure thanks to user-friendly software tools
- ▶ Short time-to-market as the inputs and outputs are freely configurable
- ▶ The appropriate modules for every requirement – flexible, simple, economical to expand
- ▶ Comprehensive diagnostic options mean short downtimes
- ▶ Fast commissioning thanks to simple wiring with plug-in terminals
- ▶ Maximum safety – up to PL e and SIL CL 3, depending on the application

Keep up-to-date on configurable control systems PNOZmulti 2:

Webcode:
web150500

Online information at www.pilz.com

► Expansion modules – for particular requirements



SS1



SS2



SSR



SSM



SDI



SOS

Safe motion monitoring modules

The safe motion monitoring modules ensure safe monitoring of your drives. Your plant and machinery are thus even more productive:

- ▶ Safety functions in accordance with EN 61800-5-2 (adjustable speed electrical power drive systems)
- ▶ Safe stop 1: SS1
- ▶ Safe stop 2: SS2
- ▶ Safe speed range: SSR
- ▶ Safe speed monitor: SSM
- ▶ Safe direction: SDI
- ▶ Safe operating stop: SOS
- ▶ Connection to all common incremental encoders via industry-compatible Mini I/O interface

The safe motion monitoring modules are easily parameterized using the software tool PNOZmulti Configurator with certified software blocks. An independent module program (mIQ) is created for this and is executed on the module. This brings considerable benefits for you, the user: For example, fine-grained configuration of several monitoring zones, such as speed or rotational speed, is possible. The module program is run locally on the expansion module. This reduces the load on the base unit.

Flexible and robust

Modules for safe monitoring of one axis or two axes are available. All common incremental encoders can be connected using drive-specific connection cables via the **industry-compatible Mini I/O interface**, characterized by particularly high durability.

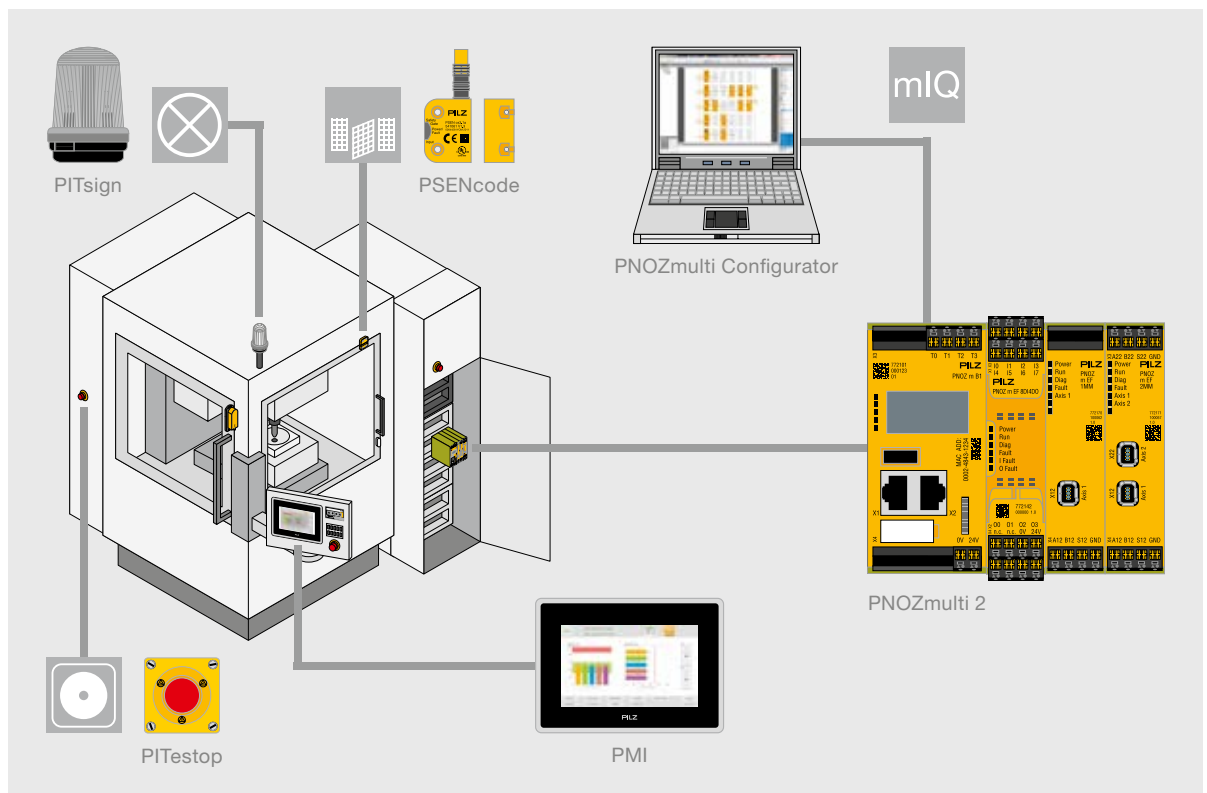

Configurable control systems PNOZmulti 2 with module program (mIQ) for configuring multiple monitoring zones. The module program is run locally on the expansion module.

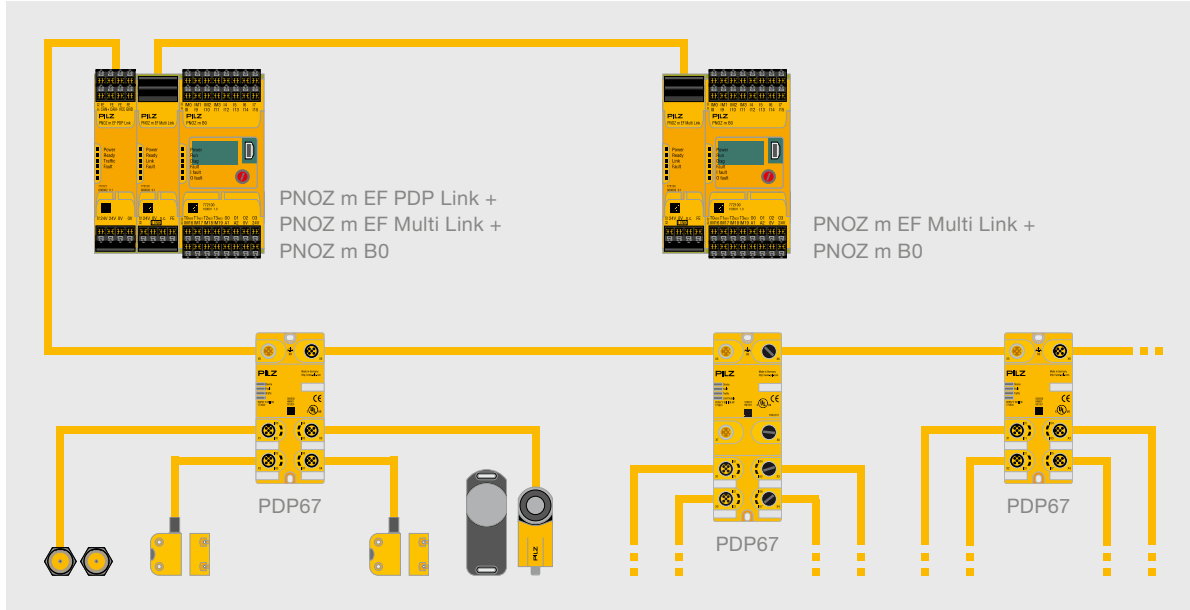

The decentralized modules PDP67 can be connected to the PNOZmulti 2 via a link module – for cost-effective, simple, decentralized expansion. A link module is also available for networking several base units.

PNOZmulti 2 – with decentralized expansion

The configurable control systems PNOZmulti 2 can be expanded using link modules for decentralization and for safe communication between multiple base units. Safety functions on more complex plant and machinery can thus be easily implemented.

Decentrally in the field

The PDP link module serves as the interface for the decentralized modules PDP67 (to protection type IP67) to the base unit. The signals from the connected sensors are directly forwarded to the PDP link module from the field for further processing. With up to 16 PDP67 modules on one base unit, the number of sensors that can be connected increases by 64. This is what an economical solution looks like!

Complex tasks – a team effort

The multi link module enables simple, safe data exchange between several base units. Thanks to the modular structure of the PNOZmulti 2, different topologies can be implemented on one base unit with up to four link modules. As a result, users can connect several PNOZmulti units to implement safety functions for complex plant and machinery.



► Technical details PNOZmulti 2

PNOZmulti 2 – Base units



Common features

- ▶ Efficient in the case of 4 or more safety functions, modular and expandable
- ▶ Application area: for monitoring E-STOP pushbuttons, two-hand buttons, safety gate limit switches, light beam devices, scanners, enabling switches, safety gate switches PSEN, operating mode selector switches, pressure-sensitive mats, safe motion monitoring and many other applications
- ▶ Safety-related characteristic data: depending on the application, up to Performance Level PL e/Cat. 4 of EN ISO 13849-1 and Safety Integrity Level (SIL) CL 3 of IEC 62061
- ▶ Can be configured using the software tool PNOZmulti Configurator
- ▶ Exchangeable program memory
- ▶ Illuminated display for status and device information
- ▶ If the diagnostic solution PVIS is activated, it is possible to display customized texts
- ▶ Visualization software PASvisu: version 1.3 via OPC UA server connection, version 1.4 and higher with direct connection to PNOZmulti
- ▶ Supply voltage: 24 V DC
- ▶ LED status indicators
- ▶ Plug-in connection terminals: either spring-loaded terminals or screw terminals available as obligatory accessories



PNOZ m B1



PNOZ m B0

Type	Features
PNOZ m B1	<ul style="list-style-type: none"> ▶ Automation project is transferred to the base unit using a USB stick (512 MB, included) or via the integrated ETH interface: <ul style="list-style-type: none"> - multiple projects can be stored - only one can be executed - managed via the project manager ▶ Larger programs in the PNOZmulti Configurator only with PNOZ m B1: <ul style="list-style-type: none"> - up to 1024 connection lines possible - macro programming not yet available - module programs supported (mIQ) ▶ Date and time for PNOZ m B1 can be set in the PNOZmulti Configurator
PNOZ m B0	<ul style="list-style-type: none"> ▶ Automation project is transferred to the base unit using a chip card (not included, available as an accessory) or via the integrated USB interface ▶ 20 safe inputs, up to 8 of which can be configured as auxiliary outputs ▶ 4 safe semiconductor outputs – up to PL e and SIL CL 3, depending on the application

	Approvals	Order number		
		Without terminals	Plug-in spring-loaded terminals	Plug-in screw terminals
<ul style="list-style-type: none"> ▶ 4 test pulse outputs for detecting shorts across contacts between the inputs, otherwise no inputs and outputs on the base unit ▶ Right side: max. 12 safe expansion modules, 1 output module for standard applications ▶ Left side: up to 4 safe link modules, max. 1 fieldbus module ▶ Modbus TCP on board ▶ Display with backlighting for diagnostics, for activating the project, Ethernet settings, for setting the date and time of the system, for stopping and starting the device ▶ Multifunction switch for menu control ▶ 2 Ethernet interfaces with switch: transmission rate 10 MBit/s, 100 MBit/s; connector type RJ-45 ▶ Dimensions (H x W x D) in mm: 100 x 45 x 120.2 	CE, cULus Listed, TÜV, BG	772101 RJ-45 cable ▶ 1.5 m _____ 314094	751016	750016
<ul style="list-style-type: none"> ▶ 4 test pulse outputs, up to 4 of which can be configured as standard outputs ▶ Right side: max. 6 safe expansion modules ▶ Left side: max. 4 safe link modules, max. 1 fieldbus module and max. 1 communication module ▶ Display with backlighting to indicate the status of the supply voltage and the inputs and outputs ▶ Rotary knob for menu control ▶ Dimensions (H x W x D) in mm: 101.4/98¹⁾ x 45 x 120 	CE, cULus Listed, EAC (Eurasian), TÜV, BG, CCC	772100 Mini USB cable ▶ 3 m _____ 312992 ▶ 5 m _____ 312993 ▶ Chip card 8 kByte 1 piece ____ 779201 ▶ Chip card 32 kByte 1 piece ____ 779211	751008 (1 set)	750008 (1 set)

¹⁾ Height incl. plug-in spring-loaded terminals/screw terminals

Keep up-to-date on PNOZmulti 2 base units:

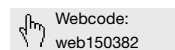

Online information at www.pilz.com

► Technical details PNOZmulti 2

PNOZmulti 2 – Expansion modules



PNOZ m EF 16DI



PNOZ m EF 8DI4DO



PNOZ m EF 4DI4DOR



PNOZ m EF 1MM



PNOZ m EF 2MM



PNOZ m EF Multi Link



PNOZ m EF PDP Link



PNOZ m ES 14DO

Type	Application area
PNOZ m EF 16DI	Safe input module
PNOZ m EF 8DI4DO	Safe input/semiconductor output module
PNOZ m EF 4DI4DOR	Safe input/relay output module
PNOZ m EF 1MM	Safe motion monitoring module for monitoring one axis
PNOZ m EF 2MM	Safe motion monitoring module for monitoring two axes
PNOZ m EF Multi Link	Safe link module for connecting two base units: optionally with PNOZmulti Mini and PNOZmulti; as many base units as necessary can be connected using link modules.
PNOZ m EF PDP Link	Safe link module for connecting a base unit to up to 4 decentralized modules PDP67
PNOZ m ES 14DO	Output module for standard applications
PDP67 F 8DI ION PDP67 F 8DI ION HP	Decentralized input modules

Common features

- Can be configured with the software tool PNOZmulti Configurator
- Status indicators via LEDs

Features	Approvals	Order number		
		Without terminals	Plug-in spring-loaded terminals	Plug-in screw terminals
<ul style="list-style-type: none"> ▶ 16 safe inputs ▶ Monitoring of shorts across contacts by means of test pulse outputs at the inputs ▶ Dimensions (H x W x D) in mm: 101.4 x 22.5 x 120 	CE, cULus Listed, EAC (Eurasian), TÜV, BG, CCC	772 140	751 004 (1 set)	750 004 (1 set)
<ul style="list-style-type: none"> ▶ 8 safe inputs ▶ 4 safe semiconductor outputs, depending on the application up to PL e, SIL CL 3 ▶ Dimensions (H x W x D) in mm: 101.4 x 22.5 x 120 	CE, cULus Listed, EAC (Eurasian), TÜV, BG, CCC	772 142	751 004 (1 set)	750 004 (1 set)
<ul style="list-style-type: none"> ▶ 4 safe inputs ▶ 4 safe relay outputs, depending on the application up to PL e and SIL CL 3 ▶ Dimensions (H x W x D) in mm: 101.4 x 22.5 x 120 	CE, cULus Listed, EAC (Eurasian), TÜV, BG, CCC	772 143	751 004 (1 set)	750 004 (1 set)
<ul style="list-style-type: none"> ▶ Safe monitoring functions in accordance with EN 61800-5-2 (electrical power drive systems with adjustable speed) <ul style="list-style-type: none"> - Stop 1 (SS1) and stop 2 (SS2) - Safe speed monitoring (SSM) - Safe speed range monitoring (SSR-M) - Safe direction monitoring (SDI-M) - Safe operating stop monitoring (SOS-M) - Analog voltage (track S) ▶ Dimensions (H x W x D) in mm: 101.4 x 22.5 x 111 	CE, cULus Listed, EAC (Eurasian), TÜV, BG, CCC	772 170	783 542 (1 set)	793 542 (1 set)
	CE, cULus Listed, EAC (Eurasian), TÜV, BG, CCC	772 171	783 544 (1 set)	793 544 (1 set)
<ul style="list-style-type: none"> ▶ On the left side, max. 4 multi-link modules can be connected to the base unit ▶ Point-to-point connection via 4-core shielded, twisted-pair cable ▶ Transfer of 32 bit input data and 32 bit output data (virtual I/Os) ▶ Dimensions (H x W x D) in mm: 101.4 x 22.5 x 120 	CE, cULus Listed, EAC (Eurasian), TÜV, BG, CCC	772 120	783 538 (1 set)	793 538 (1 set)
<ul style="list-style-type: none"> ▶ Maximum number of devices which can be connected: <ul style="list-style-type: none"> - 4 PDP link modules on the left side of the base unit - 4 decentralized modules PDP67 F 8DI ION (VA) or PDP67 F 8DI ION HP (VA) to 1 PDP link module (maximum configuration: 16 PDP67 modules) - 4 sensors to 1 decentralized PDP67 module (maximum configuration: 64 sensors) ▶ Dimensions (H x W x D) in mm: 101.4 x 22.5 x 120 	CE, cULus Listed, EAC (Eurasian), TÜV, BG, CCC	772 121	783 540 (1 set)	793 540 (1 set)
<ul style="list-style-type: none"> ▶ Expansion module with 14 semiconductor outputs for non-safety-related applications ▶ Max. 1 output module can be connected on the right side of the base unit PNOZ m B1 ▶ Dimensions (H x W x D) in mm: 101.4 x 22.5 x 120 	CE	772 181	751 004 (1 set)	750 004 (1 set)
For further information, please refer to pages 110–111	-	-	-	-

Keep up-to-date on PNOZmulti 2 I/O modules:

 Webcode: web150385

Online information at www.pilz.com

► Technical details PNOZmulti 2

PNOZmulti 2 – Fieldbus modules/communication modules



PNOZ m ES PROFINET



PNOZ m ES PROFIBUS



PNOZ m ES EtherCAT



PNOZ m ES EtherNet/IP

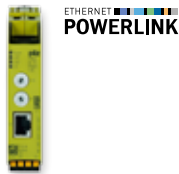

PNOZ m ES POWERLINK



PNOZ m ES CANopen



PNOZ m ES CC-Link



PNOZ m ES ETH



PNOZ m ES RS232

Type	Application area
PNOZ m ES PROFINET	Fieldbus module PROFINET (I/O Device)
PNOZ m ES PROFIBUS	Fieldbus module PROFIBUS-DP (slave, DPV0)
PNOZ m ES EtherCAT	Fieldbus module EtherCAT (slave, CANopen over EtherCAT)
PNOZ m ES EtherNet IP	Fieldbus module EtherNet/IP (adapter)
PNOZ m ES POWERLINK	Fieldbus module Ethernet POWERLINK V2 (slave)
PNOZ m ES CANopen	Fieldbus module CANopen (slave, CiA 301 V 4.2.0)
PNOZ m ES CC-Link	Fieldbus module CC-Link
PNOZ m ES ETH	Communication module with Ethernet/Modbus TCP interface
PNOZ m ES RS232	Communication module with serial interface

Common features

- Can be configured using the PNOZmulti Configurator
- Fieldbus modules: 128 virtual outputs can be defined in the PNOZmulti Configurator for communication with the fieldbus

Features	Approvals	Order number		
		Without terminals	Plug-in spring-loaded terminals	Plug-in screw terminals
<ul style="list-style-type: none"> ▶ Transmission rate 100 MBit/s (100BaseTX), full-duplex and half-duplex ▶ Two RJ-45 ports ▶ PROFINET I/O Device (V2.2) functions in accordance with conformance class C ▶ Supported functions: RT, IRT, MRP, LLDP ▶ Dimensions (H x W x D) in mm: 101.4 x 22.5 x 110.4 	CE, cULus Listed, EAC (Eurasian), CCC	772 138	783 542 (1 set)	793 542 (1 set)
<ul style="list-style-type: none"> ▶ Station addresses from 0 ... 99, selected via rotary switch ▶ Transmission rate: max. 12 MBit/s ▶ Connection to fieldbus via female 9-pin D-Sub connector ▶ Dimensions (H x W x D) in mm: 101.4 x 22.5 x 115 	CE, cULus Listed, EAC (Eurasian), CCC	772 132	783 542 (1 set)	793 542 (1 set)
<ul style="list-style-type: none"> ▶ Transmission rate: 100 MBit/s ▶ Max. 148 bytes TxPDO and 20 bytes RxPDO ▶ Connection to fieldbus via RJ-45 connector ▶ Dimensions (H x W x D) in mm: 101.4 x 22.5 x 115 	CE, cULus Listed, EAC (Eurasian), CCC	772 136	783 542 (1 set)	793 542 (1 set)
<ul style="list-style-type: none"> ▶ Transmission rate: 10 MBit/s, 100 MBit/s ▶ IP address is set at DIP switch on the front of the unit ▶ 2-port switch ▶ Connection to fieldbus via RJ-45 connector ▶ Integrated web server ▶ Dimensions (H x W x D) in mm: 101.4 x 22.5 x 110.4 	CE, cULus Listed, EAC (Eurasian), CCC	772 137	783 542 (1 set)	793 542 (1 set)
<ul style="list-style-type: none"> ▶ Station addresses from 1 ... 239, selected via rotary switch ▶ Transmission rate: 100 MBit/s ▶ Connection to fieldbus via RJ-45 connector ▶ Dimensions (H x W x D) in mm: 101.4 x 22.5 x 110.4 	CE, cULus Listed, EAC (Eurasian), CCC	772 119	783 542 (1 set)	793 542 (1 set)
<ul style="list-style-type: none"> ▶ Station addresses from 0 ... 99, selected via rotary switch ▶ Transmission rate: max. 1 MBit/s ▶ Transmission rate selected via rotary switch ▶ Connection to fieldbus via male 9-pin D-Sub connector ▶ Dimensions (H x W x D) in mm: 101.4 x 22.5 x 115 	CE, cULus Listed, EAC (Eurasian), CCC	772 134	783 542 (1 set)	793 542 (1 set)
<ul style="list-style-type: none"> ▶ Station addresses from 1 ... 63, selected via rotary switch ▶ Station type: remote device ▶ Occupied stations: 3 ▶ Transmission rate: max. 10 MBit/s ▶ Connection to fieldbus: via 5-pin Combicon plug-in connector ▶ Dimensions (H x W x D) in mm: 101.4 x 22.5 x 110.4 	CE, EAC (Eurasian), CCC	772 135	783 542 (1 set)	793 542 (1 set)
<ul style="list-style-type: none"> ▶ With 2 Ethernet interfaces ▶ Transmission rate 10 MBit/s or 100 MBit/s ▶ Connection to fieldbus via RJ-45 connector ▶ Can only be used with base unit PNOZ m B0 ▶ Dimensions (H x W x D) in mm: 101.4 x 22.5 x 111 	CE, cULus Listed, EAC (Eurasian), CCC	772 130	-	-
<ul style="list-style-type: none"> ▶ 1 serial interface RS232 ▶ Can only be used with base unit PNOZ m B0 ▶ Dimensions (H x W x D) in mm: 101.4 x 22.5 x 120 	CE, cULus Listed, EAC (Eurasian), CCC	772 131	783 538 (1 set)	793 538 (1 set)

Configurable small controllers

Keep up-to-date on PNOZmulti 2 communication modules:

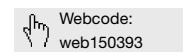

Online information at www.pilz.com

- ▶ Status indicators via LEDs
- ▶ Max. 1 fieldbus module can be connected
- ▶ Only with PNOZ m B0: max. 1 communication module can additionally be connected

► Configurable compact controllers PNOZmulti Mini

You need to monitor more than three safety functions but have limited space? Then PNOZmulti Mini is the right solution for you! You can choose between four base units which can be used as stand-alone devices or modular and expanded. A stand-alone variant is intended for use under hostile industrial conditions with increased environmental requirements. The modular, expandable base units can be linked to each other or connected to decentralized PDP modules. Different communication and fieldbus modules are used for transmitting diagnostic and status information to the higher-level controller. If you need more relay contacts, then use the contact expansion modules from the product group PNOZsigma. You use the compact small controller as a standardized safety solution independently of the operation control system and simply adapt it to changing applications.



PNOZ mm0p

Compact device – stand-alone base unit

With a width of just 45 mm, the stand-alone base unit has 20 freely configurable safe inputs, 4 safe semiconductor outputs (PL e/SIL CL 3) and 4 test pulse outputs. The compact design saves space in the control cabinet. The integrated display offers simple diagnostics and the ability to display customized texts. Short commissioning times and simple wiring save costs. Also available as a version for an extended temperature range.



PNOZ mm0.1p

Genial device – modular, expandable base unit

The base unit PNOZ mm0.1p is ready to meet growing requirements. It has the same technical features as PNOZ mm0p. The difference: it is modular and expandable. By selecting the appropriate modules and thanks to the simple configuration, you can expand your application easily and economically. Expand to the left using safe link and communication modules. On the right-hand side, contact expansion modules from the product group PNOZsigma are available to multiply the relay contacts.

Communicative device – base unit with multi-link inside

In addition to the functionality of the PNOZ mm0.1p, the base unit PNOZ mm0.2p also provides an integrated multi-link interface. This removes the need for an additional module, saving you costs. As a result, it is easy to link and exchange data between several PNOZmulti Mini base units and between PNOZmulti Mini, PNOZmulti and PNOZmulti 2.



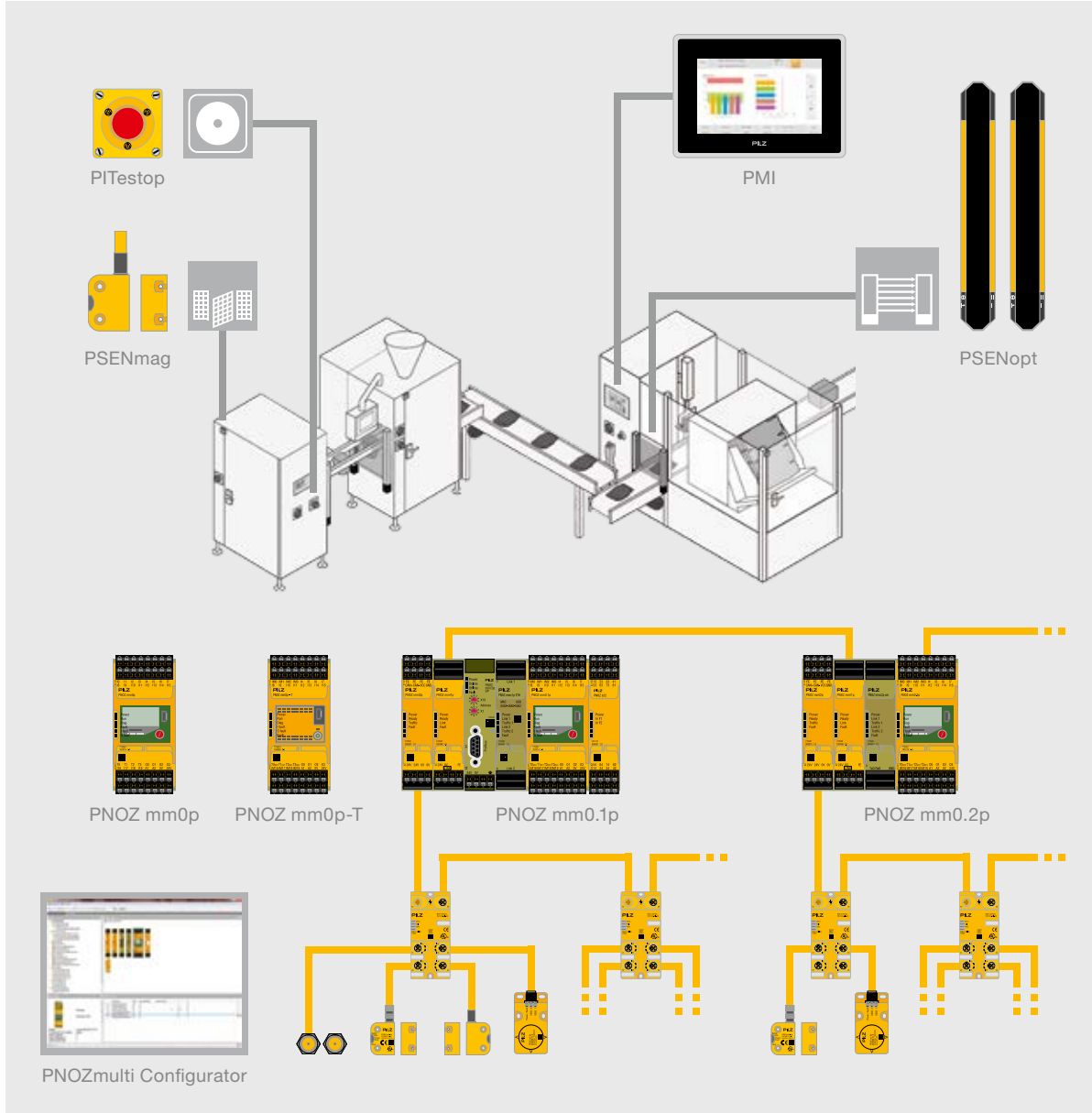

Configurable small controllers

Your benefits at a glance

- ▶ Efficient from three safety functions onwards
- ▶ The software tool PNOZmulti Configurator saves you time and costs in all engineering phases
- ▶ Maximum flexibility: inputs and outputs are freely configurable
- ▶ Saves lots of space in the control cabinet due to the compact design
- ▶ Reduced downtimes thanks to PVIS support
- ▶ Customer texts can be displayed
- ▶ Worldwide safety standard for all machine types

Keep up-to-date on configurable compact controllers PNOZmulti Mini:

 Webcode: web150501

Online information at www.pilz.com

► Technical details – PNOZmulti Mini

PNOZmulti Mini – Base units

Common features:

- Application area: for monitoring E-STOP pushbuttons, two-hand buttons, safety gate limit switches, light beam devices, scanners, enabling switches, safety gate switches PSEN, operating mode selector switches and pressure-sensitive mats
- Safety-related characteristic data: depending on the application, up to Performance Level PL e/Cat. 4 of EN ISO 13849-1 and Safety Integrity Level (SIL) CL 3 of IEC 62061
- Configurable using PNOZmulti Configurator via chip card or USB interface
- Exchangeable program memory: chip card
- 20 inputs, up to 8 of which can be configured as outputs for standard applications
- 4 safe semiconductor outputs, depending on the application up to PL e, SIL CL 3
- 4 test pulse outputs, up to 4 of which can be configured as outputs for standard applications
- Supply voltage (U_B): 24 V DC
- Voltage/current/rating: 24 V DC/2 A/48 W, outputs using semiconductor technology
- With display for error messages, state of the supply voltage, state of the inputs and outputs, status and device information; customized texts can be displayed
- If the diagnostic solution PVIS is activated, it is possible to display customized texts
- Visualization software PASvisu: version 1.3 via OPC UA server connection, version 1.4 and higher with direct connection to PNOZmulti
- Rotary knob for menu control
- Dimensions (H x W x D) in mm: 100/98¹⁾ x 45 x 120



PNOZ mm0p



PNOZ mm0p-T



PNOZ mm0.1p



PNOZ mm0.2p

Type	Application area
PNOZ mm0p	Base unit – non-modular and expandable, from 3 ... 6 safety functions
PNOZ mm0p-T ³⁾	As for PNOZ mm0p for increased environmental requirements, without display
PNOZ mm0.1p	Base unit – modular and expandable, from 4 safety functions and for standard control functions
PNOZ mm0.2p	Base unit – as for PNOZ mm0.1p, with an additional integrated multi-link interface

Features	Approvals	Order number		
		Without terminals	Push-in spring-loaded terminals	Plug-in screw terminals
Accessories ²⁾ for all PNOZmulti Mini base units: <ul style="list-style-type: none"> ▶ Mini USB cable, 3 m: 312992 ▶ Mini USB cable, 5 m: 312993 ▶ Chip card 8 kByte, 1 piece: 779201 ▶ Chip card 32 kByte, 1 piece: 779211 	CE, cULus Listed, EAC (Eurasian), TÜV, BG, CCC, KCC	772000	751008 (1 set)	750008 (1 set)
<ul style="list-style-type: none"> ▶ Ambient temperature in accordance with standard EN 60068-2-14 Temperature range -25 ... + 60 °C ▶ Short-term condensation formation during operation (only with protective extra-low voltage) 	CE, cULus Listed, EAC (Eurasian), TÜV, BG, CCC	772010	751008 (1 set)	750008 (1 set)
<ul style="list-style-type: none"> ▶ As PNOZ mm0p ▶ Expandable to the left using the link modules PNOZ mml1p Multi Link, PNOZ mml2p PDP and a communication module PNOZ mmc1p ETH or PNOZ mmc2p serial; a fieldbus module can be additionally connected ▶ Expandable to the right using a contact expansion module PNOZsigma: PNOZ s22 or s7, s7.1, s7.2, s10, s11 ▶ Decentralization: PDP67 modules for connecting sensor technology ▶ PVIS support 	CE, cULus Listed, EAC (Eurasian), TÜV, BG, CCC, KCC	772001	751008 (1 set)	750008 (1 set)
	CE, cULus Listed, EAC (Eurasian), TÜV, BG, CCC, KCC	772002	751008 (1 set)	750008 (1 set)

¹⁾ Height incl. spring-loaded terminals/plug-in screw terminals

²⁾ For more accessories, see page 108

³⁾  For increased environmental requirements (e.g. extended temperature range, condensation tolerance, resistance against corrosive gases)

Configurable small controllers

Keep up-to-date on PNOZmulti Mini base units:

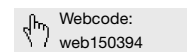

Online information at www.pilz.com

► Technical details – PNOZmulti Mini

PNOZmulti Mini – I/O modules

Common features:

- Can be configured using the PNOZmulti Configurator
- Max. 4 link modules can be connected to the left of the base unit
- 1 PNOZsigma expansion module (+ 1 contact expansion module) can be connected to the right of the base unit



PNOZ mml1p



PNOZ mml2p

Type	Application area
PNOZ mml1p Multi Link	Safe link module for connecting two base units: optionally with PNOZmulti 2 and PNOZmulti; as many base units as necessary can be connected using link modules
PNOZ mml2p PDP	Safe link module for connecting a base unit to up to 4 decentralized modules PDP67
PDP67 F 8DI ION PDP67 F 8DI ION HP	Decentralized input modules
PNOZsigma expansion modules	Contact expansion

Features	Approvals	Order number		
		Without terminals	Push-in spring-loaded terminals	Plug-in screw terminals
<ul style="list-style-type: none"> ▶ Max. 4 PNOZ mml1p units can be connected to the base unit ▶ Point-to-point connection via 4-core shielded, twisted-pair cable ▶ 32 virtual inputs and 32 virtual outputs ▶ Dimensions (H x W x D) in mm: 100 x 22.5 x 120 	CE, cULus Listed, EAC (Eurasian), TÜV, BG, CCC	772 020	783 538 (1 set)	793 538 (1 set)
<ul style="list-style-type: none"> ▶ Maximum number of devices which can be connected: <ul style="list-style-type: none"> - 4 PNOZ mml2p units on the left side of the base unit - 4 decentralized modules PDP67 F 8DI ION (VA) or PDP67 F 8DI ION HP (VA) to 1 PDP link module (maximum configuration: 16 PDP67 modules) - 4 sensors to 1 decentralized PDP67 module (maximum configuration: 64 sensors) ▶ Dimensions (H x W x D) in mm: 98/100¹⁾ x 22.5 x 120 	CE, cULus Listed, EAC (Eurasian), TÜV, BG, CCC	772 021	783 540 (1 set)	793 540 (1 set)
For further information, please refer to pages 110–111	-	-	-	-
For further information, please refer to pages 34–35	-	-	-	-

¹⁾ Height incl. spring-loaded terminals/plug-in screw terminals

Keep up-to-date on PNOZmulti Mini I/O modules:

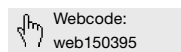

Online information at www.pilz.com

► Technical details – PNOZmulti Mini

PNOZmulti Mini – Fieldbus modules/communication modules



PNOZ mmc1p ETH



PNOZ mmc2p seriell



PNOZ mmc3p DP



PNOZ mmc4p DN



PNOZ mmc6p CAN



PNOZ mmc7p CC



PNOZ mmc11p CAT

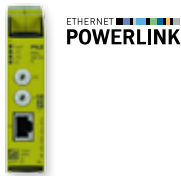

PNOZ mmc12p POWERLINK

Type	Application area
PNOZ mmc1p ETH	Communication module, subscriber on Ethernet TCP/IP and Modbus TCP (slave)
PNOZ mmc2p serial	Communication module with serial interface RS232
PNOZ mmc3p DP	Fieldbus module PROFIBUS-DP (Slave DPVO)
PNOZ mmc4p DN	Fieldbus module DeviceNet (slave)
PNOZ mmc6p CAN	Fieldbus module CANopen (slave)
PNOZ mmc7p CC	Fieldbus module CC-Link (slave V 1.10)
PNOZ mmc11p CAT	Fieldbus module EtherCAT CANopen over EtherCAT (conforms to DS301 V 4.02, slave)
PNOZ mmc12p PL	Fieldbus module POWERLINK (Ethernet POWERLINK V 2 protocol)

Common features:

- Can be configured using the PNOZmulti Configurator
- In the PNOZmulti Configurator, 24 virtual inputs and outputs can be defined for communication with the fieldbus; the number of inputs and outputs can be expanded to 128.
- Max. 1 fieldbus module and max. 1 communication module can be connected to the left of the base unit

Features	Approvals	Order number		
		Without terminals	Push-in spring-loaded terminals	Plug-in screw terminals
<ul style="list-style-type: none"> ▶ 2 Ethernet interfaces ▶ Transmission rate 10 MBit/s ▶ Status indicators via LEDs ▶ Max. 1 communication module can be connected to the left of the base unit; a fieldbus module can also be connected ▶ Connected to base unit via a link on the back of the unit ▶ Dimensions (H x W x D) in mm: 100 x 22.5 x 120 	CE, cULus Listed, EAC (Eurasian), CCC, KCC	772030	-	-
<ul style="list-style-type: none"> ▶ 1 serial interface RS232 ▶ Status indicators via LEDs ▶ Max. 1 communication module can be connected to the left of the base unit; a fieldbus module can also be connected ▶ Connected to base unit via a link on the back of the unit ▶ Dimensions (H x W x D) in mm: 100 x 22.5 x 120 	CE, cULus Listed, EAC (Eurasian), CCC, KCC	772031	783 538 (1 set)	793 538 (1 set)
<ul style="list-style-type: none"> ▶ Station addresses from 0 ... 99, selected via rotary switch ▶ Transmission rate: max. 12 MBit/s ▶ Connection to fieldbus via female 9-pin D-Sub connector ▶ Dimensions (H x W x D) in mm: 100 x 22.5 x 115 	CE, cULus Listed, EAC (Eurasian), CCC	772032	783 542 (1 set)	793 542 (1 set)
<ul style="list-style-type: none"> ▶ Station addresses from 0 ... 63, selected via DIP switch ▶ Transmission rate: 500 kBit/s ▶ Connection to fieldbus via 5-pin Combicon plug-in connector ▶ Dimensions (H x W x D) in mm: 100 x 22.5 x 110 	CE, cULus Listed, EAC (Eurasian), CCC	772033	783 542 (1 set)	793 542 (1 set)
<ul style="list-style-type: none"> ▶ Station addresses from 0 ... 99, selected via rotary switch ▶ Transmission rate: max. 1 MBit/s ▶ Transmission rate selected via rotary switch ▶ Connection to fieldbus via female 9-pin D-Sub connector ▶ Dimensions (H x W x D) in mm: 100 x 22.5 x 115 	CE, cULus Listed, EAC (Eurasian), CCC	772034	783 542 (1 set)	793 542 (1 set)
<ul style="list-style-type: none"> ▶ Transmission rate: max. 10 MBit/s ▶ Connection to fieldbus via 5-pin Combicon plug-in connector ▶ Dimensions (H x W x D) in mm: 100 x 22.5 x 110 	CE, cULus Listed, EAC (Eurasian), CCC	772035	783 542 (1 set)	793 542 (1 set)
<ul style="list-style-type: none"> ▶ Transmission rate: max. 100 MBit/s ▶ Connection to fieldbus via RJ-45 connector ▶ Dimensions (H x W x D) in mm: 100 x 22.5 x 115 	CE, cULus Listed, EAC (Eurasian), CCC	772036	783 542 (1 set)	793 542 (1 set)
<ul style="list-style-type: none"> ▶ Station addresses from 1 ... 239, selected via rotary switch ▶ Transmission rate: 100 MBit/s ▶ Connection to fieldbus via RJ-45 connector ▶ Dimensions (H x W x D) in mm: 100 x 22.5 x 110.4 	CE, cULus Listed, EAC (Eurasian), CCC	772019	783 542	793 542

Configurable small controllers

Keep up-to-date on PNOZmulti Mini fieldbus and communication modules:

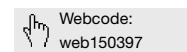

Online information at www.pilz.com

► Configurable safety systems PNOZmulti



The configurable safety system PNOZmulti is ideal when several safety functions are to be implemented on a machine. Instead of wiring, you can simply configure your safety circuit on a PC. PNOZmulti is multifunctional, freely configurable and tailor-made for use in many areas of mechanical engineering.

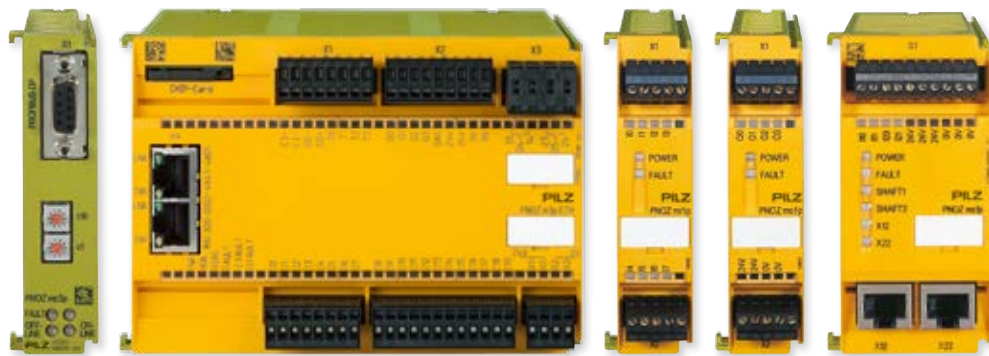

PNOZ m1p ETH

The safety system PNOZmulti monitors safety functions such as E-STOP, safety gates, light beam devices, two-hand controls and many more. All safety functions are created with the software tool PNOZmulti Configurator. Configuration of the hardware with selection of base unit and expansion modules can also be done easily via the PNOZmulti Configurator. This reduces your engineering times and the time-to-market. You can then save the completed configuration on to a chip card. From there it is transferred to the base unit.

The right module for every requirement ...

If your plant expands, the PNOZmulti simply expands with it. Expansion modules are available to extend the modular system; these can be used in any combination to suit the requirement:

- Input and output modules, e.g. the safe analog input module
- Fieldbus modules
- Safe speed and standstill monitors
- Safe link modules for the safe connection of several PNOZmulti base units or for the safe connection of decentralized periphery

All PNOZmulti base units have 20 inputs, 4 safe semiconductor outputs and 2 relay outputs. Versions are available with serial or ETH interface.



PNOZ ma1p

Monitoring analog input signals safely

The safe analog input module PNOZ ma1p provides two independent, safe inputs. For each input, up to eight limit values can be defined in the PNOZmulti Configurator with just a few clicks of the mouse. The inputs are suitable for connecting transducers or encoders with standardized 10 V voltage signals or 20 mA current signals. As users you benefit from rapid commissioning and reduced wiring. With its analog input module, the PNOZmulti is particularly suitable for the process engineering sector as well as for cable car and chair lift design and for burner controls.

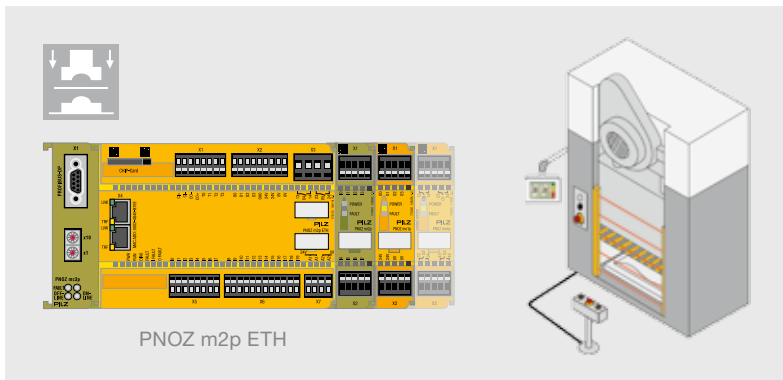

Specifically for press applications.

Use in presses

The base unit PNOZ m2p is specially designed for controlling and monitoring small and medium-sized eccentric and hydraulic presses. Approved software blocks are available for operating modes such as set-up mode, single-stroke mode and automatic mode, and for monitoring safety light curtains in single-break or double-break mode; these blocks make the system simple and economical to use.

In combination with the dual-pole semiconductor output module PNOZ mo3p, the PNOZ m2p can control press safety valves safely and efficiently.

Your benefits at a glance

- ▶ System which provides a solution for safety-related and automation tasks
- ▶ Potential savings of up to 40 % in all engineering phases thanks to a graphical configuration tool
- ▶ Wide variety of base units and modules for flexible, industry-wide use
- ▶ Simple and economical to expand by selecting compatible modules
- ▶ Simple, user-friendly diagnostics mean short downtimes and high plant availability
- ▶ Certified worldwide

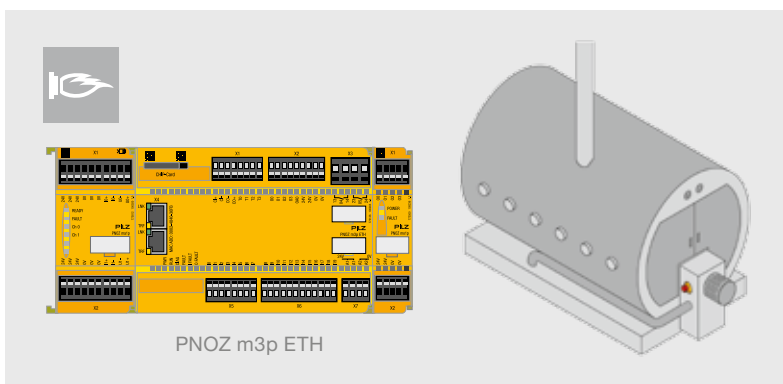

Specifically for burner management.

PNOZmulti in burner management

PNOZ m3p controls and monitors furnaces, e.g. safety sequences. The safe ignition of the fuel and the monitoring of a furnace during operation are safety-related criteria that prevent an explosion with serious damage. The base unit PNOZ m3p provides a safety-related solution that fulfils these requirements.

Keep up-to-date on configurable safety systems PNOZmulti:

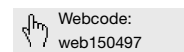

Online information at www.pilz.com

► Technical details – PNOZmulti

PNOZmulti – Base units

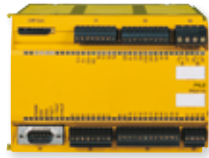

PNOZ m1p

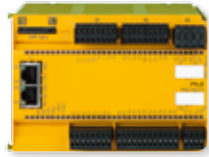

PNOZ m1p ETH

Type	Application area
PNOZ m0p	<ul style="list-style-type: none"> ► Base unit – for 3 ... 6 safety functions ► Only link modules and fieldbus modules can be connected, no other expansion modules can be used
PNOZ m0p ETH	
PNOZ m1p	Base unit – for 4 or more safety functions and for automation functions
PNOZ m1p ETH	
PNOZ m1p coated version ¹⁾	
PNOZ m1p ETH coated version ¹⁾	
PNOZ m2p	Base unit – specifically for press applications: Monitoring of operating modes such as set-up mode, single-stroke mode and automatic mode, safety light curtains in single-break and double-break mode, camshaft controllers with run monitoring, and press safety valves
PNOZ m2p ETH	
PNOZ m3p	Base unit – specifically for burner management: Control and monitoring of furnaces, e.g. monitoring of safety sequences, combustion air pressure, ignition, flame, external compound controller and leaktightness control; plus control of safety valves, ignition valves, exhaust valves, ignition, external compound controller and combustion air blower
PNOZ m3p ETH	

Features	Approvals	Order number		
		Without terminals	Spring-loaded terminals	Plug-in screw terminals
<ul style="list-style-type: none"> ▶ Application area: for connecting E-STOP devices, two-hand buttons, safety gate limit switches, light beam devices, scanners, enabling switches, safety gate switches PSEN, operating mode selector switches, muting, pressure-sensitive mats and sensors ▶ Configurable using the PNOZmulti Configurator via a chip card or the RS232 interface/Ethernet interface ▶ Exchangeable program memory: chip card ▶ Diagnostic interface ▶ Max. 1 fieldbus module can be connected ▶ PNOZ m1p/PNOZ m2p/PNOZ m3p: max. 8 expansion modules can be connected ▶ Inputs/outputs: <ul style="list-style-type: none"> - 20 freely configurable inputs - Positive-guided relay outputs: 2 safety outputs – up to PL e and SIL CL 3, depending on the application - Semiconductor outputs: 4 safety outputs – up to PL e and SIL CL 3, depending on the application; 1 output for standard applications - 4 test pulse outputs - 1 cascading input and output, can also be used as a standard output ▶ Integrated interfaces: <ul style="list-style-type: none"> - PNOZ mxp: serial interface RS232 - PNOZ mxp ETH: 2 Ethernet interfaces ▶ Supply voltage (U_B): 24 VDC ▶ Voltage/current/rating: <ul style="list-style-type: none"> - Outputs using semiconductor technology: 24 VDC/2 A/48 W - Relay outputs: DC1: 24 V/6 A/144 W ▶ Dimensions (H x W x D) in mm: 94 x 135 x 121 <p>Accessories for all PNOZmulti base units:</p> <ul style="list-style-type: none"> ▶ Chip card 8 kByte, 1 piece: 779201 ▶ Chip card 32 kByte, 1 piece: 779211 	CE, cULus Listed, EAC (Eurasian), TÜV, BG, KOSHA, CCC, KCC	773 110	783 100	793 100
	CE, cULus Listed, EAC (Eurasian), TÜV, BG, CCC, KCC	773 113	783 100	793 100
	CE, cULus Listed, EAC (Eurasian), TÜV, BG, KOSHA, CCC, KCC	773 100	783 100	793 100
	CE, cULus Listed, EAC (Eurasian), TÜV, BG, CCC, KCC	773 103	783 100	793 100
	CE, cULus Listed, EAC (Eurasian), TÜV, BG, KOSHA, CCC, KCC	773 105	783 100	793 100
	CE, cULus Listed, EAC (Eurasian), TÜV, BG, CCC	773 104	783 100	793 100
	CE, cULus Listed, EAC (Eurasian), TÜV, BG, KOSHA, CCC, KCC	773 120	783 100	793 100
	CE, cULus Listed, EAC (Eurasian), TÜV, BG, CCC, KCC	773 123	783 100	793 100
	CE, cULus Listed, EAC (Eurasian), TÜV, BG, KOSHA, CCC, KCC	773 125	783 100	793 100
	CE, cULus Listed, EAC (Eurasian), TÜV, BG, CCC, KCC	773 126	783 100	793 100

¹⁾  For increased environmental requirements (e.g. extended temperature range, condensation tolerance, resistance against corrosive gases)

Keep up-to-date on PNOZmulti base units:

 Webcode: web150378

Online information at www.pilz.com

► Technical details – PNOZmulti

PNOZmulti – Input modules



PNOZ mi1p



PNOZ mi2p

Type	Application area	Inputs/outputs
PNOZ mi1p	Safe input module	8 safe inputs
PNOZ mi1p coated version ¹⁾	Safe input module	8 safe inputs
PNOZ mi2p	Input module	8 inputs for non-safety-related functions

PNOZmulti – Safe analog input module



PNOZ ma1p

Type	Application area	Inputs/outputs
PNOZ ma1p	<ul style="list-style-type: none"> ► Safe analog input module ► Exact analog value can be forwarded to a fieldbus for diagnostic purposes 	<ul style="list-style-type: none"> ► 2 safe analog inputs for voltage or current measurement (configurable) ► Each input can be configured separately
PNOZ ma1p coated version ¹⁾		

Features	Approvals	Order number		
		Without terminals	Spring-loaded terminals	Plug-in screw terminals
<ul style="list-style-type: none"> ▶ Max. 8 input modules can be connected to the base unit ▶ Connected to base unit via a link on the back of the unit 	CE, cULus Listed, EAC (Eurasian), TÜV, BG, KOSHA, CCC	773 400	783 400 (1 set)	793 400 (1 set)
		773 405	783 400 (1 set)	793 400 (1 set)
	CE, cULus Listed, EAC (Eurasian), TÜV, BG, KOSHA, CCC	773 410	783 400 (1 set)	793 400 (1 set)

Features	Approvals	Order number		
		Without terminals	Spring-loaded terminals	Plug-in screw terminals
<ul style="list-style-type: none"> ▶ Range monitoring (4 range limits can be configured) ▶ Threshold value monitoring (8 limit values can be configured) ▶ Voltage range: -10.24 ... +10.2375 V ▶ Current range: 0 ... 25.59 mA ▶ Can be connected to the left of the base unit ▶ Max. 4 PNOZ ma1p units can be connected to the base unit ▶ Status indicators ▶ Dimensions (H x W x D) in mm: 94 x 45 x 121 	CE, cULus Listed, EAC (Eurasian), TÜV, BG, CCC	773 812	783 700 (1 set)	793 700 (1 set)
		773 813	783 700 (1 set)	793 700 (1 set)

¹⁾  For increased environmental requirements (e.g. extended temperature range, condensation tolerance, resistance against corrosive gases)

Keep up-to-date on PNOZmulti I/O modules:

 Webcode: web150379

Online information at www.pilz.com

► Technical details – PNOZmulti

PNOZmulti – Output modules



PNOZ mo1p



PNOZ mc1p

Type	Application area	Outputs
PNOZ mo1p	Safe semiconductor output module: switching 24 V actuators	Outputs using semiconductor technology: 4 safety outputs
PNOZ mo1p coated version ¹⁾		
PNOZ mo2p	Safe relay output module: volt-free switching of actuators	Relay outputs: 2 safety outputs
PNOZ mo2p coated version ¹⁾		
PNOZ mo3p	Safe semiconductor output module, 2-pole	2-pole outputs using semiconductor technology: 2 safety outputs
PNOZ mo4p	Safe relay output module: volt-free switching of actuators	Relay outputs: 4 safety outputs
PNOZ mo4p coated version ¹⁾		
PNOZ mo5p	Safe relay output module: to control the safety valves on a burner in accordance with EN 50156	Positive-guided relay outputs, diverse: 4 safety outputs
PNOZ mc1p	Output module: status message to PLC	16 auxiliary outputs using semiconductor technology
PNOZ mc1p coated version ¹⁾		

Common features

- Safety outputs: up to PL e and SIL CL 3, depending on the application (except PNOZ mc1p)
- Connected to base unit via a link on the back of the unit
- Dimensions (H x W x D) in mm: 94 x 22.5 x 121,
PNOZ mc1p: 94 x 45 x 121

Outputs: Voltage/ current/rating	Features	Approvals	Order number		
			Without terminals	Spring- loaded terminals	Plug-in screw terminals
24 VDC/2 A/48 W	▶ Max. 6 output modules can be connected to the right of the base unit	CE, cULus Listed, EAC (Eurasian), TÜV, BG, KOSHA, CCC	773 500	783 400 (1 set)	793 400 (1 set)
			773 505	783 400 (1 set)	793 400 (1 set)
DC1: 24 V/6 A		CE, cULus Listed, EAC (Eurasian), TÜV, BG, KOSHA, CCC	773 520	783 520 (1 set)	793 520 (1 set)
			773 525	783 520 (1 set)	793 520 (1 set)
24 V DC/2 A		CE, cULus Listed, EAC (Eurasian), TÜV, BG, KOSHA, CCC	773 510	783 400 (1 set)	793 400 (1 set)
DC1: 24 V/6 A		CE, cULus Listed, EAC (Eurasian), TÜV, BG, KOSHA, CCC	773 536	783 536 (1 set)	793 536 (1 set)
			773 537	783 536 (1 set)	793 536 (1 set)
DC1: 24 V/6 A/144 W		CE, cULus Listed, EAC (Eurasian), TÜV, BG, CCC	773 534	783 536 (1 set)	793 536 (1 set)
-	▶ Max. 8 output modules can be connected to the right of the base unit	CE, cULus Listed, EAC (Eurasian), TÜV, BG, KOSHA, CCC	773 700	783 700 (1 set)	793 700 (1 set)
			773 705	783 700 (1 set)	793 700 (1 set)

 1) For increased environmental requirements (e.g. extended temperature range, condensation tolerance, resistance against corrosive gases)

Keep up-to-date
on PNOZmulti
I/O modules:

 Webcode:
web150379

Online information
at www.pilz.com

► Technical details – PNOZmulti

PNOZmulti – Safe speed and standstill monitors

Common features

- Application area: The expansion modules monitor drives for standstill, speed and direction of rotation in set-up and automatic mode up to PL e of EN ISO 13849-1 and up to SIL CL 3 of EN IEC 62061
- Monitoring of 2 independent axes (8 limit frequencies can be selected), PNOZ ms4p: 1 axis
- Connection technology on incremental encoder: RJ-45 female connector, 8-pin
- Connection technology on proximity switch: plug-in connection terminals
- Max. 4 speed monitors can be connected to the base unit
- Measured variables: standstill, speed, direction of rotation
- Axis types and start mode can be selected in the PNOZmulti Configurator
- Dimensions (H x W x D) in mm: 94 x 45 x 121



PNOZ ms1p



PNOZ ms4p

Type	Connectable encoders
PNOZ ms1p	Proximity switch, incremental encoder Sin/Cos, TTL (5 V)
PNOZ ms2p	Proximity switch, incremental encoder Sin/Cos, TTL (5 V), HTL (24 V)
PNOZ ms2p HTL	Proximity switch, incremental encoder HTL
PNOZ ms2p TTL	Proximity switch, incremental encoder Sin/Cos, TTL (RS422, 5 V)
PNOZ ms2p TTL coated version ¹⁾	
PNOZ ms3p	Incremental encoder Sin/Cos, TTL (RS422, 5 V), HTL (24 V)
PNOZ ms3p HTL	Incremental encoder (12 V ... 30 V)
PNOZ ms3p TTL	Incremental encoder Sin/Cos, TTL (5 V)
PNOZ ms4p	Incremental encoder Sin/Cos, TTL (5 V), HTL (24 V)

PNOZmulti – Link modules

Common features

- Can be configured using the PNOZmulti Configurator
- Dimensions (H x W x D) in mm: 94 x 22.5 x 121



PNOZ ml1p

Type	Application area
PNOZ ml1p	To safely connect two PNOZmulti base units; tree or ring structure possible
PNOZ ml1p coated version ¹⁾	
PNOZ ml2p	To safely connect a base unit to up to 4 decentralized modules PDP

Features	Approvals	Order number		
		Without terminals	Spring-loaded terminals	Plug-in screw terminals
<ul style="list-style-type: none"> ▶ Connection per axis: 1 incremental encoder or 2 proximity switches or one of each ▶ Encoder types can be selected in the PNOZmulti Configurator ▶ Proximity detectors are connected directly to the terminals 	CE, cULus Listed, EAC (Eurasian), TÜV, BG, KOSHA, CCC	773 800	783 800 (1 set)	793 800 (1 set)
	CE, cULus Listed, EAC (Eurasian), TÜV, BG, KOSHA, CCC	773 810		
<ul style="list-style-type: none"> ▶ Incremental encoder with differential output signals from 12 Vss ... 30 Vss, i.e. now also suitable for HTL encoders ▶ Independent of the supply voltage of the incremental encoder, i.e. also for e.g. encoders with 8 V supply voltage 	CE, cULus Listed, EAC (Eurasian), TÜV, BG, KOSHA, CCC	773 815		
<ul style="list-style-type: none"> ▶ Connection per axis: 1 incremental encoder or 2 proximity switches or 1 incremental encoder and 1 proximity switch 	CE, cULus Listed, EAC (Eurasian), TÜV, BG, KOSHA, CCC	773 816		
		773 811		
<ul style="list-style-type: none"> ▶ Connection per axis: 1 incremental encoder 	CE, cULus Listed, EAC (Eurasian), TÜV, BG, CCC	773 820		
<ul style="list-style-type: none"> ▶ Connection per axis: 1 incremental encoder with differential output signals from 12 Vss ... 30 Vss 	CE, cULus Listed, EAC (Eurasian), TÜV, BG, CCC	773 825		
<ul style="list-style-type: none"> ▶ Connection per axis: 1 incremental encoder from 0.5 Vss ... 5 Vss 	CE, cULus Listed, EAC (Eurasian), TÜV, BG, CCC	773 826		
<ul style="list-style-type: none"> ▶ Monitoring of 1 axis (16 limit frequencies can be selected) ▶ Connection per axis: 1 incremental encoder from 0.5 Vss ... 30 Vss 	CE, cULus Listed, EAC (Eurasian), TÜV, BG, CCC	773 830		

Configurable small controllers

Features	Approvals	Order number		
		Without terminals	Spring-loaded terminals	Plug-in screw terminals
<ul style="list-style-type: none"> ▶ Point-to-point connection via 4-core shielded, twisted-pair cable ▶ Transfer of 32 bit input data and 32 bit output data (virtual I/Os) ▶ Max. 4 PNOZ ml1p units can be connected to the base unit 	CE, cULus Listed, EAC (Eurasian), TÜV, BG, CCC, KCC	773 540	783 400 (1 set)	793 400 (1 set)
		773 545		
<ul style="list-style-type: none"> ▶ Max. 4 PNOZ ml2p units can be connected to the base unit ▶ Max. 4 decentralized modules PDP67 F 8DI ION can be connected to the link module PNOZ ml2p 	CE, cULus Listed, EAC (Eurasian), TÜV, BG, CCC, KCC	773 602		

Keep up-to-date on PNOZmulti I/O modules:

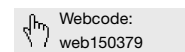

Online information at www.pilz.com

¹⁾ For increased environmental requirements (e.g. extended temperature range, condensation tolerance, resistance against corrosive gases)

► Technical details – PNOZmulti

PNOZmulti – Communication modules/fieldbus modules



PNOZ mc2.1p



PNOZ mc3p



PNOZ mc4p

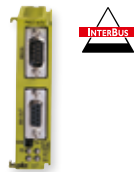

PNOZ mc5p



PNOZ mc5.1p



PNOZ mc6p

Type	Application area
PNOZ mc2.1p	Fieldbus module EtherCAT subscriber (slave), supports CANopen over EtherCAT
PNOZ mc3p	Fieldbus module PROFIBUS-DP subscriber (slave)
PNOZ mc4p	Fieldbus module DeviceNet subscriber (slave)
PNOZ mc4p coated version ¹⁾	
PNOZ mc5p	Fieldbus module Interbus subscriber (slave)
PNOZ mc5.1p	Fieldbus module Interbus fiber-optic cable (FO) subscriber (slave)
PNOZ mc0p power supply	Power supply for Interbus fieldbus modules PNOZ mc5p/PNOZ mc5.1p
PNOZ mc6p	Fieldbus modules CANopen subscriber (slave)
PNOZ mc6p coated version ¹⁾	
PNOZ mc6.1p	

Common features

- Can be configured using the PNOZmulti Configurator
- Data can be used for visualization/diagnostics or for control
- Status indicators via LEDs
- Max. 1 fieldbus module can be connected to the base unit
- Connection to the base unit using jumpers on the back of the unit

Dimensions (H x W x D) in mm	Features	Approvals	Order number
94 x 22.5 x 114	<ul style="list-style-type: none"> ▶ Transmission rate: max. 100 MBit/s ▶ Connection to fieldbus via RJ-45 connector 	CE, cULus Listed, EAC (Eurasian), CCC	773 713
94 x 22.5 x 119	<ul style="list-style-type: none"> ▶ Station addresses from 0 ... 99, selected via rotary switch ▶ Transmission rate: max. 12 MBit/s ▶ Connection: 9-pin D-Sub female connector 	CE, cULus Listed, EAC (Eurasian), TÜV, KOSHA, CCC, KCC	773 732
94 x 22.5 x 122	<ul style="list-style-type: none"> ▶ Station addresses from 0 ... 63, selected via DIP switch ▶ Transmission rate: 125, 250, 500 kBit/s ▶ Connection to fieldbus via 5-pin Combicon plug-in connector 	CE, cULus Listed, EAC (Eurasian), TÜV, KOSHA, CCC, KCC	773 711
			773 729
94 x 22.5 x 119	<ul style="list-style-type: none"> ▶ Transmission rate: 500 kBit/s, 2 MBit/s, selected via jumper ▶ Connection to IBS IN via 9-pin D-Sub male connector, to IBS OUT via 9-pin D-Sub female connector 	CE, cULus Listed, EAC (Eurasian), TÜV, KOSHA, CCC, KCC	773 723
94 x 22.5 x 121	<ul style="list-style-type: none"> ▶ Transmission rate: 500 kBit/s, 2 MBit/s, selected via jumper ▶ Status indicators for communication with Interbus and for errors ▶ Connection to fieldbus via F-SMA connector 	CE, cULus Listed, EAC (Eurasian), TÜV, KOSHA, CCC, KCC	773 728
94 x 22.5 x 121	<ul style="list-style-type: none"> ▶ Interface for connecting the base unit and a fieldbus module ▶ Galvanic isolation ▶ Status indicators ▶ Plug-in terminals (either with spring-loaded terminals or screw connection) 	CE, cULus Listed, EAC (Eurasian), CCC	<ul style="list-style-type: none"> ▶ PNOZ mc0p power supply _____ 773 720 ▶ Spring-loaded terminals (1 set) _____ 783 400 ▶ Plug-in screw terminals (1 set) _____ 793 400
94 x 22.5 x 119	<ul style="list-style-type: none"> ▶ Station addresses from 0 ... 99, selected via rotary switch ▶ Transmission rate: max. 1 MBit/s, selected via rotary switch ▶ Supported protocols: <ul style="list-style-type: none"> - PNOZ mc6p: CiA DS-301 V3.0 - PNOZ mc6.1p: CiA DS-301 V4.0.2 ▶ Connection to fieldbus via male 9-pin D-Sub connector 	CE, cULus Listed, EAC (Eurasian), TÜV, KOSHA, CCC, KCC	773 712
			773 727
		CE, cULus Listed, EAC (Eurasian), CCC	773 733

¹⁾  For increased environmental requirements (e.g. extended temperature range, condensation tolerance, resistance against corrosive gases)

Keep up-to-date on PNOZmulti communication modules:

 Webcode: web150380

Online information at www.pilz.com

► Technical details – PNOZmulti

PNOZmulti – Communication modules/fieldbus modules



PNOZ mc7p



PNOZ mc8p

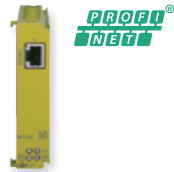

PNOZ mc9p



PNOZ mc10p

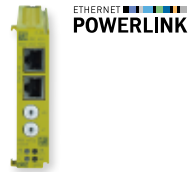

PNOZ mc12p

Type	Application area
PNOZ mc7p	Fieldbus module CC-Link subscriber (slave)
PNOZ mc7p coated version ¹⁾	
PNOZ mc8p	Fieldbus module subscriber on EtherNet IP/ Modbus TCP (slave)
PNOZ mc8p coated version ¹⁾	
PNOZ mc9p	Fieldbus module subscriber on PROFINET
PNOZ mc10p	Fieldbus module Sercos III subscriber (Slave)
PNOZ mc12p	Fieldbus module POWERLINK (Ethernet POWERLINK V 2 protocol), controlled node

Common features

- ▶ Can be configured using the PNOZmulti Configurator
- ▶ Data can be used for visualization/diagnostics or for control
- ▶ Status indicators via LEDs
- ▶ Max. 1 fieldbus module can be connected to the base unit
- ▶ Connection to the base unit using jumpers on the back of the unit

Dimensions (H x W x D) in mm	Features	Approvals	Order number
94 x 22.5 x 122	<ul style="list-style-type: none"> ▶ Station addresses from 0 ... 63, selected via rotary switch ▶ Occupied stations: 2 ▶ Transmission rate: max. 10 MBit/s, selected via rotary switch ▶ Connection: 5-pin Combicon plug-in connector 	CE, cULus Listed, EAC (Eurasian), TÜV, KOSHA, CCC, KCC	773 726
		CE, cULus Listed, EAC (Eurasian), TÜV, KOSHA, CCC	773 725
94 x 22.5 x 114	<ul style="list-style-type: none"> ▶ Transmission rate: max. 10 MBit/s ▶ IP address is set using DIP switches on the front of the unit ▶ Connection to fieldbus via RJ-45 connector 	CE, cULus Listed, EAC (Eurasian), TÜV, KOSHA, CCC, KCC	773 730
		CE, cULus Listed, EAC (Eurasian), TÜV, KOSHA, CCC	773 734
94 x 22.5 x 114	<ul style="list-style-type: none"> ▶ Device name can be configured in the PNOZmulti Configurator ▶ Diagnostics and alarm function are not supported ▶ Transmission rate: 100 MBit/s ▶ Connection to fieldbus via RJ-45 connector 	CE, cULus Listed, EAC (Eurasian), TÜV, KOSHA, CCC, KCC	773 731
94 x 22.5 x 114	<ul style="list-style-type: none"> ▶ Transmission rate: max. 100 MBit/s ▶ Connection to fieldbus via RJ-45 connector 	CE, cULus Listed, EAC (Eurasian), CCC	773 715
94 x 22.5 x 114	<ul style="list-style-type: none"> ▶ Station addresses from 1 ... 239, selected via rotary switch ▶ Transmission rates 100 MBit/s ▶ Connection to fieldbus via RJ-45 connector 	CE, cULus Listed, EAC (Eurasian), CCC	773 719

¹⁾  For increased environmental requirements (e.g. extended temperature range, condensation tolerance, resistance against corrosive gases)

Keep up-to-date on PNOZmulti communication modules:

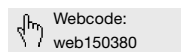

Online information at www.pilz.com

► Software tools for small controllers

Software tool – PNOZmulti Configurator



Type	Features
PNOZmulti Configurator	<ul style="list-style-type: none"> ▶ Graphical tool for configuring and programming the configurable small controllers PNOZmulti ▶ Project development, configuration generation, documentation and commissioning ▶ Data transmission varies depending on the used base unit: via serial interface, USB interface, ETH interface, chip card or USB stick ▶ User interface in German, English, French, Italian, Spanish, Japanese and Chinese (selectable) ▶ System requirements (version 10.0.0 or higher): <ul style="list-style-type: none"> - Operating system: Windows Server 2008/Vista - Standard-PC with min. 1 GHz processor - RAM: min. 1024 MB - Hard drive: 20 GB; min. 15 GB free memory space - Graphics card: supports Super VGA graphics - Browser: Internet Explorer version 9 or higher ▶ To be able to fully utilise the PNOZmulti Configurator, you will need a valid licence in addition to the software package because without a licence the PNOZmulti Configurator will only run in the demo version; various licences are available ▶ Each licence type is available as a full version or service version <ul style="list-style-type: none"> - Full version: The full version provides the whole functional range of a licence - Service version: The service version of a licence is intended for service and maintenance; it provides only limited editing options

Software tool – Diagnostic solution PVIS



Type	Features
PVIS	Diagnostic configurations can be created for all PVIS-capable control systems. This is done using the respective system software of the controller, e.g. using the PNOZmulti Configurator. The diagnostic configuration contains event notifications which can be displayed e.g. if errors occur in or at the control system, if the operating status of the control system changes or in the case of defined conditions.
PVIS OPC Server UA/ OPC Server	The OPC Server "PVIS OPC Server UA" from Pilz is used for displaying the event notifications in visualization software. The OPC Server is installed on a PC or a PMI operator terminal.
PVIS OPC Configurator	The PVIS OPC Configurator is used to create an OPC project which contains the diagnostic configurations and the OPC data for the individual control systems. The OPC Server connects to the control systems, reads in the data and makes it available in the namespace. In the namespace, not only the event notifications can be viewed but also status information and the process data of the control systems.
ActiveX Control UA/ ActiveX Control	In order to retrieve the event notifications of a control system from the OPC Server and to display them in visualization software, ActiveX control can use "PVIS ActiveX Control UA".

Licence type	Order number		
	Type	Full version	Service version
<ul style="list-style-type: none"> ▶ Basic Licence: Single user licence, issued to one owner (company name and location/project must be stated) ▶ User Licence: Discounted licence for an additional workstation, issued to the owner of a basic licence ▶ Lite Licence: Licence limited to the base units PNOZ mOp and the base units PNOZmulti Mini, for use on one workstation ▶ Multi User Licence: Multi-user licence, graduated according to the number of workstations (up to 25, 50, 100 and over 100) ▶ Project Licence: Licence to use the software within a contractually limited framework ▶ Basic/User/Multi User/Project Upgrade Licence: Discounted licence to allow existing licence owners to upgrade to a newer version of the software ▶ Time Limited Licence: Basic licence limited to 2, 3 or 4 months 	Software can be downloaded from the Internet		
	▶ Basic Licence	773 010B	773 011B
	▶ User Licence	773 010K	773 011K
	▶ Lite Licence	773 010L	773 011L
	▶ Multi User Licence	773 010M	773 011M
	▶ Project Licence	773 010G	773 011G
	▶ Time Limited Licence, 2 months	773 010S	-
	▶ Time Limited Licence, 3 months	773 010R	-
	▶ Time Limited Licence, 4 months	773 010Q	-
	Upgrade		
	▶ Basic Upgrade Licence	773 010U	773 011U
	▶ User Upgrade Licence	773 010V	773 011V
	▶ Multi User Upgrade Licence	773 010N	773 011N
	▶ Project Upgrade Licence	773 010W	773 011W

Keep up-to-date on the software tool PNOZmulti Configurator:

 Webcode:
web150399

Online information at www.pilz.com

Licence type	Order number		
	Type	Runtime licence	Project licence
<ul style="list-style-type: none"> ▶ Runtime licence: OPC/OPC UA server application which is licensed for a target computer and can be used without time restriction ▶ Project licence: Licence to use the software within a contractually limited framework 	PVIS OPC Server for PMI, point-to-point	261 905	261 905G
	PVIS OPC Server for PMI, 8 devices	261 906	261 906G
	PVIS OPC Server for PC, point-to-point	261 907	261 907G
	PVIS OPC Server for PC, unlimited	261 908	261 908G

Keep up-to-date on the software tool "Diagnostic solution PVIS":

 Webcode:
web150398

Online information at www.pilz.com

► Accessories – PNOZmulti

Accessories – Configurable small controllers PNOZmulti



PNOZmulti Toolkit



Chipcard



PSEN ma adapter

Type	Application area/features	Order number
PNOZmulti Toolkit	The tool kit in transport case contains the accessories required for starting with PNOZ m B0, PNOZmulti Mini and PNOZmulti: Documentation folder with the PNOZmulti Configurator software and manual, chip card reader, chip card set with 10 chip cards incl. chip card adapter for rewriting broken-out chip cards, configuration cable (5 m), mounting bracket.	779 000
USB memory 512 MB	For base unit PNOZ m B1, for follow-up orders only	779 213
Chipcard	Chip card for the base units PNOZ m B0, PNOZmulti Mini, PNOZmulti (obligatory accessories)	<ul style="list-style-type: none"> ▶ 8 kByte, 1 piece ____ 779 201 ▶ 8 kByte, 10 piece ____ 779 200 ▶ 32 kByte, 1 piece ____ 779 211 ▶ 32 kByte, 10 pieces ____ 779 212
Chipcard Holder	Chip card holder	779 240
Chipcard Reader	Chip card reader, PNOZmulti Configurator version 9.6.0 or higher	779 230
PNOZmulti Seal	Adhesive label for chip card, 12 pieces	779 250
SafetyNET p Cable	Connection cable for all link modules of the small controllers PNOZmulti, available by the meter 1 ... 500 m, signal yellow RAL1003	380 000
SafetyNET p connector RJ45s	Plug-in connector	380 400
PSSu A RJ45-CAB 1.5M	Patch cable with RJ-45 connector, light grey	▶ 1.5 m ____ 314 094
PSSu A USB-CAB03	Mini USB cable for the base units PNOZ m B0 and PNOZmulti Mini	<ul style="list-style-type: none"> ▶ 3 m ____ 312 992 ▶ 5 m ____ 312 993
PNOZ mli1p	Cable for safe connection of 2 link modules PNOZ ml1p, preassembled in spring-loaded or screw terminal variant	<ul style="list-style-type: none"> ▶ 5-pin shielded, push-in spring-loaded terminals - 1.5 m ____ 773 896 - 5 m ____ 773 893 - 10 m ____ 773 894 - 50 m ____ 773 895 ▶ Plug-in screw terminals - 1.5 m ____ 773 897 - 5 m ____ 773 890 - 10 m ____ 773 891 - 50 m ____ 773 892
PSEN ma adapter	Adapter for connection to PSENmag safety switches	380 300
PSEN cs adapter	Adapter for connection to PSENcode safety switches	380 301

Accessories – Configurable small controllers PNOZmulti



PNOZ msi1Ap



MM A MINI-IO-CAB

Type	Application area/features	Order number
PNOZ msi1Ap Adapter Si/Ha 25/25	▶ Connection cable for the safe speed and standstill monitors	▶ 2.5 m _____ 773 840
		▶ 5 m _____ 773 844
PNOZ msi1Bp Adapter Si/Ha 25/25	▶ PNOZ ms1p/PNOZ ms2p/PNOZ ms3p, used to connect incremental encoders	▶ 2.5 m _____ 773 841
		▶ 5 m _____ 773 839
PNOZ msi3Ap Adapter Si/Ha 15/15	▶ Connection cable for all common makes of drive	▶ 2.5 m _____ 773 842
PNOZ msi3Bp Adapter Si/Ha 15/15	▶ Connection to drive and incremental encoder via 25-pin or 15-pin D-Sub male and female connector, or wired with stranded cable	▶ 2.5 m _____ 773 843
PNOZ msi5p Adapter Bos/Rex 15/15	▶ For more information, please refer to the operating instructions	▶ 2.5 m _____ 773 857
		▶ 1.5 m _____ 773 858
PNOZ msi6p Adapter Elau 9/9		▶ 7.5 m _____ 773 859
		▶ 2.5 m _____ 773 860
		▶ 1.5 m _____ 773 861
PNOZ msi7p Adapter SEW 15/15		▶ 2.5 m _____ 773 864 ▶ 1.5 m _____ 773 865
PNOZ msi8p Adapter Lenze 9/9		▶ 2.5 m _____ 773 862 ▶ 1.5 m _____ 773 863
PNOZ msi9p adapter cable		▶ 5.0 m _____ 773 856
		▶ 2.5 m _____ 773 854
		▶ 1.5 m _____ 773 855
PNOZ msi19p ADAPTER ELAU PACDrive3		▶ 2.5 m _____ 773 847
		▶ 1.5 m _____ 773 846
PNOZ msi b1 Box 9p	▶ Adapter box for PNOZ msxp speed monitoring modules PNOZmulti	▶ 9-pin _____ 773 882
PNOZ msi b1 Box 15p	▶ x-pin D-Sub male connector/female connector,	▶ 15-pin _____ 773 880
PNOZ msi b1 Box 25p	2 x female, 1 x male	▶ 25-pin _____ 773 883
PNOZ msi S09	▶ Connector sets/adapters for connecting frequency converters to speed monitors	▶ 9-pin _____ 773 870
PNOZ msi S15	▶ PNOZ msxp, PNOZ s30, PNOZ m EF 1MM/2MM, adapter box PNOZ msi b1 Box	▶ 15-pin _____ 773 871
PNOZ msi S25	▶ Plug-in connector X1/X2: x-pin D-Sub male connector/female connector	▶ 25-pin _____ 773 872
PNOZ msi9p	▶ Connection cable for adapter box PNOZ msi b1 Box	▶ 1.5 m _____ 773 855
PNOZ msi10p	▶ Connection via RJ-45 connector, stranded wire cables with wire end ferrules	▶ 2.5 m _____ 773 854
PNOZ msi11p		▶ 5 m _____ 773 856
PNOZ msi b0 cable 15/RJ45	▶ For adapter box PNOZ msi b1 Box	▶ 15-pin, 0.3 m _____ 773 881
PNOZ msi b0 cable 25/RJ45	▶ x-pin D-Sub male connector/ 8-pin RJ-45 connector	▶ 25-pin, 2.5 m _____ 773 884
MM A MINI-IO-CAB	▶ Adapter cable for PNOZmulti 2, PNOZ m EF 1MM and PNOZ m EF 2MM ▶ Shielded ▶ Preassembled 8-pin Mini IO male connector at one end	▶ 1.5 m _____ 772 200
		▶ 2.5 m _____ 772 201
		▶ 5.0 m _____ 772 202

Configurable small controllers

► Decentralized modules PDP67

With the PDP67 modules you can achieve a high level of decentralization. The digital input module PDP67 F 8DI ION forwards signals from the sensors connected decentrally in the field, to various evaluation devices, e.g. PNOZmulti 2, PNOZmulti Mini and PNOZmulti. Up to 64 sensors can be connected.



PDP67 F 8DI ION

Decentralized and passive – decentralized safety

The passive junction PDP67 F 4 code enables the connection of up to four sensors PSEnlock or PSEnini. In addition to the possibility of connection to the configurable control systems PNOZmulti, PNOZmulti Mini and PNOZmulti 2, the PNOZsigma safety relays are also available.

Versatile automation architectures are possible due to the possibility of connection to various evaluation devices.

PDP67 – economical and safe

Integrated in dirt and water-repellent IP67 housings, the PDP67 modules can also be used where there are high demands on hygiene. The decentralized modules optimize the installation and wiring effort – saving you time, money and space in the control cabinet. PDP67 modules with stainless steel threads satisfy the requirements of the food industry.

Type code for decentralized modules PDP67

PDP67 F 8DI ION HP VA

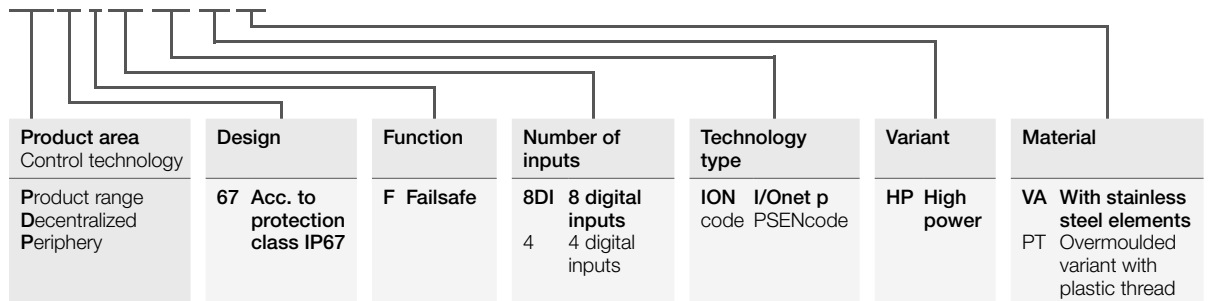

Keep up-to-date
on decentralized
modules PDP67:

Webcode:
web150510

Online information
at www.pilz.com



PDP67 F 8DI ION PT

**New decentralized input module
PDP67 F 8DI ION PT**

Thanks to an improved manufacturing process, the new decentralized input module is a cost-effective alternative to existing solutions on the market. This new addition to the range of Pilz decentralized field devices allows modular machine concepts to be planned and implemented with ease.

Your benefits at a glance

- ▶ Less planning and design work thanks to simple installation
- ▶ Simple implementation of a modular machine concept
- ▶ Saving of space in the control cabinet
- ▶ Integrated in dirt and water-repellent housings
- ▶ Can be used for applications with high demands on hygiene

Technical details – Modules for alternative connection options for sensors



PDP67 F 4 code



PDP67 Connector cs

Type	Features	Safety	Approvals	Order number
PDP67 F 8DI ION	Decentralized input module for PNOZmulti 2, PNOZmulti Mini and PNOZmulti	<ul style="list-style-type: none"> ▶ PL e of EN ISO 13849-1 ▶ SIL CL 3 of EN/IEC 62061 	BG, CE, TÜV, cULus Listed	773 600
PDP67 F 8DI ION VA			BG, CE, TÜV, cULus Listed	773 614
PDP67 F 8DI ION PT			CE, TÜV, ¹⁾	773 616
PDP67 F 8DI ION HP	Decentralized input module for <ul style="list-style-type: none"> ▶ PNOZmulti 2, PNOZmulti Mini and PNOZmulti ▶ High power ▶ Additional supply voltage for PSENslock and PSENopt 		BG, CE, TÜV, cULus Listed	773 601
PDP67 F 8DI ION HP VA			BG, CE, TÜV, cULus Listed	773 615
PDP67 F 4 code	Passive junction PSENcode		CE, cULus Listed	773 603
PDP67 F 4 code VA			CE, cULus Listed	773 613
PDP67 Connector cs	Adapter for connection cable to the evaluation device	-	-	773 610
PDP67 Connector cs VA			-	773 612

¹⁾ Product labelling for the North American market is currently in preparation

► Cable navigator

The cable navigator helps in the creation of your application. It provides a fast, simple overview of which cable and which adapter can be used to connect to the respective evaluation device and on various sensors.

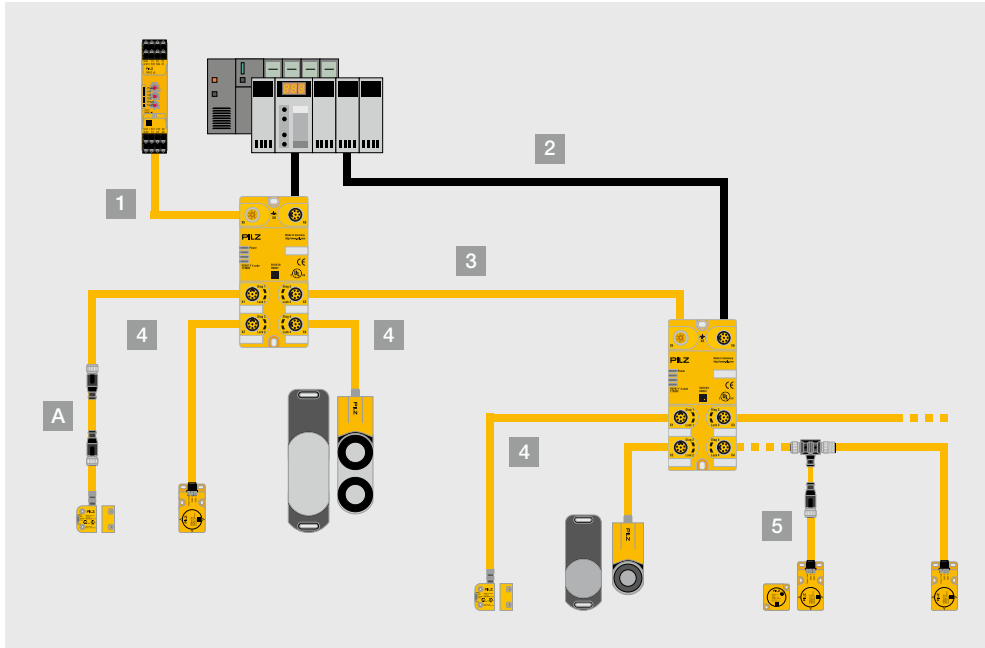

Use of cables for an application with PDP67 F 4 code.

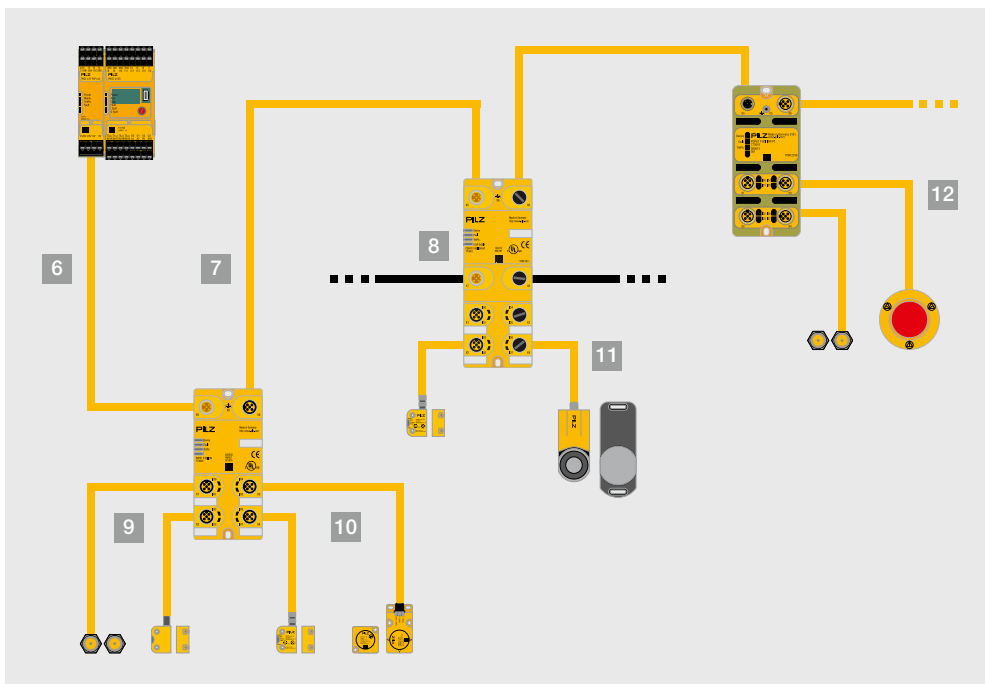

Use of cables for an application with PDP67 F 8DI ION.

Cable navigator

Type

- | | |
|----|--|
| A | Adapter for M8 connection, 8-pin sensors |
| 1 | Connection cable evaluation device – PDP67 (X5) |
| 2 | Connection cable standard evaluation device – PDP67 (X6) |
| 3 | Connection cable PDP67 (X1–X4) – PDP67 (X5) |
| 4 | Connection cable PSENcode, PSENslock, PSENini (X1–X4) |
| 5 | PSEN Y-junction/PSEN T-junction for series connection |
| 6 | Connection cable PNOZ m EF PDP Link/PNOZ ml2p/ PNOZ mml2p – PDP67 (X5) |
| 7 | Connection cable PDP67 (X6) – PDP67 (X5) |
| 8 | Supply cable PDP67 F 8DI ION HP (X7–X8) |
| 9 | Connection cable PSENmag (X1–X4) |
| 10 | Connection cable PSENcode (X1–X4) |
| 11 | Connection cable PSENslock (X1–X4) |
| 12 | Connection cable PIT, sensors without M12 connection (X1–X4) |

Features	Approvals	Order number	Order number					
			2 m	3 m	5 m	10 m	20 m	30 m
PSEnconverter, straight, M8, 8-pin, socket to M12, 8-pin, connector	UL	540 329	-	-	-	-	-	-
PSEncable, straight, M12, 8-pin, open-ended socket	UL	-	-	540 319	540 320	540 321	540 333	540 326
PDP67 cable, straight, M12, 8-pin, open-ended connector	UL	-	380 700	-	380 701	380 702	380 703	380 704
PSEncable, straight, M12, 8-pin, plug/socket	UL	-	540 340	-	540 341	540 342	540 343	540 344
PSEncable, straight, M12, 8-pin, plug/socket	UL	-	540 340	-	540 341	540 342	540 343	540 344
PSEN Y-junction M8-M12/M12, pigtail, series connection with M8, 8-pin	-	540 337	-	-	-	-	-	-
PSEN Y-junction M12-M12/M12, pigtail, series connection with M12, 8-pin	-	540 338	-	-	-	-	-	-
PSEN T-junction, M12, diagnostic connector	-	540 331	-	-	-	-	-	-
PSEN op cable, straight, M12, 5-pin, open-ended socket	UL	-	-	630 310	630 311	630 312	630 298	630 297
PSS67 cable, straight, M12, 5-pin, plug/socket	UL	-	-	380 208	380 209	380 210	380 220	380 211
X7: PSS67 supply cable, straight, M12, 5-pin, open-ended socket, B-coded	UL	-	-	380 256	380 257	380 258	-	-
X7-X8: PSS67 supply cable, straight, M12, 5-pin, plug/socket, B-coded	UL	-	-	380 250	380 251	380 252	-	-
n-type: PSS67 cable, straight, M12, 5-pin, plug/socket	UL	-	-	380 208	380 209	380 210	380 220	380 211
p-type (M8, 4-pin): PSS67 cable, straight, M8, 4-pin, socket, M12, 4-pin, connector	UL	-	-	380 200	380 201	380 202	-	380 203
Adapter for p-type: PSEn mag adapter	-	-	380 300	-	-	-	-	-
n-type: PSS67 cable, straight, M12, 5-pin, plug/socket	UL	-	-	380 208	380 209	380 210	380 220	380 211
p-type (M12, 8-pin): PSS67 cable, straight, M12, 5-pin, plug/socket	UL	-	-	380 208	380 209	380 210	380 220	380 211
Adapter for p-type: PSEN cs adapter	-	-	380 301	-	-	-	-	-
n-type: PSS67 cable, straight, M12, 5-pin, plug/socket	UL	-	-	380 208	380 209	380 210	380 220	380 211
p-type (M12, 8-pin): PSS67 cable, straight, M12, 5-pin, plug/socket	UL	-	-	380 208	380 209	380 210	380 220	380 211
PSEN sl adapter	-	-	380 325	-	-	-	-	-
PDP67 cable, straight, M12, 5-pin, open-ended connector	UL	-	-	380 705	380 709	380 706	380 707	380 708

▶ Controllers and I/O systems

You can use controllers and decentralized I/O systems from Pilz to easily and flexibly implement safety and automation applications of any size: machines with an elementary function range, machines with multiple axes, interlinked plant and machinery. High availability and productivity, as well as maximum safety, are guaranteed for your plant and machinery.

Product range

Controllers and I/O systems

▶ Controllers and I/O systems PSSuniversal	116
▶ Automation system PSS 4000	118
▶ Visualization software PASvisu	122
▶ Visualization terminal PMIvisu	123

Product range

Decentralized I/O system PSSuniversal

▶ Technical details	126
---------------------	-----

Product range

Remote I/O system PSSuniversal 2

▶ Technical details	146
---------------------	-----



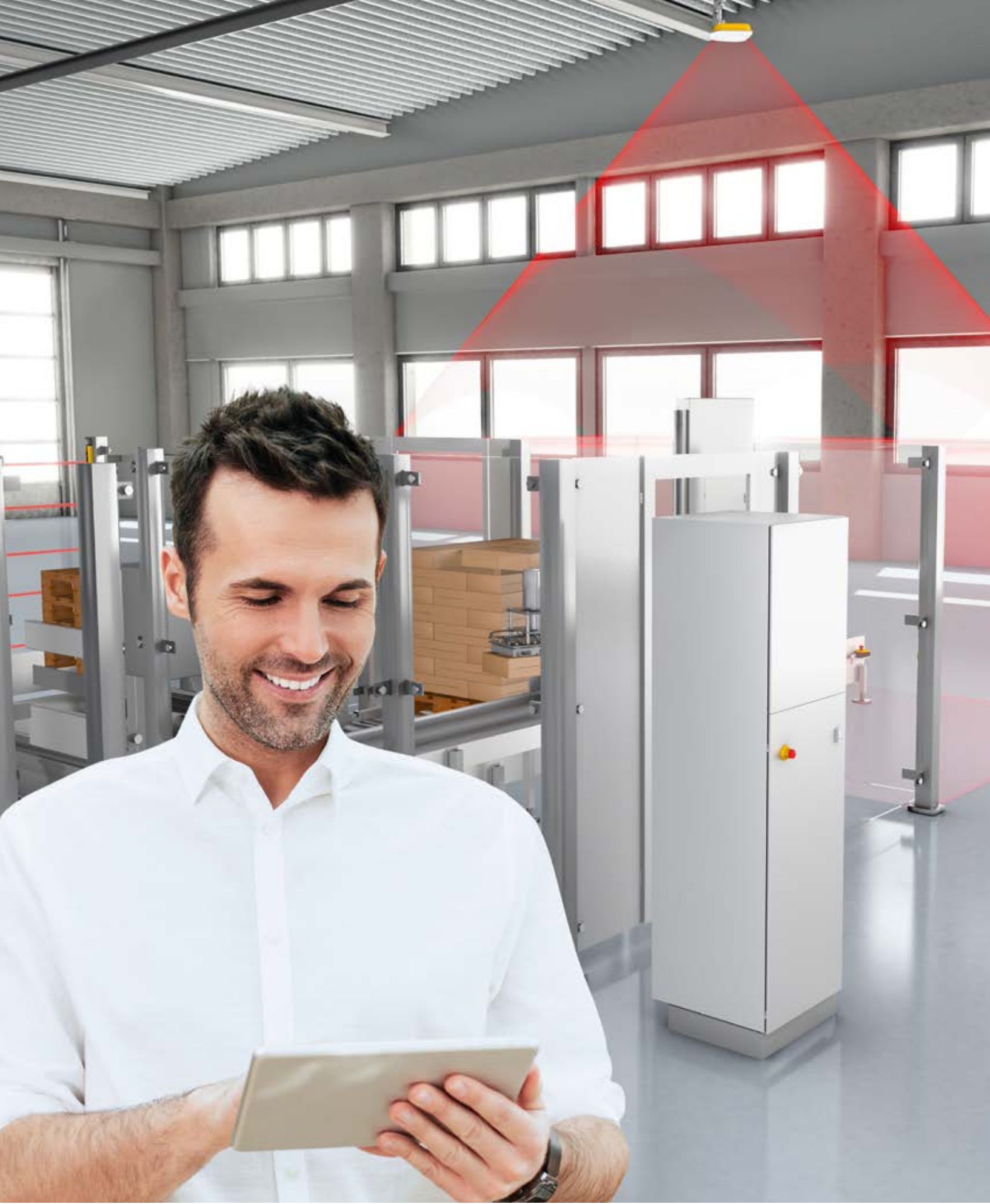

▶ Controllers and I/O systems PSSUniversal

The controllers and I/O systems PSSUniversal from Pilz can be used for the most diverse applications and offer maximum flexibility. Various hardware and software components for safety and automation enable different combinations for implementing your application. Openness and easy handling are key features of our systems.

Overview of product range PSSUniversal

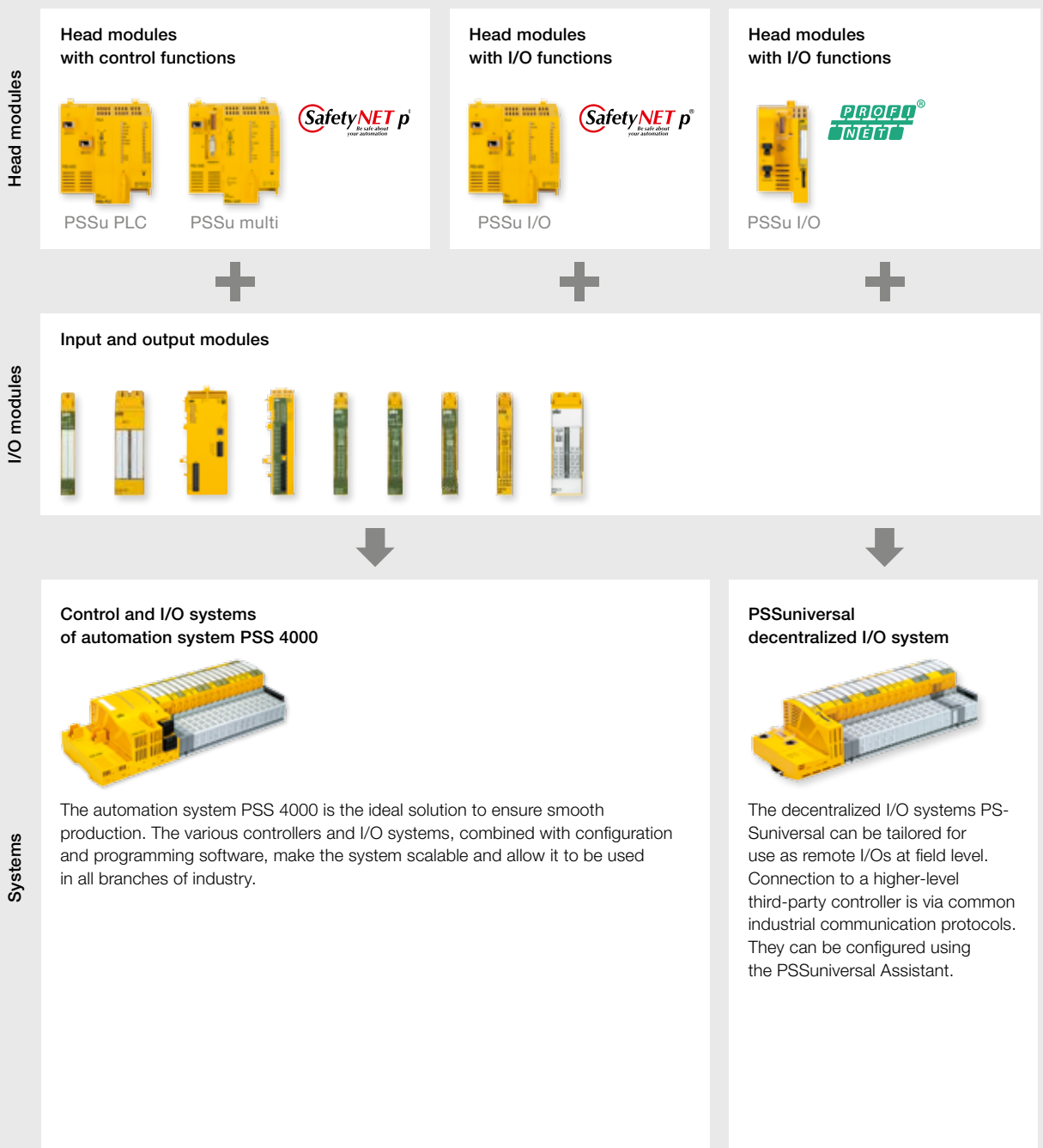

Head modules with I/O functions



PSS u2 I/O



Input and output modules



PSSuniversal 2 remote I/O system

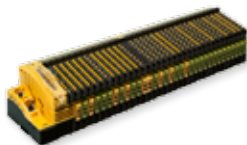

The remote I/O system PSS u2 is the new generation of universal systems. In the first stage the remote I/O system consists of the PROFINET communication module and a selection of I/O modules. Thanks to technical and mechanical improvements users benefit from time and cost savings.

Easy to configure!

PSSuniversal allows you to implement projects for safety and automation. Both worlds merge together intelligently. So that the safety of man and machine is guaranteed at all times, the system fulfils the requirements for absence of feedback and enables extremely short reaction times. This ensures that changes or expansions in the control section have no influence on safety. PSSuniversal therefore complies with EN/IEC 61508 up to SIL 3 and EN ISO 13849 up to PL e. The PSSu I/O decentralized I/O systems are connected to a higher-level controller PSSuniversal PLC or PSSuniversal multi via SafetyNET p.

Your benefits at a glance

- ▶ Processing of safety and automation functions
- ▶ Modular system structure for maximum flexibility
- ▶ Extensive selection of modules to meet your specific requirements
- ▶ Ready for use in a variety of applications
- ▶ Digital and analog value processing
- ▶ Fast installation, fast module change even during operation
- ▶ Greater energy efficiency thanks to intelligent system design
- ▶ Functions comply with the international standards for machine safety
- ▶ Simple handling thanks to easily understandable software



Keep up-to-date on PLC controllers and I/O systems:

Webcode: web150509

Online information at www.pilz.com

► Automation system PSS 4000



Are you looking for a safe and easy way to automate your plant or machinery? The automation system PSS 4000 can be customized according to your specific needs. You can choose from controllers and head modules without control functions as well as a wide range of I/O modules. The appropriate engineering software and a visualization software package complete the system. In combination with network components, you can implement various automation architectures and increase network availability.

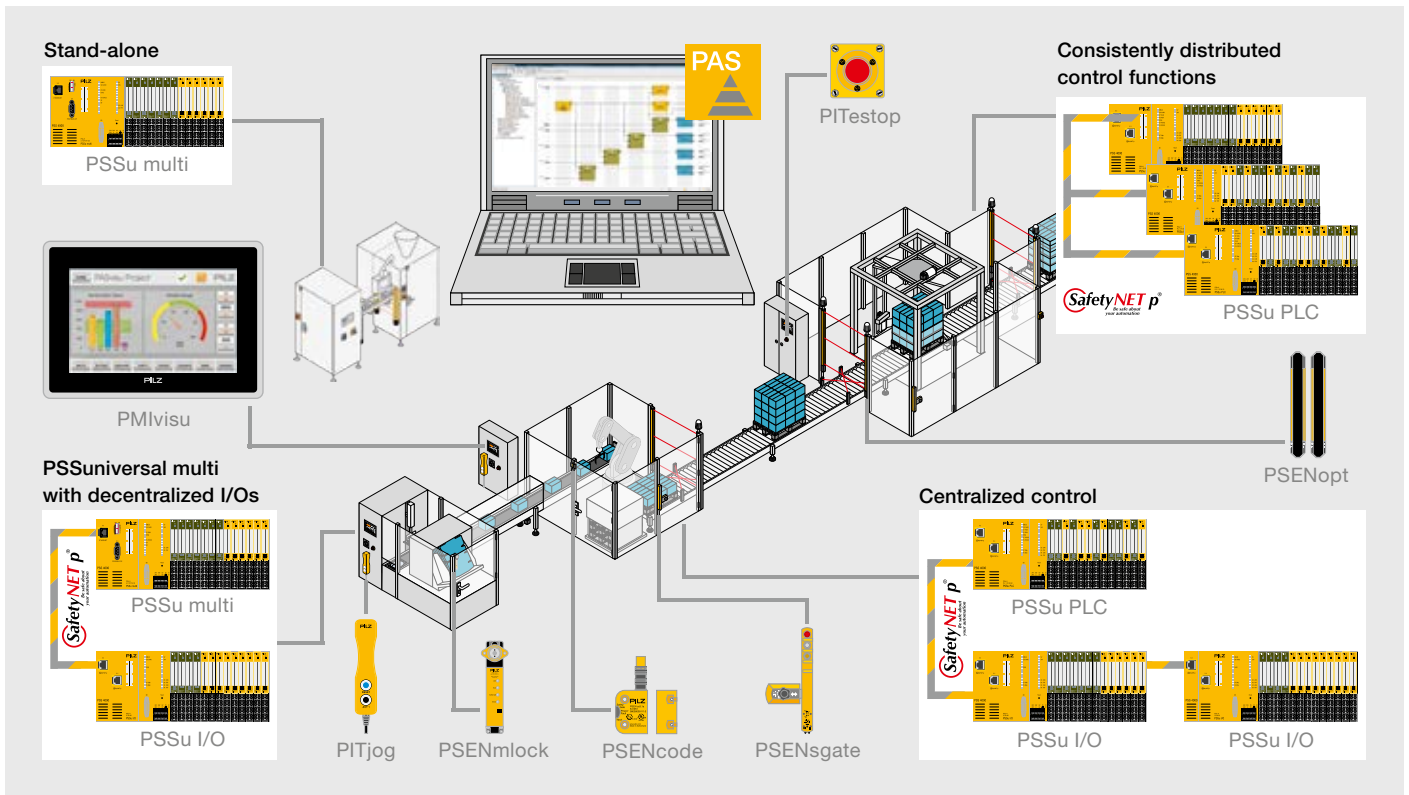

Controllers and I/O systems



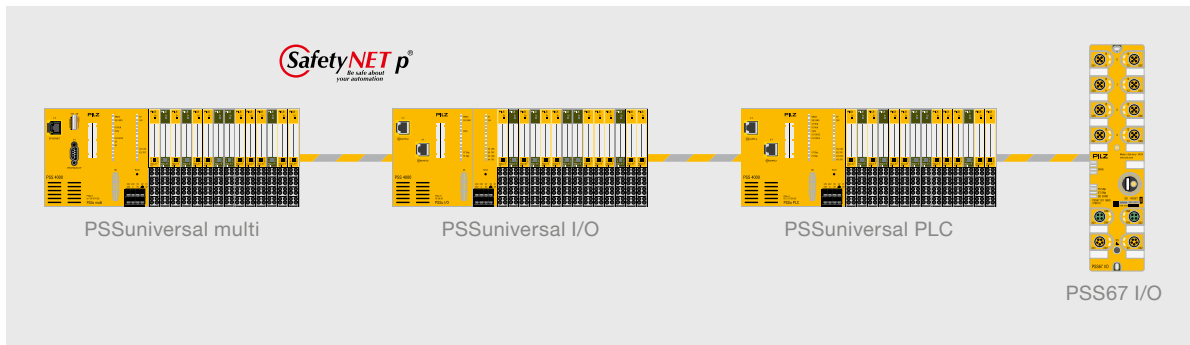

Controllers and I/O systems for every requirement

The controllers PSSuniversal PLC are the all-rounders in the automation system PSS 4000. They can be used as "classic" central PLCs for safety and automation, but can also be used as a distributed system. They can be configured and programmed in the main languages defined in EN/IEC 61131-3.

The controllers PSSuniversal multi can be used as small controllers within the system network – with PSSuniversal PLC and the I/O systems PSSuniversal I/O and PSS67 I/O – or as stand-alone devices. The controllers PSSuniversal multi are suitable for individual machines or small, interlinked plants. They are configured and programmed using the graphics program editor PASmulti.

The modules PSSuniversal I/O and PSS67 I/O are used for decentralized networking and transfer of safety-related and non-safety-related signals at field level. PSSuniversal I/O enables a wide range of applications to be implemented by connecting up to 64 I/O modules. The I/O block PSS67 with its protection type IP67 is ideal for installation without control cabinet!



Real-time Ethernet SafetyNET p – communication in its purest form

In addition to the connection to communication networks such as EtherNet/IP, EtherCAT, Modbus TCP, PROFINET and PROFIBUS-DP, the controllers PSSuniversal PLC also have the communication interface SafetyNET p. SafetyNET p is the backbone of the whole system. Various infrastructure components such as switches allow the network to be adapted to the plant structure. Gateways are also available to connect to various third-party controllers.

Your benefits at a glance

- ▶ One system for the entire automation technology
- ▶ Merging safety and automation
- ▶ Optimum solution for Industrie 4.0
- ▶ Distribution of control functions according to the multi-master principle
- ▶ Easy programming and configuration with the PAS4000 software
- ▶ Web-based visualization with the PASvisu software
- ▶ Safe communication via real-time Ethernet SafetyNET p
- ▶ High level of flexibility thanks to modular system structure
- ▶ Can be used in all branches
- ▶ Special approvals for use for railway, lift/escalator and fire protection applications
- ▶ Can be integrated into existing automation structures

Keep up-to-date on the automation system PSS 4000:

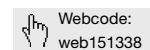

Webcode:
web151338

Online information at www.pilz.com

Software PAS4000 – easy handling of complex functions

With PAS4000 you can create programs for safety and automation quickly and intuitively using just one interface.

You use the graphical program editor PASmulti to configure the controllers PSSuniversal PLC and PSSuniversal multi.

Inputs and outputs can be freely configured in the tool. Combination with the programming languages PAS STL (structured text), PAS LD (ladder diagram) and PAS IL (instruction list) in accordance with EN/IEC 61131-3 is possible.

You can use these languages to program the controllers PSSuniversal PLC. The comprehensive library of safety-related and non-safety-related software blocks make creating automation programs easy.

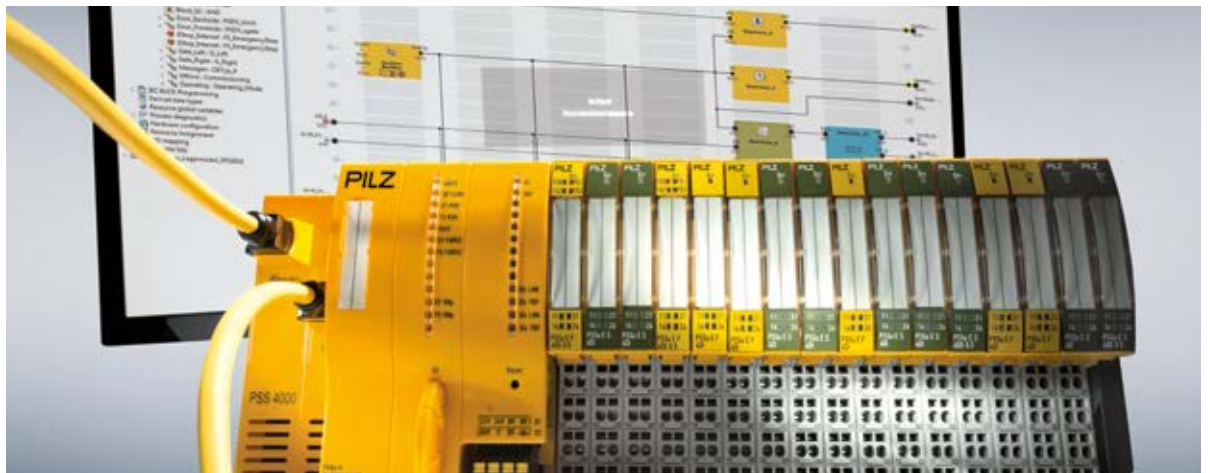

Safe motion monitoring

The I/O module PSSu K F EI with local fast shutdown allows you to implement extended motion monitoring functions with the controllers PSSuniversal PLC and PSSuniversal multi. This makes your plant even more efficient and productive. The compact module monitors safe speed, direction and stop functions. You benefit from reduced reaction times, higher productivity and simpler maintenance and repair of your plants and machinery. Appropriate software blocks can be found in the library of the PAS4000 software.

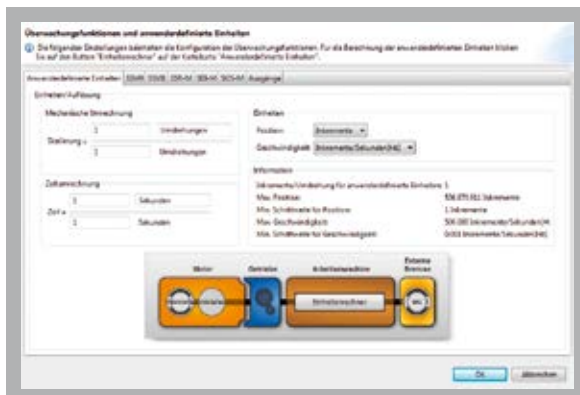

Configuration of PSSu K F EI

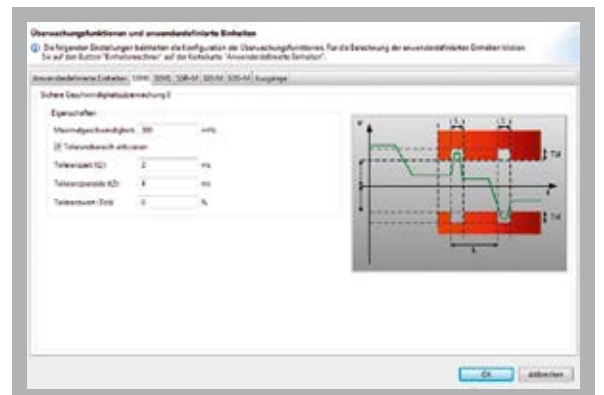

Configuration of SSM0



Automation of the future requires solutions that can distribute control intelligence and are still easy to use. The automation system PSS 4000 makes this possible. Multiple controllers with identical authorization rights are connected simply via the real-time Ethernet SafetyNET p. SafetyNET p exchanges data and state information between the controllers and synchronizes it.

In PAS4000, you program and configure all network subscribers centrally. This simplifies the networking of multiple controllers. The PASvisu web-based visualization software allows you to keep a close eye on the project. That makes handling your project really simple, however large it is! And you can react to customer requests quickly and flexibly at any time!

Solution for Industrie 4.0

- ▶ One system for the entire automation technology
- ▶ Merging safety and automation
- ▶ Solution for Industrie 4.0
- ▶ Distribution of control functions according to the multi-master principle
- ▶ Easy programming and configuration with the PAS4000 software
- ▶ Web-based visualization with the PASvisu software
- ▶ Safe communications via real-time Ethernet SafetyNET p
- ▶ High level of flexibility thanks to modular system structure
- ▶ Can be integrated into existing automation structures
- ▶ Querying and utilization of extensive diagnostic data from safety devices using Safety Device Diagnostics



One system for all automation requirements



Temperature-resistant modules

Rugged environments demand components that will operate reliably where there are high temperature fluctuations. Modules identified by a "-T" in the type designation are used where cabinet heating would be very costly or uneconomical, or where high temperatures prevail. The specified operating temperature range is from $-40\text{ }^{\circ}\text{C}$ to $+70\text{ }^{\circ}\text{C}$. In addition, the modules are protected against condensation in compliance with pollution degree 2. The T-modules are suitable for applications such as wind turbines and cable cars. In many cases, using these modules means there is no need for additional climate control measures, reducing costs considerably.



► Keeping a close eye on the automation system

The PASvisu web-based visualization software allows you to keep a close eye on the automation system PSS 4000: both locally and by remote access. You can link the web-based visualization software PASvisu directly to the control project from the software PAS4000. That automatically gives you full access to all process variables created in the project as well as to the entire namespace of the automation system. This means that information such as the check sum of the project or the firmware version of the controller PSSuniversal PLC can also be called up. In this way, you benefit from shorter project runtimes, faster engineering and reduced potential for error.

Keep up-to-date on the visualization software PASvisu:

Webcode:
web150430

Online information at www.pilz.com



Optimum link: Control project and visualization.

Control diagnostics

The (safety) blocks configured in the controller are shown grouped as predefined tiles in the visualization. In this case the selection is made via the instance name rather than the individual variables. All the safety blocks used in the control project (from the software PAS4000) are automatically available in the PASvisu Builder and can be used directly for graphical block diagnostics. All relevant variables are already linked to these Pilz hardware tiles. The diagnostic list (alarms and remedial measures) and the history can also be shown. In addition, a tile is available with the LED status of the PSS 4000 hardware.

Your benefits at a glance

- Fast, safe automation
- Future-proof and platform-independent
- Accelerated projects: from engineering and runtime to maintenance
- Link between PAS4000 and PASvisu projects enables shorter project times
- Faster engineering, as variables do not need to be entered and assigned manually
- Flexible use on a multitude of end devices – thanks to platform independence
- Language switching: create, export and import languages

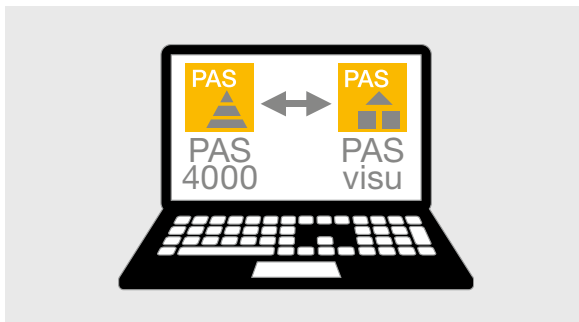

Linking of control projects and visualization.



PASvisu Builder

► PMLvisu – Visualization terminal for PASvisu

PMLvisu from Pilz is a preinstalled and licensed solution package – consisting of the operator terminals PMI with the web-based visualization software PASvisu. This provides professional visualization of plant and machinery at a glance.



PMI v512

The capacitive displays are available in two sizes: Choose between 7" and 12" and benefit from superior functionality. The PMI Assistant is available for simple panel commissioning and management.

Your benefits at a glance

- Professional visualization of plant and machinery
- PASvisu visualization software is preinstalled and licensed
- Up to 500 variables are included for data exchange with the controller
- Efficient project planning thanks to coordinated and preconfigured HMI functions
- Unicode-enabled language management
- Access rights are assigned through the integrated user manager
- External 4 GB SD memory card with PMI v5 Assistant for simple panel commissioning and management

Operator terminals PMI with web-based visualization software PASvisu

Type	Display size	Resolution (in pixels)	Power consumption	Operation	Interfaces	Order number
PMI v507	7" (18 cm)	800 x 480	6.5 W (24 V DC)	Capacitive glass touch-screen	<ul style="list-style-type: none"> ► 1 x RS232 ► 1 x RJ45 ETH ► 1 x SD card ► 2 x USB 2.0 	265 507
PMI v512	12" (31 cm)	1280 x 800	8.9 W (24 V DC)	Capacitive glass touch-screen	<ul style="list-style-type: none"> ► 1 x RS232 ► 1 x RJ45 ETH ► 1 x SD card ► 2 x USB 2.0 	265 512

Type	Features
PASvisu	<ul style="list-style-type: none"> ► Consists of the configuration tool PASvisu Builder and PASvisu Runtime. ► Wide range of predefined GUI elements (tiles) available. ► Sophisticated visualization thanks to the most diverse style sheets. ► Optimum link between control project (PAS4000) and visualization (PASvisu).

Keep up-to-date on the visualization panels:

 Webcode: web160789

Online information at www.pilz.com

▶ Decentralized I/O system PSSUniversal

The decentralized I/O system PSSUniversal allows you to perform safety-related and automation functions at field level. Communication with the control level takes place via common fieldbus protocols. Here all sensor and actuator signals are connected to one module. This ensures clear cabling and avoids errors during installation.



Your benefits at a glance

- ▶ Processing of safety-related and automation functions decentrally at field level
- ▶ Reduction of switching times
- ▶ Optimum availability thanks to safe block switching
- ▶ Fast commissioning and easy configuration thanks to the independent periphery test

The decentralized I/O systems can be connected to different higher-level controllers as a cost-effective variant of a remote I/O system. The PSSUniversal system is therefore a solution for connecting periphery and safety-related functions to a central controller.

Safe block switching of individual plant sections

Safe block switching is used to shut down the supply voltage to a group of standard outputs (e.g. several motors) if a hazardous event occurs. When a hazardous event does occur (e.g. an E-STOP pushbutton is pressed), safe block switching ensures safe shutdown of a complete plant section while other sections can continue to operate.



Simple configuration, fast commissioning

The decentralized I/O systems are configured using the PSSUniversal Assistant. Thanks to the PSSUniversal Startup Tool, the system can be commissioned quickly. You can already perform the first cable and function tests before the plant or machine is set up. That way all of the periphery is already tested and functional when you come to commission the plant. Commissioning operations can be carried out independently and simultaneously – reducing dependencies and saving time!

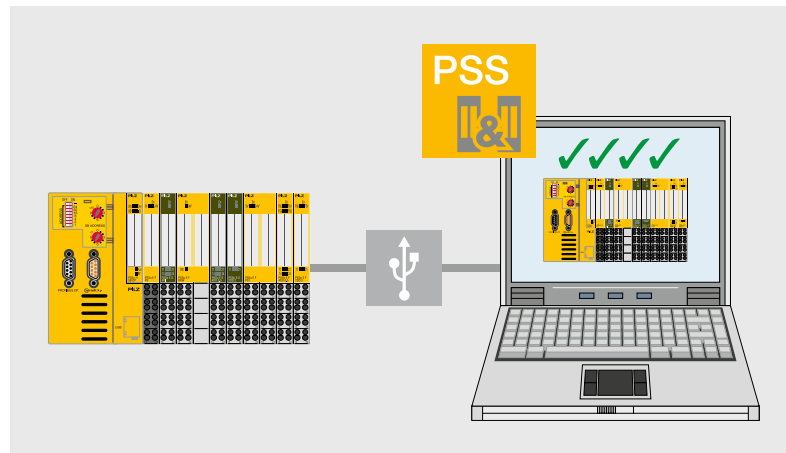

Cable and function tests performed easily via the USB port on the notebook.

PSSUniversal – also for PROFINET users

Optimized address management on the PROFINET versions of the decentralized I/O system is particularly convincing. The PROFINET/PROFIsafe address is only required once per decentralized station. This means, for example, that safety settings for each device only need to be made at a single point, i.e. in the head module. There is no need for address setting and management on each individual I/O module. As a result, the failsafe addresses are optimally utilized. This saves planning and management costs.

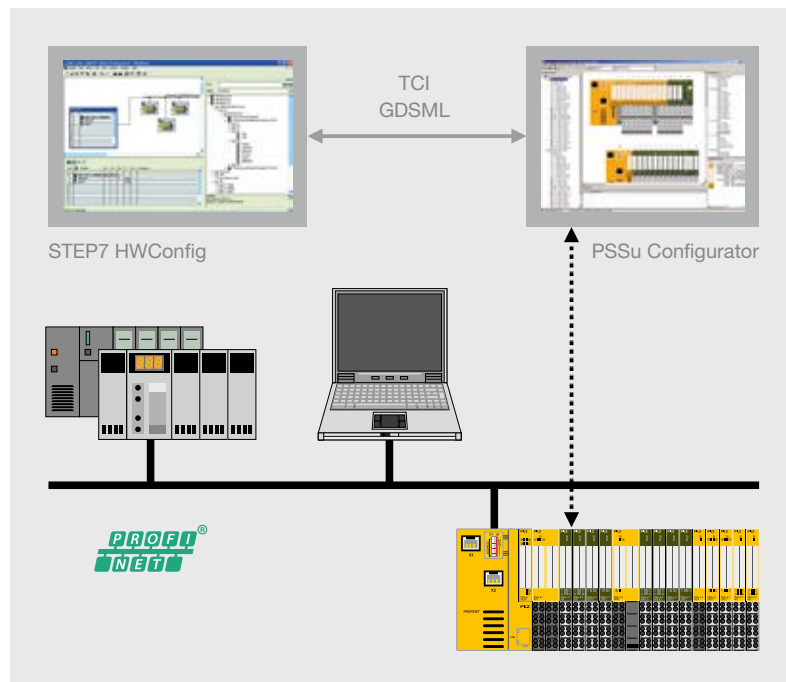

Comprehensive tool support for configuration, commissioning and diagnostics.

PSSu Configurator

- ▶ Called up via TCI
- ▶ Configures the system
- ▶ Generates station-specific GSDML files
- ▶ Manages all safety-related CRC sums

▶ Technical details – Controllers and I/O systems

Decentralized I/O system PSSuniversal – Head modules



PSSu H F PN

Type	Application area		Communication interfaces
	Failsafe functions	Automation functions	
PSSu H F PN	◆	◆	<ul style="list-style-type: none"> ▶ 1 x PROFINET ▶ 1 x PROFIsafe
PSSu H F PN o	◆	◆	<ul style="list-style-type: none"> ▶ 1 x PROFINET ▶ 1 x PROFIsafe ▶ Fibre-optic
PSSu H S PN		◆	2 x PROFINET

Automation system PSS 4000 – Head modules with control and I/O function



PSSuniversal PLC



PSSuniversal multi



PSSuniversal I/O

Type	Application area		Communication interfaces
	Failsafe functions	Automation functions	
▶ PSSuniversal PLC			
PSSu H PLC1 FS SN SD	◆	◆	2 x SafetyNET p
PSSu H PLC1 FS DP SN SD	◆	◆	<ul style="list-style-type: none"> ▶ SafetyNET p ▶ PROFIBUS-DP (slave, DPV0)
▶ PSSuniversal multi			
PSSu H m F DP SN SD	◆	◆	<ul style="list-style-type: none"> ▶ SafetyNET p ▶ PROFIBUS-DP (slave, DPV0)
PSSu H m F DP ETH SD	◆	◆	<ul style="list-style-type: none"> ▶ Ethernet ▶ PROFIBUS-DP (slave, DPV0)
PSSu H m F DPsafe SN SD	◆	◆	<ul style="list-style-type: none"> ▶ SafetyNET p ▶ PROFIBUS/PROFIsafe (PROFIsafe V2.4)
▶ PSSuniversal I/O			
PSSu H FS SN SD	◆	◆	2 x SafetyNET p
PSS67 IO1 16FDI	◆	◆	2 x SafetyNET p

Common features

- ▶ PSSuniversal module bus for connection of up to 64 I/O modules for safety-related and non-safety-related functions
- ▶ Integral power supply
- ▶ Integrated switch function for SafetyNET p linear topology
- ▶ SD card to store the device project and configuration data
- ▶ International safety standards (up to SIL CL 3 of EN/IEC 61508, up to PL e of EN ISO 13849), lifts standard EN 81/2 and EN 50129
- ▶ Dimensions (H x W x D) in mm: 125.6 x 130 x 83.7

PSSuniversal

Features	Approvals	Order number		
		Regular version	T-type ¹⁾	R-type ²⁾
<ul style="list-style-type: none"> ▶ PSSuniversal module bus for connection of up to 64 I/O modules for safety-related and non-safety-related functions ▶ Dimensions (H x W x D) in mm: 128.4 x 75.2 x 79.4 	BG, CE, EAC, TÜV, cULus Listed	312043	-	-
	CE, EAC, TÜV, cULus Listed	312042	-	-
	CE, cULus Listed	312041	-	-

Features	Approvals	Order number		
		Regular version	T-type ¹⁾	R-type ²⁾
<ul style="list-style-type: none"> ▶ Can be configured using the graphics program editor PASmulti ▶ Programming in PAS IL (instruction list), PAS LD (ladder diagram) and PAS STL (structured text) in accordance with EN/IEC 61131-3 ▶ Programming via Ethernet TCP/IP ▶ Max. number of failsafe tasks: 9 ▶ Max. number of standard tasks: 9 	BG, CE, EAC (Eurasian), KOSHA, TÜV, cULus Listed	312070	314070	315070
	BG, CE, EAC (Eurasian), KOSHA, TÜV, cULus Listed	312071	-	-
<ul style="list-style-type: none"> ▶ Local safety functions ▶ Can be configured using the graphics program editor PASmulti ▶ Max. number of failsafe tasks: 1 ▶ Devices with SafetyNET p interface: Max. number of SafetyNET p connections: 5 	BG, CE, EAC (Eurasian), KOSHA, TÜV, cULus Listed	312065	-	-
	BG, CE, EAC (Eurasian), KOSHA, TÜV, cULus Listed	312060	-	-
	BG, CE, EAC (Eurasian), TÜV, cULus Listed	312066	-	-
<ul style="list-style-type: none"> ▶ Communication with other SafetyNET p devices (RTFN) ▶ Standard module bus for standard I/O modules 	BG, CE, EAC (Eurasian), KOSHA, TÜV, cULus Listed	312085	314085	315085
	in preparation	316010	-	-
<ul style="list-style-type: none"> ▶ Communication with other SafetyNET p devices (RTFN) ▶ With IP67 protection – suitable for use in the extended temperature range (-30 °C to +60 °C) 				

¹⁾  The modules are also available as T-type for increased environmental requirements. The order numbers of the T-type modules are 314... instead of 312...

²⁾  The modules are also available as R-type for railway applications. The order numbers of the R-type modules are 315... instead of 312...

Keep up-to-date on controllers PSSuniversal and I/O systems:

 Webcode: web150509

Online information at www.pilz.com

► Technical details – PSSuniversal

Supply modules, junction modules and safe block switching module



PSSu E F PS



PSSu E PD

Type	Suitable for		Function	Application area		Electrical data	
	PSSuniversal – I/O system	PSSuniversal – controllers PSS 4000		Failsafe functions	Automation functions	Supply voltage	Current load capacity Module supply
PSSu E F PS	◆	◆	Power supply	◆	◆	24 V DC	Max. 1.5 A
PSSu E F PS1	◆	◆	Power supply, buffered	◆	◆	24 V DC	Max. 2.0 A
PSSu E F PS2		◆	Power supply, buffered	◆	◆	24 V DC	Max. 1.0 A
PSSu E F PS-P	◆	◆	Power supply, periphery	◆	◆	24 V DC	-
PSSu E PD	◆	◆	Voltage distribution		◆	-	-
PSSu E PD1	◆	◆	Voltage distribution		◆	-	-
PSSu E S PD-D	◆	◆	Voltage distribution		◆	-	-
PSSu E F BSW	◆		Block switching function	◆	◆	24 V DC	-
PSSu E PS-P 5 V	◆	◆	Voltage distribution		◆	24 V DC	-
PSSu E PS-P +/- 10 V	◆	◆	Voltage distribution		◆	24 V DC	-
PSSu E PS-P +/- 15 V	◆	◆	Voltage distribution		◆	24 V DC	-

Keep up-to-date on PSSuniversal I/O modules:

Webcode:
web150421

Online information at www.pilz.com

Type code for PSSuniversal electronic module/supply modules

PSSu E F 4DI

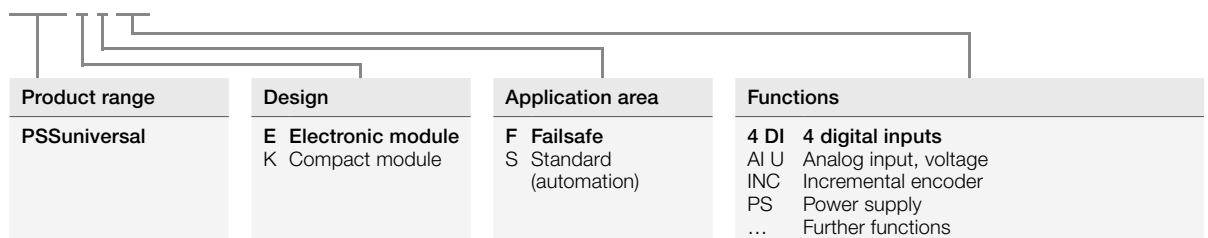

► Technical details – PSSuniversal

Digital inputs and outputs



PSSu E F 4DI



PSSu E S 4DI

Type	Suitable for		Function	Application area	
	PSSuniversal – I/O system	PSSuniversal – controllers PSS 4000		Failsafe functions	Automation functions
PSSu E F 4DI	◆	◆	4 digital inputs	◆	
PSSu E F 4DO 0.5	◆	◆	4 digital outputs	◆	
PSSu E F 2DO 2	◆	◆	2 digital outputs	◆	
PSSu E F DI OZ 2	◆	◆	1 digital input, 1 digital output	◆	
PSSu E F 2DOR 8	◆	◆	2 relay outputs	◆	
PSSu K F FCU		◆	12 digital inputs, 2 digital outputs (1-pole), 2 digital outputs (2-pole), Fast Control Unit	◆	
PSSu K F FAU P		◆	4 digital inputs, 2 digital outputs	◆	
PSSu K F FAU B		◆	4 digital inputs, 2 digital outputs	◆	
PSSu E S 4DI	◆	◆	4 digital inputs		◆
PSSu E S 4DO 0.5	◆	◆	4 digital outputs		◆
PSSu E S 2DO 2	◆	◆	2 digital outputs		◆
PSSu E S 2DOR 10	◆	◆	2 relay outputs		◆
PSSu E S 2DOR 2	◆	◆	2 relay outputs		◆
PSSu K S 8DI 8DO 0.5	◆	◆	8 digital inputs, 8 digital outputs		◆
PSSu K S 16DI	◆	◆	16 digital inputs		◆
PSSu K S 16DO 0.5	◆	◆	16 digital outputs		◆

Common features

- ▶ Supply voltage from module supply: 5 V DC
- ▶ Potential isolation

Keep up-to-date on PSSuniversal I/O modules:

Webcode:
web150421

Online information at www.pilz.com

Electrical data Feature Inputs Outputs	Approvals						Order number		Screw terminals ⁵⁾						Cage clamp terminals ⁶⁾					
	BG	CE	EAC (Eurasian)	KOSHA	TÜV	cULus Listed	Regular version	Diagnostic modules (-D)	Suitable base module	Order number										
-	◆	◆	◆	◆	◆	◆	312200 ¹⁾	-												
0.5 A	◆	◆	◆	◆	◆	◆	312210 ^{1), 2)}	-												
2 A	◆	◆	◆	◆	◆	◆	312215 ^{1), 2)}	-												
1 (2 A), 2-pin 1 test pulse output	◆	◆	◆	◆	◆	◆	312220 ^{1), 2)}	-												
2 N/O AC1: 250 V/8 A; 2000 V DC1: 24 V/8 A	◆	◆	◆	◆	◆	◆	312225 ^{1), 2)}	-							◆	◆				
- 2 (2 A) 1-pin 2 (2 A) 2-pin		◆	◆	◆	◆	◆	312435	-												
2 (3 A) 2-pin		◆	◆		◆	◆	312421	-												
2 (1.75 A) 1-pin		◆	◆		◆	◆	312420	-												
-	◆	◆			◆	◆	312400 ^{1), 2)}	312401			◆	◆	◆		◆	◆	◆			
0.5 A	◆	◆			◆	◆	312405 ¹⁾	312406 ¹⁾			◆	◆	◆		◆	◆	◆			
2 A	◆	◆			◆	◆	312410 ¹⁾	312411 ¹⁾			◆	◆	◆		◆	◆	◆			
2 N/O	◆	◆			◆	◆	312510 ¹⁾	-							◆	◆				
2 N/O		◆				◆	312511 ¹⁾	-			◆	◆	◆		◆	◆	◆			
0.5 A		◆	◆		◆	◆	312431 ¹⁾	-												
-		◆	◆		◆	◆	312430	-												
0.5 A		◆	◆		◆	◆	312432	-												

¹⁾  The modules are also available as T-type for increased environmental requirements. The order numbers of the T-type modules are 314 ... instead of 312 ...

²⁾  The modules are also available as R-type for railway applications. The order numbers of the R-type modules are 315 ... instead of 312 ...

³⁾ Without C-rail

⁴⁾ With C-rail

⁵⁾ Shield terminal available (312963)

⁶⁾ Shield terminal available (312964)

► Technical details – PSSuniversal

Analog inputs and outputs



PSSu E S 4AO U

Type	Suitable for		Function	Application area	
	PSSuniversal – I/O system	PSSuniversal – controllers PSS 4000		Failsafe functions	Automation functions
PSSu E S 2AI U	◆	◆	2 analog inputs		◆
PSSu E S 4AI U	◆	◆	4 analog inputs		◆
PSSu E S 2AI I s.e.	◆	◆	2 analog inputs		◆
PSSu E S 2AO U	◆	◆	2 analog outputs		◆
PSSu E S 4AO U	◆	◆	4 analog outputs		◆
PSSu E S 2AO I	◆	◆	2 analog outputs		◆
PSSu E S 2AI RTD	◆	◆	2 analog inputs		◆
PSSu E S 2AI TC	◆	◆	2 analog inputs		◆
PSSu E F AI I		◆	1 analog input	◆	
PSSu E F AI U		◆	1 analog input	◆	
PSSu E AI SHT1	◆	◆	1 analog input, 2 analog outputs	◆	◆
PSSu E AI SHT2	◆	◆	1 analog input, 2 analog outputs	◆	◆

Keep up-to-date on PSSuniversal I/O modules:

Webcode:
web150421

Online information at www.pilz.com

Electrical data	Approvals					Order number	Screw terminals ⁵⁾										Cage clamp terminals ⁶⁾											
	Feature	BG	CE	EAC (Eurasian)	KOSHA		TÜV	cULus Listed	Suitable base module	Order number	312600	312610	312602	312612	312618	312620	312622	312628	312630	312601	312611	312603	312613	312619	312621	312623	312629	312631
0 ... 10 V s.e.; diff; -10 ... +10 V		◆			◆	◆	312440 ¹⁾	◆	◆				◆	◆					◆	◆			◆	◆				
0 ... 10 V s.e.		◆				◆	312445 ¹⁾	◆	◆				◆	◆					◆	◆			◆	◆				
0 ... 20 mA; 4 ... 20 mA		◆			◆	◆	312450 ¹⁾	◆	◆				◆	◆					◆	◆			◆	◆				
0 ... 10 V; -10 ... +10 V		◆			◆	◆	312460 ¹⁾	◆	◆				◆	◆					◆	◆			◆	◆				
0 ... 10 V		◆				◆	312465 ¹⁾	◆	◆				◆	◆					◆	◆			◆	◆				
0 ... 20 mA; 4 ... 20 mA		◆				◆	312470 ¹⁾	◆	◆				◆	◆					◆	◆			◆	◆				
-		◆			◆	◆	312490 ¹⁾						◆	◆									◆	◆				
Thermocouples		◆			◆	◆	312500 ¹⁾					◆	◆								◆	◆						
0 ... 25 mA		◆					312260 ^{1), 2)}	◆	◆				◆	◆					◆	◆			◆	◆				
-10 ... +10 V		◆					312265 ^{1), 2)}	◆	◆				◆	◆					◆	◆			◆	◆				
0 ... 0.6 A; 0 ... 20 mA		◆	◆		◆	◆	312261 ¹⁾	◆	◆														◆	◆				
0 ... 0.2 A; 0 ... 20 mA		◆				◆	312262	◆	◆				◆	◆					◆	◆			◆	◆				

¹⁾  The modules are also available as T-type for increased environmental requirements. The order numbers of the T-type modules are 314 ... instead of 312 ...

²⁾  The modules are also available as R-type for railway applications. The order numbers of the R-type modules are 315 ... instead of 312 ...

³⁾ Without C-rail

⁴⁾ With C-rail

⁵⁾ Shield terminal available (312963)

⁶⁾ Shield terminal available (312964)

► Technical details – PSSuniversal

Counter modules



PSSu E S INC

Type	Suitable for		Function	Application area	
	PSSuniversal – I/O system	PSSuniversal – controllers PSS 4000		Failsafe functions	Automation functions
PSSu E S ABS SSI	◆	◆	Absolute encoder SSI		◆
PSSu E S INC	◆	◆	Incremental encoder		◆
PSSu E S INC 24V se	◆	◆	Incremental encoder		◆
PSSu E F ABS SSI		◆	Absolute encoder SSI	◆	
PSSu E F INC		◆	Incremental encoder	◆	
PSSu K F INC		◆	Incremental encoder	◆	
PSSu K F EI		◆	Encoder interface	◆	
PSSu K F EI CV		◆	Encoder interface	◆	

Electronic modules with serial interface



PSSu E S RS232

PSSu E S RS232	◆	◆	RS232 interface		◆
PSSu K S RS232		◆	RS232 interface		◆
PSSu K S RS232 Modbus ASCII		◆	RS232 interface		◆
PSSu E S RS485	◆	◆	RS485 interface		◆

Keep up-to-date on PSSuniversal I/O modules:

Webcode:
web150421

Online information at www.pilz.com

Electrical data	Approvals						Order number	Screw terminals ⁵⁾										Cage clamp terminals ⁶⁾										
	Feature	BG	CE	EAC (Eurasian)	KOSHA	TÜV		cULus Listed	Suitable base module	Order number	312600	312610	312602	312612	312618	312620	312622	312628	312630	312601	312611	312603	312613	312619	312621	312623	312629	312631
SSI		◆				◆	312480 ¹⁾	◆	◆				◆		◆			◆	◆			◆		◆				
INC			◆			◆	312485 ¹⁾										◆	◆								◆	◆	
INC			◆		◆	◆	312486 ¹⁾										◆	◆								◆	◆	
SSI	◆	◆	◆	◆	◆	◆	312275 ¹⁾	◆	◆				◆		◆			◆	◆				◆		◆			
INC	◆	◆	◆	◆	◆	◆	312280 ¹⁾										◆	◆								◆	◆	
INC	◆	◆	◆	◆	◆	◆	312437 ¹⁾																					
Sin/Cos, TTL, HTL, initiators 24 V		◆				◆	312433																					
Sin/Cos, TTL, HTL, initiators 24 V		◆				◆	312434 ¹⁾																					

-		◆				◆	312515 ¹⁾		◆	◆			◆	◆				◆	◆			◆	◆					
-		◆				◆	312439 ¹⁾																					
-		◆				◆	312438 ¹⁾																					
-		◆				◆	312516 ¹⁾		◆	◆			◆	◆				◆	◆			◆	◆					

¹⁾  The modules are also available as T-type for increased environmental requirements. The order numbers of the T-type modules are 314 ... instead of 312 ...

²⁾  The modules are also available as R-type for railway applications. The order numbers of the R-type modules are 315 ... instead of 312 ...

³⁾ Without C-rail

⁴⁾ With C-rail

⁵⁾ Shield terminal available (312963)

⁶⁾ Shield terminal available (312964)

▶ Accessories – PSSuniversal

Accessories – PSSuniversal



PSSu XB F-T



PSSu XR F-T



SD Memory Card
512MB

Type	Function
PSSu XB F-T	Base station used to extend the PSSu module bus by 0.5 m or 1 m, inside the control cabinet
PSSu XR F-T	Remote station used to extend the PSSu module bus by 0.5 m or 1 m, inside the control cabinet
PSSu A ET	End bracket for top-hat rail
PSSu A ETM	End bracket for top-hat rail, metal version, for high mechanical stresses
PSSu A EC	Terminating plate with integrated terminating resistor
PSSu A ET PE	Earthing terminal for top-hat rail, PE connection, GN/YE
PSSu A USB-CAB03	PSSu USB cable, length 3 m
PSSu A USB-CAB05	PSSu USB cable, length 5 m
SD Memory Card 512MB	512 MB SD memory card for PSSu head modules
PSSu A Con 1/4 S	Connector set for power supply, 1-row, 4-pin, screw connection
PSSu A Con 2/8 C	Connector set for power supply, 2-row, 8-pin, spring-loaded connection
PSSu A Con 1/10 C	Connector set for compact modules, 1-row, 10-pin, spring-loaded connection
PSSu A Con 3/30 C	Connector set for compact modules, 3-row, 30-pin, spring-loaded connection
PSSu A Con 4 S	Connector for compact modules, 4-pin, screw connection (for INC module)
PSSu A Con 4 C	Connector for compact modules, 4-pin, spring-loaded connection (for INC module)
PSSu A Con Set1 C	Connector set for compact modules, set consisting of 1-row, 5-pin and 10-pin, spring-loaded connection (for K-F-EI module)

Approvals	Order number	Suitable for
BG, CE, EAC (Eurasian), KOSHA, TÜV, cULus Listed	314 092 ¹⁾	<ul style="list-style-type: none"> ▶ PSSu BP 2/16 S _____ 312 628 ▶ PSSu BP 2/16 C _____ 312 629 ▶ PSSu BP-C 2/16 S _____ 312 630 ▶ PSSu BP-C 2/16 C _____ 312 631
BG, CE, EAC (Eurasian), KOSHA, TÜV, cULus Listed	314 093 ¹⁾	Connection cable PSSu A RJ45-CAB 1.5M _____ 314 094 ¹⁾
-	312 900	-
-	312 901	-
cULus Listed	312 902	-
CE, cULus Listed	314 902 ¹⁾	-
-	312 949	-
-	312 992	-
-	312 993	-
-	313 100	-
BG, CE, TÜV, cULus Listed	313 110	Head modules in automation system PSS 4000 (page 126)
BG, CE, TÜV, cULus Listed	313 111	Head modules in automation system PSS 4000 (page 126)
BG, CE, TÜV, cULus Listed	313 115	-
BG, CE, TÜV, cULus Listed	313 116	-
-	313 117	-
CE, cULus Listed	313 118	-
CE, cULus Listed	313 114	-

¹⁾  The modules are available as T-type for increased environmental requirements.

Keep up-to-date
on PSSuniversal
accessories:

 Webcode:
web84867

Online information
at www.pilz.com

► Technical details – Infrastructure components

Unmanaged switches PSSnet SLL



PSSnet SLL 5T

Type	Technical features	Approvals	Order number
PSSnet SLL 5T	5 electrical ports	CE, cULus Listed	380600
PSSnet SLL 4T 1FMMSC	<ul style="list-style-type: none"> ▶ 4 electrical ports ▶ 1 fiber-optic port ▶ Multimode connection 	CE, cULus Listed	380604

Common features

- ▶ Plug and play (no configuration necessary)
- ▶ Diagnostic LEDs

Managed switches PSSnet SHL



PSSnet SHL 6T 2FSMSC MRP

Type	Technical features	Approvals	Order number
PSSnet SHL 8T MRP	8 electrical ports	CE, cULus Listed	380601
PSSnet SHL 6T 2FMMSC MRP	<ul style="list-style-type: none"> ▶ 6 electrical ports ▶ 2 fiber-optic ports ▶ Multimode connection 	CE, cULus Listed	380602
PSSnet SHL 6T 2FSMSC MRP	<ul style="list-style-type: none"> ▶ 6 electrical ports ▶ 2 fiber-optic ports ▶ Single-mode connection 	CE, cULus Listed	380650

Common features

- ▶ Extensive management functions for configuration and diagnostics
- ▶ Web-based management for access via web browser
- ▶ Ring redundancy MRP
- ▶ Redundant voltage supply

SafetyNET p connector, cable and stripping tool



SafetyNET p
Connector RJ45s



SafetyNET p
Cable

Type	Technical features	Approvals	Order number
SafetyNET p connector RJ45s	<ul style="list-style-type: none"> ▶ Standard connector for IP20 installation ▶ Quick connection ▶ RJ45 mating face ▶ Housing form compatible with PSSuniversal stabilising collar ▶ Ambient temperature: -40°C ... +70 °C 	-	380 400
SafetyNET p cable	<ul style="list-style-type: none"> ▶ Cable (by the meter) ▶ Cable cross section AWG 22 ▶ CAT 5e, 4-wire 	-	380 000
SN CAB RJ45s RJ45s, 0.5 m	0.5 m cable with 2 x RJ45 connector	-	380 001
SN CAB RJ45s RJ45s, 1 m	1 m cable with 2 x RJ45 connector	-	380 003
SN CAB RJ45s RJ45s, 2 m	2 m cable with 2 x RJ45 connector	-	380 005
SN CAB RJ45s RJ45s, 5 m	5 m cable with 2 x RJ45 connector	-	380 007
SN CAB RJ45s RJ45s, 10 m	10 m cable with 2 x RJ45 connector	-	380 009
Stripping tool	Installation tool for SafetyNET p cable and connector	-	380 070

Gateways



PSSnet GW1
MOD-EtherCAT

Type	Technical features	Approvals	Order number
PSSnet GW1 MOD-CAN	Protocol converter from Modbus/TCP Slave to CANopen Slave	CE, cULus Listed	311 602
PSSnet GW1 MOD-EtherCAT	Protocol converter from Modbus/TCP slave to EtherCAT slave	CE, cULus Listed	311 601

Keep up-to-date on:

- ▶ Infrastructure components SafetyNET p

Webcode: web150453

- ▶ Gateways

Webcode: web150452

Online information at www.pilz.com

▶ Selection guide – Software

Configuration tools for decentralized I/O system PSSuniversal



Type	Features
PSSuniversal Startup Software incl. PSSuniversal Assistant Configuration of and independent periphery test on decentralized I/O system PSSuniversal	<ul style="list-style-type: none"> ▶ Function test performed on a PSSuniversal system via the USB interface, without controller connected ▶ FS and ST outputs are switched on/off ▶ Input status display (supports e.g. the cabinet manufacturer during the wiring test) ▶ Online help

¹⁾ Startup Software PSSuniversal Assistant is licence-free



Software in the automation system PSS 4000



Type	Features
PAS4000 Software platform in the automation system PSS 4000	<ul style="list-style-type: none"> ▶ PAS STL, PAS IL, PAS LD editors in accordance with EN/IEC 61131-3 ▶ Graphics program editor PASmulti ▶ Online help ▶ Special licence model



Visualization software PASvisu



Type	Features
PASvisu Web-based visualization software	<ul style="list-style-type: none"> ▶ Consists of the configuration tool PASvisu Builder and PASvisu Runtime ▶ Wide range of predefined GUI elements (tiles) ▶ Sophisticated visualization thanks to a wide variety of different style sheets ▶ Optimum link between the control project (PAS4000) and visualization (PASvisu) ▶ Convenient overview, locally and via remote access

Order number

Software can be downloaded from the Internet: www.pilz.com/pssuniversal_tools

- ▶ Single user licence (basic)¹⁾ 312 890B
- ▶ Additional licence (user)¹⁾ for an additional workstation 312 890K

Order number

Software can be downloaded from the Internet: www.pilz.com/pas4000

PASunits: Once enabled for production operation, the project is licensed in PAS4000, PASunits for the used functions are calculated and then credited to the project from the software's points account.

- ▶ PASunits 500 317 910
- ▶ PASunits 1000 317 920
- ▶ PASunits 5000 317 930
- ▶ PASunits 10000 317 940
- ▶ PASkey: USB crypto memory for secure storage and transfer of PASunits 317 999

Order number

Software can be downloaded from the Internet at www.pilz.com/pasvisu

Keep up-to-date on:

- ▶ PSSuniversal tools

 Webcode: web150426

- ▶ PSS 4000 tools

 Webcode: web150424

Online information at www.pilz.com

▶ Selection guide – Software blocks PAS4000®



General failsafe control blocks



FS_EmergencyStop



FS_TwoHandControl



Type	Function
FS_EmergencyStop	Configures and monitors operation of E-STOP pushbuttons with one or two N/C contacts.
FS_LightCurtain	Monitors the function of light grids with 2 N/C contacts.
FS_SafetyGate	Monitors the function of safety gate switches with up to 3 contacts.
FS_Operating ModeSelectorSwitch	Monitors up to 8 positions on an operating mode selector switch. Unneeded inputs may remain unassigned. Once the switchover time has elapsed, only one contact at a time may be closed.
FS_SafetyValve	Monitors the operation of safety valves of the single, double and directional type.
FS_TwoHandControl	Monitors whether the two buttons on the two-hand control are operated simultaneously (within 0.5 s). In accordance with EN 574, two-hand pushbuttons of type IIIA (2 N/O contacts) or type IIIC (combination of 2 N/O and 2 N/C contacts) can be used.
FS_Muting	Used to temporarily suspend safety functions (ESPE/AOPD) without interrupting the process (muting), in accordance with EN 61496-1.
FS_CounterDual	Used in conjunction with the blocks FS_AbsoluteEncoder and/or FS_IncrementalEncoder to calculate the following safe values: Position, speed and standstill.

The PAS4000 software blocks can be found directly within the tool in the software library.
Tool download: www.pilz.com/PAS4000

Hardware-related blocks



Type	Function
FS_Absolute Encoder	Calculates a counter status (in increments) from the measured value from the absolute encoder and monitors the module status.
FS_Incremental Encoder	Initializes the counter, calculates the current counter status (in increments) and transmits status information.
FS_AnalogInput Dual	Monitors redundant, analog input values for upward violation of a value range, downward violation of a value range and upward violation of a difference between the analog input value 0 and analog input value 1 over a defined period of time (plausibility check).
FS_Scaling	Scales an analog input value and sends it to an O-variable.
FS_EI_Basic	Block for compact module PSSu K F EI
FS_EI_SSM0	Block for compact module PSSu K F EI for safe speed monitoring (SSM)
FS_EI_SOSM	Block for compact module PSSu K F EI for safe operating stop monitoring (SOS-M)
FS_EI_SDIM	Block for compact module PSSu K F EI for safe direction monitoring (SDI-M)
FS_EI_SSM1_SSRM	Block for compact module PSSu K F EI for safe speed range monitoring (SSR-M)

Press control blocks



Type	Function
FS_PressOperating Modes	Controls and monitors the setup, single stroke and automatic operating modes of a mechanical press.
FS_CamEvaluation	Monitors the mechanical rotary cam arrangement of a press for: plausibility of the signals from the overrun cam and run-up cam, failure of the dynamic cam and overrun cam, upward violation of the overrun at top dead centre.
FS_CycleMode LightCurtain	Enables the cycle mode (control) for triggering the press stroke when using a light curtain in the standard and Sweden operating modes.
FS_CamController	Provides the position signals for a press control. It uses the angle values, e.g. from the block FS_PositionToAngle, to determine the signal for achieving the top dead centre and so enables shutdown of the press. It is used in the safe, electronic rotary cam arrangement.

Keep up-to-date on PAS4000:

 Webcode: web150424

Online information at www.pilz.com

▶ Remote I/O system PSSuniversal 2



The PSSuniversal 2 remote I/O system is the new generation of universal systems from Pilz. PSSuniversal 2 offers flexibility, openness and granularity in a single system for safety and automation. In the first stage the remote I/O system consists of the PROFINET communication module and a selection of I/O modules. A communication module with EtherNet/IP interface and further I/O modules will be available in the next step. Thanks to technical and mechanical improvements users benefit from time and cost savings. The most striking new development is the three-part system structure, which makes the remote I/O system PSSuniversal 2 extremely easy to install and service.



Your benefits at a glance

- ▶ Easy, flexible and granular:
 - Optimized handling during commissioning and service
 - Three-part system structure reduces servicing work
- ▶ Compact:
 - Minimized dimensions thanks to maximum packing density, with up to 16 channels on 12.5 mm
- ▶ Functional safety as a basic function:
 - Design of safety and standard functions that can be combined at will
- ▶ Precise diagnostics:
 - Concordant display of the faulty module slot and the terminal affected
 - Rapid fault localization and troubleshooting
- ▶ Openness:
 - Ability to adapt to PROFINET, EtherNet/IP and other protocols by exchanging the head module
 - Safe I/O modules universally usable in an identical manner for a wide variety of safety protocols



Simple configuration

The remote I/O system PSSUniversal 2 is configured using the new software PASconfig. This software allows you to put the system into operation quickly and simply. PASconfig can be called up directly from the Tool Calling Interface of the TIA portal.

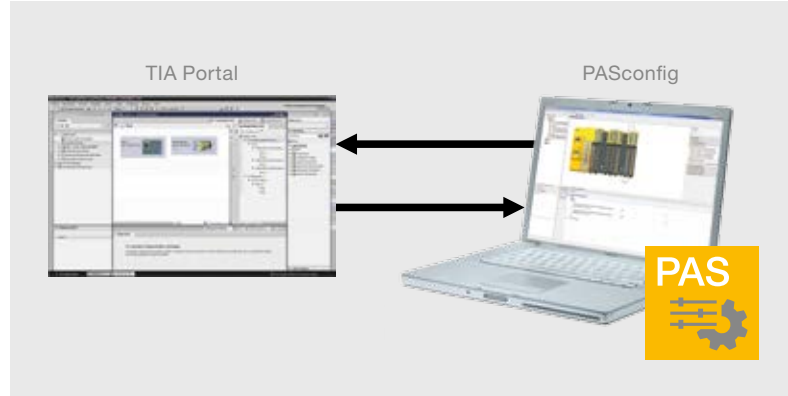

Software tool PASconfig for advanced configuration from the TIA Portal.

Improved mechanical design

The new three-part system design significantly reduces the work involved in service and maintenance. Diagnostics can be performed with great precision in the remote I/O system. Modules can be hot-swapped. As a result the head module can be swapped without having to reconfigure. It is no longer necessary to completely dismantle the system to swap the backplane. PSSUniversal 2 offers a high level of operating safety thanks to individual coding.

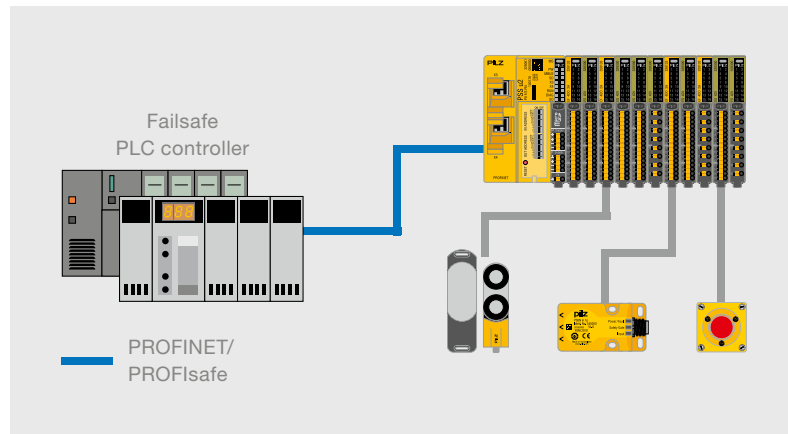

Standard and safety-related connection via PROFINET/PROFIsafe.



Keep up-to-date on the remote I/O system PSSUniversal 2:

Webcode: web150509

Online information at www.pilz.com

► Technical details – PSSuniversal 2

Remote I/O system PSSuniversal 2 – Head module



PSS u2 P0 F/S PN

Type	Communication interfaces	Application area	
		Failsafe functions	Automation functions
PSS u2 P0 F/S PN	2 x PROFINET/PROFIsafe	◆	◆

Backplanes/module racks



PSS u2 B 4

Type	Function	Application area	
		Failsafe functions	Automation functions
PSS u2 B 4	Module rack with 4 slots	◆	◆
PSS u2 B 1	Module rack with 1 slot	◆	◆

Supply modules/junction modules



PSS u2 ES 16PT 0V

Type	Function
PSS u2 ES 16PT 0V	Standard routing module, 0 V supply, 16-fold
PSS u2 ES 16PT FE	Standard routing module, functional earth, shield connection, 16-fold
PSS u2 ES 8PTD 24V 0V	Standard routing module, 24 V supply, 0 V supply, diagnosable, 16-fold
PSS u2 ES PSP	Voltage supply module, 24 V/8 A periphery supply

Features	Approvals	Order number	Suitable terminal block
<ul style="list-style-type: none"> ▶ Head module PROFINET Client/PROFIsafe Device ▶ Integrated Ethernet switch (two Ethernet ports) ▶ Can be configured using the PASconfig tool ▶ PSS u2 backplane bus for connecting up to 64 I/O modules ▶ Dimensions (H x W x D) in mm: 110.1 x 64.1 x 94.7 	CE, TÜV, ¹⁾	328061	328831

Features	Approvals	Order number
<ul style="list-style-type: none"> ▶ Backplane and module supply ▶ Dimensions (H x W x D) in mm: 107.0 x 53.9 x 32.9 	CE, TÜV, ¹⁾	328810
<ul style="list-style-type: none"> ▶ Backplane and module supply ▶ Dimensions (H x W x D) in mm: 107.0 x 16.4 x 32.9 	CE, TÜV, ¹⁾	328811

Features	Approvals	Order number	Suitable terminal block
16 terminal connections, 0 V potential	CE, TÜV, ¹⁾	328090	328850
16 terminal connections, functional earth	CE, TÜV, ¹⁾	328091	328850
<ul style="list-style-type: none"> ▶ 8 terminal connections, 0 V ▶ 8 terminal connections, 24 V DC/0.5 A 	CE, TÜV, ¹⁾	328092	328850
Infeed of periphery voltage 24 V DC, max. 8 A	CE, TÜV, ¹⁾	328080	328840

¹⁾ Product labelling for the North American market is currently in preparation

Keep up-to-date on the remote I/O system PSSuniversal 2:

 Webcode: web150509

Online information at www.pilz.com

► Technical details – PSSuniversal 2

Digital inputs and outputs



Type	Function	Application area	
		Failsafe functions	Automation functions
PSS u2 EF 8DI	8 digital inputs	◆	
PSS u2 EF 8DO 0.5A	8 digital outputs	◆	
PSS u2 EF 4DO 2A	4 digital outputs	◆	
PSS u2 EF 2DO TP 2A	2 digital outputs	◆	
PSS u2 EF 2DO R 8A	2 relay outputs	◆	
PSS u2 ES 4DID	4 digital inputs		◆
PSS u2 ES 8DID	8 digital inputs		◆
PSS u2 ES 4DI	4 digital inputs		◆
PSS u2 ES 8DI	8 digital inputs		◆
PSS u2 ES 4DOD 0.5A	4 digital outputs		◆
PSS u2 ES 8DOD 0.5A	8 digital outputs		◆
PSS u2 ES 16DOD 0.5A	16 digital outputs		◆
PSS u2 ES 4DOD 2A	4 digital outputs		◆

Accessories



Type	Function
PSS u2 A LC E1 (10 pcs.)	Label holder 23.5 x 10.5 mm, 10 pcs.
PSS u2 A LC E2 (10 pcs.)	Label holder 103 x 10.5 mm, 10 pcs.
PSS u2 A LC T3 (10 pcs.)	Label holder for terminal block, 61 x 11.5 mm, 10 pcs.
PSS u2 A CE E (10 pcs.)	Coding element, 10 pcs.
PSS u2 A CE T (10 pcs.)	Coding strip, 10 pcs.
PSS u2 A SH 4 (10 pcs.)	Shield connection element for backplane/module rack with 4 slots (pack of 10)
PSS u2 A LA E1 (10 pcs.)	Label strip 23.5 x 10.5 mm (10 DIN A4 sheets)
PSS u2 A LA E2 (10 pcs.)	Label strips 103 x 10.5 mm (10 DIN A4 sheets)

Features	Approvals	Order number	Suitable terminal block
8 digital inputs (24 V), 8/4 test pulse outputs	CE, TÜV, ¹⁾	328 101	328 850
8 semiconductor outputs, positive-switching, max. 0.5 A	CE, TÜV, ¹⁾	328 131	328 850
4 semiconductor outputs, positive-switching, max. 2 A	CE, TÜV, ¹⁾	328 133	328 840
2 semiconductor outputs, 2-pole, max. 2 A	CE, TÜV, ¹⁾	328 140	328 840
2 N/O contacts, 250 V AC/10 A, 24 V/10 A	CE, TÜV, ¹⁾	328 150	328 840
4 digital inputs (24 V), extended diagnostics	CE, TÜV, ¹⁾	328 310	328 840
8 digital inputs (24 V), extended diagnostics	CE, TÜV, ¹⁾	328 311	328 850
4 digital inputs (24 V)	CE, TÜV, ¹⁾	328 300	328 840
8 digital inputs (24 V)	CE, TÜV, ¹⁾	328 301	328 840
4 semiconductor outputs, positive-switching, max. 0.5 A, extended diagnostics	CE, TÜV, ¹⁾	328 400	328 840
8 semiconductor outputs, positive-switching, max. 0.5 A, extended diagnostics	CE, TÜV, ¹⁾	328 401	328 850
16 semiconductor outputs, positive-switching, max. 0.5 A, extended diagnostics	CE, TÜV, ¹⁾	328 402	328 850
4 semiconductor outputs, positive-switching, max. 2 A, extended diagnostics	CE, TÜV, ¹⁾	328 410	328 840

	Approvals	Order number
	CE, TÜV, ¹⁾	328 910
	CE, TÜV, ¹⁾	328 911
	CE, TÜV, ¹⁾	328 912
	CE, TÜV, ¹⁾	328 860
	CE, TÜV, ¹⁾	328 861
	CE, TÜV, ¹⁾	328 820
	CE, TÜV, ¹⁾	328 913
	CE, TÜV, ¹⁾	328 914

¹⁾ Product labelling for the North American market is currently in preparation

Keep up-to-date on the remote I/O system PSSuniversal 2:

 Webcode: web150509

Online information at www.pilz.com

► Consulting, engineering and training

As a solution supplier, Pilz can help you to apply optimum safety strategies worldwide. Services encompass the whole machine lifecycle. Our training package with practical, up-to-date course content completes the offering.



We are your reliable service provider for plant and machinery safety

Your projects belong in our safe hands!



Risk assessment

We inspect your machinery in accordance with the applicable national and/or international standards and directives and assess the existing hazards.



Safety concept

We develop detailed technical solutions for the safety of your plant and machinery through mechanical, electronic and organizational measures.



Safety design

The aim of the safety design is to reduce or eliminate danger points through detailed planning of the necessary safeguards.



System implementation

The results of the risk analysis and safety design are implemented to suit the particular requirements through selected safety measures.



tuv-sued.de/ps-zert

Our management system was certified in the field of system integration to EN/IEC 61508.



Safety validation

In the safety validation, the risk assessment and safety concept are mirrored and inspected by competent, specialist staff.



CE marking

We control all activities and processes for the necessary conformity assessment procedure, including the technical documentation that is required.



International compliance services

We conduct the evaluation process and develop the necessary strategies in order to enable compliance with the relevant ISO, IEC, ANSI, EN or other national or international standards.



Machinery Safety Audit

We will prepare an overview of your entire plant in the shortest possible time. With an on-site inspection we will expose risks and calculate the cost of optimizing your safeguards.



Inspection of safeguards

With our independent, ISO/IEC 17020-compliant inspection body, which is accredited by the German Accreditation Body (DAkkS), we can guarantee objectivity and high availability of your machines.



Pilz GmbH & Co. KG, Ostfildern, operates an independent inspection body in accordance with DIN EN ISO/IEC 17020:2012 for the plant and machinery sector, accredited by the German Accreditation Body (DAkkS).



LOTO System

Our customized Lockout Tagout (LOTO) measures guarantee that staff can safely control potentially hazardous energies during maintenance and repair.



Training

Pilz offers two types of courses: Product-neutral seminars on machinery safety and product-specific courses



And to progress to the expert level in machinery safety we offer the qualification of CMSE® – Certified Machinery Safety Expert.

Services related to machinery safety:

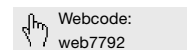

Online information at www.pilz.com

Index

- ▶ **0-9**
 - 2-relay technology _____ 36
- ▶ **A**
 - Absolute encoder _____ 134, 143
 - AC/DC supplies _____ 12, 16
 - ActiveX Control UA _____ 106
 - Adapter _____ 112
 - Analog inputs and outputs _____ 132
 - Analog input signals _____ 92
 - Analog output _____ 12, 16
 - AND/OR logic connection _____ 47
 - Automatic mode _____ 100
 - Automation _____ 9
 - Automation system PSS 4000 _____ 116, 118, 121, 122, 126, 140
- ▶ **B**
 - Backplanes/module racks _____ 146
 - Base unit _____ 56, 58, 61, 68, 74, 78, 84, 86, 92, 94
 - Block switching module _____ 128
 - Brake control, safe _____ 28
 - Burner controls _____ 24, 92
 - Burner management _____ 93, 94
- ▶ **C**
 - Cable _____ 112
 - Cable cars _____ 55, 121
 - Cable navigator _____ 112
 - CANopen _____ 82, 90, 102
 - CC-Link _____ 82, 90, 104
 - Communication networks _____ 73, 75
 - Compact controllers _____ 68, 84
 - Configurable control systems _____ 8, 66, 68, 74, 77, 78
 - Configurable safety systems _____ 92, 94
 - Configurable small controllers _____ 68, 108
 - Configuration _____ 9, 26, 68, 70, 71, 84, 92, 124, 125
 - Contact expansion _____ 22, 25, 27, 34, 58, 84
 - Control diagnostics _____ 122
 - Controllers _____ 9, 73, 75, 114, 116, 119
 - Controllers and I/O systems _____ 114, 116, 126
 - Control technology _____ 8
 - Current monitoring _____ 15
- ▶ **D**
 - Data exchange _____ 77, 84, 123
 - Decentralization _____ 77, 87, 110
 - Decentralized modules _____ 77, 84, 110
 - DeviceNet _____ 90, 102
 - Diagnostic list _____ 122
 - Diagnostics _____ 15, 18, 22, 29, 46, 57, 62, 63, 69, 72, 84
 - Diagnostic solution PVIS _____ 70, 71, 75, 106
 - Digital inputs _____ 130, 148
 - Digital inputs and outputs _____ 130, 148
 - DIN EN 61557-8 _____ 12, 16
 - DIN ISO 9001 _____ 21
 - DIN VDE 0100-710 _____ 12
 - Direction of rotation _____ 16, 26, 34, 100
 - Display, illuminated _____ 78
 - Diverse safety contacts _____ 24, 32
 - Drive monitoring _____ 26, 92, 100
- ▶ **E**
 - E-STOP _____ 18, 22, 36, 44, 56, 92, 124
 - E-STOP relays _____ 18
 - Earth fault monitoring _____ 16
 - Electrical safety _____ 12
 - Electromechanical contacts _____ 36
 - Electronic monitoring relays _____ 12
 - EN/IEC 62061 _____ 21, 26, 28, 111
 - EN 50156-1 _____ 24, 32
 - EN 81-1/A3 _____ 32
 - EN ISO 13849-1 _____ 21, 24, 26, 28, 111
 - EtherCAT _____ 82, 90, 102, 119
 - EtherNet/IP _____ 82, 104, 119, 144
 - Ethernet _____ 82
 - Ethernet TCP/IP _____ 75, 90
 - Evaluation device _____ 110, 112
- ▶ **F**
 - Fiber-optic cable _____ 102
 - Fieldbus _____ 75
 - Fieldbus modules _____ 73, 75, 82, 84, 90, 92, 102, 104
 - Fill level _____ 12
 - Furnaces _____ 24, 93
- ▶ **H**
 - Head modules _____ 116, 126, 146
 - Holding brakes _____ 28, 29
- ▶ **I**
 - I/O block _____ 119
 - I/O systems _____ 119
 - IEC 60364-7-710 _____ 12
 - Increased environmental requirements _____ 87, 95, 97, 99, 101, 103, 105
 - Incremental encoder _____ 76, 100
 - Independent periphery test _____ 124
 - Industrie 4.0 _____ 62, 71, 119, 121
 - Input and output modules _____ 116, 117
 - Input module _____ 92, 96, 111
 - Instruction list _____ 120, 127, 140
 - Insulation fault _____ 14
 - Insulation monitoring _____ 16
 - Insulation resistance _____ 13
 - Interbus _____ 102
 - International standards and regulations _____ 20
 - IP20 _____ 63, 65, 139
 - IP67 _____ 63, 65, 77, 110, 119, 127
 - IT networks _____ 12, 16
- ▶ **J**
 - Junction modules _____ 128, 146
- ▶ **L**
 - Ladder diagram _____ 120, 127
 - Lifts standard EN 81-1 _____ 24
 - Light beam devices _____ 18, 36, 44, 92
 - Link modules _____ 69, 77
 - Logic function operations _____ 46
- ▶ **M**
 - Machine control _____ 69
 - Machinery Directive _____ 26
 - Macro elements _____ 71
 - Modbus TCP _____ 73, 75, 90, 104, 119
 - Modular structure _____ 18, 62, 77
 - Module program (mIQ) _____ 76
 - Motion monitoring, safe _____ 120
 - Motion monitoring functions _____ 120
 - Motion monitoring modules _____ 69, 76
 - Motor feedback _____ 26, 27
 - Multi-master principle _____ 119, 121
 - Muting _____ 36, 43
- ▶ **O**
 - OPC UA server _____ 71, 72, 107
 - Operating modes, selectable _____ 22
 - Operating modes _____ 18, 22, 24, 53, 93, 94, 143
 - Operating mode selector switch _____ 142
 - Operator terminals _____ 22, 71, 73, 75, 123
 - Optimized address management _____ 125
 - Overcurrent _____ 14
 - Overexcitation _____ 28
 - Overload _____ 14
 - Overload and underload monitoring _____ 12
 - Overtemperature _____ 14
 - Overvoltage _____ 14

► P

PAS4000 ____ 73, 120, 121, 122, 140, 142
 PASconfig ____ 145
 PAS IL ____ 120, 140
 PAS LD ____ 120, 140
 PAS STL ____ 120, 140
 PASvisu Builder ____ 122
 PDP67 ____ 75, 77, 110, 112
 Performance Level (PL) –
 EN ISO 13849-1 ____ 30, 38, 48
 Performance Level PL e/
 Cat. 4 of EN ISO 13849-1 ____ 78
 Periphery ____ 124
 Phase failure monitoring ____ 16
 Phase sequence evaluation ____ 16
 Phase sequence monitoring ____ 16
 PLIDdys, safe
 line inspection ____ 52, 54, 55
 PMDsigma ____ 12
 PMDsrage ____ 14, 16
 PMLvisu ____ 72, 123
 PNOZ ____ 18, 20
 PNOZcompact ____ 18, 44
 PNOZelog ____ 18, 46
 PNOZmulti 2 ____ 68, 74
 PNOZmulti ____ 68, 92
 PNOZmulti Configurator ____ 69, 70, 71,
 74, 75, 76, 85, 92, 106
 PNOZmulti Mini ____ 68, 84
 PNOZpower ____ 18, 56
 PNOZsigma ____ 18, 22, 24, 26, 28
 PNOZ X ____ 18, 36
 Position ____ 26, 142
 Position monitoring ____ 35
 POWERLINK ____ 82, 90, 104
 Press application ____ 93, 94
 Presses ____ 93
 Pressure-sensitive mats ____ 18
 PROFIBUS-DP ____ 82, 90, 102, 119
 PROFINET ____ 82, 104, 119, 125, 144, 145
 PROFIsafe ____ 125, 145
 Program editor PASmulti ____ 119, 120
 Programming ____ 9, 116, 119, 121
 Programming languages ____ 120
 Proximity switch ____ 26, 27
 PSSuniversal ____ 9, 114, 116,
 117, 124, 125
 PSSuniversal 2 ____ 9, 117, 144, 145
 PSSuniversal Assistant ____ 125, 140
 Push-in technology ____ 18, 22, 45

► R

Real-time
 Ethernet SafetyNET p ____ 119, 121
 Reduced speed ____ 26
 Relays ____ 8, 10
 Remote access ____ 73
 Remote I/O system ____ 9, 117, 124, 144
 Residual voltage ____ 14
 RS232 ____ 82, 90, 95, 134

► S

Safe block switching ____ 124
 Safe control technology ____ 20
 Safe direction (SDI) ____ 26, 76
 Safe operating stop (SOS) ____ 26, 76
 Safe speed monitoring (SSM) ____ 26, 76
 Safe speed range (SSR) ____ 26, 76
 Safe stop 1 (SS1) ____ 76
 Safe stop 2 (SS2) ____ 76
 Safety, electrical ____ 10
 Safety, functional ____ 10
 Safety brakes ____ 28, 29
 Safety circuit ____ 92
 Safety contacts ____ 18, 25, 56
 Safety Device Diagnostics ____ 62, 121
 Safety functions ____ 18, 66, 74
 Safety functions
 in accordance with EN 61800-5-2 ____ 76
 Safety gates ____ 18, 36, 44, 56, 92
 Safety Integrity Level (SIL) CL 3
 of IEC 62061 ____ 78
 Safety Integrity Level (SIL) CL –
 claim limit of IEC 62061 ____ 30, 38, 48
 Safety relays ____ 18, 20, 22, 24, 28, 36,
 44, 46, 56, 110
 Safety standard ____ 8, 68, 85
 Safety systems ____ 68, 92
 Safety technology ____ 18, 20, 22, 68
 Safety valves ____ 24
 Scalability ____ 19
 Semiconductor output module ____ 93
 Sercos III ____ 104
 Set-up mode ____ 26, 93, 94, 100
 Shear pin breakage ____ 26, 34
 Short commissioning time ____ 15, 84
 Small controllers ____ 8, 66
 Software ____ 8, 70, 72, 75, 106,
 116, 117, 119, 120, 121,
 122, 140, 142, 145
 Software blocks ____ 8, 68, 76, 93,
 120, 142

Speed ____ 26, 34
 Speed monitor ____ 26, 30, 100
 Speed monitoring ____ 34, 36, 92, 100
 Speed range ____ 26
 Spring-loaded terminals ____ 22
 Standardization ____ 44
 Standards ____ 8, 20, 21
 Standstill ____ 26, 34, 142
 Standstill monitor ____ 30, 92
 Standstill monitoring ____ 14, 36, 92, 100
 Startup tool ____ 125
 Structured text ____ 120, 127
 Supply modules ____ 128, 146

► T

TCI ____ 125
 Temperature-resistant modules ____ 121
 Temperature monitoring ____ 15, 16
 Timer functions ____ 22, 32
 Times, selectable ____ 22
 Tool support ____ 125
 True power conversion ____ 12
 True power monitoring ____ 12, 14, 16
 Two-hand control ____ 18, 36, 92

► U

Unearthed AC/DC systems ____ 13
 Universal power supply ____ 18, 19, 36
 USB interface ____ 86

► V

Visualization ____ 28, 71, 72, 119,
 121, 122, 123, 140
 Visualization software PASvisu,
 web-based ____ 8, 66, 70, 72, 73, 75,
 121, 122, 123, 140
 Visualization terminal ____ 123
 Voltage-free contacts ____ 36
 Voltage monitoring ____ 15

► W

Wear-free ____ 18, 25, 46
 Wind turbines ____ 55, 121

▶ Contact

AT

Pilz Ges.m.b.H.
Sichere Automation
Modecenterstraße 14
1030 Wien
Austria
Telephone: +43 1 7986263-0
Telefax: +43 1 7986264
E-Mail: pilz@pilz.at
Internet: www.pilz.at

AU

Pilz Australia
Safe Automation
Unit 1, 12-14 Miles Street
Mulgrave
Victoria 3170
Australia
Telephone: +61 3 95600621
Telefax: +61 3 95749035
E-Mail: safety@pilz.com.au
Internet: www.pilz.com.au

BE, LU

Pilz Belgium
Safe Automation
Bijenstraat 4
9051 Gent (Sint-Denijs-Westrem)
Belgium
Telephone: +32 9 3217570
Telefax: +32 9 3217571
E-Mail: info@pilz.be
Internet: www.pilz.be

BR

Pilz do Brasil
Automação Segura
Av. Piraporinha, 521
Bairro: Planalto
São Bernardo do Campo – SP
CEP: 09891-000
Brazil
Telephone: +55 11 4126-7290
Telefax: +55 11 4942-7002
E-Mail: pilz@pilz.com.br
Internet: www.pilz.com.br

CA

Pilz Automation Safety Canada L.P.
250 Bayview Drive
Barrie, Ontario
Canada, L4N 4Y8
Telephone: +1 705 481-7459
Telefax: +1 705 481-7469
E-Mail: info@pilz.ca
Internet: www.pilz.ca

CH

Pilz Industrieelektronik GmbH
Gewerbepark Hintermättli
5506 Mägenwil
Switzerland
Telephone: +41 62 88979-30
Telefax: +41 62 88979-40
E-Mail: pilz@pilz.ch
Internet: www.pilz.ch

CN

Pilz Industrial Automation
Trading (Shanghai) Co., Ltd.
Rm. 1702-1704
Yongda International Tower
No. 2277 Long Yang Road
Shanghai 201204
China
Telephone: +86 21 60880878
Telefax: +86 21 60880870
E-Mail: sales@pilz.com.cn
Internet: www.pilz.com.cn

CZ

Pilz Czech s.r.o.
Safe Automation
Zelený pruh 1560/99
140 00 Praha 4
Czech Republic
Telephone: +420 222 135353
Telefax: +420 296 374788
E-Mail: info@pilz.cz
Internet: www.pilz.cz

DE

Pilz GmbH & Co. KG
Felix-Wankel-Straße 2
73760 Ostfildern
Germany
Telephone: +49 711 3409-0
Telefax: +49 711 3409-133
E-Mail: info@pilz.de
Internet: www.pilz.de

DK

Pilz Skandinavien K/S
Safe Automation
Ellegaardvej 25 L
6400 Sonderborg
Denmark
Telephone: +45 74436332
Telefax: +45 74436342
E-Mail: pilz@pilz.dk
Internet: www.pilz.dk

ES

Pilz Industrieelektronik S.L.
Safe Automation
Camí Ral, 130
Polígono Industrial Palou Nord
08401 Granollers
Spain
Telephone: +34 938497433
Telefax: +34 938497544
E-Mail: pilz@pilz.es
Internet: www.pilz.es

FI

Pilz Skandinavien K/S
Safe Automation
Nuijamiestentie 7
00400 Helsinki
Finland
Telephone: +358 10 3224030
Telefax: +358 9 27093709
E-Mail: pilz.fi@pilz.dk
Internet: www.pilz.fi

FR

Pilz France Electronic
1, rue Jacob Mayer
CS 80012
67037 Strasbourg Cedex 2
France
Telephone: +33 3 88104000
Telefax: +33 3 88108000
E-Mail: siege@pilz-france.fr
Internet: www.pilz.fr

GB

Pilz Automation Ltd
Pilz House
Little Colliers Field
Corby, Northants
NN18 8TJ
United Kingdom
Telephone: +44 1536 460766
Telefax: +44 1536 460866
E-Mail: sales@pilz.co.uk
Internet: www.pilz.co.uk

ID

Pilz South East Asia Pte. Ltd.
25 International Business Park
#04-56 German Centre
Singapore 609916
Singapore
Telephone: +65 6839 292-0
Telefax: +65 6839 292-1
E-Mail: sales@pilz.sg
Internet: www.pilz.sg

IE

Pilz Ireland Industrial Automation
Cork Business and Technology Park
Model Farm Road
Cork
Ireland
Telephone: +353 21 4346535
Telefax: +353 21 4804994
E-Mail: sales@pilz.ie
Internet: www.pilz.ie

IN

Pilz India Pvt Ltd.
Office No 202, Delite Square
Near Aranyeshwar Temple
Sahakar Nagar No 1
Pune 411009
India
Telephone: +91 20 2421399-4/-5
Telefax: +91 20 2421399-6
E-Mail: info@pilz.in
Internet: www.pilz.in

IT, MT

Pilz Italia S.r.l.
Automazione sicura
Via Gran Sasso n. 1
20823 Lentate sul Seveso (MB)
Italy
Telephone: +39 0362 1826711
Telefax: +39 0362 1826755
E-Mail: info@pilz.it
Internet: www.pilz.it

JP

Pilz Japan Co., Ltd.
Safe Automation
Ichigo Shin-Yokohama Bldg. 4F
3-17-5 Shin-Yokohama
Kohoku-ku
222-0033 Yokohama
Japan
Telephone: +81 45 471-2281
Telefax: +81 45 471-2283
E-Mail: pilz@pilz.co.jp
Internet: www.pilz.jp

KH

Pilz South East Asia Pte. Ltd.
25 International Business Park
#04-56 German Centre
Singapore 609916
Singapore
Telephone: +65 6839 292-0
Telefax: +65 6839 292-1
E-Mail: sales@pilz.sg
Internet: www.pilz.sg

Headquarters:

Pilz GmbH & Co. KG, Felix-Wankel-Straße 2, 73760 Ostfildern, Germany
Telephone: +49 711 3409-0, Telefax: +49 711 3409-133, E-Mail: info@pilz.de, Internet: www.pilz.com

KR

Pilz Korea Ltd.
Safe Automation
4FL, Elentec bldg.,
17 Pangyoro-228 Bundang-gu
Seongnam-si
Gyunggi-do
South Korea 13487
Telephone: +82 31 450 0677
Telefax: +82 31 450 0670
E-Mail: info@pilzkorea.co.kr
Internet: www.pilz.co.kr

LA

Pilz South East Asia Pte. Ltd.
25 International Business Park
#04-56 German Centre
Singapore 609916
Singapore
Telephone: +65 6839 292-0
Telefax: +65 6839 292-1
E-Mail: sales@pilz.sg
Internet: www.pilz.sg

MX

Pilz de México, S. de R.L. de C.V.
Automatización Segura
Convento de Actopan 36
Jardines de Santa Mónica
Tlalnepantla, Méx. 54050
Mexico
Telephone: +52 55 5572 1300
Telefax: +52 55 5572 1300
E-Mail: info@pilz.com.mx
Internet: www.pilz.mx

MY

Pilz South East Asia Pte. Ltd.
25 International Business Park
#04-56 German Centre
Singapore 609916
Singapore
Telephone: +65 6839 292-0
Telefax: +65 6839 292-1
E-Mail: sales@pilz.sg
Internet: www.pilz.sg

NL

Pilz Nederland
Veilige automatisering
Havenweg 22
4131 NM Vianen
Netherlands
Telephone: +31 347 320477
Telefax: +31 347 320485
E-Mail: info@pilz.nl
Internet: www.pilz.nl

NZ

Pilz New Zealand
Safe Automation
Unit 4, 12 Laidlaw Way
East Tamaki
Auckland 2016
New Zealand
Telephone: +64 9 6345350
Telefax: +64 9 6345352
E-Mail: office@pilz.co.nz
Internet: www.pilz.co.nz

PH

Pilz South East Asia Pte. Ltd.
25 International Business Park
#04-56 German Centre
Singapore 609916
Singapore
Telephone: +65 6839 292-0
Telefax: +65 6839 292-1
E-Mail: sales@pilz.sg
Internet: www.pilz.sg

PL, BY, UA

Pilz Polska Sp. z o.o.
Safe Automation
ul. Ruchliwa 15
02-182 Warszawa
Poland
Telephone: +48 22 8847100
Telefax: +48 22 8847109
E-Mail: info@pilz.pl
Internet: www.pilz.pl

PT

Pilz Industrielektronik S.L.
R. Eng Duarte Pacheco, 120
4 Andar Sala 21
4470-174 Maia
Portugal
Telephone: +351 229407594
E-Mail: pilz@pilz.pt
Internet: www.pilz.pt

RU

Pilz RUS OOO
Ugreshskaya street, 2,
bldg. 11, office 16 (1st floor)
115088 Moskau
Russian Federation
Telephone: +7 495 665 4993
E-Mail: pilz@pilzrussia.ru
Internet: www.pilzrussia.ru

SE

Pilz Skandinavien K/S
Safe Automation
Smörhålevägen 3
43442 Kungsbacka
Sweden
Telephone: +46 300 13990
Telefax: +46 300 30740
E-Mail: pilz.se@pilz.dk
Internet: www.pilz.se

SG

Pilz South East Asia Pte. Ltd.
25 International Business Park
#04-56 German Centre
Singapore 609916
Singapore
Telephone: +65 6839 292-0
Telefax: +65 6839 292-1
E-Mail: sales@pilz.sg
Internet: www.pilz.sg

SK

Pilz Slovakia s.r.o.
Štúrova 101
05921 Svit
Slovakia
Telephone: +421 52 7152601
E-Mail: info@pilzsklovakia.sk
Internet: www.pilzsklovakia.sk

TH

Pilz South East Asia Pte. Ltd.
25 International Business Park
#04-56 German Centre
Singapore 609916
Singapore
Telephone: +65 6839 292-0
Telefax: +65 6839 292-1
E-Mail: sales@pilz.sg
Internet: www.pilz.sg

TR

Pilz Emniyet Otomasyon
Ürünleri ve Hizmetleri Tic. Ltd. Şti.
Kayışdağı Mahallesi Dudullu Yolu Cad.
Mecnun Sok. Duru Plaza No:7
34755 Ataşehir/İstanbul
Turkey
Telephone: +90 216 5775550
Telefax: +90 216 5775549
E-Mail: info@pilz.com.tr
Internet: www.pilz.com.tr

TW

Pilz Taiwan Ltd.
7F.-3, No. 146, Songjiang Rd.
Zhongshan Dist., Taipei City 104
Taiwan
Telephone: +886 2 2568 1680
Telefax: +886 2 2568 1600
E-Mail: info@pilz.tw
Internet: www.pilz.tw

US

Pilz Automation Safety L.P.
7150 Commerce Boulevard
Canton
Michigan 48187
USA
Telephone: +1 734 354 0272
Telefax: +1 734 354 3355
E-Mail: info@pilzusa.com
Internet: www.pilz.us

VN

Pilz South East Asia Pte. Ltd.
25 International Business Park
#04-56 German Centre
Singapore 609916
Singapore
Telephone: +65 6839 292-0
Telefax: +65 6839 292-1
E-Mail: sales@pilz.sg
Internet: www.pilz.sg

► Support

Technical support is available from Pilz round the clock.

Americas

Brazil
+55 11 97569-2804

Canada
+1 888-315-PILZ (315-7459)

Mexico
+52 55 5572 1300

USA (toll-free)
+1 877-PILZUSA (745-9872)

Asia

China
+86 21 60880878-216

Japan
+81 45 471-2281

South Korea
+82 31 450 0680

Australia

+61 3 95600621

Europe

Austria
+43 1 7986263-0

Belgium, Luxembourg
+32 9 3217575

France
+33 3 88104000

Germany
+49 711 3409-444

Ireland
+353 21 4804983

Italy, Malta
+39 0362 1826711

Scandinavia

+45 74436332

Spain

+34 938497433

Switzerland

+41 62 88979-30

The Netherlands

+31 347 320477

Turkey

+90 216 5775552

United Kingdom

+44 1536 462203

You can reach our international hotline on:

+49 711 3409-444
support@pilz.com

Pilz develops environmentally-friendly products using ecological materials and energy-saving technologies. Offices and production facilities are ecologically designed, environmentally-aware and energy-saving. So Pilz offers sustainability, plus the security of using energy-efficient products and environmentally-friendly solutions.



Presented by:

Pilz Automation Safety, L.P.
7150 Commerce Blvd.
Canton, MI 48187
Tel.: +1 (734) 354-0272
Fax: +1 (734) 354-3355
info@pilzusa.com
www.pilz.us

In many countries we are represented by sales partners. Please refer to our homepage www.pilz.com for further details or contact our headquarters.



7-4-us-3-018, 2017-05
© Pilz GmbH & Co. KG, 2017

CMSE®, InduraNET, p®, PAS4000®, PASscal®, PASconfig®, Pilz®, PIT®, PLUD®, PMCPromo®, PMCProtecto®, PMClendo®, PMD®, PMI®, PNOZ®, Primo®, PSEN®, PSS®, PVS®, SafetyBUS p®, SafetyYE®, SafetyNET p®, THE SPIRIT OF SAFETY® are registered and protected trademarks of Pilz GmbH & Co. KG in some countries. We would point out that product features may vary from the details stated in this document, depending on the status at the time of publication and the scope of the equipment. We accept no responsibility for the validity, accuracy and entirety of the text and graphics presented in this information. Please contact our Technical Support if you have any questions.