

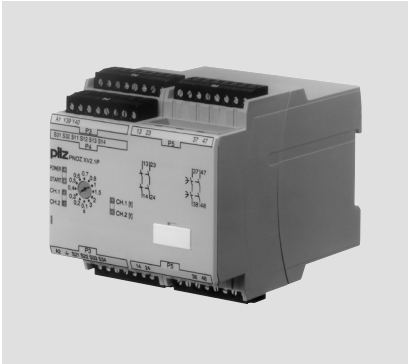



Up to Category 4, EN 954-1 PNOZ XV2.1P



Safety relay for monitoring E-STOP pushbuttons and safety gates.

Approvals

PNOZ XV2.1P	
	◆
	◆
	◆

Unit features

- ▶ Positive-guided relay outputs:
 - 2 safety contacts (N/O), instantaneous
 - 2 safety contacts (N/O), delay-on de-energisation
- ▶ Connection options for:
 - E-STOP pushbutton
 - Safety gate limit switch
 - Reset button
- ▶ Delay time can be cancelled via reset button
- ▶ Delay-on de-energisation, fixed or selectable
- ▶ LED indicator for:
 - Switch status channel 1/2
 - Supply voltage
 - Reset circuit
- ▶ See order reference for unit types

The max. category the safety contacts can achieve in accordance with EN 954-1 is stated in the technical details.

Safety features

The relay conforms to the following safety criteria:

- ▶ The circuit is redundant with built-in self-monitoring.
- ▶ The safety function remains effective in the case of a component failure.
- ▶ The correct opening and closing of the safety function relays is tested automatically in each on-off cycle.
- ▶ The unit has an electronic fuse.

Unit description

The safety relay meets the requirements of EN 60204-1 and IEC 60204-1 and may be used in applications with

- ▶ E-STOP pushbuttons
- ▶ Safety gates

Block diagram

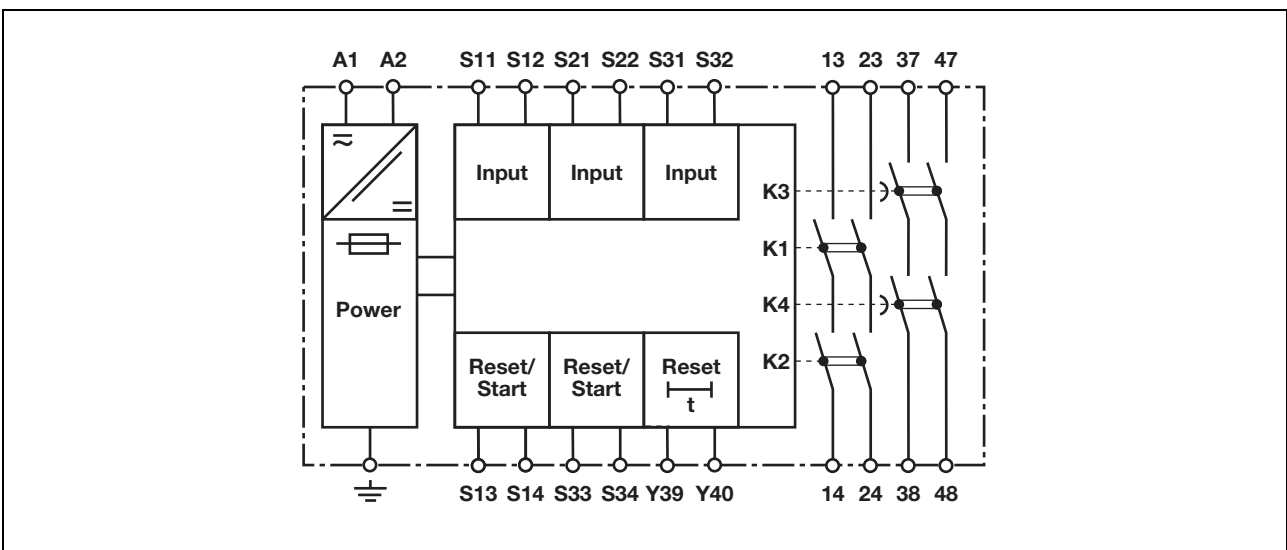

Up to Category 4, EN 954-1 PNOZ XV2.1P

Function description

- ▶ Single-channel operation: no redundancy in the input circuit, earth faults in the reset and input circuit are detected.
- ▶ Dual-channel operation with detection of shorts across contacts: redundant input circuit, detects
 - earth faults in the reset and input circuit,
 - short circuits in the input circuit and, with a monitored reset, in the reset circuit too,
 - shorts between contacts in the input circuit.
- ▶ Automatic start: Unit is active once the input circuit has been closed.
- ▶ Monitored reset: Unit is active once the input circuit is closed and once the reset circuit is closed after the waiting period has elapsed (see technical details).
- ▶ Increase in the number of available contacts by connecting contact expander modules or external contactors/relays.

Timing diagram

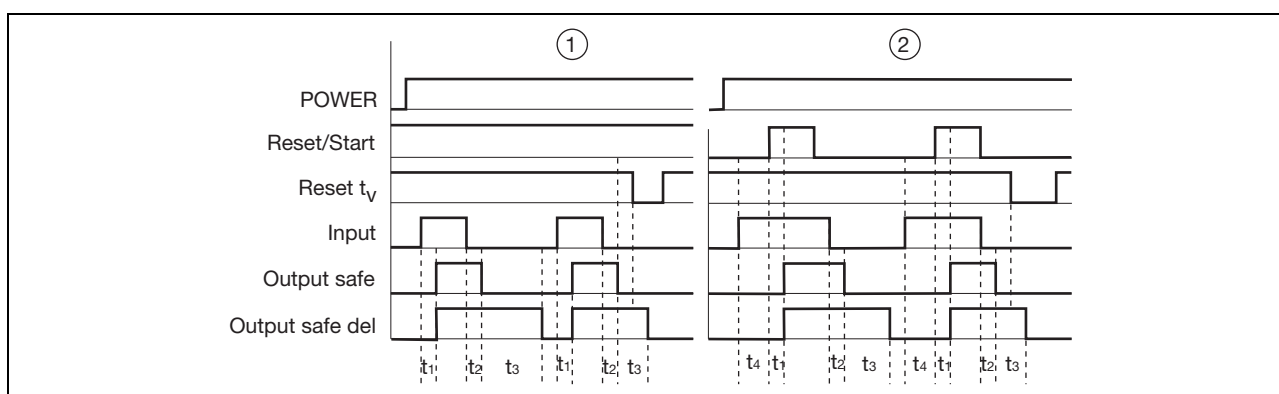

Key

- ▶ Power: Supply voltage
- ▶ Reset/start: Reset circuit S13-S14, S33-S34
- ▶ Reset t_v : Y39-Y40
- ▶ Input: Input circuits S11-S12, S21-S22, S31-S32
- ▶ Output safe: Safety contacts, instantaneous 13-14, 23-24
- ▶ Output safe del: Safety contacts, delayed 37-38, 47-48
- ▶ ①: Automatic reset
- ▶ ②: Monitored reset
- ▶ t_1 : Switch-on delay
- ▶ t_2 : Delay-on de-energisation
- ▶ t_3 : Delay time
- ▶ t_4 : Waiting period

Wiring

Please note:

- ▶ Information given in the “Technical details” must be followed.
- ▶ Outputs 13-14, 23-24 are instantaneous safety contacts, outputs 37-38, 47-48 are delay-on de-energisation safety contacts.
- ▶ To prevent contact welding, a fuse should be connected before the output contacts (see technical details).
- ▶ Calculation of the max. cable runs l_{max} in the input circuit:

$$l_{max} = \frac{R_{lmax}}{R_l / km}$$

R_{lmax} = max. overall cable resistance (see technical details)

R_l / km = cable resistance/km

- ▶ Use copper wire that can withstand 60/75 °C.

- ▶ Sufficient fuse protection must be provided on all output contacts with capacitive and inductive loads.

Up to Category 4, EN 954-1 PNOZ XV2.1P

Preparing for operation

► Supply voltage

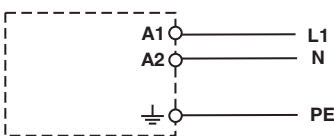
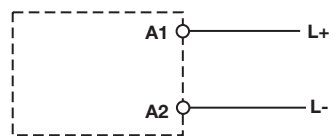
Supply voltage	AC	DC
		

► Input circuit

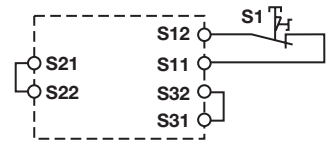
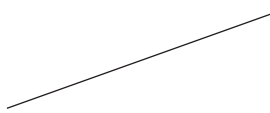
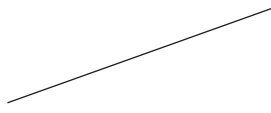
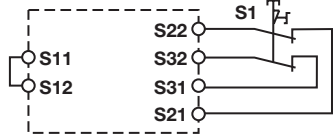
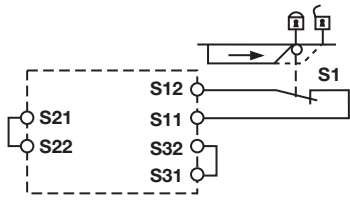
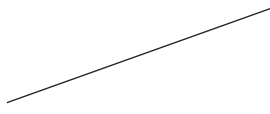
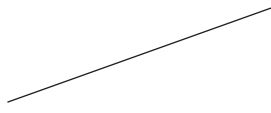
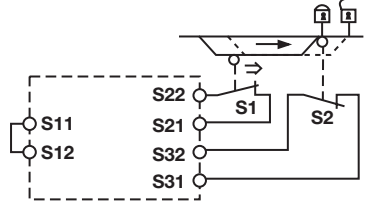
Input circuit	Single-channel	Dual-channel
E-STOP without detection of shorts across contacts		
E-STOP with detection of shorts across contacts		
Safety gate without detection of shorts across contacts		
Safety gate with detection of shorts across contacts		

Up to Category 4, EN 954-1 PNOZ XV2.1P

▶ Reset circuit

Reset circuit	E-STOP wiring (single-channel) Safety gate (single-channel)	E-STOP wiring (dual-channel) Safety gate (dual-channel)
Automatic reset		
Monitored reset		



▶ Reset

Feedback loop	Automatic reset	Monitored reset
Link or N/C contact		

▶ Feedback loop

Feedback loop	Automatic reset	Monitored reset
Contacts from external contactors		

▶ Key

S1/S2	E-STOP pushbutton/ safety gate switch
S3	Reset button
	Switch operated
	Gate open
	Gate closed

Up to Category 4, EN 954-1 PNOZ XV2.1P

Terminal configuration

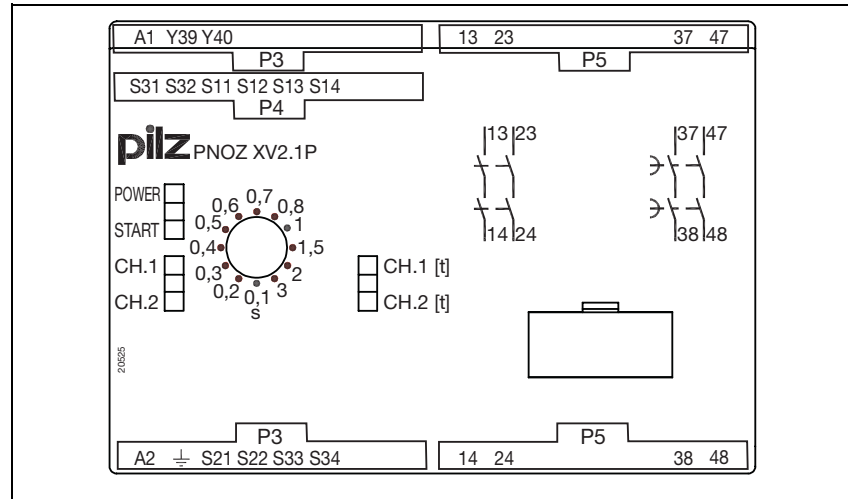

Installation

- ▶ The safety relay should be installed in a control cabinet with a protection type of at least IP54.
- ▶ Use the notch on the rear of the unit to attach it to a DIN rail.
- ▶ Ensure the unit is mounted securely on a vertical DIN rail (35 mm) by using a fixing element (e.g. retaining bracket or an end angle).

Dimensions

* with cage clamp terminals

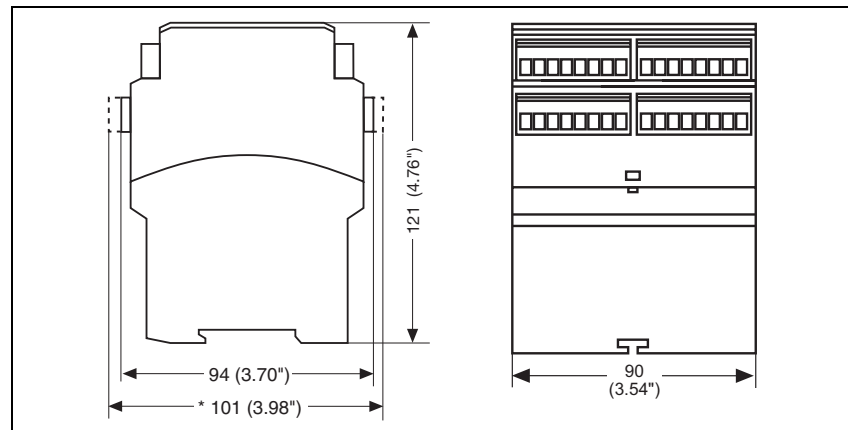

Up to Category 4, EN 954-1 PNOZ XV2.1P

Notice

This data sheet is only intended for use during configuration. For installation and operation, please refer to the operating instructions supplied with the unit.

Service life graph

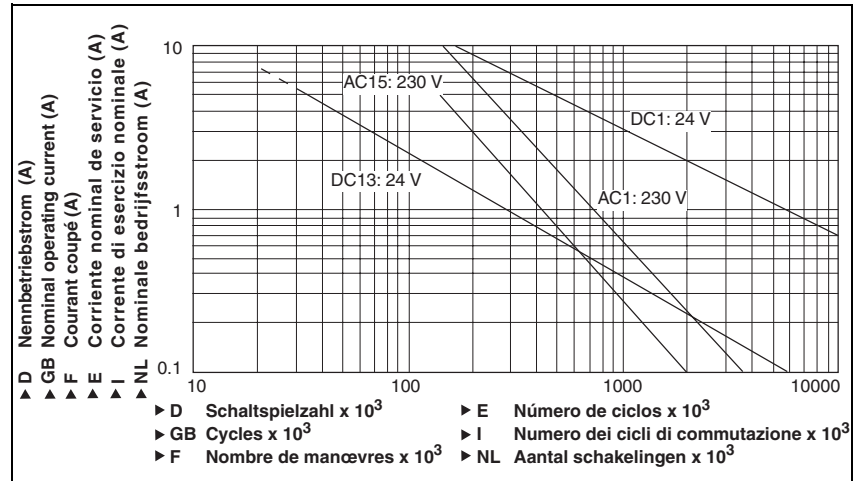

Technical details

Electrical data

Supply voltage	
Supply voltage U_B AC/DC	24 - 240 V
Voltage tolerance	-15 %/+10 %
Power consumption at U_B AC	8.5 VA
Power consumption at U_B DC	5.0 W
Frequency range AC	50 - 60 Hz
Residual ripple DC	160 %
Voltage and current at	
input circuit DC: 24.0 V	35.0 mA
reset circuit DC: 24.0 V	30.0 mA
feedback loop DC: 24.0 V	3.1 mA
Output contacts in accordance with EN 954-1 Category 4	Safety contacts (N/O): 2
Output contacts in accordance with EN 954-1 Category 3	Safety contacts (N/O), delayed: 2
Category 1 Order no.: 777540, 777548, 787540, 787548	Delay time <30 s
	Delay time >30 s
Utilisation category in accordance with EN 60947-4-1	
Safety contacts: AC1 at 240 V	I_{min} : 0.01 A , I_{max} : 8.00 A P_{max} : 2000 VA
Safety contacts: DC1 at 24 V	I_{min} : 0.01 A , I_{max} : 8.0 A P_{max} : 200 W
Safety contacts, delayed: AC1 at 240 V	I_{min} : 0.01 A , I_{max} : 8.0 A P_{max} : 2000 VA
Safety contacts, delayed: DC1 at 24 V	I_{min} : 0.01 A , I_{max} : 8.0 A P_{max} : 200 W
Utilisation category in accordance with EN 60947-5-1	
Safety contacts: AC15 at 230 V	I_{max} : 5.0 A
Safety contacts: DC13 at 24 V (6 cycles/min)	I_{max} : 7.0 A
Safety contacts, delayed: AC15 at 230 V	I_{max} : 5.0 A
Safety contacts, delayed: DC13 at 24 V (6 cycles/min)	I_{max} : 7.0 A
Contact material	AgSnO2 + 0.2 µm Au

Up to Category 4, EN 954-1 PNOZ XV2.1P

Electrical data	
External contact fuse protection to EN 60947-5-1	
Blow-out fuse, quick	
Safety contacts:	10 A
Safety contacts, delayed:	10 A
Blow-out fuse, slow	
Safety contacts:	6 A
Safety contacts, delayed:	6 A
Circuit breaker 24 VAC/DC, characteristic B/C	
Safety contacts:	6 A
Safety contacts, delayed:	6 A
Max. overall cable resistance R_{lmax} input circuits, reset circuits	
single-channel at U_B DC	200 Ohm
single-channel at U_B AC	200 Ohm
dual-channel with detect. of shorts across contacts at U_B DC	20 Ohm
dual-channel with detect. of shorts across contacts at U_B AC	20 Ohm
Times	
Switch-on delay	
with automatic reset typ.	400 ms
with automatic reset max.	550 ms
with automatic reset after power on typ.	625 ms
with automatic reset after power on max.	870 ms
with monitored reset typ.	35 ms
with monitored reset max.	60 ms
Delay-on de-energisation	
with E-STOP typ.	15 ms
with E-STOP max.	30 ms
with power failure typ. $U_B = 24$ V DC	120 ms
with power failure max. $U_B = 24$ V DC	500 ms
with power failure typ. $U_B = 240$ VAC	900 ms
with power failure max. $U_B = 240$ VAC	2200 ms
Recovery time at max. switching frequency 1/s after E-STOP	
after power failure on universal power supply	50 ms +tv
Delay time t_V : selectable	2250 ms
	0.00 s; 0.50 s; 1.00 s; 2.00 s; 4.00 s; 6.00 s; 8.00 s; 10.00 s; 15.00 s; 20.00 s; 25.00 s; 30.00 s Order no.: 777540
	0.10 s; 0.20 s; 0.30 s; 0.40 s; 0.50 s; 0.60 s; 0.70 s; 0.80 s; 1.00 s; 1.50 s; 2.00 s; 3.00 s Order no.: 777542
	0.00 s; 5.00 s; 10.00 s; 20.00 s; 40.00 s; 60.00 s; 80.00 s; 100.00 s; 150.00 s; 200.00 s; 250.00 s; 300.00 s Order no.: 777548
	0.00 s; 0.50 s; 1.00 s; 2.00 s; 4.00 s; 6.00 s; 8.00 s; 10.00 s; 15.00 s; 20.00 s; 25.00 s; 30.00 s Order no.: 787540
	0.10 s; 0.20 s; 0.30 s; 0.40 s; 0.50 s; 0.60 s; 0.70 s; 0.80 s; 1.00 s; 1.50 s; 2.00 s; 3.00 s Order no.: 787542
	0.00 s; 5.00 s; 10.00 s; 20.00 s; 40.00 s; 60.00 s; 80.00 s; 100.00 s; 150.00 s; 200.00 s; 250.00 s; 300.00 s Order no.: 787548
Delay time t_V : fixed	0.50 s Order no.: 777544
	10.00 s Order no.: 777547
	3.00 s Order no.: 777545
Repetition accuracy	2 %
Time accuracy	-15 %/+15 % +50 ms
Waiting period with a monitored reset	300 ms
Min. start pulse duration with a monitored reset	30 ms
Simultaneity, channel 1 and 2	∞
Supply interruption before de-energisation	20 ms
Environmental data	
EMC	EN 60947-5-1, EN 61000-6-2, EN 61000-6-4

Up to Category 4, EN 954-1 PNOZ XV2.1P

Environmental data	
Vibration in accordance with EN 60068-2-6	
Frequency	10 - 55 Hz
Amplitude	0.35 mm
Climatic suitability	EN 60068-2-78
Airgap creepage	VDE 0110-1
Ambient temperature	-10 - 55 °C
Storage temperature	-40 - 85 °C
Protection type	
Mounting (e.g. control cabinet)	IP54
Housing	IP40
Terminals	IP20
Mechanical data	
Housing material	
Housing	PPO UL 94 V0
Front	ABS UL 94 V0
Max. cross section of external conductors with screw terminals	
1 core flexible	0.25 - 2.50 mm², 24 - 12 AWG Order no.: 777540, 777542, 777544, 777545, 777547, 777548
2 core, same cross section, flexible: with crimp connectors, without insulating sleeve	0.25 - 1.00 mm², 24 - 16 AWG Order no.: 777540, 777542, 777544, 777545, 777547, 777548
without crimp connectors or with TWIN crimp connectors	0.20 - 1.50 mm², 24 - 16 AWG Order no.: 777540, 777542, 777544, 777545, 777547, 777548
Torque setting with screw terminals	0.50 Nm Order no.: 777540, 777542, 777544, 777545, 777547, 777548
Max. cross section of external conductors with cage clamp terminals: flexible without crimp connectors	0.20 - 1.50 mm², 24 - 16 AWG Order no.: 787540, 787542, 787548
Cage clamp terminals: terminal points per connection	2 Order no.: 787540, 787542, 787548
Stripping length	8 mm Order no.: 787540, 787542, 787548
Dimensions	
Height	101.0 mm Order no.: 787540, 787542, 787548 94.0 mm Order no.: 777540, 777542, 777544, 777545, 777547, 777548
Width	90.0 mm
Depth	121.0 mm
Weight	550 g Order no.: 777544, 777545, 777547, 787540, 787542, 787548 560 g Order no.: 777540, 777542, 777548

The standards current on **04/03** apply.

Max. continuous current		
Number of contacts	I_{max} (A) at U_B DC	I_{max} (A) at U_B AC
1	8.00 A	8.00 A
2	7.00 A	7.00 A
3	5.70 A	5.70 A
4	5.00 A	5.00 A

Order reference				
Type	Features		Terminals	Order no.
PNOZ XV2.1P C	24 - 240 VAC/DC	3 s selectable	Cage clamp terminals	787 542
PNOZ XV2.1P	24 - 240 VAC/DC	3 s selectable	Screw terminals	777 542
PNOZ XV2.1P C	24 - 240 VAC/DC	30 s selectable	Cage clamp terminals	787 540

Up to Category 4, EN 954-1 PNOZ XV2.1P

Type	Features		Terminals	Order no.
PNOZ XV2.1P	24 - 240 VAC/DC	30 s selectable	Screw terminals	777 540
PNOZ XV2.1P C	24 - 240 VAC/DC	300 s selectable	Cage clamp terminals	787 548
PNOZ XV2.1P	24 - 240 VAC/DC	300 s selectable	Screw terminals	777 548
PNOZ XV2.1P	24 - 240 VAC/DC	0.5 s fixed	Screw terminals	777 544
PNOZ XV2.1P	24 - 240 VAC/DC	3 s fixed	Screw terminals	777 545
PNOZ XV2.1P	24 - 240 VAC/DC	10 s fixed	Screw terminals	777 547