

1

2

3

4

5

6

7

8

A

B

C

D

E

F

A

B

C

D

E

F

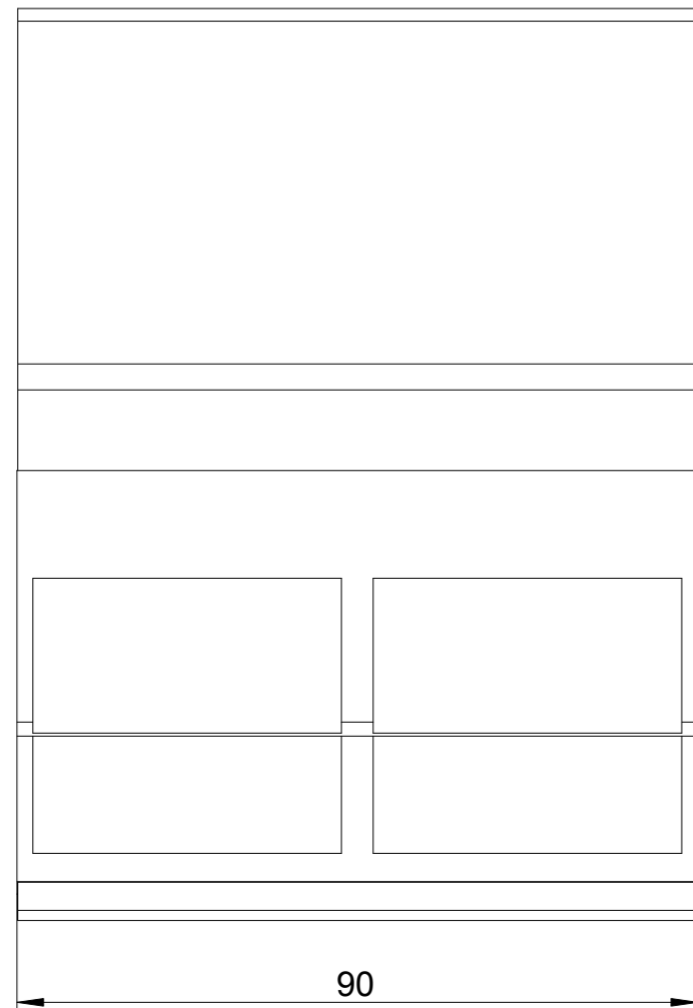
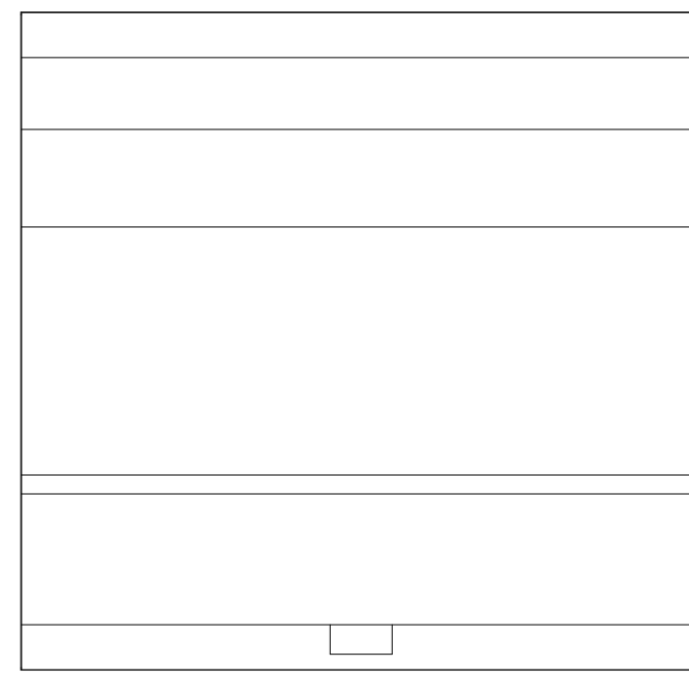
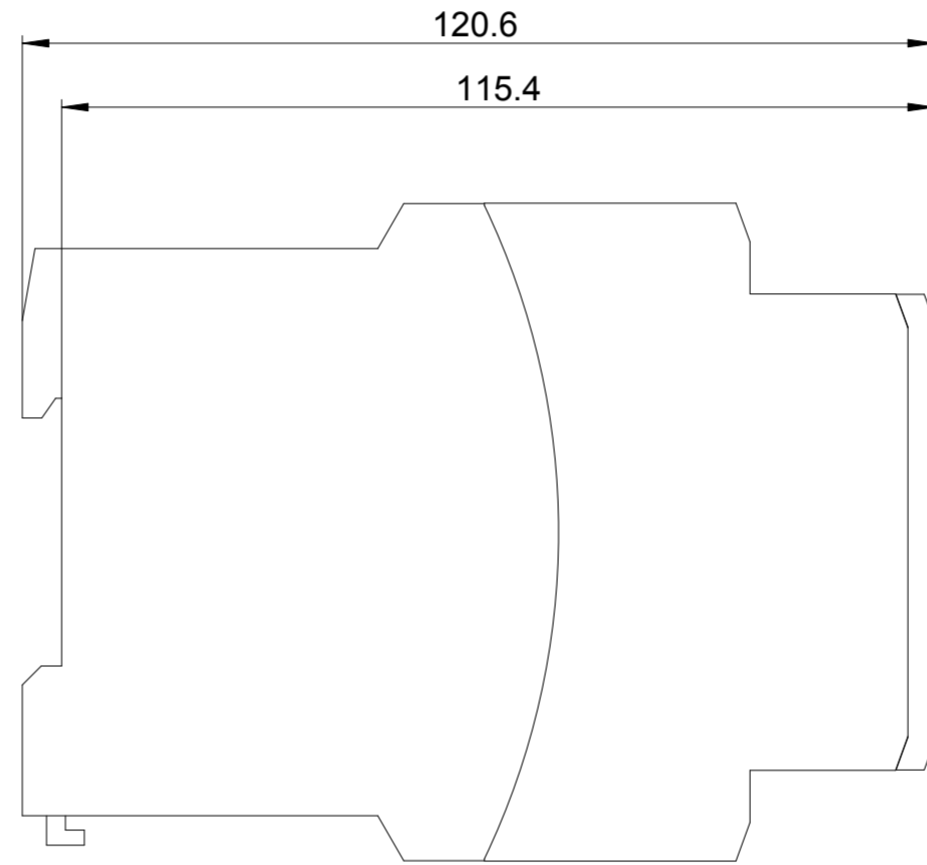
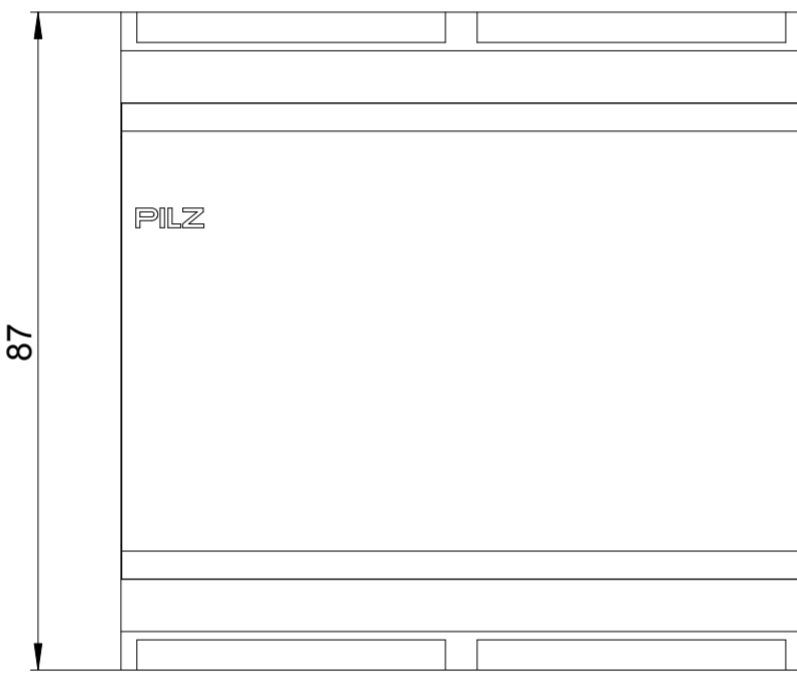
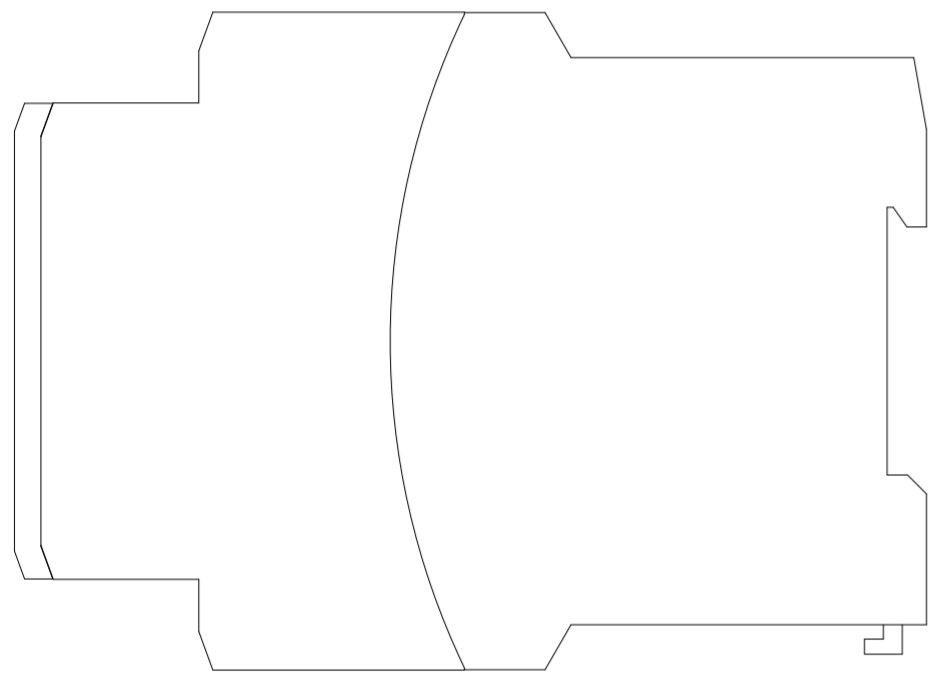
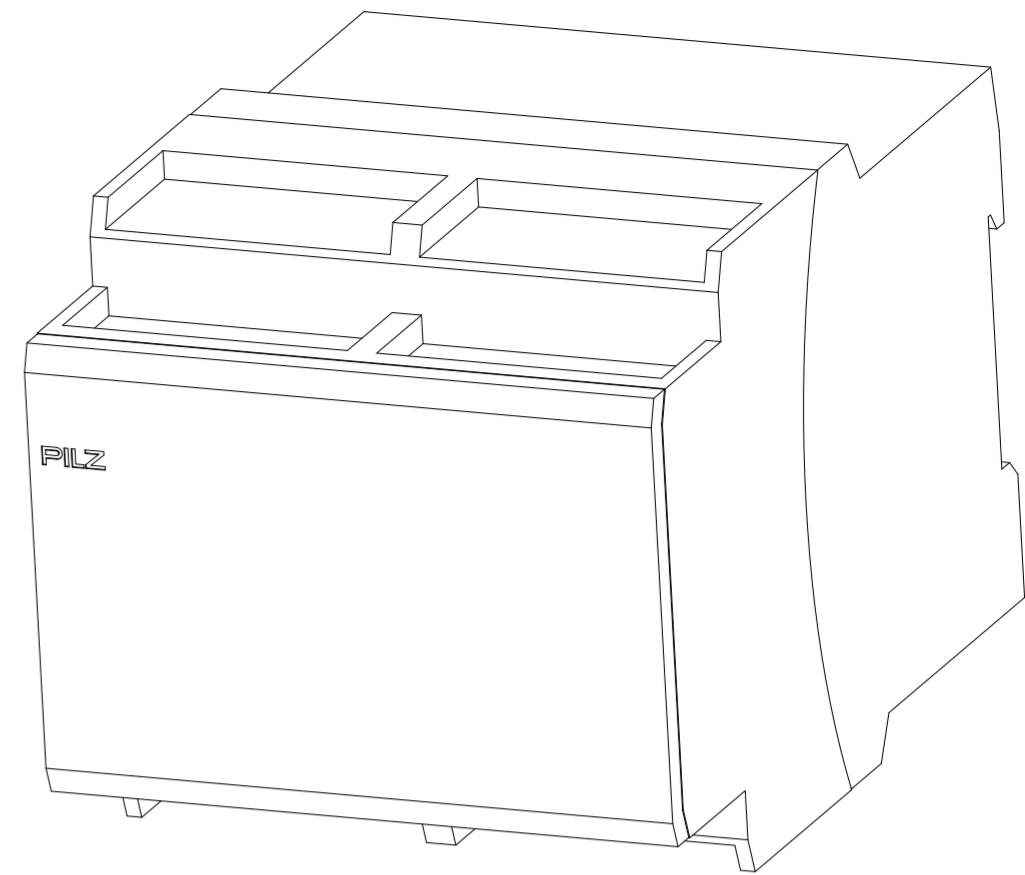
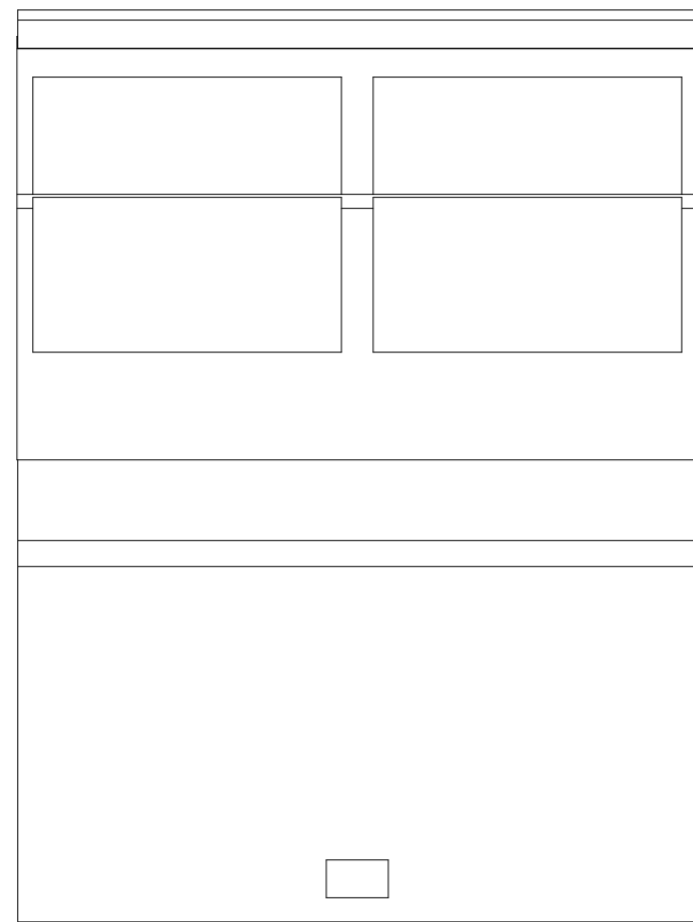

-	20170155	10.10.2017	PD-SUP-MCPD-SUP-MD	Neue Zeichnung. New drawing.		
Index	ECO no.	Date	Editor	Checked		
Scale	1:1			Date	Name	MODEL: 2025114 DRW: 2025115
Material			Created	10.10.2017	PD-SUP-MD	Internet Dokumente Internet documents P99/90
			Checked	10.10.2017	PD-SUP-MD	
			Norm	-	-	
Surface			All dimensions are in mm			
			Unspecified tolerance			Doc.-No. 2025115 Page 1
					Mat.-No. -	of 1

Refer to protection notice ISO 18016

