



PDP20 F 4 mag

PILZ
THE SPIRIT OF SAFETY

- ▶ Decentralised periphery

This document is the original document.

Where unavoidable, for reasons of readability, the masculine form has been selected when formulating this document. We do assure you that all persons are regarded without discrimination and on an equal basis.

All rights to this documentation are reserved by Pilz GmbH & Co. KG. Copies may be made for the user's internal purposes. Suggestions and comments for improving this documentation will be gratefully received.

Pilz®, PIT®, PMI®, PNOZ®, Primo®, PSEN®, PSS®, PVIS®, SafetyBUS p®, SafetyEYE®, SafetyNET p®, the spirit of safety® are registered and protected trademarks of Pilz GmbH & Co. KG in some countries.



SD means Secure Digital

Introduction	4
Validity of documentation	4
Using the documentation	4
Definition of symbols	4
Safety	5
Intended use	5
Safety regulations	6
Safety assessment	6
Use of qualified personnel	6
Warranty and liability	6
Disposal	6
For your safety	7
Unit features	7
Block diagram	7
Function description	8
Timing diagram	9
Installation	9
Wiring	10
Permitted sensors from Pilz	10
Preparing for operation	11
Operation	12
Status indicator	13
Fault indicator	13
Technical details	14
Safety characteristic data	16
Order reference	17
Product	17
Accessories	17
EC declaration of conformity	17
UKCA-Declaration of Conformity	17

Introduction

Validity of documentation

This documentation is valid for the product PDP20 F 4 mag. It is valid until new documentation is published.

This operating manual explains the function and operation, describes the installation and provides guidelines on how to connect the product.

Using the documentation

This document is intended for instruction. Only install and commission the product if you have read and understood this document. The document should be retained for future reference.

Definition of symbols

Information that is particularly important is identified as follows:



DANGER!

This warning must be heeded! It warns of a hazardous situation that poses an immediate threat of serious injury and death and indicates preventive measures that can be taken.



WARNING!

This warning must be heeded! It warns of a hazardous situation that could lead to serious injury and death and indicates preventive measures that can be taken.



CAUTION!

This refers to a hazard that can lead to a less serious or minor injury plus material damage, and also provides information on preventive measures that can be taken.



NOTICE

This describes a situation in which the product or devices could be damaged and also provides information on preventive measures that can be taken. It also highlights areas within the text that are of particular importance.

**INFORMATION**

This gives advice on applications and provides information on special features.

Safety**Intended use**

The sensor interface PDP20 F 4 mag enables up to 4 sensors to be connected in series, and connection to an evaluation device.

Permitted sensors are sensors with a N/O / N/O combination and the Pilz sensors listed in the section entitled "Permitted sensors from Pilz".

The sensor interface meets the requirements in accordance with:

- ▶ EN 60204-1
- ▶ EN 60947-5-3
- ▶ EN 62061: up to max. SIL CL 3
- ▶ EN ISO 13849-1: up to max. PL e

If multiple sensor interfaces PDP20 F 4 mag are connected in series, 3 additional sensors per sensor interface may be connected in series.

Improper use

The following is deemed improper use in particular

- ▶ Any component, technical or electrical modification to the product,
- ▶ Use of the product outside the areas described in this operating manual,
- ▶ Use of the product outside the technical details (see [Technical details](#)  14]).

**NOTICE****EMC-compliant electrical installation**

The product is designed for use in an industrial environment. The product may cause interference if installed in other environments. If installed in other environments, measures should be taken to comply with the applicable standards and directives for the respective installation site with regard to interference.

Safety regulations

Safety assessment

Before using a device, a safety assessment in accordance with the Machinery Directive is required.

The product as an individual component fulfils the functional safety requirements in accordance with EN ISO 13849 and EN 62061. However, this does not guarantee the functional safety of the overall plant/machine. To achieve the relevant safety level of the overall plant/machine's required safety functions, each safety function needs to be considered separately.

Use of qualified personnel

The products may only be assembled, installed, programmed, commissioned, operated, maintained and decommissioned by persons who are competent to do so.

A competent person is a qualified and knowledgeable person who, because of their training, experience and current professional activity, has the specialist knowledge required. To be able to inspect, assess and operate devices, systems and machines, the person has to be informed of the state of the art and the applicable national, European and international laws, directives and standards.

It is the company's responsibility only to employ personnel who

- ▶ Are familiar with the basic regulations concerning health and safety / accident prevention,
- ▶ Have read and understood the information provided in the section entitled Safety
- ▶ Have a good knowledge of the generic and specialist standards applicable to the specific application.

Warranty and liability

All claims to warranty and liability will be rendered invalid if

- ▶ The product was used contrary to the purpose for which it is intended,
- ▶ Damage can be attributed to not having followed the guidelines in the manual,
- ▶ Operating personnel are not suitably qualified,
- ▶ Any type of modification has been made (e.g. exchanging components on the PCB boards, soldering work etc.).

Disposal

- ▶ In safety-related applications, please comply with the mission time T_M in the safety-related characteristic data.
- ▶ When decommissioning, please comply with local regulations regarding the disposal of electronic devices (e.g. Electrical and Electronic Equipment Act).

For your safety

The unit meets all the necessary conditions for safe operation. However, please note the following:

- ▶ Note for overvoltage category III: If voltages higher than low voltage (>50 VAC or >120 VDC) are present on the unit, connected control elements and sensors must have a rated insulation voltage of at least 250 V.

Unit features

- ▶ Connection of 4 sensors with a N/O / N/O combination
- ▶ 2 safety outputs
- ▶ 1 signal output
- ▶ LED display for:
 - State of the outputs
 - State of the inputs
 - Operational readiness
- ▶ Multiple PDP20 F 4 mag may be connected in series
- ▶ Plug-in connection terminals:
 - Either spring-loaded terminal or screw terminal available as an accessory (see [order reference](#) [ 17])

Block diagram

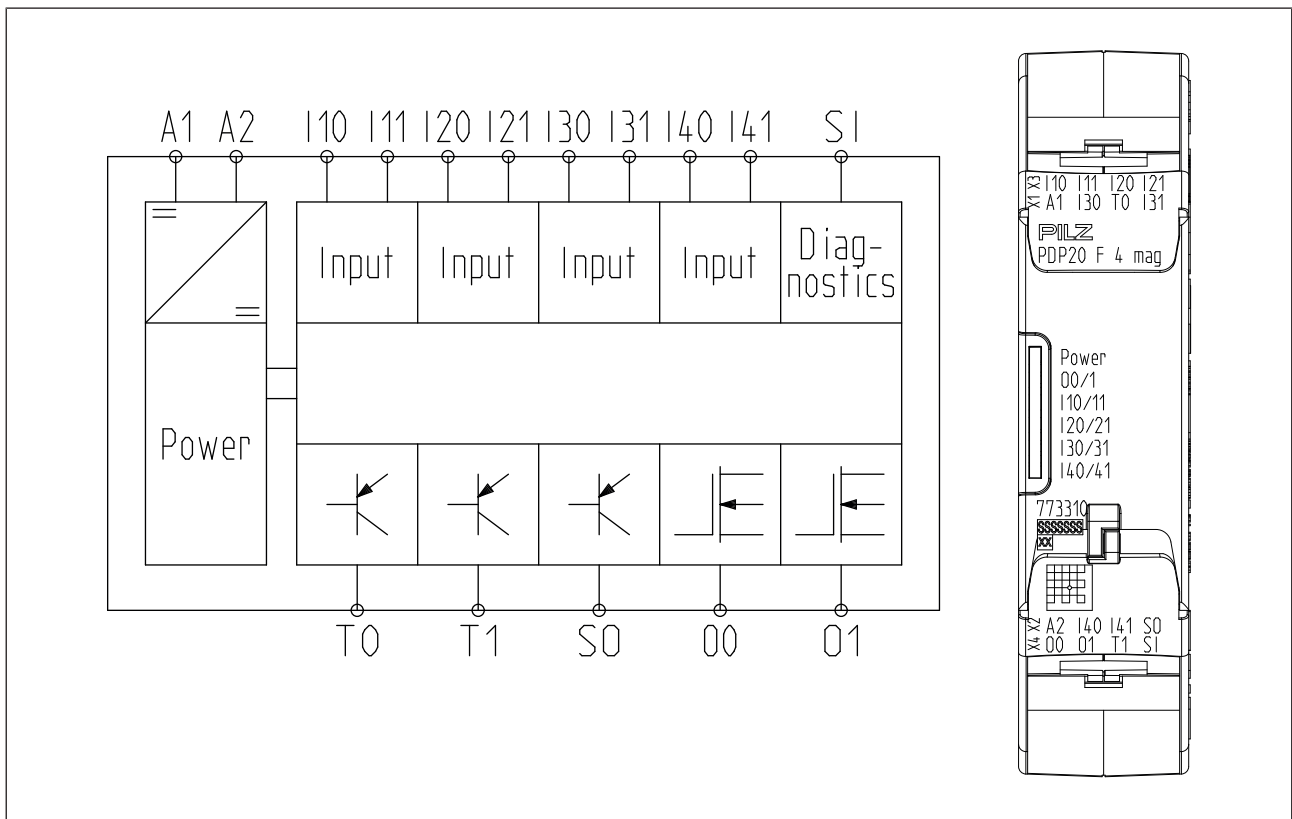

Function description

The inputs of the PDP20 F 4 mag are AND-linked. The result of the logic AND operation is expressed via safety outputs O0 and O1.

A signal output (SO) indicates the state of the sensors.

Safety outputs

- ▶ There is a high signal at safety outputs O0, O1 when all the input circuits I10 ... I41 are closed.
- ▶ If at least one of the input circuits is open or a sensor is partially operated, the safety outputs will switch to a low signal.

Signal Output

- ▶ There is a high signal at the signal output SO when the connected sensors are operated (N/O contact closed).
- ▶ If at least one of the sensors is not operated or is partially operated, the signal output SO will switch to a low signal.

Detection of shorts across contacts

2 test pulse outputs T0 and T1 enable shorts across contacts to be detected at the inputs. The two test pulse outputs are permanently assigned to the inputs. If the test pulses are swapped or there is a short circuit at the inputs, the device switches off the safety outputs safely (low signal) and registers an error.

Series connection

The safety outputs of a PDP20 F 4 mag may be connected to the cascading inputs I40 - I41 on another PDP20 F 4 mag. 3 additional sensors may be AND-linked via this device. In the event of a short across the contacts, the safety outputs will be switched off safely (low signal).

Input SI

The input SI is reserved for future functions and may not be used.

Timing diagram

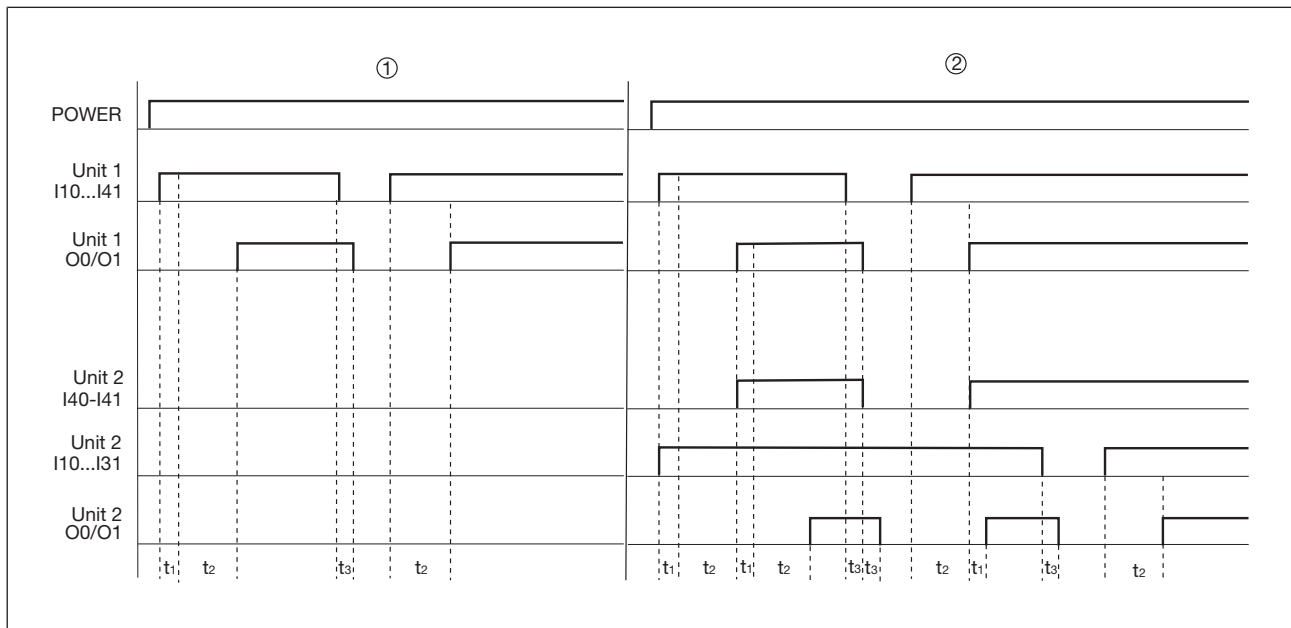

Legend

- ▶ ①: Single connection with Unit 1
- ▶ ②: Series connection of Unit 1 and Unit 2
- ▶ Power: Supply voltage
- ▶ Unit 1, I10 ... I41: Input circuits of Unit 1
- ▶ Unit 1, O0/O1: Safety outputs of Unit 1
- ▶ Unit 2, I40- I41: Cascading input of Unit 2
- ▶ Unit 2, I10 ... I31: Input circuits of Unit 2
- ▶ Unit 2, O0/O1: Safety outputs of Unit 2
- ▶ t_1 : Max. processing time for input when signal changes from "0" to "1"
- ▶ t_2 : Typ. switch-on delay
- ▶ t_3 : Max. processing time for semiconductor output when signal changes from "1" to "0"

Installation

- ▶ The unit should be installed in a control cabinet with a protection type of at least IP54.
- ▶ Use the notch on the rear of the unit to attach it to a DIN rail (35mm).
- ▶ When installed vertically: Secure the unit by using a fixing element (e.g. retaining bracket or end angle)
- ▶ Push the device upwards or downwards before lifting it from the DIN rail.

Wiring

Please note:

- ▶ Information given in the "[Technical details \[14\]](#)" must be followed.
- ▶ Calculation of the max. cable length l_{\max} in the input circuit:

$$l_{\max} = \frac{R_{l_{\max}}}{R_l / \text{km}}$$

$R_{l_{\max}}$ = max. overall cable resistance (see [Technical details \[14\]](#))
 R_l / km = cable resistance/km

- ▶ Use copper wiring with a temperature stability of 75 °C.
- ▶ To prevent EMC interferences (particularly common-mode interferences) the measures described in EN 60204-1 must be executed. This includes the separate routing of cables of the control circuits (input, start and feedback loop) from other cables for energy transmission or the shielding of cables, for example.
- ▶ The power supply must comply with the regulations for extra low voltages with protective electrical separation (SELV, PELV) in accordance with VDE 0100, Part 410.
- ▶ 1 wire may be connected per terminal. Use a terminal block if you need multiple connections per terminal.

Permitted sensors from Pilz

- ▶ PSENmag:
 - PSEN 1.1p-10, PSEN 1.1p-20
 - PSEN ma1.3-20 M12, PSEN ma1.3a-20, PSEN ma1.3b-20, PSEN ma1.3b-23, PSEN ma1.3n-20, PSEN ma1.3p-20
 - PSEN ma1.4-51 M12, PSEN ma1.4a-50, PSEN ma1.4a-51, PSEN ma1.4n-50, PSEN ma1.4n-51, PSEN ma1.4p-50, PSEN ma1.4p-51
- ▶ PSENhinge
 - PSEN hs1.1p
 - PSEN hs1.2p
- ▶ PSENRope
 - PSEN rs1.0
 - PSEN rs2.0
- ▶ PITestop
 - PIT es Set1s-5, PIT es Set1s-5c, PIT es Set1s-5ns
 - PIT esc1, PIT esc1c, PIT esc2, PIT esc2c

Preparing for operation

Single connection

X1: Terminal block

Grey area: Control cabinet

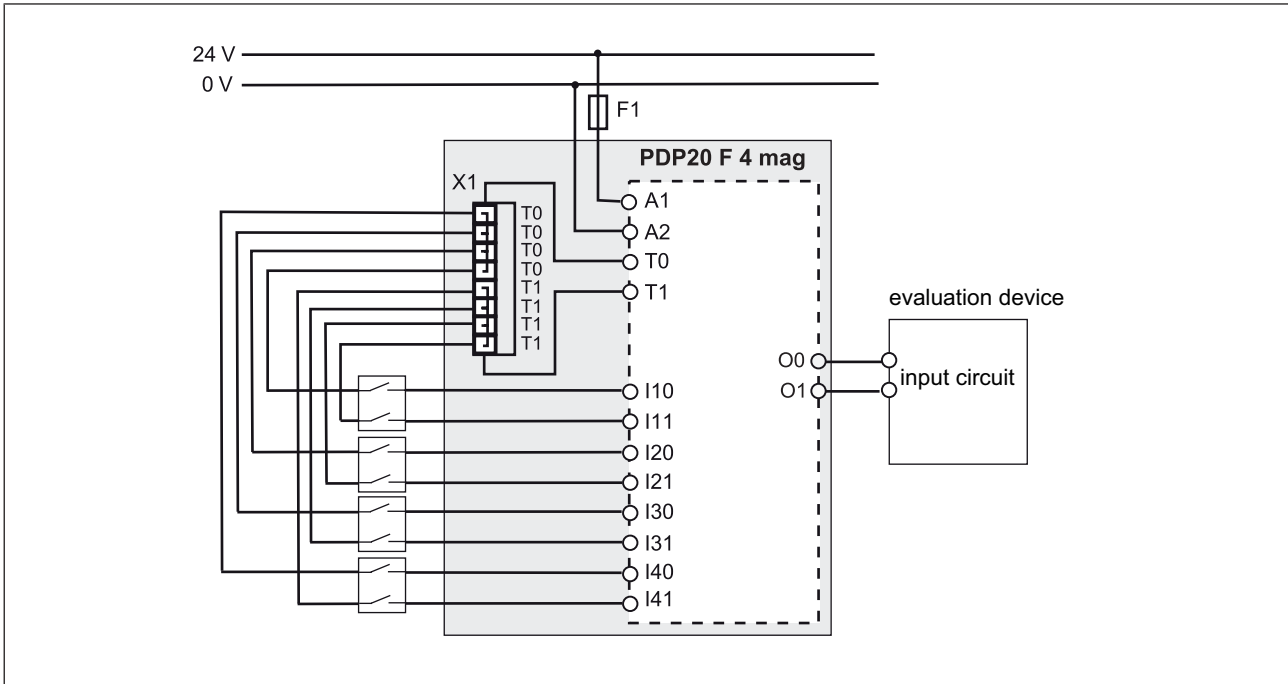

NOTICE

- The test pulses are permanently assigned to the inputs (T0 to I10, I20, I30, I40 and T1 to I11, I21, I31, I41) and must be connected as shown in the wiring diagram.
- Unused inputs must also be connected to the assigned test pulse.

Series connection

X1, X2: Terminal block

Grey area: Control cabinet

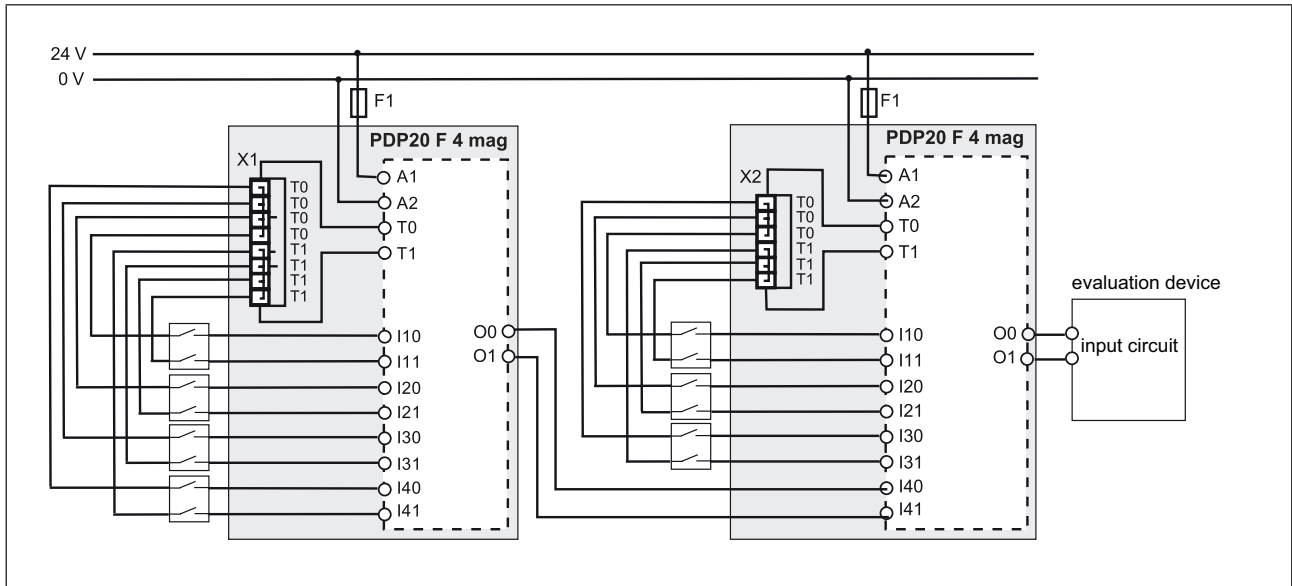

NOTICE

- **No** sensor should be connected between safety outputs O0 and O1 of the first PDP20 F 4 mag and inputs I40 and I41 of the second PDP20 F 4 mag. With a series connection, only safety output O0/O1 may be connected to the cascading inputs I40 - I41.
- The signal output SO indicates the state of the connected sensors. The state at input circuit I40 - I41 is not considered.

Operation





NOTICE

The safety functions should be checked after initial commissioning and each time the plant/machine is changed. The safety functions may only be checked by qualified personnel.





When the supply voltage is applied, the device checks whether the device is operating as a stand-alone device or in series with another PDP20 F 4 mag.

The unit is ready for operation when the Power LED is permanently lit.





LEDs indicate the status and errors during operation:

-  LED on
-  LED flashes
-  LED off

Status indicator

-  **O0 or O1**
High signal at the safety outputs
-  **O0 or O1**
Low signal at the safety outputs
-  **I10/11 or I20/21 or I30/31 or I40/41**
Input circuit is closed
-  **I10/11 or I20/21 or I30/31 or I40/41**
Input circuit is open

Fault indicator

-  **Power**
Supply voltage is missing, device is not ready for operation.
-  **Power**
Run-up phase, device checks whether it's a single or series connection
-  **O0 or O1**
Fault, short across contact or short circuit in the input or output circuit
Remedy: Switch off supply voltage, rectify the fault and then switch the supply voltage back on again.
-  **I10/11 or I20/21 or I30/31 or I40/41**
Input circuit is partially operated
Remedy: Open input circuit and close both N/O contacts again.

Technical details

General	
Certifications	CE, EAC, TÜV, UKCA, cULus Listed
Application range	Failsafe
Electrical data	
Supply voltage	
for	Module supply
Voltage	24 V
Kind	DC
Voltage tolerance	-15 %/+10 %
Output of external power supply (DC)	3,5 W
Residual ripple DC	20 %
External unit fuse protection F1 max.	6 A slow/10 A quick
Inputs	
Number	8
Input voltage in accordance with EN 61131-2 Type 1	24 V DC
Input current range	5 mA
Max. overall cable resistance R _{lmax}	
Single-channel at UB DC	1000 Ohm
Dual-channel without detection of shorts across contacts at UB DC	2000 Ohm
Dual-channel with detection of shorts across contacts at UB DC	2000 Ohm
Max. line capacitance	450 nF
Max. processing time of input when signal changes from "0" to "1"	40 ms
Semiconductor outputs	
Overall performance ext. loading, semiconductor	40 W
Number of positive-switching single-pole semiconductor outputs	2
Rated voltage	24 V DC
Permitted current range	0,000 - 0,500 A
Residual current at "0" signal	4 mA
Max. internal voltage drop	1 V
Max. processing time of semiconductor output when signal changes from "1" to "0"	40 ms
Conditional rated short circuit current	100 A
Lowest operating current	3 mA
Utilisation category in accordance with EN 60947-1	DC-12
Max. line capacitance at the outputs without load	2 nF
Test pulse outputs	
Number of test pulse outputs	2
Voltage, test pulse outputs	24 V DC

Times	
Switch-on delay	
Typ. switch-on delay	500 ms
Recovery time at max. switching frequency 1/s	
After power failure	40 ms
Supply interruption before de-energisation	20 ms
Environmental data	
Climatic suitability	EN 60068-2-78
Ambient temperature	
Temperature range	-10 - 55 °C
Storage temperature	
Temperature range	-25 - 70 °C
EMC	EN 60947-5-1, EN 60947-5-3, EN 61000-6-2, EN 61000-6-4, EN 61326-3-1
Vibration	
In accordance with the standard	EN 60068-2-6
Frequency	10 - 55 Hz
Amplitude	0,35 mm
Airgap creepage	
In accordance with the standard	EN 60947-1
Overvoltage category	III
Pollution degree	2
Rated insulation voltage	30 V
Rated impulse withstand voltage	0,8 kV
Protection type	
In accordance with the standard	EN 60529
Housing	IP40
Terminals	IP20
Mounting area (e.g. control cabinet)	IP54
Mechanical data	
Mounting position	Any
Material	
Bottom	PC
Front	PC
Top	PC
Connection type	Spring-loaded terminal, screw terminal
Mounting type	plug-in
Conductor cross section with screw terminals	
1 core flexible	0,25 - 2,5 mm², 24 - 12 AWG
2 core with the same cross section, flexible with crimp connectors, no plastic sleeve	0,25 - 1 mm², 24 - 16 AWG
2 core with the same cross section, flexible without crimp connectors or with TWIN crimp connectors	0,2 - 1,5 mm², 24 - 16 AWG
Torque setting with screw terminals	0,5 Nm
Stripping length with screw terminals	8 mm

Mechanical data

Conductor cross section with spring-loaded terminals:	
Flexible with/without crimp connector	0,2 - 2,5 mm², 24 - 12 AWG
Spring-loaded terminals: Terminal points per connection	
	2
Stripping length with spring-loaded terminals	
	9 mm
Dimensions	
Height	98 mm
Width	22,5 mm
Depth	120 mm
Weight	
	105 g

Where standards are undated, the 2022-09 latest editions shall apply.

Safety characteristic data



NOTICE
 You must comply with the safety characteristic data in order to achieve the required safety level for your plant/machine.

Operating mode	EN ISO 13849-1: 2015 PL	EN ISO 13849-1: 2015 Category	EN IEC 62061 SIL CL/ maximum SIL	EN IEC 62061 PFH _D [1/h]	EN/IEC 61511 SIL	EN/IEC 61511 PFD	EN ISO 13849-1: 2015 T _M [year]
2-channel	PL e	Cat. 4	SIL 3	3,44E-09	SIL 3	4,36E-05	20
Cascading inputs	PL e	Cat. 4	SIL 3	3,72E-09	SIL 3	5,84E-05	20

Explanatory notes for the safety-related characteristic data:

- ▶ Safety characteristic data in accordance with EN IEC 62061 and EN/IEC 61511 was calculated based on EN/IEC 61508.
- ▶ T_M is the maximum mission time in accordance with EN ISO 13849-1. The value also applies as the retest interval in accordance with EN/IEC 61508-6 and EN/IEC 61511 and as the proof test interval and mission time in accordance with EN IEC 62061.

All the units used within a safety function must be considered when calculating the safety characteristic data.



INFORMATION
 A safety function's SIL/PL values are **not** identical to the SIL/PL values of the units that are used and may be different. We recommend that you use the PAscal software tool to calculate the safety function's SIL/PL values.

Order reference

Product

Product type	Features	Order no.
PDP20 F 4 mag	Sensor interface	773310

Accessories

Product type	Features	Order no.
Set spring terminals	1 set of spring-loaded terminals	751004
Set screw terminals	1 set of screw terminals	750004

EC declaration of conformity

This product/these products meet the requirements of the directive 2006/42/EC for machinery of the European Parliament and of the Council. The complete EC Declaration of Conformity is available on the Internet at www.pilz.com/downloads.

Authorised representative: Norbert Fröhlich, Pilz GmbH & Co. KG, Felix-Wankel-Str. 2, 73760 Ostfildern, Germany

UKCA-Declaration of Conformity

This product(s) complies with following UK legislation: Supply of Machinery (Safety) Regulation 2008.

The complete UKCA Declaration of Conformity is available on the Internet at www.pilz.com/downloads.

Representative: Pilz Automation Technology, Pilz House, Little Colliers Field, Corby, Northamptonshire, NN18 8TJ United Kingdom, eMail: mail@pilz.co.uk

