

1 2 3 4

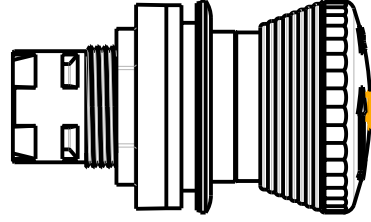
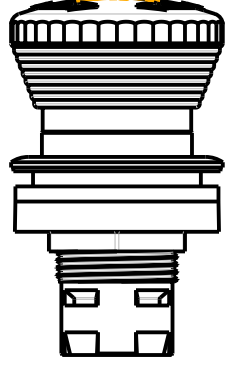
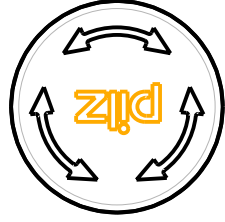
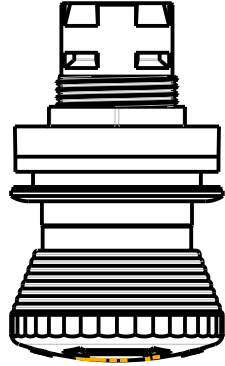
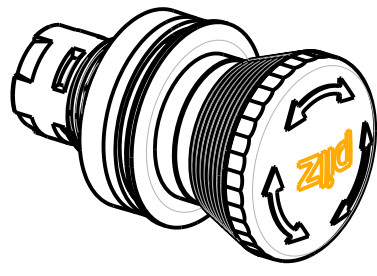
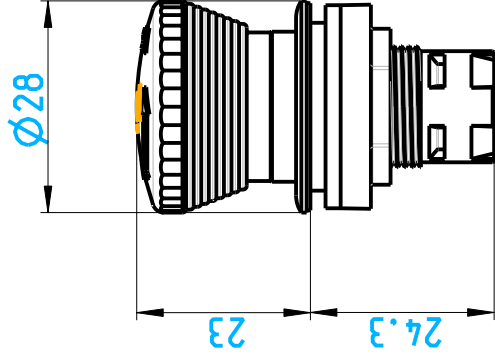
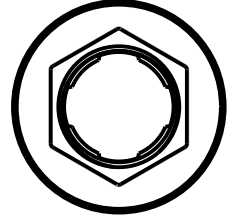

A

B

C

D

Observe protection note to DIN 34

-	20120486	29.11.2012	EP-MK	EP-MK	Neuanlage new Drawing	MODEL: 2011787	DRW: 2011788
Index	ECO no.	Date	Editor	Checked	Name	Internet Dokument Internet document PIT es small	
Scale	1:1		Created	Date	EP-MK	Doc.-No.	Page 1
Material	-		Checked	29.11.2012	EP-MK	2011788	
			Norm	-	-	Mat.-No.	of 1
Surface			All dimensions are in mm				
			Unspecified tolerance				

