



## PIT m3.2p

**PILZ**  
THE SPIRIT OF SAFETY

- ▶ Control and signal devices

This document is the original document.

Where unavoidable, for reasons of readability, the masculine form has been selected when formulating this document. We do assure you that all persons are regarded without discrimination and on an equal basis.

All rights to this documentation are reserved by Pilz GmbH & Co. KG. Copies may be made for the user's internal purposes. Suggestions and comments for improving this documentation will be gratefully received.

Pilz®, PIT®, PMI®, PNOZ®, Primo®, PSEN®, PSS®, PVIS®, SafetyBUS p®, SafetyEYE®, SafetyNET p®, the spirit of safety® are registered and protected trademarks of Pilz GmbH & Co. KG in some countries.



SD means Secure Digital

<b>1</b>	<b>Introduction</b>	<b>5</b>
1.1	Validity of documentation	5
1.1.1	Retaining the documentation	5
1.2	Definition of symbols	5
<b>2</b>	<b>Overview</b>	<b>7</b>
2.1	Features of the operating mode selector switch	7
2.2	Features of transponder key	8
2.3	Control elements	9
2.3.1	Explanation of front membrane	10
<b>3</b>	<b>Safety</b>	<b>12</b>
3.1	Intended use	12
3.2	Safety regulations	13
3.2.1	Use of qualified personnel	13
3.2.2	Warranty and liability	13
3.2.3	Disposal	13
<b>4</b>	<b>Function description</b>	<b>14</b>
4.1	Configuration of functions	16
4.2	Operating mode interface	20
4.2.1	Switch behaviour after a transponder key is removed	20
4.2.2	Control program requirements	20
4.3	Interface for status information	21
4.3.1	Timing diagrams	23
4.3.1.1	Operator actions	23
4.3.1.2	Device error	25
4.3.1.3	Application error: "No authorisation"	25
4.3.1.4	Application error: "Pushbutton operated incorrectly"	27
4.4	Key ID interface	30
4.4.1	Key ID number of the transponder key	30
4.4.2	Communication mode for downloading the Key ID number	31
4.4.2.1	Transmitter-controlled communication mode	31
4.4.2.2	Handshake-controlled communication mode	32
4.4.2.3	Advanced communication mode	33
4.4.3	Evaluation by a controller	34
4.4.3.1	Evaluation of the Key ID number with transmitter-controlled communication	34
4.4.3.2	Evaluation of the Key ID number with handshake-controlled communication	37
4.4.3.3	Evaluation of the Key ID number with advanced communication	41
4.5	Operating mode lock and operating mode preselection	41
4.5.1	Operating mode lock	41
4.5.2	Operating mode pre-selection	43
<b>5</b>	<b>Installation</b>	<b>46</b>
5.1	General installation guidelines	46
5.2	Dimensions in mm	46
5.3	Mounting cutout	47

<b>6</b>	<b>Wiring</b> .....	<b>48</b>
6.1	Terminal configuration.....	48
6.2	Connecting the unit .....	49
6.3	Connection to a control system.....	50
<b>7</b>	<b>Operation</b> .....	<b>54</b>
7.1	Select operating modes OM1 ... OM4.....	54
7.2	Select special mode (service).....	55
7.3	Monitoring of operating time.....	56
7.4	Switchover delay t1 .....	57
7.5	Troubleshooting .....	57
7.5.1	Delete error .....	58
7.6	Diagnostics.....	59
7.6.1	Status information about the interface for status information.....	59
7.6.2	Status information about button backlighting .....	59
7.6.3	Status information via authorisation display.....	61
<b>8</b>	<b>Technical details</b> .....	<b>62</b>
8.1	Safety characteristic data.....	64
<b>9</b>	<b>Supplementary data</b> .....	<b>65</b>
9.1	Radio approval.....	65
9.2	Chemical resistance.....	65
9.2.1	Front membrane.....	65
9.2.2	Plastic frame .....	67
<b>10</b>	<b>Order reference</b> .....	<b>69</b>
10.1	Product.....	69
10.2	Accessories.....	69
<b>11</b>	<b>EC declaration of conformity</b> .....	<b>71</b>
<b>12</b>	<b>UKCA-Declaration of Conformity</b> .....	<b>72</b>

# 1 Introduction

## 1.1 Validity of documentation

This documentation is valid for the product PIT m3.2p. It is valid until new documentation is published.

This operating manual explains the function and operation, describes the installation and provides guidelines on how to connect the product.

### 1.1.1 Retaining the documentation

This documentation is intended for instruction and should be retained for future reference.

## 1.2 Definition of symbols

Information that is particularly important is identified as follows:



### **DANGER!**

This warning must be heeded! It warns of a hazardous situation that poses an immediate threat of serious injury and death and indicates preventive measures that can be taken.



### **WARNING!**

This warning must be heeded! It warns of a hazardous situation that could lead to serious injury and death and indicates preventive measures that can be taken.



### **CAUTION!**

This refers to a hazard that can lead to a less serious or minor injury plus material damage, and also provides information on preventive measures that can be taken.



### **NOTICE**

This describes a situation in which the product or devices could be damaged and also provides information on preventive measures that can be taken. It also highlights areas within the text that are of particular importance.



**INFORMATION**

This gives advice on applications and provides information on special features.

## 2 Overview

The operating mode selector switch may only be operated in conjunction with a transponder key. 5 transponder keys are available, each with different authorisations.

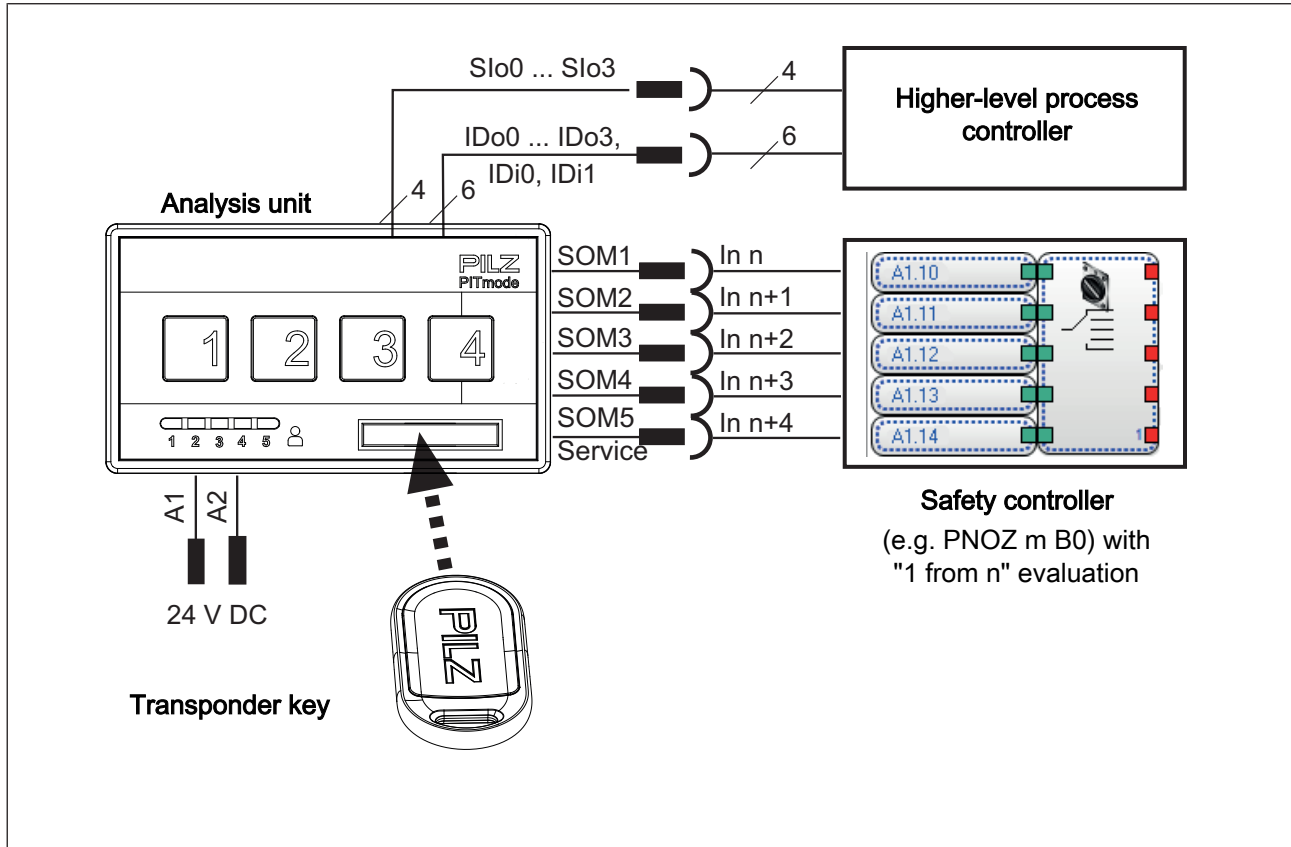





Fig.: Operating mode selector switch in an application (principle)

### 2.1 Features of the operating mode selector switch

The product has the following features:

- ▶ Supply voltage 24 V DC
- ▶ 4 pushbuttons for switching the operating mode
- ▶ Selected operating mode is displayed through pushbutton backlighting
- ▶ 4 operating modes OM1 ... OM4
- ▶ 1 special mode OM5 (Service)
- ▶ 5 monitored semiconductor outputs (24 V) in accordance with EN 61496-1; 1 semiconductor output per operating mode
- ▶ Interface for status information, consisting of 4 signal outputs (24 V)
- ▶ Status information is divided into information classes:
  - Operator actions
    - Insert transponder key
    - Remove transponder key
    - Select operating mode

- Messages (e.g. user error, malfunction)
- ▶ Interface (Key ID interface) for downloading the Key ID number of the transponder key you are using, consisting of
  - 3 semiconductor outputs (24 V)
  - 2 inputs
  - 1 configurable input/output
    - can be configured as
      - input (see [Transmitter-controlled](#)  31] and [Handshake-controlled communication mode](#)  32])
      - output (see [Advanced communication mode](#)  33])
- ▶ Configurable communication mode for downloading the Key ID number
  - Transmitter-controlled communication mode
  - Handshake-controlled communication mode
  - Advanced communication mode
- ▶ Authorisations of a transponder key are displayed via LEDs

## 2.2 Features of transponder key

A transponder key contains a Key ID number and the authorisations to which you can switch with that transponder key.

Features:

- ▶ Replaces the mechanical key
- ▶ Different authorisations
- ▶ Authorisations are identified via printed "Key Mode".
- ▶ Unique identification of a certain transponder key via Key-ID number



## 2.3 Control elements

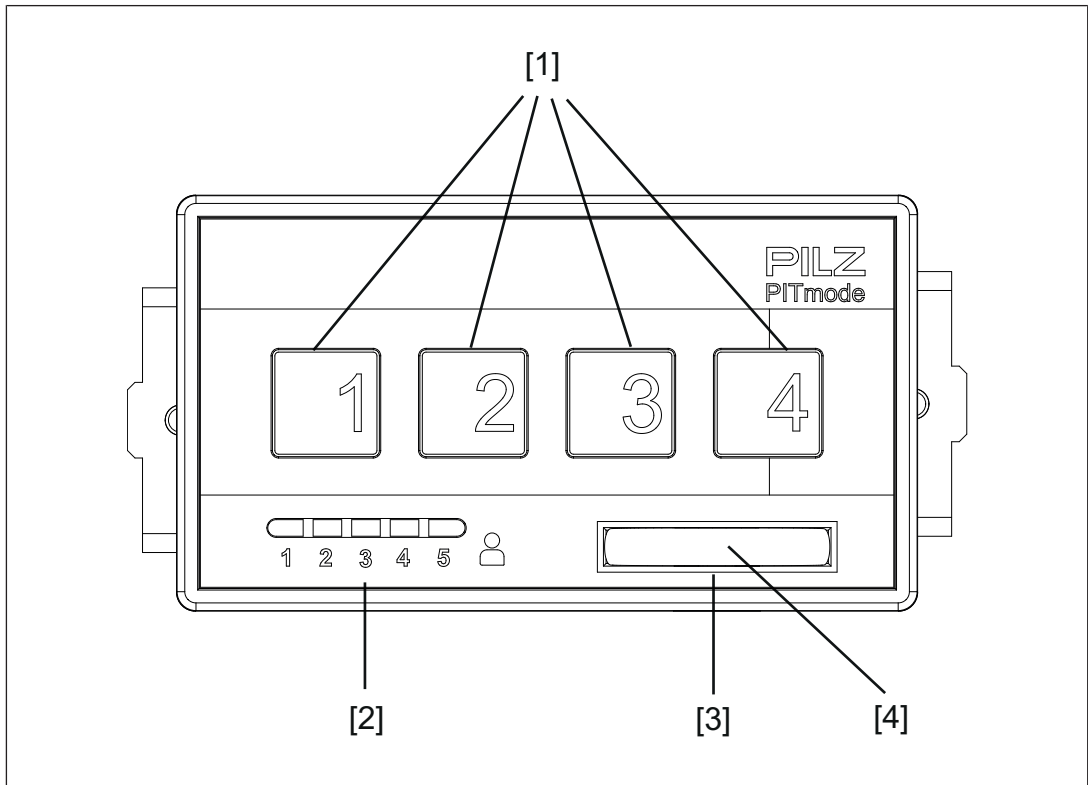

Fig.: Front view

### Legend

- [1] Pushbutton to select an operating mode
  - 1 Pushbutton for OM1 / OM5
  - 2 Pushbutton for OM2
  - 3 Pushbutton for OM3
  - 4 Pushbutton for OM4
- [2] Authorisation display – LEDs to display the authorisations for the relevant transponder key
  - 1 Authorisation for OM1
  - 2 Authorisation for OM2
  - 3 Authorisation for OM3
  - 4 Authorisation for OM4
  - 5 Authorisation for OM5
- [3] Slot for inserting the transponder key
- [4] Transponder key

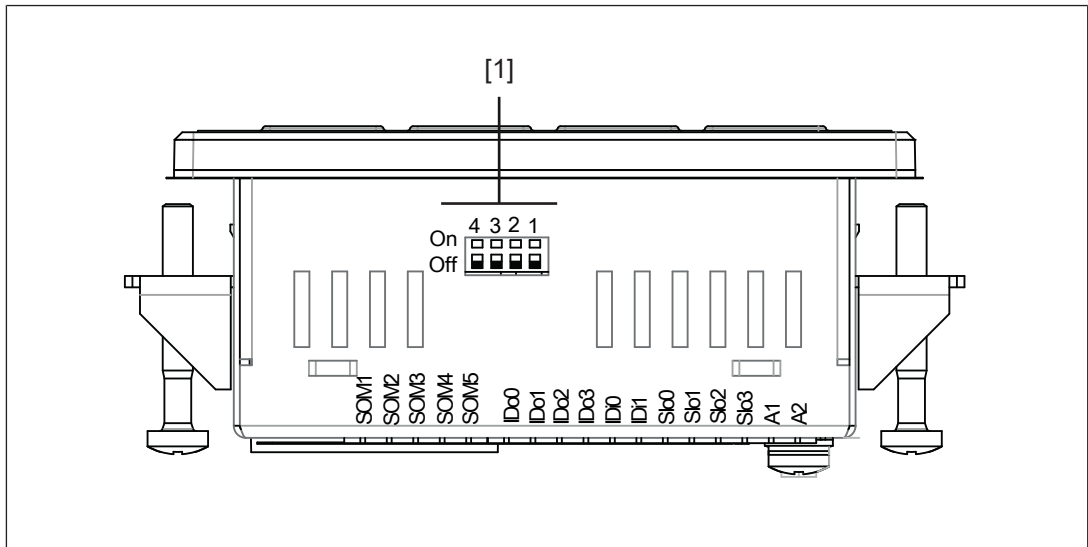

Fig.: View from above

**Legend**

- [1] DIP switch for configuration of the switching behaviour after the transponder key is removed and for configuration of the communication mode for downloading the Key ID number

**2.3.1 Explanation of front membrane**

There is a version of the operating mode selector switch with front membrane, for use with moulding machines. The front membrane contains symbols of the various operating modes.

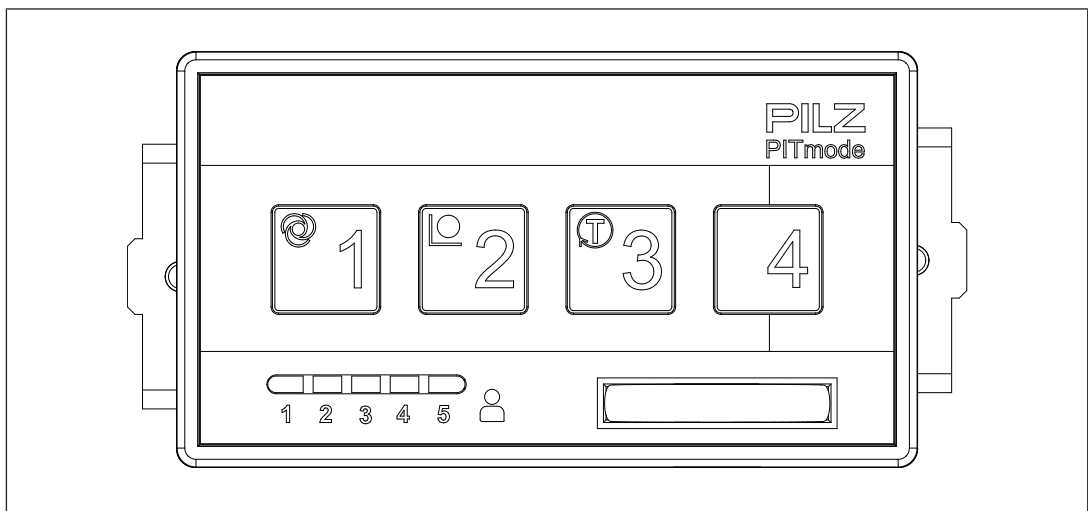









Fig.: PITm3.2p with front membrane

The table below explains what the symbols mean:

Operating mode	Display	Explanation
		Automatic mode (EN ISO 16090-1:2014)
		Set-up (EN ISO 16090-1:2014)
		Test run (EN ISO 16090-1:2014)
		Process monitoring in production without enabling device

## 3 Safety

### 3.1 Intended use

The operating mode selector switch is suitable for machines that can be operated in multiple operating modes with different safety functions and/or work procedures. It enables you to switch between defined operating modes, such as:

- ▶ Set-up mode
- ▶ Manual mode
- ▶ Automatic mode
- ▶ Service

The operating mode selector switch meets the following safety requirements:

- ▶ Interlock to protect against unauthorised switching  
To switch to an operating mode with the (selection) pushbutton, contact with a transponder key is required.
- ▶ Access permissions are restricted to certain groups  
A transponder key with the relevant permission is required in order to switch to a certain operating mode.
- ▶ Prevents unintentional switching  
The switch to a different operating mode is only recognised once the corresponding (selection) pushbutton has been operated for a defined period ("deliberate operator action"). Multiple operation of (selection) pushbuttons is detected.
- ▶ Safe "1oon" circuit of the operating mode outputs  
The operating mode selector switch only ever leads to one operating mode output "1" signal.

When restarting, the device is in OM1 or in the last selected operating mode, depending on the device configuration.

Depending on the application area and its respective regulations, the device can be used up to SIL CL 2 (EN IEC 62061) and up to PL d (EN ISO 13849-1), if the operating modes are evaluated by a safety controller with safe "1oon" evaluation.



#### NOTICE

Faulty operation of PITmode can lead to hazardous situations. Switching to an operating mode must not initiate a hazardous movement, nor can it cancel an existing control command.

## **3.2 Safety regulations**

### **3.2.1 Use of qualified personnel**

The products may only be assembled, installed, programmed, commissioned, operated, maintained and decommissioned by persons who are competent to do so.

A competent person is a qualified and knowledgeable person who, because of their training, experience and current professional activity, has the specialist knowledge required. To be able to inspect, assess and operate devices, systems and machines, the person has to be informed of the state of the art and the applicable national, European and international laws, directives and standards.

It is the company's responsibility only to employ personnel who

- ▶ Are familiar with the basic regulations concerning health and safety / accident prevention,
- ▶ Have read and understood the information provided in the section entitled Safety
- ▶ Have a good knowledge of the generic and specialist standards applicable to the specific application.

### **3.2.2 Warranty and liability**

All claims to warranty and liability will be rendered invalid if

- ▶ The product was used contrary to the purpose for which it is intended,
- ▶ Damage can be attributed to not having followed the guidelines in the manual,
- ▶ Operating personnel are not suitably qualified,
- ▶ Any type of modification has been made (e.g. exchanging components on the PCB boards, soldering work etc.).

### **3.2.3 Disposal**

- ▶ In safety-related applications, please comply with the mission time  $T_M$  in the safety-related characteristic data.
- ▶ When decommissioning, please comply with local regulations regarding the disposal of electronic devices (e.g. Electrical and Electronic Equipment Act).

## 4 Function description

The operating mode selector switch enables you to switch between 5 different operating modes (operating modes OM1 ... OM4 and special operating mode OM5 (Service)).

For OM1 ... OM4, one button each is available. For the special operating mode (Service), button OM1 must be operated for a certain period (see [Monitoring of operating time](#) [📖 56]). Each pushbutton is assigned a monitored semiconductor output (see [Operating mode interface](#) [📖 20]). Operating the button changes the semiconductor output from a "0" signal to a "1" signal. The operating mode selector switch guarantees that only one of the semiconductor outputs has a "1" signal at any one time.



### INFORMATION

#### OM storage of operating mode

When configured with OM storage (see [Configuration of functions](#) [📖 16]), after a restart the unit will start with the last selected operating mode.

If OM storage is **not** configured, the unit always starts with OM1. For this reason you should make sure that OM1 represents the safest operating mode.

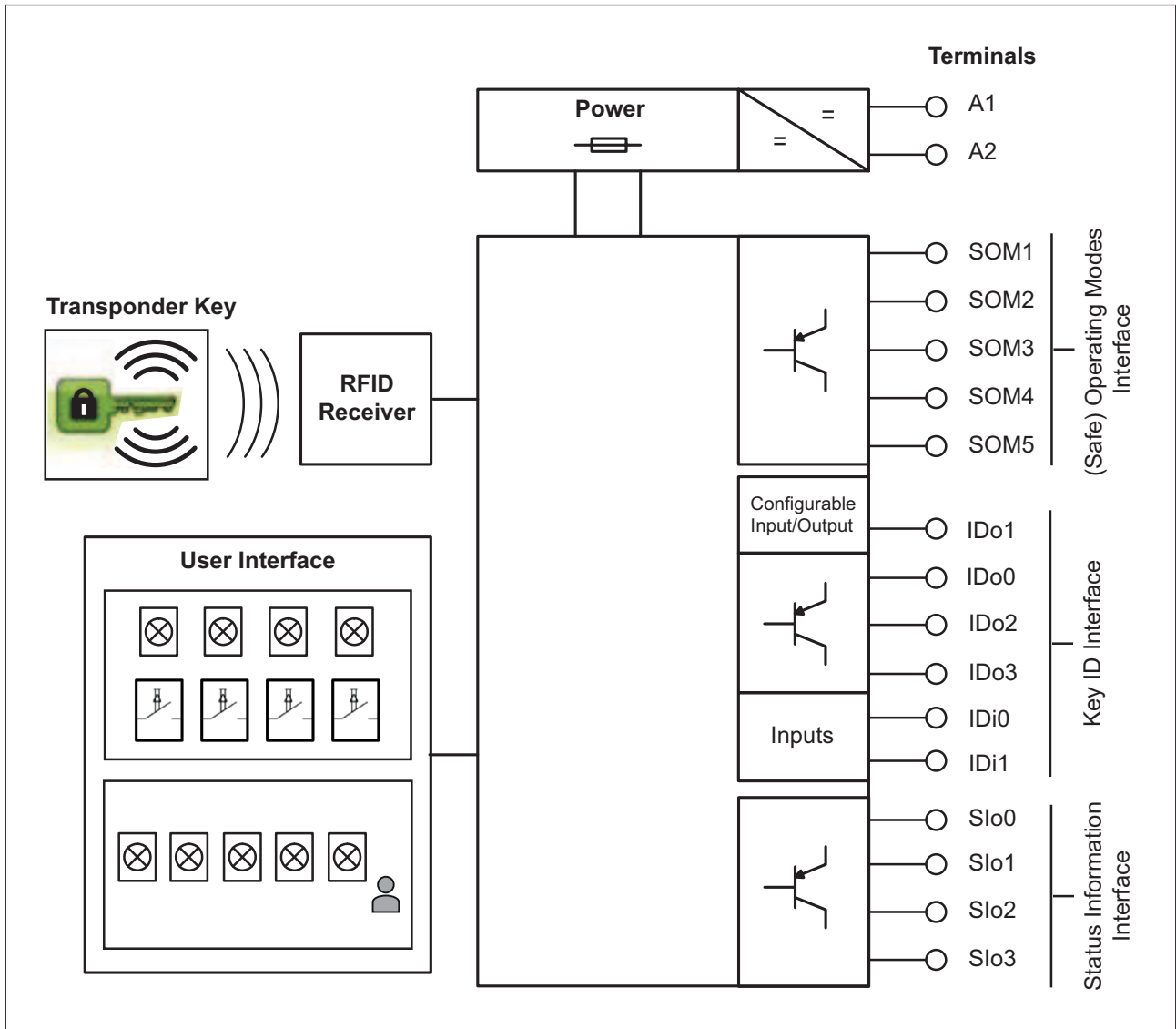

Fig.: Block diagram

**Legend**

- |                                    |  |
|------------------------------------|--|
| Transponder Key                    | Electronic key to enable a change of operating mode  |
| User Interface                     | <ul style="list-style-type: none"> <li>▶ Button to select the operating mode</li> <li>▶ Authorisation display (LEDs to display the authorisations for the relevant transponder key)</li> </ul> |
| A1, A2                             | Supply voltage   |
| SOM1 ... SOM5                      | Operating mode interface<br>Interface to display the operating mode that is currently selected,<br>consisting of 5 monitored outputs   |
| IDo0 ... IDo3 and<br>IDi0 ... IDi1 | Key ID interface<br>Interface to download the Key ID number to a controller,<br>consisting of 3 outputs, 2 inputs and 1 configurable input/output  |

Slo0 ... Slo3                      Interface for status information  
 Interface to signal status information,  
 consisting of 4 signal outputs

The operating mode selector switch is protected against unauthorised operation. A switch between operating modes must be enabled via a transponder key.

**Transponder key authorisations**

A total of 5 transponder keys are available for an operating mode selector switch. Each transponder key provides authorisation to switch up to 5 operating modes, including special authorisations. A transponder key can be identified via the printed key mode.

**Assignment of key modes to authorisations**

Designation	Marking on transponder key	Authorisation for operating mode
Key Mode 01	<b>1</b>	OM1
Key Mode 02	<b>2</b>	OM1+ OM2
Key Mode 03	<b>3</b>	OM1 + OM2 + OM3
Key Mode 04	<b>4</b>	OM1 + OM2 + OM3 + OM4
Key Service	<b>Service</b>	OM1 + OM2 + OM3 + OM4 + OM5 (Service)

**4.1 Configuration of functions**

The operating mode selector switch has a DIP switch, which you can use to set the required communication mode for downloading the Key ID number and the unit's behaviour

- ▶ after the transponder key is removed and
- ▶ after the voltage reset.

The communication modes have different functions. These functions are described in the following subsections:

- ▶ [Transmitter-controlled communication mode !\[\]\(32b3140000635d85b5fcc7ce37a1b40f\_img.jpg\) 31](#)
- ▶ [Handshake-controlled communication mode !\[\]\(a2709e896f70a15af1b75ddfa7236315\_img.jpg\) 32](#)
- ▶ [Advanced communication mode !\[\]\(6a35e7fc1cc98abd5e41a848bc25419c\_img.jpg\) 33](#)





**NOTICE**

**It is essential to note:**





- The configuration may only be performed by a competent person.
- The configuration must be performed when the supply voltage is switched off.
- The configuration is adopted as the device is started up, provided the switch setting is valid. If not, the device switches to a "Device error" fault condition.
- During operation, the DIP switch setting is monitored for any change. If the switch setting is changed during operation, the device switches to a "Device error" fault condition, remedy: [Delete error](#) [58].
- The communication mode changes when you change the DIP switch setting from Pos. [1]-[4] to Pos. [5]-[8]. In this case you automatically switch to advanced communication mode.

**Legend**

	DIP switch in ON position
	DIP switch in OFF position

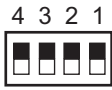
The sliders of the DIP switches are shown in black in the table.

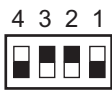
DIP switch setting	Switch behaviour of operating mode (OM)	Communication modes	Operating mode lock and operating mode preselection
[1]: Default setting 	OM1-OM4: OM hold OM5: Service fallback	Sender or handshake-controlled communication mode	<input type="checkbox"/>
[2] 	OM hold	Sender or handshake-controlled communication mode	<input type="checkbox"/>
[3] 	OM fallback	Sender or handshake-controlled communication mode	<input type="checkbox"/>

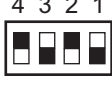
DIP switch setting	Switch behaviour of operating mode (OM)	Communication modes	Operating mode lock and operating mode preselection
[4] On Off 	OM storage	Sender or handshake-controlled communication mode	<input type="checkbox"/>
[5] On Off 	OM1-OM4: OM hold	Advanced communication mode	<input checked="" type="checkbox"/>
	OM5: Service fallback		
[6] On Off 	OM hold	Advanced communication mode	<input checked="" type="checkbox"/>
[7] On Off 	OM fallback	Advanced communication mode	<input checked="" type="checkbox"/>
[8] On Off 	OM storage	Advanced communication mode	<input checked="" type="checkbox"/>

DIP configuration



**NOTICE**

It is **essential** to note that only the DIP switch settings described above will be assessed as valid. With all other DIP switch settings, the device switches to a "Device error" fault condition.

**Explanation of the switching behaviour**

	<b>When the transponder key is removed</b>	<b>After a voltage reset</b>
OM hold	<ul style="list-style-type: none"> <li>▶ the operating mode currently selected is maintained,</li> <li>▶ the assigned pushbutton is back-lit or all pushbuttons flash (BA5),</li> <li>▶ the assigned semiconductor output has a "1" signal.</li> </ul>	<ul style="list-style-type: none"> <li>▶ the operating mode BA1 is activated,</li> <li>▶ pushbutton 1 is back-lit,</li> <li>▶ SOM1 has a "1" signal.</li> </ul>
OM fallback	<ul style="list-style-type: none"> <li>▶ the operating mode switches to OM1,</li> <li>▶ pushbutton 1 is back-lit,</li> <li>▶ SOM1 has a "1" signal.</li> </ul>	<ul style="list-style-type: none"> <li>▶ the operating mode BA1 is activated,</li> <li>▶ pushbutton 1 is back-lit,</li> <li>▶ SOM1 has a "1" signal.</li> </ul>
Service fallback (BA5 must be active)	<ul style="list-style-type: none"> <li>▶ the operating mode switches to OM1,</li> <li>▶ pushbutton 1 is back-lit,</li> <li>▶ SOM1 has a "1" signal.</li> </ul>	<ul style="list-style-type: none"> <li>▶ the operating mode BA1 is activated,</li> <li>▶ pushbutton 1 is back-lit,</li> <li>▶ SOM1 has a "1" signal.</li> </ul>
OM storage	<ul style="list-style-type: none"> <li>▶ the operating mode currently selected is maintained,</li> <li>▶ the assigned pushbutton is back-lit or all pushbuttons flash (BA5),</li> <li>▶ the assigned semiconductor output has a "1" signal.</li> </ul>	<ul style="list-style-type: none"> <li>▶ the operating mode selected most recently is activated,</li> <li>▶ the assigned pushbutton is back-lit or all pushbuttons flash (BA5),</li> <li>▶ the assigned semiconductor output has a "1" signal.</li> </ul>



**NOTICE**

Switching of the operating mode to OM1 by removing the transponder key is **not** a safety-related function. Switching of the operating mode has to be validated in accordance with the requirements.

## 4.2 Operating mode interface

The operating mode interface consists of the monitored outputs SOM1 ... SOM5 (see [Block diagram](#)  14). "SOM" stands for "Safe Operating Mode". The outputs are assigned to buttons, which can be used to select an operating mode if they have the relevant authorisation (transponder key):

Pushbutton	Output	Operating mode	
1	SOM1	OM1	The operating mode OM1/OM5 is selected based on the operating time of button 1 (see <a href="#">Monitoring of operating time</a>  56)
	SOM5	OM5	
2	SOM2	OM2	
3	SOM3	OM3	
4	SOM4	OM4	

### 4.2.1 Switch behaviour after a transponder key is removed

If the transponder key is removed after changing to a different operating mode, it is possible to configure the subsequent switch behaviour of SOM1 ... SOM5. A DIP switch is available for this purpose (see [Control elements](#)  9).

The individual switch settings and the resulting switch behaviour are described in the chapter entitled [Configuration of functions](#)  16.

### 4.2.2 Control program requirements

In order to achieve SIL CL 2 (EN IEC 62061)/PL d (EN ISO 13849-1) in an application, the evaluation must be carried out by a safety-related function block. The safety-related function block must meet the following requirements:

- ▶ The function block must enable safe "1oon" evaluation of the output signals at SOM1 ... SOM5.
- ▶ If two or more operating modes are present at the same time, this must be detected as an error.



#### INFORMATION

The function block must bridge the t1 switchover delay (see [Switchover delay t1](#)  57).

If a PNOZmulti (e.g. PNOZ m1p) is used as the safety controller in conjunction with an "operating mode selector switch" function element, then this requirement is met automatically.

### 4.3 Interface for status information

Various status information can be signalled via the interface for status information (see [Block diagram \[14\]](#)). The status information can be evaluated through a controller.

The status information is subdivided into the following information classes:

- ▶ Operator actions
  - Insert transponder key
  - Remove transponder key
  - Select operating mode
- ▶ Messages (e.g. application error, malfunction, response)



#### NOTICE

When the operating mode is selected (Slo0 ... Slo3 = 3h, 8h ... Bh) and when there is a device error (Dh), the information remains present indefinitely. All other information stays active for just **200 ms**. After that time the selected operating mode is again displayed.

Status information	Information class	Slo3 (MSB)	Slo2	Slo1	Slo0 (LSB)	Value (in Hex)
Operating mode preselection is switched [5]	Response	0	0	0	0	0h
Reserve	- - -	0	0	0	1	1h
Transponder key 5 – Inserted [1]	Operator action	0	0	1	0	2h
OM5 selected	Operator action	0	0	1	1	3h
Transponder key 1 – Inserted [1]	Operator action	0	1	0	0	4h
Transponder key 2 – Inserted [1]	Operator action	0	1	0	1	5h
Transponder key 3 – Inserted [1]	Operator action	0	1	1	0	6h
Transponder key 4 – Inserted [1]	Operator action	0	1	1	1	7h
OM1 selected	Operator action	1	0	0	0	8h
OM2 selected	Operator action	1	0	0	1	9h
OM3 selected	Operator action	1	0	1	0	Ah
OM4 selected	Operator action	1	0	1	1	Bh
No permission [2]	Application error	1	1	0	0	Ch
Device error [3]	Error	1	1	0	1	Dh
Pushbutton operated incorrectly [4]	Application error	1	1	1	0	Eh
Transponder key removed	Operator action	1	1	1	1	Fh

[1] When a pushbutton is released, information as to which transponder key is used will be displayed for 200 ms (see Status information 2h and 4h ... 7h). The selected operating mode is then displayed (see Status information 3h and 8h ... Bh).

Please refer to the timing diagrams for [Operator actions](#)  23].

[2] The error "No authorisation" (Ch) is registered in the following cases:

- ▶ Operating mode selected without transponder key
- ▶ Operating mode selected with a transponder key that is not authorised for the selected operating mode
- ▶ Transponder key is not authorised for the active operating mode
- ▶ Transponder key is not inserted in time before the operating mode is selected
- ▶ A pushbutton is operated during the operating mode lock

The remedy is described in the chapter entitled [Troubleshooting](#)  57].

Please refer to the timing diagrams for [Application error: "No authorisation"](#)  25].

[3] A "Device error" (Dh) is registered,

- ▶ if the DIP switch setting is changed during operation (see [Delete error](#)  58]) or
- ▶ if one of the operating mode outputs SOM1 ... SOM5 is stuck because of external voltage (stuck-at-1 or stuck-at-0) or
- ▶ if there is an internal device error.

The remedy is described in the chapter entitled [Troubleshooting](#)  57].

[4] The error "Pushbutton operated incorrectly" (Eh) is displayed in the following cases:

- ▶ Multiple operation of pushbuttons
- ▶ Pushbutton operated for too long (timeout for OM1 to OM4 = 5 s and timeout for OM5 = 10 s)  
**Note:** If a key is operated for < 50 ms this will not be evaluated, so there will be no reaction.
- ▶ Pushbutton was released after the transponder key was removed

The remedy is described in the chapter entitled [Troubleshooting](#)  57].

Please refer to the timing diagrams for [Application error: "Pushbutton operated incorrectly"](#)  27].

[5] In the configurations with DIP switch settings [5] ... [8] the switching of operating mode outputs to the preselected operating mode is displayed for 200 ms during an operating mode preselection. This is used as a feedback for the controller.

### 4.3.1 Timing diagrams

#### 4.3.1.1 Operator actions



The following timing diagrams show how status information is registered at outputs Slo0 ... Slo3, based on operator actions.



**INFORMATION**

The signal changes at the outputs without delay. Use a software filter to avoid read-in errors.

Legend:

	Message is displayed constantly
	Message is displayed briefly (200 ms)
MSO	Mode of safe operation (operating mode)

**Select operating mode**

1. Start position:
  - OM1 selected
  - DIP switch in default setting
2. Operator action: Insert transponder key (e.g. Authorisation Key Mode 02)
3. Operator action: Select operating mode (e.g. Press pushbutton "2" for OM2)
4. Operator action: Remove transponder key

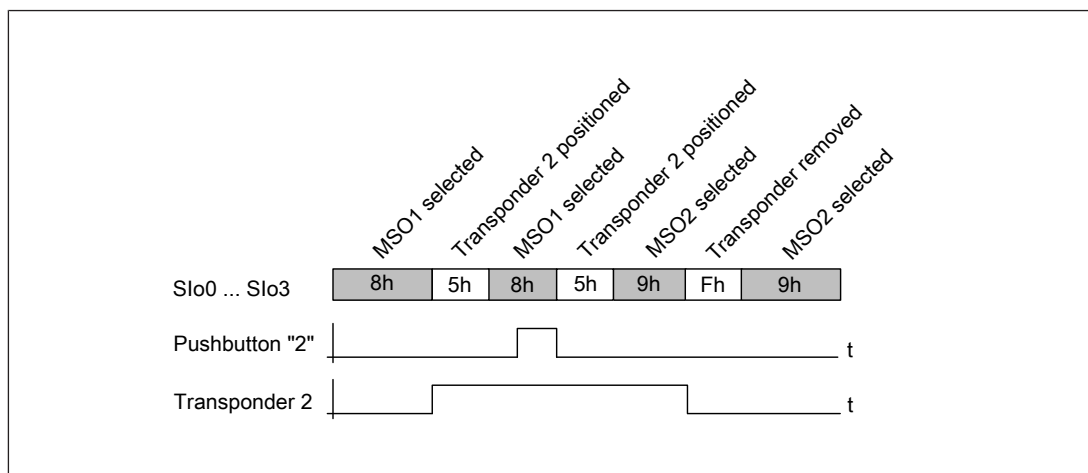

Fig.: Timing diagram for "Select operating mode" with DIP switch setting [1] (default setting) and [5]

### Remove transponder key

1. Start position:

⇒ OM5 is selected and the transponder key "Key Service" is inserted

or

⇒ One of the operating modes OM1 ... OM4 is selected and a transponder key with the relevant authorisation is inserted

2. Operator action: Remove transponder key

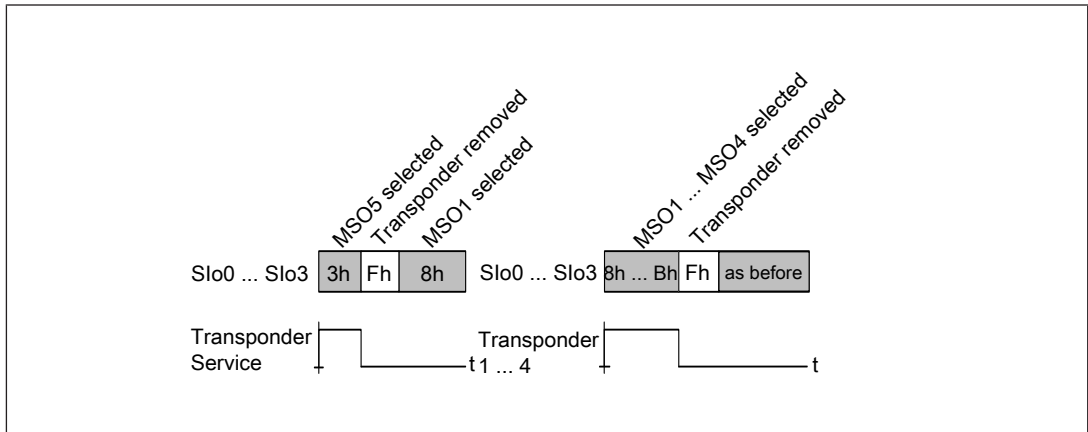

Fig.: Timing diagram for "Remove transponder key" with DIP switch setting [1] (default setting) and [5]

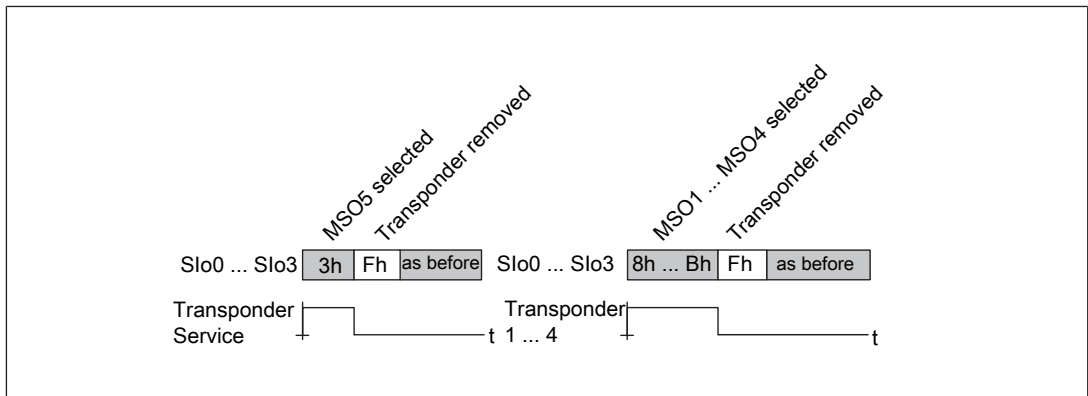

Fig.: Timing diagram for "Remove transponder key" with DIP switch setting [2], [4], [6] and [8]



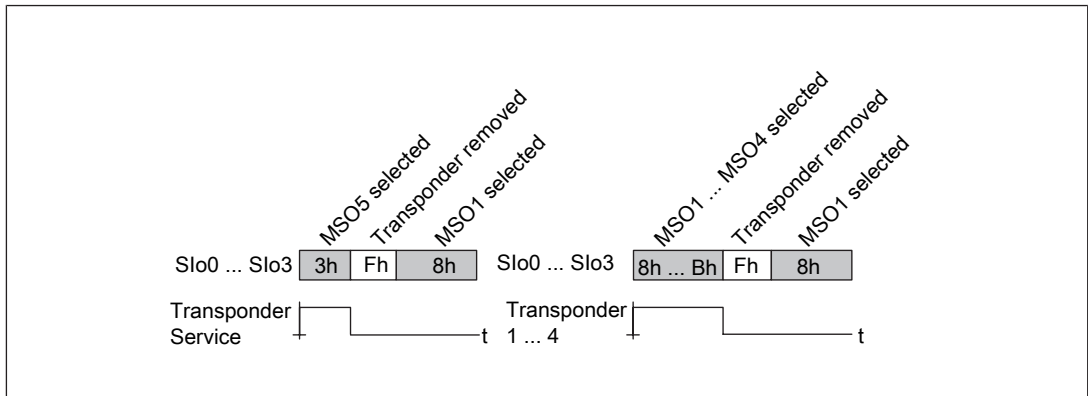

Fig.: Timing diagram for "Remove transponder key" with DIP switch setting [3] and [7]

4.3.1.2

**Device error**

The following timing diagram shows how status information is registered at outputs Slo0 ... Slo3, based on a device error.

Legend:

■	Message is displayed constantly
□	Message is displayed briefly (200 ms)
MSO	Mode of safe operation (operating mode)

**Device error**

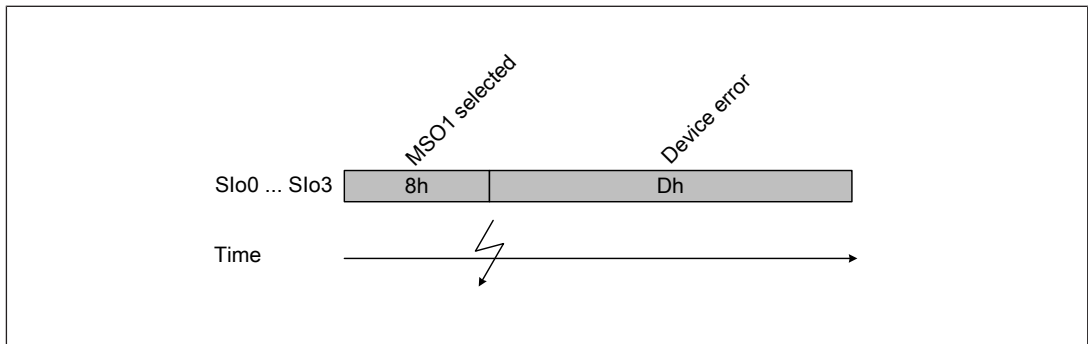

Fig.: Timing diagram for device error

4.3.1.3

**Application error: "No authorisation"**

The following timing diagrams show how status information is registered at outputs Slo0 ... Slo3, based on the application errors "No permission".

Legend:

■	Message is displayed constantly
□	Message is displayed briefly (200 ms)
MSO	Mode of safe operation (operating mode)

**Operating mode selected without transponder key**

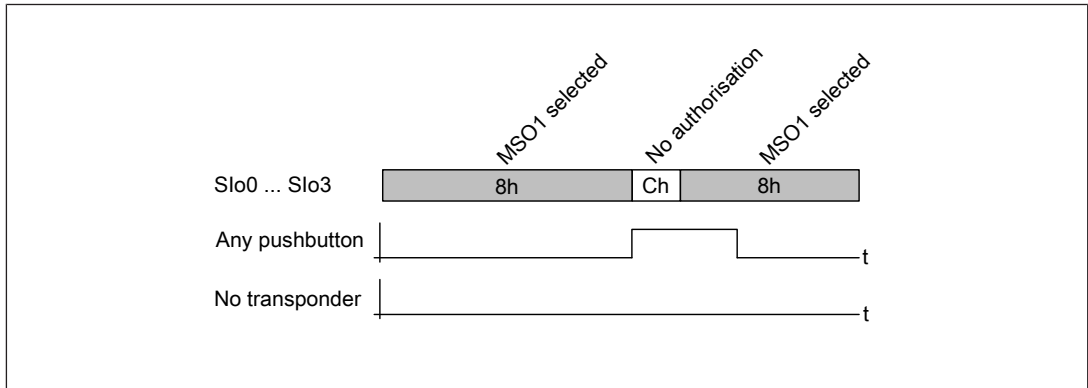

Fig.: Timing diagram for "Operating mode selected without transponder key"

**Operating mode selected with a transponder key that does not have permission for the selected operating mode**

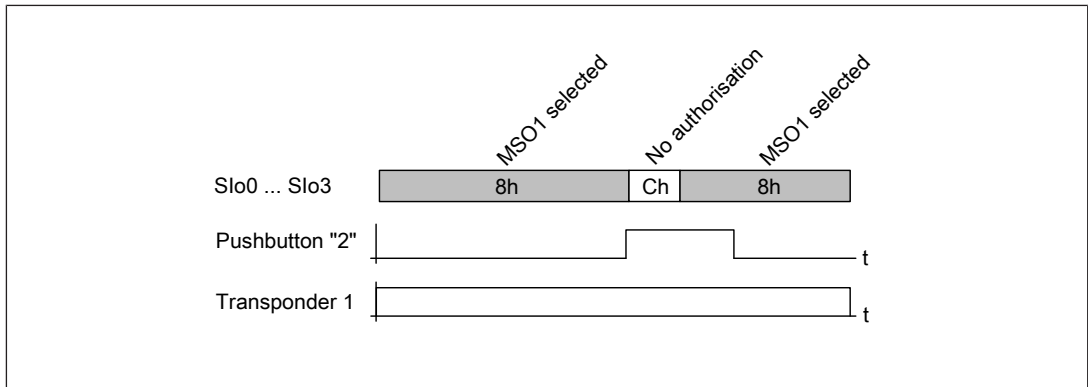

Fig.: Timing diagram for operating mode selection with insufficient permission for the desired operating mode

**Operating mode selected with a transponder key that does not have permission for the active operating mode**

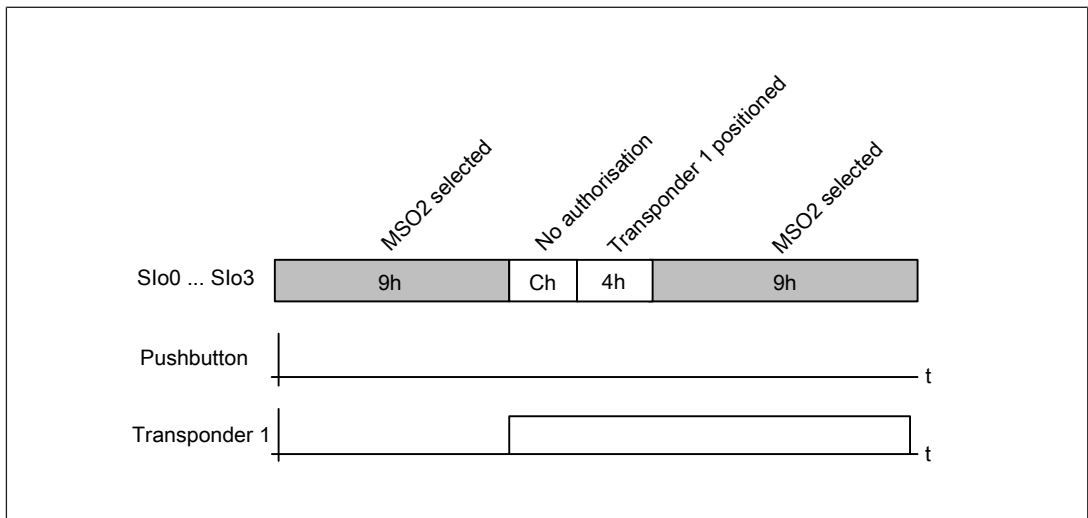

Fig.: Timing diagram for operating mode selection with insufficient permission for the active operating mode

**Transponder key is not inserted in time before the operating mode is selected**

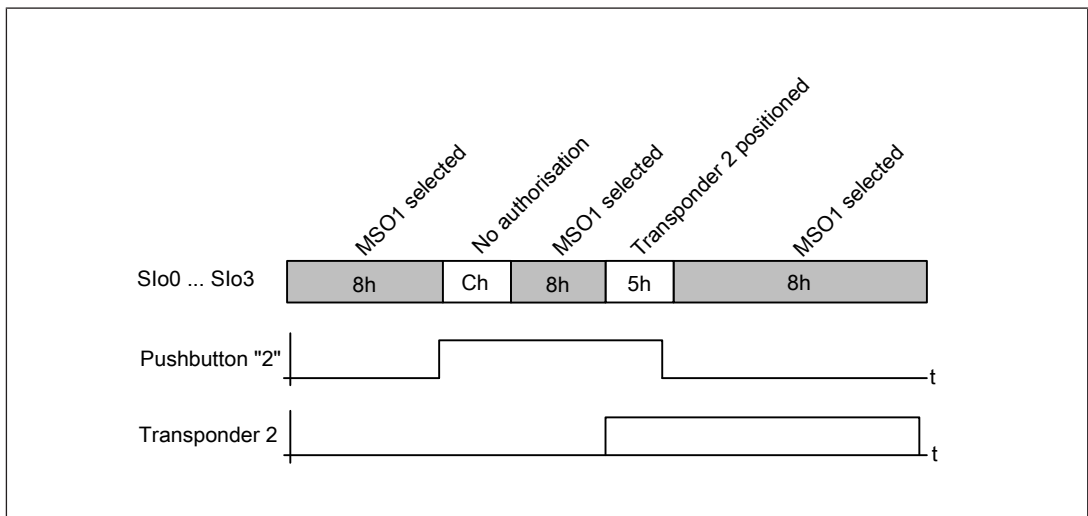



Fig.: Timing diagram for selecting the operating mode before the transponder key is inserted

**4.3.1.4**

**Application error: "Pushbutton operated incorrectly"**

The following timing diagrams show how status information is registered at outputs Slo0 ... Slo3, based on the application errors "Pushbutton operated incorrectly".

Legend:

	Message is displayed constantly
	Message is displayed briefly (200 ms)
MSO	Mode of safe operation (operating mode)

### Multiple pushbuttons operated

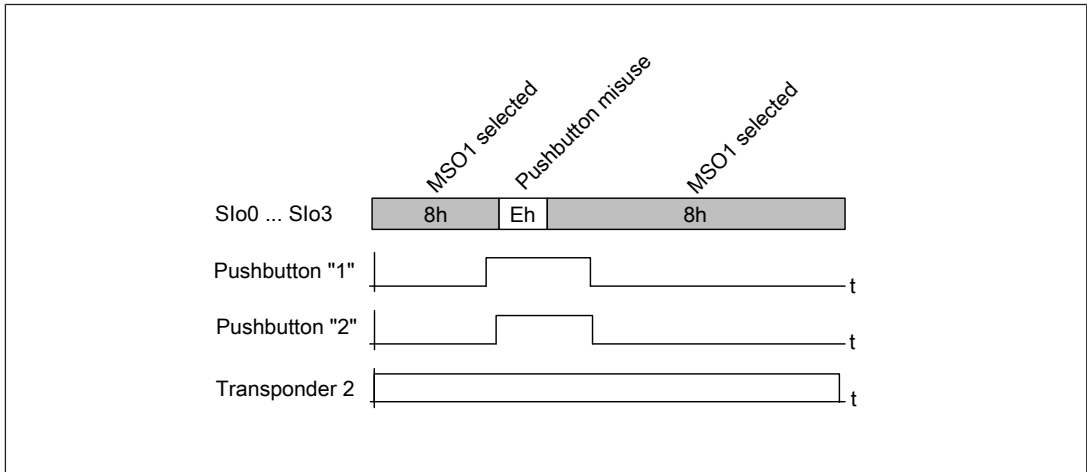

Fig.: Timing diagram for "Multiple pushbuttons operated"

### Pushbutton operated for too long

- ▶ "Pushbutton operated for too long" with "Key Mode 01" ... "Key Mode 04" permissions
- or
- ▶ "Pushbutton operated for too long" with "Key Service" permission

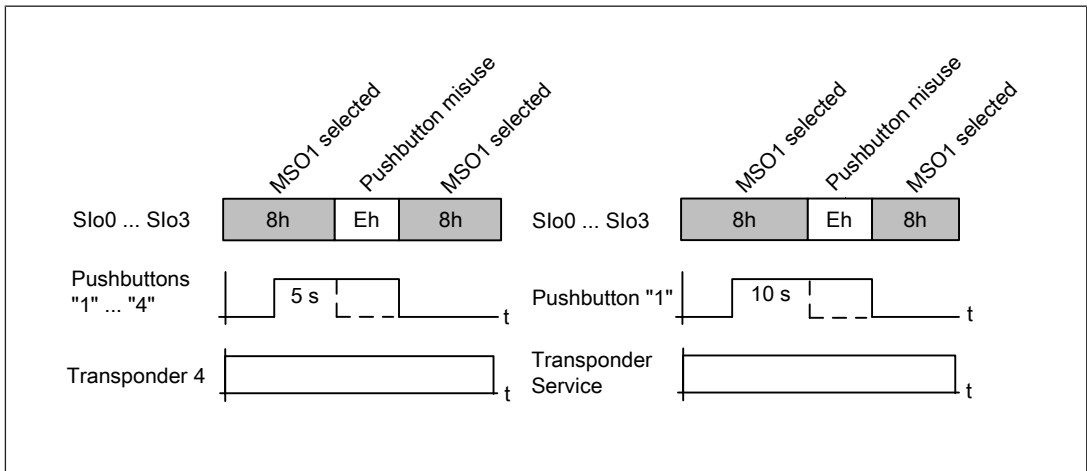

Fig.: Timing diagram for "Pushbutton operated for too long"

**Pushbutton was released after the transponder key was removed**

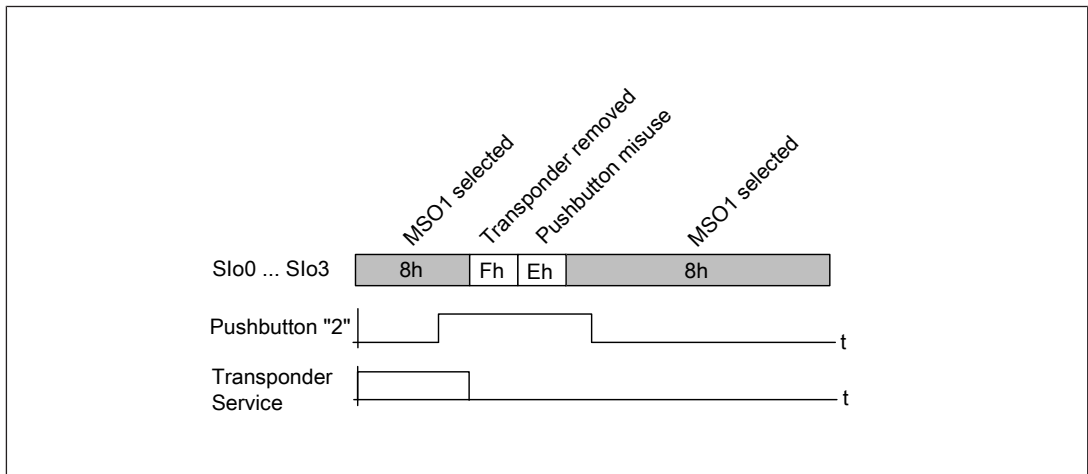

Fig.: Timing diagram for application errors when the pushbutton is released

## 4.4 Key ID interface

The Key ID interface (see [Block diagram \[14\]](#)) is used to download the Key ID number to a controller.

### 4.4.1 Key ID number of the transponder key

The Key ID number is used to clearly identify the transponder key and is unique. It is printed on the transponder key's type label as a 9-digit decimal figure.



#### NOTICE

##### Please note:

The Key ID number is **not** printed on the transponder key packaging.

If the transponder key is lost, it is impossible to supply a replacement transponder key with an identical Key ID number.

The Key ID number consists of two parts:

- ▶ Bit 27 = 24: Key Mode (0 ... 15<sub>D</sub>)
- ▶ Bit 23 = 00: Consecutive number (0 ... 999999999<sub>D</sub>)

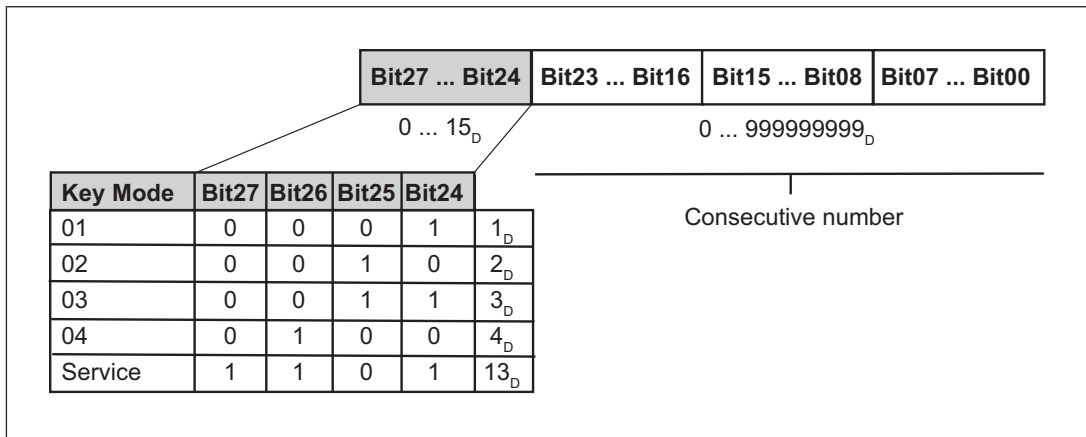
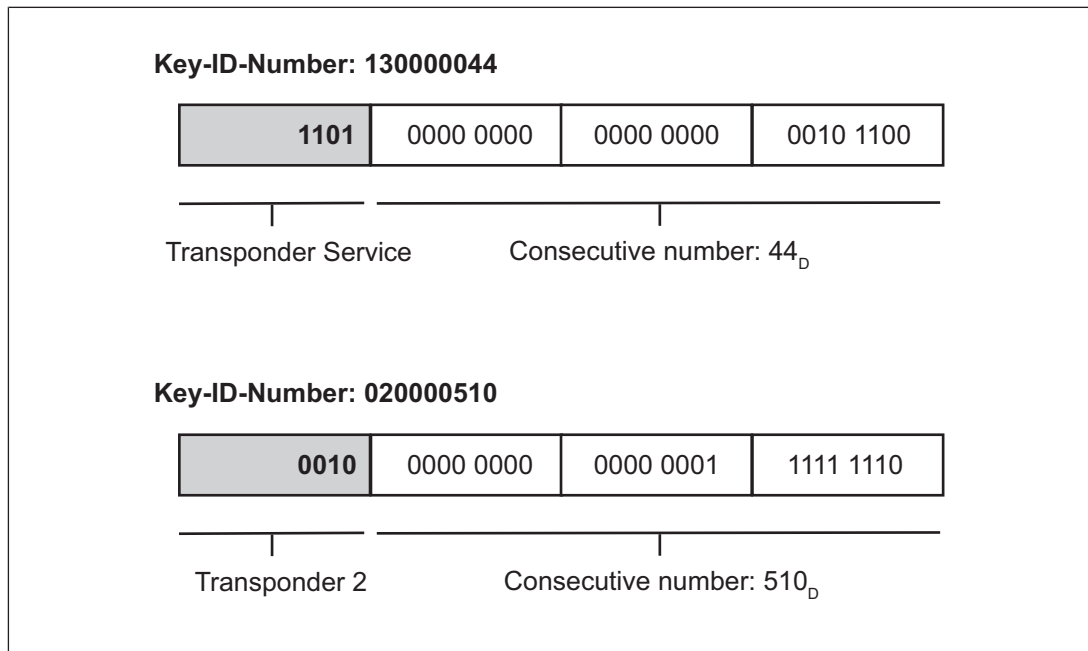

Fig.: Structure of the Key ID number

**Examples:****4.4.2 Communication mode for downloading the Key ID number**

The unique Key ID number for the relevant transponder key is downloaded to the higher-level process controller using a defined protocol, depending on the coded communication mode. The communication mode is coded on the Key ID interface of the operating mode selector switch (jumpers available/not available).

The operating mode selector switch detects the coded communication mode at each power-on. As long as voltage is applied to the operating mode selector switch, the coded communication mode will be active; the change in communication mode does not come into effect until the supply voltage is switched off and then on again.

It is possible to choose between the following communication modes:

- ▶ Transmitter-controlled communication mode
- ▶ Handshake-controlled communication mode
- ▶ Advanced communication mode

**4.4.2.1 Transmitter-controlled communication mode**

With transmitter-controlled communication mode, the download of the Key ID number is started by the operating mode selector switch (= transmitter).

Features of this communication mode:

- ▶ Download of Key ID number starts once the transponder key is connected
- ▶ Constant bit rate (100 ms)
- ▶ Download on 2 data lines
- ▶ Constant download time (typ. 1.8 s)
- ▶ Monitored data download
- ▶ Input/outputs required on the controller: 4 inputs and 2 outputs
- ▶ Download is repeated by reconnecting the transponder key

No special coding is required on the Key ID interface in order to download the Key ID number of a transponder key to the controller in transmitter-controlled communication mode. The terminals (see also [Terminal assignment \[48\]](#)) on the Key ID interface are used as follows:

Key ID interface	Brief description of application	Assignment control system	Coding
IDo0	IDSync	Input	No coding required
IDo1	IDclock	Input	
IDo2	IDout0	Input	
IDo3	IDout1	Input	
IDi0	IDin0	Output	
IDi1	IDin1	Output	

#### 4.4.2.2 Handshake-controlled communication mode

With handshake-controlled communication mode, the download of the Key ID number is started by the controller (Request).

Features of this communication mode:

- ▶ Download starts via a request to the controller, once the transponder key is connected
- ▶ Download is repeated by a renewed request to the controller
- ▶ Variable bit rate (min. 2 PLC cycles per bit)
- ▶ Download on 1 data line
- ▶ Min. download time: 28 Bit \* (20 ms + 2 \* PLC cycle)
- ▶ Identifier for ID end for feasibility check
- ▶ Input/outputs required on the controller: 3 inputs and 1 output

The Key ID interface must be coded with a jumper between IDo3 and IDi1 in order to download the Key ID number of a transponder key to the controller in handshake-controlled communication mode. The terminals (see also [Terminal assignment \[48\]](#)) on the Key ID interface are used as follows:

Key ID interface	Brief description of application	Assignment control system	Coding
IDo0	IDSync	Input	Coding via jumpers   <span style="display: inline-block; vertical-align: middle; margin-left: 10px;">IDo3    Coding: OUT</span>  <span style="display: inline-block; vertical-align: middle; margin-left: 10px;">IDi1    Coding: IN</span>
IDo1	IDresponse	Input	
IDo2	IDdata	Input	
IDo3	<i>Coding: OUT</i>	n. c.	
IDi0	IDrequest	Output	
IDi1	<i>Coding: IN</i>	n. c.	



In handshake-controlled communication mode, the operating mode selector switch can be operated in a functional variant. In this case the Key ID number of the transponder key is not downloaded to the controller. The controller is only used to evaluate IDsync on the Key ID interface. In this case IDsync is used as a signal output, enabling the controller to recognise whether the transponder key is valid/invalid. With this functional variant, only 1 input is required on the controller. The unused terminals on the Key ID interface (IDresponse, IDdata and IDrequest) may remain unwired ("open").

#### 4.4.2.3 Advanced communication mode

In advanced communication mode, the download of the Key ID number behaves in the same way as the handshake-controlled mode. It differs from the handshake-controlled communication mode in so far as an operating mode lock and operating mode pre-selection can be configured (see [Key lock](#) [41] and [Operating mode pre-selection](#) [43]).

##### Features of this communication mode:

- ▶ Download starts via a request to the controller, once the transponder key is connected
- ▶ Download is repeated by a renewed request to the controller
- ▶ Variable bit rate (min. 2 PLC cycles per bit)
- ▶ Download on 1 data line
- ▶ Min. download time: 28 Bit \* (20 ms + 2 \* PLC cycle)
- ▶ Identifier for ID end for feasibility check
- ▶ Input/outputs required on the controller: 3 inputs and 3 outputs

To enable the Key-ID number of a transponder key to be downloaded to the controller in advanced communication mode, the DIP switch must be set accordingly (see [Switch behaviour after a transponder key is removed](#) [20]). The terminals (see also [Terminal assignment](#) [48]) on the Key ID interface are used as follows:

Key ID interface	Brief description of application	Assignment control system	Coding
IDo0	IDresponse	Input	Configuration via DIP switch setting
IDo1	IDrequest	Output	
IDo2	IDdata	Input	
IDo3	IDsync	Input	
IDi0	keylock	Output	
IDi1	ack	Output	

### 4.4.3 Evaluation by a controller

#### 4.4.3.1 Evaluation of the Key ID number with transmitter-controlled communication

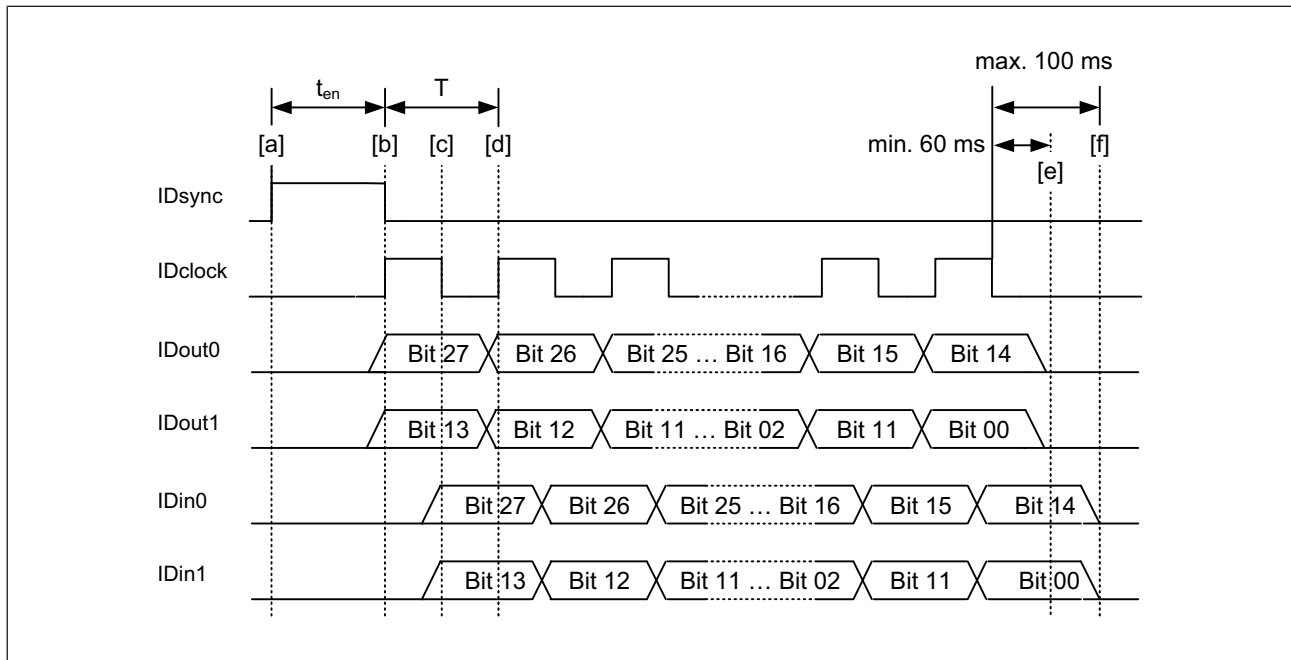

Fig.: Timing diagram for transmitter-controlled signal download

#### Legend

To assign the terminal designations to the short descriptions, please note the table in [Transmitter-controlled communication mode \[31\]](#).

IDsync	Control line The signal is generated by the operating mode selector switch. "0" signal No transponder key is connected or the transponder key that is connected is invalid. "1" signal A valid transponder key is created. The operating mode selector switch signals to the controller when the download starts. The signal is present for 100 ms.
IDclock	Test pulse line The signal is generated by the operating mode selector switch and indicates the validity of the data bits at IDout0 and IDout1. ▶ T = 100 ms ▶ Duty cycle = 50%
IDout0, IDout1	Data lines for transmitting the Key ID number The operating mode selector switch sends the Key ID number to the controller via these two data lines. IDout0: Send Bit 27 ... Bit 14 IDout2 Send Bit 13 ... Bit 00
IDin0, IDin1	Data line for reading back the Key ID number The controller sends the previously received Key ID number back to the operating mode selector switch via these two data lines. IDin0: Receive Bit 27 ... Bit 14 IDin1 Receive Bit 13 ... Bit 00

### Download procedure

- [a] The operating mode selector switch sets the signal at IDsync (control line) to "1" for 100 ms, thereby signalling to the controller that transmission has started.
- [b] A rising edge at IDclock (test pulse line) indicates that the data at data lines IDout0 and IDout1 is present and valid and can be read by the controller.
- [c] Until the falling edge at IDclock (test pulse line), the controller must have sent the previously read bit back to the operating mode selector switch via the data lines IDi0 and IDi1.
- [d] From the rising edge IDclock (test pulse line), the operating mode selector switch reads the bits sent back to IDi0 and IDi1 by the controller and checks it for equivalence.
- [e] At least 60 ms after the falling edge at IDclock (test pulse line), the last bit sent back by the controller must be present at data lines IDin0 and IDin1.
- [f] A maximum of 100 ms after the falling edge at IDclock (test pulse line), the last bit sent back by the controller must be present at data lines IDin0 and IDin1; in other words, by this point at the latest, data transfer must be completed and the data lines must have a "0" signal.



#### INFORMATION

If the controller does not feed back the previously read Bits correctly, the download is aborted and restarted. The "IDsync" signal is set once again. The download is repeated until the Key ID number is downloaded completely.

The download of the Key ID number typically takes 1.8 s.

Flowchart for evaluating the Key ID interface

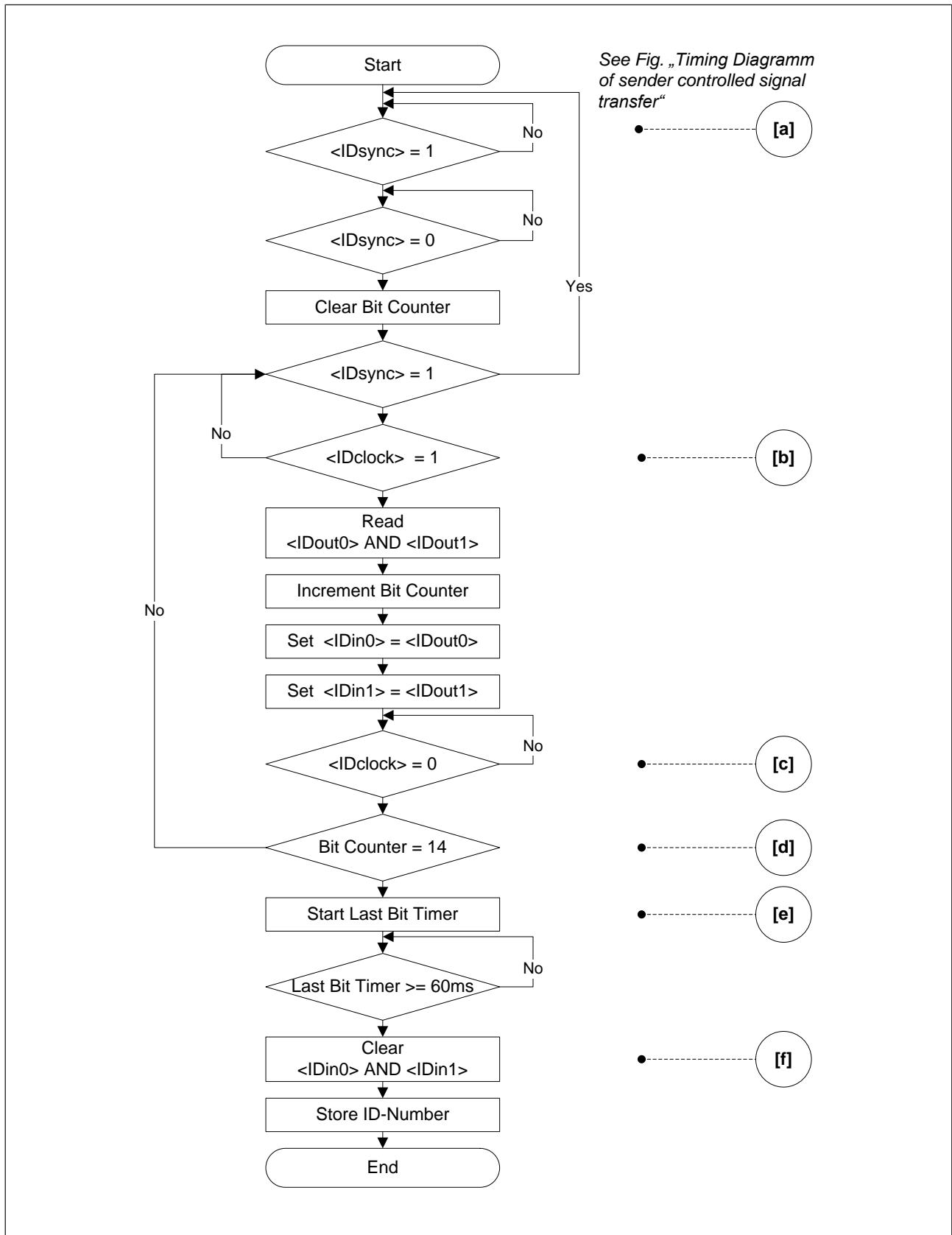

Fig.: Evaluation of the Key ID number via a controller (principle)

### 4.4.3.2 Evaluation of the Key ID number with handshake-controlled communication

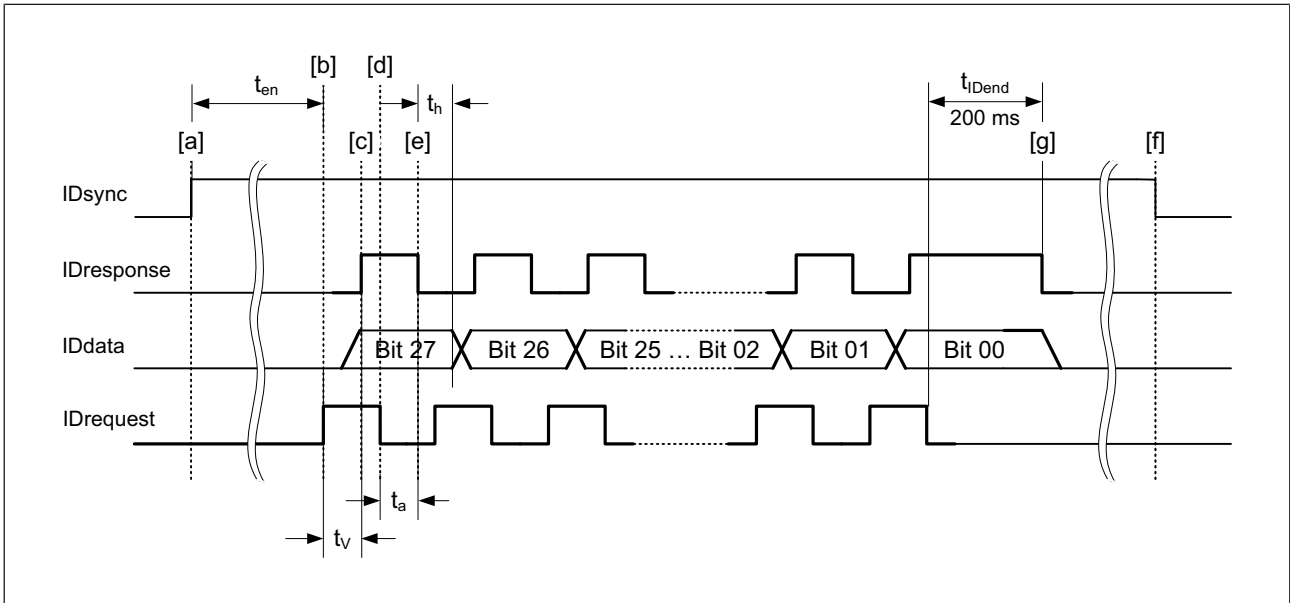

Fig.: Timing diagram for handshake-controlled signal download

#### Legend

To assign the terminal designations to the short descriptions, please note the table in [Handshake-controlled communication mode \[32\]](#).

IDsync	Control line The signal is generated by the operating mode selector switch.
"0" signal	No transponder key is connected or the transponder key that is connected is invalid. The controller cannot request the Key ID number.
"1" signal	A valid transponder key is connected and the controller can request the Key ID number.
IDresponse	Handshake line (Response) The signal is generated by the operating mode selector switch and indicates whether a data bit at IDdata is valid/invalid.
"0" signal	The data bit at IDdata is invalid and may not be evaluated.
"1" signal	The data bit at IDdata is valid and may be evaluated.
IDdata	Data line for downloading the Key ID number The Key ID number (28 Bit) is generated by the operating mode selector switch. The download begins with MSB (Bit27 ... Bit00).
IDrequest	Handshake line (Request) The signal is generated by the controller.
"0" signal	No bit is requested at IDdata
"1" signal	A new bit is requested at IDdata.

$t_{en}$	IDsync Enable Time (min. 0 ms)
$t_v$	Data Output Valid Time (max. 10 ms)
$t_h$	Data Output Hold Time (min. 0 ms)
$t_a$	Data Output Access Time (max. 10 ms)
$t_{IDend}$	End of Key ID Number Transfer (200 ms) After the last falling edge at IDrequest, the operating mode selector switch still has a "1" signal at output IDresponse for 200 ms. In this way, the end of the Key ID number and therefore the end of the download (End of Key ID Number Transfer) is displayed. This can be used for the feasibility check.

### Download procedure

- [a] "1" signal at IDsync (control line):  
A valid transponder key is present at the operating mode selector switch.
- [b] "1" signal at IDrequest (handshake line):  
The controller requests a data bit at data line IDdata.
- [c] "1" signal at IDresponse (handshake line):  
The operating mode selector switch confirms the validity of the data bit at data line IDdata.
- [d] "0" signal at IDrequest (handshake line):  
The controller confirms that it has read the requested data bit without error.
- [e] "0" signal at IDresponse (handshake line):  
The operating mode selector switch is ready to issue a new data bit at data line IDdata.
- [f] "0" signal at IDsync (control line):  
The transponder key was removed.
- [g] The controller must request all the data bits of a Key ID number (Bit27 ... Bit00). Only then is it possible to start downloading a new Key ID number. The end of the download is indicated by the signal extension ( $t_{IDend}$ ) at IDresponse.

Status diagram for handshake-controlled signal download

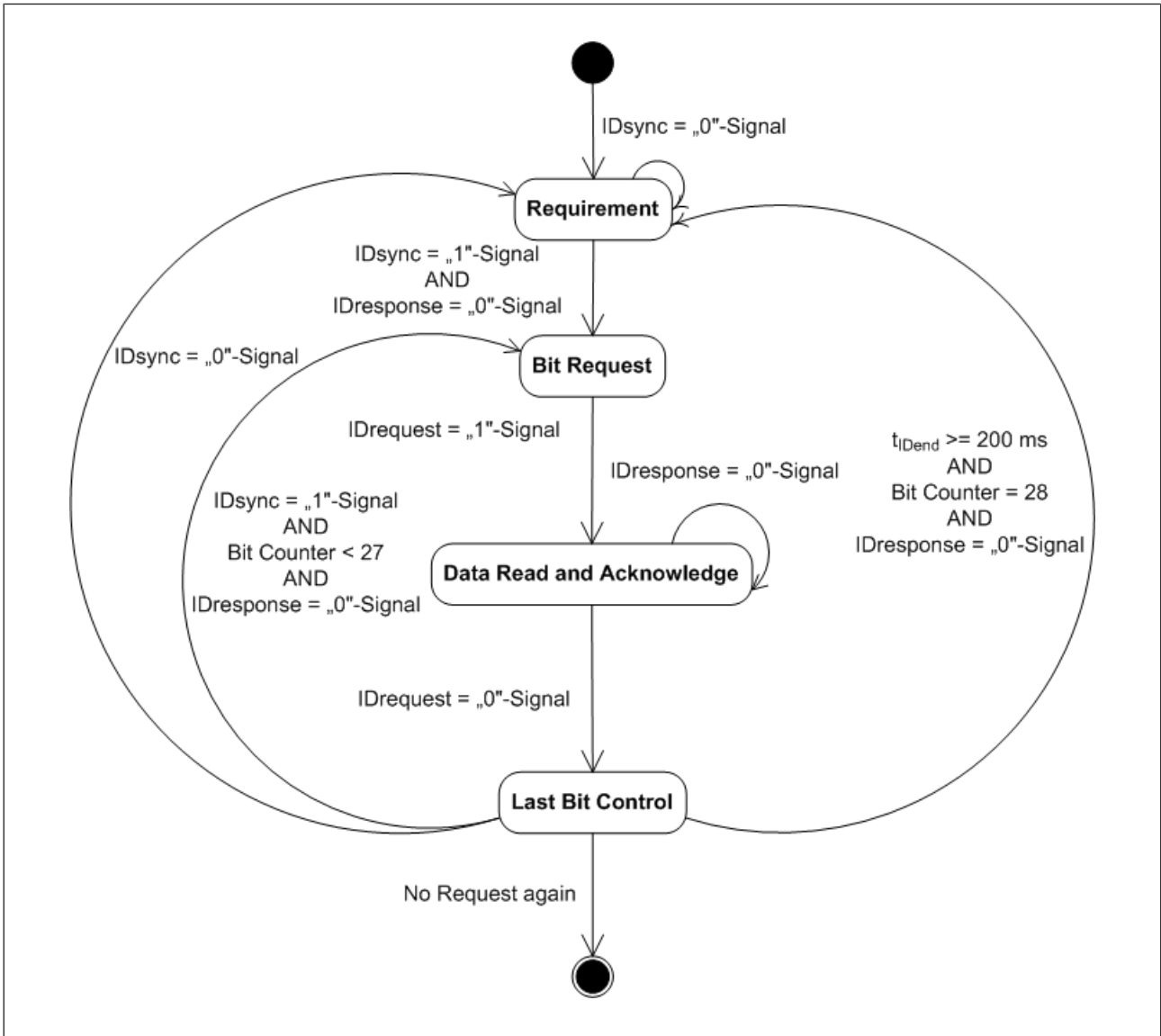

Fig.: Status diagram for handshake-controlled signal download

Flowchart for evaluating the Key ID interface

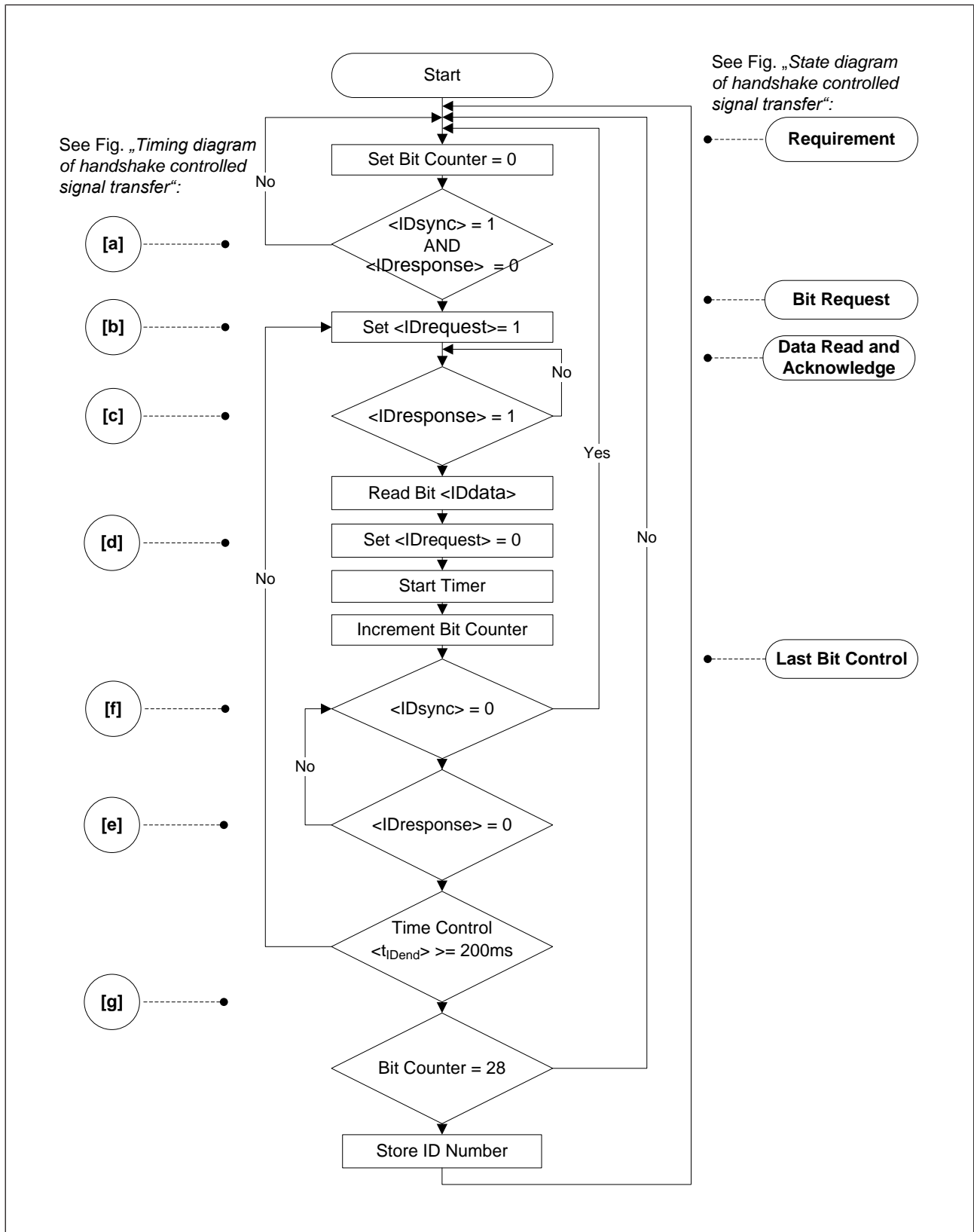

Fig.: Evaluation of the Key ID number via a controller (principle)



#### 4.4.3.3 Evaluation of the Key ID number with advanced communication

Evaluation of the Key ID number in advanced communication mode is identical to the handshake-controlled communication mode. Please refer to the timing diagram and the flow-chart from the previous section [Handshake-controlled communication mode](#) [32].

In advanced communication mode, the two control signals are added:

- ▶ ack → to adopt the preselected operating mode
- ▶ keylock → to disable the change of an operating mode

Both signals are sent from the controller to the operating mode selector switch. They are standard inputs that do **not** affect the safety function of the operating mode selector switch.

## 4.5 Operating mode lock and operating mode preselection

### 4.5.1 Operating mode lock

The operating mode lock is to enable and disable the request for a change of operating mode via a digital input.

A change of operating mode can be triggered by:

- ▶ Operating the pushbutton
- ▶ Removing the transponder key with an OM fallback and with a service fallback

When a change of operating mode is requested during the operating mode lock,

- ▶ the corresponding pushbutton backlighting flashes briefly,
- ▶ the status information interface signals "No authorisation" and
- ▶ the operating mode outputs do not switch.

You can deactivate the function, although it is configured. To do this, connect a "1" signal to input IDi0.



#### NOTICE

The operating mode lock is **not** a safety-related function. Switching of the operating mode has to be validated in accordance with the requirements.

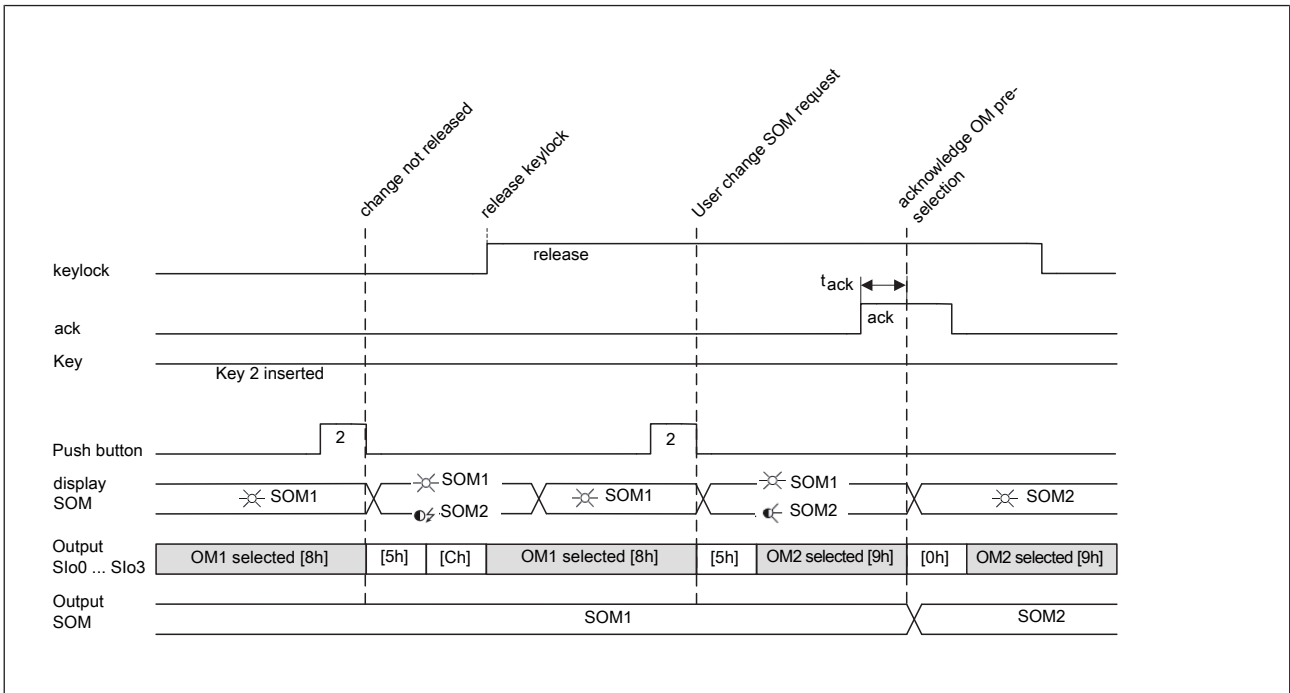

Fig.: Changing the operating mode after operating the pushbutton, with DIP switch settings [5] to [8]

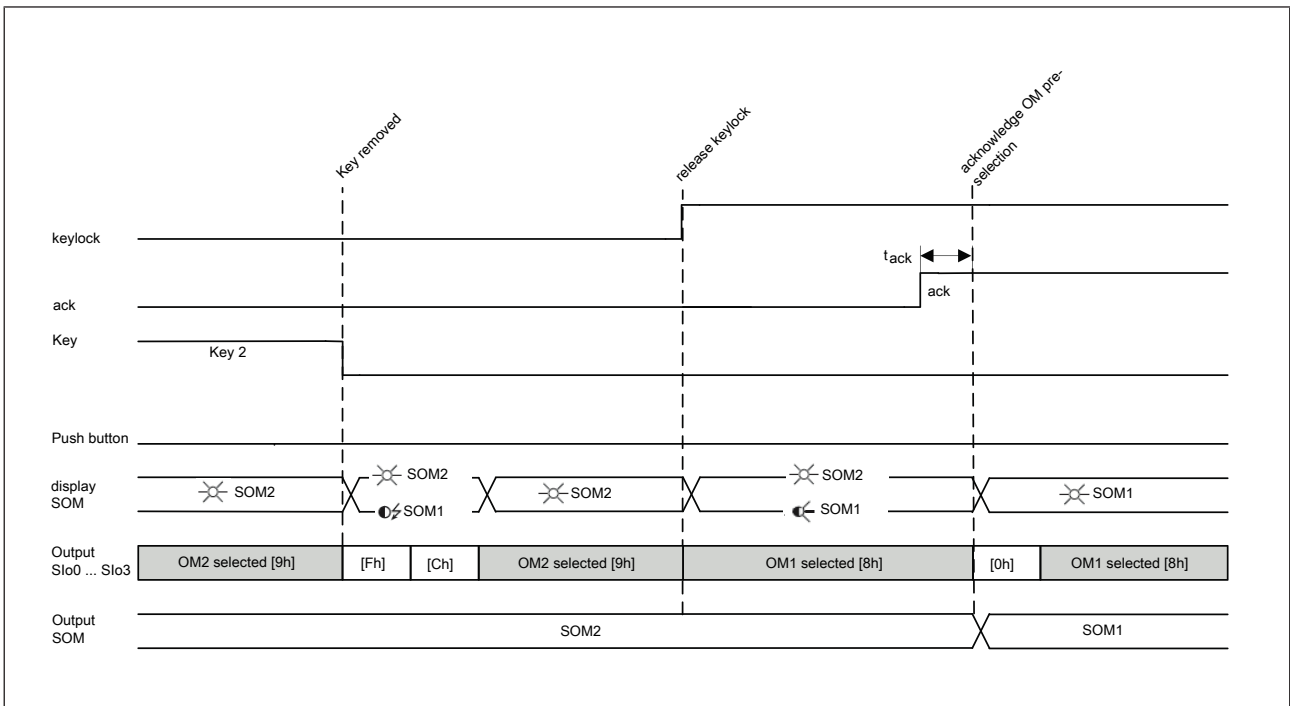

Fig.: Changing the operating mode after removing the transponder key, with DIP switch settings [7]

**Legend**

To assign the terminal designations to the short descriptions, please refer to the table in [Advanced communication mode \[33\]](#).

$t_{ack}$  Acknowledge Time min. 120 ms.

keylock	Control signal is generated by the controller and must be present for at least 20 ms for the signal state to be adopted
"0" signal	Locking the change of operating mode and/or ending an operating mode preselection
"1" signal	Enabling the change of operating mode and/or resuming an operating mode preselection
ack	Control signal is generated by the controller. "0" signal must be present for at least 20 ms for the signal state to be adopted.
"0" signal	Preventing the switching of operating mode outputs
"1" signal	Enabling the switching of operating mode outputs
display SOM	Pushbutton backlighting
Output Slo0 ... Slo3	Interface for control information
Output SOM	Operating mode outputs

## 4.5.2 Operating mode pre-selection

The function of the operating mode pre-selection is to prevent or to confirm the changing of the operating mode during the change of the operating mode by a digital input, depending on the process requirement. Only the last operating mode preselection is confirmed by the controller.

You can deactivate the function, although it is configured. To do this, connect a "1" signal to input IDi1.

### Display during the operating mode preselection

- ▶ The display element indicates the selected operating mode by being lit continuously. The flashing of a display element indicates a preselected operating mode (see Status information via the signal outputs).
- ▶ The status information interface outputs the preselected operation mode (see [Interface for status information](#) [📖 21]).
- ▶ The selected operating mode is output by the operating mode outputs (see [Operating mode interface](#) [📖 20]).

When OM storing is configured, the last confirmed operating mode is taken during device restart. The operating mode preselection is not stored.

### Display in accordance with the operating mode selection when it has been confirmed

- ▶ Operating mode outputs switch to the preselected operating mode.
- ▶ The interface for status information still displays the same operating mode and confirms the transfer of the preselected operation mode to the selected operating mode with the status information "Operating mode preselection switched" (see [Interface for status information](#) [📖 21]).
- ▶ The pushbutton backlighting for the newly selected operating mode is lit continuously and the pushbutton backlighting for the last confirmed operating mode goes out.

### Undoing an operating mode preselection

By user:

- ▶ Operating the pushbutton with the selected operating mode (being lit continuously)
- ▶ Inserting the transponder key with OM fallback and service fallback; authorisation must be equal or higher than the previously removed authorisation.

By controller:

- ▶ "0" signal at the input keylock

Please note that removing the actuator does not reset the operating mode preselection.



#### NOTICE

The operating mode preselection is **not** a safety-related function. Switching of the operating mode has to be validated in accordance with the requirements.

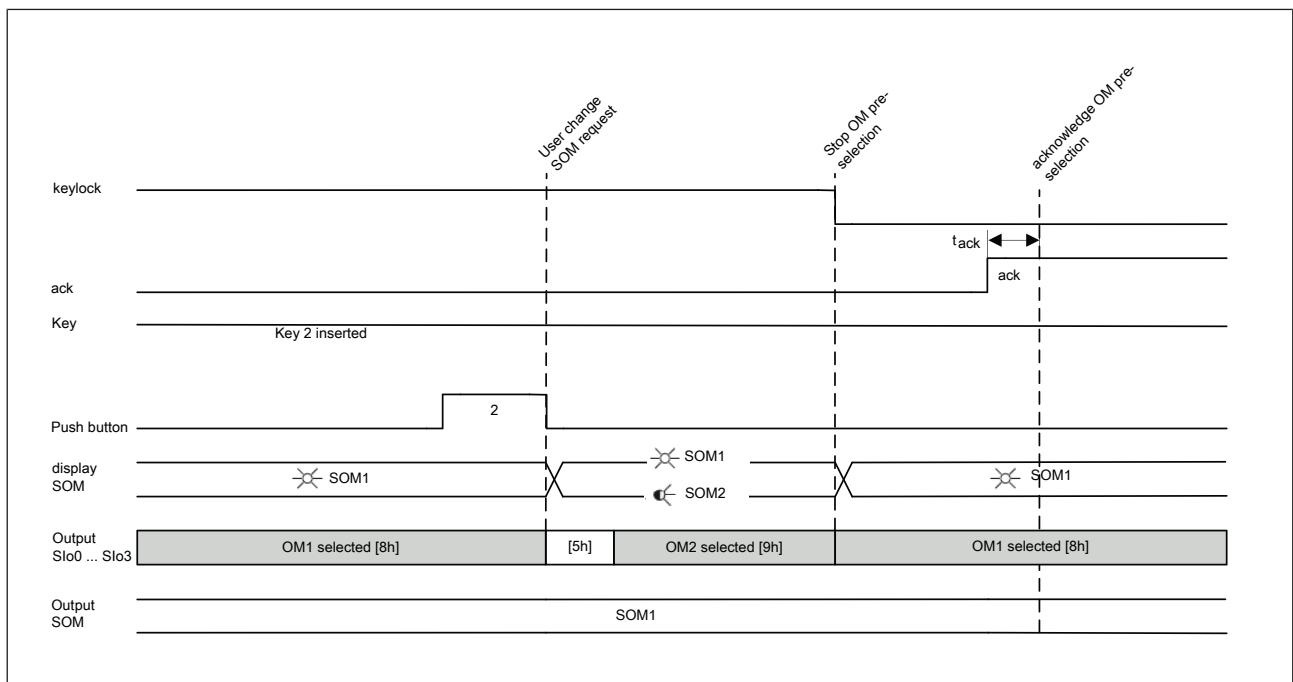

Fig.: Exiting the operating mode preselection after operating the pushbutton, with DIP switch setting [5] to [8]

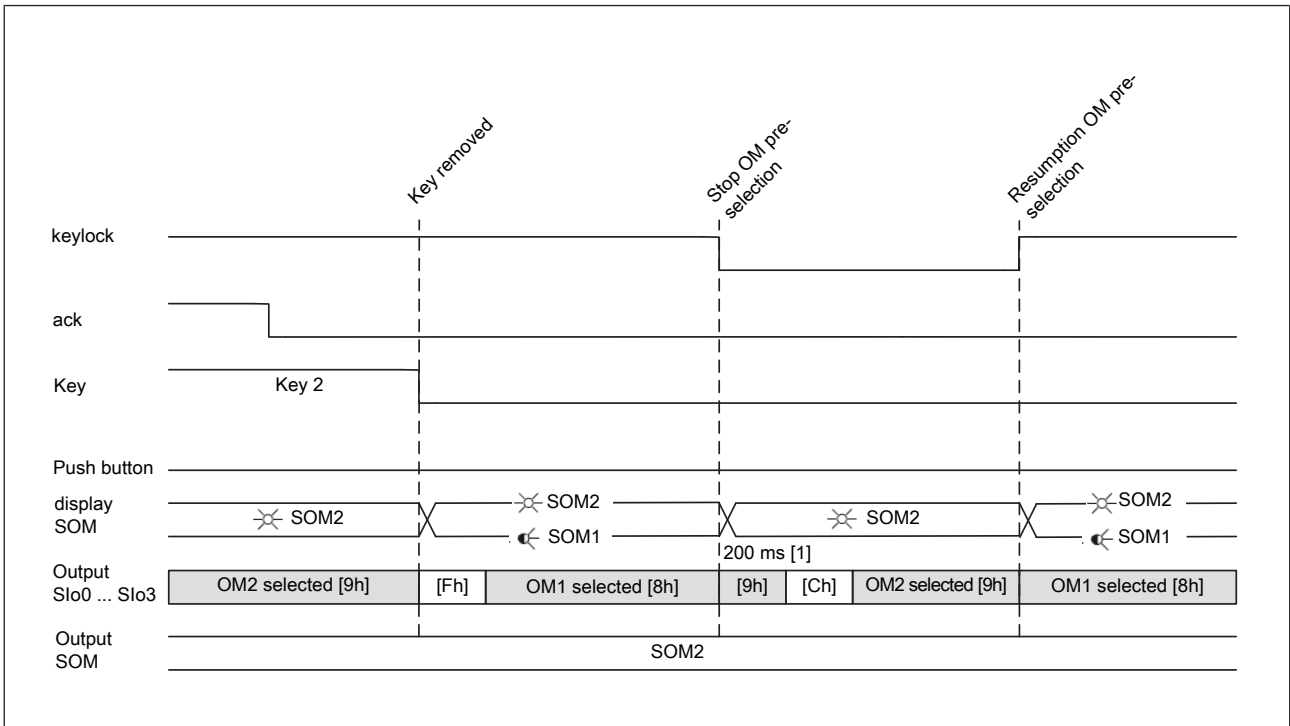

Fig.: Exiting the operating mode preselection after removing the transponder key, with DIP switch setting [7]

### Legend

To assign the terminal designations to the short descriptions, please refer to the table in [Advanced communication mode \[33\]](#).

$t_{ack}$	Acknowledge Time min. 120 ms.
keylock	Control signal is generated by the controller and must be present for at least 20 ms for the signal state to be adopted
"0" signal	Locking the change of operating mode and/or ending an operating mode preselection
"1" signal	Enabling the change of operating mode and/or resuming an operating mode preselection
ack	Control signal is generated by the controller. "0" signal must be present for at least 20 ms for the signal state to be adopted.
"0" signal	Preventing the switching of operating mode outputs
"1" signal	Enabling the switching of operating mode outputs
display SOM	Pushbutton backlighting
Output Slo0 ... Slo3	Interface for control information
Output SOM	Operating mode outputs

## 5 Installation

### 5.1 General installation guidelines

- ▶ The installation site must conform to the protection type IP65.
- ▶ Ensure that the operating mode selector switch has sufficient ventilation.
- ▶ Attach the operating mode selector switch using the brackets provided.
- ▶ Do not exceed the max. torque setting of 0.30 Nm. The locking hooks can break off if the torque setting is too high.
- ▶ Make sure that the gasket is seated correctly.
- ▶ Please refer to the regulations in EN 60204-1 with regard to the protective earth system.

### 5.2 Dimensions in mm

Front view

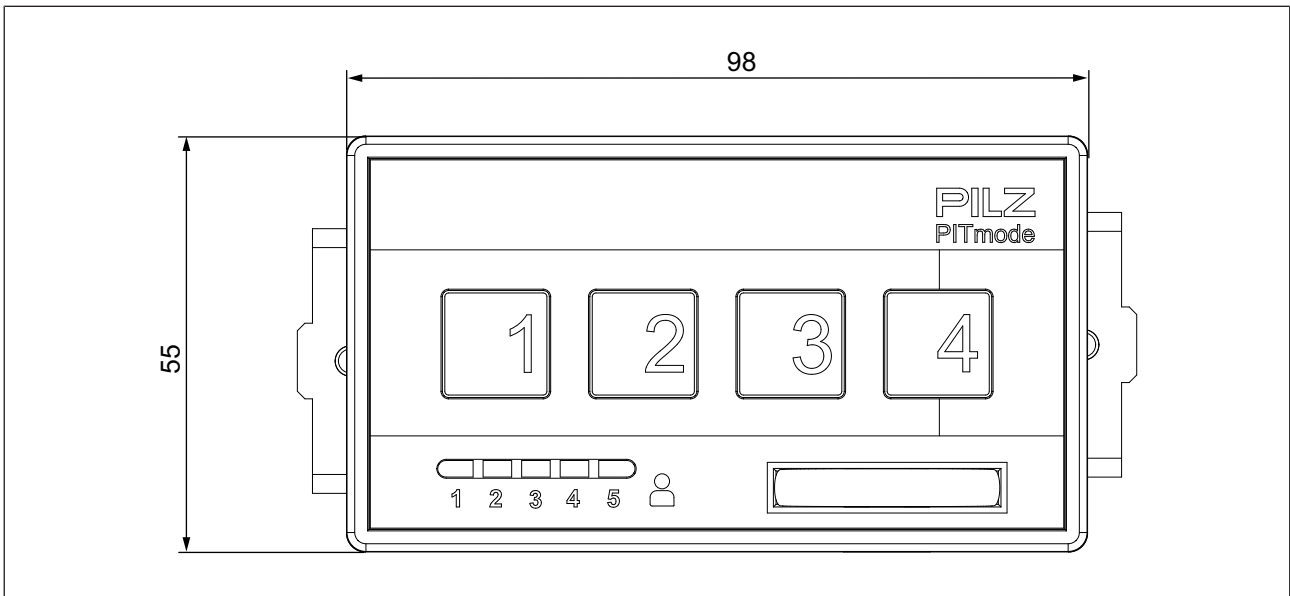

View from below

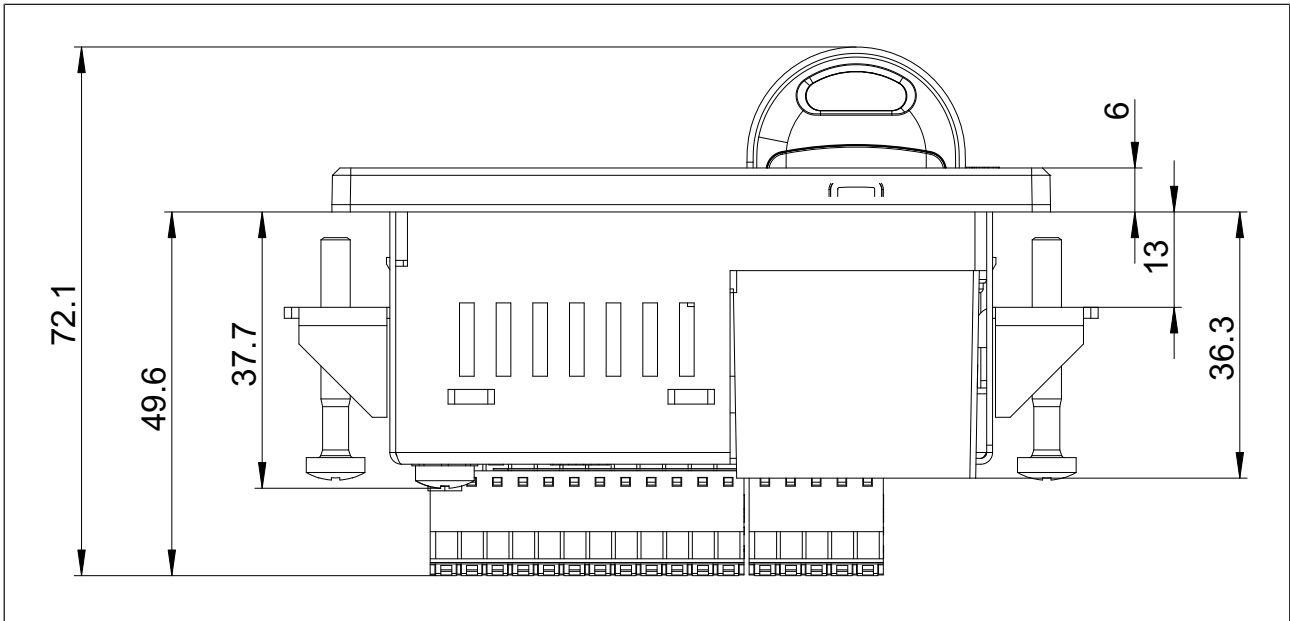

### 5.3 Mounting cutout

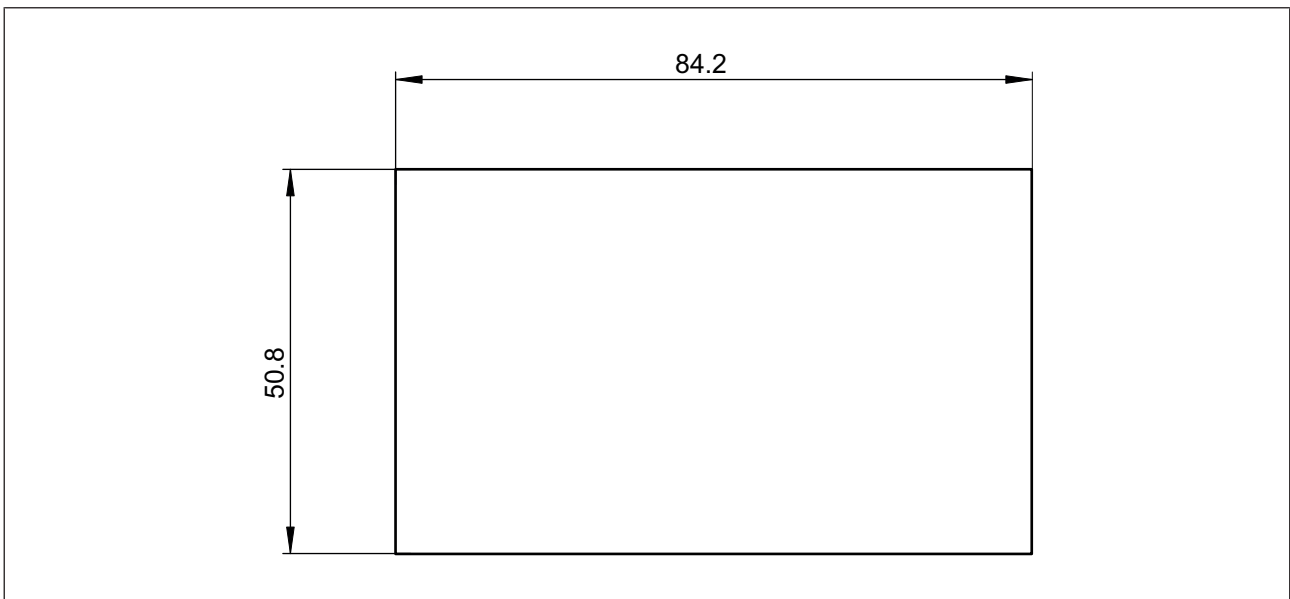

## 6 Wiring

### 6.1 Terminal configuration



**INFORMATION**

The connection terminals are not supplied with the unit.

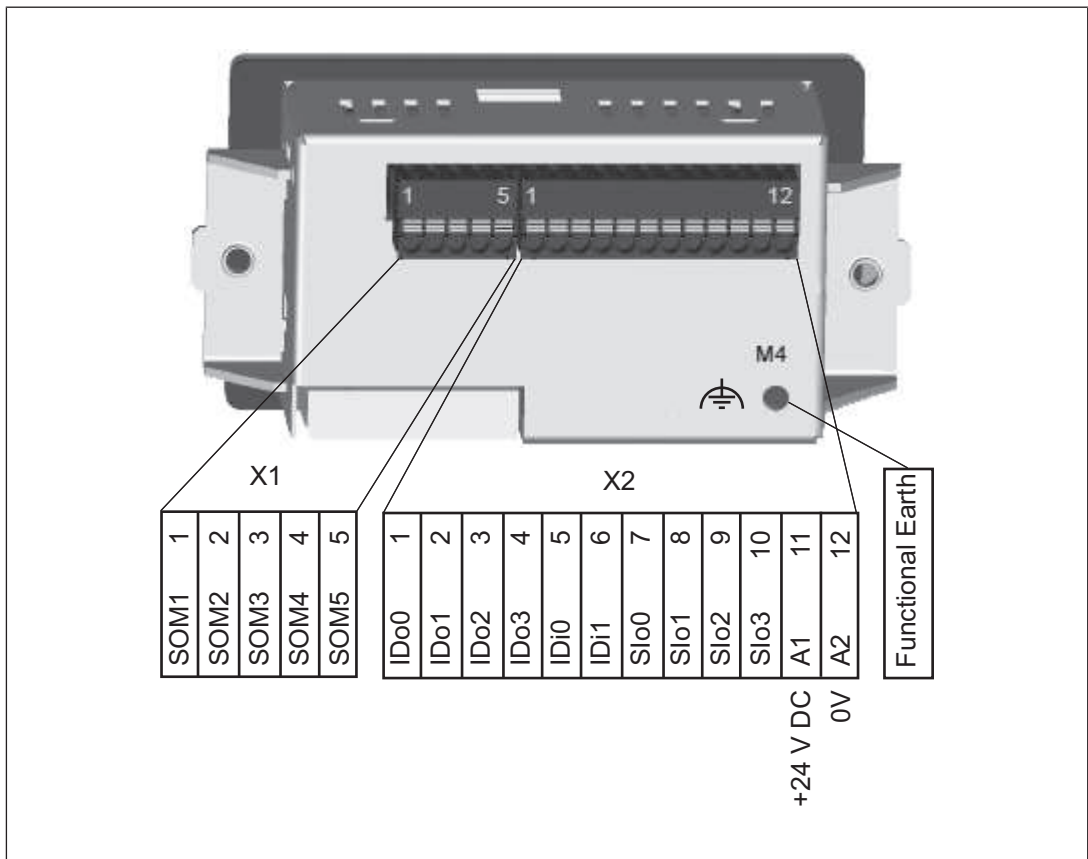

Fig.: Terminal configuration

**Legend**

- SOM1 .. SOM5    Operating mode interface: Monitored semiconductor outputs for the operating modes OM1 ... OM5
- IDo0 ... IDo3    Key ID interface: Semiconductor outputs for sending the output signals to the control system  
The function of the terminals depends on the communication mode that has been configured.
- IDi0 ... IDi1    Key ID interface: Inputs for receiving the input signals from the control system  
The function of the terminals depends on the communication mode that has been configured.
- Slo0 ... Slo3    Interface for status information Evaluation of status information
- A1, A2            Terminals for connecting the supply voltage
- Functional earth





## 6.2 Connecting the unit



### INFORMATION

When installed in an earthed console, the functional earth must be connected.

Follow the instructions below:

1. Connecting the supply voltage
  - ⇒ Connect the supply voltage to (A1, A2).
    - It is essential to note:**  
The power supply must meet the regulations for extra low voltages with protective electrical separation (SELV, PELV).  
The cables for the device's supply voltage (A1, A2) must be fitted with a 4 A fuse, characteristic B/C.
2. Connect the operating mode interface's semiconductor outputs
  - ⇒ Connect the operating mode interface's semiconductor outputs to a control system that supports "1oon" evaluation.  
**You must read** the information concerning intended use (see [Intended use](#)  12]).
3. Connecting the terminals for the interface for status information
  - ⇒ Connect the terminals (Slo0 ... Slo3) to a controller that supports evaluation of the status information.
4. Code communication mode for downloading the Key ID number (alternative configuration via DIP switch settings, see [Configuration of functions](#)  16])
  - Coding via jumpers is not required for the transmitter-controlled communication mode.
  - To download the Key-ID number in handshake-controlled communication mode, code the Key-ID interface via a jumper between terminals IDo3 and IDi1.
  - Coding via jumpers is not required for advanced communication mode.
5. Connect the terminals of the Key ID interface
  - ⇒ Depending on the selected communication mode, connect the terminals of the Key ID interface to a controller that supports the download of the Key ID number.
  - or
  - ⇒ Connect IDsync to a controller, if all you wish to do in handshake-controlled communication mode is evaluate whether the transponder key is valid/invalid. In this case you will only use IDsync as a signal output. The unused terminals on the Key ID interface (IDresponse, IDdata and IDrequest) may remain unwired ("open").

## 6.3 Connection to a control system

When restarting, the device is in OM1 or in the last selected operating mode, depending on the device configuration.

Depending on the application area and its respective regulations, the device can be used up to SIL CL 2 (EN IEC 62061) and up to PL d (EN ISO 13849-1), if the operating modes are evaluated by a safety controller with safe "1oon" evaluation.

The examples below meet the following conditions:

- ▶ A PNOZ m1p is used as a safety control system.
- ▶ An "operating mode selector switch" function element is configured in the PNOZmulti Configurator for safe "1oon" evaluation.
- ▶ The Key ID interface and the interface for status information are evaluated via a higher-level process control system.
- ▶ The cables for the unit's supply voltage (A1, A2) contain a 4 A fuse, characteristic B/C.

Connection for transmitter-controlled communication mode

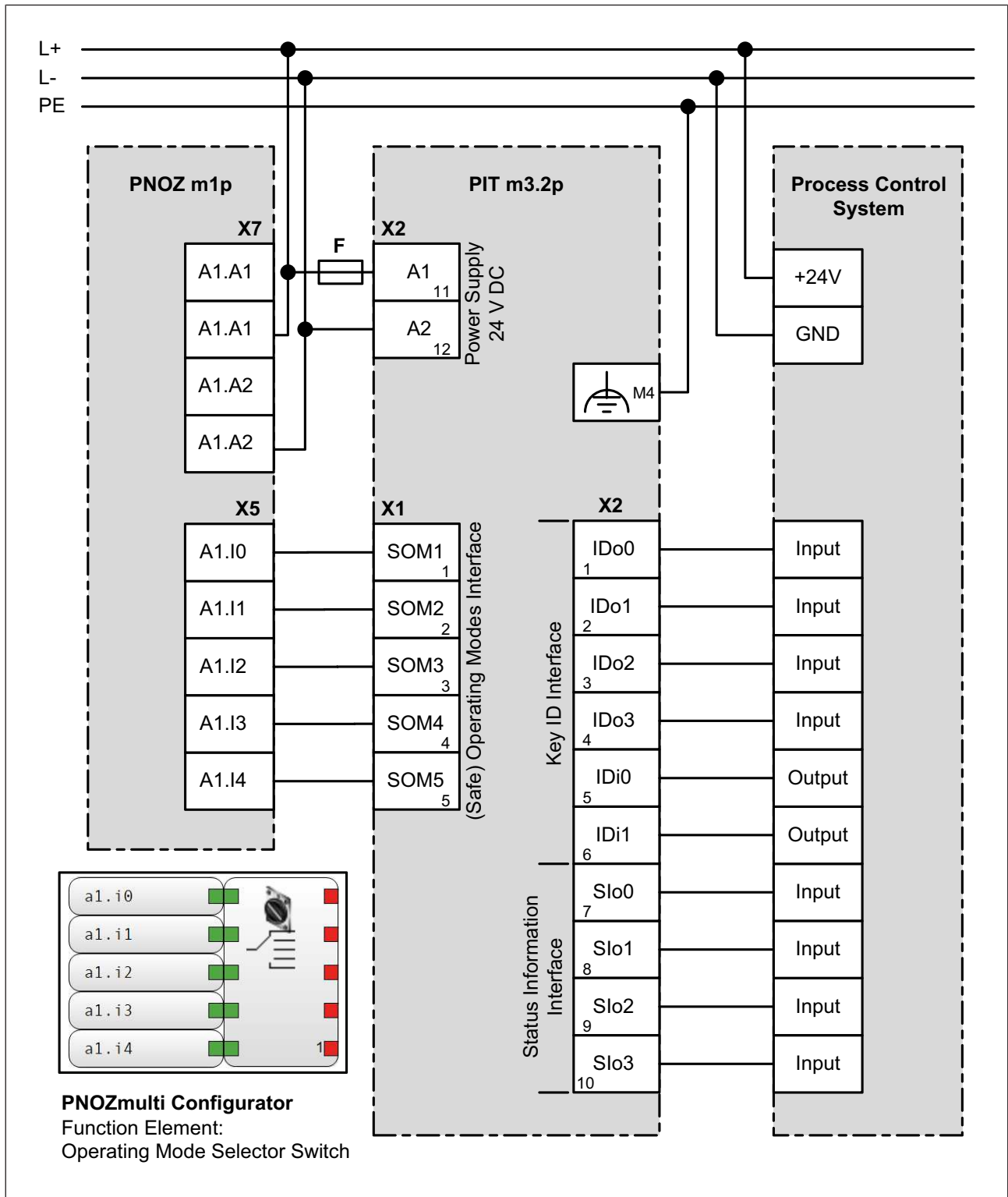

Fig.: Connection for transmitter-controlled communication mode (example)

Connection for handshake-controlled communication mode

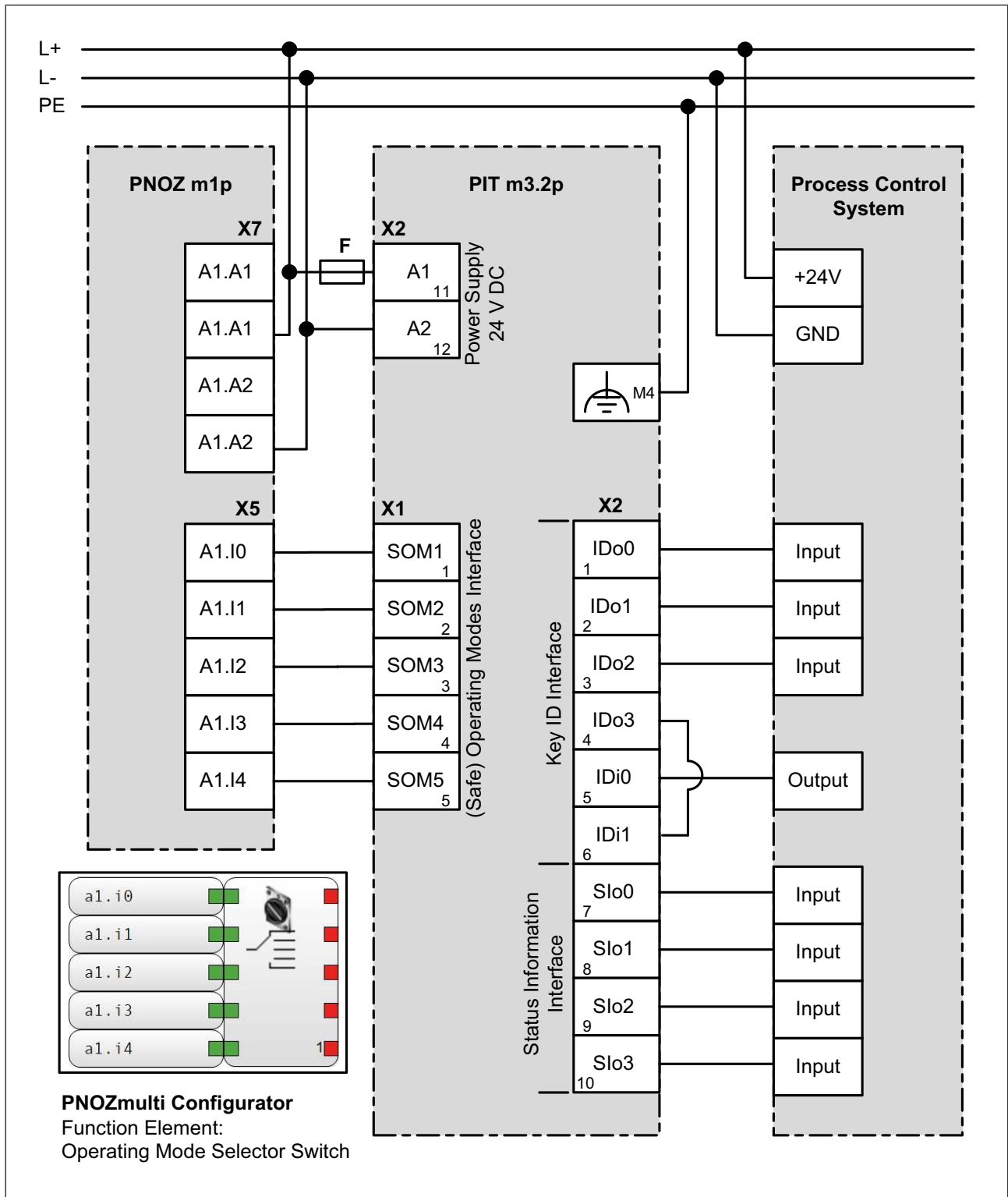

Fig.: Connection for handshake-controlled communication mode (example)

Connection for advanced communication mode

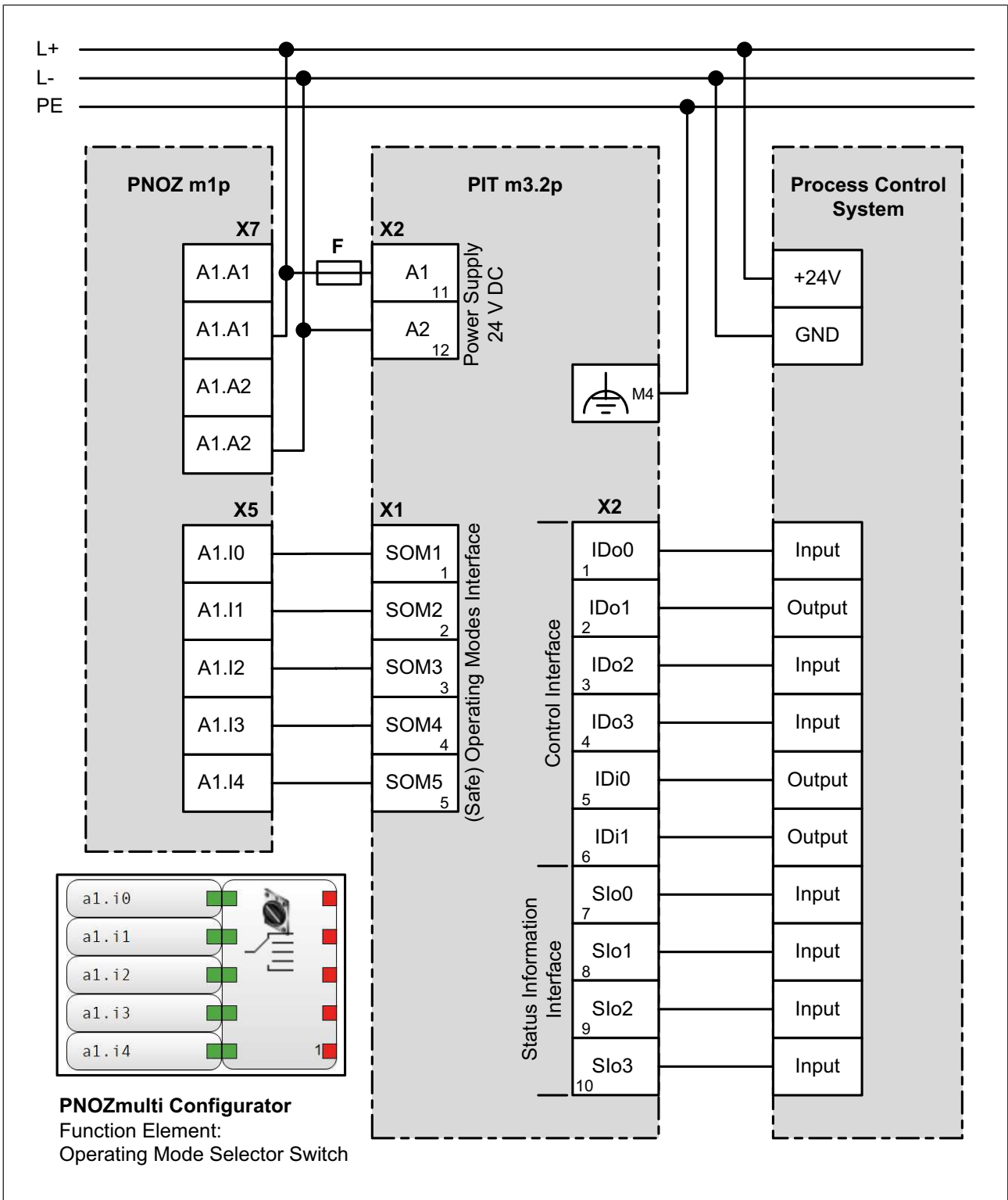

Fig.: Connection for advanced communication mode (example)

## 7 Operation

### Switch-on behaviour



#### INFORMATION

After the operating mode selector switch is switched on (Power-On) or after supply voltage is returned (reset), operating mode OM1 is selected automatically. This also applies if no transponder key is connected, or a transponder key is detected but is invalid.

### Behaviour in the event of an error in operating modes OM1 ... OM4



#### NOTICE

In the event of an error, the unit does **not** change operating mode. The active operating mode (OM1, OM2, OM3 or OM4) is displayed via the relevant backlit pushbutton and the assigned semiconductor output has a "1" signal.

### Behaviour in the event of an error in special operating mode OM5 (Service)



#### NOTICE

In the event of an error, the unit does **not** change operating mode. Faulty operation is indicated by the fact that all pushbuttons are either all lit or all out. The assigned semiconductor output has a "1" signal.

## 7.1 Select operating modes OM1 ... OM4

### Prerequisites

- ▶ A transponder key with the relevant authorisations must be present.
- ▶ The operating mode selector switch must recognise the transponder key as valid.
- ▶ The transponder key must be present at the operating mode selector switch for the whole time the button is operated.
- ▶ Several buttons may **not** be operated simultaneously when selecting an operating mode.

### Procedure

1. Establish the connection with the transponder key
  - ⇒ Insert the transponder key into the slot.  
**Note:** The transponder key must support the operating mode into which you wish to switch. The authorisation display LEDs provide information about the authorisations available with the relevant transponder key (see [Control elements](#) [📖 9]).
2. Select operating mode
  - ⇒ Select the required operating mode by pressing the relevant pushbutton. Please note the required operating time (see [Monitoring of operating time](#) [📖 56]). The operating mode has been selected correctly if the pushbutton is back-lit once it is released.
3. Complete operating mode selection
  - ⇒ Complete the operating mode selection by removing the transponder key. Once you have removed the transponder key, the operating mode selector switch behaves in accordance with the configuration (see [Switch behaviour after a transponder key is removed](#) [📖 20]).



#### INFORMATION

You can switch at will between the individual operating modes OM1, OM2, OM3 and OM4; i.e. it is possible to switch from OM1 to OM3 or from OM4 to OM2, for example.

## 7.2 Select special mode (service)

### Prerequisites

- ▶ A transponder key must be available with authorisation for special operating mode OM5 (Service).
- ▶ The operating mode selector switch must recognise the transponder key as valid.
- ▶ The transponder key must be present at the operating mode selector switch for the whole time the button is operated.
- ▶ Several buttons may **not** be operated simultaneously when selecting an operating mode.

**Procedure**

1. Establish the connection with the transponder key
  - ⇒ Insert the transponder key "Key Service" into the slot.  
**Note:** All authorisation display LEDs must light (see [Control elements \[9\]](#)).
2. Select special mode OM5 (Service)
  - ⇒ Operate pushbutton 1 (OM1).  
 Please note the required operating time (see [Monitoring of operating time \[56\]](#)). The operating mode has been selected correctly if all the pushbuttons flash when pushbutton 1 is released. The pushbuttons flash for as long as they are in special operating mode OM5 (Service).
3. Complete operating mode selection
  - ⇒ Complete the operating mode selection by removing the transponder key.  
 Once you have removed the transponder key, the operating mode selector switch behaves in accordance with the configuration (see [Switch behaviour after a transponder key is removed \[20\]](#)).



**INFORMATION**

Special operating mode OM5 (Service) can be selected from any of the operating modes.

## 7.3 Monitoring of operating time

A change of operating modes is only detected if the relevant button has been operated for a defined time period.

**Button's operating time**

Pushbutton	Operating mode	Output	Operating time
1	OM1	SOM1	> 50 ms and < 5 s
2	OM2	SOM2	
3	OM3	SOM3	
4	OM4	SOM4	
1	OM5 (Service)	SOM5	> 5 s and < 10 s



## 7.4 Switchover delay t1

Once a button has been released, the assigned output on the operating mode interface switches to a "1" signal after the switchover delay t1 has elapsed (see [Technical details \[62\]](#)). This defined switchover delay guarantees that only one operating mode at a time has a "1" signal at the assigned output.

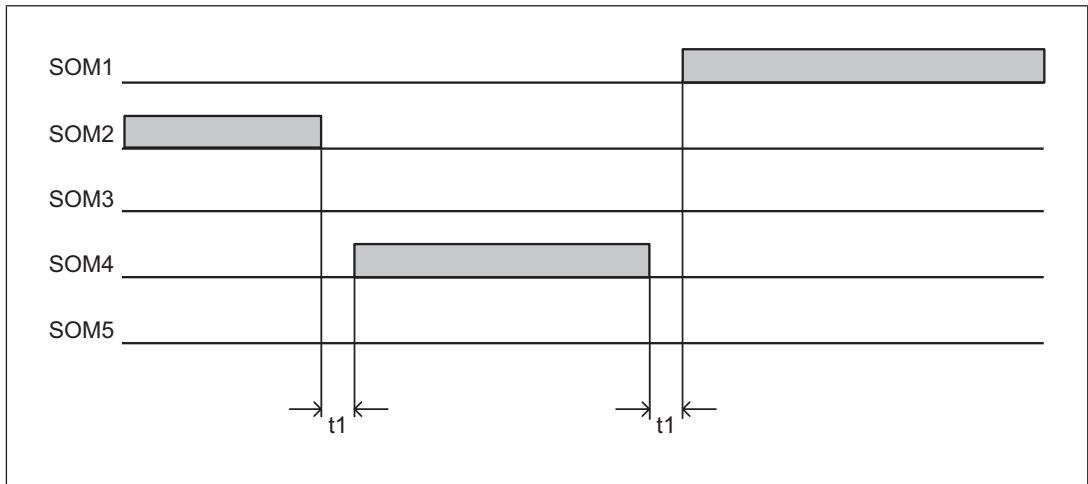

Fig.: Time behaviour when switching operating mode

## 7.5 Troubleshooting

If an error occurs on the operating mode selector switch, the last operating mode to be set will be retained.

Error	Possible cause	Remedy
Unable to switch the operating mode	Multiple operation of buttons	Make sure that only one button is operated
	Operating time too long or too short	Make sure that the period of operation is observed
	Transponder key is not detected	Make sure that the transponder key is connected to the operating mode selector switch or inserted correctly
	No valid authorisation	Make sure that you use a transponder key that has the required authorisation
Pushbutton backlighting and authorisation display remain switched off or they are frozen	Device error	Switch supply voltage off and then on again

Error	Possible cause	Remedy
Device error	The DIP switch setting was changed during operation	<a href="#">Delete error</a>
	One of the operating mode outputs SOM1 ... SOM5 stuck because of external voltage (stuck-at-1 or stuck-at-0)	Rectify error, switch supply voltage off and then on again
	Internal device error	Switch supply voltage off and then on again, change unit if necessary

Please refer to the timing diagram for [Device error](#) [25].

### 7.5.1 Delete error

Procedure:

- ▶ Switch off device (power off)
- ▶ Configure DIP switch setting as shown (all switches to ON)

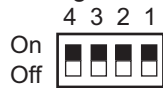

- ▶ Device restart → device error is still displayed
- ▶ Switch off device
- ▶ Configure required DIP switch position
- ▶ Device restart → Error deleted

## 7.6 Diagnostics

The operating mode selector switch has various options for displaying status information:

- ▶ Interface for status information (Slo0 ... Slo3)
- ▶ Button backlighting
- ▶ Authorisation display (LEDs 1 ... 5)

### 7.6.1 Status information about the interface for status information





Various status information can be signalled via the interface for status information (see [Block diagram \[14\]](#)). The status information can be evaluated through a control system (see [Interface for status information \[21\]](#)).











### 7.6.2 Status information about button backlighting





























Pushbuttons 1 ... 4 (see [Control elements \[9\]](#)) have pushbutton backlighting. Pushbutton backlighting is used to indicate which operating mode is active; in other words, which output (SOM 1 ... SOM5) has a "1" signal.

#### Evaluation of pushbutton backlighting

##### Legend

-  LED on
-  LED flashes
-  LED flashes briefly
-  LED off

LED pushbutton 1	LED pushbutton 2	LED pushbutton 3	LED pushbutton 4	Meaning
●	●	●	●	▶ No supply voltage
				▶ OM5 (Service) is active ▶ SOM1 has a "1" signal
	●	●	●	▶ OM1 is active ▶ SOM1 has a "1" signal
●		●	●	▶ OM2 is active ▶ SOM2 has a "1" signal
●	●		●	▶ OM3 is active ▶ SOM3 has a "1" signal
●	●	●		▶ OM4 is active ▶ SOM4 has a "1" signal
	 *	●	●	▶ No authorisation for OM1 or ▶ Operating mode lock active

LED pushbutton 1	LED pushbutton 2	LED pushbutton 3	LED pushbutton 4	Meaning
 *				<ul style="list-style-type: none"> <li>▶ No authorisation for OM2 or</li> <li>▶ Operating mode lock active</li> </ul>
 *				<ul style="list-style-type: none"> <li>▶ No authorisation for OM3 or</li> <li>▶ Operating mode lock active</li> </ul>
 *				<ul style="list-style-type: none"> <li>▶ No authorisation for OM4 or</li> <li>▶ Operating mode lock active</li> </ul>
	 *			<ul style="list-style-type: none"> <li>▶ Only when operating mode is preselected</li> <li>▶ OM2 is preselected, but OM1 is still active</li> <li>▶ SOM1 has a "1" signal</li> </ul>
				<ul style="list-style-type: none"> <li>▶ Only when operating mode is preselected</li> <li>▶ OM5 is preselected, but OM1 is still active</li> <li>▶ SOM1 has a "1" signal</li> </ul>
  **	  **	  **	  **	<ul style="list-style-type: none"> <li>▶ Only when operating mode is preselected</li> <li>▶ OM1 is preselected, but OM5 is still active</li> <li>▶ SOM1 has a "1" signal</li> </ul>

\* OM serves only as an example. One of the operating modes must always light or flash.



\*\* Pushbutton backlighting for the newly selected operating mode and all other pushbutton backlights flash alternately







### 7.6.3 Status information via authorisation display

If a transponder key is inserted in the slot of the operating mode selector switch, its authorisations are displayed via the authorisation display LEDs (see [Control elements \[📖 9\]](#)).

#### Evaluation of LED signals

##### Legend

-  LED on
-  LED off

LED	Status	Meaning
All LEDs	●	▶ No transponder key connected or ▶ Authorisation not recognised, or not recognised fully
		Authorisation available for OM1 ... OM5
LED "1"	●	No authorisation for OM1
		Authorisation available for OM1
LED "2"	●	No authorisation for OM2
		Authorisation available for OM2
LED "3"	●	No authorisation for OM3
		Authorisation available for OM3
LED "4"	●	No authorisation for OM4
		Authorisation available for OM4
LED "5"	●	No authorisation for OM5
		Authorisation available for OM5

## 8 Technical details

<b>General</b>	
Certifications	<b>CE, FCC, IC, TÜV, UKCA, cULus Listed</b>
Sensor's mode of operation	<b>Transponder</b>
Pilz coding type	<b>0x1111</b>
<b>Transponder</b>	
Energy supply to transponder	<b>passive (battery free)</b>
Frequency band	<b>125 kHz</b>
<b>Electrical data</b>	
Supply voltage	
Voltage	<b>24 V</b>
Kind	<b>DC</b>
Voltage tolerance	<b>-15 %/+10 %</b>
Output of external power supply (DC) at no load	<b>1 W</b>
Residual ripple DC	<b>20 %</b>
Duty cycle	<b>100 %</b>
Status indicator	<b>LED</b>
<b>Inputs</b>	
Number	<b>3</b>
Signal level at "0"	<b>-3 - +5 V DC</b>
Signal level at "1"	<b>15 - 30 V DC</b>
Voltage at inputs	<b>24 V DC</b>
Input current range	<b>2 mA</b>
Galvanic isolation	<b>No</b>
<b>Semiconductor outputs</b>	
Overall performance ext. loading, semiconductor	<b>9 W</b>
Number of positive-switching single-pole semiconductor outputs	<b>13</b>
Switching capability	
Voltage	<b>24 V</b>
Current	<b>50 mA</b>
Signal level at "1"	<b>UB - 0.5 VDC</b>
Residual current at "0"	<b>0,5 mA</b>
Galvanic isolation	<b>No</b>
Short circuit-proof	<b>yes</b>
<b>Times</b>	
Switch-on delay	
after UB is applied	<b>1 s</b>
Supply interruption before de-energisation	<b>20 ms</b>
Switchover time	<b>50 ms</b>
Operating time button 1 ... 4	<b>50 ms ... 5 s</b>
Operating time, service button	<b>5 s ... 10 s</b>

<b>Environmental data</b>	
Climatic suitability	<b>DIN IEC 60068-2-3</b>
Ambient temperature	
Temperature range	<b>-20 - 60 °C</b>
Storage temperature	
Temperature range	<b>-25 - 70 °C</b>
Climatic suitability	
In accordance with the standard	<b>EN 60068-2-78</b>
Humidity	<b>95 % r. h. at 40 °C</b>
EMC	<b>EN 60947-5-1</b>
Vibration	
In accordance with the standard	<b>EN 60068-2-6</b>
Frequency	<b>10 - 55 Hz</b>
Amplitude	<b>0,35 mm</b>
Airgap creepage	
In accordance with the standard	<b>EN 60664-1</b>
Overvoltage category	<b>II</b>
Pollution degree	<b>2</b>
Rated insulation voltage	<b>60 V</b>
Rated impulse withstand voltage	<b>0,8 kV</b>
Protection type	
Housing	<b>IP20</b>
Terminals	<b>IP20</b>
Mounting area (e.g. control cabinet)	<b>IP65</b>
<b>Operating distances</b>	
Typical operating distance $S_o$	<b>5 mm</b>
<b>Mechanical data</b>	
Mounting position	<b>Any</b>
Max. cable length	<b>1000 m</b>
Material	
Bottom	<b>ST + 10<math>\mu</math> Zn</b>
Front	<b>ABS</b>
Connection type	<b>Spring-loaded terminal, plug-in, screw terminal, plug-in</b>
Conductor cross section with screw terminals	
1 core flexible	<b>0,25 - 1,5 mm<sup>2</sup>, 28 - 16 AWG</b>
Max. torque setting for fixing screws	<b>0,3 Nm</b>
Torque setting with screw terminals	<b>0,25 Nm</b>
Conductor cross section with spring-loaded terminals:	
Flexible with/without crimp connector	<b>0,2 - 2,5 mm<sup>2</sup>, 24 - 12 AWG</b>
Spring-loaded terminals: Terminal points per connection	<b>1</b>
Stripping length with spring-loaded terminals	<b>9 mm</b>

**Mechanical data**

Dimensions

Height	55 mm
Width	98 mm
Depth	43 mm

Weight	140 g
--------	-------

Where standards are undated, the 2019-03 latest editions shall apply.

**8.1 Safety characteristic data**



**NOTICE**

You must comply with the safety characteristic data in order to achieve the required safety level for your plant/machine.

Operating mode	EN ISO 13849-1: 2015	EN ISO 13849-1: 2015	EN IEC 62061 SIL CL/ maximum SIL	EN IEC 62061 PFH <sub>D</sub> [1/h]	EN/IEC 61511 SIL	EN/IEC 61511 PFD	EN ISO 13849-1: 2015 T <sub>M</sub> [year]
–	PL d	Cat. 3	SIL CL 2	1,10E-08	SIL 2	5,28E-04	20

Explanatory notes for the safety-related characteristic data:

- ▶ Safety characteristic data in accordance with EN IEC 62061 and EN/IEC 61511 was calculated based on EN/IEC 61508.
- ▶ T<sub>M</sub> is the maximum mission time in accordance with EN ISO 13849-1. The value also applies as the retest interval in accordance with EN/IEC 61508-6 and EN/IEC 61511 and as the proof test interval and mission time in accordance with EN IEC 62061.

All the units used within a safety function must be considered when calculating the safety characteristic data.



**INFORMATION**

A safety function's SIL/PL values are **not** identical to the SIL/PL values of the units that are used and may be different. We recommend that you use the PAScal software tool to calculate the safety function's SIL/PL values.



## 9 Supplementary data

### 9.1 Radio approval

#### FCC/IC approval

USA/Canada
 <b>FCC ID: VT8-PITM3</b> <b>IC: 7482A-PITM3</b>
<p><u>FCC/IC-Requirements:</u>                      This product complies with Part 15 of the FCC Rules and with Industry Canada licence-exempt RSS standards. Operation is subject to the following two conditions:                      1) this product may not cause harmful interference, and                      2) this product must accept any interference received, including interference that may cause undesired operation.</p> <p>Changes or modifications made to this product not expressly approved by Pilz may void the FCC authorization to operate this equipment.</p> <p>NOTE: This equipment has been tested and found to comply with the limits for a Class A digital device, pursuant to Part 15 of the FCC Rules. These limits are designed to provide reasonable protection against harmful interference when the equipment is operated in a commercial environment. This equipment generates, uses, and can radiate radio frequency energy and, if not installed and used in accordance with the instruction manual, may cause harmful interference to radio communications. Operation of this equipment in a residential area is likely to cause harmful interference in which case the user will be required to correct the interference at his own expense.</p> <p>Le présent produit est conforme aux CNR d'Industrie Canada applicables aux appareils radio exempts de licence. L'exploitation est autorisée aux deux conditions suivantes:                      (1) le produit ne doit pas produire de brouillage, et                      (2) l'utilisateur de le produit doit accepter tout brouillage radioélectrique subi, même si le brouillage est susceptible d'en compromettre le fonctionnement.</p>

### 9.2 Chemical resistance

#### 9.2.1 Front membrane

A "+" means that chemical resistance is provided. Despite the mechanical strength after chemical penetration, some substances may still discolour the surface. These are listed in the table.

Inspection equipment	Abrasion resist- ance	Moisture expan- sion	Discolouration
<b>Acids, alkalis, salts</b>			
Acetic acid (6%)	+		
Citric acid (10%)	+	+	Shinier
Hydrochloric acid (10%)	+	+	None
Nitric acid (10%)	+		
Sulphuric acid (3%)	+	+	Min. milky
Lactic acid	+		
Sodium bicarbonate	+	-	Slightly milky
Cola	+		
Table salt	+	-	Shinier
Caustic soda	-	+	Milky

Inspection equipment	Abrasion resistance	Moisture expansion	Discolouration
Ammonia water	+	+	Opaque
<b>Alcohol, foodstuffs</b>			
Red wine	+	-	Slight
White wine	+	-	None
Stamp ink	+	+	Slight
Ethanol	+	+	None
Methanol	+	+	Min. milky
Blackcurrant juice	+	-	Slight
Coffee	+	+	Medium
Tea	+	+	+
<b>Fats</b>			
Olive oil	+	+	+
<b>Solvents, hydrocarbons</b>			
Ethylene glycol	+	-	Slightly milky
Methyl ethyl ketone	+	+	Shinier
Toluene	+	+	None
Xylene	+	+	None
Chloroform	+	+	Shinier
Dichloromethane	+	+	Shinier
Dichloroethane	+	+	Shinier
N,N-dimethylformamide	+		
<b>Spices</b>			
Mustard	+	+	Medium
Ketchup	+	+	Slight
<b>Iodine/disinfectant</b>			
Betaisadona	+	-	Slight
Hydrogen peroxide	+	+	None
Dibromol tincture	+		
Octenisept	+		

**Legend**

+	OK, resistant
-	Non-resistant
Cell empty	Test not performed

## 9.2.2 Plastic frame

Inspection equipment	23 °C	50 °C
Acetic acid, 25% in water	+	+
Hydrochloric acid, 25% in water	+	0
Sulphuric acid, 50% in water	+	+
Nitric acid, 30% in water	+	0
Phosphoric acid, 1% in water	+	+
Citric acid, 10% in water	+	+
Sodium carbonate (soda), 10% in water	+	+
Sodium chloride (table salt), saturated/aqueous solution	+	+
Sodium nitrate, 10% in water	+	+
Ammonium nitrate, 10% in water	+	+
Iron chloride, saturated/aqueous solution	+	+
Potassium hydroxide (potash), 1% in water	+	+
Sodium chloride (solution)	+	+
Ammonia, 25% in water	+	+
Acetone	-	-
Petrol (normally lead-free)	0	-
Benzene	-	-
Butyl acetate	-	-
Chloroform	-	-
Chlorinated lime	+	+
Diethylene glycol	+	+
Dimethylformamide	-	-
Diesel oil	+	+
1.4 dioxane	-	-
Ethanol (pure)	+	0
Ethylene glycol	+	+
Ethylene chloride	-	-
Ethyl chloride	-	-
Acetic acid (25%)	+	+
Glycerin	+	+

Inspection equipment	23 °C	50 °C
Iso-octane (2.2.4-trimethylpentane, pure)	+	+
Isopropanol, pure	0	-
Hexane	0	
Methanol	0	-
Methyl butyl alcohol	+	0
Methylene chloride	-	-
Methyl ethyl ketone	-	-
Ozone, <0.5ppm	+	+
Paraffin, paraffin oil, (vaseline), pure/ aromatic-free	+	+
Perchloroethylene	0	0
i-propanol	+	-
Propane	+	
n-propanol	+	0
Stearic acid	+	+
Silicone oil	+	+
Carbon tetrachloride	-	-
Tetrachloroethane	-	-
White spirit	+	0
Tricresyl phosphate	-	-
Triethylene glycol	+	+
Xylene	-	-

**Legend**

- + Resistant
- 0 Conditionally resistant, moisture expansion, initiation or development of tension cracks possible
- Non-resistant, severe moisture expansion, disintegration, initiation or formation of tension cracks

## 10 Order reference

### 10.1 Product

Product type	Features	Order No.
PIT m3.2p	Operating mode selector switch	402230
PIT m3.2p machine tools pic-togram	Operating mode selector switch with front membrane	402231

### 10.2 Accessories

#### Terminals

Product type	Features	Order No.
Spring-loaded terminals	1 set	402302
Angled screw terminals	1 set	402303
Screw terminals	1 set	402305

#### Transponder key

Product type	Features	Order No.
PIT m3 key2 mode 1	Transponder key, authorisation for OM1, material: Plastic	402281
PIT m3 key2 mode 2	Transponder key, authorisation for OM1/2, material: Plastic	402282
PIT m3 key2 mode 3	Transponder key, authorisation for OM1/2/3, material: Plastic	402283
PIT m3 key2 mode 4	Transponder key, authorisation for OM1/2/3/4, material: Plastic	402284
PIT m3 key2 mode service	Transponder key, authorisation for OM1/2/3/4/service mode, material: Plastic	402285
PIT m3 key2hq mode 1	Transponder key, authorisation for OM1, material: Plastic with zinc die cast metal frame, chrome plated	402291
PIT m3 key2hq mode 2	Transponder key, authorisation for OM1/2, material: Plastic with zinc die cast metal frame, chrome plated	402292
PIT m3 key2hq mode 3	Transponder key, authorisation for OM1/2/3, material: Plastic with zinc die cast metal frame, chrome plated	402293
PIT m3 key2hq mode 4	Transponder key, authorisation for OM1/2/3/4, material: Plastic with zinc die cast metal frame, chrome plated	402294

Product type	Features	Order No.
PIT m3 key2hq mode service	Transponder key, authorisation for OM1/2/3/4/service mode, material: Plastic with zinc die cast metal frame, chrome plated	402295

## 11 **EC declaration of conformity**

This product/these products meet the requirements of the directive 2006/42/EC for machinery of the European Parliament and of the Council. The complete EC Declaration of Conformity is available on the Internet at [www.pilz.com/downloads](http://www.pilz.com/downloads).

Authorised representative: Norbert Fröhlich, Pilz GmbH & Co. KG, Felix-Wankel-Str. 2, 73760 Ostfildern, Germany

## 12 UKCA-Declaration of Conformity

This product(s) complies with following UK legislation: Supply of Machinery (Safety) Regulation 2008.

The complete UKCA Declaration of Conformity is available on the Internet at [www.pilz.com/downloads](http://www.pilz.com/downloads).

Representative: Pilz Automation Technology, Pilz House, Little Colliers Field, Corby, Northamptonshire, NN18 8TJ United Kingdom, eMail: [mail@pilz.co.uk](mailto:mail@pilz.co.uk)



# ► Support

Technical support is available from Pilz round the clock.

## Americas

### Brazil

+55 11 97569-2804

### Canada

+1 888 315 7459

### Mexico

+52 55 5572 1300

### USA (toll-free)

+1 877-PILZUSA (745-9872)

## Asia

### China

+86 21 60880878-216

### Japan

+81 45 471-2281

### South Korea

+82 31 778 3300

## Australia and Oceania

### Australia

+61 3 95600621

### New Zealand

+64 9 6345350

## Europe

### Austria

+43 1 7986263-0

### Belgium, Luxembourg

+32 9 3217570

### France

+33 3 88104003

### Germany

+49 711 3409-444

### Ireland

+353 21 4804983

### Italy, Malta

+39 0362 1826711

## Scandinavia

+45 74436332

## Spain

+34 938497433

## Switzerland

+41 62 88979-32

## The Netherlands

+31 347 320477

## Turkey

+90 216 5775552

## United Kingdom

+44 1536 462203

## You can reach our international hotline on:

+49 711 3409-222

support@pilz.com

Pilz develops environmentally-friendly products using ecological materials and energy-saving technologies. Offices and production facilities are ecologically designed, environmentally-aware and energy-saving. So Pilz offers sustainability, plus the security of using energy-efficient products and environmentally-friendly solutions.



We are represented internationally. Please refer to our homepage [www.pilz.com](http://www.pilz.com) for further details or contact our headquarters.

Headquarters: Pilz GmbH & Co. KG, Felix-Wankel-Straße 2, 73760 Ostfildern, Germany  
Telephone: +49 711 3409-0, Telefax: +49 711 3409-133, E-Mail: [info@pilz.com](mailto:info@pilz.com), Internet: [www.pilz.com](http://www.pilz.com)

**PILZ**  
THE SPIRIT OF SAFETY

1003176-EN-10, 2023-03 Printed in Germany  
© Pilz GmbH & Co. KG, 2019  
CECE®, CHRE®, CMSE®, InduraNET p®, Leansafe®, Master of Safety®, Master of Security®, PAS4000®, PAScaff®, PASconfig®, Pilz®, PIT®, PLID®, PMCPirimo®, PMCPiritego®, PMCTendo®, PMD®, PMJ®, PNOZ®, PRBM®, PRCM®, PRIMO®, PRM®, PSENET p®, PSEN®, PSS®, PVS®, SafetyBUS p®, SafetyEYE®, SafetyNET p®, THE SPIRIT OF SAFETY® are registered and protected trademarks of Pilz GmbH & Co. KG in some countries. We would point out that product features may vary from the details stated in this document, depending on the status at the time of publication and the scope of the equipment. We accept no responsibility for the validity, accuracy and entirety of the text and graphics presented in this information. Please contact our Technical Support if you have any questions.