



▶ PNOZ 2

PILZ

THE SPIRIT OF SAFETY

Operating Manual-22151-EN-08

- Safety relays



This document is the original document.

Where unavoidable, for reasons of readability, the masculine form has been selected when formulating this document. We do assure you that all persons are regarded without discrimination and on an equal basis.

All rights to this documentation are reserved by Pilz GmbH & Co. KG. Copies may be made for the user's internal purposes. Suggestions and comments for improving this documentation will be gratefully received.

Pilz®, PIT®, PMI®, PNOZ®, Primo®, PSEN®, PSS®, PVIS®, SafetyBUS p®, SafetyEYE®, SafetyNET p®, the spirit of safety® are registered and protected trademarks of Pilz GmbH & Co. KG in some countries.



SD means Secure Digital

Introduction	4
Validity of documentation	4
Using the documentation	4
Definition of symbols	4
Safety	5
Intended use	5
Safety regulations	5
Safety assessment	5
Use of qualified personnel	6
Warranty and liability	6
Disposal	6
For your safety	6
Unit features	7
Safety features	7
Block diagram/terminal configuration	7
Function Description	8
Operating modes	8
Timing diagram	9
Installation	9
Wiring	10
Preparing for operation	11
Operation	12
Status indicators	12
Faults – Interference	13
Dimensions in mm	13
Technical details	14
Safety characteristic data	18
Supplementary data	19
Service life graph	19
Order reference	20
EC declaration of conformity	20
UKCA-Declaration of Conformity	20

Introduction

Validity of documentation

This documentation is valid for the product PNOZ 2. It is valid until new documentation is published.

This operating manual explains the function and operation, describes the installation and provides guidelines on how to connect the product.

Using the documentation

This document is intended for instruction. Only install and commission the product if you have read and understood this document. The document should be retained for future reference.

Definition of symbols

Information that is particularly important is identified as follows:



DANGER!

This warning must be heeded! It warns of a hazardous situation that poses an immediate threat of serious injury and death and indicates preventive measures that can be taken.



WARNING!

This warning must be heeded! It warns of a hazardous situation that could lead to serious injury and death and indicates preventive measures that can be taken.



CAUTION!

This refers to a hazard that can lead to a less serious or minor injury plus material damage, and also provides information on preventive measures that can be taken.



NOTICE

This describes a situation in which the product or devices could be damaged and also provides information on preventive measures that can be taken. It also highlights areas within the text that are of particular importance.

**INFORMATION**

This gives advice on applications and provides information on special features.

Safety**Intended use**

The safety relay PNOZ 2 provides a safety-related interruption of a safety circuit.

The safety relay meets the requirements of EN 60947-5-1 and EN 60204-1 and may be used in applications with:

- ▶ E-STOP pushbuttons
- ▶ Safety gates

Improper use

The following is deemed improper use in particular:

- ▶ Any component, technical or electrical modification to the product,
- ▶ Use of the product outside the areas described in this operating manual,
- ▶ Use of the product outside the technical details (see chapter entitled [Technical Details](#) [ 14]).

**NOTICE****EMC-compliant electrical installation**

The product is designed for use in an industrial environment. The product may cause interference if installed in other environments. If installed in other environments, measures should be taken to comply with the applicable standards and directives for the respective installation site with regard to interference.

Safety regulations**Safety assessment**

Before using a device, a safety assessment in accordance with the Machinery Directive is required.

The product as an individual component fulfils the functional safety requirements in accordance with EN ISO 13849 and EN IEC 62061. However, this does not guarantee the functional safety of the overall plant/machine. To achieve the relevant safety level of the overall plant/machine's required safety functions, each safety function needs to be considered separately.

Use of qualified personnel

The products may only be assembled, installed, programmed, commissioned, operated, maintained and decommissioned by persons who are competent to do so.

A competent person is a qualified and knowledgeable person who, because of their training, experience and current professional activity, has the specialist knowledge required. To be able to inspect, assess and operate devices, systems and machines, the person has to be informed of the state of the art and the applicable national, European and international laws, directives and standards.

It is the company's responsibility only to employ personnel who

- ▶ Are familiar with the basic regulations concerning health and safety / accident prevention,
- ▶ Have read and understood the information provided in the section entitled Safety
- ▶ Have a good knowledge of the generic and specialist standards applicable to the specific application.

Warranty and liability

All claims to warranty and liability will be rendered invalid if

- ▶ The product was used contrary to the purpose for which it is intended,
- ▶ Damage can be attributed to not having followed the guidelines in the manual,
- ▶ Operating personnel are not suitably qualified,
- ▶ Any type of modification has been made (e.g. exchanging components on the PCB boards, soldering work etc.).

Disposal

- ▶ In safety-related applications, please comply with the mission time T_M in the safety-related characteristic data.
- ▶ When decommissioning, please comply with local regulations regarding the disposal of electronic devices (e.g. Electrical and Electronic Equipment Act).

For your safety

The unit meets all the necessary conditions for safe operation. However, please note the following:

- ▶ Note for overvoltage category III: If voltages higher than low voltage (>50 VAC or >120 VDC) are present on the unit, connected control elements and sensors must have a rated insulation voltage of at least 250 V.

Unit features

- ▶ Positive-guided relay outputs:
 - 3 safety contacts (N/O), instantaneous
 - 1 auxiliary contact (N/C), instantaneous
- ▶ Connection options for:
 - E-STOP pushbutton
 - Safety gate limit switch
 - Start button
- ▶ LED display for:
 - Supply voltage
 - Switch status of the safety contacts
- ▶ See order reference for unit types

Safety features

The safety relay meets the following safety requirements:

- ▶ The circuit is internally redundant with built-in self-monitoring.
- ▶ The safety device remains effective in the case of a component failure.
- ▶ The correct opening and closing of the safety device relays is tested automatically in each on-off cycle.

Block diagram/terminal configuration

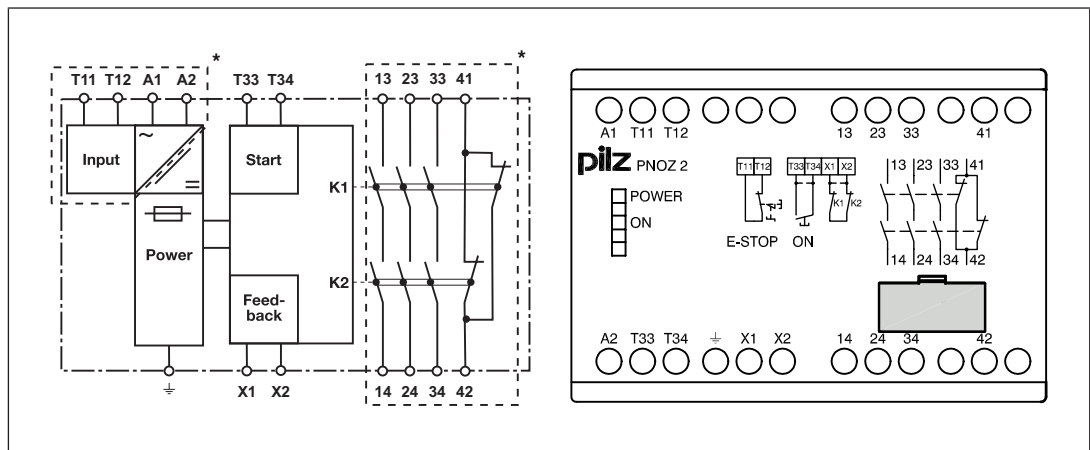

*Insulation between the non-marked area and the relay contacts: Basic insulation (over-voltage category III), Protective separation (overvoltage category II)

Function Description

The safety relay PNOZ 2 provides a safety-oriented interruption of a safety circuit. When supply voltage is supplied the "POWER" LED is lit. The unit is ready for operation when the feedback loop X1-X2 and the start circuit T33-T34 are closed.

- ▶ Input circuit is closed (e.g. E-STOP pushbutton not operated):
 - The "ON" LED is lit.
 - Safety contacts 13-14, 23-24 and 33-34 are closed, auxiliary contact 41-42 is open. The unit is active.
- ▶ Input circuit is opened (e.g. E-STOP pushbutton operated):
 - The "ON" LED goes out.
 - Safety contacts 13-14, 23-24 and 33-34 are opened redundantly, auxiliary contact 41-42 is closed.



NOTICE

If the safety requirement (e.g. E-STOP pushbutton operated) is triggered < 6 s after starting, the delay-on de-energisation of the instantaneous safety contacts may be increased (see [Technical details](#) [14]).

Operating modes

- ▶ Single-channel operation: No redundancy in the input circuit, earth faults in the start and input circuit are detected.
- ▶ Automatic start: Unit is active once the input circuit has been closed.
- ▶ Manual start: Unit is active once the input circuit and the start circuit are closed.
- ▶ Increase in the number of available contacts by connecting contact expansion modules or external contactors/relays.

Timing diagram

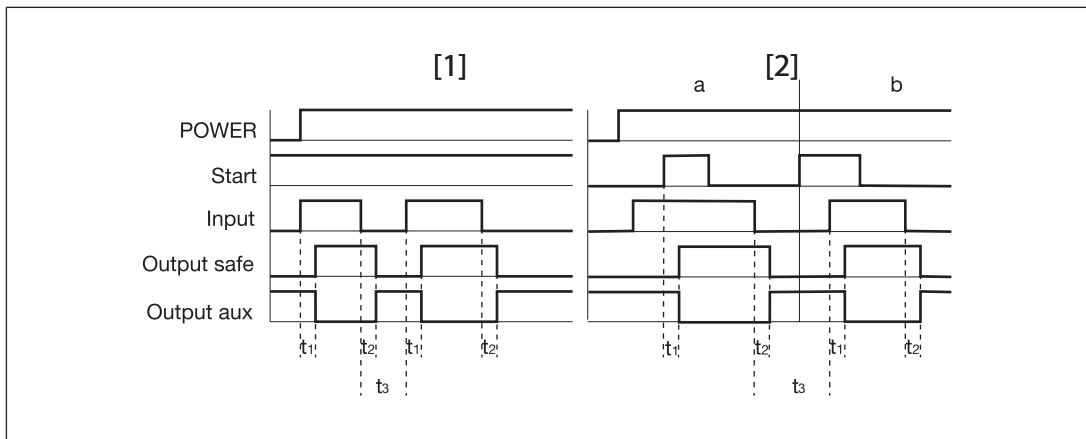

Legend

- ▶ Power: Supply voltage
- ▶ Start: Start circuit
- ▶ Input: Input circuit
- ▶ Output safe: Safety contacts
- ▶ Output aux: Auxiliary contact
- ▶ [1]: Automatic start
- ▶ [2]: Manual start
- ▶ a: Input circuit closes before start circuit
- ▶ b: Start circuit closes before input circuit
- ▶ t_1 : Switch-on delay
- ▶ t_2 : Delay-on de-energisation
- ▶ t_3 : Recovery time

Installation

- ▶ The unit should be installed in a control cabinet with a protection type of at least IP54.
- ▶ Use the notch on the rear of the unit to attach it to a DIN rail (35 mm).
- ▶ When installed vertically: Secure the unit by using a fixing element (e.g. retaining bracket or end angle).

Wiring

Please note:

- ▶ Information given in the "[Technical details \[14\]](#)" must be followed.
- ▶ Outputs 13-14, 23-24, 33-34 are safety contacts; output 41-42 is an auxiliary contact (e.g. for display).
- ▶ Auxiliary contact 41-42 should **not** be used for safety circuits!
- ▶ Do not connect undesignated terminals.
- ▶ To prevent contact welding, a fuse should be connected before the output contacts (see [Technical details \[14\]](#)).
- ▶ Calculating the max. cable length I_{\max} in the input circuit with unit types 24 VAC and 42 VAC:

$$I_{\max} = \frac{R_{I_{\max}}}{R_l / \text{km}}$$

$R_{I_{\max}}$ = max. overall cable resistance (see [Technical details \[14\]](#))

R_l / km = cable resistance/km

- ▶ Calculating the max. cable length I_{\max} in the input circuit with unit types 110 VAC and 230 VAC:

$$I_{\max} = \frac{C_{I_{\max}}}{C_l / \text{km}}$$

$C_{I_{\max}}$ = max. overall cable capacitance (see [Technical details \[14\]](#))

C_l / km = cable capacitance/km



WARNING!

If the max. overall cable capacitance is exceeded, the unit will no longer switch off safely and serious injuries and death may result.

Always comply with the max. overall cable capacitance.

- ▶ Use copper wiring with a temperature stability of 60/75 °C.
- ▶ To prevent EMC interferences (particularly common-mode interferences) the measures described in EN 60204-1 must be executed. This includes the separate routing of cables of the control circuits (input, start and feedback loop) from other cables for energy transmission or the shielding of cables, for example.
- ▶ Do not switch low currents using contacts that have been used previously with high currents.
- ▶ Adequate protection must be provided on all output contacts with capacitive and inductive loads.
- ▶ The emergency stop pushbutton or safety gate limit switch is connected directly to the supply voltage.

Preparing for operation

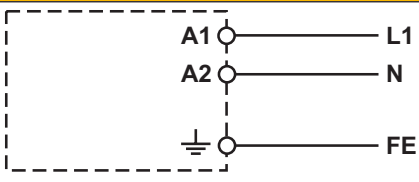
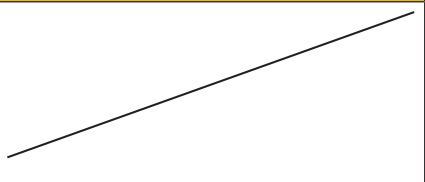
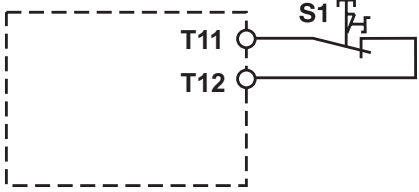
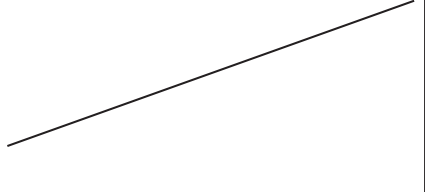
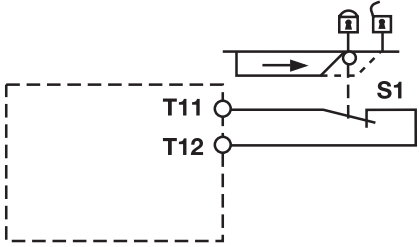
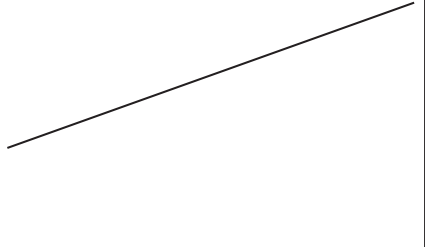
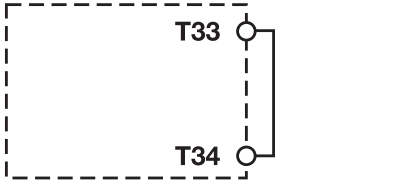
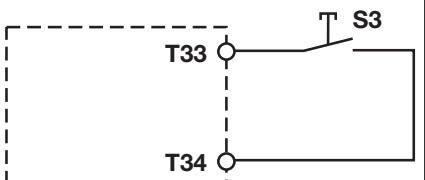
Supply voltage	AC	DC
		
Input circuit	Single-channel	Dual-channel
E-STOP		
Safety gate		
Start circuit	Automatic start	Manual start
E-STOP wiring/safety gate (single-channel)		 <p>Minimum duty cycle: 200 ms</p>





NOTICE

In the event of an automatic start or manual start with bridged start contact (fault):

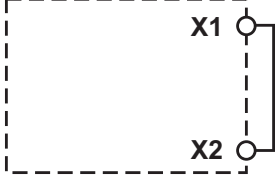
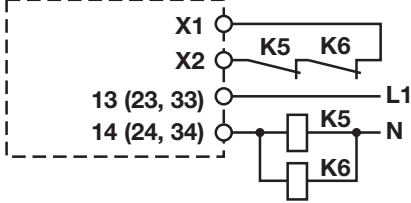
The unit starts up automatically when the safeguard is reset, e.g. when the E-STOP pushbutton is released. Use external circuit measures to prevent an unexpected restart.

Feedback loop	without feedback loop monitoring	with feedback loop monitoring
Link or contacts from external con- tactors		

Legend

- ▶ S1: E-STOP/safety gate switch
- ▶ S3: Start button
- ▶ : Gate open
- ▶ : Gate closed

Operation

When the relay outputs are switched on, the mechanical contact on the relay cannot be tested automatically. Depending on the operational environment, measures to detect the non-opening of switching elements may be required under some circumstances.

When the product is used in accordance with the European Machinery Directive, a check must be carried out to ensure that the safety contacts on the relay outputs open correctly. Open the safety contacts (switch off output) and start the device again, so that the internal diagnostics can check that the safety contacts open correctly

- ▶ for SIL 3/PL e at least 1x per month
- ▶ for SIL 2/PL d at least 1x per year





NOTICE

The safety functions should be checked after initial commissioning and each time the plant/machine is changed. The safety functions may only be checked by qualified personnel.

Status indicators

LEDs indicate the status and errors during operation:

-  LED on
-  **POWER**
Supply voltage is present.
-  **ON**
Unit is active.

Faults – Interference

- ▶ Earth fault: The supply voltage fails and the safety contacts open. Once the cause of the respective fault has been rectified and the supply voltage is switched off for approx. 1 minute, the unit is ready for operation again.
- ▶ Contact malfunctions: If the contacts have welded, reactivation will not be possible after the input circuit has opened.
- ▶ LED "POWER" does not light: Short circuit or no supply voltage.

Dimensions in mm

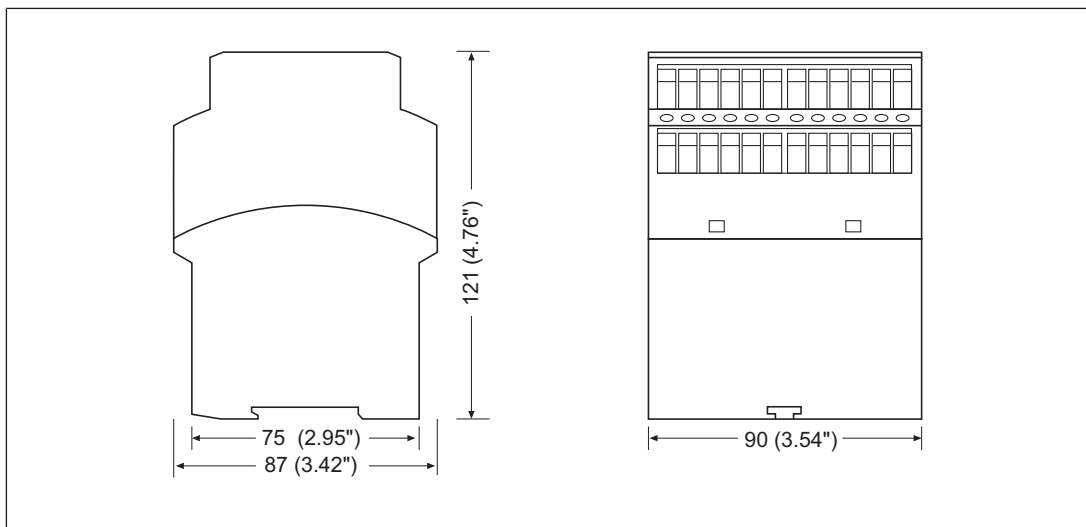

Technical details

General	775830	775850
Certifications	CCC, CE, EAC, TÜV, UKCA, cULus Listed	CCC, CE, EAC, TÜV, UKCA, cULus Listed
Electrical data	775830	775850
Supply voltage		
Voltage	110 V	230 V
Kind	AC	AC
Voltage tolerance	-15 %/+10 %	-15 %/+10 %
Output of external power supply (AC)	5 VA	5 VA
Frequency range AC	50 - 60 Hz	50 - 60 Hz
Duty cycle	100 %	100 %
Inputs	775830	775850
Quantity	1	1
Voltage at		
Start circuit DC	24 V	24 V
Feedback loop DC	24 V	24 V
Current at		
Start circuit DC	50 mA	50 mA
Feedback loop DC	50 mA	50 mA
Max. overall line capacitance C _{lmax}	300 nF	75 nF
Relay outputs	775830	775850
Number of output contacts		
Safety contacts (N/O), instantaneous	3	3
Auxiliary contacts (N/C)	1	1
Max. short circuit current I _K	1 kA	1 kA
Utilisation category		
in accordance with the standard	EN 60947-4-1	EN 60947-4-1
Utilisation category of safety contacts		
AC1 at	240 V	240 V
Min. current	0,01 A	0,01 A
Max. current	8 A	8 A
Max. power	2000 VA	2000 VA
DC1 at	24 V	24 V
Min. current	0,01 A	0,01 A
Max. current	8 A	8 A
Max. power	200 W	200 W

Relay outputs	775830	775850
Utilisation category of auxiliary contacts		
AC1 at	240 V	240 V
Min. current	0,01 A	0,01 A
Max. current	8 A	8 A
Max. power	2000 VA	2000 VA
DC1 at	24 V	24 V
Min. current	0,01 A	0,01 A
Max. current	8 A	8 A
Max. power	200 W	200 W
Utilisation category		
in accordance with the standard	EN 60947-5-1	EN 60947-5-1
Utilisation category of safety contacts		
AC15 at	230 V	230 V
Max. current	5 A	5 A
DC13 (6 cycles/min) at	24 V	24 V
Max. current	7 A	7 A
Utilisation category of auxiliary contacts		
AC15 at	230 V	230 V
Max. current	5 A	5 A
DC13 (6 cycles/min) at	24 V	24 V
Max. current	7 A	7 A
Utilisation category in accordance with UL		
Voltage with current	240 V AC G. P. 8 A	240 V AC G. P. 8 A
Voltage with current	24 V DC Resistive 5 A	24 V DC Resistive 5 A
Pilot Duty	B300, R300	B300, R300
External contact fuse protection, safety contacts		
in accordance with the standard	EN 60947-5-1	EN 60947-5-1
Max. melting integral	240 A²s	240 A²s
Blow-out fuse, quick	10 A	10 A
Blow-out fuse, slow	6 A	6 A
Blow-out fuse, gG	10 A	10 A
Circuit breaker 24V AC/DC, characteristic B/C	6 A	6 A

Relay outputs	775830	775850
External contact fuse protection, auxiliary contacts		
Max. melting integral	240 A²s	240 A²s
Blow-out fuse, quick	10 A	10 A
Blow-out fuse, slow	6 A	6 A
Blow-out fuse, gG	10 A	10 A
Circuit breaker, 24 V AC/DC, characteristic B/C	6 A	6 A
Conventional thermal current	8 A	8 A
Contact material	AgSnO₂ + 0,2 µm Au	AgSnO₂ + 0,2 µm Au
Times	775830	775850
Switch-on delay		
with automatic start typ.	150 ms	150 ms
with automatic start max.	250 ms	250 ms
with manual start typ.	150 ms	150 ms
with manual start max.	250 ms	250 ms
Delay-on de-energisation		
with E-STOP typ.	50 ms	50 ms
with E-STOP, duty cycle < 6 s, max.	250 ms	250 ms
with E-STOP, duty cycle ≥ 6 s, max.	100 ms	100 ms
with power failure typ.	50 ms	50 ms
with power failure max.	250 ms	250 ms
Recovery time at max. switching frequency 1/s		
after E-STOP	250 ms	250 ms
after power failure	250 ms	250 ms
Environmental data	775830	775850
Climatic suitability	EN 60068-2-78	EN 60068-2-78
Ambient temperature		
Temperature range	-10 - 55 °C	-10 - 55 °C
Storage temperature		
Temperature range	-40 - 85 °C	-40 - 85 °C
Climatic suitability		
Humidity	93 % r. h. at 40 °C	93 % r. h. at 40 °C
Condensation during operation	Not permitted	Not permitted
EMC	EN 60947-5-1, EN 61000-6-2, EN 61326-3-1	EN 60947-5-1, EN 61000-6-2, EN 61326-3-1
Vibration		
in accordance with the standard	EN 60068-2-6	EN 60068-2-6
Frequency	10 - 55 Hz	10 - 55 Hz
Amplitude	0,35 mm	0,35 mm

Environmental data	775830	775850
Airgap creepage		
in accordance with the standard	EN 60947-1	EN 60947-1
Overvoltage category	III / II	III / II
Pollution degree	2	2
Rated insulation voltage	250 V	250 V
Rated impulse withstand voltage	4 kV	4 kV
Protection type		
Housing	IP40	IP40
Terminals	IP20	IP20
Mounting area (e.g. control cabinet)	IP54	IP54
Mechanical data	775830	775850
Mounting position	Any	Any
Mechanical life	10,000,000 cycles	10,000,000 cycles
Material		
Bottom	PPO UL 94 V1	PPO UL 94 V1
Front	ABS UL 94 V0	ABS UL 94 V0
Top	PPO UL 94 V1	PPO UL 94 V1
Connection type	Screw terminal	Screw terminal
Mounting type	Fixed	Fixed
Conductor cross section with screw terminals		
1 core flexible	0,2 - 4 mm², 24 - 10 AWG	0,2 - 4 mm², 24 - 10 AWG
2 core with the same cross section, flexible with crimp connectors, no plastic sleeve	0,2 - 2,5 mm², 24 - 14 AWG	0,2 - 2,5 mm², 24 - 14 AWG
2 core with the same cross section, flexible without crimp connectors or with TWIN crimp connectors	0,2 - 2,5 mm², 24 - 14 AWG	0,2 - 2,5 mm², 24 - 14 AWG
Torque setting with screw terminals	0,5 Nm	0,5 Nm
Stripping length with screw terminals	6 mm	6 mm
Dimensions		
Height	87 mm	87 mm
Width	90 mm	90 mm
Depth	121 mm	121 mm
Weight	500 g	500 g

Where standards are undated, the 2022-09 latest editions shall apply.

Safety characteristic data



NOTICE

You must comply with the safety characteristic data in order to achieve the required safety level for your plant/machine.

Operating mode	EN ISO 13849-1: 2015 PL	EN ISO 13849-1: 2015 Category	EN IEC 62061 SIL CL/ maximum SIL	EN IEC 62061 PFH _D [1/h]	EN/IEC 61511 SIL	EN/IEC 61511 PFD	EN ISO 13849-1: 2015 T _M [year]
–	PL e	Cat. 4	SIL 3	2,31E-09	SIL 3	2,03E-06	20

Explanatory notes for the safety-related characteristic data:

- ▶ Safety characteristic data in accordance with EN IEC 62061 and EN/IEC 61511 was calculated based on EN/IEC 61508.
- ▶ T_M is the maximum mission time in accordance with EN ISO 13849-1. The value also applies as the retest interval in accordance with EN/IEC 61508-6 and EN/IEC 61511 and as the proof test interval and mission time in accordance with EN IEC 62061.

All the units used within a safety function must be considered when calculating the safety characteristic data.



INFORMATION

A safety function's SIL/PL values are **not** identical to the SIL/PL values of the units that are used and may be different. We recommend that you use the PAScal software tool to calculate the safety function's SIL/PL values.

Supplementary data



CAUTION!

It is essential to consider the relay's service life graphs. The relay outputs' safety-related characteristic data is only valid if the values in the service life graphs are met.

The PFH value depends on the switch frequency and the load of the relay output. If the service life graphs are not accessible, the stated PFH value can be used irrespective of the switch frequency and the load, as the PFH value already considers the relay's B10d value as well as the failure rates of the other components.

Service life graph

The service life graphs indicate the number of cycles from which failures due to wear must be expected. The wear is mainly caused by the electrical load; the mechanical load is negligible.

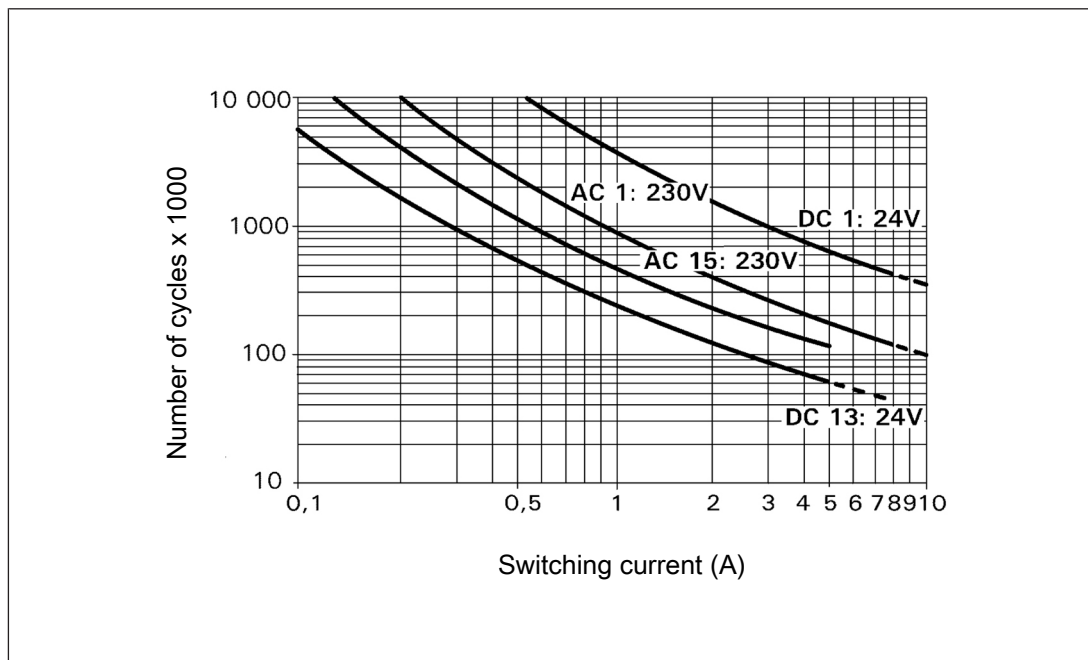

Example

- ▶ Inductive load: 0.2 A
- ▶ Utilisation category: AC15
- ▶ Contact service life: 4 000 000 cycles

Provided the application to be implemented requires fewer than 4 000 000 cycles, the PFH value (see Technical details) can be used in the calculation.

To increase the service life, sufficient spark suppression must be provided on all output contacts. With capacitive loads, any power surges that occur must be noted. With DC contactors, use flywheel diodes for spark suppression.

Order reference

Product type	Features	Connection type	Order no.
PNOZ 2	110 VAC	Screw terminals	775830
PNOZ 2	230 VAC	Screw terminals	775850

EC declaration of conformity

This product/these products meet the requirements of the directive 2006/42/EC for machinery of the European Parliament and of the Council. The complete EC Declaration of Conformity is available on the Internet at www.pilz.com/downloads.

Authorised representative: Norbert Fröhlich, Pilz GmbH & Co. KG, Felix-Wankel-Str. 2, 73760 Ostfildern, Germany

UKCA-Declaration of Conformity

This product(s) complies with following UK legislation: Supply of Machinery (Safety) Regulation 2008.

The complete UKCA Declaration of Conformity is available on the Internet at www.pilz.com/downloads.

Representative: Pilz Automation Technology, Pilz House, Little Colliers Field, Corby, Northamptonshire, NN18 8TJ United Kingdom, eMail: mail@pilz.co.uk

