



## ► PNOZ X10

**PILZ**  
THE SPIRIT OF SAFETY

Operating Manual-19554-EN-11  
- Safety relays



This document is the original document.

Where unavoidable, for reasons of readability, the masculine form has been selected when formulating this document. We do assure you that all persons are regarded without discrimination and on an equal basis.

All rights to this documentation are reserved by Pilz GmbH & Co. KG. Copies may be made for the user's internal purposes. Suggestions and comments for improving this documentation will be gratefully received.

Pilz®, PIT®, PMI®, PNOZ®, Primo®, PSEN®, PSS®, PVIS®, SafetyBUS p®, SafetyEYE®, SafetyNET p®, the spirit of safety® are registered and protected trademarks of Pilz GmbH & Co. KG in some countries.



SD means Secure Digital

<b>Introduction</b> .....	<b>5</b>
Validity of documentation .....	5
Using the documentation .....	5
Definition of symbols .....	5
<b>Safety</b> .....	<b>6</b>
Intended use .....	6
Safety regulations .....	6
Safety assessment .....	6
Use of qualified personnel .....	7
Warranty and liability .....	7
Disposal .....	7
For your safety .....	7
<b>Unit features</b> .....	<b>8</b>
<b>Safety features</b> .....	<b>8</b>
<b>Block diagram/terminal configuration</b> .....	<b>8</b>
Types: AC .....	8
Type: DC .....	9
<b>Function Description</b> .....	<b>9</b>
Operating modes .....	9
Timing diagram .....	10
<b>Installation</b> .....	<b>10</b>
<b>Wiring</b> .....	<b>11</b>
<b>Preparing for operation</b> .....	<b>12</b>
<b>Operation</b> .....	<b>14</b>
Status indicators .....	15
<b>Faults – Interference</b> .....	<b>15</b>
<b>Dimensions in mm</b> .....	<b>15</b>
<b>Technical details Order no. 774700, 774701, 774703</b> .....	<b>16</b>
<b>Technical details Order no. 774706, 774709</b> .....	<b>21</b>
<b>Safety characteristic data</b> .....	<b>26</b>
<b>Supplementary data</b> .....	<b>27</b>
Service life graph .....	27

<b>Order reference .....</b>	<b>28</b>
<b>EC declaration of conformity .....</b>	<b>28</b>
<b>UKCA-Declaration of Conformity .....</b>	<b>28</b>

## Introduction

### Validity of documentation

This documentation is valid for the product PNOZ X10. It is valid until new documentation is published.

This operating manual explains the function and operation, describes the installation and provides guidelines on how to connect the product.

### Using the documentation

This document is intended for instruction. Only install and commission the product if you have read and understood this document. The document should be retained for future reference.

### Definition of symbols

Information that is particularly important is identified as follows:



#### **DANGER!**

This warning must be heeded! It warns of a hazardous situation that poses an immediate threat of serious injury and death and indicates preventive measures that can be taken.



#### **WARNING!**

This warning must be heeded! It warns of a hazardous situation that could lead to serious injury and death and indicates preventive measures that can be taken.



#### **CAUTION!**

This refers to a hazard that can lead to a less serious or minor injury plus material damage, and also provides information on preventive measures that can be taken.



#### **NOTICE**

This describes a situation in which the product or devices could be damaged and also provides information on preventive measures that can be taken. It also highlights areas within the text that are of particular importance.

**INFORMATION**

This gives advice on applications and provides information on special features.

**Safety****Intended use**

The safety relay PNOZ X10 provides a safety-related interruption of a safety circuit.

The safety relay meets the requirements of EN 60947-5-1 and EN 60204-1 and may be used in applications with:

- ▶ E-STOP pushbuttons
- ▶ Safety gates
- ▶ Light grids and safety switches with detection of shorts across contacts

**Improper use**

The following is deemed improper use in particular:

- ▶ Any component, technical or electrical modification to the product,
- ▶ Use of the product outside the areas described in this operating manual,
- ▶ Use of the product outside the technical details (see chapter entitled [Technical Details](#) [ 16]).

**NOTICE****EMC-compliant electrical installation**

The product is designed for use in an industrial environment. The product may cause interference if installed in other environments. If installed in other environments, measures should be taken to comply with the applicable standards and directives for the respective installation site with regard to interference.

**Safety regulations****Safety assessment**

Before using a device, a safety assessment in accordance with the Machinery Directive is required.

The product as an individual component fulfils the functional safety requirements in accordance with EN ISO 13849 and EN IEC 62061. However, this does not guarantee the functional safety of the overall plant/machine. To achieve the relevant safety level of the overall plant/machine's required safety functions, each safety function needs to be considered separately.

**Use of qualified personnel**

The products may only be assembled, installed, programmed, commissioned, operated, maintained and decommissioned by persons who are competent to do so.

A competent person is a qualified and knowledgeable person who, because of their training, experience and current professional activity, has the specialist knowledge required. To be able to inspect, assess and operate devices, systems and machines, the person has to be informed of the state of the art and the applicable national, European and international laws, directives and standards.

It is the company's responsibility only to employ personnel who

- ▶ Are familiar with the basic regulations concerning health and safety / accident prevention,
- ▶ Have read and understood the information provided in the section entitled Safety
- ▶ Have a good knowledge of the generic and specialist standards applicable to the specific application.

**Warranty and liability**

All claims to warranty and liability will be rendered invalid if

- ▶ The product was used contrary to the purpose for which it is intended,
- ▶ Damage can be attributed to not having followed the guidelines in the manual,
- ▶ Operating personnel are not suitably qualified,
- ▶ Any type of modification has been made (e.g. exchanging components on the PCB boards, soldering work etc.).

**Disposal**

- ▶ In safety-related applications, please comply with the mission time  $T_M$  in the safety-related characteristic data.
- ▶ When decommissioning, please comply with local regulations regarding the disposal of electronic devices (e.g. Electrical and Electronic Equipment Act).

**For your safety**

The unit meets all the necessary conditions for safe operation. However, please note the following:

- ▶ Note for overvoltage category III: If voltages higher than low voltage (>50 VAC or >120 VDC) are present on the unit, connected control elements and sensors must have a rated insulation voltage of at least 250 V.

### Unit features

- ▶ Positive-guided relay outputs:
  - 6 safety contacts (N/O), instantaneous
  - 4 auxiliary contacts (N/C), instantaneous
- ▶ Connection options for:
  - E-STOP pushbuttons
  - Safety gate limit switches
  - Start buttons
  - Light grids and safety switches with detection of shorts across contacts
- ▶ LED display for:
  - Supply voltage
  - Switch status of the safety contacts
- ▶ See order reference for unit types

### Safety features

The safety relay meets the following safety requirements:

- ▶ The circuit is redundant with built-in self-monitoring.
- ▶ The safety function remains effective in the case of a component failure.
- ▶ The correct opening and closing of the safety function relays is tested automatically in each on-off cycle.

### Block diagram/terminal configuration

#### Types: AC

- ▶ U<sub>B</sub>: 24 VAC; Order no. 774700
- ▶ U<sub>B</sub>: 42 VAC; Order no. 774701
- ▶ U<sub>B</sub>: 110 - 120 VAC; Order no. 774703
- ▶ U<sub>B</sub>: 230 - 240 VAC; Order no. 774706

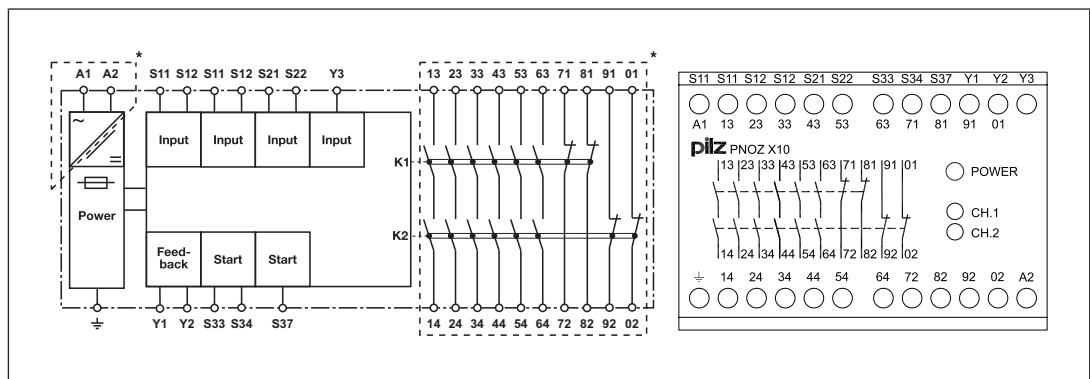

\*Insulation between the non-marked area and the relay contacts: Basic insulation (over-voltage category III), Protective separation (overvoltage category II)



**Type: DC**

▶  $U_B$ : 24 VDC; Order no. 774709

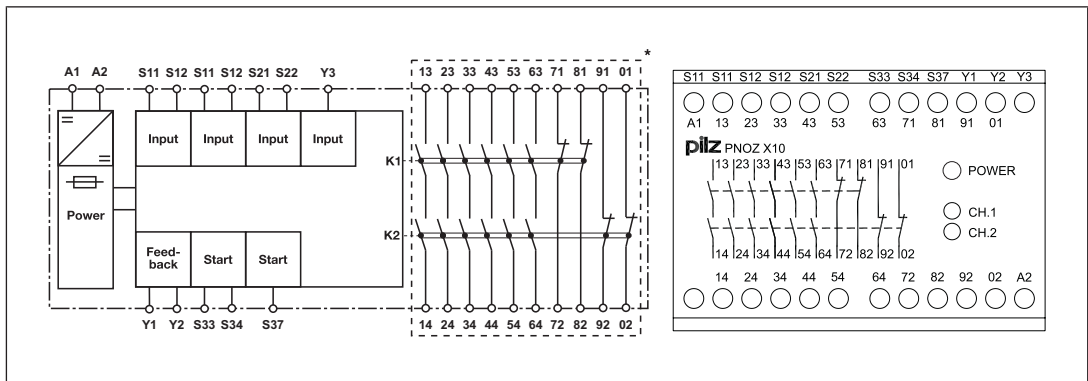

\*Insulation between the non-marked area and the relay contacts: Basic insulation (over-voltage category III), Protective separation (overvoltage category II)

**Function Description**

The safety relay PNOZ X10 provides a safety-oriented interruption of a safety circuit. When supply voltage is supplied the "POWER" LED is lit. The unit is ready for operation when the feedback loop Y1-Y2 and the start circuit S12-S34 are closed.

- ▶ Input circuit is closed (e.g. E-STOP pushbutton is not operated):
  - The LEDs "CH.1" and "CH.2" are lit.
  - Safety contacts 13-14, 23-24, 33-34, 43-44, 53-54 and 63-64 are closed, auxiliary contacts 71-72, 81-82, 91-92 and 01-02 are opened. The unit is active.
- ▶ Input circuit is opened (e.g. E-STOP pushbutton operated):
  - The LEDs "CH.1" and "CH.2" go out.
  - Safety contacts 13-14, 23-24, 33-34, 43-44, 53-54 and 63-64 are opened redundantly, auxiliary contacts 71-72, 81-82, 91-92 and 01-02 are closed.

**Operating modes**

- ▶ Single-channel operation: No redundancy in the input circuit, earth faults in the start and input circuit are detected.
- ▶ Dual-channel operation with detection of shorts across contacts: Redundant input circuit, PNOZ X10 detects
  - earth faults in the start and input circuit,
  - short circuits in the input circuit,
  - shorts across contacts in the input circuit.
- ▶ Dual-channel operation without detection of shorts across contacts: Redundant input circuit, detects PNOZ X10
  - earth faults in the start and input circuit,
  - short circuits in the input circuit.
- ▶ Automatic start: Unit is active once the input circuit has been closed.
- ▶ Manual start: Unit is active once the input circuit and the start circuit are closed.

- ▶ Monitored start: Unit is active once
  - the input circuit is closed and then the start circuit is closed and opened again.
  - the start circuit is closed and then opened again once the input circuit is closed.
- ▶ Increase in the number of available contacts by connecting contact expansion modules or external contactors/relays.

### Timing diagram

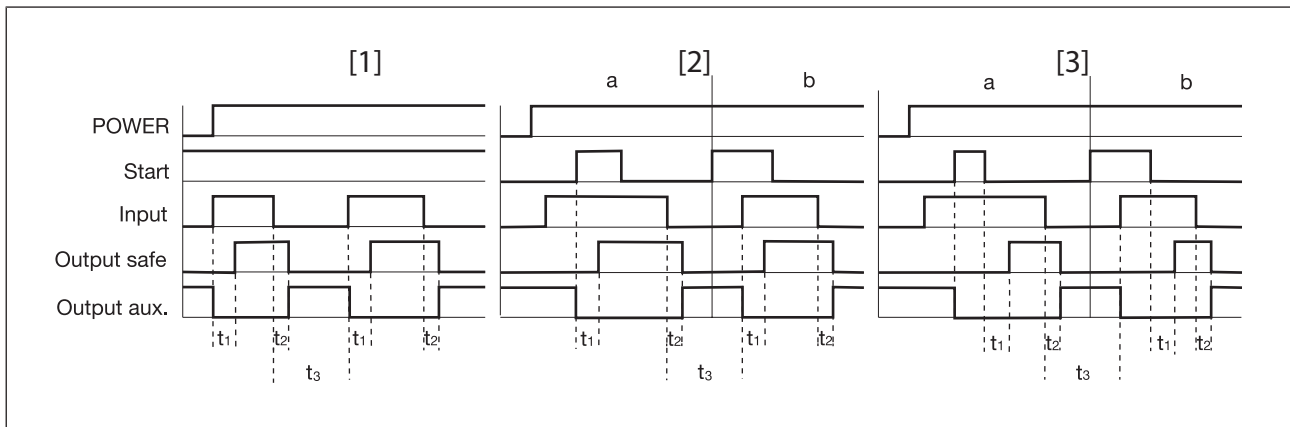

### Legend

- ▶ Power: Supply voltage
- ▶ Start: Start circuit
- ▶ Input: Input circuit
- ▶ Output safe: Safety contacts
- ▶ Output aux: Auxiliary contacts
- ▶ [1]: Automatic start
- ▶ [2]: Manual start
- ▶ [3]: Monitored start
- ▶ a: Input circuit closes before start circuit
- ▶ b: Start circuit closes before input circuit
- ▶  $t_1$ : Switch-on delay
- ▶  $t_2$ : Delay-on de-energisation
- ▶  $t_3$ : Recovery time

### Installation

- ▶ The unit should be installed in a control cabinet with a protection type of at least IP54.
- ▶ Use the notch on the rear of the unit to attach it to a DIN rail (35 mm).
- ▶ When installed vertically: Secure the unit by using a fixing element (e.g. retaining bracket or end angle).

## Wiring

Please note:

- ▶ Information given in the "[Technical details \[16\]](#)" must be followed.
- ▶ Outputs 13-14, 23-24, 33-34, 43-44, 53-54, 63-64 are safety contacts; outputs 71-72, 81-82, 91-92, 01-02 are auxiliary contacts (e.g. for display).
- ▶ Do **not** use auxiliary contacts 71-72, 81-82, 91-92, 01-02 for safety circuits!
- ▶ Do not connect undesignated terminals.
- ▶ To prevent contact welding, a fuse should be connected before the output contacts (see [Technical details \[16\]](#)).
- ▶ Calculation of the max. cable length  $l_{\max}$  in the input circuit:

$$l_{\max} = \frac{R_{l_{\max}}}{R_l / \text{km}}$$

$R_{l_{\max}}$  = max. overall cable resistance (see [Technical details \[16\]](#))

$R_l / \text{km}$  = cable resistance/km

- ▶ Use copper wiring with a temperature stability of 60/75 °C.
- ▶ To prevent EMC interferences (particularly common-mode interferences) the measures described in EN 60204-1 must be executed. This includes the separate routing of cables of the control circuits (input, start and feedback loop) from other cables for energy transmission or the shielding of cables, for example.
- ▶ Do not switch low currents using contacts that have been used previously with high currents.
- ▶ Adequate protection must be provided on all output contacts with capacitive and inductive loads.
- ▶ When connecting magnetically operated, reed proximity switches, ensure that the max. peak inrush current (on the input circuit) does not overload the proximity switch.
- ▶ On 24 VDC devices:  
The power supply must comply with the regulations for extra low voltages with protective electrical separation (SELV, PELV) in accordance with VDE 0100, Part 410.

### Important for detection of shorts across contacts:

As this function for detecting shorts across contacts is not failsafe, it is tested by Pilz during the final control check. If there is a danger of exceeding the cable runs, we recommend the following test after the installation of the device:

1. Unit ready for operation (output contacts closed)
2. Short circuit the test terminals S12, S22 for detecting shorts across the inputs.
3. The unit's fuse must be triggered and the output contacts must open. Cable lengths in the scale of the maximum length can delay the fuse triggering for up to 2 minutes.
4. Reset the fuse: remove the short circuit and switch off the supply voltage for approx. 1 minute.

### Preparing for operation

Supply voltage	AC	DC
Input circuit	Single-channel	Dual-channel
E-STOP <b>without</b> detection of shorts across contacts		
E-STOP <b>with</b> detection of shorts across contacts		
Safety gate <b>without</b> detection of shorts across contacts		
Safety gate <b>with</b> detection of shorts across contacts		
Light guards or safety switch, detection of shorts across contacts via ESPE (only when $U_B = 24\text{ VDC}$ )		



#### NOTICE

With single-channel wiring the safety level of your machine/plant may be lower than the safety level of the unit (see [Safety characteristic data](#) [ 26]).



**NOTICE**

**Operation with a light guard or safety switch**

It must not be possible to switch off the supply voltage for the PNOZ X10 separately from the supply voltage for the light guard or safety switch.

Start circuit	Single-channel, dual-channel without detection of shorts across contacts	Dual-channel with detection of shorts across contacts
Automatic start		
Automatic start with start-up test	<p>Simultaneity S1 and S2: 150 ms</p>	
Manual start		
Monitored start		





**NOTICE**

**In the event of an automatic start or manual start with bridged start contact (fault):**

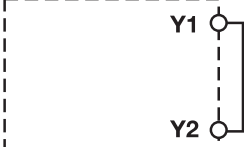
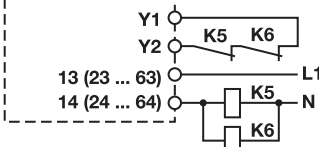
The unit starts up automatically when the safeguard is reset, e.g. when the E-STOP pushbutton is released. Use external circuit measures to prevent an unexpected restart.

Feedback loop	Without feedback loop monitoring	With feedback loop monitoring
Link or contacts from external contactors		

**Legend**

- ▶ S1/S2: E-STOP/safety gate switch
- ▶ S3: Reset button
- ▶ ⬆: Switch operated
- ▶ : Gate open
- ▶ : Gate closed



**INFORMATION**

With automatic start and manual start, Y1 and S37 must not be linked.

**Operation**

When the relay outputs are switched on, the mechanical contact on the relay cannot be tested automatically. Depending on the operational environment, measures to detect the non-opening of switching elements may be required under some circumstances.

When the product is used in accordance with the European Machinery Directive, a check must be carried out to ensure that the safety contacts on the relay outputs open correctly. Open the safety contacts (switch off output) and start the device again, so that the internal diagnostics can check that the safety contacts open correctly

- ▶ for SIL 3/PL e at least 1x per month
- ▶ for SIL 2/PL d at least 1x per year







**NOTICE**

The safety functions should be checked after initial commissioning and each time the plant/machine is changed. The safety functions may only be checked by qualified personnel.

### Status indicators

LEDs indicate the status and errors during operation:

-  LED on
  
-  **POWER**  
 Supply voltage is present.
  
-  **CH.1**  
 Safety contacts of channel 1 are closed.
  
-  **CH.2**  
 Safety contacts of channel 2 are closed.

### Faults – Interference

- ▶ Earth fault: The supply voltage fails and the safety contacts open. Once the cause of the respective fault has been rectified and the supply voltage is switched off for approx. 1 minute, the unit is ready for operation again.
- ▶ Contact malfunctions: If the contacts have welded, reactivation will not be possible after the input circuit has opened.
- ▶ LED "POWER" does not light: Short circuit or no supply voltage.

### Dimensions in mm

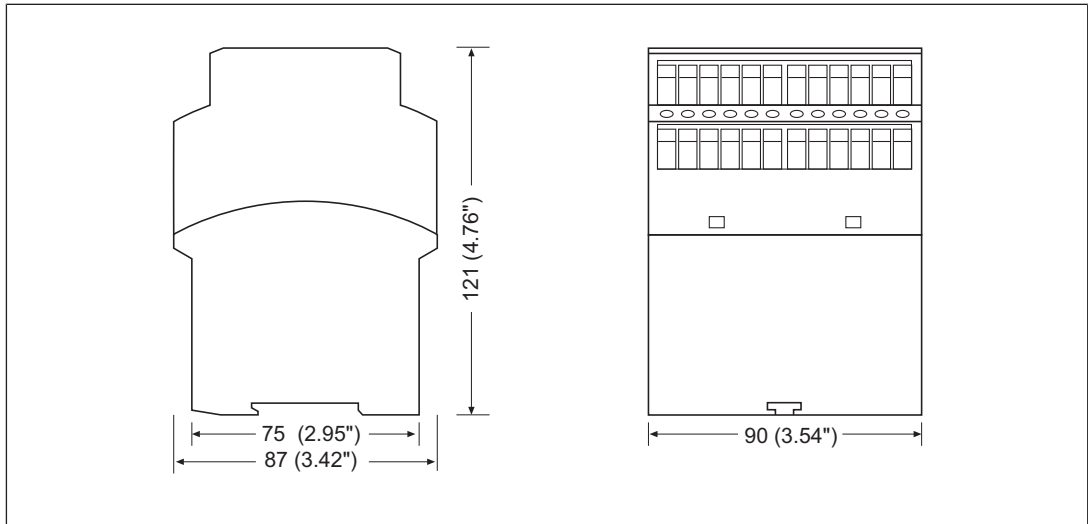

### Technical details Order no. 774700, 774701, 774703

<b>General</b>	<b>774700</b>	<b>774701</b>	<b>774703</b>
Certifications	CCC, CE, EAC, TÜV, UKCA, cULus Listed	CCC, CE, EAC, TÜV, UKCA, cULus Listed	CCC, CE, EAC, TÜV, UKCA, cULus Listed
<b>Electrical data</b>	<b>774700</b>	<b>774701</b>	<b>774703</b>
Supply voltage			
Voltage	24 V	42 V	110 - 120 V
Kind	AC	AC	AC
Voltage tolerance	-15 %/+10 %	-15 %/+10 %	-15 %/+10 %
Output of external power supply (AC)	10 VA	10 VA	10 VA
Frequency range AC	50 - 60 Hz	50 - 60 Hz	50 - 60 Hz
Duty cycle	100 %	100 %	100 %
<b>Inputs</b>	<b>774700</b>	<b>774701</b>	<b>774703</b>
Quantity	2	2	2
Voltage at			
Input circuit DC	24 V	24 V	24 V
Start circuit DC	24 V	24 V	24 V
Feedback loop DC	24 V	24 V	24 V
Current at			
Input circuit DC	50 mA	50 mA	50 mA
Start circuit DC	100 mA	100 mA	100 mA
Feedback loop DC	100 mA	100 mA	100 mA
Min. input resistance at power-on	89 Ohm	89 Ohm	89 Ohm
Max. overall cable resistance R <sub>lmax</sub>			
Single-channel at UB AC	45 Ohm	45 Ohm	45 Ohm
Dual-channel without detection of shorts across contacts at UB AC	90 Ohm	90 Ohm	90 Ohm
Dual-channel with detection of shorts across contacts at UB AC	15 Ohm	15 Ohm	15 Ohm
<b>Relay outputs</b>	<b>774700</b>	<b>774701</b>	<b>774703</b>
Number of output contacts			
Safety contacts (N/O), instantaneous	6	6	6
Auxiliary contacts (N/C)	4	4	4
Max. short circuit current I <sub>K</sub>	1 kA	1 kA	1 kA
Utilisation category in accordance with the standard	EN 60947-4-1	EN 60947-4-1	EN 60947-4-1



<b>Relay outputs</b>	<b>774700</b>	<b>774701</b>	<b>774703</b>
Utilisation category of safety contacts			
AC1 at	<b>400 V</b>	<b>400 V</b>	<b>400 V</b>
Min. current	<b>0,01 A</b>	<b>0,01 A</b>	<b>0,01 A</b>
Max. current	<b>5 A</b>	<b>5 A</b>	<b>5 A</b>
Max. power	<b>2000 VA</b>	<b>2000 VA</b>	<b>2000 VA</b>
AC1 at	<b>240 V</b>	<b>240 V</b>	<b>240 V</b>
Min. current	<b>0,01 A</b>	<b>0,01 A</b>	<b>0,01 A</b>
Max. current	<b>8 A</b>	<b>8 A</b>	<b>8 A</b>
Max. power	<b>2000 VA</b>	<b>2000 VA</b>	<b>2000 VA</b>
DC1 at	<b>24 V</b>	<b>24 V</b>	<b>24 V</b>
Min. current	<b>0,01 A</b>	<b>0,01 A</b>	<b>0,01 A</b>
Max. current	<b>8 A</b>	<b>8 A</b>	<b>8 A</b>
Max. power	<b>200 W</b>	<b>200 W</b>	<b>200 W</b>
Utilisation category of auxiliary contacts			
AC1 at	<b>240 V</b>	<b>240 V</b>	<b>240 V</b>
Min. current	<b>0,01 A</b>	<b>0,01 A</b>	<b>0,01 A</b>
Max. current	<b>8 A</b>	<b>8 A</b>	<b>8 A</b>
Max. power	<b>2000 VA</b>	<b>2000 VA</b>	<b>2000 VA</b>
DC1 at	<b>24 V</b>	<b>24 V</b>	<b>24 V</b>
Min. current	<b>0,01 A</b>	<b>0,01 A</b>	<b>0,01 A</b>
Max. current	<b>8 A</b>	<b>8 A</b>	<b>8 A</b>
Max. power	<b>200 W</b>	<b>200 W</b>	<b>200 W</b>
Utilisation category in accordance with the standard			
	<b>EN 60947-5-1</b>	<b>EN 60947-5-1</b>	<b>EN 60947-5-1</b>
Utilisation category of safety contacts			
AC15 at	<b>230 V</b>	<b>230 V</b>	<b>230 V</b>
Max. current	<b>5 A</b>	<b>5 A</b>	<b>5 A</b>
DC13 (6 cycles/min) at	<b>24 V</b>	<b>24 V</b>	<b>24 V</b>
Max. current	<b>7 A</b>	<b>7 A</b>	<b>7 A</b>
Utilisation category of auxiliary contacts			
AC15 at	<b>230 V</b>	<b>230 V</b>	<b>230 V</b>
Max. current	<b>5 A</b>	<b>5 A</b>	<b>5 A</b>
DC13 (6 cycles/min) at	<b>24 V</b>	<b>24 V</b>	<b>24 V</b>
Max. current	<b>7 A</b>	<b>7 A</b>	<b>7 A</b>
Utilisation category in accordance with UL			
Voltage with current	<b>240 V AC G. P. 8 A</b>	<b>240 V AC G. P. 8 A</b>	<b>240 V AC G. P. 8 A</b>
Voltage with current	<b>24 V DC Resistive 5 A</b>	<b>24 V DC Resistive 5 A</b>	<b>24 V DC Resistive 5 A</b>
Pilot Duty	<b>B300, R300</b>	<b>B300, R300</b>	<b>B300, R300</b>

<b>Relay outputs</b>	<b>774700</b>	<b>774701</b>	<b>774703</b>
External contact fuse protection, safety contacts			
in accordance with the standard	<b>EN 60947-5-1</b>	<b>EN 60947-5-1</b>	<b>EN 60947-5-1</b>
Max. melting integral	<b>240 A<sup>2</sup>s</b>	<b>240 A<sup>2</sup>s</b>	<b>240 A<sup>2</sup>s</b>
Blow-out fuse, quick	<b>10 A</b>	<b>10 A</b>	<b>10 A</b>
Blow-out fuse, slow	<b>6 A</b>	<b>6 A</b>	<b>6 A</b>
Blow-out fuse, gG	<b>10 A</b>	<b>10 A</b>	<b>10 A</b>
Circuit breaker 24V AC/DC, characteristic B/C	<b>6 A</b>	<b>6 A</b>	<b>6 A</b>
External contact fuse protection, auxiliary contacts			
Max. melting integral	<b>240 A<sup>2</sup>s</b>	<b>240 A<sup>2</sup>s</b>	<b>240 A<sup>2</sup>s</b>
Blow-out fuse, quick	<b>10 A</b>	<b>10 A</b>	<b>10 A</b>
Blow-out fuse, slow	<b>6 A</b>	<b>6 A</b>	<b>6 A</b>
Blow-out fuse, gG	<b>10 A</b>	<b>10 A</b>	<b>10 A</b>
Circuit breaker, 24 V AC/DC, characteristic B/C	<b>6 A</b>	<b>6 A</b>	<b>6 A</b>
Contact material	<b>AgSnO<sub>2</sub> + 0,2 µm Au</b>	<b>AgSnO<sub>2</sub> + 0,2 µm Au</b>	<b>AgSnO<sub>2</sub> + 0,2 µm Au</b>
<b>Conventional thermal current while loading several contacts</b>	<b>774700</b>	<b>774701</b>	<b>774703</b>
I <sub>th</sub> per contact at UB AC; AC1: 240 V, DC1: 24 V			
Conv. therm. current with 1 contact	<b>8 A</b>	<b>8 A</b>	<b>8 A</b>
Conv. therm. current with 2 contacts	<b>7 A</b>	<b>7 A</b>	<b>7 A</b>
Conv. therm. current with 3 contacts	<b>5,6 A</b>	<b>5,6 A</b>	<b>5,6 A</b>
Conv. therm. current with 4 contacts	<b>4,9 A</b>	<b>4,9 A</b>	<b>4,9 A</b>
Conv. therm. current with 5 contacts	<b>4,4 A</b>	<b>4,4 A</b>	<b>4,4 A</b>
Conv. therm. current with 6 contacts	<b>4 A</b>	<b>4 A</b>	<b>4 A</b>

<b>Times</b>	<b>774700</b>	<b>774701</b>	<b>774703</b>
Switch-on delay			
with automatic start typ.	<b>180 ms</b>	<b>180 ms</b>	<b>180 ms</b>
with automatic start max.	<b>250 ms</b>	<b>250 ms</b>	<b>250 ms</b>
with automatic start after power on typ.	<b>200 ms</b>	<b>200 ms</b>	<b>200 ms</b>
with automatic start after power on max.	<b>300 ms</b>	<b>300 ms</b>	<b>300 ms</b>
with manual start typ.	<b>200 ms</b>	<b>200 ms</b>	<b>200 ms</b>
with manual start max.	<b>250 ms</b>	<b>250 ms</b>	<b>250 ms</b>
with monitored start typ.	<b>150 ms</b>	<b>150 ms</b>	<b>150 ms</b>
with monitored start max.	<b>200 ms</b>	<b>200 ms</b>	<b>200 ms</b>
Delay-on de-energisation			
with E-STOP typ.	<b>20 ms</b>	<b>20 ms</b>	<b>20 ms</b>
with E-STOP max.	<b>30 ms</b>	<b>30 ms</b>	<b>30 ms</b>
with power failure typ.	<b>170 ms</b>	<b>170 ms</b>	<b>170 ms</b>
with power failure max.	<b>250 ms</b>	<b>250 ms</b>	<b>250 ms</b>
Recovery time at max. switching frequency 1/s			
after E-STOP	<b>50 ms</b>	<b>50 ms</b>	<b>50 ms</b>
after power failure	<b>300 ms</b>	<b>300 ms</b>	<b>300 ms</b>
Min. start pulse duration with a monitored start			
	<b>50 ms</b>	<b>50 ms</b>	<b>50 ms</b>
Supply interruption before de-energisation			
	<b>35 ms</b>	<b>35 ms</b>	<b>35 ms</b>
<b>Environmental data</b>	<b>774700</b>	<b>774701</b>	<b>774703</b>
Climatic suitability			
	<b>EN 60068-2-78</b>	<b>EN 60068-2-78</b>	<b>EN 60068-2-78</b>
Ambient temperature			
Temperature range	<b>-10 - 55 °C</b>	<b>-10 - 55 °C</b>	<b>-10 - 55 °C</b>
Storage temperature			
Temperature range	<b>-40 - 85 °C</b>	<b>-40 - 85 °C</b>	<b>-40 - 85 °C</b>
Climatic suitability			
Humidity	<b>93 % r. h. at 40 °C</b>	<b>93 % r. h. at 40 °C</b>	<b>93 % r. h. at 40 °C</b>
Condensation during operation			
	<b>Not permitted</b>	<b>Not permitted</b>	<b>Not permitted</b>
EMC			
	<b>EN 60947-5-1, EN 61000-6-2, EN 61326-3-1</b>	<b>EN 60947-5-1, EN 61000-6-2, EN 61326-3-1</b>	<b>EN 60947-5-1, EN 61000-6-2, EN 61326-3-1</b>
Vibration			
in accordance with the standard	<b>EN 60068-2-6</b>	<b>EN 60068-2-6</b>	<b>EN 60068-2-6</b>
Frequency	<b>10 - 55 Hz</b>	<b>10 - 55 Hz</b>	<b>10 - 55 Hz</b>
Amplitude	<b>0,35 mm</b>	<b>0,35 mm</b>	<b>0,35 mm</b>

<b>Environmental data</b>	<b>774700</b>	<b>774701</b>	<b>774703</b>
Airgap creepage			
in accordance with the standard	<b>EN 60947-1</b>	<b>EN 60947-1</b>	<b>EN 60947-1</b>
Overvoltage category	<b>III / II</b>	<b>III / II</b>	<b>III / II</b>
Pollution degree	<b>2</b>	<b>2</b>	<b>2</b>
Rated insulation voltage	<b>250 V</b>	<b>250 V</b>	<b>250 V</b>
Rated impulse withstand voltage	<b>4 kV</b>	<b>4 kV</b>	<b>4 kV</b>
Protection type			
Housing	<b>IP40</b>	<b>IP40</b>	<b>IP40</b>
Terminals	<b>IP20</b>	<b>IP20</b>	<b>IP20</b>
Mounting area (e.g. control cabinet)	<b>IP54</b>	<b>IP54</b>	<b>IP54</b>
<b>Mechanical data</b>	<b>774700</b>	<b>774701</b>	<b>774703</b>
Mounting position	<b>Any</b>	<b>Any</b>	<b>Any</b>
Mechanical life	<b>10,000,000 cycles</b>	<b>10,000,000 cycles</b>	<b>10,000,000 cycles</b>
Material			
Bottom	<b>PPO UL 94 V1</b>	<b>PPO UL 94 V1</b>	<b>PPO UL 94 V1</b>
Front	<b>ABS UL 94 V0</b>	<b>ABS UL 94 V0</b>	<b>ABS UL 94 V0</b>
Top	<b>PPO UL 94 V1</b>	<b>PPO UL 94 V1</b>	<b>PPO UL 94 V1</b>
Connection type	<b>Screw terminal</b>	<b>Screw terminal</b>	<b>Screw terminal</b>
Mounting type	<b>Fixed</b>	<b>Fixed</b>	<b>Fixed</b>
Conductor cross section with screw terminals			
1 core flexible	<b>0,2 - 4 mm<sup>2</sup>, 24 - 10 AWG</b>	<b>0,2 - 4 mm<sup>2</sup>, 24 - 10 AWG</b>	<b>0,2 - 4 mm<sup>2</sup>, 24 - 10 AWG</b>
2 core with the same cross section, flexible with crimp connectors, no plastic sleeve	<b>0,2 - 2,5 mm<sup>2</sup>, 24 - 14 AWG</b>	<b>0,2 - 2,5 mm<sup>2</sup>, 24 - 14 AWG</b>	<b>0,2 - 2,5 mm<sup>2</sup>, 24 - 14 AWG</b>
2 core with the same cross section, flexible without crimp connectors or with TWIN crimp connectors	<b>0,2 - 2,5 mm<sup>2</sup>, 24 - 14 AWG</b>	<b>0,2 - 2,5 mm<sup>2</sup>, 24 - 14 AWG</b>	<b>0,2 - 2,5 mm<sup>2</sup>, 24 - 14 AWG</b>
Torque setting with screw terminals	<b>0,5 Nm</b>	<b>0,5 Nm</b>	<b>0,5 Nm</b>
Stripping length with screw terminals	<b>6 mm</b>	<b>6 mm</b>	<b>6 mm</b>
Dimensions			
Height	<b>87 mm</b>	<b>87 mm</b>	<b>87 mm</b>
Width	<b>90 mm</b>	<b>90 mm</b>	<b>90 mm</b>
Depth	<b>121 mm</b>	<b>121 mm</b>	<b>121 mm</b>
Weight	<b>720 g</b>	<b>720 g</b>	<b>720 g</b>

Where standards are undated, the 2022-09 latest editions shall apply.

### Technical details Order no. 774706, 774709

<b>General</b>	<b>774706</b>	<b>774709</b>
Certifications	CCC, CE, EAC, TÜV, UKCA, cULus Listed	CCC, CE, EAC, TÜV, UKCA, cULus Listed
<b>Electrical data</b>	<b>774706</b>	<b>774709</b>
Supply voltage		
Voltage	<b>230 - 240 V</b>	<b>24 V</b>
Kind	<b>AC</b>	<b>DC</b>
Voltage tolerance	<b>-15 %/+10 %</b>	<b>-15 %/+10 %</b>
Output of external power supply (AC)	<b>10 VA</b>	–
Output of external power supply (DC)	–	<b>5,5 W</b>
Frequency range AC	<b>50 - 60 Hz</b>	–
Residual ripple DC	–	<b>160 %</b>
Duty cycle	<b>100 %</b>	<b>100 %</b>
<b>Inputs</b>	<b>774706</b>	<b>774709</b>
Quantity	<b>2</b>	<b>2</b>
Voltage at		
Input circuit DC	<b>24 V</b>	<b>24 V</b>
Start circuit DC	<b>24 V</b>	<b>24 V</b>
Feedback loop DC	<b>24 V</b>	<b>24 V</b>
Current at		
Input circuit DC	<b>50 mA</b>	<b>50 mA</b>
Start circuit DC	<b>100 mA</b>	<b>100 mA</b>
Feedback loop DC	<b>100 mA</b>	<b>100 mA</b>
Min. input resistance at power-on	<b>89 Ohm</b>	<b>89 Ohm</b>
Max. overall cable resistance RI-max		
Single-channel at UB DC	–	<b>45 Ohm</b>
Single-channel at UB AC	<b>45 Ohm</b>	–
Dual-channel without detection of shorts across contacts at UB DC	–	<b>90 Ohm</b>
Dual-channel without detection of shorts across contacts at UB AC	<b>90 Ohm</b>	–
Dual-channel with detection of shorts across contacts at UB DC	–	<b>15 Ohm</b>
Dual-channel with detection of shorts across contacts at UB AC	<b>15 Ohm</b>	–
<b>Relay outputs</b>	<b>774706</b>	<b>774709</b>
Number of output contacts		
Safety contacts (N/O), instantaneous	<b>6</b>	<b>6</b>
Auxiliary contacts (N/C)	<b>4</b>	<b>4</b>
Max. short circuit current IK	<b>1 kA</b>	<b>1 kA</b>

<b>Relay outputs</b>	<b>774706</b>	<b>774709</b>
Utilisation category		
in accordance with the standard	<b>EN 60947-4-1</b>	<b>EN 60947-4-1</b>
Utilisation category of safety con- tacts		
AC1 at	<b>400 V</b>	<b>400 V</b>
Min. current	<b>0,01 A</b>	<b>0,01 A</b>
Max. current	<b>5 A</b>	<b>5 A</b>
Max. power	<b>2000 VA</b>	<b>2000 VA</b>
AC1 at	<b>240 V</b>	<b>240 V</b>
Min. current	<b>0,01 A</b>	<b>0,01 A</b>
Max. current	<b>8 A</b>	<b>8 A</b>
Max. power	<b>2000 VA</b>	<b>2000 VA</b>
DC1 at	<b>24 V</b>	<b>24 V</b>
Min. current	<b>0,01 A</b>	<b>0,01 A</b>
Max. current	<b>8 A</b>	<b>8 A</b>
Max. power	<b>200 W</b>	<b>200 W</b>
Utilisation category of auxiliary con- tacts		
AC1 at	<b>240 V</b>	<b>240 V</b>
Min. current	<b>0,01 A</b>	<b>0,01 A</b>
Max. current	<b>8 A</b>	<b>8 A</b>
Max. power	<b>2000 VA</b>	<b>2000 VA</b>
DC1 at	<b>24 V</b>	<b>24 V</b>
Min. current	<b>0,01 A</b>	<b>0,01 A</b>
Max. current	<b>8 A</b>	<b>8 A</b>
Max. power	<b>200 W</b>	<b>200 W</b>
Utilisation category		
in accordance with the standard	<b>EN 60947-5-1</b>	<b>EN 60947-5-1</b>
Utilisation category of safety con- tacts		
AC15 at	<b>230 V</b>	<b>230 V</b>
Max. current	<b>5 A</b>	<b>5 A</b>
DC13 (6 cycles/min) at	<b>24 V</b>	<b>24 V</b>
Max. current	<b>7 A</b>	<b>7 A</b>
Utilisation category of auxiliary con- tacts		
AC15 at	<b>230 V</b>	<b>230 V</b>
Max. current	<b>5 A</b>	<b>5 A</b>
DC13 (6 cycles/min) at	<b>24 V</b>	<b>24 V</b>
Max. current	<b>7 A</b>	<b>7 A</b>

<b>Relay outputs</b>	<b>774706</b>	<b>774709</b>
Utilisation category in accordance with UL		
Voltage with current	<b>240 V AC G. P. 8 A</b>	<b>240 V AC G. P. 8 A</b>
Voltage with current	<b>24 V DC Resistive 5 A</b>	<b>24 V DC Resistive 5 A</b>
Pilot Duty	<b>B300, R300</b>	<b>B300, R300</b>
External contact fuse protection, safety contacts		
in accordance with the standard	<b>EN 60947-5-1</b>	<b>EN 60947-5-1</b>
Max. melting integral	<b>240 A<sup>2</sup>s</b>	<b>240 A<sup>2</sup>s</b>
Blow-out fuse, quick	<b>10 A</b>	<b>10 A</b>
Blow-out fuse, slow	<b>6 A</b>	<b>6 A</b>
Blow-out fuse, gG	<b>10 A</b>	<b>10 A</b>
Circuit breaker 24V AC/DC, characteristic B/C	<b>6 A</b>	<b>6 A</b>
External contact fuse protection, auxiliary contacts		
Max. melting integral	<b>240 A<sup>2</sup>s</b>	<b>240 A<sup>2</sup>s</b>
Blow-out fuse, quick	<b>10 A</b>	<b>10 A</b>
Blow-out fuse, slow	<b>6 A</b>	<b>6 A</b>
Blow-out fuse, gG	<b>10 A</b>	<b>10 A</b>
Circuit breaker, 24 V AC/DC, characteristic B/C	<b>6 A</b>	<b>6 A</b>
Contact material	<b>AgSnO<sub>2</sub> + 0,2 µm Au</b>	<b>AgSnO<sub>2</sub> + 0,2 µm Au</b>
<b>Conventional thermal current while loading several contacts</b>	<b>774706</b>	<b>774709</b>
I <sub>th</sub> per contact at UB AC; AC1: 240 V, DC1: 24 V		
Conv. therm. current with 1 contact	<b>8 A</b>	–
Conv. therm. current with 2 contacts	<b>7 A</b>	–
Conv. therm. current with 3 contacts	<b>5,6 A</b>	–
Conv. therm. current with 4 contacts	<b>4,9 A</b>	–
Conv. therm. current with 5 contacts	<b>4,4 A</b>	–
Conv. therm. current with 6 contacts	<b>4 A</b>	–

<b>Conventional thermal current while loading several contacts</b>		
	<b>774706</b>	<b>774709</b>
I <sub>th</sub> per contact at UB DC; AC1: 240 V, DC1: 24 V		
Conv. therm. current with 1 contact	–	<b>8 A</b>
Conv. therm. current with 2 contacts	–	<b>8 A</b>
Conv. therm. current with 3 contacts	–	<b>7 A</b>
Conv. therm. current with 4 contacts	–	<b>6,1 A</b>
Conv. therm. current with 5 contacts	–	<b>5,4 A</b>
Conv. therm. current with 6 contacts	–	<b>5 A</b>
<b>Times</b>	<b>774706</b>	<b>774709</b>
Switch-on delay		
with automatic start typ.	<b>180 ms</b>	<b>190 ms</b>
with automatic start max.	<b>250 ms</b>	<b>250 ms</b>
with automatic start after power on typ.	<b>200 ms</b>	<b>200 ms</b>
with automatic start after power on max.	<b>300 ms</b>	<b>300 ms</b>
with manual start typ.	<b>200 ms</b>	<b>200 ms</b>
with manual start max.	<b>250 ms</b>	<b>250 ms</b>
with monitored start typ.	<b>150 ms</b>	<b>165 ms</b>
with monitored start max.	<b>200 ms</b>	<b>220 ms</b>
Delay-on de-energisation		
with E-STOP typ.	<b>20 ms</b>	<b>20 ms</b>
with E-STOP max.	<b>30 ms</b>	<b>30 ms</b>
with power failure typ.	<b>170 ms</b>	<b>170 ms</b>
with power failure max.	<b>250 ms</b>	<b>250 ms</b>
Recovery time at max. switching frequency 1/s		
after E-STOP	<b>50 ms</b>	<b>50 ms</b>
after power failure	<b>300 ms</b>	<b>300 ms</b>
Min. start pulse duration with a monitored start		
	<b>50 ms</b>	<b>50 ms</b>
Supply interruption before de-energisation		
	<b>35 ms</b>	<b>35 ms</b>
<b>Environmental data</b>	<b>774706</b>	<b>774709</b>
Climatic suitability	<b>EN 60068-2-78</b>	<b>EN 60068-2-78</b>
Ambient temperature		
Temperature range	<b>-10 - 55 °C</b>	<b>-10 - 55 °C</b>
Storage temperature		
Temperature range	<b>-40 - 85 °C</b>	<b>-40 - 85 °C</b>



<b>Environmental data</b>	<b>774706</b>	<b>774709</b>
Climatic suitability		
Humidity	93 % r. h. at 40 °C	93 % r. h. at 40 °C
Condensation during operation	Not permitted	Not permitted
EMC	EN 60947-5-1, EN 61000-6-2, EN 61326-3-1	EN 60947-5-1, EN 61000-6-2, EN 61326-3-1
Vibration		
in accordance with the standard	EN 60068-2-6	EN 60068-2-6
Frequency	10 - 55 Hz	10 - 55 Hz
Amplitude	0,35 mm	0,35 mm
Airgap creepage		
in accordance with the standard	EN 60947-1	EN 60947-1
Overvoltage category	III / II	III / II
Pollution degree	2	2
Rated insulation voltage	250 V	250 V
Rated impulse withstand voltage	4 kV	4 kV
Protection type		
Housing	IP40	IP40
Terminals	IP20	IP20
Mounting area (e.g. control cabinet)	IP54	IP54
<b>Mechanical data</b>	<b>774706</b>	<b>774709</b>
Mounting position	Any	Any
Mechanical life	10,000,000 cycles	10,000,000 cycles
Material		
Bottom	PPO UL 94 V1	PPO UL 94 V1
Front	ABS UL 94 V0	ABS UL 94 V0
Top	PPO UL 94 V1	PPO UL 94 V1
Connection type	Screw terminal	Screw terminal
Mounting type	Fixed	Fixed
Conductor cross section with screw terminals		
1 core flexible	0,2 - 4 mm <sup>2</sup> , 24 - 10 AWG	0,2 - 4 mm <sup>2</sup> , 24 - 10 AWG
2 core with the same cross section, flexible with crimp connectors, no plastic sleeve	0,2 - 2,5 mm <sup>2</sup> , 24 - 14 AWG	0,2 - 2,5 mm <sup>2</sup> , 24 - 14 AWG
2 core with the same cross section, flexible without crimp connectors or with TWIN crimp connectors	0,2 - 2,5 mm <sup>2</sup> , 24 - 14 AWG	0,2 - 2,5 mm <sup>2</sup> , 24 - 14 AWG
Torque setting with screw terminals	0,5 Nm	0,5 Nm
Stripping length with screw terminals	6 mm	6 mm
Dimensions		
Height	87 mm	87 mm
Width	90 mm	90 mm
Depth	121 mm	121 mm

Mechanical data	774706	774709
Weight	720 g	540 g

Where standards are undated, the 2022-09 latest editions shall apply.

### Safety characteristic data



**NOTICE**

You must comply with the safety characteristic data in order to achieve the required safety level for your plant/machine.

Operating mode	EN ISO 13849-1: 2015	EN ISO 13849-1: 2015	EN IEC 62061 SIL CL/ maximum SIL	EN IEC 62061 PFH <sub>D</sub> [1/h]	EN/IEC 61511 SIL	EN/IEC 61511 PFD	EN ISO 13849-1: 2015 T <sub>M</sub> [year]
–	PL e	Cat. 4	SIL 3	2,31E-09	SIL 3	2,03E-06	20

Explanatory notes for the safety-related characteristic data:

- ▶ Safety characteristic data in accordance with EN IEC 62061 and EN/IEC 61511 was calculated based on EN/IEC 61508.
- ▶ T<sub>M</sub> is the maximum mission time in accordance with EN ISO 13849-1. The value also applies as the retest interval in accordance with EN/IEC 61508-6 and EN/IEC 61511 and as the proof test interval and mission time in accordance with EN IEC 62061.

All the units used within a safety function must be considered when calculating the safety characteristic data.



**INFORMATION**

A safety function's SIL/PL values are **not** identical to the SIL/PL values of the units that are used and may be different. We recommend that you use the PAScal software tool to calculate the safety function's SIL/PL values.

## Supplementary data



### CAUTION!

It is essential to consider the relay's service life graphs. The relay outputs' safety-related characteristic data is only valid if the values in the service life graphs are met.

The PFH value depends on the switch frequency and the load of the relay output. If the service life graphs are not accessible, the stated PFH value can be used irrespective of the switch frequency and the load, as the PFH value already considers the relay's B10d value as well as the failure rates of the other components.

### Service life graph

The service life graphs indicate the number of cycles from which failures due to wear must be expected. The wear is mainly caused by the electrical load; the mechanical load is negligible.

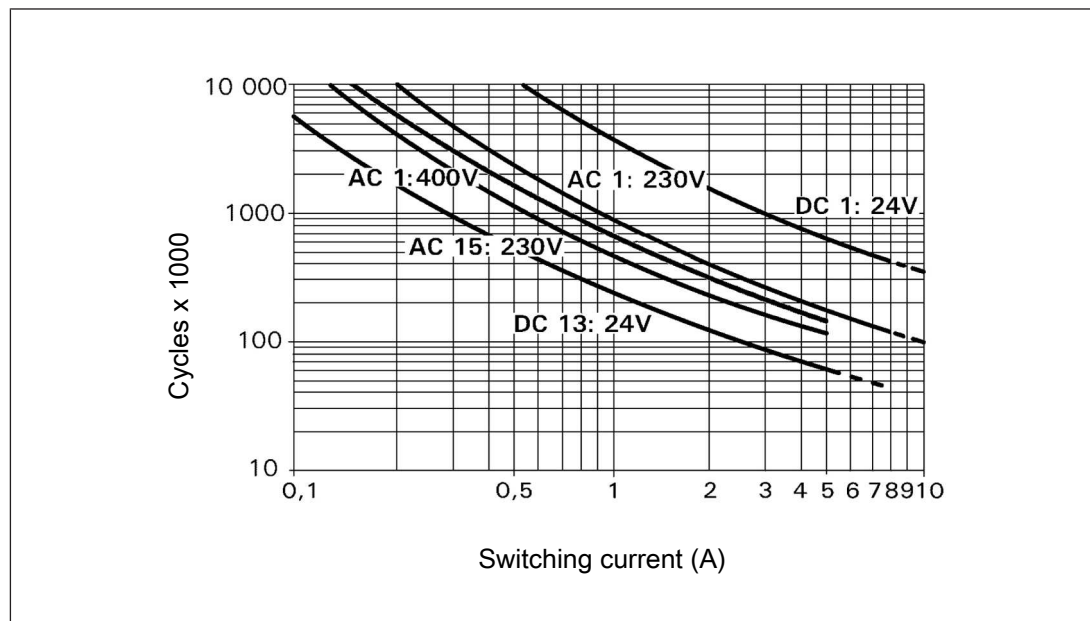

### Example

- ▶ Inductive load: 0.2 A
- ▶ Utilisation category: AC15
- ▶ Contact service life: 4 000 000 cycles

Provided the application to be implemented requires fewer than 4 000 000 cycles, the PFH value (see Technical details) can be used in the calculation.

To increase the service life, sufficient spark suppression must be provided on all output contacts. With capacitive loads, any power surges that occur must be noted. With DC contactors, use flywheel diodes for spark suppression.

**Order reference**

Product type	Features	Connection type	Order no.
PNOZ X10	24 V AC	Screw terminals	774700
PNOZ X10	42 VAC	Screw terminals	774701
PNOZ X10	110 - 120 VAC	Screw terminals	774703
PNOZ X10	230 - 240 VAC	Screw terminals	774706
PNOZ X10	24 V DC	Screw terminals	774709

**EC declaration of conformity**

This product/these products meet the requirements of the directive 2006/42/EC for machinery of the European Parliament and of the Council. The complete EC Declaration of Conformity is available on the Internet at [www.pilz.com/downloads](http://www.pilz.com/downloads).

Authorised representative: Norbert Fröhlich, Pilz GmbH & Co. KG, Felix-Wankel-Str. 2, 73760 Ostfildern, Germany

**UKCA-Declaration of Conformity**

This product(s) complies with following UK legislation: Supply of Machinery (Safety) Regulation 2008.

The complete UKCA Declaration of Conformity is available on the Internet at [www.pilz.com/downloads](http://www.pilz.com/downloads).

Representative: Pilz Automation Technology, Pilz House, Little Colliers Field, Corby, Northamptonshire, NN18 8TJ United Kingdom, eMail: [mail@pilz.co.uk](mailto:mail@pilz.co.uk)

# ► Support

Technical support is available from Pilz round the clock.

## Americas

### Brazil

+55 11 97569-2804

### Canada

+1 888 315 7459

### Mexico

+52 55 5572 1300

### USA (toll-free)

+1 877-PILZUSA (745-9872)

## Asia

### China

+86 21 60880878-216

### Japan

+81 45 471-2281

### South Korea

+82 31 778 3300

## Australia and Oceania

### Australia

+61 3 95600621

### New Zealand

+64 9 6345350

## Europe

### Austria

+43 1 7986263-0

### Belgium, Luxembourg

+32 9 3217570

### France

+33 3 88104003

### Germany

+49 711 3409-444

### Ireland

+353 21 4804983

### Italy, Malta

+39 0362 1826711

## Scandinavia

+45 74436332

## Spain

+34 938497433

## Switzerland

+41 62 88979-32

## The Netherlands

+31 347 320477

## Turkey

+90 216 5775552

## United Kingdom

+44 1536 462203

## You can reach our international hotline on:

+49 711 3409-222

support@pilz.com

Pilz develops environmentally-friendly products using ecological materials and energy-saving technologies. Offices and production facilities are ecologically designed, environmentally-aware and energy-saving. So Pilz offers sustainability, plus the security of using energy-efficient products and environmentally-friendly solutions.



We are represented internationally. Please refer to our homepage [www.pilz.com](http://www.pilz.com) for further details or contact our headquarters.

Headquarters: Pilz GmbH & Co. KG, Felix-Wankel-Straße 2, 73760 Ostfildern, Germany  
Telephone: +49 711 3409-0, Telefax: +49 711 3409-133, E-Mail: [info@pilz.com](mailto:info@pilz.com), Internet: [www.pilz.com](http://www.pilz.com)

**PILZ**  
THE SPIRIT OF SAFETY

19554-EN-11, 2023-06 Printed in Germany  
© Pilz GmbH & Co. KG, 2019

CECE®, CHRE®, CMSE®, InduraNET p®, Leansafe®, Master of Safety®, Master of Security®, PAS4000®, PAScaff®, PASconfig®, Pilz®, PTT®, PLID®, PMCPirimo®, PMCPiritego®, PMCTendo®, PMD®, PMJ®, PNOZ®, PRBM®, PRCM®, PRIMO®, PRM®, PSENET p®, PSEN®, PSS®, PVS®, SafetyBUS p®, SafetyEYE®, SafetyNET p®, THE SPIRIT OF SAFETY® are registered and protected trademarks of Pilz GmbH & Co. KG in some countries. We would point out that product features may vary from the details stated in this document, depending on the status at the time of publication and the scope of the equipment. We accept no responsibility for the validity, accuracy and entirety of the text and graphics presented in this information. Please contact our Technical Support if you have any questions.