



Visualisation; Diagnostics

Easy to Configure

Programming IEC 61131-3

Rapid Installation

## PNOZ X2C

# PILZ

THE SPIRIT OF SAFETY

► Safety relays

This document is the original document.

All rights to this documentation are reserved by Pilz GmbH & Co. KG. Copies may be made for the user's internal purposes. Suggestions and comments for improving this documentation will be gratefully received.

Source code from third-party manufacturers or open source software has been used for some components. The relevant licence information is available on the Internet on the Pilz homepage.

Pilz®, PIT®, PMI®, PNOZ®, Primo®, PSEN®, PSS®, PVIS®, SafetyBUS p®, SafetyEYE®, SafetyNET p®, the spirit of safety® are registered and protected trademarks of Pilz GmbH & Co. KG in some countries.



SD means Secure Digital

<b>Introduction</b> .....	<b>4</b>
Validity of documentation .....	4
Using the documentation .....	4
Definition of symbols .....	4
<b>Safety</b> .....	<b>5</b>
Intended use .....	5
Safety regulations .....	6
Safety assessment .....	6
Use of qualified personnel .....	6
Warranty and liability .....	6
Disposal .....	6
For your safety .....	7
<b>Unit features</b> .....	<b>7</b>
<b>Safety features</b> .....	<b>7</b>
<b>Block diagram/terminal configuration</b> .....	<b>8</b>
<b>Function Description</b> .....	<b>9</b>
Operating modes .....	9
Timing diagram .....	9
<b>Installation</b> .....	<b>10</b>
<b>Wiring</b> .....	<b>10</b>
<b>Preparing for operation</b> .....	<b>11</b>
<b>Operation</b> .....	<b>12</b>
Status indicators .....	13
<b>Faults – Interference</b> .....	<b>13</b>
<b>Dimensions in mm</b> .....	<b>13</b>
<b>Technical details</b> .....	<b>14</b>
Safety characteristic data .....	17
<b>Supplementary data</b> .....	<b>17</b>
Service life graph .....	18
<b>Order reference</b> .....	<b>18</b>
<b>EC declaration of conformity</b> .....	<b>18</b>

## Introduction

### Validity of documentation

This documentation is valid for the product PNOZ X2C. It is valid until new documentation is published.

This operating manual explains the function and operation, describes the installation and provides guidelines on how to connect the product.

### Using the documentation

This document is intended for instruction. Only install and commission the product if you have read and understood this document. The document should be retained for future reference.

### Definition of symbols

Information that is particularly important is identified as follows:



#### **DANGER!**

This warning must be heeded! It warns of a hazardous situation that poses an immediate threat of serious injury and death and indicates preventive measures that can be taken.



#### **WARNING!**

This warning must be heeded! It warns of a hazardous situation that could lead to serious injury and death and indicates preventive measures that can be taken.



#### **CAUTION!**

This refers to a hazard that can lead to a less serious or minor injury plus material damage, and also provides information on preventive measures that can be taken.



#### **NOTICE**

This describes a situation in which the product or devices could be damaged and also provides information on preventive measures that can be taken. It also highlights areas within the text that are of particular importance.

**INFORMATION**

This gives advice on applications and provides information on special features.

**Safety****Intended use**

The safety relay PNOZ X2C provides a safety-related interruption of a safety circuit.

The safety relay meets the requirements of EN 60947-5-1 and EN 60204-1 and may be used in applications with:

- ▶ E-STOP pushbuttons
- ▶ Safety gates

The following is deemed improper use in particular

- ▶ Any component, technical or electrical modification to the product,
- ▶ Use of the product outside the areas described in this manual,
- ▶ Use of the product outside the technical details (see [Technical details](#)  14]).

**NOTICE****EMC-compliant electrical installation**

The product is designed for use in an industrial environment. The product may cause interference if installed in other environments. If installed in other environments, measures should be taken to comply with the applicable standards and directives for the respective installation site with regard to interference.

## Safety regulations

### Safety assessment

Before using a device, a safety assessment in accordance with the Machinery Directive is required.

The product as an individual component fulfils the functional safety requirements in accordance with EN ISO 13849 and EN 62061. However, this does not guarantee the functional safety of the overall plant/machine. To achieve the relevant safety level of the overall plant/machine's required safety functions, each safety function needs to be considered separately.

### Use of qualified personnel

The products may only be assembled, installed, programmed, commissioned, operated, maintained and decommissioned by persons who are competent to do so.

A competent person is a qualified and knowledgeable person who, because of their training, experience and current professional activity, has the specialist knowledge required. To be able to inspect, assess and operate devices, systems and machines, the person has to be informed of the state of the art and the applicable national, European and international laws, directives and standards.

It is the company's responsibility only to employ personnel who

- ▶ Are familiar with the basic regulations concerning health and safety / accident prevention,
- ▶ Have read and understood the information provided in the section entitled Safety
- ▶ Have a good knowledge of the generic and specialist standards applicable to the specific application.

### Warranty and liability

All claims to warranty and liability will be rendered invalid if

- ▶ The product was used contrary to the purpose for which it is intended,
- ▶ Damage can be attributed to not having followed the guidelines in the manual,
- ▶ Operating personnel are not suitably qualified,
- ▶ Any type of modification has been made (e.g. exchanging components on the PCB boards, soldering work etc.).

### Disposal

- ▶ In safety-related applications, please comply with the mission time  $T_M$  in the safety-related characteristic data.
- ▶ When decommissioning, please comply with local regulations regarding the disposal of electronic devices (e.g. Electrical and Electronic Equipment Act).

**For your safety**

The unit meets all the necessary conditions for safe operation. However, please note the following:

- ▶ Note for overvoltage category III: If voltages higher than low voltage (>50 VAC or >120 VDC) are present on the unit, connected control elements and sensors must have a rated insulation voltage of at least 250 V.

**Unit features**

- ▶ Positive-guided relay outputs:
  - 2 safety contacts (N/O), instantaneous
- ▶ Connection options for:
  - E-STOP pushbutton
  - Safety gate limit switch
  - Start button
- ▶ LED display for:
  - Supply voltage
  - Switch status of the safety contacts

**Safety features**

The safety relay meets the following safety requirements:

- ▶ The circuit is redundant with built-in self-monitoring.
- ▶ The safety function remains effective in the case of a component failure.
- ▶ The correct opening and closing of the safety function relays is tested automatically in each on-off cycle.

### Block diagram/terminal configuration

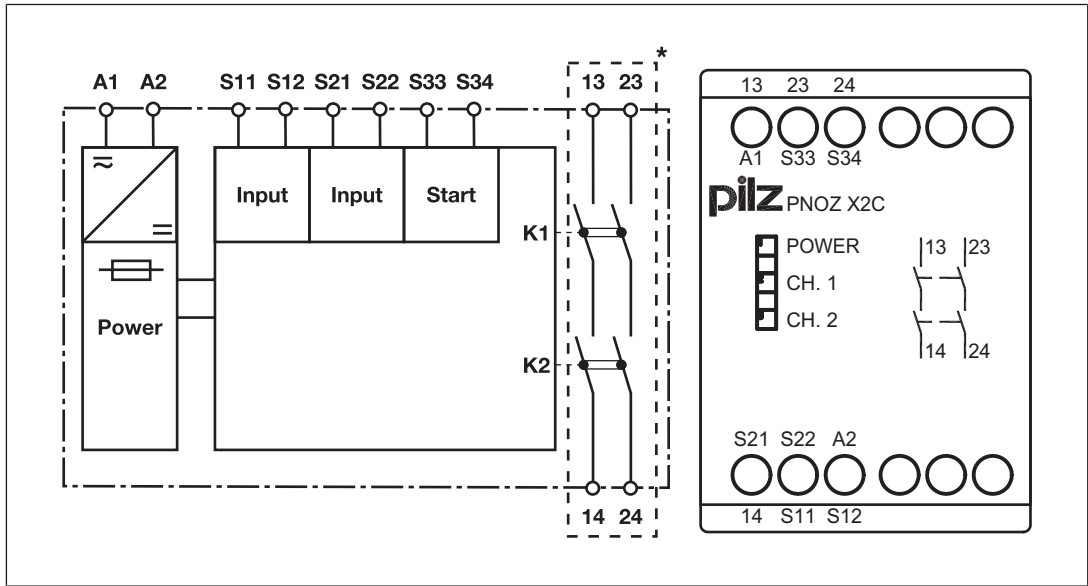

\*Insulation between the non-marked area and the relay contacts: Basic insulation (over-voltage category III), Protective separation (overvoltage category II)



## Function Description

The safety relay PNOZ X2C provides a safety-oriented interruption of a safety circuit. When supply voltage is supplied the "POWER" LED is lit. The unit is ready for operation when the start circuit S33-S34 is closed.

- ▶ Input circuit is closed (e.g. E-STOP pushbutton not operated):
  - Safety contacts 13-14 and 23-24 are closed, the unit is active.
  - The LEDs "CH.1" and "CH.2" are lit.
- ▶ Input circuit is opened (e.g. E-STOP pushbutton operated):
  - Safety contacts 13-14 and 23-24 are redundantly opened.
  - The LEDs "CH.1" and "CH.2" go out.

## Operating modes

- ▶ Single-channel operation: No redundancy in the input circuit, the PNOZ X2C detects
  - earth faults in the input circuit,
  - earth faults and short circuits in the start circuit.
- ▶ Dual-channel operation with detection of shorts across contacts: Redundant input circuit, detects PNOZ X2C
  - earth faults in the start and input circuit,
  - short circuits in the start and input circuit,
  - shorts across contacts in the input circuit.
- ▶ Monitored start: Unit is active once the input circuit is closed and once the start circuit is closed after the waiting period has elapsed (see [Technical details \[14\]](#)).
- ▶ Increase in the number of available contacts by connecting contact expansion modules or external contactors/relays.

## Timing diagram

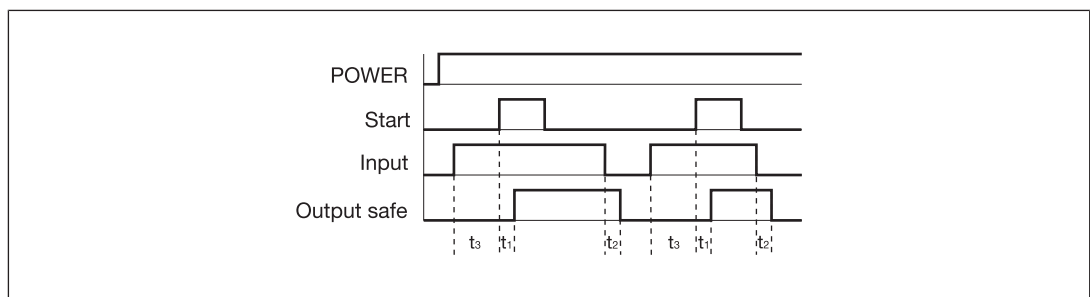

## Legend

- ▶ Power: Supply voltage
- ▶ Start: Start circuit
- ▶ Input: Input circuit
- ▶ Output safe: Safety contacts
- ▶  $t_1$ : Switch-on delay
- ▶  $t_2$ : Delay-on de-energisation
- ▶  $t_3$ : Waiting period with a monitored start

## Installation

- ▶ The unit should be installed in a control cabinet with a protection type of at least IP54.
- ▶ Use the notch on the rear of the unit to attach it to a DIN rail (35 mm).
- ▶ When installed vertically: Secure the unit by using a fixing element (e.g. retaining bracket or end angle).

## Wiring

Please note:

- ▶ Information given in the "[Technical details \[14\]](#)" must be followed.
- ▶ The outputs 13-14, 23-24 are safety contacts.
- ▶ To prevent contact welding, a fuse should be connected before the output contacts (see [Technical details \[14\]](#)).
- ▶ Calculation of the max. cable length  $l_{\max}$  in the input circuit:

$$l_{\max} = \frac{R_{l_{\max}}}{R_l / \text{km}}$$

$R_{l_{\max}}$  = max. overall cable resistance (see [Technical details \[14\]](#))  
 $R_l / \text{km}$  = cable resistance/km

- ▶ Use copper wiring with a temperature stability of 60/75 °C.
- ▶ To prevent EMC interferences (particularly common-mode interferences) the measures described in EN 60204-1 must be executed. This includes the separate routing of cables of the control circuits (input, start and feedback loop) from other cables for energy transmission or the shielding of cables, for example.
- ▶ Adequate protection must be provided on all output contacts with capacitive and inductive loads.
- ▶ Do not switch low currents using contacts that have been used previously with high currents.
- ▶ When connecting magnetically operated, reed proximity switches, ensure that the max. peak inrush current (on the input circuit) does not overload the proximity switch.
- ▶ The power supply must comply with the regulations for extra low voltages with protective electrical separation (SELV, PELV) in accordance with VDE 0100, Part 410.

### Important for detection of shorts across contacts:

As this function for detecting shorts across contacts is not failsafe, it is tested by Pilz during the final control check. If there is a danger of exceeding the cable runs, we recommend the following test after the installation of the device:

1. Unit ready for operation (output contacts closed)
2. Short circuit the test terminals S12, S22 for detecting shorts across the inputs.
3. The unit's fuse must be triggered and the output contacts must open. Cable lengths in the scale of the maximum length can delay the fuse triggering for up to 2 minutes.
4. Reset the fuse: remove the short circuit and switch off the supply voltage for approx. 1 minute.

### Preparing for operation

Supply voltage	AC	DC
Input circuit	Single-channel	Dual-channel (with detection of shorts across contacts)
E-STOP		
Safety gate		





#### NOTICE

With single-channel wiring the safety level of your machine/plant may be lower than the safety level of the unit (see [Safety characteristic data \[17\]](#)).

Start circuit	Single-channel	Dual-channel (with detection of shorts across contacts)
Monitored start		
Feedback loop	Single-channel	Dual-channel (with detection of shorts across contacts)
Contacts from external contactors		

**Legend**

- ▶ S1/S2: E-STOP/safety gate switch
- ▶ S3: Reset button
- ▶ : Switch operated
- ▶ : Gate open
- ▶ : Gate closed

**Operation**

When the relay outputs are switched on, the mechanical contact on the relay cannot be tested automatically. Depending on the operational environment, measures to detect the non-opening of switching elements may be required under some circumstances.

When the product is used in accordance with the European Machinery Directive, a check must be carried out to ensure that the safety contacts on the relay outputs open correctly. Open the safety contacts (switch off output) and start the device again, so that the internal diagnostics can check that the safety contacts open correctly

- ▶ for SIL CL 3/PL e at least 1x per month
- ▶ for SIL CL 2/PL d at least 1x per year

**NOTICE**

The safety function should be checked after initial commissioning and each time the plant/machine is changed. The safety functions may only be checked by qualified personnel.

**Status indicators**

LEDs indicate the status and errors during operation:



LED on



**POWER**

Supply voltage is present.



**CH.1**

Safety contacts of channel 1 are closed.



**CH.2**

Safety contacts of channel 2 are closed.

**Faults – Interference**

- ▶ Earth fault: The supply voltage fails and the safety contacts open. Once the cause of the respective fault has been rectified and the supply voltage is switched off for approx. 1 minute, the unit is ready for operation again.
- ▶ Contact malfunctions: If the contacts have welded, reactivation will not be possible after the input circuit has opened.
- ▶ LED "POWER" does not light: Short circuit or no supply voltage.

**Dimensions in mm**

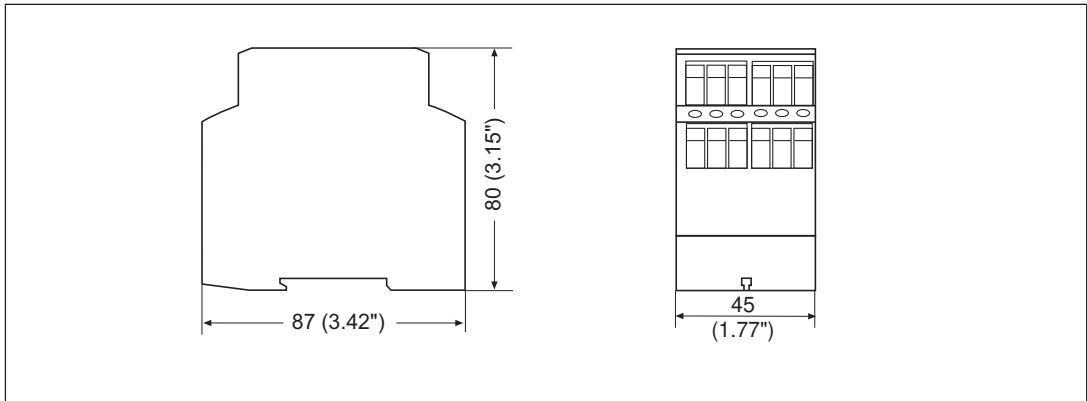

## Technical details

<b>General</b>	
Certifications	CCC, CE, EAC (Eurasian), TÜV, cULus Listed
<b>Electrical data</b>	
Supply voltage	
Voltage	<b>24 V</b>
Kind	<b>AC/DC</b>
Voltage tolerance	<b>-15 %/+10 %</b>
Output of external power supply (AC)	<b>4,5 VA</b>
Output of external power supply (DC)	<b>2 W</b>
Frequency range AC	<b>50 - 60 Hz</b>
Residual ripple DC	<b>160 %</b>
Duty cycle	<b>100 %</b>
Max. inrush current impulse	
Current pulse, A1	<b>1,7 A</b>
Pulse duration, A1	<b>1,5 ms</b>
<b>Inputs</b>	
Number	<b>2</b>
Voltage at	
Input circuit DC	<b>24 V</b>
Start circuit DC	<b>24 V</b>
Feedback loop DC	<b>24 V</b>
Current at	
Input circuit DC	<b>25 mA</b>
Start circuit DC	<b>30 mA</b>
Feedback loop DC	<b>30 mA</b>
Min. input resistance at power-on	<b>467 Ohm</b>
Max. overall cable resistance R <sub>lmax</sub>	
Single-channel at UB DC	<b>50 Ohm</b>
Single-channel at UB AC	<b>150 Ohm</b>
Dual-channel with detection of shorts across contacts at UB DC	<b>15 Ohm</b>
Dual-channel with detection of shorts across contacts at UB AC	<b>30 Ohm</b>
<b>Relay outputs</b>	
Number of output contacts	
Safety contacts (N/O), instantaneous	<b>2</b>
Max. short circuit current I <sub>K</sub>	<b>1 kA</b>
Utilisation category	
In accordance with the standard	<b>EN 60947-4-1</b>

**Relay outputs**

## Utilisation category of safety contacts

AC1 at	<b>240 V</b>
Min. current	<b>0,01 A</b>
Max. current	<b>8 A</b>
Max. power	<b>2000 VA</b>
DC1 at	<b>24 V</b>
Min. current	<b>0,01 A</b>
Max. current	<b>8 A</b>
Max. power	<b>200 W</b>

## Utilisation category

In accordance with the standard	<b>EN 60947-5-1</b>
---------------------------------	---------------------

## Utilisation category of safety contacts

AC15 at	<b>230 V</b>
Max. current	<b>5 A</b>
DC13 (6 cycles/min) at	<b>24 V</b>
Max. current	<b>7 A</b>

## Utilisation category in accordance with UL

Voltage	<b>240 V AC G. P.</b>
With current	<b>8 A</b>
Pilot Duty	<b>C300, R300</b>

## External contact fuse protection, safety contacts

In accordance with the standard	<b>EN 60947-5-1</b>
Max. melting integral	<b>240 A<sup>2</sup>s</b>
Blow-out fuse, quick	<b>10 A</b>
Blow-out fuse, slow	<b>6 A</b>
Blow-out fuse, gG	<b>10 A</b>
Circuit breaker 24V AC/DC, characteristic B/C	<b>6 A</b>

## Conventional thermal current

**8 A**

## Contact material

**AgSnO<sub>2</sub> + 0,2 µm Au****Times**

## Switch-on delay

With monitored start typ.	<b>35 ms</b>
With monitored start max.	<b>50 ms</b>

## Delay-on de-energisation

With E-STOP typ.	<b>15 ms</b>
With E-STOP max.	<b>30 ms</b>
With power failure typ.	<b>70 ms</b>
With power failure max.	<b>110 ms</b>

## Recovery time at max. switching frequency 1/s

After E-STOP	<b>50 ms</b>
After power failure	<b>150 ms</b>

## Waiting period with a monitored start

**180 ms**

## Min. start pulse duration with a monitored start

**30 ms**

## Supply interruption before de-energisation

**20 ms**

## Simultaneity, channel 1 and 2 max.

**∞**

<b>Environmental data</b>	
Climatic suitability	<b>EN 60068-2-78</b>
Ambient temperature	
Temperature range	<b>-10 - 55 °C</b>
Storage temperature	
Temperature range	<b>-40 - 85 °C</b>
Climatic suitability	
Humidity	<b>93 % r. h. at 40 °C</b>
Condensation during operation	<b>Not permitted</b>
EMC	<b>EN 60947-5-1, EN 61000-6-2, EN 61326-3-1</b>
Vibration	
In accordance with the standard	<b>EN 60068-2-6</b>
Frequency	<b>10 - 55 Hz</b>
Amplitude	<b>0,35 mm</b>
Airgap creepage	
In accordance with the standard	<b>EN 60947-1</b>
Overvoltage category	<b>III / II</b>
Pollution degree	<b>2</b>
Rated insulation voltage	<b>250 V</b>
Rated impulse withstand voltage	<b>4 kV</b>
Protection type	
Housing	<b>IP40</b>
Terminals	<b>IP20</b>
Mounting area (e.g. control cabinet)	<b>IP54</b>
<b>Mechanical data</b>	
Mounting position	<b>Any</b>
Mechanical life	<b>10,000,000 cycles</b>
Material	
Bottom	<b>PPO UL 94 V0</b>
Front	<b>ABS UL 94 V0</b>
Top	<b>PPO UL 94 V0</b>
Connection type	<b>Screw terminal</b>
Mounting type	<b>Fixed</b>
Conductor cross section with screw terminals	
1 core flexible	<b>0,2 - 4 mm<sup>2</sup>, 24 - 10 AWG</b>
2 core with the same cross section, flexible with crimp connectors, no plastic sleeve	<b>0,2 - 2,5 mm<sup>2</sup>, 24 - 14 AWG</b>
2 core with the same cross section, flexible without crimp connectors or with TWIN crimp connectors	<b>0,2 - 2,5 mm<sup>2</sup>, 24 - 14 AWG</b>
Torque setting with screw terminals	<b>0,6 Nm</b>
Stripping length with screw terminals	<b>8 mm</b>
Dimensions	
Height	<b>87 mm</b>
Width	<b>45 mm</b>
Depth	<b>80 mm</b>
Weight	<b>190 g</b>



Where standards are undated, the 2020-07 latest editions shall apply.

**Safety characteristic data**



**NOTICE**

You must comply with the safety characteristic data in order to achieve the required safety level for your plant/machine.

Operating mode	EN ISO 13849-1: 2015	EN ISO 13849-1: 2015	EN 62061 SIL CL	EN 62061 PFH <sub>D</sub> [1/h]	IEC 61511 SIL	IEC 61511 PFD	EN ISO 13849-1: 2015 T <sub>M</sub> [year]
	PL	Category					
–	PL e	Cat. 4	SIL CL 3	2,31E-09	SIL 3	2,03E-06	20

Explanatory notes for the safety-related characteristic data:

- ▶ The SIL CL value in accordance with EN 62061 corresponds to the SIL value in accordance with EN 61508.
- ▶ T<sub>M</sub> is the maximum mission time in accordance with EN ISO 13849-1. The value also applies as the retest interval in accordance with EN 61508-6 and IEC 61511 and as the proof test interval and mission time in accordance with EN 62061.

All the units used within a safety function must be considered when calculating the safety characteristic data.



**INFORMATION**

A safety function's SIL/PL values are **not** identical to the SIL/PL values of the units that are used and may be different. We recommend that you use the PAScal software tool to calculate the safety function's SIL/PL values.

**Supplementary data**



**CAUTION!**

It is essential to consider the relay's service life graphs. The relay outputs' safety-related characteristic data is only valid if the values in the service life graphs are met.

The PFH value depends on the switch frequency and the load of the relay output. If the service life graphs are not accessible, the stated PFH value can be used irrespective of the switch frequency and the load, as the PFH value already considers the relay's B10d value as well as the failure rates of the other components.

### Service life graph

The service life graphs indicate the number of cycles from which failures due to wear must be expected. The wear is mainly caused by the electrical load; the mechanical load is negligible.

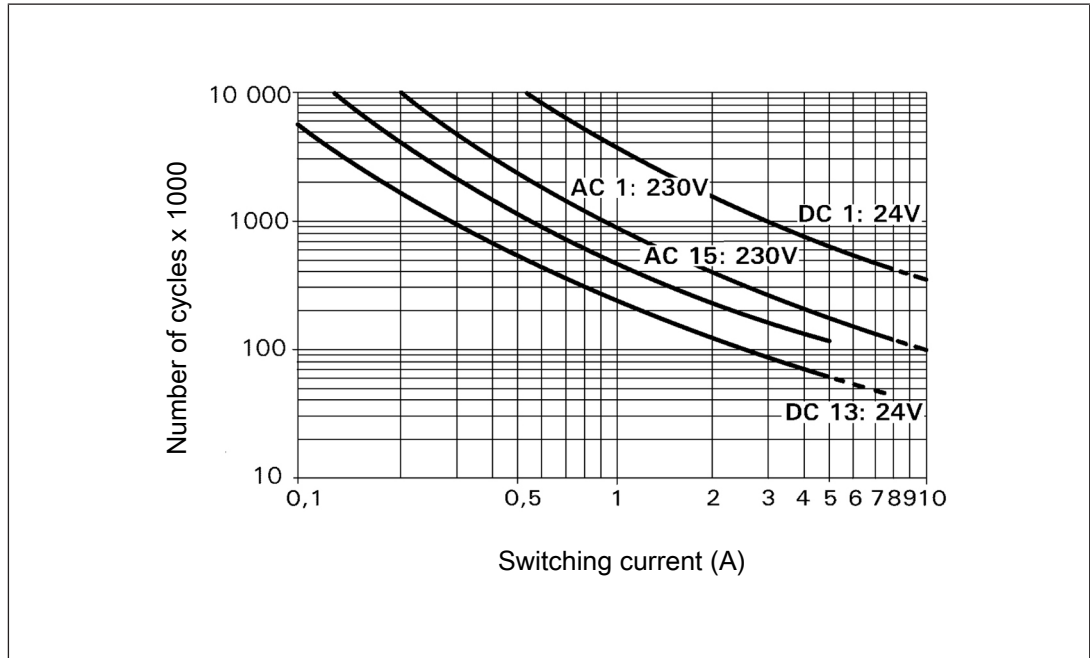

### Example

- ▶ Inductive load: 0.2 A
- ▶ Utilisation category: AC15
- ▶ Contact service life: 4 000 000 cycles

Provided the application to be implemented requires fewer than 4 000 000 cycles, the PFH value (see Technical details) can be used in the calculation.

To increase the service life, sufficient spark suppression must be provided on all output contacts. With capacitive loads, any power surges that occur must be noted. With DC contactors, use flywheel diodes for spark suppression.

### Order reference

Product type	Features	Connection type	Order no.
PNOZ X2C	24 VAC/DC	Screw terminals	774304

### EC declaration of conformity

This product/these products meet the requirements of the directive 2006/42/EC for machinery of the European Parliament and of the Council. The complete EC Declaration of Conformity is available on the Internet at [www.pilz.com/support/downloads](http://www.pilz.com/support/downloads).

Representative: Norbert Fröhlich, Pilz GmbH & Co. KG, Felix-Wankel-Str. 2, 73760 Ostfildern, Germany

# ► Support

Technical support is available from Pilz round the clock.

## Americas

**Brazil**  
+55 11 97569-2804

**Canada**  
+1 888 315 7459

**Mexico**  
+52 55 5572 1300

**USA (toll-free)**  
+1 877-PILZUSA (745-9872)

## Asia

**China**  
+86 21 60880878-216

**Japan**  
+81 45 471-2281

**South Korea**  
+82 31 778 3300

## Australia

+61 3 95600621

## Europe

**Austria**  
+43 1 7986263-0

**Belgium, Luxembourg**  
+32 9 3217570

**France**  
+33 3 88104003

**Germany**  
+49 711 3409-444

**Ireland**  
+353 21 4804983

**Italy, Malta**  
+39 0362 1826711

## Scandinavia

+45 74436332

## Spain

+34 938497433

## Switzerland

+41 62 88979-32

## The Netherlands

+31 347 320477

## Turkey

+90 216 5775552

## United Kingdom

+44 1536 462203

## You can reach our international hotline on:

+49 711 3409-444  
support@pilz.com

Pilz develops environmentally-friendly products using ecological materials and energy-saving technologies. Offices and production facilities are ecologically designed, environmentally-aware and energy-saving. So Pilz offers sustainability, plus the security of using energy-efficient products and environmentally-friendly solutions.

*Energy*  
saving by Pilz



We are represented internationally. Please refer to our homepage [www.pilz.com](http://www.pilz.com) for further details or contact our headquarters.

Headquarters: Pilz GmbH & Co. KG, Felix-Wankel-Straße 2, 73760 Ostfildern, Germany  
Telephone: +49 711 3409-0, Telefax: +49 711 3409-133, E-Mail: [info@pilz.com](mailto:info@pilz.com), Internet: [www.pilz.com](http://www.pilz.com)

**PILZ**  
THE SPIRIT OF SAFETY

19918-EN-08, 2020-11 Printed in Germany  
© Pilz GmbH & Co. KG, 2019

CECE®, CHRE®, CMSE®, InduraNET p®, Leansafe®, Master of Safety®, Master of Security®, PAS4000®, PAScall®, PASconfig®, Pilz®, PTT®, PLID®, PMCPirimo®, PMCPiritego®, PMCTendo®, PMD®, PMJ®, PNOZ®, PRBT®, PRCM®, PRCM®, PSEN®, PSEN®, PSENET p®, SafetyBUS p®, SafetyEYE®, SafetyNET p®, THE SPIRIT OF SAFETY® are registered and protected trademarks of Pilz GmbH & Co. KG in some countries. We would point out that product features may vary from the details stated in this document, depending on the status at the time of publication and the scope of the equipment. We accept no responsibility for the validity, accuracy and entirety of the text and graphics presented in this information. Please contact our Technical Support if you have any questions.