



Visualisation; Diagnostics

Easy to Configure

Programming IEC 61131-3

Rapid Installation

PNOZ X9P

PILZ

THE SPIRIT OF SAFETY

► Safety relays

This document is the original document.

All rights to this documentation are reserved by Pilz GmbH & Co. KG. Copies may be made for the user's internal purposes. Suggestions and comments for improving this documentation will be gratefully received.

Source code from third-party manufacturers or open source software has been used for some components. The relevant licence information is available on the Internet on the Pilz homepage.

Pilz®, PIT®, PMI®, PNOZ®, Primo®, PSEN®, PSS®, PVIS®, SafetyBUS p®, SafetyEYE®, SafetyNET p®, the spirit of safety® are registered and protected trademarks of Pilz GmbH & Co. KG in some countries.



SD means Secure Digital

Introduction	5
Validity of documentation	5
Using the documentation	5
Definition of symbols	5
Safety	6
Intended use	6
Safety regulations	6
Safety assessment	6
Use of qualified personnel	7
Warranty and liability	7
Disposal	7
For your safety	7
Unit features	8
Safety features	8
Block diagram/terminal configuration	9
Types: DC	9
Type: AC/DC	9
Function Description	10
Operating modes	10
Timing diagram	11
Installation	11
Wiring	12
Preparing for operation	13
Operation	16
Status indicators	16
Faults – Interference	17
Dimensions in mm	17
Technical details Order no. 777606, 787606	18
Technical details Order no. 777607, 777609, 787609	23
Safety characteristic data	29
Supplementary data	30
Service life graph	31

Remove plug-in terminals	32
Order reference	32
EC declaration of conformity	32

Introduction

Validity of documentation

This documentation is valid for the product PNOZ X9P. It is valid until new documentation is published.

This operating manual explains the function and operation, describes the installation and provides guidelines on how to connect the product.

Using the documentation

This document is intended for instruction. Only install and commission the product if you have read and understood this document. The document should be retained for future reference.

Definition of symbols

Information that is particularly important is identified as follows:



DANGER!

This warning must be heeded! It warns of a hazardous situation that poses an immediate threat of serious injury and death and indicates preventive measures that can be taken.



WARNING!

This warning must be heeded! It warns of a hazardous situation that could lead to serious injury and death and indicates preventive measures that can be taken.



CAUTION!

This refers to a hazard that can lead to a less serious or minor injury plus material damage, and also provides information on preventive measures that can be taken.



NOTICE

This describes a situation in which the product or devices could be damaged and also provides information on preventive measures that can be taken. It also highlights areas within the text that are of particular importance.

**INFORMATION**

This gives advice on applications and provides information on special features.

Safety**Intended use**

The safety relay PNOZ X9P provides a safety-related interruption of a safety circuit.

The safety relay meets the requirements of EN 60947-5-1 and EN 60204-1 and may be used in applications with:

- ▶ E-STOP pushbuttons
- ▶ Safety gates
- ▶ Light grids and safety switches with detection of shorts across contacts

The following is deemed improper use in particular

- ▶ Any component, technical or electrical modification to the product,
- ▶ Use of the product outside the areas described in this manual,
- ▶ Use of the product outside the technical details (see [Technical details](#)  18]).

**NOTICE****EMC-compliant electrical installation**

The product is designed for use in an industrial environment. The product may cause interference if installed in other environments. If installed in other environments, measures should be taken to comply with the applicable standards and directives for the respective installation site with regard to interference.

Safety regulations**Safety assessment**

Before using a device, a safety assessment in accordance with the Machinery Directive is required.

The product as an individual component fulfils the functional safety requirements in accordance with EN ISO 13849 and EN 62061. However, this does not guarantee the functional safety of the overall plant/machine. To achieve the relevant safety level of the overall plant/machine's required safety functions, each safety function needs to be considered separately.

Use of qualified personnel

The products may only be assembled, installed, programmed, commissioned, operated, maintained and decommissioned by persons who are competent to do so.

A competent person is a qualified and knowledgeable person who, because of their training, experience and current professional activity, has the specialist knowledge required. To be able to inspect, assess and operate devices, systems and machines, the person has to be informed of the state of the art and the applicable national, European and international laws, directives and standards.

It is the company's responsibility only to employ personnel who

- ▶ Are familiar with the basic regulations concerning health and safety / accident prevention,
- ▶ Have read and understood the information provided in the section entitled Safety
- ▶ Have a good knowledge of the generic and specialist standards applicable to the specific application.

Warranty and liability

All claims to warranty and liability will be rendered invalid if

- ▶ The product was used contrary to the purpose for which it is intended,
- ▶ Damage can be attributed to not having followed the guidelines in the manual,
- ▶ Operating personnel are not suitably qualified,
- ▶ Any type of modification has been made (e.g. exchanging components on the PCB boards, soldering work etc.).

Disposal

- ▶ In safety-related applications, please comply with the mission time T_M in the safety-related characteristic data.
- ▶ When decommissioning, please comply with local regulations regarding the disposal of electronic devices (e.g. Electrical and Electronic Equipment Act).

For your safety

The unit meets all the necessary conditions for safe operation. However, please note the following:

- ▶ Note for overvoltage category III: If voltages higher than low voltage (>50 VAC or >120 VDC) are present on the unit, connected control elements and sensors must have a rated insulation voltage of at least 250 V.

Unit features

- ▶ Positive-guided relay outputs:
 - 7 safety contacts (N/O), instantaneous
 - 2 auxiliary contacts (N/C), instantaneous
- ▶ 2 semiconductor outputs
- ▶ Connection options for:
 - E-STOP pushbuttons
 - Safety gate limit switches
 - Start buttons
 - Light grids and safety switches with detection of shorts across contacts
- ▶ LED indicator for:
 - Supply voltage
 - Input state
 - Switch state of the safety contacts
 - Start circuit
- ▶ Semiconductor outputs signal:
 - Supply voltage is present
 - Switch status of the safety contacts
- ▶ Plug-in connection terminals (either spring-loaded terminal or screw terminal)
- ▶ See order reference for unit types

Safety features

The safety relay meets the following safety requirements:

- ▶ The circuit is redundant with built-in self-monitoring.
- ▶ The safety function remains effective in the case of a component failure.
- ▶ The correct opening and closing of the safety function relays is tested automatically in each on-off cycle.

Block diagram/terminal configuration

Types: DC

- ▶ U_B : 12 VDC; Order no. 777607
- ▶ U_B : 24 VDC; Order no. 777609, 787609

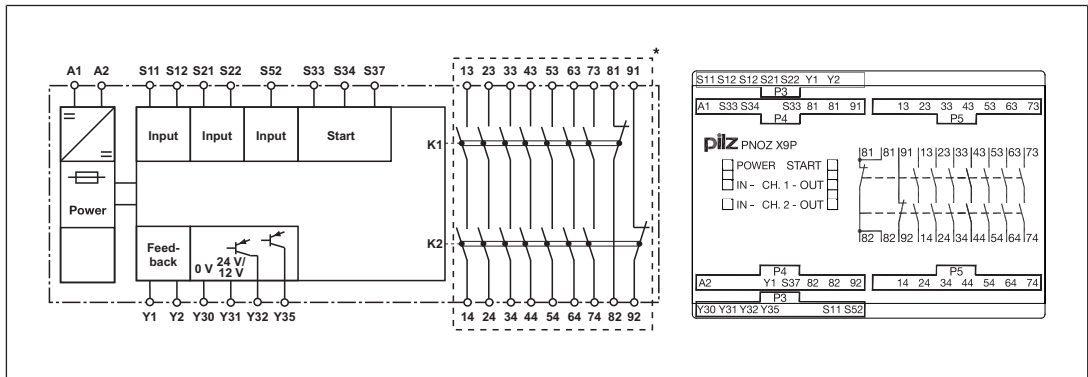

*Insulation between the non-marked area and the relay contacts: Basic insulation (over-voltage category III), Protective separation (overvoltage category II)

Type: AC/DC

- ▶ U_B : 24-240 V AC/DC, 24 V DC; Order no. 777606, 787606

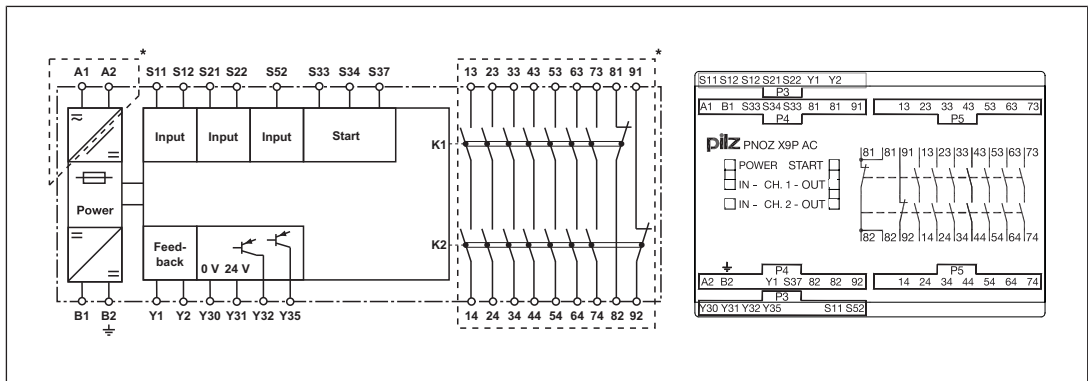

*Insulation between the non-marked area and the relay contacts: Basic insulation (over-voltage category III), Protective separation (overvoltage category II)

Function Description

The safety relay PNOZ X9P provides a safety-oriented interruption of a safety circuit. When supply voltage is supplied the "POWER" LED is lit. The unit is ready for operation when the feedback loop Y1-Y2 and the start circuit S33-S34 are closed. The "START" LED is lit.

- ▶ Input circuit is closed (e.g. E-STOP pushbutton not operated):
 - The LEDs "CH.1 IN" and "CH.2 IN" are lit.
 - Safety contacts 13-14, 23-24, 33-34, 43-44, 53-54, 63-64 and 73-74 are closed, the auxiliary contacts 81-82 and 91-92 are opened. The unit is active.
 - A high signal is present at the semiconductor output switch state Y32.
 - The LEDs "CH.1 OUT" and "CH.2 OUT" are lit. The "START" LED goes out.
- ▶ Input circuit is opened (e.g. E-STOP pushbutton operated):
 - The LEDs "CH.1 IN" and "CH.2 IN" go out.
 - Safety contacts 13-14, 23-24, 33-34, 43-44, 53-54, 63-64 and 73-74 are opened redundantly, the auxiliary contacts 81-82 and 91-92 are closed.
 - A low signal is present at the semiconductor output switch state Y32.
 - The LEDs "CH.1 OUT" and "CH.2 OUT" go out.
- ▶ A high signal is present at semi-conductor output Y35 if the supply voltage is present and the internal fuse has not blown.

Operating modes

- ▶ Single-channel operation: No redundancy in the input circuit, earth faults in the start and input circuit are detected.
- ▶ Dual-channel operation without detection of shorts across contacts: Redundant input circuit, detects PNOZ X9P
 - earth faults in the start and input circuit,
 - short circuits in the input circuit.
- ▶ Dual-channel operation with detection of shorts across contacts: Redundant input circuit, PNOZ X9P detects
 - earth faults in the start and input circuit,
 - short circuits in the input circuit,
 - shorts across contacts in the input circuit.
- ▶ Automatic start: Unit is active once the input circuit has been closed.
- ▶ Manual start: Unit is active once the input circuit and the start circuit are closed.
- ▶ Monitored start: Unit is active once
 - the input circuit is closed and then the start circuit is closed and opened again.
 - the start circuit is closed and then opened again once the input circuit is closed.
- ▶ Increase in the number of available contacts by connecting contact expansion modules or external contactors/relays.

Timing diagram

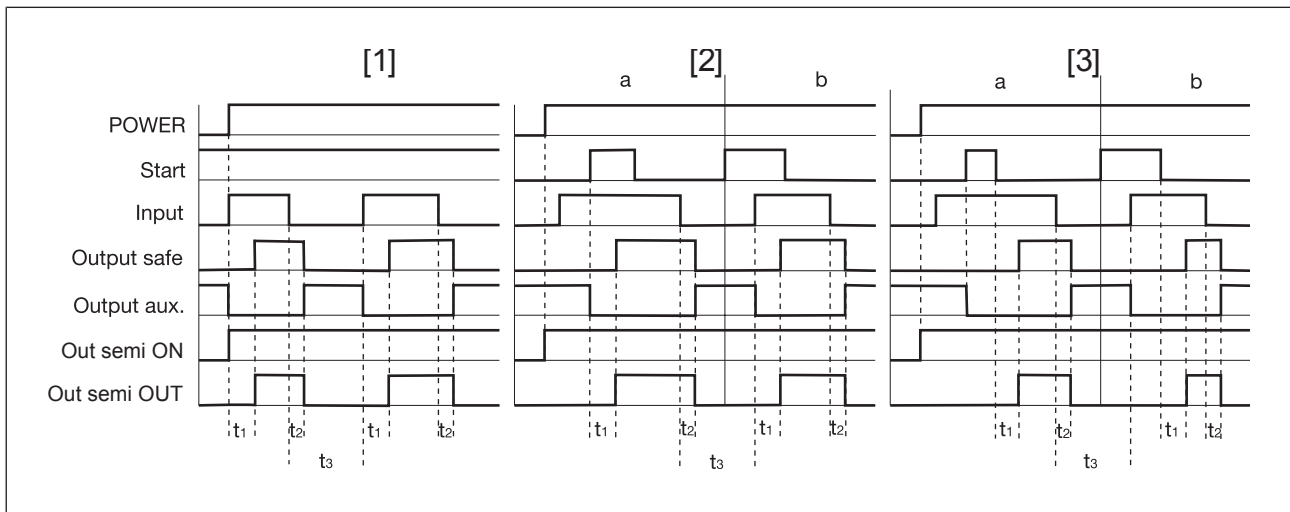

Legend

- ▶ Power: Supply voltage
- ▶ Start: Start circuit
- ▶ Input: Input circuit
- ▶ Output safe: Safety contacts
- ▶ Output aux.: Auxiliary contacts
- ▶ Out semi ON: Semiconductor output supply voltage
- ▶ Out semi OUT: Semiconductor output switch state
- ▶ [1]: Automatic start
- ▶ [2]: Manual start
- ▶ [3]: Monitored start
- ▶ a: Input circuit closes before start circuit
- ▶ b: Start circuit closes before input circuit
- ▶ t_1 : Switch-on delay
- ▶ t_2 : Delay-on de-energisation
- ▶ t_3 : Recovery time

Installation

- ▶ The unit should be installed in a control cabinet with a protection type of at least IP54.
- ▶ Use the notch on the rear of the unit to attach it to a DIN rail (35 mm).
- ▶ When installed vertically: Secure the unit by using a fixing element (e.g. retaining bracket or end angle).

Wiring

Please note:

- ▶ Information given in the "[Technical details \[18\]](#)" must be followed.
- ▶ Delivery status of units with screw terminals: Link between Y1-Y2 (feedback loop)
- ▶ Outputs 13-14, 23-24, 33-34, 43-44, 53-54, 63-64, 73-74 are safety contacts, the outputs 81-82, 91-92 are auxiliary contacts (e.g. for display).
- ▶ Do **not** use auxiliary contacts 81-82, 91-92 and semiconductor outputs Y32, Y35 for safety circuits!
- ▶ Do not connect undesignated terminals.
- ▶ To prevent contact welding, a fuse should be connected before the output contacts (see [Technical details \[18\]](#)).
- ▶ Calculation of the max. cable length l_{\max} in the input circuit:

$$l_{\max} = \frac{R_{l_{\max}}}{R_l / \text{km}}$$

$R_{l_{\max}}$ = max. overall cable resistance (see [Technical details \[18\]](#))

R_l / km = cable resistance/km

- ▶ Use copper wiring with a temperature stability of 60/75 °C.
- ▶ To prevent EMC interferences (particularly common-mode interferences) the measures described in EN 60204-1 must be executed. This includes the separate routing of cables of the control circuits (input, start and feedback loop) from other cables for energy transmission or the shielding of cables, for example.
- ▶ Adequate protection must be provided on all output contacts with capacitive and inductive loads.
- ▶ Do not switch low currents using contacts that have been used previously with high currents.
- ▶ When connecting magnetically operated, reed proximity switches, ensure that the max. peak inrush current (on the input circuit) does not overload the proximity switch.
- ▶ 777607, 777609, 787609 units or 777606, 787606 units, when the supply voltage is connected via B1 and B2:
The power supply must meet the regulations for extra low voltages with protective electrical separation (SELV, PELV).

Important for detection of shorts across contacts:

As this function for detecting shorts across contacts is not failsafe, it is tested by Pilz during the final control check. If there is a danger of exceeding the cable runs, we recommend the following test after the installation of the device:

1. Unit ready for operation (output contacts closed)
2. Short circuit the test terminals S12, S22 for detecting shorts across the inputs.
3. The unit's fuse must be triggered and the output contacts must open. Cable lengths in the scale of the maximum length can delay the fuse triggering for up to 2 minutes.
4. Reset the fuse: remove the short circuit and switch off the supply voltage for approx. 1 minute.

Preparing for operation

Supply voltage	AC	DC
▶ Order no. 777606, 787606 U_B : 24-240 V AC/DC via A1 and A2		
▶ Order no. 777606, 787606 U_B : 24 V DC via B1 and B2		
Supply voltage	AC	DC
▶ Order no. 777607 U_B : 12 V DC ▶ Order no. 777609, 787609 U_B : 24 VDC		
Input circuit	Single-channel	Dual-channel
E-STOP without detection of shorts across contacts		
E-STOP with detection of shorts across contacts		
Safety gate without detection of shorts across contacts		
Safety gate with detection of shorts across contacts		

Input circuit	Single-channel	Dual-channel
Light guard or safety switch, detection of shorts across contacts via ESPE ▶ Order no. 777609, 787609 U _B : 24 VDC		
Light guard or safety switch, detection of shorts across contacts via ESPE ▶ Order no. 777606, 787606 U _B : 24 V DC via B1 and B2		



NOTICE

With single-channel wiring the safety level of your machine/plant may be lower than the safety level of the unit (see [Safety characteristic data \[29\]](#)).



NOTICE

Operation with a light guard or safety switch

It must not be possible to switch off the supply voltage for the PNOZ X9P separately from the supply voltage for the light guard or safety switch.

Start circuit	Single-channel, dual-channel without detection of shorts across contacts	Dual-channel with detection of shorts across contacts
Automatic start		
Automatic start with start-up test (safety gate, dual-channel)	<p>Simultaneity S1 and S2: 150 ms, U_B: 12 V DC: 50 ms</p>	
Manual start		

Start circuit	Single-channel, dual-channel without detection of shorts across contacts	Dual-channel with detection of shorts across contacts
Monitored start		



NOTICE

In the event of an automatic start or manual start with a bridged start contact (fault case)

The unit starts up automatically when the safeguard is reset, e.g. when the E-STOP pushbutton is released. Use external circuit measures to prevent an unexpected restart.

Feedback loop	without feedback loop monitoring	with feedback loop monitoring
Link or contacts from external contactors		
Semiconductor output	U_B : 12 V DC	U_B : 24 V DC; 24-240 V AC/DC
Y31, Y30: External supply voltage		

Legend

- ▶ S1/S2: E-STOP/safety gate switch
- ▶ S3: Reset button
- ▶ : Switch operated
- ▶ : Gate open
- ▶ : Gate closed



INFORMATION

With automatic and manual start, Y1 and S37 must not be linked.

Operation

When the relay outputs are switched on, the mechanical contact on the relay cannot be tested automatically. Depending on the operational environment, measures to detect the non-opening of switching elements may be required under some circumstances.

When the product is used in accordance with the European Machinery Directive, a check must be carried out to ensure that the safety contacts on the relay outputs open correctly. Open the safety contacts (switch off output) and start the device again, so that the internal diagnostics can check that the safety contacts open correctly

- ▶ for SIL CL 3/PL e at least 1x per month
- ▶ for SIL CL 2/PL d at least 1x per year



NOTICE

The safety function should be checked after initial commissioning and each time the plant/machine is changed. The safety functions may only be checked by qualified personnel.

Status indicators

LEDs indicate the status and errors during operation:



LED on



POWER

Supply voltage is present.



START

Start circuit is closed.



CH.1 IN

Channel 1 input circuit is closed.



CH.2 IN

Channel 2 input circuit is closed.



CH.1 OUT

Channel 1 safety contacts are closed.



CH.2 OUT

Channel 2 safety contacts are closed.

Faults – Interference

- ▶ Earth fault: The supply voltage fails and the safety contacts open. Once the cause of the respective fault has been rectified and the supply voltage is switched off for approx. 1 minute, the unit is ready for operation again.
- ▶ Contact malfunctions: If the contacts have welded, reactivation will not be possible after the input circuit has opened.
- ▶ LED "POWER" does not light: Short circuit or no supply voltage.

Dimensions in mm

* with spring-loaded terminals

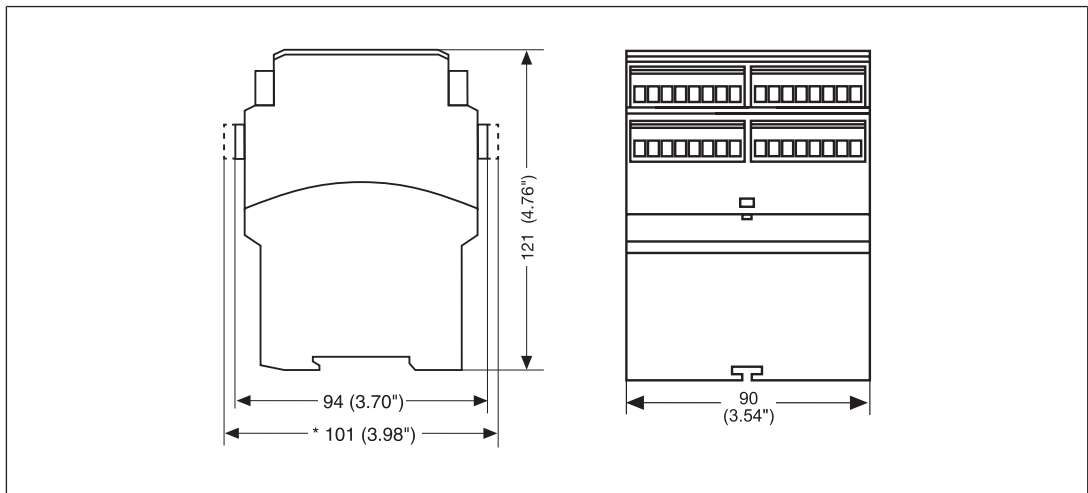

Technical details Order no. 777606, 787606

General	777606	787606
Certifications	CCC, CE, EAC (Eurasian), TÜV, cULus Listed	CCC, CE, EAC (Eurasian), TÜV, cULus Listed
Electrical data	777606	787606
Supply voltage		
Voltage	24 - 240 V	24 - 240 V
Kind	AC/DC	AC/DC
Voltage tolerance	-15 %/+10 %	-15 %/+10 %
Output of external power supply (AC)	8,5 VA	8,5 VA
Output of external power supply (DC)	5,5 W	5,5 W
Frequency range AC	50 - 60 Hz	50 - 60 Hz
Supply voltage		
Voltage	24 V	24 V
Kind	DC	DC
Voltage tolerance	-15 %/+10 %	-15 %/+10 %
Output of external power supply (DC)	5,5 W	5,5 W
Residual ripple DC	160 %	160 %
Duty cycle	100 %	100 %
Inputs	777606	787606
Number	2	2
Voltage at		
Input circuit DC	24 V	24 V
Start circuit DC	24 V	24 V
Feedback loop DC	24 V	24 V
Current at		
Input circuit DC	50 mA	50 mA
Start circuit DC	100 mA	100 mA
Feedback loop DC	100 mA	100 mA
Min. input resistance at power-on	89 Ohm	89 Ohm
Max. overall cable resistance RI-max		
Single-channel at UB DC	45 Ohm	45 Ohm
Single-channel at UB AC	45 Ohm	45 Ohm
Dual-channel without detection of shorts across contacts at UB DC	90 Ohm	90 Ohm
Dual-channel without detection of shorts across contacts at UB AC	90 Ohm	90 Ohm
Dual-channel with detection of shorts across contacts at UB DC	15 Ohm	15 Ohm
Dual-channel with detection of shorts across contacts at UB AC	15 Ohm	15 Ohm

Semiconductor outputs	777606	787606
Number	2	2
Voltage	24 V	24 V
Current	20 mA	20 mA
External supply voltage	24 V	24 V
Voltage tolerance	-20 %/+20 %	-20 %/+20 %
Residual current at "0" signal	0,1 mA	0,1 mA
Max. internal voltage drop	4 V	4 V
Conditional rated short circuit current	100 A	100 A
Lowest operating current	0 mA	0 mA
Utilisation category in accordance with EN 60947-1	DC-12	DC-12
Relay outputs	777606	787606
Number of output contacts		
Safety contacts (N/O), instantaneous	7	7
Auxiliary contacts (N/C)	2	2
Max. short circuit current I _K	1 kA	1 kA
Utilisation category		
In accordance with the standard	EN 60947-4-1	EN 60947-4-1
Utilisation category of safety contacts		
AC1 at	240 V	240 V
Min. current	0,01 A	0,01 A
Max. current	8 A	8 A
Max. power	2000 VA	2000 VA
DC1 at	24 V	24 V
Min. current	0,01 A	0,01 A
Max. current	8 A	8 A
Max. power	200 W	200 W
Utilisation category of auxiliary contacts		
AC1 at	240 V	240 V
Min. current	0,01 A	0,01 A
Max. current	8 A	8 A
Max. power	2000 VA	2000 VA
DC1 at	24 V	24 V
Min. current	0,01 A	0,01 A
Max. current	8 A	8 A
Max. power	200 W	200 W
Utilisation category		
In accordance with the standard	EN 60947-5-1	EN 60947-5-1

Relay outputs	777606	787606
Utilisation category of safety contacts		
AC15 at	230 V	230 V
Max. current	5 A	5 A
DC13 (6 cycles/min) at	24 V	24 V
Max. current	7 A	7 A
Utilisation category of auxiliary contacts		
AC15 at	230 V	230 V
Max. current	5 A	5 A
DC13 (6 cycles/min) at	24 V	24 V
Max. current	7 A	7 A
Utilisation category in accordance with UL		
Voltage	240 V AC G. P.	240 V AC G. P.
With current	8 A	8 A
Voltage	24 V DC Resistive	24 V DC Resistive
With current	5 A	5 A
Pilot Duty	B300, R300	B300, R300
External contact fuse protection, safety contacts		
In accordance with the standard	EN 60947-5-1	EN 60947-5-1
Max. melting integral	240 A²s	240 A²s
Blow-out fuse, quick	10 A	10 A
Blow-out fuse, slow	6 A	6 A
Blow-out fuse, gG	10 A	10 A
Circuit breaker 24V AC/DC, characteristic B/C	6 A	6 A
External contact fuse protection, auxiliary contacts		
Max. melting integral	240 A²s	240 A²s
Blow-out fuse, quick	10 A	10 A
Blow-out fuse, slow	6 A	6 A
Blow-out fuse, gG	10 A	10 A
Circuit breaker 24 V AC/DC, characteristic B/C	6 A	6 A
Contact material	AgSnO₂ + 0,2 µm Au	AgSnO₂ + 0,2 µm Au

Conventional thermal current while loading several contacts	777606	787606
Ith per contact at UB AC; AC1: 240 V, DC1: 24 V		
Conv. therm. current with 1 contact	8 A	8 A
Conv. therm. current with 2 contacts	8 A	8 A
Conv. therm. current with 3 contacts	8 A	8 A
Conv. therm. current with 4 contacts	7 A	7 A
Conv. therm. current with 5 contacts	6 A	6 A
Conv. therm. current with 6 contacts	5,5 A	5,5 A
Conv. therm. current with 7 contacts	5 A	5 A
Ith per contact at UB DC; AC1: 240 V, DC1: 24 V		
Conv. therm. current with 1 contact	8 A	8 A
Conv. therm. current with 2 contacts	8 A	8 A
Conv. therm. current with 3 contacts	8 A	8 A
Conv. therm. current with 4 contacts	7 A	7 A
Conv. therm. current with 5 contacts	6 A	6 A
Conv. therm. current with 6 contacts	5,5 A	5,5 A
Conv. therm. current with 7 contacts	5 A	5 A
Times	777606	787606
Switch-on delay		
With automatic start typ.	200 ms	200 ms
With automatic start max.	250 ms	250 ms
With automatic start after power on typ.	500 ms	500 ms
With automatic start after power on max.	650 ms	650 ms
With manual start typ.	200 ms	200 ms
With manual start max.	250 ms	250 ms
With monitored start typ.	150 ms	150 ms
With monitored start max.	220 ms	220 ms

Times	777606	787606
Delay-on de-energisation		
With E-STOP typ.	20 ms	20 ms
With 24 V power failure at A1 typ.	230 ms	230 ms
With E-STOP max.	30 ms	30 ms
With power failure at B1 typ.	170 ms	170 ms
With power failure at B1 max.	250 ms	250 ms
With 240 V power failure at A1 max.	550 ms	550 ms
With 240 V power failure at A1 typ.	430 ms	430 ms
With 24 V power failure at A1 max.	300 ms	300 ms
Recovery time at max. switching frequency 1/s		
After E-STOP	50 ms	50 ms
After power failure at A1	600 ms	600 ms
Min. start pulse duration with a monitored start		
	50 ms	50 ms
Supply interruption before de-energisation		
	20 ms	20 ms
Environmental data		
	777606	787606
Climatic suitability		
	EN 60068-2-78	EN 60068-2-78
Ambient temperature		
Temperature range	-10 - 55 °C	-10 - 55 °C
Storage temperature		
Temperature range	-40 - 85 °C	-40 - 85 °C
Climatic suitability		
Humidity	93 % r. h. at 40 °C	93 % r. h. at 40 °C
Condensation during operation		
	Not permitted	Not permitted
EMC		
	EN 60947-5-1, EN 61000-6-2, EN 61326-3-1	EN 60947-5-1, EN 61000-6-2, EN 61326-3-1
Vibration		
In accordance with the standard	EN 60068-2-6	EN 60068-2-6
Frequency	10 - 55 Hz	10 - 55 Hz
Amplitude	0,35 mm	0,35 mm
Airgap creepage		
In accordance with the standard	EN 60947-1	EN 60947-1
Overvoltage category	III / II	III / II
Pollution degree	2	2
Rated insulation voltage		
	250 V	250 V
Rated impulse withstand voltage		
	4 kV	4 kV
Protection type		
Housing	IP40	IP40
Terminals	IP20	IP20
Mounting area (e.g. control cabinet)	IP54	IP54

Mechanical data	777606	787606
Mounting position	Any	Any
Mechanical life	10,000,000 cycles	10,000,000 cycles
Material		
Bottom	PPO UL 94 V0	PPO UL 94 V0
Front	ABS UL 94 V0	ABS UL 94 V0
Top	PPO UL 94 V0	PPO UL 94 V0
Connection type	Screw terminal	Spring-loaded terminal
Mounting type	plug-in	plug-in
Conductor cross section with screw terminals		
1 core flexible	0,25 - 2,5 mm², 24 - 12 AWG	–
2 core with the same cross section, flexible with crimp connectors, no plastic sleeve	0,25 - 1 mm², 24 - 16 AWG	–
2 core with the same cross section, flexible without crimp connectors or with TWIN crimp connectors	0,2 - 1,5 mm², 24 - 16 AWG	–
Torque setting with screw terminals	0,5 Nm	–
Stripping length with screw terminals	8 mm	–
Conductor cross section with spring-loaded terminals: Flexible with/without crimp connector	–	0,2 - 1,5 mm², 24 - 16 AWG
Spring-loaded terminals: Terminal points per connection	–	2
Stripping length with spring-loaded terminals	–	8 mm
Dimensions		
Height	94 mm	101 mm
Width	90 mm	90 mm
Depth	121 mm	121 mm
Weight	600 g	600 g

Where standards are undated, the 2020-07 latest editions shall apply.

Technical details Order no. 777607, 777609, 787609

General	777607	777609	787609
Certifications	CCC, CE, EAC (Eurasian), TÜV, cULus Listed	CCC, CE, EAC (Eurasian), TÜV, cULus Listed	CCC, CE, EAC (Eurasian), TÜV, cULus Listed

Electrical data	777607	777609	787609
Supply voltage			
Voltage	12 V	24 V	24 V
Kind	DC	DC	DC
Voltage tolerance	-20 %/+20 %	-15 %/+10 %	-15 %/+10 %
Output of external power supply (DC)	7 W	5,5 W	5,5 W
Residual ripple DC	160 %	160 %	160 %
Duty cycle	100 %	100 %	100 %
Max. inrush current impulse			
Current pulse, A1	5,5 A	10 A	10 A
Pulse duration, A1	1 ms	1 ms	1 ms
Inputs	777607	777609	787609
Number	2	2	2
Voltage at			
Input circuit DC	12 V	24 V	24 V
Start circuit DC	12 V	24 V	24 V
Feedback loop DC	12 V	24 V	24 V
Current at			
Input circuit DC	130 mA	50 mA	50 mA
Start circuit DC	200 mA	100 mA	100 mA
Feedback loop DC	200 mA	100 mA	100 mA
Min. input resistance at power-on	9 Ohm	89 Ohm	89 Ohm
Max. overall cable resistance R _{lmax}			
Single-channel at UB DC	8 Ohm	45 Ohm	45 Ohm
Dual-channel without detection of shorts across contacts at UB DC	15 Ohm	90 Ohm	90 Ohm
Dual-channel with detection of shorts across contacts at UB DC	8 Ohm	15 Ohm	15 Ohm
Semiconductor outputs	777607	777609	787609
Number	2	2	2
Voltage	12 V	24 V	24 V
Current	20 mA	20 mA	20 mA
External supply voltage	12 V	24 V	24 V
Voltage tolerance	-20 %/+20 %	-20 %/+20 %	-20 %/+20 %
Residual current at "0" signal	0,1 mA	0,1 mA	0,1 mA
Max. internal voltage drop	4 V	4 V	4 V
Conditional rated short circuit current	100 A	100 A	100 A
Lowest operating current	0 mA	0 mA	0 mA

Semiconductor outputs	777607	777609	787609
Utilisation category in accordance with EN 60947-1			
	DC-12	DC-12	DC-12
Relay outputs	777607	777609	787609
Number of output contacts			
Safety contacts (N/O), instantaneous	7	7	7
Auxiliary contacts (N/C)	2	2	2
Max. short circuit current IK	1 kA	1 kA	1 kA
Utilisation category			
In accordance with the standard	EN 60947-4-1	EN 60947-4-1	EN 60947-4-1
Utilisation category of safety contacts			
AC1 at	240 V	240 V	240 V
Min. current	0,01 A	0,01 A	0,01 A
Max. current	8 A	8 A	8 A
Max. power	2000 VA	2000 VA	2000 VA
DC1 at	24 V	24 V	24 V
Min. current	0,01 A	0,01 A	0,01 A
Max. current	8 A	8 A	8 A
Max. power	200 W	200 W	200 W
Utilisation category of auxiliary contacts			
AC1 at	240 V	240 V	240 V
Min. current	0,01 A	0,01 A	0,01 A
Max. current	8 A	8 A	8 A
Max. power	2000 VA	2000 VA	2000 VA
DC1 at	24 V	24 V	24 V
Min. current	0,01 A	0,01 A	0,01 A
Max. current	8 A	8 A	8 A
Max. power	200 W	200 W	200 W
Utilisation category			
In accordance with the standard	EN 60947-5-1	EN 60947-5-1	EN 60947-5-1
Utilisation category of safety contacts			
AC15 at	230 V	230 V	230 V
Max. current	5 A	5 A	5 A
DC13 (6 cycles/min) at	24 V	24 V	24 V
Max. current	7 A	7 A	7 A

Relay outputs	777607	777609	787609
Utilisation category of auxiliary contacts			
AC15 at	230 V	230 V	230 V
Max. current	5 A	5 A	5 A
DC13 (6 cycles/min) at	24 V	24 V	24 V
Max. current	7 A	7 A	7 A
Utilisation category in accordance with UL			
Voltage	240 V AC G. P.	240 V AC G. P.	240 V AC G. P.
With current	8 A	8 A	8 A
Voltage	24 V DC Resistive	24 V DC Resistive	24 V DC Resistive
With current	5 A	5 A	5 A
Pilot Duty	B300, R300	B300, R300	B300, R300
External contact fuse protection, safety contacts			
In accordance with the standard	EN 60947-5-1	EN 60947-5-1	EN 60947-5-1
Max. melting integral	240 A²s	240 A²s	240 A²s
Blow-out fuse, quick	10 A	10 A	10 A
Blow-out fuse, slow	6 A	6 A	6 A
Blow-out fuse, gG	10 A	10 A	10 A
Circuit breaker 24V AC/DC, characteristic B/C	6 A	6 A	6 A
External contact fuse protection, auxiliary contacts			
Max. melting integral	240 A²s	240 A²s	240 A²s
Blow-out fuse, quick	10 A	10 A	10 A
Blow-out fuse, slow	6 A	6 A	6 A
Blow-out fuse, gG	10 A	10 A	10 A
Circuit breaker 24 V AC/DC, characteristic B/C	6 A	6 A	6 A
Contact material	AgSnO₂ + 0,2 µm Au	AgSnO₂ + 0,2 µm Au	AgSnO₂ + 0,2 µm Au

Conventional thermal current while loading several contacts	777607	777609	787609
Ith per contact at UB DC; AC1: 240 V, DC1: 24 V			
Conv. therm. current with 1 contact	8 A	8 A	8 A
Conv. therm. current with 2 contacts	8 A	8 A	8 A
Conv. therm. current with 3 contacts	8 A	8 A	8 A
Conv. therm. current with 4 contacts	7 A	7 A	7 A
Conv. therm. current with 5 contacts	6 A	6 A	6 A
Conv. therm. current with 6 contacts	5,5 A	5,5 A	5,5 A
Conv. therm. current with 7 contacts	5 A	5 A	5 A
Times	777607	777609	787609
Switch-on delay			
With automatic start typ.	130 ms	200 ms	200 ms
With automatic start max.	200 ms	250 ms	250 ms
With automatic start after power on typ.	150 ms	220 ms	220 ms
With automatic start after power on max.	220 ms	300 ms	300 ms
With manual start typ.	150 ms	200 ms	200 ms
With manual start max.	200 ms	250 ms	250 ms
With monitored start typ.	100 ms	150 ms	150 ms
With monitored start max.	150 ms	220 ms	220 ms
Delay-on de-energisation			
With E-STOP typ.	20 ms	20 ms	20 ms
With E-STOP max.	30 ms	30 ms	30 ms
With power failure typ.	60 ms	170 ms	170 ms
With power failure max.	80 ms	250 ms	250 ms
Recovery time at max. switching frequency 1/s			
After E-STOP	50 ms	50 ms	50 ms
After power failure	100 ms	300 ms	300 ms
Min. start pulse duration with a monitored start	30 ms	50 ms	50 ms
Supply interruption before de-energisation	20 ms	20 ms	20 ms

Environmental data	777607	777609	787609
Climatic suitability	EN 60068-2-78	EN 60068-2-78	EN 60068-2-78
Ambient temperature			
Temperature range	-10 - 55 °C	-10 - 55 °C	-10 - 55 °C
Storage temperature			
Temperature range	-40 - 85 °C	-40 - 85 °C	-40 - 85 °C
Climatic suitability			
Humidity	93 % r. h. at 40 °C	93 % r. h. at 40 °C	93 % r. h. at 40 °C
Condensation during operation	Not permitted	Not permitted	Not permitted
EMC	EN 60947-5-1, EN 61000-6-2, EN 61326-3-1	EN 60947-5-1, EN 61000-6-2, EN 61326-3-1	EN 60947-5-1, EN 61000-6-2, EN 61326-3-1
Vibration			
In accordance with the standard	EN 60068-2-6	EN 60068-2-6	EN 60068-2-6
Frequency	10 - 55 Hz	10 - 55 Hz	10 - 55 Hz
Amplitude	0,35 mm	0,35 mm	0,35 mm
Airgap creepage			
In accordance with the standard	EN 60947-1	EN 60947-1	EN 60947-1
Overvoltage category	III / II	III / II	III / II
Pollution degree	2	2	2
Rated insulation voltage	250 V	250 V	250 V
Rated impulse withstand voltage	4 kV	4 kV	4 kV
Protection type			
Housing	IP40	IP40	IP40
Terminals	IP20	IP20	IP20
Mounting area (e.g. control cabinet)	IP54	IP54	IP54
Mechanical data	777607	777609	787609
Mounting position	Any	Any	Any
Mechanical life	10,000,000 cycles	10,000,000 cycles	10,000,000 cycles
Material			
Bottom	PPO UL 94 V0	PPO UL 94 V0	PPO UL 94 V0
Front	ABS UL 94 V0	ABS UL 94 V0	ABS UL 94 V0
Top	PPO UL 94 V0	PPO UL 94 V0	PPO UL 94 V0
Connection type	Screw terminal	Screw terminal	Spring-loaded terminal
Mounting type	plug-in	plug-in	plug-in

Mechanical data	777607	777609	787609
Conductor cross section with screw terminals			
1 core flexible	0,25 - 2,5 mm ² , 24 - 12 AWG	0,25 - 2,5 mm ² , 24 - 12 AWG	–
2 core with the same cross section, flexible with crimp connectors, no plastic sleeve	0,25 - 1 mm ² , 24 - 16 AWG	0,25 - 1 mm ² , 24 - 16 AWG	–
2 core with the same cross section, flexible without crimp connectors or with TWIN crimp connectors	0,2 - 1,5 mm ² , 24 - 16 AWG	0,2 - 1,5 mm ² , 24 - 16 AWG	–
Torque setting with screw terminals	0,5 Nm	0,5 Nm	–
Stripping length with screw terminals	8 mm	8 mm	–
Conductor cross section with spring-loaded terminals: Flexible with/without crimp connector	–	–	0,2 - 1,5 mm ² , 24 - 16 AWG
Spring-loaded terminals: Terminal points per connection	–	–	2
Stripping length with spring-loaded terminals	–	–	8 mm
Dimensions			
Height	94 mm	94 mm	101 mm
Width	90 mm	90 mm	90 mm
Depth	121 mm	121 mm	121 mm
Weight	570 g	570 g	570 g

Where standards are undated, the 2020-07 latest editions shall apply.

Safety characteristic data



NOTICE

You must comply with the safety characteristic data in order to achieve the required safety level for your plant/machine.

Operating mode	EN ISO 13849-1: 2015	EN ISO 13849-1: 2015	EN 62061 SIL CL	EN 62061 PFH _D [1/h]	IEC 61511 SIL	IEC 61511 PFD	EN ISO 13849-1: 2015 T _M [year]
–	PL e	Cat. 4	SIL CL 3	2,31E-09	SIL 3	2,03E-06	20

Explanatory notes for the safety-related characteristic data:

- ▶ The SIL CL value in accordance with EN 62061 corresponds to the SIL value in accordance with EN 61508.
- ▶ T_M is the maximum mission time in accordance with EN ISO 13849-1. The value also applies as the retest interval in accordance with EN 61508-6 and IEC 61511 and as the proof test interval and mission time in accordance with EN 62061.

All the units used within a safety function must be considered when calculating the safety characteristic data.



INFORMATION

A safety function's SIL/PL values are **not** identical to the SIL/PL values of the units that are used and may be different. We recommend that you use the PASCAL software tool to calculate the safety function's SIL/PL values.

Supplementary data



CAUTION!

It is essential to consider the relay's service life graphs. The relay outputs' safety-related characteristic data is only valid if the values in the service life graphs are met.

The PFH value depends on the switch frequency and the load of the relay output. If the service life graphs are not accessible, the stated PFH value can be used irrespective of the switch frequency and the load, as the PFH value already considers the relay's B10d value as well as the failure rates of the other components.

Service life graph

The service life graphs indicate the number of cycles from which failures due to wear must be expected. The wear is mainly caused by the electrical load; the mechanical load is negligible.

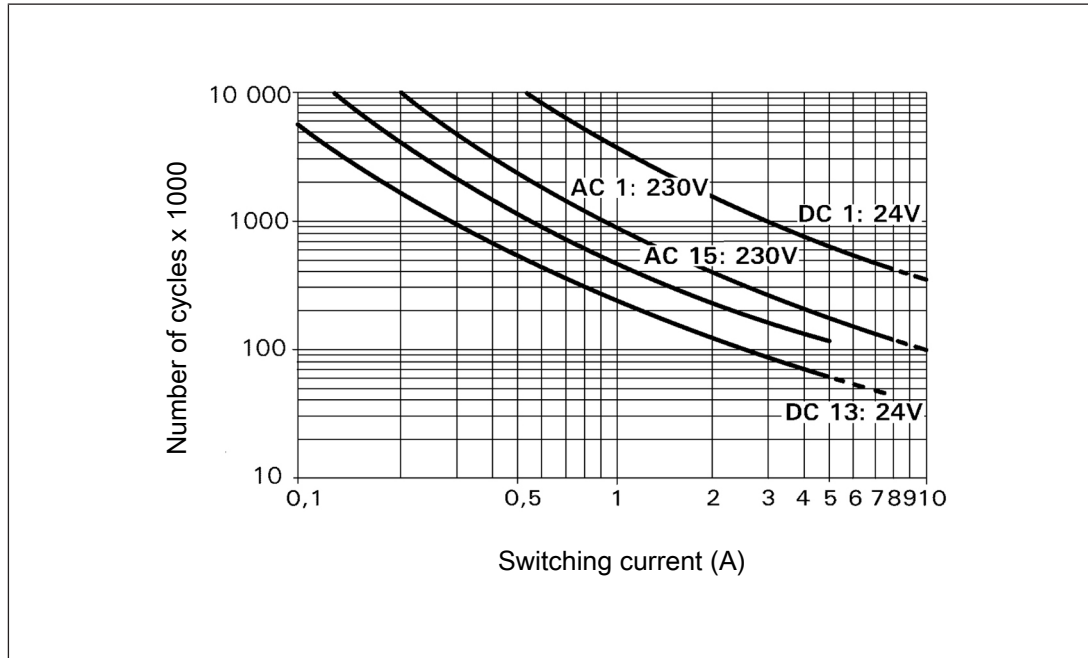

Example

- ▶ Inductive load: 0.2 A
- ▶ Utilisation category: AC15
- ▶ Contact service life: 4 000 000 cycles

Provided the application to be implemented requires fewer than 4 000 000 cycles, the PFH value (see Technical details) can be used in the calculation.

To increase the service life, sufficient spark suppression must be provided on all output contacts. With capacitive loads, any power surges that occur must be noted. With DC contacts, use flywheel diodes for spark suppression.

Remove plug-in terminals

Procedure: Insert the screwdriver into the housing recess behind the terminal and lever the terminal out.

Do **not** remove the terminals by pulling the cables!

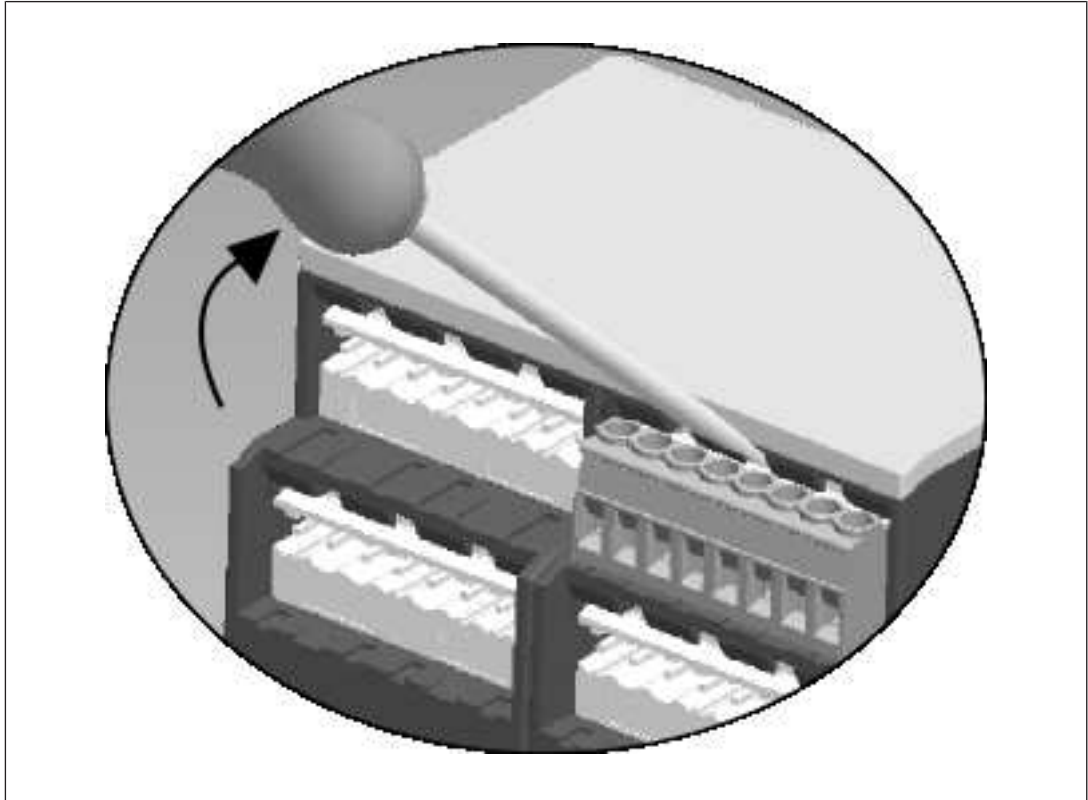

Order reference

Product type	Features	Connection type	Order no.
PNOZ X9P	24-240 V AC/DC, 24 V DC	Screw terminals	777606
PNOZ X9P C	24-240 V AC/DC, 24 V DC	Spring-loaded terminals	787606
PNOZ X9P	12 V DC	Screw terminals	777607
PNOZ X9P	24 V DC	Screw terminals	777609
PNOZ X9P C	24 V DC	Spring-loaded terminals	787609

EC declaration of conformity

This product/these products meet the requirements of the directive 2006/42/EC for machinery of the European Parliament and of the Council. The complete EC Declaration of Conformity is available on the Internet at www.pilz.com/support/downloads.

Representative: Norbert Fröhlich, Pilz GmbH & Co. KG, Felix-Wankel-Str. 2, 73760 Ostfildern, Germany

► Support

Technical support is available from Pilz round the clock.

Americas

Brazil
+55 11 97569-2804

Canada
+1 888 315 7459

Mexico
+52 55 5572 1300

USA (toll-free)
+1 877-PILZUSA (745-9872)

Asia

China
+86 21 60880878-216

Japan
+81 45 471-2281

South Korea
+82 31 778 3300

Australia

+61 3 95600621

Europe

Austria
+43 1 7986263-0

Belgium, Luxembourg
+32 9 3217570

France
+33 3 88104003

Germany
+49 711 3409-444

Ireland
+353 21 4804983

Italy, Malta
+39 0362 1826711

Scandinavia

+45 74436332

Spain

+34 938497433

Switzerland

+41 62 88979-32

The Netherlands

+31 347 320477

Turkey

+90 216 5775552

United Kingdom

+44 1536 462203

You can reach our international hotline on:

+49 711 3409-444
support@pilz.com

Pilz develops environmentally-friendly products using ecological materials and energy-saving technologies. Offices and production facilities are ecologically designed, environmentally-aware and energy-saving. So Pilz offers sustainability, plus the security of using energy-efficient products and environmentally-friendly solutions.

Energy saving by Pilz



We are represented internationally. Please refer to our homepage www.pilz.com for further details or contact our headquarters.

Headquarters: Pilz GmbH & Co. KG, Felix-Wankel-Straße 2, 73760 Ostfildern, Germany
Telephone: +49 711 3409-0, Telefax: +49 711 3409-133, E-Mail: info@pilz.com, Internet: www.pilz.com

PILZ
THE SPIRIT OF SAFETY

1003362-EN-12, 2020-11 Printed in Germany
© Pilz GmbH & Co. KG, 2019

CECC® , CHRE® , CMSE® , InduraNET p® , Leansafe® , Master of Safety® , Master of Security® , PAS4000® , PAScall® , PASconfig® , Pilz® , PTT® , PLID® , PMCPirimo® , PMCPiritego® , PMCTendo® , PMD® , PMJ® , PNOZ® , PRBT® , PRCM® , PRCM® , PSEN® , PSEN® , PSS® , PVS® , SafetyBUS p® , SafetyEYE® , SafetyNET p® , THE SPIRIT OF SAFETY® are registered and protected trademarks of Pilz GmbH & Co. KG in some countries. We would point out that product features may vary from the details stated in this document, depending on the status at the time of publication and the scope of the equipment. We accept no responsibility for the validity, accuracy and entirety of the text and graphics presented in this information. Please contact our Technical Support if you have any questions.