



Visualisation; Diagnostics

Easy to Configure

Programming IEC 61131-3

Rapid Installation

PNOZ XV3.1P

PILZ

THE SPIRIT OF SAFETY

► Safety relays

This document is the original document.

All rights to this documentation are reserved by Pilz GmbH & Co. KG. Copies may be made for the user's internal purposes. Suggestions and comments for improving this documentation will be gratefully received.

Source code from third-party manufacturers or open source software has been used for some components. The relevant licence information is available on the Internet on the Pilz homepage.

Pilz®, PIT®, PMI®, PNOZ®, Primo®, PSEN®, PSS®, PVIS®, SafetyBUS p®, SafetyEYE®, SafetyNET p®, the spirit of safety® are registered and protected trademarks of Pilz GmbH & Co. KG in some countries.



SD means Secure Digital

Introduction	5
Validity of documentation	5
Using the documentation	5
Definition of symbols	5
Safety	6
Intended use	6
Safety regulations	6
Safety assessment	6
Use of qualified personnel	7
Warranty and liability	7
Disposal	7
For your safety	7
Unit features	8
Safety features	8
Block diagram/terminal configuration	9
Types: AC/DC	9
Types: DC	9
Function Description	10
Operating modes	10
Timing diagram	11
Installation	12
Wiring	12
Preparing for operation	13
Operation	15
Status indicators	16

Faults – Interference	17
Dimensions in mm	17
Technical details Order no. 777520-777525	18
Technical details Order no. 777530-777538	23
Technical details Order no. 787520-787530	30
Technical details Order no. 787532-787538	37
Safety characteristic data	43
Supplementary data	44
Service life graph	44
Remove plug-in terminals	45
Order reference	46
EC declaration of conformity	46

Introduction

Validity of documentation

This documentation is valid for the product PNOZ XV3.1P. It is valid until new documentation is published.

This operating manual explains the function and operation, describes the installation and provides guidelines on how to connect the product.

Using the documentation

This document is intended for instruction. Only install and commission the product if you have read and understood this document. The document should be retained for future reference.

Definition of symbols

Information that is particularly important is identified as follows:



DANGER!

This warning must be heeded! It warns of a hazardous situation that poses an immediate threat of serious injury and death and indicates preventive measures that can be taken.



WARNING!

This warning must be heeded! It warns of a hazardous situation that could lead to serious injury and death and indicates preventive measures that can be taken.



CAUTION!

This refers to a hazard that can lead to a less serious or minor injury plus material damage, and also provides information on preventive measures that can be taken.



NOTICE

This describes a situation in which the product or devices could be damaged and also provides information on preventive measures that can be taken. It also highlights areas within the text that are of particular importance.

**INFORMATION**

This gives advice on applications and provides information on special features.

Safety**Intended use**

The safety relay PNOZ XV3.1P provides a safety-related interruption of a safety circuit.

The safety relay meets the requirements of EN 60947-5-1 and EN 60204-1 and may be used in applications with:

- ▶ E-STOP pushbuttons
- ▶ Safety gates
- ▶ Light grids and safety switches with detection of shorts across contacts

The following is deemed improper use in particular

- ▶ Any component, technical or electrical modification to the product,
- ▶ Use of the product outside the areas described in this manual,
- ▶ Use of the product outside the technical details (see [Technical details](#)  18).

**NOTICE****EMC-compliant electrical installation**

The product is designed for use in an industrial environment. The product may cause interference if installed in other environments. If installed in other environments, measures should be taken to comply with the applicable standards and directives for the respective installation site with regard to interference.

Safety regulations**Safety assessment**

Before using a device, a safety assessment in accordance with the Machinery Directive is required.

The product as an individual component fulfils the functional safety requirements in accordance with EN ISO 13849 and EN 62061. However, this does not guarantee the functional safety of the overall plant/machine. To achieve the relevant safety level of the overall plant/machine's required safety functions, each safety function needs to be considered separately.

Use of qualified personnel

The products may only be assembled, installed, programmed, commissioned, operated, maintained and decommissioned by persons who are competent to do so.

A competent person is a qualified and knowledgeable person who, because of their training, experience and current professional activity, has the specialist knowledge required. To be able to inspect, assess and operate devices, systems and machines, the person has to be informed of the state of the art and the applicable national, European and international laws, directives and standards.

It is the company's responsibility only to employ personnel who

- ▶ Are familiar with the basic regulations concerning health and safety / accident prevention,
- ▶ Have read and understood the information provided in the section entitled Safety
- ▶ Have a good knowledge of the generic and specialist standards applicable to the specific application.

Warranty and liability

All claims to warranty and liability will be rendered invalid if

- ▶ The product was used contrary to the purpose for which it is intended,
- ▶ Damage can be attributed to not having followed the guidelines in the manual,
- ▶ Operating personnel are not suitably qualified,
- ▶ Any type of modification has been made (e.g. exchanging components on the PCB boards, soldering work etc.).

Disposal

- ▶ In safety-related applications, please comply with the mission time T_M in the safety-related characteristic data.
- ▶ When decommissioning, please comply with local regulations regarding the disposal of electronic devices (e.g. Electrical and Electronic Equipment Act).

For your safety

The unit meets all the necessary conditions for safe operation. However, please note the following:

- ▶ Note for overvoltage category III: If voltages higher than low voltage (>50 VAC or >120 VDC) are present on the unit, connected control elements and sensors must have a rated insulation voltage of at least 250 V.

Unit features

- ▶ Positive-guided relay outputs:
 - 3 safety contacts (N/O), instantaneous
 - 2 safety contacts (N/O), delay-on de-energisation
 - 1 auxiliary contact (N/C), instantaneous
- ▶ Connection options for:
 - E-STOP pushbuttons
 - Safety gate limit switches
 - Start buttons
 - Light grids and safety switches with detection of shorts across contacts
- ▶ Delay time fixed or selectable
- ▶ Possible to cancel delay time
- ▶ LED display for:
 - Supply voltage
 - Switch state of the safety contacts
 - Start circuit
- ▶ Plug-in connection terminals (either spring-loaded terminal or screw terminal)
- ▶ See order reference for unit types

Safety features

The safety relay meets the following safety requirements:

- ▶ The circuit is redundant with built-in self-monitoring.
- ▶ The safety function remains effective in the case of a component failure.
- ▶ The correct opening and closing of the safety function relays is tested automatically in each on-off cycle.

Block diagram/terminal configuration

Types: AC/DC

► U_B : 24 - 240 VAC/DC; Order no. 777530, 787530, 777532, 787532, 777538, 787538

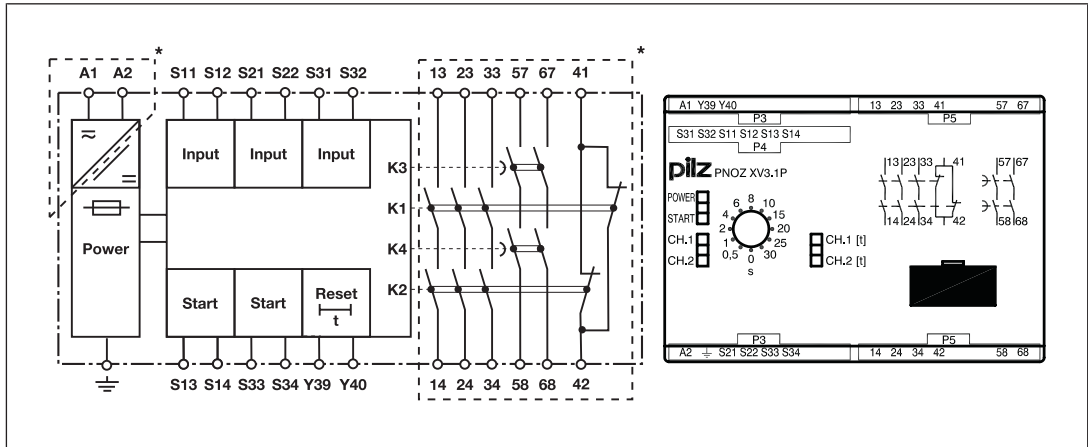

*Insulation between the non-marked area and the relay contacts: Basic insulation (over-voltage category III), Protective separation (overvoltage category II)

Types: DC

► U_B : 24 VDC; Order no. 777520, 787520, 777522, 787522, 777525

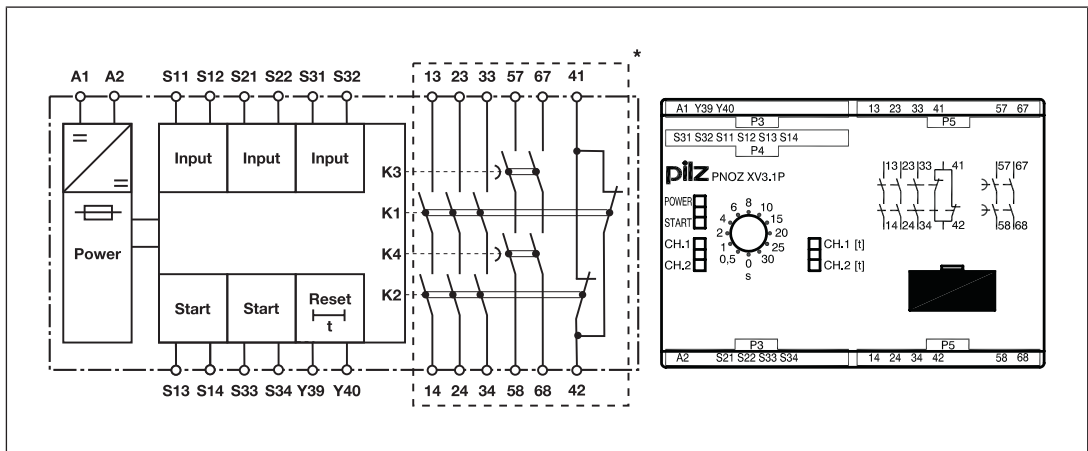

*Insulation between the non-marked area and the relay contacts: Basic insulation (over-voltage category III), Protective separation (overvoltage category II)

Function Description

The safety relay PNOZ XV3.1P provides a safety-oriented interruption of a safety circuit. When supply voltage is supplied the "POWER" LED is lit. The unit is ready for operation when the reset circuit Y39-Y40 and the start circuit S13-S14 are closed.

- ▶ Input circuit is closed (e.g. E-STOP pushbutton not operated):
 - The "START" LED is lit.
 - The LEDs "CH.1", "CH.1 [t]", "CH.2" and "CH.2 [t]" are lit.
 - Safety contacts 13-14, 23-24, 33-34, 57-58 and 67-68 are closed, auxiliary contact 41-42 is opened. The unit is active.
 - The "START" LED goes out.
- ▶ Input circuit is opened (e.g. E-STOP pushbutton operated):
 - The LEDs "CH.1" and "CH.2" go out.
 - Safety contacts 13-14, 23-24 and 33-34 are opened redundantly, auxiliary contact 41-42 is closed.
 - Safety contacts 57-58 and 67-68 open after the delay time has elapsed.
 - The LEDs "CH.1 [t]" and "CH.2 [t]" go out.

Before the unit can be restarted, the delay time must have elapsed and the unit must again be ready for operation.

Set delay time:

On units with selectable delay time, the delay time of the safety contacts 57-58 and 67-68 can be set on the front of the unit using a screwdriver.

Reset function:

The delay time cycle can be ended prematurely by opening the reset circuit Y39-Y40. For this purpose, one N/C contact is connected between Y39-Y40 instead of a link.

Operating modes

- ▶ Single-channel operation: No redundancy in the input circuit, earth faults in the start and input circuit are detected.
- ▶ Dual-channel operation with detection of shorts across contacts: Redundant input circuit, detects PNOZ XV3.1P
 - earth faults in the start and input circuit,
 - short circuits in the input circuit,
 - Shorts across contacts in the input circuit.
- ▶ Dual-channel operation without detection of shorts across contacts: Redundant input circuit, detects PNOZ XV3.1P
 - earth faults in the start and input circuit,
 - short circuits in the input circuit.
- ▶ Automatic start: Unit is active once the input circuit has been closed.
- ▶ Monitored start: Unit is active once the input circuit is closed and once the start circuit is closed after the waiting period has elapsed (see [Technical details](#)  18]).

- ▶ Increase in the number of available contacts by connecting contact expansion modules or external contactors/relays.

Timing diagram

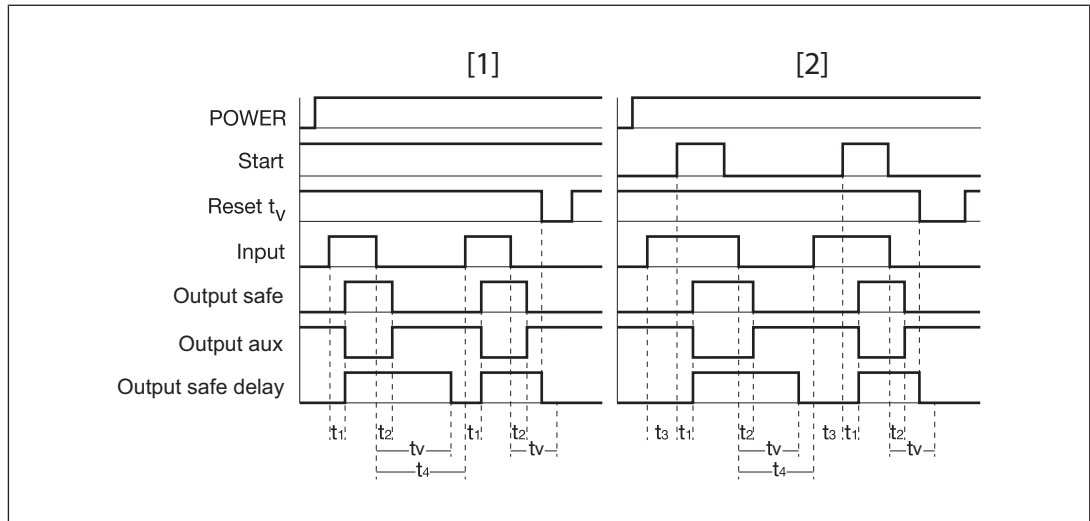

Legend

- ▶ Power: Supply voltage
- ▶ Start: Start circuit
- ▶ Reset t_v : Reset circuit
- ▶ Input: Input circuit
- ▶ Output safe: Safety contacts, instantaneous
- ▶ Output safe delay: Safety contacts, delayed
- ▶ Output aux: Auxiliary contact
- ▶ [1]: Automatic start
- ▶ [2]: Monitored start
- ▶ t_1 : Switch-on delay
- ▶ t_2 : Delay-on de-energisation
- ▶ t_3 : Waiting period with a monitored start
- ▶ t_4 : Recovery time
- ▶ t_v : Delay time



NOTICE

At the latest, the delay-on de-energisation safety contacts open after the set delay time + 50 ms + 15% of the set value, even in the case of a component failure.

Installation

- ▶ The unit should be installed in a control cabinet with a protection type of at least IP54.
- ▶ Use the notch on the rear of the unit to attach it to a DIN rail (35 mm).
- ▶ When installed vertically: Secure the unit by using a fixing element (e.g. retaining bracket or end angle).

Wiring

Please note:

- ▶ Information given in the "[Technical details \[18\]](#)" must be followed.
- ▶ Delivery status of units with screw terminals: Link between S11-S12 (dual-channel input circuit) and link between Y39-Y40 (reset circuit)
- ▶ Outputs 13-14, 23-24, 33-34 are instantaneous safety contacts, outputs 57-58, 67-68 are delay-on de-energisation safety contacts, output 41-42 is an instantaneous auxiliary contact (e.g. for display).
- ▶ Auxiliary contact 41-42 should **not** be used for safety circuits!
- ▶ Do not connect undesignated terminals.
- ▶ To prevent contact welding, a fuse should be connected before the output contacts (see [Technical details \[18\]](#)).
- ▶ Calculation of the max. cable length l_{\max} in the input circuit:

$$l_{\max} = \frac{R_{l_{\max}}}{R_l / \text{km}}$$

$R_{l_{\max}}$ = max. overall cable resistance (see [Technical details \[18\]](#))

R_l / km = cable resistance/km

- ▶ Use copper wiring with a temperature stability of 60/75 °C.
- ▶ To prevent EMC interferences (particularly common-mode interferences) the measures described in EN 60204-1 must be executed. This includes the separate routing of cables of the control circuits (input, start and feedback loop) from other cables for energy transmission or the shielding of cables, for example.
- ▶ Adequate protection must be provided on all output contacts with capacitive and inductive loads.
- ▶ On units with U_b 24 – 240 VAC/DC: Connect operational earth terminal to functional earth.
- ▶ Do not switch low currents using contacts that have been used previously with high currents.
- ▶ On 24 VDC devices:
The power supply must comply with the regulations for extra low voltages with protective electrical separation (SELV, PELV) in accordance with VDE 0100, Part 410.

Important for detection of shorts across contacts:

As this function for detecting shorts across contacts is not failsafe, it is tested by Pilz during the final control check. If there is a danger of exceeding the cable length, we recommend the following test once the unit is installed:

1. Unit ready for operation (output contacts closed)
2. Short circuit the test terminals S22, S32 for detecting shorts across the inputs.
3. The unit's fuse must be triggered and the output contacts must open. Cable lengths in the scale of the maximum length can delay the fuse triggering for up to 2 minutes.
4. Reset the fuse: Remove the short circuit and switch off the supply voltage for approx. 1 minute.

Preparing for operation

Supply voltage	U _B 24 - 240 VAC/DC	U _B 24 VDC
Input circuit	Single-channel	Dual-channel
E-STOP without detection of shorts across contacts		
E-STOP with detection of shorts across contacts	/	
Safety gate without detection of shorts across contacts		
Safety gate with detection of shorts across contacts	/	

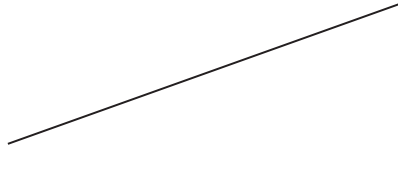
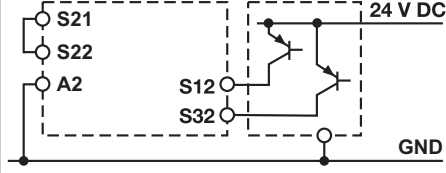
Input circuit	Single-channel	Dual-channel
Light guard or safety switch, detection of shorts across contacts via ESPE (only when $U_B = 24 \text{ VDC}$); Order no. 777520, 787520, 777522, 787522, 777525)		



NOTICE

With single-channel wiring the safety level of your machine/plant may be lower than the safety level of the unit (see Safety characteristic data).



NOTICE

Operation with a light guard or safety switch

It must not be possible to switch off the supply voltage for the PNOZ XV3.1P separately from the supply voltage for the light grid or safety switch.

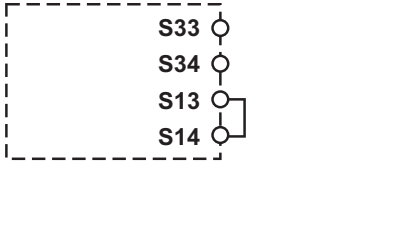
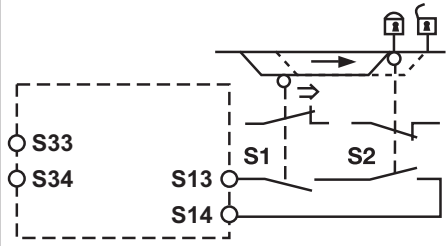
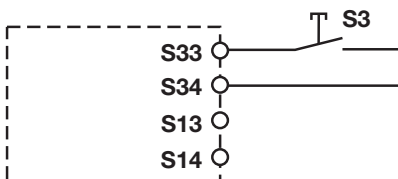
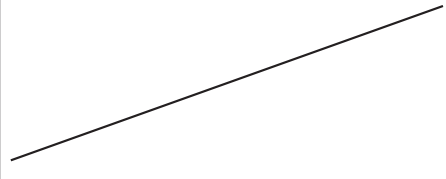
Start circuit	E-STOP wiring Safety gate without start-up test	Safety gate with start-up test
Automatic start		
Monitored start		



NOTICE

In the event of an automatic start:

The unit starts up automatically when the safeguard is reset, e.g. when the E-STOP pushbutton is released. Use external circuit measures to prevent an unexpected restart.

Reset delay time	Without reset	With reset
Link or N/C contact		
Feedback loop	Automatic start	Monitored start
Contacts from external contactors		

Legend

- ▶ S1/S2: E-STOP/safety gate switch
- ▶ S3: Reset button
- ▶ ⬆: Switch operated
- ▶ : Gate open
- ▶ : Gate closed



INFORMATION

With automatic start, S33 and S34 must not be linked; with monitored start, S13 and S14 must not be linked.

Operation

When the relay outputs are switched on, the mechanical contact on the relay cannot be tested automatically. Depending on the operational environment, measures to detect the non-opening of switching elements may be required under some circumstances.

When the product is used in accordance with the European Machinery Directive, a check must be carried out to ensure that the safety contacts on the relay outputs open correctly. Open the safety contacts (switch off output) and start the device again, so that the internal diagnostics can check that the safety contacts open correctly

- ▶ for SIL CL 3/PL e at least 1x per month
- ▶ for SIL CL 3/PL d at least 1x per year

**NOTICE**

The safety function should be checked after initial commissioning and each time the plant/machine is changed. The safety functions may only be checked by qualified personnel.

Status indicators

LEDs indicate the status and errors during operation:



LED on

**POWER**

Supply voltage is present.

**START**

Start circuit is closed.

**CH.1**

Safety contacts of channel 1 are closed.

**CH.2**

Safety contacts of channel 2 are closed.

**CH.1 [t]**

Channel 3 safety contacts are closed.

**CH.2 [t]**

Channel 4 safety contacts are closed.

Faults – Interference

- ▶ Earth fault: The supply voltage fails and the safety contacts open. Once the cause of the respective fault has been rectified and the supply voltage is switched off for approx. 1 minute, the unit is ready for operation again.
- ▶ Contact malfunctions: If the contacts have welded, reactivation will not be possible after the input circuit has opened.
- ▶ LED "POWER" does not light: Short circuit or no supply voltage.
- ▶ In the case of an error, the delay-on de-energisation contacts may open before the delay time has elapsed.

Dimensions in mm

* with spring-loaded terminals

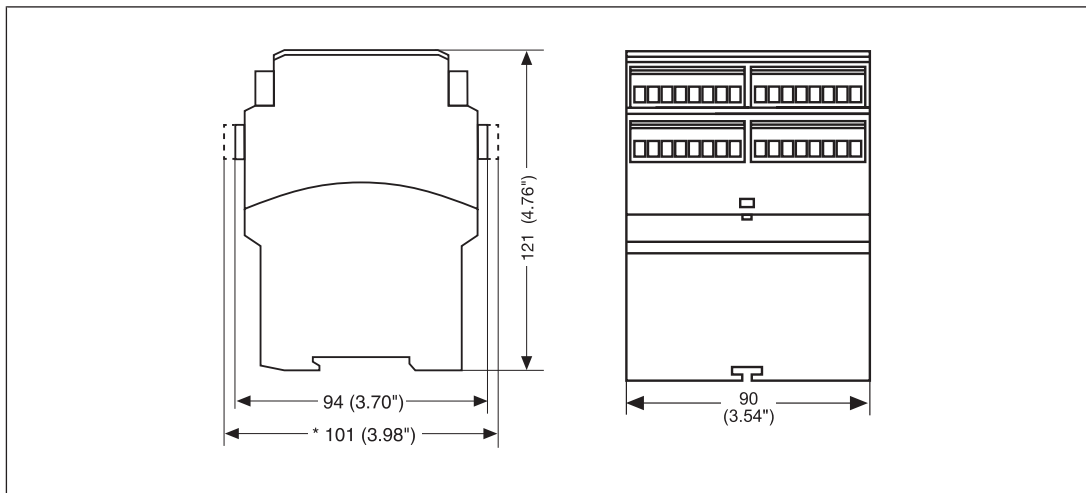

Technical details Order no. 777520-777525

General	777520	777522	777525
Certifications	CCC, CE, EAC (Eurasian), TÜV, cULus Listed	CCC, CE, EAC (Eurasian), TÜV, cULus Listed	CCC, CE, EAC (Eurasian), TÜV, cULus Listed
Electrical data	777520	777522	777525
Supply voltage			
Voltage	24 V	24 V	24 V
Kind	DC	DC	DC
Voltage tolerance	-15 %/+10 %	-15 %/+10 %	-15 %/+10 %
Output of external power supply (DC)	4,5 W	4,5 W	4,5 W
Residual ripple DC	160 %	160 %	160 %
Duty cycle	100 %	100 %	100 %
Max. inrush current impulse			
Current pulse, A1	5 A	5 A	5 A
Pulse duration, A1	1 ms	1 ms	1 ms
Inputs	777520	777522	777525
Number	2	2	2
Voltage at			
Input circuit DC	24 V	24 V	24 V
Start circuit DC	24 V	24 V	24 V
Feedback loop DC	24 V	24 V	24 V
Current at			
Input circuit DC	50 mA	50 mA	50 mA
Start circuit DC	40 mA	40 mA	40 mA
Feedback loop DC	3 mA	3 mA	3 mA
Max. overall cable resistance R _{lmax}			
Single-channel at UB DC	100 Ohm	100 Ohm	100 Ohm
Dual-channel without detection of shorts across contacts at UB DC	120 Ohm	120 Ohm	120 Ohm
Dual-channel with detection of shorts across contacts at UB DC	10 Ohm	10 Ohm	10 Ohm
Relay outputs	777520	777522	777525
Number of output contacts			
Safety contacts (N/O), instantaneous	3	3	3
Safety contacts (N/O), delayed	2	2	2
Auxiliary contacts (N/C)	1	1	1

Relay outputs	777520	777522	777525
Max. short circuit current IK	1 kA	1 kA	1 kA
Utilisation category			
In accordance with the standard	EN 60947-4-1	EN 60947-4-1	EN 60947-4-1
Utilisation category of safety contacts			
AC1 at	240 V	240 V	240 V
Min. current	0,01 A	0,01 A	0,01 A
Max. current	8 A	8 A	8 A
Max. power	2000 VA	2000 VA	2000 VA
DC1 at	24 V	24 V	24 V
Min. current	0,01 A	0,01 A	0,01 A
Max. current	8 A	8 A	8 A
Max. power	200 W	200 W	200 W
Utilisation category of safety contacts delayed			
AC1 at	240 V	240 V	240 V
Min. current	0,01 A	0,01 A	0,01 A
Max. current	8 A	8 A	8 A
Max. power	2000 VA	2000 VA	2000 VA
DC1 at	24 V	24 V	24 V
Min. current	0,01 A	0,01 A	0,01 A
Max. current	8 A	8 A	8 A
Max. power	200 W	200 W	200 W
Utilisation category of auxiliary contacts			
AC1 at	240 V	240 V	240 V
Min. current	0,01 A	0,01 A	0,01 A
Max. current	8 A	8 A	8 A
Max. power	2000 VA	2000 VA	2000 VA
DC1 at	24 V	24 V	24 V
Min. current	0,01 A	0,01 A	0,01 A
Max. current	8 A	8 A	8 A
Max. power	200 W	200 W	200 W
Utilisation category			
In accordance with the standard	EN 60947-5-1	EN 60947-5-1	EN 60947-5-1
Utilisation category of safety contacts			
AC15 at	230 V	230 V	230 V
Max. current	5 A	5 A	5 A
DC13 (6 cycles/min) at	24 V	24 V	24 V
Max. current	7 A	7 A	7 A

Relay outputs	777520	777522	777525
Utilisation category of safety contacts delayed			
AC15 at	230 V	230 V	230 V
Max. current	5 A	5 A	5 A
DC13 (6 cycles/min) at	24 V	24 V	24 V
Max. current	7 A	7 A	7 A
Utilisation category of auxiliary contacts			
AC15 at	230 V	230 V	230 V
Max. current	5 A	5 A	5 A
DC13 (6 cycles/min) at	24 V	24 V	24 V
Max. current	7 A	7 A	7 A
Utilisation category in accordance with UL			
Voltage	240 V AC G. P.	240 V AC G. P.	240 V AC G. P.
With current	8 A	8 A	8 A
Voltage	24 V DC Resistive	24 V DC Resistive	24 V DC Resistive
With current	5 A	5 A	5 A
Pilot Duty	C300, R300	C300, R300	C300, R300
External contact fuse protection, safety contacts			
In accordance with the standard	EN 60947-5-1	EN 60947-5-1	EN 60947-5-1
Max. melting integral	240 A²s	240 A²s	240 A²s
Blow-out fuse, quick	10 A	10 A	10 A
Blow-out fuse, slow	6 A	6 A	6 A
Blow-out fuse, gG	10 A	10 A	10 A
Circuit breaker 24V AC/DC, characteristic B/C	6 A	6 A	6 A
External contact fuse protection, delayed safety contacts			
Max. melting integral	240 A²s	240 A²s	240 A²s
Blow-out fuse, quick	10 A	10 A	10 A
Blow-out fuse, slow	6 A	6 A	6 A
Blow-out fuse, gG	10 A	10 A	10 A
Circuit breaker 24 V AC/DC, characteristic B/C	6 A	6 A	6 A

Relay outputs	777520	777522	777525
External contact fuse protection, auxiliary contacts			
Max. melting integral	240 A²s	240 A²s	240 A²s
Blow-out fuse, quick	10 A	10 A	10 A
Blow-out fuse, slow	6 A	6 A	6 A
Blow-out fuse, gG	10 A	10 A	10 A
Circuit breaker 24 V AC/DC, characteristic B/C	6 A	6 A	6 A
Contact material	AgSnO₂ + 0,2 µm Au	AgSnO₂ + 0,2 µm Au	AgSnO₂ + 0,2 µm Au
Conventional thermal current while loading several contacts	777520	777522	777525
I _{th} per contact at UB DC; AC1: 240 V, DC1: 24 V			
Conv. therm. current with 1 contact	8 A	8 A	8 A
Conv. therm. current with 2 contacts	7,8 A	7,8 A	7,8 A
Conv. therm. current with 3 contacts	6,5 A	6,5 A	6,5 A
Conv. therm. current with 4 contacts	5,5 A	5,5 A	5,5 A
Conv. therm. current with 5 contacts	5 A	5 A	5 A
Times	777520	777522	777525
Switch-on delay			
With automatic start typ.	400 ms	400 ms	400 ms
With automatic start max.	850 ms	850 ms	850 ms
With automatic start after power on typ.	400 ms	400 ms	400 ms
With automatic start after power on max.	870 ms	870 ms	870 ms
With monitored start typ.	40 ms	40 ms	40 ms
With monitored start max.	70 ms	70 ms	70 ms
Delay-on de-energisation			
With E-STOP typ.	15 ms	15 ms	15 ms
With E-STOP max.	30 ms	30 ms	30 ms
With power failure typ.	110 ms	110 ms	110 ms
With power failure max.	150 ms	150 ms	150 ms
Recovery time at max. switching frequency 1/s			
After E-STOP	50 ms +tv	50 ms +tv	50 ms +tv
After power failure	200 ms	200 ms	200 ms

Times	777520	777522	777525
Delay time tv	0,1 s, 0,5 s, 1 s, 2 s, 4 s, 6 s, 8 s, 10 s, 15 s, 20 s, 25 s, 30 s	0,1 s, 0,2 s, 0,3 s, 0,4 s, 0,5 s, 0,6 s, 0,7 s, 0,8 s, 1 s, 1,5 s, 2 s, 3 s	3 s
Time accuracy	-15 %/+15 % +50 ms	-15 %/+15 % +50 ms	-15 %/+15 % +50 ms
Repetition accuracy	2 %	2 %	2 %
Waiting period with a monitored start	300 ms	300 ms	300 ms
Min. start pulse duration with a monitored start	30 ms	30 ms	30 ms
Supply interruption before de-energisation	20 ms	20 ms	20 ms
Simultaneity, channel 1 and 2 max.	∞	∞	∞
Environmental data	777520	777522	777525
Climatic suitability	EN 60068-2-78	EN 60068-2-78	EN 60068-2-78
Ambient temperature			
Temperature range	-10 - 55 °C	-10 - 55 °C	-10 - 55 °C
Storage temperature			
Temperature range	-40 - 85 °C	-40 - 85 °C	-40 - 85 °C
Climatic suitability			
Humidity	93 % r. h. at 40 °C	93 % r. h. at 40 °C	93 % r. h. at 40 °C
Condensation during operation	Not permitted	Not permitted	Not permitted
EMC	EN 60947-5-1, EN 61000-6-2, EN 61326-3-1	EN 60947-5-1, EN 61000-6-2, EN 61326-3-1	EN 60947-5-1, EN 61000-6-2, EN 61326-3-1
Vibration			
In accordance with the standard	EN 60068-2-6	EN 60068-2-6	EN 60068-2-6
Frequency	10 - 55 Hz	10 - 55 Hz	10 - 55 Hz
Amplitude	0,35 mm	0,35 mm	0,35 mm
Airgap creepage			
In accordance with the standard	EN 60947-1	EN 60947-1	EN 60947-1
Overvoltage category	III / II	III / II	III / II
Pollution degree	2	2	2
Rated insulation voltage	250 V	250 V	250 V
Rated impulse withstand voltage	4 kV	4 kV	4 kV
Protection type			
Housing	IP40	IP40	IP40
Terminals	IP20	IP20	IP20
Mounting area (e.g. control cabinet)	IP54	IP54	IP54
Mechanical data	777520	777522	777525
Mounting position	Any	Any	Any
Mechanical life	10,000,000 cycles	10,000,000 cycles	10,000,000 cycles

Mechanical data	777520	777522	777525
Material			
Bottom	PPO UL 94 V0	PPO UL 94 V0	PPO UL 94 V0
Front	ABS UL 94 V0	ABS UL 94 V0	ABS UL 94 V0
Top	PPO UL 94 V0	PPO UL 94 V0	PPO UL 94 V0
Connection type	Screw terminal	Screw terminal	Screw terminal
Mounting type	plug-in	plug-in	plug-in
Conductor cross section with screw terminals			
1 core flexible	0,25 - 2,5 mm², 24 - 12 AWG	0,25 - 2,5 mm², 24 - 12 AWG	0,25 - 2,5 mm², 24 - 12 AWG
2 core with the same cross section, flexible with crimp connectors, no plastic sleeve	0,25 - 1 mm², 24 - 16 AWG	0,25 - 1 mm², 24 - 16 AWG	0,25 - 1 mm², 24 - 16 AWG
2 core with the same cross section, flexible without crimp connectors or with TWIN crimp connectors	0,2 - 1,5 mm², 24 - 16 AWG	0,2 - 1,5 mm², 24 - 16 AWG	0,2 - 1,5 mm², 24 - 16 AWG
Torque setting with screw terminals	0,5 Nm	0,5 Nm	0,5 Nm
Stripping length with screw terminals	8 mm	8 mm	8 mm
Dimensions			
Height	94 mm	94 mm	94 mm
Width	90 mm	90 mm	90 mm
Depth	121 mm	121 mm	121 mm
Weight	510 g	510 g	500 g

Where standards are undated, the 2020-07 latest editions shall apply.

Technical details Order no. 777530-777538

General	777530	777532	777538
Certifications	CCC, CE, EAC (Eurasian), TÜV, cULus Listed	CCC, CE, EAC (Eurasian), TÜV, cULus Listed	CCC, CE, EAC (Eurasian), TÜV, cULus Listed
Electrical data	777530	777532	777538
Supply voltage			
Voltage	24 - 240 V	24 - 240 V	24 - 240 V
Kind	AC/DC	AC/DC	AC/DC
Voltage tolerance	-15 %/+10 %	-15 %/+10 %	-15 %/+10 %
Output of external power supply (AC)	8,5 VA	8,5 VA	8,5 VA
Output of external power supply (DC)	5 W	5 W	5 W
Frequency range AC	50 - 60 Hz	50 - 60 Hz	50 - 60 Hz
Residual ripple DC	160 %	160 %	160 %
Duty cycle	100 %	100 %	100 %

Inputs	777530	777532	777538
Number	2	2	2
Voltage at			
Input circuit DC	24 V	24 V	24 V
Start circuit DC	24 V	24 V	24 V
Feedback loop DC	24 V	24 V	24 V
Current at			
Input circuit DC	40 mA	40 mA	40 mA
Start circuit DC	40 mA	40 mA	40 mA
Feedback loop DC	3 mA	3 mA	3 mA
Max. overall cable resistance R _{lmax}			
Single-channel at UB DC	150 Ohm	150 Ohm	150 Ohm
Single-channel at UB AC	150 Ohm	150 Ohm	150 Ohm
Dual-channel without detection of shorts across contacts at UB DC	200 Ohm	200 Ohm	200 Ohm
Dual-channel without detection of shorts across contacts at UB AC	200 Ohm	200 Ohm	200 Ohm
Dual-channel with detection of shorts across contacts at UB DC	20 Ohm	20 Ohm	20 Ohm
Dual-channel with detection of shorts across contacts at UB AC	20 Ohm	20 Ohm	20 Ohm
Relay outputs	777530	777532	777538
Number of output contacts			
Safety contacts (N/O), instantaneous	3	3	3
Safety contacts (N/O), delayed	2	2	2
Auxiliary contacts (N/C)	1	1	1
Max. short circuit current IK	1 kA	1 kA	1 kA
Utilisation category			
In accordance with the standard	EN 60947-4-1	EN 60947-4-1	EN 60947-4-1

Relay outputs	777530	777532	777538
Utilisation category of safety contacts			
AC1 at	240 V	240 V	240 V
Min. current	0,01 A	0,01 A	0,01 A
Max. current	8 A	8 A	8 A
Max. power	2000 VA	2000 VA	2000 VA
DC1 at	24 V	24 V	24 V
Min. current	0,01 A	0,01 A	0,01 A
Max. current	8 A	8 A	8 A
Max. power	200 W	200 W	200 W
Utilisation category of safety contacts delayed			
AC1 at	240 V	240 V	240 V
Min. current	0,01 A	0,01 A	0,01 A
Max. current	8 A	8 A	8 A
Max. power	2000 VA	2000 VA	2000 VA
DC1 at	24 V	24 V	24 V
Min. current	0,01 A	0,01 A	0,01 A
Max. current	8 A	8 A	8 A
Max. power	200 W	200 W	200 W
Utilisation category of auxiliary contacts			
AC1 at	240 V	240 V	240 V
Min. current	0,01 A	0,01 A	0,01 A
Max. current	8 A	8 A	8 A
Max. power	2000 VA	2000 VA	2000 VA
DC1 at	24 V	24 V	24 V
Min. current	0,01 A	0,01 A	0,01 A
Max. current	8 A	8 A	8 A
Max. power	200 W	200 W	200 W
Utilisation category			
In accordance with the standard	EN 60947-5-1	EN 60947-5-1	EN 60947-5-1
Utilisation category of safety contacts			
AC15 at	230 V	230 V	230 V
Max. current	5 A	5 A	5 A
DC13 (6 cycles/min) at	24 V	24 V	24 V
Max. current	7 A	7 A	7 A
Utilisation category of safety contacts delayed			
AC15 at	230 V	230 V	230 V
Max. current	5 A	5 A	5 A
DC13 (6 cycles/min) at	24 V	24 V	24 V
Max. current	7 A	7 A	7 A

Relay outputs	777530	777532	777538
Utilisation category of auxiliary contacts			
AC15 at	230 V	230 V	230 V
Max. current	5 A	5 A	5 A
DC13 (6 cycles/min) at	24 V	24 V	24 V
Max. current	7 A	7 A	7 A
Utilisation category in accordance with UL			
Voltage	240 V AC G. P.	240 V AC G. P.	240 V AC G. P.
With current	8 A	8 A	8 A
Voltage	24 V DC Resistive	24 V DC Resistive	24 V DC Resistive
With current	5 A	5 A	5 A
Pilot Duty	C300, R300	C300, R300	C300, R300
External contact fuse protection, safety contacts			
In accordance with the standard	EN 60947-5-1	EN 60947-5-1	EN 60947-5-1
Max. melting integral	240 A²s	240 A²s	240 A²s
Blow-out fuse, quick	10 A	10 A	10 A
Blow-out fuse, slow	6 A	6 A	6 A
Blow-out fuse, gG	10 A	10 A	10 A
Circuit breaker 24V AC/DC, characteristic B/C	6 A	6 A	6 A
External contact fuse protection, delayed safety contacts			
Max. melting integral	240 A²s	240 A²s	240 A²s
Blow-out fuse, quick	10 A	10 A	10 A
Blow-out fuse, slow	6 A	6 A	6 A
Blow-out fuse, gG	10 A	10 A	10 A
Circuit breaker 24 V AC/DC, characteristic B/C	6 A	6 A	6 A
External contact fuse protection, auxiliary contacts			
Max. melting integral	240 A²s	240 A²s	240 A²s
Blow-out fuse, quick	10 A	10 A	10 A
Blow-out fuse, slow	6 A	6 A	6 A
Blow-out fuse, gG	10 A	10 A	10 A
Circuit breaker 24 V AC/DC, characteristic B/C	6 A	6 A	6 A
Contact material	AgSnO₂ + 0,2 µm Au	AgSnO₂ + 0,2 µm Au	AgSnO₂ + 0,2 µm Au

Conventional thermal current while loading several contacts	777530	777532	777538
Ith per contact at UB AC; AC1: 240 V, DC1: 24 V			
Conv. therm. current with 1 contact	8 A	8 A	8 A
Conv. therm. current with 2 contacts	7,8 A	7,8 A	7,8 A
Conv. therm. current with 3 contacts	6,5 A	6,5 A	6,5 A
Conv. therm. current with 4 contacts	5,5 A	5,5 A	5,5 A
Conv. therm. current with 5 contacts	5 A	5 A	5 A
Ith per contact at UB DC; AC1: 240 V, DC1: 24 V			
Conv. therm. current with 1 contact	8 A	8 A	8 A
Conv. therm. current with 2 contacts	7,8 A	7,8 A	7,8 A
Conv. therm. current with 3 contacts	6,5 A	6,5 A	6,5 A
Conv. therm. current with 4 contacts	5,5 A	5,5 A	5,5 A
Conv. therm. current with 5 contacts	5 A	5 A	5 A
Times	777530	777532	777538
Switch-on delay			
With automatic start typ.	400 ms	400 ms	400 ms
With automatic start max.	550 ms	550 ms	550 ms
With automatic start after power on typ.	750 ms	750 ms	750 ms
With automatic start after power on max.	1.050 ms	1.050 ms	1.050 ms
With monitored start typ.	35 ms	35 ms	35 ms
With monitored start max.	60 ms	60 ms	60 ms

Times	777530	777532	777538
Delay-on de-energisation			
With E-STOP typ.	15 ms	15 ms	15 ms
With E-STOP max.	30 ms	30 ms	30 ms
With power failure typ. UB 240 V	900 ms	900 ms	900 ms
With power failure max. UB 240 V	1400 ms	1400 ms	1400 ms
With power failure typ. UB 24 V	120 ms	120 ms	120 ms
With power failure max. UB 24 V	170 ms	170 ms	170 ms
Recovery time at max. switching frequency 1/s			
After E-STOP	50 ms +tv	50 ms +tv	50 ms +tv
After power failure on wide-range power supply	1450 ms	1450 ms	1450 ms
Delay time tv	0,1 s, 0,5 s, 1 s, 2 s, 4 s, 6 s, 8 s, 10 s, 15 s, 20 s, 25 s, 30 s	0,1 s, 0,2 s, 0,3 s, 0,4 s, 0,5 s, 0,6 s, 0,7 s, 0,8 s, 1 s, 1,5 s, 2 s, 3 s	0,3 s, 5 s, 10 s, 20 s, 40 s, 60 s, 80 s, 100 s, 150 s, 200 s, 250 s, 300 s
Time accuracy	-15 %/+15 % +50 ms	-15 %/+15 % +50 ms	-15 %/+15 % +50 ms
Repetition accuracy	2 %	2 %	2 %
Waiting period with a monitored start	300 ms	300 ms	300 ms
Min. start pulse duration with a monitored start	30 ms	30 ms	30 ms
Supply interruption before de-energisation	20 ms	20 ms	20 ms
Simultaneity, channel 1 and 2 max.	∞	∞	∞
Environmental data			
Climatic suitability	EN 60068-2-78	EN 60068-2-78	EN 60068-2-78
Ambient temperature			
Temperature range	-10 - 55 °C	-10 - 55 °C	-10 - 55 °C
Storage temperature			
Temperature range	-40 - 85 °C	-40 - 85 °C	-40 - 85 °C
Climatic suitability			
Humidity	93 % r. h. at 40 °C	93 % r. h. at 40 °C	93 % r. h. at 40 °C
Condensation during operation	Not permitted	Not permitted	Not permitted
EMC	EN 60947-5-1, EN 61000-6-2, EN 61000-6-4, EN 61326-3-1	EN 60947-5-1, EN 61000-6-2, EN 61000-6-4, EN 61326-3-1	EN 60947-5-1, EN 61000-6-2, EN 61000-6-4, EN 61326-3-1
Vibration			
In accordance with the standard	EN 60068-2-6	EN 60068-2-6	EN 60068-2-6
Frequency	10 - 55 Hz	10 - 55 Hz	10 - 55 Hz
Amplitude	0,35 mm	0,35 mm	0,35 mm

Environmental data	777530	777532	777538
Airgap creepage			
In accordance with the standard	EN 60947-1	EN 60947-1	EN 60947-1
Overvoltage category	III / II	III / II	III / II
Pollution degree	2	2	2
Rated insulation voltage	250 V	250 V	250 V
Rated impulse withstand voltage	4 kV	4 kV	4 kV
Protection type			
Housing	IP40	IP40	IP40
Terminals	IP20	IP20	IP20
Mounting area (e.g. control cabinet)	IP54	IP54	IP54
Mechanical data	777530	777532	777538
Mounting position	Any	Any	Any
Mechanical life	10,000,000 cycles	10,000,000 cycles	10,000,000 cycles
Material			
Bottom	PPO UL 94 V0	PPO UL 94 V0	PPO UL 94 V0
Front	ABS UL 94 V0	ABS UL 94 V0	ABS UL 94 V0
Top	PPO UL 94 V0	PPO UL 94 V0	PPO UL 94 V0
Connection type	Screw terminal	Screw terminal	Screw terminal
Mounting type	plug-in	plug-in	plug-in
Conductor cross section with screw terminals			
1 core flexible	0,25 - 2,5 mm², 24 - 12 AWG	0,25 - 2,5 mm², 24 - 12 AWG	0,25 - 2,5 mm², 24 - 12 AWG
2 core with the same cross section, flexible with crimp connectors, no plastic sleeve	0,25 - 1 mm², 24 - 16 AWG	0,25 - 1 mm², 24 - 16 AWG	0,25 - 1 mm², 24 - 16 AWG
2 core with the same cross section, flexible without crimp connectors or with TWIN crimp connectors	0,2 - 1,5 mm², 24 - 16 AWG	0,2 - 1,5 mm², 24 - 16 AWG	0,2 - 1,5 mm², 24 - 16 AWG
Torque setting with screw terminals	0,5 Nm	0,5 Nm	0,5 Nm
Stripping length with screw terminals	8 mm	8 mm	8 mm
Dimensions			
Height	94 mm	94 mm	94 mm
Width	90 mm	90 mm	90 mm
Depth	121 mm	121 mm	121 mm
Weight	540 g	540 g	540 g

Where standards are undated, the 2020-07 latest editions shall apply.

Technical details Order no. 787520-787530

General	787520	787522	787530
Certifications	CCC, CE, EAC (Eurasian), TÜV, cULus Listed	CCC, CE, EAC (Eurasian), TÜV, cULus Listed	CCC, CE, EAC (Eurasian), TÜV, cULus Listed
Electrical data	787520	787522	787530
Supply voltage			
Voltage	24 V	24 V	24 - 240 V
Kind	DC	DC	AC/DC
Voltage tolerance	-15 %/+10 %	-15 %/+10 %	-15 %/+10 %
Output of external power supply (AC)	–	–	8,5 VA
Output of external power supply (DC)	4,5 W	4,5 W	5 W
Frequency range AC	–	–	50 - 60 Hz
Residual ripple DC	160 %	160 %	160 %
Duty cycle	100 %	100 %	100 %
Max. inrush current impulse			
Current pulse, A1	5 A	5 A	–
Pulse duration, A1	1 ms	1 ms	–
Inputs	787520	787522	787530
Number	2	2	2
Voltage at			
Input circuit DC	24 V	24 V	24 V
Start circuit DC	24 V	24 V	24 V
Feedback loop DC	24 V	24 V	24 V
Current at			
Input circuit DC	50 mA	50 mA	40 mA
Start circuit DC	40 mA	40 mA	40 mA
Feedback loop DC	3 mA	3 mA	3 mA

Inputs	787520	787522	787530
Max. overall cable resistance R _{lmax}			
Single-channel at UB DC	100 Ohm	100 Ohm	150 Ohm
Single-channel at UB AC	–	–	150 Ohm
Dual-channel without detection of shorts across contacts at UB DC	120 Ohm	120 Ohm	200 Ohm
Dual-channel without detection of shorts across contacts at UB AC	–	–	200 Ohm
Dual-channel with detection of shorts across contacts at UB DC	10 Ohm	10 Ohm	20 Ohm
Dual-channel with detection of shorts across contacts at UB AC	–	–	20 Ohm
Relay outputs	787520	787522	787530
Number of output contacts			
Safety contacts (N/O), instantaneous	3	3	3
Safety contacts (N/O), delayed	2	2	2
Auxiliary contacts (N/C)	1	1	1
Max. short circuit current I _K	1 kA	1 kA	1 kA
Utilisation category			
In accordance with the standard	EN 60947-4-1	EN 60947-4-1	EN 60947-4-1
Utilisation category of safety contacts			
AC1 at	240 V	240 V	240 V
Min. current	0,01 A	0,01 A	0,01 A
Max. current	8 A	8 A	8 A
Max. power	2000 VA	2000 VA	2000 VA
DC1 at	24 V	24 V	24 V
Min. current	0,01 A	0,01 A	0,01 A
Max. current	8 A	8 A	8 A
Max. power	200 W	200 W	200 W

Relay outputs	787520	787522	787530
Utilisation category of safety contacts delayed			
AC1 at	240 V	240 V	240 V
Min. current	0,01 A	0,01 A	0,01 A
Max. current	8 A	8 A	8 A
Max. power	2000 VA	2000 VA	2000 VA
DC1 at	24 V	24 V	24 V
Min. current	0,01 A	0,01 A	0,01 A
Max. current	8 A	8 A	8 A
Max. power	200 W	200 W	200 W
Utilisation category of auxiliary contacts			
AC1 at	240 V	240 V	240 V
Min. current	0,01 A	0,01 A	0,01 A
Max. current	8 A	8 A	8 A
Max. power	2000 VA	2000 VA	2000 VA
DC1 at	24 V	24 V	24 V
Min. current	0,01 A	0,01 A	0,01 A
Max. current	8 A	8 A	8 A
Max. power	200 W	200 W	200 W
Utilisation category			
In accordance with the standard	EN 60947-5-1	EN 60947-5-1	EN 60947-5-1
Utilisation category of safety contacts			
AC15 at	230 V	230 V	230 V
Max. current	5 A	5 A	5 A
DC13 (6 cycles/min) at	24 V	24 V	24 V
Max. current	7 A	7 A	7 A
Utilisation category of safety contacts delayed			
AC15 at	230 V	230 V	230 V
Max. current	5 A	5 A	5 A
DC13 (6 cycles/min) at	24 V	24 V	24 V
Max. current	7 A	7 A	7 A
Utilisation category of auxiliary contacts			
AC15 at	230 V	230 V	230 V
Max. current	5 A	5 A	5 A
DC13 (6 cycles/min) at	24 V	24 V	24 V
Max. current	7 A	7 A	7 A

Relay outputs	787520	787522	787530
Utilisation category in accordance with UL			
Voltage	240 V AC G. P.	240 V AC G. P.	240 V AC G. P.
With current	8 A	8 A	8 A
Voltage	24 V DC Resistive	24 V DC Resistive	24 V DC Resistive
With current	5 A	5 A	5 A
Pilot Duty	C300, R300	C300, R300	C300, R300
External contact fuse protection, safety contacts			
In accordance with the standard	EN 60947-5-1	EN 60947-5-1	EN 60947-5-1
Max. melting integral	240 A²s	240 A²s	240 A²s
Blow-out fuse, quick	10 A	10 A	10 A
Blow-out fuse, slow	6 A	6 A	6 A
Blow-out fuse, gG	10 A	10 A	10 A
Circuit breaker 24V AC/DC, characteristic B/C	6 A	6 A	6 A
External contact fuse protection, delayed safety contacts			
Max. melting integral	240 A²s	240 A²s	240 A²s
Blow-out fuse, quick	10 A	10 A	10 A
Blow-out fuse, slow	6 A	6 A	6 A
Blow-out fuse, gG	10 A	10 A	10 A
Circuit breaker 24 V AC/DC, characteristic B/C	6 A	6 A	6 A
External contact fuse protection, auxiliary contacts			
Max. melting integral	240 A²s	240 A²s	240 A²s
Blow-out fuse, quick	10 A	10 A	10 A
Blow-out fuse, slow	6 A	6 A	6 A
Blow-out fuse, gG	10 A	10 A	10 A
Circuit breaker 24 V AC/DC, characteristic B/C	6 A	6 A	6 A
Contact material	AgSnO₂ + 0,2 µm Au	AgSnO₂ + 0,2 µm Au	AgSnO₂ + 0,2 µm Au

Conventional thermal current while loading several contacts	787520	787522	787530
Ith per contact at UB AC; AC1: 240 V, DC1: 24 V			
Conv. therm. current with 1 contact	–	–	8 A
Conv. therm. current with 2 contacts	–	–	7,8 A
Conv. therm. current with 3 contacts	–	–	6,5 A
Conv. therm. current with 4 contacts	–	–	5,5 A
Conv. therm. current with 5 contacts	–	–	5 A
Ith per contact at UB DC; AC1: 240 V, DC1: 24 V			
Conv. therm. current with 1 contact	8 A	8 A	8 A
Conv. therm. current with 2 contacts	7,8 A	7,8 A	7,8 A
Conv. therm. current with 3 contacts	6,5 A	6,5 A	6,5 A
Conv. therm. current with 4 contacts	5,5 A	5,5 A	5,5 A
Conv. therm. current with 5 contacts	5 A	5 A	5 A
Times	787520	787522	787530
Switch-on delay			
With automatic start typ.	400 ms	400 ms	400 ms
With automatic start max.	850 ms	850 ms	550 ms
With automatic start after power on typ.	400 ms	400 ms	750 ms
With automatic start after power on max.	870 ms	870 ms	1.050 ms
With monitored start typ.	40 ms	40 ms	35 ms
With monitored start max.	70 ms	70 ms	60 ms

Times	787520	787522	787530
Delay-on de-energisation			
With E-STOP typ.	15 ms	15 ms	15 ms
With E-STOP max.	30 ms	30 ms	30 ms
With power failure typ.	110 ms	110 ms	–
With power failure max.	150 ms	150 ms	–
With power failure typ. UB 240 V	–	–	900 ms
With power failure max. UB 240 V	–	–	1400 ms
With power failure typ. UB 24 V	–	–	120 ms
With power failure max. UB 24 V	–	–	170 ms
Recovery time at max. switching frequency 1/s			
After E-STOP	50 ms +tv	50 ms +tv	50 ms +tv
After power failure	200 ms	200 ms	–
After power failure on wide-range power supply	–	–	1450 ms
Delay time tv	0,1 s, 0,5 s, 1 s, 2 s, 4 s, 6 s, 8 s, 10 s, 15 s, 20 s, 25 s, 30 s	0,1 s, 0,2 s, 0,3 s, 0,4 s, 0,5 s, 0,6 s, 0,7 s, 0,8 s, 1 s, 1,5 s, 2 s, 3 s	0,1 s, 0,5 s, 1 s, 2 s, 4 s, 6 s, 8 s, 10 s, 15 s, 20 s, 25 s, 30 s
Time accuracy	-15 %/+15 % +50 ms	-15 %/+15 % +50 ms	-15 %/+15 % +50 ms
Repetition accuracy	2 %	2 %	2 %
Waiting period with a monitored start	300 ms	300 ms	300 ms
Min. start pulse duration with a monitored start	30 ms	30 ms	30 ms
Supply interruption before de-energisation	20 ms	20 ms	20 ms
Simultaneity, channel 1 and 2 max.	∞	∞	∞
Environmental data			
Climatic suitability	EN 60068-2-78	EN 60068-2-78	EN 60068-2-78
Ambient temperature			
Temperature range	-10 - 55 °C	-10 - 55 °C	-10 - 55 °C
Storage temperature			
Temperature range	-40 - 85 °C	-40 - 85 °C	-40 - 85 °C
Climatic suitability			
Humidity	93 % r. h. at 40 °C	93 % r. h. at 40 °C	93 % r. h. at 40 °C
Condensation during operation	Not permitted	Not permitted	Not permitted
EMC			
	EN 60947-5-1, EN 61000-6-2, EN 61326-3-1	EN 60947-5-1, EN 61000-6-2, EN 61326-3-1	EN 60947-5-1, EN 61000-6-2, EN 61000-6-4, EN 61326-3-1

Environmental data	787520	787522	787530
Vibration			
In accordance with the standard	EN 60068-2-6	EN 60068-2-6	EN 60068-2-6
Frequency	10 - 55 Hz	10 - 55 Hz	10 - 55 Hz
Amplitude	0,35 mm	0,35 mm	0,35 mm
Airgap creepage			
In accordance with the standard	EN 60947-1	EN 60947-1	EN 60947-1
Overvoltage category	III / II	III / II	III / II
Pollution degree	2	2	2
Rated insulation voltage	250 V	250 V	250 V
Rated impulse withstand voltage	4 kV	4 kV	4 kV
Protection type			
Housing	IP40	IP40	IP40
Terminals	IP20	IP20	IP20
Mounting area (e.g. control cabinet)	IP54	IP54	IP54
Mechanical data	787520	787522	787530
Mounting position	Any	Any	Any
Mechanical life	10,000,000 cycles	10,000,000 cycles	10,000,000 cycles
Material			
Bottom	PPO UL 94 V0	PPO UL 94 V0	PPO UL 94 V0
Front	ABS UL 94 V0	ABS UL 94 V0	ABS UL 94 V0
Top	PPO UL 94 V0	PPO UL 94 V0	PPO UL 94 V0
Connection type	Spring-loaded terminal	Spring-loaded terminal	Spring-loaded terminal
Mounting type	plug-in	plug-in	plug-in
Conductor cross section with spring-loaded terminals: Flexible with/without crimp connector	0,2 - 1,5 mm², 24 - 16 AWG	0,2 - 1,5 mm², 24 - 16 AWG	0,2 - 1,5 mm², 24 - 16 AWG
Spring-loaded terminals: Terminal points per connection	2	2	2
Stripping length with spring-loaded terminals	8 mm	8 mm	8 mm
Dimensions			
Height	101 mm	101 mm	101 mm
Width	90 mm	90 mm	90 mm
Depth	121 mm	121 mm	121 mm
Weight	510 g	510 g	535 g

Where standards are undated, the 2020-07 latest editions shall apply.

Technical details Order no. 787532-787538

General	787532	787538
Certifications	CCC, CE, EAC (Eurasian), TÜV, cULus Listed	CCC, CE, EAC (Eurasian), TÜV, cULus Listed
Electrical data	787532	787538
Supply voltage		
Voltage	24 - 240 V	24 - 240 V
Kind	AC/DC	AC/DC
Voltage tolerance	-15 %/+10 %	-15 %/+10 %
Output of external power supply (AC)	8,5 VA	8,5 VA
Output of external power supply (DC)	5 W	5 W
Frequency range AC	50 - 60 Hz	50 - 60 Hz
Residual ripple DC	160 %	160 %
Duty cycle	100 %	100 %
Inputs	787532	787538
Number	2	2
Voltage at		
Input circuit DC	24 V	24 V
Start circuit DC	24 V	24 V
Feedback loop DC	24 V	24 V
Current at		
Input circuit DC	40 mA	40 mA
Start circuit DC	40 mA	40 mA
Feedback loop DC	3 mA	3 mA
Max. overall cable resistance RI-max		
Single-channel at UB DC	150 Ohm	150 Ohm
Single-channel at UB AC	150 Ohm	150 Ohm
Dual-channel without detection of shorts across contacts at UB DC	200 Ohm	200 Ohm
Dual-channel without detection of shorts across contacts at UB AC	200 Ohm	200 Ohm
Dual-channel with detection of shorts across contacts at UB DC	20 Ohm	20 Ohm
Dual-channel with detection of shorts across contacts at UB AC	20 Ohm	20 Ohm
Relay outputs	787532	787538
Number of output contacts		
Safety contacts (N/O), instantaneous	3	3
Safety contacts (N/O), delayed	2	2
Auxiliary contacts (N/C)	1	1
Max. short circuit current IK	1 kA	1 kA

Relay outputs	787532	787538
Utilisation category		
In accordance with the standard	EN 60947-4-1	EN 60947-4-1
Utilisation category of safety con- tacts		
AC1 at	240 V	240 V
Min. current	0,01 A	0,01 A
Max. current	8 A	8 A
Max. power	2000 VA	2000 VA
DC1 at	24 V	24 V
Min. current	0,01 A	0,01 A
Max. current	8 A	8 A
Max. power	200 W	200 W
Utilisation category of safety con- tacts delayed		
AC1 at	240 V	240 V
Min. current	0,01 A	0,01 A
Max. current	8 A	8 A
Max. power	2000 VA	2000 VA
DC1 at	24 V	24 V
Min. current	0,01 A	0,01 A
Max. current	8 A	8 A
Max. power	200 W	200 W
Utilisation category of auxiliary con- tacts		
AC1 at	240 V	240 V
Min. current	0,01 A	0,01 A
Max. current	8 A	8 A
Max. power	2000 VA	2000 VA
DC1 at	24 V	24 V
Min. current	0,01 A	0,01 A
Max. current	8 A	8 A
Max. power	200 W	200 W
Utilisation category		
In accordance with the standard	EN 60947-5-1	EN 60947-5-1
Utilisation category of safety con- tacts		
AC15 at	230 V	230 V
Max. current	5 A	5 A
DC13 (6 cycles/min) at	24 V	24 V
Max. current	7 A	7 A
Utilisation category of safety con- tacts delayed		
AC15 at	230 V	230 V
Max. current	5 A	5 A
DC13 (6 cycles/min) at	24 V	24 V
Max. current	7 A	7 A

Relay outputs	787532	787538
Utilisation category of auxiliary contacts		
AC15 at	230 V	230 V
Max. current	5 A	5 A
DC13 (6 cycles/min) at	24 V	24 V
Max. current	7 A	7 A
Utilisation category in accordance with UL		
Voltage	240 V AC G. P.	240 V AC G. P.
With current	8 A	8 A
Voltage	24 V DC Resistive	24 V DC Resistive
With current	5 A	5 A
Pilot Duty	C300, R300	C300, R300
External contact fuse protection, safety contacts		
In accordance with the standard	EN 60947-5-1	EN 60947-5-1
Max. melting integral	240 A²s	240 A²s
Blow-out fuse, quick	10 A	10 A
Blow-out fuse, slow	6 A	6 A
Blow-out fuse, gG	10 A	10 A
Circuit breaker 24V AC/DC, characteristic B/C	6 A	6 A
External contact fuse protection, delayed safety contacts		
Max. melting integral	240 A²s	240 A²s
Blow-out fuse, quick	10 A	10 A
Blow-out fuse, slow	6 A	6 A
Blow-out fuse, gG	10 A	10 A
Circuit breaker 24 V AC/DC, characteristic B/C	6 A	6 A
External contact fuse protection, auxiliary contacts		
Max. melting integral	240 A²s	240 A²s
Blow-out fuse, quick	10 A	10 A
Blow-out fuse, slow	6 A	6 A
Blow-out fuse, gG	10 A	10 A
Circuit breaker 24 V AC/DC, characteristic B/C	6 A	6 A
Contact material	AgSnO₂ + 0,2 µm Au	AgSnO₂ + 0,2 µm Au

Conventional thermal current while loading several contacts	787532	787538
Ith per contact at UB AC; AC1: 240 V, DC1: 24 V		
Conv. therm. current with 1 contact	8 A	8 A
Conv. therm. current with 2 contacts	7,8 A	7,8 A
Conv. therm. current with 3 contacts	6,5 A	6,5 A
Conv. therm. current with 4 contacts	5,5 A	5,5 A
Conv. therm. current with 5 contacts	5 A	5 A
Ith per contact at UB DC; AC1: 240 V, DC1: 24 V		
Conv. therm. current with 1 contact	8 A	8 A
Conv. therm. current with 2 contacts	7,8 A	7,8 A
Conv. therm. current with 3 contacts	6,5 A	6,5 A
Conv. therm. current with 4 contacts	5,5 A	5,5 A
Conv. therm. current with 5 contacts	5 A	5 A
Times	787532	787538
Switch-on delay		
With automatic start typ.	400 ms	400 ms
With automatic start max.	550 ms	550 ms
With automatic start after power on typ.	750 ms	750 ms
With automatic start after power on max.	1.050 ms	1.050 ms
With monitored start typ.	35 ms	35 ms
With monitored start max.	60 ms	60 ms
Delay-on de-energisation		
With E-STOP typ.	15 ms	15 ms
With E-STOP max.	30 ms	30 ms
With power failure typ. UB 240 V	900 ms	900 ms
With power failure max. UB 240 V	1400 ms	1400 ms
With power failure typ. UB 24 V	120 ms	120 ms
With power failure max. UB 24 V	170 ms	170 ms
Recovery time at max. switching frequency 1/s		
After E-STOP	50 ms +tv	50 ms +tv
After power failure on wide-range power supply	1450 ms	1450 ms

Times	787532	787538
Delay time tv	0,1 s, 0,2 s, 0,3 s, 0,4 s, 0,5 s, 0,6 s, 0,7 s, 0,8 s, 1 s, 1,5 s, 2 s, 3 s	0,3 s, 5 s, 10 s, 20 s, 40 s, 60 s, 80 s, 100 s, 150 s, 200 s, 250 s, 300 s
Time accuracy	-15 %/+15 % +50 ms	-15 %/+15 % +50 ms
Repetition accuracy	2 %	2 %
Waiting period with a monitored start	300 ms	300 ms
Min. start pulse duration with a monitored start	30 ms	30 ms
Supply interruption before de-energisation	20 ms	20 ms
Simultaneity, channel 1 and 2 max.	∞	∞
Environmental data	787532	787538
Climatic suitability	EN 60068-2-78	EN 60068-2-78
Ambient temperature		
Temperature range	-10 - 55 °C	-10 - 55 °C
Storage temperature		
Temperature range	-40 - 85 °C	-40 - 85 °C
Climatic suitability		
Humidity	93 % r. h. at 40 °C	93 % r. h. at 40 °C
Condensation during operation	Not permitted	Not permitted
EMC	EN 60947-5-1, EN 61000-6-2, EN 61000-6-4, EN 61326-3-1	EN 60947-5-1, EN 61000-6-2, EN 61000-6-4, EN 61326-3-1
Vibration		
In accordance with the standard	EN 60068-2-6	EN 60068-2-6
Frequency	10 - 55 Hz	10 - 55 Hz
Amplitude	0,35 mm	0,35 mm
Airgap creepage		
In accordance with the standard	EN 60947-1	EN 60947-1
Overvoltage category	III / II	III / II
Pollution degree	2	2
Rated insulation voltage	250 V	250 V
Rated impulse withstand voltage	4 kV	4 kV
Protection type		
Housing	IP40	IP40
Terminals	IP20	IP20
Mounting area (e.g. control cabinet)	IP54	IP54
Mechanical data	787532	787538
Mounting position	Any	Any
Mechanical life	10,000,000 cycles	10,000,000 cycles
Material		
Bottom	PPO UL 94 V0	PPO UL 94 V0
Front	ABS UL 94 V0	ABS UL 94 V0
Top	PPO UL 94 V0	PPO UL 94 V0
Connection type	Spring-loaded terminal	Spring-loaded terminal

Mechanical data	787532	787538
Mounting type	plug-in	plug-in
Conductor cross section with spring-loaded terminals: Flexible with/without crimp connector	0,2 - 1,5 mm², 24 - 16 AWG	0,2 - 1,5 mm², 24 - 16 AWG
Spring-loaded terminals: Terminal points per connection	2	2
Stripping length with spring-loaded terminals	8 mm	8 mm
Dimensions		
Height	101 mm	101 mm
Width	90 mm	90 mm
Depth	121 mm	121 mm
Weight	535 g	535 g

Where standards are undated, the 2020-07 latest editions shall apply.

Safety characteristic data



NOTICE

You must comply with the safety characteristic data in order to achieve the required safety level for your plant/machine.

Operating mode	EN ISO 13849-1: 2015 PL	EN ISO 13849-1: 2015 Category	EN 62061 SIL CL	EN 62061 PFH _D [1/h]	EN ISO 13849-1: 2015 T _M [year]
Safety contacts, instantaneous	PL e	Cat. 4	SIL CL 3	2,31E-09	20
Safety contacts, delayed <30 s	PL d	Cat. 3	SIL CL 3	2,64E-09	20
Safety contacts, delayed ≥30 s	PL c	Cat. 1	SIL CL 1	2,87E-09	20

Explanatory notes for the safety-related characteristic data:

- ▶ The SIL CL value in accordance with EN 62061 corresponds to the SIL value in accordance with EN 61508.
- ▶ T_M is the maximum mission time in accordance with EN ISO 13849-1. The value also applies as the retest interval in accordance with EN 61508-6 and IEC 61511 and as the proof test interval and mission time in accordance with EN 62061.

All the units used within a safety function must be considered when calculating the safety characteristic data.



INFORMATION

A safety function's SIL/PL values are **not** identical to the SIL/PL values of the units that are used and may be different. We recommend that you use the PASCAL software tool to calculate the safety function's SIL/PL values.

Supplementary data



CAUTION!

It is essential to consider the relay's service life graphs. The relay outputs' safety-related characteristic data is only valid if the values in the service life graphs are met.

The PFH value depends on the switch frequency and the load of the relay output. If the service life graphs are not accessible, the stated PFH value can be used irrespective of the switch frequency and the load, as the PFH value already considers the relay's B10d value as well as the failure rates of the other components.

Service life graph

The service life graphs indicate the number of cycles from which failures due to wear must be expected. The wear is mainly caused by the electrical load; the mechanical load is negligible.

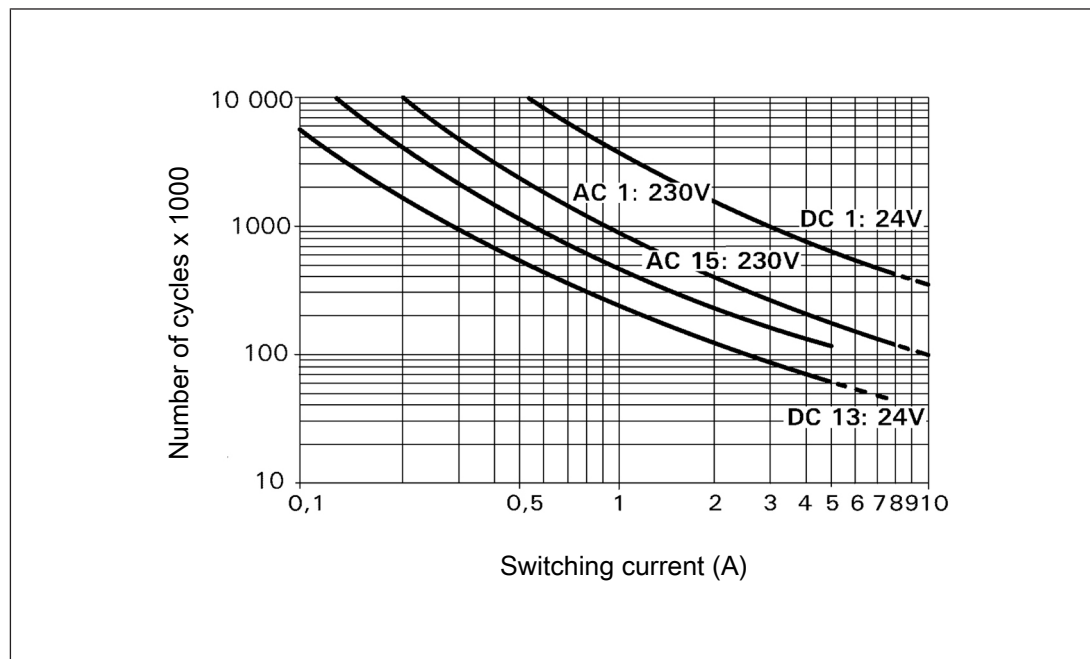

Example

- ▶ Inductive load: 0.2 A
- ▶ Utilisation category: AC15
- ▶ Contact service life: 4 000 000 cycles

Provided the application to be implemented requires fewer than 4 000 000 cycles, the PFH value (see Technical details) can be used in the calculation.

To increase the service life, sufficient spark suppression must be provided on all output contacts. With capacitive loads, any power surges that occur must be noted. With DC contacts, use flywheel diodes for spark suppression.

Remove plug-in terminals

Procedure: Insert the screwdriver into the housing recess behind the terminal and lever the terminal out.

Do **not** remove the terminals by pulling the cables!

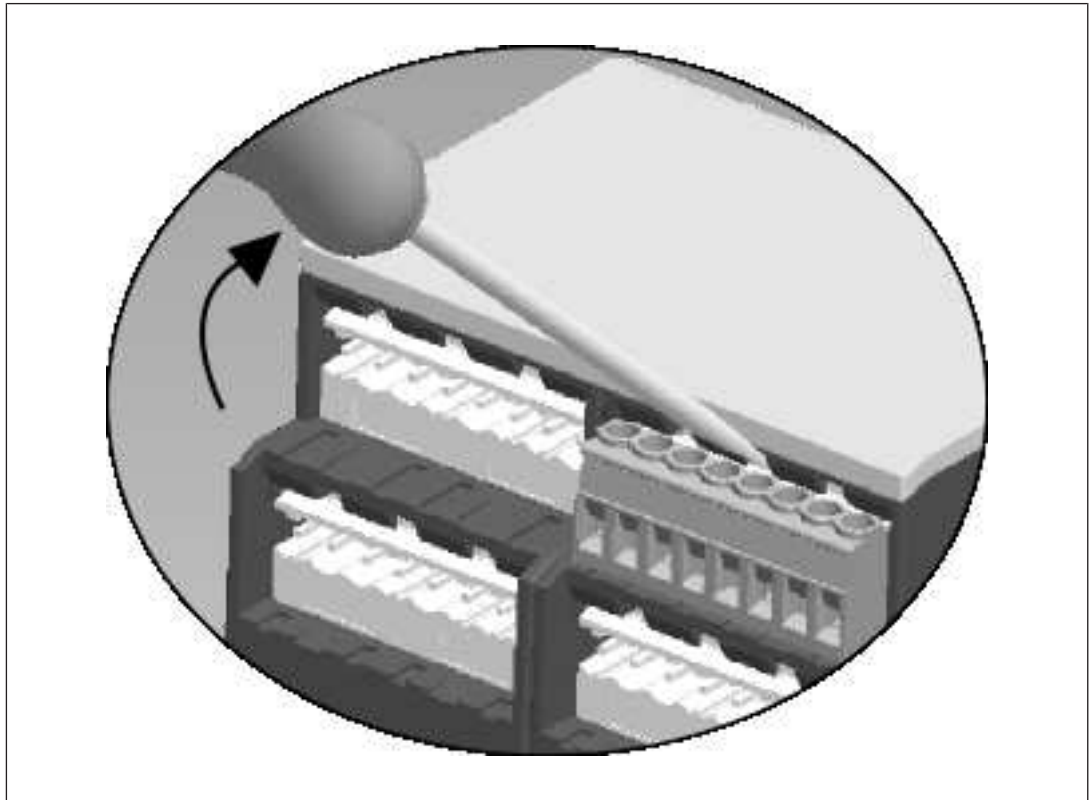

Order reference

Product type	Features	Connection type	Order no.
PNOZ XV3.1P	24 VDC; Delay: up to 3 s selectable	Screw terminals	777522
PNOZ XV3.1P C	24 VDC; Delay: up to 3 s selectable	Spring-loaded terminals	787522
PNOZ XV3.1P	24 VDC; Delay: 3 s fixed	Screw terminals	777525
PNOZ XV3.1P	24 VDC; Delay: up to 30 s selectable	Screw terminals	777520
PNOZ XV3.1P C	24 VDC; Delay: up to 30 s selectable	Spring-loaded terminals	787520
PNOZ XV3.1P	24 - 240 VAC/DC; Delay: up to 3 s selectable	Screw terminals	777532
PNOZ XV3.1P C	24 - 240 VAC/DC; Delay: up to 3 s selectable	Spring-loaded terminals	787532
PNOZ XV3.1P	24 - 240 VAC/DC; Delay: up to 30 s selectable	Screw terminals	777530
PNOZ XV3.1P C	24 - 240 VAC/DC; Delay: up to 30 s selectable	Spring-loaded terminals	787530
PNOZ XV3.1P	24 - 240 VAC/DC; Delay: up to 300 s selectable	Screw terminals	777538
PNOZ XV3.1P C	24 - 240 VAC/DC; Delay: up to 300 s selectable	Spring-loaded terminals	787538

EC declaration of conformity

This product/these products meet the requirements of the directive 2006/42/EC for machinery of the European Parliament and of the Council. The complete EC Declaration of Conformity is available on the Internet at www.pilz.com/support/downloads.

Representative: Norbert Fröhlich, Pilz GmbH & Co. KG, Felix-Wankel-Str. 2, 73760 Ostfildern, Germany

► Support

Technical support is available from Pilz round the clock.

Americas

Brazil
+55 11 97569-2804

Canada
+1 888 315 7459

Mexico
+52 55 5572 1300

USA (toll-free)
+1 877-PILZUSA (745-9872)

Asia

China
+86 21 60880878-216

Japan
+81 45 471-2281

South Korea
+82 31 778 3300

Australia

+61 3 95600621

Europe

Austria
+43 1 7986263-0

Belgium, Luxembourg
+32 9 3217570

France
+33 3 88104003

Germany
+49 711 3409-444

Ireland
+353 21 4804983

Italy, Malta
+39 0362 1826711

Scandinavia

+45 74436332

Spain

+34 938497433

Switzerland

+41 62 88979-32

The Netherlands

+31 347 320477

Turkey

+90 216 5775552

United Kingdom

+44 1536 462203

You can reach our international hotline on:

+49 711 3409-444
support@pilz.com

Pilz develops environmentally-friendly products using ecological materials and energy-saving technologies. Offices and production facilities are ecologically designed, environmentally-aware and energy-saving. So Pilz offers sustainability, plus the security of using energy-efficient products and environmentally-friendly solutions.

Energy
saving by Pilz



We are represented internationally. Please refer to our homepage www.pilz.com for further details or contact our headquarters.

Headquarters: Pilz GmbH & Co. KG, Felix-Wankel-Straße 2, 73760 Ostfildern, Germany
Telephone: +49 711 3409-0, Telefax: +49 711 3409-133, E-Mail: info@pilz.com, Internet: www.pilz.com

PILZ
THE SPIRIT OF SAFETY

201516-EN-09, 2020-10 Printed in Germany
© Pilz GmbH & Co. KG, 2019

CECC® , CHRE® , CMSE® , InduraNET p® , Leansafe® , Master of Safety® , Master of Security® , PAS4000® , PAScall® , PASconfig® , Pilz® , PTT® , PLID® , PMCPirimo® , PMCPiritego® , PMCTendo® , PMD® , PMJ® , PNOZ® , PRBT® , PRCM® , PRCM® , PSEN® , PSEN® , PSEN® , PSENET p® , SafetyBUS p® , SafetyEYE® , SafetyNET p® , THE SPIRIT OF SAFETY® are registered and protected trademarks of Pilz GmbH & Co. KG in some countries. We would point out that product features may vary from the details stated in this document, depending on the status at the time of publication and the scope of the equipment. We accept no responsibility for the validity, accuracy and entirety of the text and graphics presented in this information. Please contact our Technical Support if you have any questions.