



Visualisation; Diagnostics

Easy to Configure

Programming IEC 61131-3

Rapid Installation

PNOZ e1p

► Safety relays

PILZ
THE SPIRIT OF SAFETY

This document is a translation of the original document.

All rights to this documentation are reserved by Pilz GmbH & Co. KG. Copies may be made for internal purposes. Suggestions and comments for improving this documentation will be gratefully received.

Source code from third-party manufacturers or open source software has been used for some components. The relevant licence information is available on the Internet on the Pilz homepage.

Pilz®, PIT®, PMI®, PNOZ®, Primo®, PSEN®, PSS®, PVIS®, SafetyBUS p®, SafetyEYE®, SafetyNET p®, the spirit of safety® are registered and protected trademarks of Pilz GmbH & Co. KG in some countries.



SD means Secure Digital

Introduction	5
Validity of documentation	5
Using the documentation	5
Definition of symbols	5
Safety	6
Intended use	6
Safety regulations	6
Safety assessment	6
Use of qualified personnel	7
Warranty and liability	7
Disposal	7
Unit features	8
Safety features	8
Block diagram/terminal configuration	8
Function description	9
Operating modes	9
Selecting sensors	10
Installation	10
Wiring	11
Preparing for operation	12
Supply voltage	12
Input circuit	12
Start circuit	13
Logic connection between several units	14
Operation	15
Status indicators	15
Faults – Interference	16
Dimensions	21
Technical details	21
Safety characteristic data	24
Remove plug-in terminals	25

Order reference	25
Product	25
Accessories	25

Introduction

Validity of documentation

This documentation is valid for the product PNOZ e1p. It is valid until new documentation is published.

This operating manual explains the function and operation, describes the installation and provides guidelines on how to connect the product.

Using the documentation

This document is intended for instruction. Only install and commission the product if you have read and understood this document. The document should be retained for future reference.

Definition of symbols

Information that is particularly important is identified as follows:



DANGER!

This warning must be heeded! It warns of a hazardous situation that poses an immediate threat of serious injury and death and indicates preventive measures that can be taken.



WARNING!

This warning must be heeded! It warns of a hazardous situation that could lead to serious injury and death and indicates preventive measures that can be taken.



CAUTION!

This refers to a hazard that can lead to a less serious or minor injury plus material damage, and also provides information on preventive measures that can be taken.



NOTICE

This describes a situation in which the product or devices could be damaged and also provides information on preventive measures that can be taken. It also highlights areas within the text that are of particular importance.

**INFORMATION**

This gives advice on applications and provides information on special features.

Safety**Intended use**

The safety relay PNOZ e1p provides a safety-related interruption of a safety circuit.

The safety relay meets the requirements of EN 60947-5-1, EN 60204-1 and VDE 0113-1 and may be used in applications with

- ▶ E-STOP pushbuttons
- ▶ Safety gates
- ▶ Light grids and safety switches with detection of shorts across contacts

The following is deemed improper use in particular:

- ▶ Any component, technical or electrical modification to the product
- ▶ Use of the product outside the areas described in this manual
- ▶ Use of the product outside the technical details (see [Technical details](#)  21)).

**NOTICE****EMC-compliant electrical installation**

The product is designed for use in an industrial environment. The product may cause interference if installed in other environments. If installed in other environments, measures should be taken to comply with the applicable standards and directives for the respective installation site with regard to interference.

Safety regulations**Safety assessment**

Before using a unit it is necessary to perform a safety assessment in accordance with the Machinery Directive.

Functional safety is guaranteed for the product as a single component. However, this does not guarantee the functional safety of the overall plant/machine. In order to achieve the required safety level for the overall plant/machine, define the safety requirements for the plant/machine and then define how these must be implemented from a technical and organisational standpoint.

Use of qualified personnel

The products may only be assembled, installed, programmed, commissioned, operated, maintained and decommissioned by competent persons.

A competent person is a qualified and knowledgeable person who, because of their training, experience and current professional activity, has the specialist knowledge required. To be able to inspect, assess and operate devices, systems and machines, the person has to be informed of the state of the art and the applicable national, European and international laws, directives and standards.

It is the company's responsibility only to employ personnel who

- ▶ Are familiar with the basic regulations concerning health and safety / accident prevention,
- ▶ Have read and understood the information provided in this description under "Safety"
- ▶ Have a good knowledge of the generic and specialist standards applicable to the specific application.

Warranty and liability

All claims to warranty and liability will be rendered invalid if

- ▶ The product was used contrary to the purpose for which it is intended
- ▶ Damage can be attributed to not having followed the guidelines in the manual
- ▶ Operating personnel are not suitably qualified
- ▶ Any type of modification has been made (e.g. exchanging components on the PCB boards, soldering work etc.).

Disposal

- ▶ In safety-related applications, please comply with the mission time T_M in the safety-related characteristic data.
- ▶ When decommissioning, please comply with local regulations regarding the disposal of electronic devices (e.g. Electrical and Electronic Equipment Act).

Unit features

- ▶ Outputs using semiconductor technology:
 - 2 safety outputs
 - 1 auxiliary output
 - 2 test pulse outputs
- ▶ Connection options:
 - E-STOP pushbuttons
 - Safety gate limit switches
 - Start button
 - Proximity switch
- ▶ To process signals from output signal switching devices (OSSDs) on light grids
- ▶ LED display for:
 - Supply voltage
 - Switch status of the safety contacts
- ▶ Detection of shorts across contacts via test pulse outputs

Safety features

The relay meets the following safety requirements:

- ▶ The circuit is redundant with built-in self-monitoring.
- ▶ The safety device remains effective in the case of a component failure.
- ▶ The safety outputs are tested periodically using an off-test.

Block diagram/terminal configuration

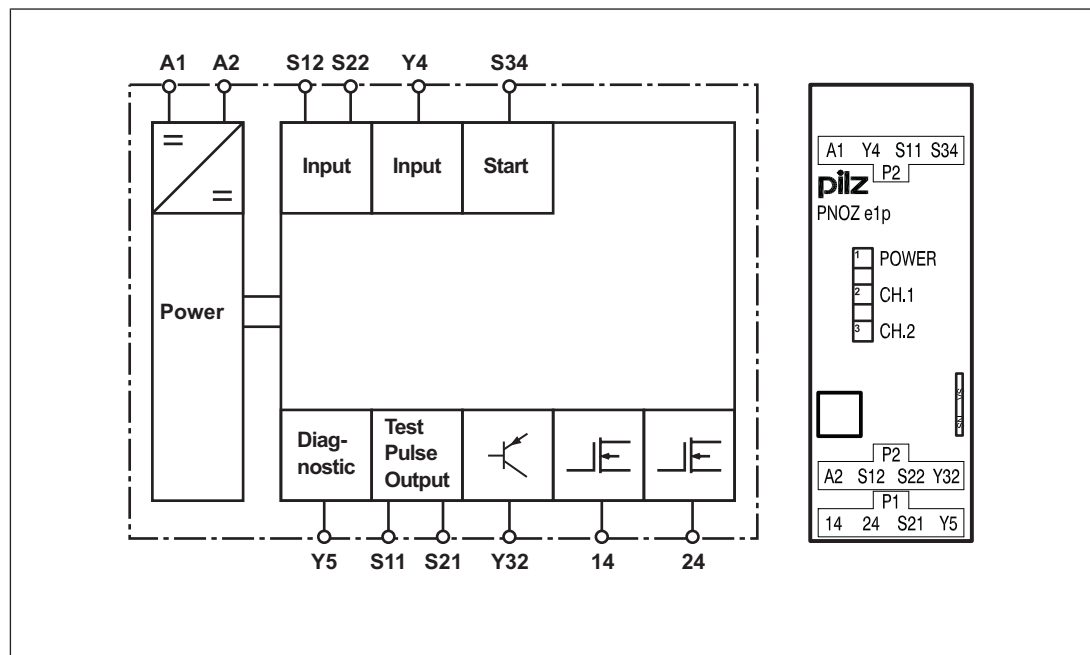

Function description

When supply voltage is applied and the set operating mode is detected (initialisation phase), the "POWER" LED is lit. The unit is ready for operation.

- ▶ Input circuit is closed (e.g. E-STOP pushbutton not operated):
 - There are high signals at safety outputs 14 and 24 and auxiliary output Y32.
 - The LEDs "CH.1" and "CH.2" are lit.
- ▶ Input circuit is opened (e.g. E-STOP pushbutton operated):
 - There are low signals at safety outputs 14 and 24 and auxiliary output Y32.
 - The LEDs "CH.1" and "CH.2" go out.

Feedback loop

Feedback loop is connected in series to the start circuit. Before a safety output is switched on, a test is run to establish whether the contacts in the feedback loop are closed. If a contact is open, an error is detected and LEDs CH.1 and CH.2 will flash alternately. It will not be possible to switch the unit back on until the feedback loop is closed and the safety function has been reset.

With automatic start, the feedback loop contacts are also checked when the signal at the output changes from high to low. After this signal change, the feedback loop contacts must close within 150 ms. If a contact is still open after 150 ms has elapsed, an error is detected and is displayed as a flashing code 1,8 (see [Faults – Interference \[16\]](#)). It will not be possible to switch the unit back on until the error has been rectified and the supply voltage has been switched off and then on again.

Operating modes

- ▶ Single-channel operation: Input wiring in accordance with EN 60204, no redundancy in the input circuit; earth faults in the input circuit and start circuit are detected.
- ▶ Dual-channel operation: Redundant input circuit; earth faults in the input circuit and start circuit are detected, with or without detection of shorts between the pushbutton contacts.
- ▶ Automatic start: Unit is active once the input circuit has been closed.
- ▶ Monitored start: Unit is not active until the start button has been operated and then released.
- ▶ The start-up test prevents automatic restarting after a power failure and subsequent return of voltage. The unit checks whether the input circuit is opened and then closed when supply voltage is applied.
- ▶ Increase in the number of available contacts by connecting contact expander modules or external contactors/relays.

Selecting sensors

When selecting sensors, you must comply with the technical details of the input circuits on the PNOZelog units.

Please note:

- ▶ Sensors with mechanical contacts can be used in operating modes with or without detection of shorts across contacts, provided you comply with the technical details provided by the manufacturer. It is not always possible to use sensors with semiconductor outputs when operating with detection of shorts across contacts.
- ▶ Sensors with pulsed semiconductor outputs are only permitted if the PNOZelog is operated without detection of shorts across contacts.

Installation



CAUTION!

Electrostatic discharge can damage components on the safety system!

Ensure against discharge before touching the safety system, e.g. by touching an earthed, conductive surface or by wearing an earthed armband.

- ▶ The unit should be installed in a control cabinet with a protection type of at least IP54.
- ▶ Use the notch on the rear of the unit to attach it to a DIN rail (35 mm).
- ▶ When installed vertically: Secure the unit by using a fixing element (e.g. retaining bracket or end angle).



NOTICE

If you are connecting several units logically, please note the guidelines in the section entitled [Logic connection between several units](#) [📖 14].



Wiring

Please note:

- ▶ Information given in the "Technical details  21]" must be followed.
- ▶ Use copper wire that can withstand 60/75 °C.
- ▶ Calculation of the max. cable length l_{\max} in the input circuit:

$$l_{\max} = \frac{R_{l_{\max}}}{R_l / \text{km}}$$

$R_{l_{\max}}$ = max. overall cable resistance (see Technical details  21)
 R_l / km = cable resistance/km

- ▶ Cables that have to be laid outside the control cabinet must be protected from mechanical damage, e.g. by installing them in a conduit.
- ▶ The unit and the input circuits must always be supplied by a single power supply.
- ▶ Safety outputs 14 and 24 should exclusively be used for safe applications.
- ▶ The safety outputs must **not** be connected to control inputs.
- ▶ To suppress the pulse on switching off at safety outputs 14 and 24, use the terminal block with filter (see Order reference  25]).
- ▶ You must comply with the idling capacity at safety outputs 14 and 24 (see Technical details  21]).
- ▶ Output Y32 is an auxiliary output, e.g. for communication with a PLC or text display.
- ▶ Auxiliary output Y32 should **not** be used for safety circuits!
- ▶ Only contactors with positive-guided contacts should be used for safety functions.
- ▶ Use freewheel diodes to drive inductive loads (e.g. contactors or relays) with the safety/ auxiliary outputs.
- ▶ When connecting magnetically operated, reed proximity switches, ensure that the max. peak inrush current (on the input circuit) does not overload the proximity switch.
- ▶ The power supply must comply with the regulations for extra low voltages with protective electrical separation (SELV, PELV) in accordance with VDE 0100, Part 410.
- ▶ Ensure the wiring and EMC requirements of EN 60204-1 are met.
- ▶ Terminal Y5 is provided for Pilz-internal diagnostic purposes.

Preparing for operation

Supply voltage

Supply voltage	AC	DC
	/	

Input circuit

Connect the N/C contact from the trigger element (e.g. E-STOP) to the input circuit.

Input circuit	Single-channel	Dual-channel
E-STOP without detection of shorts across contacts		
E-STOP with detection of shorts across contacts	/	
Safety gate without detection of shorts across contacts		
Safety gate with detection of shorts across contacts	/	
Light guard or safety switch, detection of shorts across contacts via ESPE	/	

The E-STOP pushbutton and safety gate switch symbolise a trigger element with N/C / N/C combination.

Start circuit

Start circuit	without feedback loop monitoring	with feedback loop monitoring
Automatic start E-STOP wiring		
Automatic start Safety gate without start-up test		
Automatic start Safety gate with start-up test		



NOTICE
With automatic start

The unit starts up automatically when the safeguard is reset, e.g. when the E-STOP pushbutton is released. Use external circuit measures to prevent an unexpected restart.

Start circuit	without feedback loop monitoring	with feedback loop monitoring
Monitored start E-STOP wiring		
Monitored start Safety gate without start-up test		

K1 and K2 symbolise the contacts of the external contactors

Logic connection between several units

From Version 3.0, safety outputs on the PNOZ e1p can be logically linked to the safety inputs on other PNOZelog units.

Units from the PNOZelog product range can be logically connected to each other and to units from the PNOZmulti product range. On the PNOZelog, input S35 is intended for the logic OR connection and input S36 for the logic AND connection. Safety outputs 14 and 24 on the PNOZelog are suitable for logic connections.

When linking several units logically, please note:

- ▶ When PNOZelog units are linked logically to each other, a safety output from a PNOZelog unit may be connected to logic inputs from one or more PNOZelog units.
- ▶ When linking PNOZelog units logically to PNOZmulti units
 - a cascading output from PNOZmulti units may be connected to logic inputs on PNOZelog units
 - or
 - a safety output from PNOZelog units may be connected to cascading inputs on PNOZmulti units.
- ▶ The unit with the lowest SIL/PL value determines the SIL/PL value of the entire circuit.
- ▶ PNOZ e1p, PNOZ e8.1p: These units do not have logic inputs. Their safety outputs can be used to logically link the units to the logic inputs of other PNOZelog units or to the cascading inputs from PNOZmulti units.
- ▶ Safety outputs from the PNOZ e1p are suitable for logic connections from unit version 3.0.
- ▶ Each safety output on a PNOZelog unit that is connected to the load may also be connected to the logic inputs of a maximum of four PNOZelog units.
- ▶ Up to 50 logic inputs from PNOZelog units can be connected to safety outputs with no load.
- ▶ Logically linking the units leads to delays when switching on and off (see on-delay and response time in the [Technical details](#)  21]). These are added up with each unit that is logically linked.
- ▶ Install all the logically linked units in the same control cabinet or ensure that faults regarding the units' connection are excluded, e.g. via protected installation of the connection cables.
- ▶ All linked units must be connected to the same supply voltage.

Operation



NOTICE

The safety function should be checked after initial commissioning and each time the plant/machine is changed. The safety functions may only be checked by qualified personnel.



INFORMATION

The safety outputs are constantly checked via test pulses. This may generate a humming noise on the connected contactors, which does not affect the function. The test pulses also mean that, when measured with a multi-meter, the voltage at the safety outputs is displayed to be less than it actually is.

The unit detects the set operating mode once supply voltage is applied. During this time (initialisation phase) the "POWER" LED will flash. The unit is ready for operation when the "POWER" LED is lit continuously.

LEDs indicate the status and errors during operation:



LED on



LED flashes

Status indicators



POWER

Supply voltage is present, operating mode is detected.



POWER

Initialisation phase



CH.1

There is a high signal at safety output 14.



CH.2

There is a high signal at safety output 24.

Faults – Interference



INFORMATION

Supply interruptions lasting longer than 20 ms are detected as an error. The LEDs indicate an error and the safety outputs carry a low signal. The plant or machinery driven via the safety outputs will be shut down. The unit can only be restarted when the supply voltage is switched off for at least 1 s and then switched on again.

Fault

Fault conditions are indicated by flashing the LEDs. There are faults that are displayed via periodic flashing (see table "Display of fault conditions") and faults where an error code can be determined via the number of flashes (see table "Relationship between the number of flashes and the decimal error code"). These faults are always indicated by three short flashes at LED CH.1 or CH.2. After a longer pause, the LED will then flash at one second intervals. The number of LED flashes corresponds to a digit in the error code. The error code can consist of up to 4 digits. The digits are separated by a longer period without flashing. The entire sequence is constantly repeated.



INFORMATION

Error code 0: 16 flashes

Display of fault conditions

LED	Fault	Remedy
LEDs unlit	Supply voltage is missing, too low, wrongly connected	Connect supply voltage: A1 - +24 VDC and A2 - 0 VDC Permitted voltage range: 19.2 ... 30 VDC
POWER flashes	Unknown operating mode, initialisation phase, start not executed	Depending on operating mode: Press start button or perform start-up test
CH.1 or CH.2 flash a code	Error coding, see table "Error code [19]"	See table "Error code [19]"
CH.1 and CH.2 flash alternately	1.) Feedback loop open on start-up 2.) Only one channel of the input circuit is open or is partially operated	1.) Close feedback loop, open input circuit, start unit again 2.) Open both input circuit channels or activate and then clear the safety mat

Examples

Error code 1, 3:

LED CH.1 or CH.2 flashes

- ▶ 3 times, short
- ▶ Pause
- ▶ Once for one second
- ▶ Pause
- ▶ 3 times, for one second each

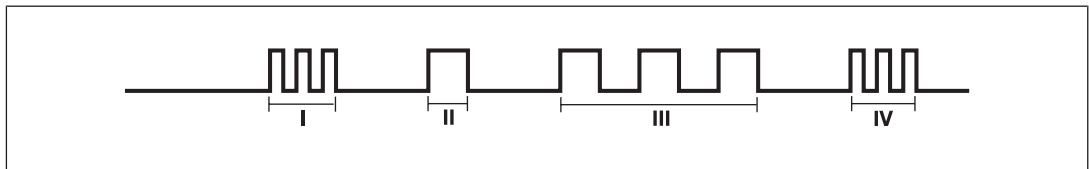

Error code 1:

LED CH.1 or CH.2 flashes

- ▶ 3 times, short
- ▶ Pause
- ▶ Once for one second

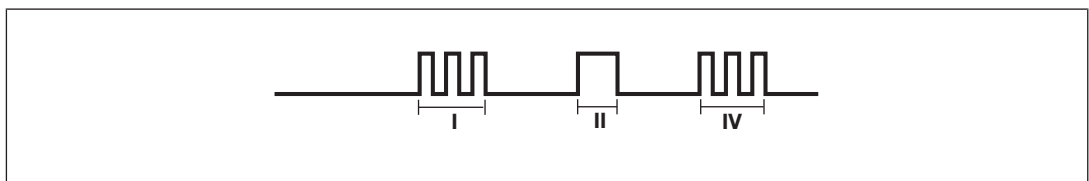

Error code 1, 0:
LED CH.1 or CH.2 flashes

- ▶ 3 times, short
- ▶ Pause
- ▶ Once for one second
- ▶ Pause
- ▶ 16 times, for one second each

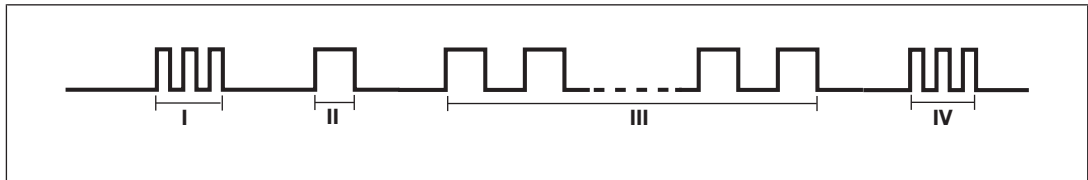

- I Code for error message
- II Code for 1st digit
- III Code for 2nd digit
- IV Code for error message repeated

The table below shows the relationship between the number of flashes and the error code. The key to the error codes is described in the Error coding table.

Number of flashes	1	2	3	4	5	6	7	8	9	10	11	12	13	14	15	16
Decimal error code	1	2	3	4	5	6	7	8	9	10	11	12	13	14	15	0

Error coding

**INFORMATION**

Each time a fault is rectified, switch the supply voltage off for at least 1 s and then switch it back on.

Decimal error code	Number of flashes	Description	Remedy
1	3x short – 1x long – 3x short	Faulty wiring, short circuit	Wiring error at start input, input circuits, feedback loop or programming input
2	3x short – 2x long – 3x short		
3	3x short – 3x long – 3x short	Operating mode changed during operation	Check wiring for the operating mode and rectify fault
4	3x short – 4x long – 3x short	In the initialisation phase, short circuit between the safety outputs and +24 VDC	Rectify wiring error at terminals 14, 24
...	...		
9	3x short – 9x long – 3x short		
10	3x short – 10x long – 3x short	During operation, short circuit between the safety outputs and +24 VDC	Rectify wiring error at terminals 14, 24
...	...		
1, 0	3x short – 1x long – 16x long – 3x short		
1, 1	3x short – 1x long – 1x long – 3x short		
1, 9	3x short – 1x long – 9x long – 3x short		
10.1	3x short – 10x long – 1x long – 3x short		
14.5	3x short – 14x long – 5x long – 3x short		
1, 2	3x short – 1x long – 2x long – 3x short	During operation, short circuit between the safety outputs and 0 VDC or $U_b < 19.2$ VDC	Rectify wiring error at terminals 14, 24; Keep within the supply voltage range of 19.2 ... 30 VDC
1, 3	3x short – 1x long – 3x long – 3x short		
1, 12	3x short – 1x long – 12x long – 3x short		
1, 13	3x short – 1x long – 13x long – 3x short		
1, 4	3x short – 1x long – 4x long – 3x short	Operating mode changed during operation	Check wiring for the operating mode and rectify fault

Decimal error code	Number of flashes	Description	Remedy
1, 5	3x short – 1x long – 5x long – 3x short	Unexpected status at S36	Check wiring at terminal S36
1, 6 1, 7	3x short – 1x long – 6x long – 3x short 3x short – 1x long – 7x long – 3x short	Wiring of operating mode “with detection of shorts across contacts” faulty	Rectify wiring error at input circuits
1, 8 1, 11	3x short – 1x long – 8x long – 3x short 3x short – 1x long – 11x long – 3x short	1. Maximum time of feedback loop monitoring exceeded 2. PNOZ e6.1p, PNOZ e6vp: External feedback loop closed, but internal feedback loop faulty	1. Check contactor for contact welding 2. No user remedy possible. Change the unit.
1, 10	3x short – 1x long – 10x long – 3x short	Open circuit	Check safety mat wiring
5, 10	3x short – 5x long – 10x long – 3x short	$U_B < 19.2$ VDC	Keep within the supply voltage range of 19.2 ... 30 VDC
8, 1	3x short – 8x long – 1x long – 3x short	Invalid operating mode	Check wiring for the operating mode and rectify fault
8, 2 8, 3 14, 13	3x short – 8x long – 2x long – 3x short 3x short – 8x long – 3x long – 3x short 3x short – 14x long – 13x long – 3x short	Supply interrupted, possibly caused by a short to earth	Rectify wiring error at terminal A1 or check supply voltage
2, 0, 0 2, 0, 1	3x short – 2x long – 16x long – 16x long – 3x short 3x short – 2x long – 16x long – 1x long – 3x short	$U_B < 19.2$ VDC	Keep within the supply voltage range of 19.2 ... 30 VDC
2, 0, 2	3x short – 2x long – 16x long – 2x long – 3x short	In the initialisation phase, short circuit between the safety outputs and +24 VDC	Rectify wiring error at terminals 14, 24
2, 0, 3	3x short – 2x long – 16x long – 3x long – 3x short	$U_B < 19.2$ VDC	Keep within the supply voltage range of 19.2 ... 30 VDC

Dimensions

* With spring-loaded terminals

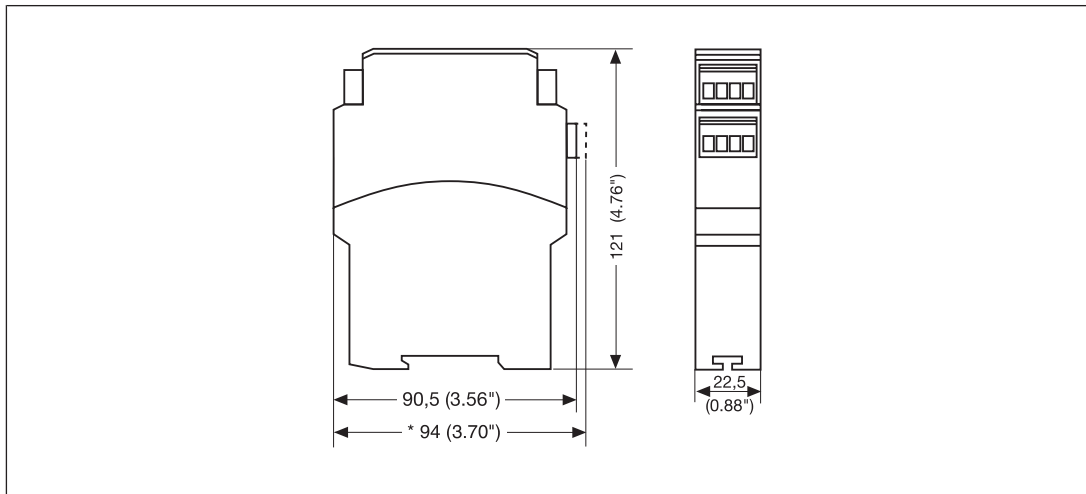

Technical details

General	774130	784130
Approvals	CE, EAC (Eurasian), TÜV, cULus Listed	CE, EAC (Eurasian), TÜV, cULus Listed
Electrical data	774130	784130
Supply voltage		
Voltage	24 V	24 V
Kind	DC	DC
Voltage tolerance	-20 %/+25 %	-20 %/+25 %
Output of external power supply (DC) at no load	2 W	2 W
Residual ripple DC	20 %	20 %
Duty cycle	100 %	100 %
External unit fuse protection F1 max.	6 A slow/10 A quick	6 A slow/10 A quick
Inputs	774130	784130
Voltage at		
Input circuit DC	24 V	24 V
Start circuit DC	24 V	24 V
Feedback loop DC	24 V	24 V
Current at		
Input circuit DC	5 mA	5 mA
Start circuit DC	5 mA	5 mA
Feedback loop DC	5 mA	5 mA
Min. input resistance at power-on	3.780 Ohm	3.780 Ohm

Inputs	774130	784130
Max. overall cable resistance Rl-max		
Start circuit and feedback loop	1.000 Ohm	1.000 Ohm
Input circuit, single-channel	1.000 Ohm	1.000 Ohm
Input circuit, dual-channel	2.000 Ohm	2.000 Ohm
Max. line capacitance	450 nF	450 nF
Semiconductor outputs	774130	784130
Overall performance ext. loading, semiconductor	130 W	130 W
Number of safety outputs		
Instantaneous	2	2
Number of auxiliary outputs	1	1
Number of test pulse outputs	2	2
Switching capability, 2 safety outputs under load		
Current at UB ≤ 26.5 V	2 A	2 A
Current at UB > 26,5 V	1,5 A	1,5 A
Power at UB ≤ 26.5 V	50 W	50 W
Power at UB > 26,5 V	45 W	45 W
Switching capability, 1 safety output under load		
Current at UB ≤ 26.5 V	2,7 A	2,7 A
Current at UB > 26,5 V	2,2 A	2,2 A
Power at UB ≤ 26.5 V	70 W	70 W
Power at UB > 26,5 V	65 W	65 W
Max. line capacitance at the outputs without load	2 nF	2 nF
Voltage auxiliary and test pulse outputs	24 V	24 V
Current auxiliary and test pulse outputs	0,5 A	0,5 A
Times	774130	784130
Switch-on delay		
After power on	3 s	3 s
With automatic start typ.	100 ms	100 ms
With automatic start max.	180 ms	180 ms
With monitored start typ.	180 ms	180 ms
With monitored start max.	260 ms	260 ms
Response time tr semiconductor outputs		
typ.	40 ms	40 ms
max.	43 ms	43 ms
Maximum time of feedback loop monitoring	150 ms	150 ms
Supply interruption before de-energisation	20 ms	20 ms
Simultaneity, channel 1 and 2 max.	∞	∞

Environmental data	774130	784130
Climatic suitability	EN 60068-2-78	EN 60068-2-78
Ambient temperature		
Temperature range	-10 - 55 °C	-10 - 55 °C
Storage temperature		
Temperature range	-25 - 70 °C	-25 - 70 °C
Climatic suitability		
Humidity	93 % r. h. at 40 °C	93 % r. h. at 40 °C
Condensation during operation	Not permitted	Not permitted
EMC	EN 60947-5-1, EN 61000-6-2, EN 61000-6-4, EN 61326-3-1	EN 60947-5-1, EN 61000-6-2, EN 61000-6-4, EN 61326-3-1
Vibration		
In accordance with the standard	EN 60068-2-6	EN 60068-2-6
Frequency	10 - 55 Hz	10 - 55 Hz
Amplitude	0,35 mm	0,35 mm
Airgap creepage		
In accordance with the standard	EN 60947-1	EN 60947-1
Overvoltage category	III	III
Pollution degree	2	2
Rated insulation voltage	30 V	30 V
Rated impulse withstand voltage	0,8 kV	0,8 kV
Protection type		
Housing	IP40	IP40
Terminals	IP20	IP20
Mounting area (e.g. control cabinet)	IP54	IP54
Mechanical data	774130	784130
Mounting position	Any	Any
Material		
Bottom	PPO UL 94 V0	PPO UL 94 V0
Front	ABS UL 94 V0	ABS UL 94 V0
Top	PPO UL 94 V0	PPO UL 94 V0
Connection type	Screw terminal	Spring-loaded terminal
Mounting type	plug-in	plug-in
Conductor cross section with screw terminals		
1 core flexible	0,25 - 2,5 mm², 24 - 12 AWG	–
2 core with the same cross section, flexible with crimp connectors, no plastic sleeve	0,25 - 1 mm², 24 - 16 AWG	–
2 core with the same cross section, flexible without crimp connectors or with TWIN crimp connectors	0,2 - 1,5 mm², 24 - 16 AWG	–
Torque setting with screw terminals	0,5 Nm	–
Conductor cross section with spring-loaded terminals: Flexible with/without crimp connector	–	0,2 - 1,5 mm², 24 - 16 AWG

Mechanical data	774130	784130
Spring-loaded terminals: Terminal points per connection	–	2
Stripping length with spring-loaded terminals	–	8 mm
Dimensions		
Height	90,5 mm	94 mm
Width	22,5 mm	22,5 mm
Depth	121 mm	121 mm
Weight	120 g	120 g

Where standards are undated, the 2017-01 latest editions shall apply.

Safety characteristic data



NOTICE

You must comply with the safety-related characteristic data in order to achieve the required safety level for your plant/machine.

Operating Mode	EN ISO 13849-1: 2015 PL	EN ISO 13849-1: 2015 Category	EN 62061 SIL CL	EN 62061 PFH _D [1/h]	IEC 61511 SIL	IEC 61511 PFD	EN ISO 13849-1: 2015 T _M [year]
SC output, 1-ch. mon. start	PL d	Cat. 2	SIL CL 2	1,34E-08	SIL 2	1,03E-03	20
SC output, 1/2-ch. auto. start	PL e	Cat. 4	SIL CL 3	3,44E-09	SIL 3	4,53E-05	20
SC output, 2-ch. mon. start	PL e	Cat. 4	SIL CL 3	3,44E-09	SIL 3	4,53E-05	20

All the units used within a safety function must be considered when calculating the safety characteristic data.



INFORMATION

A safety function's SIL/PL values are **not** identical to the SIL/PL values of the units that are used and may be different. We recommend that you use the PASCAL software tool to calculate the safety function's SIL/PL values.

Remove plug-in terminals

Procedure: Insert the screwdriver into the housing recess behind the terminal and lever the terminal out.

Do **not** remove the terminals by pulling the cables!

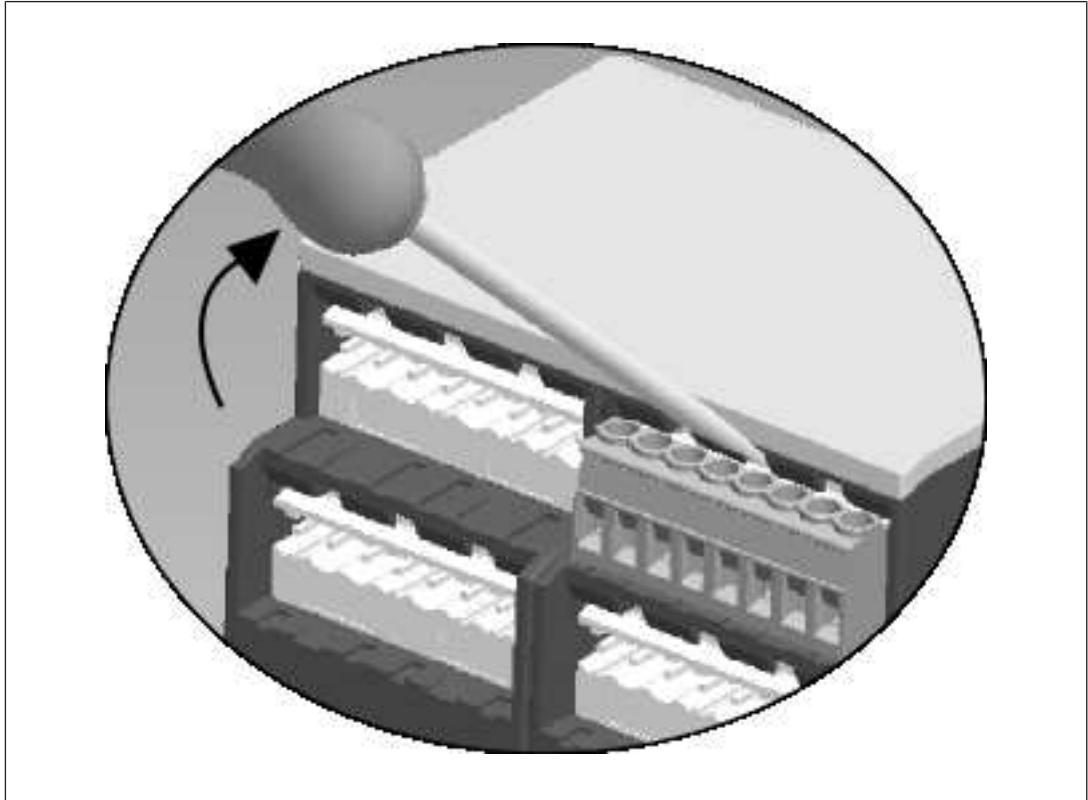

Order reference

Product

Product type	Features	Connection type	Order no.
PNOZ e1p	24 VDC	Screw terminals	774 130
PNOZ e1p C	24 VDC	Spring-loaded terminal	784 130

Accessories

Product type	Features	Order no.
Terminal block filter 1	Terminal block with filter for 3-10 kOhm load range	774 195
Terminal block filter 2	Terminal block with filter for 10-30 kOhm load range	774 196

► Support

Technical support is available from Pilz round the clock.

Americas

Brazil

+55 11 97569-2804

Canada

+1 888-315-PILZ (315-7459)

Mexico

+52 55 5572 1300

USA (toll-free)

+1 877-PILZUSA (745-9872)

Asia

China

+86 21 60880878-216

Japan

+81 45 471-2281

South Korea

+82 31 450 0680

Australia

+61 3 95600621

Europe

Austria

+43 1 7986263-0

Belgium, Luxembourg

+32 9 3217575

France

+33 3 88104000

Germany

+49 711 3409-444

Ireland

+353 21 4804983

Italy, Malta

+39 0362 1826711

Scandinavia

+45 74436332

Spain

+34 938497433

Switzerland

+41 62 88979-30

The Netherlands

+31 347 320477

Turkey

+90 216 5775552

United Kingdom

+44 1536 462203

You can reach our international hotline on:

+49 711 3409-444

support@pilz.com

Pilz develops environmentally-friendly products using ecological materials and energy-saving technologies. Offices and production facilities are ecologically designed, environmentally-aware and energy-saving. So Pilz offers sustainability, plus the security of using energy-efficient products and environmentally-friendly solutions.

Energy
saving by Pilz



Pilz GmbH & Co. KG
Felix-Wankel-Straße 2
73760 Ostfildern, Germany
Tel.: +49 711 3409-0
Fax: +49 711 3409-133
info@pilz.com
www.pilz.com

PILZ
THE SPIRIT OF SAFETY