



▶ PNOZ m1p (ETH)

PILZ
THE SPIRIT OF SAFETY

Operating Manual-20878-EN-18

- Configurable, safe small controllers PNOZmulti Classic



This document is the original document.

Where unavoidable, for reasons of readability, the masculine form has been selected when formulating this document. We do assure you that all persons are regarded without discrimination and on an equal basis.

All rights to this documentation are reserved by Pilz GmbH & Co. KG. Copies may be made for the user's internal purposes. Suggestions and comments for improving this documentation will be gratefully received.

Pilz®, PIT®, PMI®, PNOZ®, Primo®, PSEN®, PSS®, PVIS®, SafetyBUS p®, SafetyEYE®, SafetyNET p®, the spirit of safety® are registered and protected trademarks of Pilz GmbH & Co. KG in some countries.



SD means Secure Digital

1	Introduction	5
1.1	Validity of documentation	5
1.2	Using the documentation	5
1.3	Definition of symbols	5
2	Overview	7
2.1	Range	7
2.2	Unit features	7
2.3	Chip card	8
2.4	Front view	9
3	Safety	11
3.1	Intended use	11
3.2	System requirements	11
3.3	Safety regulations	12
3.3.1	Safety assessment	12
3.3.2	Use of qualified personnel	12
3.3.3	Warranty and liability	12
3.3.4	Disposal	12
3.3.5	For your safety	13
4	Function description	14
4.1	Integrated protection mechanisms	14
4.2	Functions	14
4.3	Block diagram	14
4.4	Diagnostics	15
4.5	Cascading	15
4.6	Safety mat, muting	15
4.7	Interfaces	15
5	Installation	16
5.1	Control cabinet installation	16
5.2	Dimensions	17
5.3	Install base unit without expansion module	17
5.4	Connecting the base unit and expansion modules	18
6	Commissioning	19
6.1	General wiring guidelines	19
6.2	Ethernet interfaces (ETH version only)	20
6.2.1	RJ45 interfaces ("Ethernet")	20
6.2.2	Requirements of the connection cable and connector	20
6.2.3	Interface configuration	20
6.2.4	RJ45 connection cable	21
6.2.5	Process data exchange	22
6.3	Function test during commissioning	22
6.4	Commissioning the PNOZmulti control system for the first time	23
6.4.1	Load project from chip card	23
6.4.2	Load project via integrated interface	23

6.5	Download modified project to the PNOZmulti system.....	24
6.5.1	Load modified project from chip card.....	24
6.5.2	Load modified project via integrated interface.....	24
6.6	Connection.....	24
6.7	Connection example.....	27
7	Operation.....	28
7.1	LED indicators.....	28
7.1.1	Indicators for the Ethernet connection (ETH version only).....	29
7.2	Function test of the relay outputs.....	29
7.3	Reset Ethernet connection settings.....	30
8	Technical Details.....	31
8.1	Safety characteristic data.....	39
9	Supplementary data.....	41
9.1	Service life graph for the relay contacts.....	41
10	Order reference.....	43
10.1	Product.....	43
10.2	Accessories.....	43

1 Introduction

1.1 Validity of documentation

This documentation is valid for the product PNOZ m1p. It is valid until new documentation is published.

This operating manual explains the function and operation, describes the installation and provides guidelines on how to connect the product.

1.2 Using the documentation

This document is intended for instruction. Only install and commission the product if you have read and understood this document. The document should be retained for future reference.

1.3 Definition of symbols

Information that is particularly important is identified as follows:



DANGER!

This warning must be heeded! It warns of a hazardous situation that poses an immediate threat of serious injury and death and indicates preventive measures that can be taken.



WARNING!

This warning must be heeded! It warns of a hazardous situation that could lead to serious injury and death and indicates preventive measures that can be taken.



CAUTION!

This refers to a hazard that can lead to a less serious or minor injury plus material damage, and also provides information on preventive measures that can be taken.



NOTICE

This describes a situation in which the product or devices could be damaged and also provides information on preventive measures that can be taken. It also highlights areas within the text that are of particular importance.



INFORMATION

This gives advice on applications and provides information on special features.

2 Overview

2.1 Range

- ▶ Base unit PNOZ m1p
- ▶ 2 terminators

2.2 Unit features

Application of the product PNOZ m1p:

Base unit from the configurable control system PNOZmulti

The product has the following features:

- ▶ Can be configured in the PNOZmulti Configurator
- ▶ Positive-guided relay outputs:
 - 2 safety outputs
Depending on the application, up to PL e of EN ISO 13849-1 and up to SIL CL 3 of EN IEC 62061
- ▶ Semiconductor outputs:
 - 4 safety outputs
Depending on the application, up to PL e of EN ISO 13849-1 and up to SIL CL 3 of EN IEC 62061
 - 1 output for standard applications
- ▶ 4 test pulse outputs
- ▶ 1 cascading input and output;
can also be used as a standard output
- ▶ 20 inputs for connecting, for example:
 - E-STOP pushbuttons
 - Two-hand pushbuttons
 - Safety gate limit switches
 - Start buttons
 - Light beam devices
 - Scanners
 - Enabling switches
 - PSEN
 - Operating mode selector switches
 - Safety mats
- ▶ Muting function

- ▶ LED indicator for:
 - Diagnostics
 - Supply voltage
 - Output circuits
 - Input circuits
- ▶ Test pulse outputs used to monitor shorts across the inputs
- ▶ Monitoring of shorts between the safety outputs
- ▶ Expansion modules can be connected
(please refer to the document "PNOZmulti System Expansion" for details of the type and number that can be connected)
- ▶ Integrated interfaces:
 - PNOZ m1p: Serial interface RS232
 - PNOZ m1p **ETH**: 2 Ethernet interfaces
- ▶ Plug-in connection terminals:
Either spring-loaded terminal or screw terminal available as an accessory (see Order references for accessories).
- ▶ Coated version:
Increased environmental requirements (see [Technical details](#)  31)

2.3 Chip card

To be able to use the product you will need a chip card.

Chip cards are available with memories of 8 kByte and 32 kByte. For large-scale projects we recommend the 32 kByte chip card (see Technical Catalogue: Accessories chapter).

2.4 Front view

PNOZ m1p

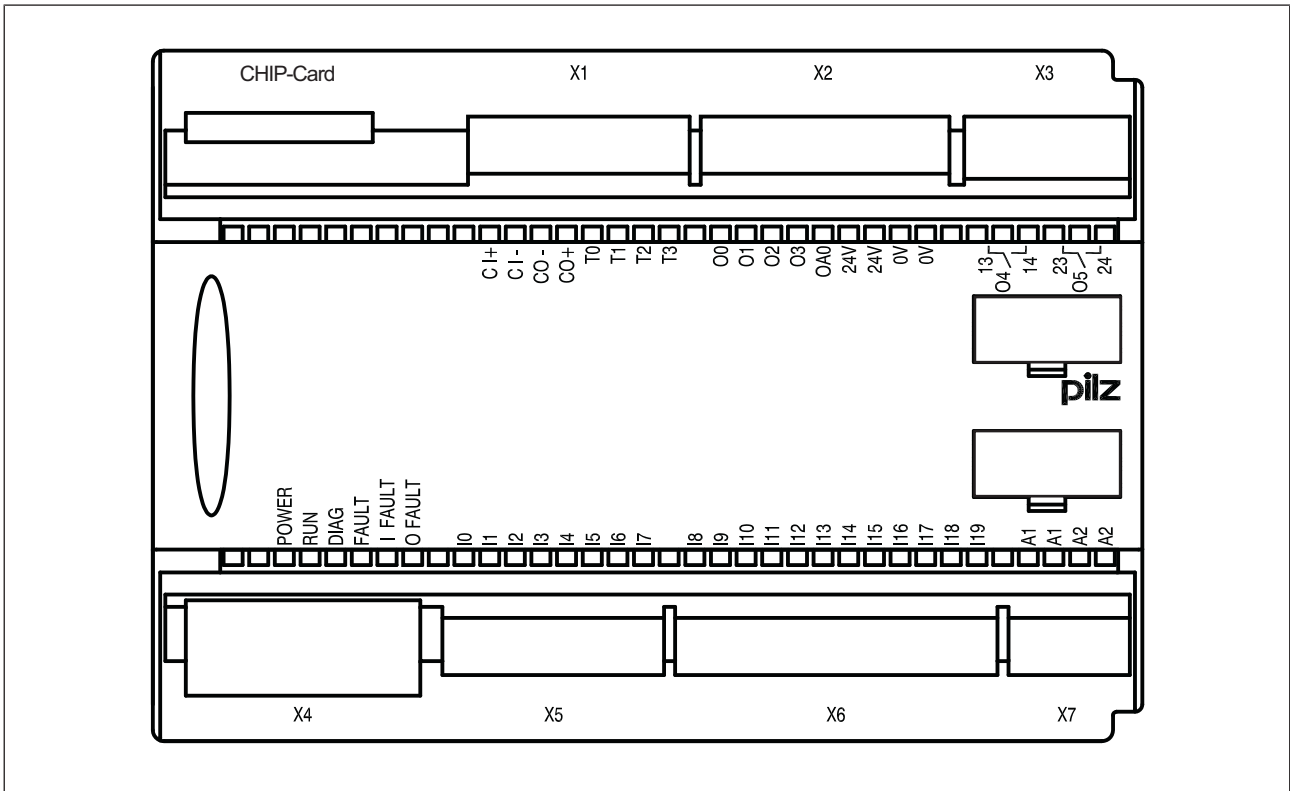

PNOZ m1p ETH

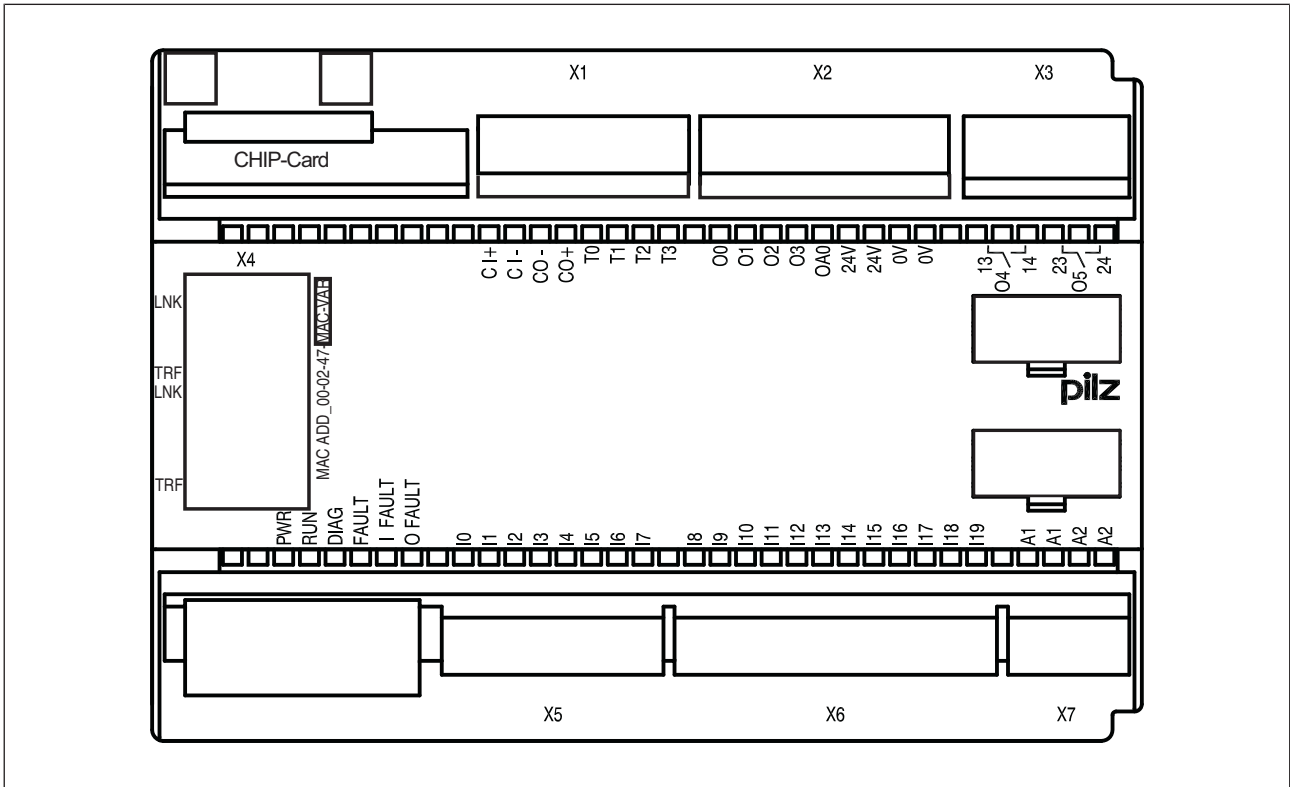

Legend:

- CHIP card Chipkarte interface
- X1 Cascading inputs and outputs CI and CO,
Test pulse outputs T0 ... T3
- X2 Semiconductor outputs O0 ... O3,
Auxiliary output OA0,
Supply connections
- X3 Relay outputs O4 and O5
- X4 RS232 interface / Ethernet interface
- X5, X6 Inputs I0 ... I19
- X7 Power supply
- LEDs: PWR
 RUN
 DIAG
 FAULT
 I FAULT
 O FAULT

3 Safety

3.1 Intended use

The configurable small control systems PNOZmulti are used for the safety-related interruption of safety circuits and are designed for use in:

- ▶ E-STOP equipment
- ▶ Safety circuits in accordance with VDE 0113 Part 1 and EN 60204-1



CAUTION!

Inputs and outputs for standard functions must not be used for safety-related applications.

The coated version of the product PNOZ m1p is suitable for use where there are increased environmental requirements (see [Technical details \[31\]](#)).

Improper use

The following is deemed improper use in particular

- ▶ Any component, technical or electrical modification to the product,
- ▶ Use of the product outside the areas described in this operating manual,
- ▶ Use of the product outside the technical details (see [Technical details \[31\]](#)).



NOTICE

EMC-compliant electrical installation

The product is designed for use in an industrial environment. The product may cause interference if installed in other environments. If installed in other environments, measures should be taken to comply with the applicable standards and directives for the respective installation site with regard to interference.

3.2 System requirements

Please refer to the "Product Modifications" document in the "Version overview" section for details of which versions of the PNOZmulti Configurator can be used for this product.

3.3 Safety regulations

3.3.1 Safety assessment

Before using a device, a safety assessment in accordance with the Machinery Directive is required.

The product as an individual component fulfils the functional safety requirements in accordance with EN ISO 13849 and EN 62061. However, this does not guarantee the functional safety of the overall plant/machine. To achieve the relevant safety level of the overall plant/machine's required safety functions, each safety function needs to be considered separately.

3.3.2 Use of qualified personnel

The products may only be assembled, installed, programmed, commissioned, operated, maintained and decommissioned by persons who are competent to do so.

A competent person is a qualified and knowledgeable person who, because of their training, experience and current professional activity, has the specialist knowledge required. To be able to inspect, assess and operate devices, systems and machines, the person has to be informed of the state of the art and the applicable national, European and international laws, directives and standards.

It is the company's responsibility only to employ personnel who

- ▶ Are familiar with the basic regulations concerning health and safety / accident prevention,
- ▶ Have read and understood the information provided in the section entitled Safety
- ▶ Have a good knowledge of the generic and specialist standards applicable to the specific application.

3.3.3 Warranty and liability

All claims to warranty and liability will be rendered invalid if

- ▶ The product was used contrary to the purpose for which it is intended,
- ▶ Damage can be attributed to not having followed the guidelines in the manual,
- ▶ Operating personnel are not suitably qualified,
- ▶ Any type of modification has been made (e.g. exchanging components on the PCB boards, soldering work etc.).

3.3.4 Disposal

- ▶ In safety-related applications, please comply with the mission time T_M in the safety-related characteristic data.
- ▶ When decommissioning, please comply with local regulations regarding the disposal of electronic devices (e.g. Electrical and Electronic Equipment Act).

3.3.5 For your safety

The unit meets all the necessary conditions for safe operation. However, you should always ensure that the following safety requirements are met:

- ▶ This operating manual only describes the basic functions of the unit. Advanced functions are described in the online help for the PNOZmulti Configurator, in the "PNOZmulti Communication Interfaces" document and in "PNOZmulti Special Applications". Only use these functions once you have read and understood the documentation.
- ▶ Please note the "PNOZmulti Installation Manual".
- ▶ You must note the information stated in the "PNOZmulti Safety Manual".
- ▶ Adequate protection circuit must be provided for all inductive consumers.
- ▶ Do not open the housing or make any unauthorised modifications.
- ▶ Please make sure you shut down the supply voltage when performing maintenance work (e.g. exchanging contactors).

4 Function description

4.1 Integrated protection mechanisms

The relay meets the following safety requirements:

- ▶ The circuit is redundant with built-in self-monitoring.
- ▶ The safety device remains effective in the case of a component failure.
- ▶ The relay contacts meet the requirements for protective separation through increased insulation compared with all other circuits in the safety system.
- ▶ The safety outputs are tested periodically using a disconnection test.

4.2 Functions

The function of the inputs and outputs on the control system depends on the safety circuit created using the PNOZmulti Configurator. A chip card is used to download the safety circuit to the base unit. The base unit has 2 microcontrollers that monitor each other. They evaluate the input circuits on the base unit and expansion modules and switch the outputs on the base unit and expansion modules accordingly.

The LEDs on the base unit and expansion modules indicate the status of the configurable control system PNOZmulti.

The online help on the PNOZmulti Configurator contains descriptions of the operating modes and all the functions of the control system, plus connection examples.

4.3 Block diagram

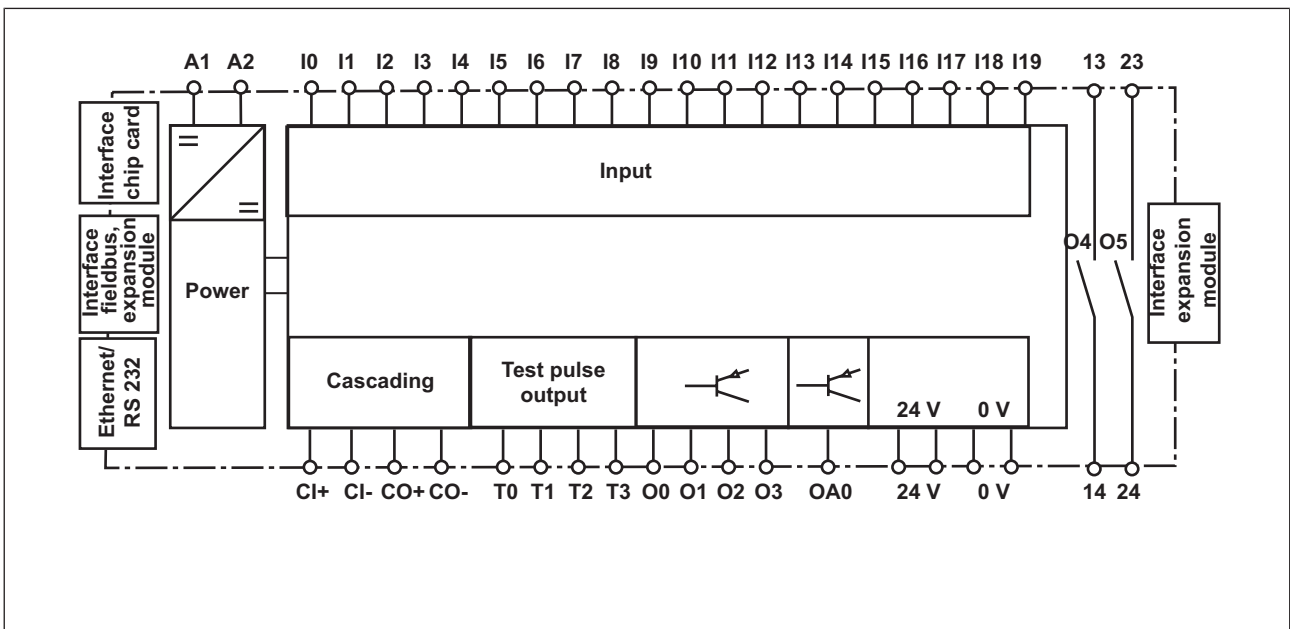

4.4 Diagnostics

The status and error messages displayed by the LEDs are saved in an error stack. This error stack can be read from the PNOZmulti Configurator via the interfaces (RS 232 or Ethernet). More comprehensive diagnostics are possible via the interfaces or one of the fieldbus modules, e.g. the PROFIBUS module.

4.5 Cascading

The cascading inputs and outputs enable several PNOZmulti and PNOZelog units to be connected in series or as a tree structure.



INFORMATION

Detailed information on these functions and connection examples can be found in the online help for the PNOZmulti Configurator and in the PNOZmulti Installation Manual.

4.6 Safety mat, muting



INFORMATION

Detailed information on these functions and connection examples can be found in the online help for the PNOZmulti Configurator and in the document entitled "PNOZmulti - Special Applications".

4.7 Interfaces

The product PNOZ m1p **ETH** has two Ethernet interfaces, the product PNOZ m1p has one serial interface to

- ▶ Project download
- ▶ Read the diagnostic data
- ▶ Set virtual inputs for standard functions
- ▶ Read virtual outputs for standard functions.

Information on diagnostics via the interfaces can be found in the document "PNOZmulti communication interfaces".

The connection to Ethernet is made via the two 8-pin RJ45 sockets.

The Ethernet interface is configured in the PNOZmulti Configurator and is described in the online help for the PNOZmulti Configurator.

5 Installation

5.1 Control cabinet installation

- ▶ The control system should be installed in a control cabinet with a protection type of at least IP54. Fit the control system to a horizontal mounting rail. The venting slots must face upward and downward. Other mounting positions could destroy the control system.
- ▶ Use the locking elements on the rear of the unit to attach it to a mounting rail. Connect the control system to the mounting rail in an upright position, so that the earthing springs on the control system are pressed on to the mounting rail.
- ▶ The ambient temperature of the devices in the control cabinet must not exceed the figure stated in the technical details. Air conditioning may otherwise be required.
- ▶ To comply with EMC requirements, the mounting rail must have a low impedance connection to the control cabinet housing.

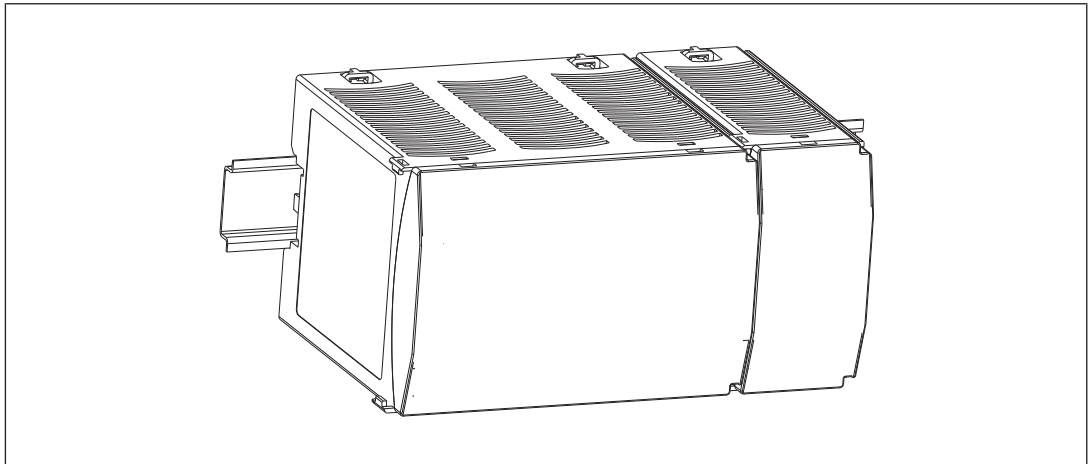

NOTICE

Damage due to electrostatic discharge!

Electrostatic discharge can damage components. Ensure against discharge before touching the product, e.g. by touching an earthed, conductive surface or by wearing an earthed armband.

5.2 Dimensions

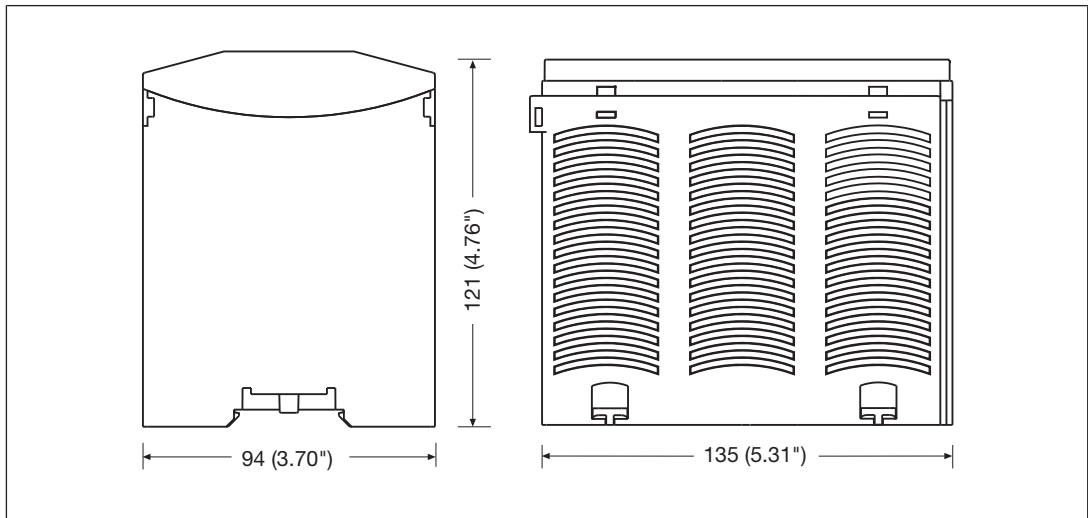

5.3 Install base unit without expansion module

- ▶ The terminator must be fitted to the side of the base unit marked "Termination/Link".
- ▶ Do not fit a terminator on the left hand side of the base unit.

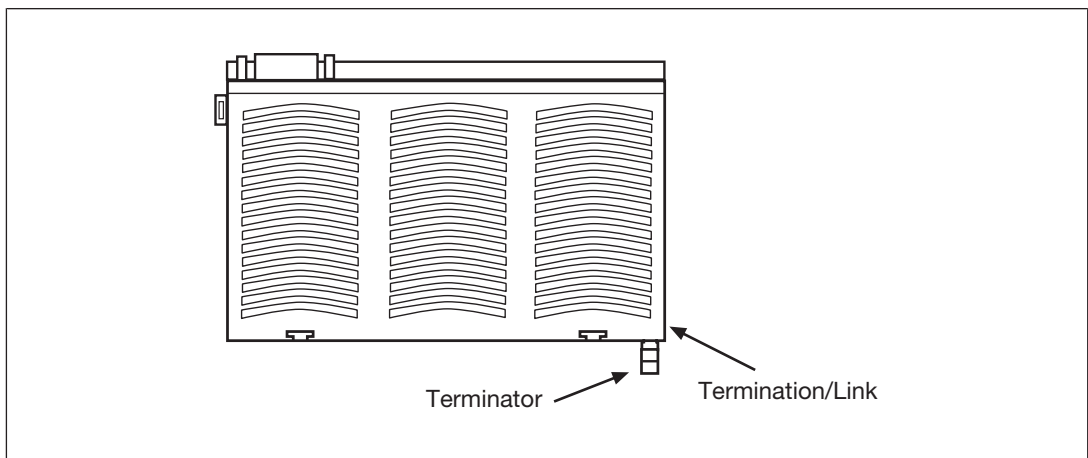

5.4 Connecting the base unit and expansion modules

The position of the expansion modules is defined in the PNOZmulti Configurator. The expansion modules are connected to the left or right of the base unit, depending on the type.

Please refer to the document "PNOZmulti System Expansion" for details of the number of modules that can be connected to the base unit and the module types.

The modules are linked via jumpers.

There are 2 pin connectors on the rear of the base unit.

A max. of 12 expansion modules plus one fieldbus module may be connected to one base unit.

- ▶ Ensure that no terminator is connected.
- ▶ Connect the base unit, the expansion modules and the fieldbus module using the jumpers supplied.
- ▶ The terminator must be fitted to the last expansion module to the right of the base unit.
- ▶ A terminator must not be fitted to the last expansion module to the left of the base unit.

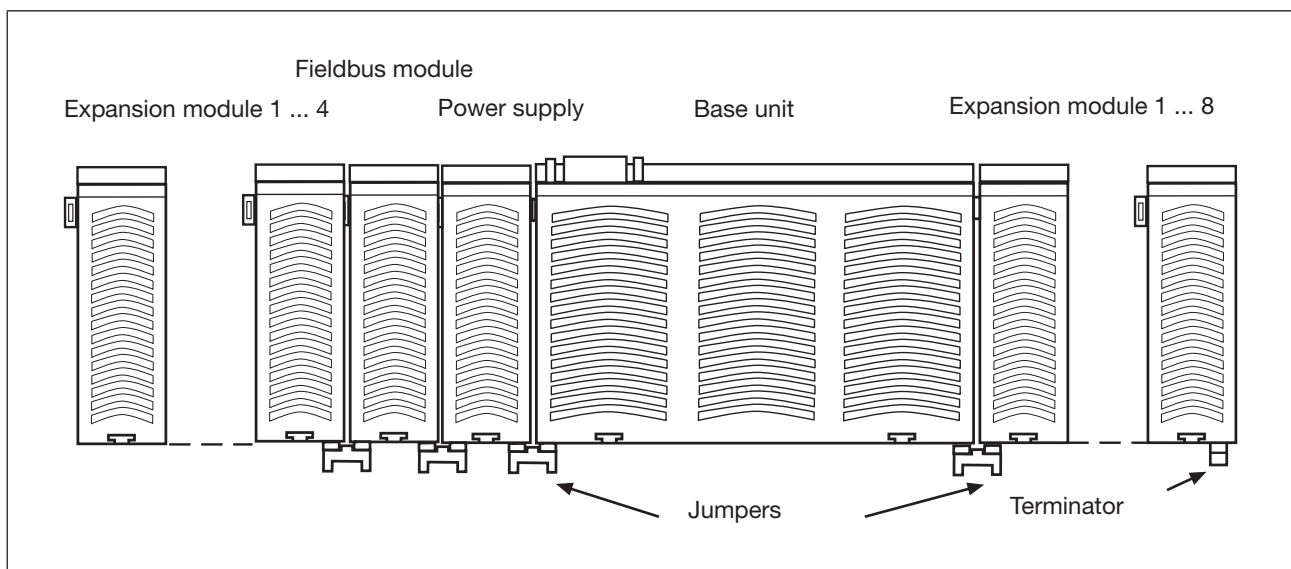

6 Commissioning

6.1 General wiring guidelines

The wiring is defined in the circuit diagram in the Configurator. There you can select the inputs that are to perform a safety function and the outputs that are to switch this safety function.

Please note:



CAUTION!

The plug-in connection terminals on the relay outputs carry mains voltage and should only be connected and disconnected when the voltage is switched off.

- ▶ Information given in the [Technical details \[31\]](#) must be followed.
- ▶ Outputs:
 - O0 to O5 are safety outputs
 - O4 and O5 are relay outputs
 - O0 to O3 are semiconductor outputs
 - OA0 is an output to delete a project from the base unit (see online help for the PNOZmutli Configurator).
- ▶ To prevent contact welding, a fuse should be connected before the output contacts (see technical details).
- ▶ Use copper wiring with a temperature stability of 75°C.
- ▶ Adequate protection circuit must be provided on all output contacts with inductive loads.
- ▶ The control system and input circuits must always be supplied by a single power supply. The power supply must meet the regulations for extra low voltages with protective separation.
- ▶ Two connection terminals are available for each of the supply connections 24 V and 0 V (semiconductor outputs), plus A1 and A2 (power supply). This means that the supply voltage can be looped through several connections. When the supply voltage is looped, the current at each terminal may not exceed 3 A.
- ▶ Test pulse outputs must exclusively be used to test the inputs. They must not be used to drive loads.
Do not route the test pulse lines together with actuator cables within an unprotected multicore cable.
- ▶ Test pulse outputs are also used to supply safety mats that trigger a short circuit.
Test pulses that are used for the safety mat may not be reused for other purposes.

6.2 Ethernet interfaces (ETH version only)

6.2.1 RJ45 interfaces ("Ethernet")

Two free switch ports are provided as Ethernet interfaces via an internal autosensing switch. The autosensing switch automatically detects whether data transfer is occurring at 10 Mbit/s or 100 Mbit/s.



INFORMATION

The connected subscribers must support the autosensing/autonegotiation function. If not, the communication partner must be set permanently to "10 Mbit/s, half duplex".

The switch's automatic crossover function means there is no need to distinguish on the connection cable between patch cable (uncrossed data line connection) and crossover cable (crossover data line connection). The switch automatically creates the correct data line connection internally. Patch cable can therefore be used as the connection cable for end devices as well as cascading.

Both Ethernet interfaces use RJ45 technology.

6.2.2 Requirements of the connection cable and connector

The following minimum requirements must be met:

- ▶ Ethernet standards (min. Category 5) 10BaseT or 100BaseTX
- ▶ Double-shielded twisted pair cable for industrial Ethernet use
- ▶ Shielded RJ45 connectors (industrial connectors)

6.2.3 Interface configuration

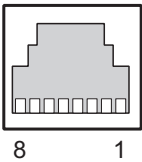
RJ45 socket 8-pin	PIN	Standard	Crossover
	1	TD+ (Transmit+)	RD+ (Receive+)
	2	TD- (Transmit-)	RD- (Receive-)
	3	RD+ (Receive+)	TD+ (Transmit+)
	4	n.c.	n.c.
	5	n.c.	n.c.
	6	RD- (Receive-)	TD- (Transmit-)
	7	n.c.	n.c.
	8	n.c.	n.c.

6.2.4 RJ45 connection cable

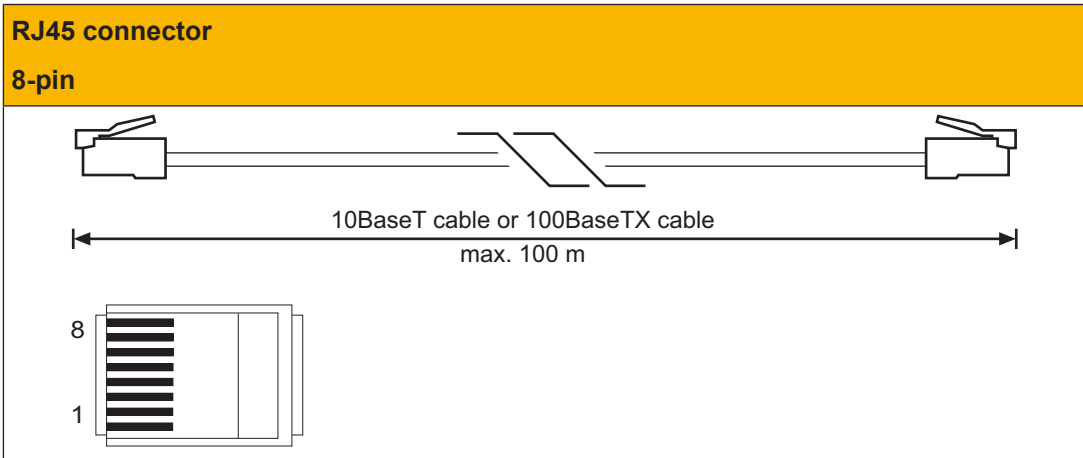

NOTICE

With the plug-in connection please note that the data cable and connector have a limited mechanical load capacity. Appropriate design measures should be used to ensure that the plug-in connection is insensitive to increased mechanical stress (e.g. through shock, vibration). Such measures include fixed routing with strain relief, for example.

6.2.5 Process data exchange

The RJ45 interfaces on the internal autosensing switch enable process data to be exchanged with other Ethernet subscribers within a network.

The product PNOZ m1p can also be connected to Ethernet via a hub (hub or switch).

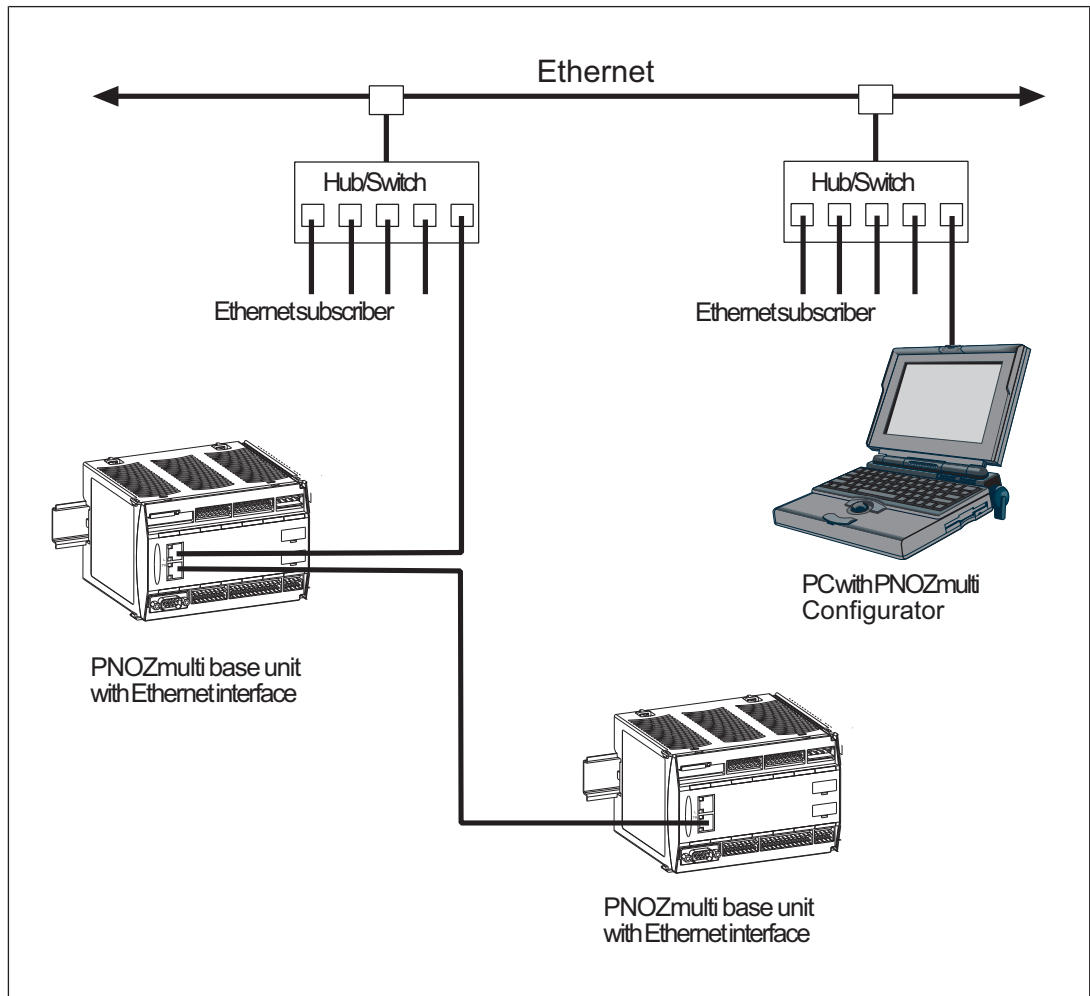

Fig.: PNOZmulti as Ethernet subscriber - possible topologies

6.3 Function test during commissioning



CAUTION!

It is essential to check that the safety devices operate correctly

- after the chip card has been exchanged
- after a project has been downloaded
- when the project has been deleted from the base unit's memory ("Reset Project" menu)

6.4 Commissioning the PNOZmulti control system for the first time

Procedure:

- ▶ Wire the inputs and outputs on the base unit and expansion modules in accordance with the circuit diagram.
- ▶ Cascading output as auxiliary output: Connect the load to CO+ and A2, see connection example.
- ▶ Connect the supply voltage:
 - Supply voltage for the units (connector X7):
 - Terminal A1: + 24 VDC
 - Terminal A2: 0 V
 - Supply voltage for the semiconductor outputs (connector X2):
 - 24 V terminal: + 24 VDC
 - 0V terminal: 0 V

Please note: Supply voltage must always be applied to X2 and X7, even if you are not using the semiconductor outputs.

6.4.1 Load project from chip card



NOTICE

Chip contacting is only guaranteed if the contact surface is clean and undamaged. The chip's contact surface should therefore be protected from contamination, contact and mechanical impact such as scratches.

Procedure:

- ▶ Insert the chip card containing the current project into the card slot on the base unit.
- ▶ Switch on the supply voltage.

6.4.2 Load project via integrated interface

Procedure:

- ▶ Insert a chip card into the chip card slot on the base unit.
- ▶ Connect the computer containing the PNOZmulti Configurator to the base unit via the interface.
- ▶ Switch on the supply voltage.
- ▶ Download the project (see PNOZmulti Configurator's online help).



INFORMATION

You will need a PC with an Ethernet card in order to establish an Ethernet connection.

6.5 Download modified project to the PNOZmulti system

6.5.1 Load modified project from chip card

To download data via chip card, the existing configuration data must first be deleted (general reset of device).

Procedure:

- ▶ Switch off the supply voltage.
- ▶ Disconnect all the output terminals.
- ▶ Jumper OA0-I19 on the base unit.
- ▶ Switch on the supply voltage.

When the "DIAG" LED on the base unit flashes, the memory has been cleared. The project data can now be downloaded:

- ▶ Switch off the supply voltage.
- ▶ Remove the old chip card from the chip card slot on the base unit.
- ▶ Remove the jumper from OA0-I19 on the base unit.
- ▶ Insert the chip card containing the current project into the card slot.
- ▶ Switch on the supply voltage.

6.5.2 Load modified project via integrated interface

Proceed as described for the initial commissioning

6.6 Connection

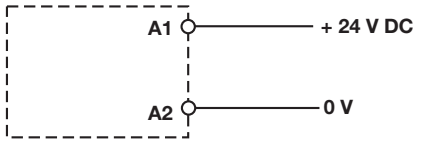
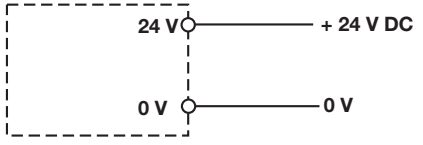
Supply voltage	AC	DC
For the safety system (connector X7)	/	
For the semiconductor outputs (connector X2) Must always be present, even if the semiconductor outputs are not used	/	

Supply voltage

Input circuit	Single-channel	Dual-channel
E-STOP without detection of shorts across contacts		
E-STOP with detection of shorts across contacts		

Connection examples for the input circuit

Start circuit	Input circuit without detection of shorts across contacts	Input circuit with detection of shorts across contacts

Connection examples for start circuit

Redundant output		
Single output		

Connection examples for semiconductor outputs

<p>Redundant output</p>		
<p>Single output</p>		

Connection examples for relay outputs

<p>Feedback loop</p>	<p>Redundant output</p>	
<p>Contacts from external contactors</p>		

Connection examples for feedback loop

6.7 Connection example

Dual-channel E-STOP and safety gate wiring, monitored start (I17), feedback loop (I14), cascading output as auxiliary output (CO+/A2)

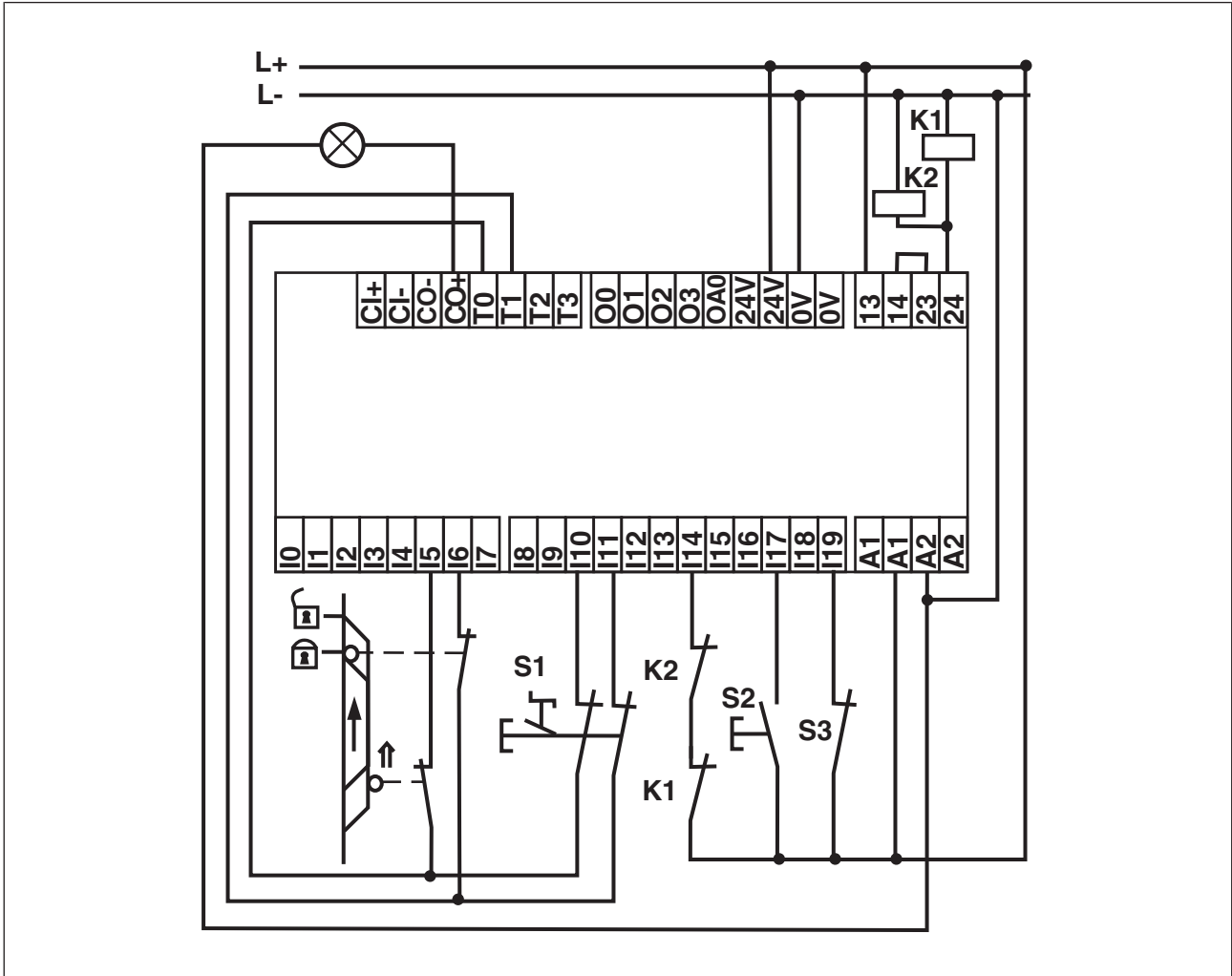



7 Operation





















When the supply voltage is switched on, the PNOZmulti copies the configuration from the chip card.

The PNOZmulti control system is ready for operation when the "POWER" and "RUN" LEDs on the base unit are lit continuously.

7.1 LED indicators

Legend

-  LED on
-  LED flashes
-  LED off

Basis								Exp.		Error
Input Ix	Run	Diag	Fault	IFAULT	OFAULT	CI	CO	Fault	IN/OUT	
	●									The existing user program has been deleted.
	●									External error on the base unit, leading to a safe condition, e.g. terminator not connected
	●									External error leading to a safe condition, e.g. short across the contacts or error at safety mat input.
	●									External error on the base unit outputs, e.g. short across the contacts, leading to a safe condition.
	●									External error, leading to a safe condition, e.g. short across the contacts
	●									External error on the output
	●									Internal error on the base unit
	●									Internal error on the base unit
	●									Internal error on the base unit
	●									Internal error on the expansion module
	●									Base unit in a STOP condition
										External error on the base unit inputs, which does not lead to a safe condition, e.g. partially operated
										External error on the base unit outputs, which does not lead to a safe condition, e.g. feedback input defective

Basis								Exp.		Error
Input Ix	Run	Diag	Fault	IFault	OFAULT	CI	CO	Fault	IN/OUT	
										External error on the inputs, which does not lead to a safe condition, e.g. partially operated; feedback input defective
										The fieldbus module has not been recognised. Or The base unit has been identified via the PNOZmulti Configurator.
										Error on cascading input; unit remains in a RUN condition
										Error on cascading output; unit remains in a RUN condition

7.1.1 Indicators for the Ethernet connection (ETH version only)

The operating and fault states of the Ethernet connection are displayed via the LNK (Link) and TRF (Traffic) LEDs on the Ethernet interfaces.

LED	Signal	Meaning
LNK (green)		No network connection
		Network connection present
TRF (yellow)		No data traffic
		Data traffic present

7.2 Function test of the relay outputs

When the relay outputs are switched on, the mechanical contact on the relay cannot be tested automatically. Depending on the operational environment, measures to detect the non-opening of switching elements may be required under some circumstances.

When the product is used in accordance with the European Machinery Directive, a check must be carried out to ensure that the safety contacts on the relay outputs open correctly. Start the device again or open the safety contacts (switch off output), so that the internal diagnostics can check the correct opening of the safety contacts

- ▶ for SIL 3/PL e at least 1x per month
- ▶ for SIL 2/PL d at least 1x per year

7.3 **Reset Ethernet connection settings**

The Ethernet connection settings of the base unit can be configured in the PNOZmulti Configurator.

You can reset the base unit's Ethernet connection settings to the default settings.

Proceed as follows:

- ▶ Switch off the supply voltage
- ▶ Remove the chip card
- ▶ Restart the base unit without the chip card inserted.

The Ethernet connection settings are now reset to the default settings.

8 Technical Details

General	773100	773103	773104	773105
Certifications	CE, EAC, KCC, KOSHA, TÜV, UKCA, cULus Listed	CE, EAC, KCC, KOSHA, TÜV, UKCA, cULus Listed	CE, EAC, KCC, KOSHA, TÜV, UKCA, cULus Listed	CE, EAC, KCC, KOSHA, TÜV, UKCA, cULus Listed
Electrical data	773100	773103	773104	773105
Supply voltage for	Supply to the system	Supply to the system	Supply to the system	Supply to the system
Voltage	24 V	24 V	24 V	24 V
Kind	DC	DC	DC	DC
Voltage tolerance	-15 %/+20 %	-15 %/+20 %	-15 %/+20 %	-15 %/+20 %
Output of external power supply (DC) at no load	8 W	9 W	9 W	8 W
Residual ripple DC	5 %	5 %	5 %	5 %
Supply voltage for	Supply to the SC outputs	Supply to the SC outputs	Supply to the SC outputs	Supply to the SC outputs
Voltage	24 V	24 V	24 V	24 V
Kind	DC	DC	DC	DC
Voltage tolerance	-15 %/+20 %	-15 %/+20 %	-15 %/+20 %	-15 %/+20 %
Output of external power supply (DC)	192 W	192 W	192 W	192 W
Residual ripple DC	5 %	5 %	5 %	5 %
Potential isolation	Yes	Yes	Yes	Yes
Supply voltage				
Power consumption per expansion module	2,5 W	2,5 W	2,5 W	2,5 W
Status indicator	LED	LED	LED	LED
Inputs	773100	773103	773104	773105
Quantity	20	20	20	20
Max. number of live inputs within the max. permitted ambient temperature (see "Environmental data")	U _B ≤ 26,4 V : 20, U _B > 26,4 V : 15	U _B ≤ 26,4 V : 20, U _B > 26,4 V : 15	U _B ≤ 26,4 V : 20, U _B > 26,4 V : 15	U _B ≤ 26,4 V : 20, U _B > 26,4 V : 15
Signal level at g0 h	-3 - +5 V DC	-3 - +5 V DC	-3 - +5 V DC	-3 - +5 V DC
Signal level at "1"	15 - 30 V DC	15 - 30 V DC	15 - 30 V DC	15 - 30 V DC
Input voltage in accordance with EN 61131-2 Type 1	24 V DC	24 V DC	24 V DC	24 V DC

Inputs	773100	773103	773104	773105
Input current at rated voltage	8 mA	8 mA	8 mA	8 mA
Min. pulse duration	18 ms	18 ms	18 ms	18 ms
Pulse suppression	0,6 ms	0,6 ms	0,6 ms	0,6 ms
Maximum input delay	4 ms	4 ms	4 ms	4 ms
Potential isolation	No	No	No	No
Semiconductor outputs	773100	773103	773104	773105
Quantity	4	4	4	4
Switching capability				
Voltage	24 V	24 V	24 V	24 V
Current	2 A	2 A	2 A	2 A
Power	48 W	48 W	48 W	48 W
Derating of coated version at an ambient temperature > 50 °C				
Voltage	–	–	24 V	24 V
Current	–	–	1 A	1 A
Power	–	–	24 W	24 W
Signal level at "1"	UB - 0.5 VDC at 2 A	UB - 0.5 VDC at 2 A	UB - 0.5 VDC at 2 A	UB - 0.5 VDC at 2 A
Residual current at "0"	0,5 mA	0,5 mA	0,5 mA	0,5 mA
Max. capacitive load	1 µF	1 µF	1 µF	1 µF
Max. duration of off time during self test	300 µs	300 µs	300 µs	300 µs
Switch-off delay	30 ms	30 ms	30 ms	30 ms
Potential isolation	Yes	Yes	Yes	Yes
Short circuit-proof	Yes	Yes	Yes	Yes
Semiconductor outputs (standard)	773100	773103	773104	773105
Quantity	1	1	1	1
Switching capability				
Voltage	24 V	24 V	24 V	24 V
Current	0,5 A	0,5 A	0,5 A	0,5 A
Power	12 W	12 W	12 W	12 W
Galvanic isolation	Yes	Yes	Yes	Yes
Short circuit-proof	Yes	Yes	Yes	Yes
Residual current at "0"	0,5 mA	0,5 mA	0,5 mA	0,5 mA
Signal level at "1"	UB - 0.5 VDC at 0.5 A	UB - 0.5 VDC at 0.5 A	UB - 0.5 VDC at 0.5 A	UB - 0.5 VDC at 0.5 A
Test pulse outputs	773100	773103	773104	773105
Number of test pulse outputs	4	4	4	4

Test pulse outputs	773100	773103	773104	773105
Voltage	24 V	24 V	24 V	24 V
Current	0,5 A	0,5 A	0,5 A	0,5 A
Max. duration of off time during self test	5 ms	5 ms	5 ms	5 ms
Short circuit-proof	Yes	Yes	Yes	Yes
Potential isolation	No	No	No	No
Relay outputs	773100	773103	773104	773105
Number of relay outputs	2	2	2	2
Utilisation category in accordance with the standard	EN 60947-4-1	EN 60947-4-1	EN 60947-4-1	EN 60947-4-1
Utilisation category of safety contacts				
AC1 at	240 V	240 V	240 V	240 V
Max. current	6 A	6 A	6 A	6 A
Max. power	1440 VA	1440 VA	1440 VA	1440 VA
DC1 at	24 V	24 V	24 V	24 V
Max. current	6 A	6 A	6 A	6 A
Max. power	144 W	144 W	144 W	144 W
Derating of coated version at an ambient temperature > 50 °C				
Safety contacts, AC1 at	–	–	240 V	240 V
Max. current	–	–	4 A	4 A
Max. power	–	–	960 W	960 W
Safety contacts, DC 1 at	–	–	24 V	24 V
Max. current	–	–	4 A	4 A
Max. power	–	–	96 W	96 W
Utilisation category in accordance with the standard	EN 60947-5-1	EN 60947-5-1	EN 60947-5-1	EN 60947-5-1
Utilisation category of safety contacts				
AC15 at	230 V	230 V	230 V	230 V
Max. current	3 A	3 A	3 A	3 A
Max. power	690 W	690 W	690 W	690 W
DC13 (6 cycles/min) at	24 V	24 V	24 V	24 V
Max. current	3 A	3 A	3 A	3 A
Max. power	72 W	72 W	72 W	72 W

Relay outputs	773100	773103	773104	773105
Airgap creepage between				
Relay contacts	3 mm	3 mm	3 mm	3 mm
Relay contacts and other circuits	5,5 mm	5,5 mm	5,5 mm	5,5 mm
External contact fuse protection, safety contacts				
in accordance with the standard	EN 60947-5-1	EN 60947-5-1	EN 60947-5-1	EN 60947-5-1
Blow-out fuse, quick	6 A	6 A	6 A	6 A
Blow-out fuse, slow	6 A	6 A	6 A	6 A
Circuit breaker 24V AC/DC, characteristic B/C	6 A	6 A	6 A	6 A
Switch-off delay	50 ms	50 ms	50 ms	50 ms
Potential isolation	Yes	Yes	Yes	Yes
Cascading output as standard output	773100	773103	773104	773105
Quantity	1	1	1	1
Switching capability				
Voltage	24 V	24 V	24 V	24 V
Current	0,2 A	0,2 A	0,2 A	0,2 A
Power	4,8 W	4,8 W	4,8 W	4,8 W
Galvanic isolation	No	No	No	No
Short circuit-proof	Yes	Yes	Yes	Yes
Residual current at "0"	0,5 mA	0,5 mA	0,5 mA	0,5 mA
Ethernet interface	773100	773103	773104	773105
Quantity	–	2	2	–
Serial interface	773100	773103	773104	773105
Number of RS232 interfaces	1	–	–	1
Times	773100	773103	773104	773105
Switch-on delay	5 s	5 s	5 s	5 s
Supply interruption before de-energisation	20 ms	20 ms	20 ms	20 ms
Simultaneity, channel 1 and 2 max.	3 s	3 s	3 s	3 s
Simultaneity in the two-hand circuit	0,5 s	0,5 s	0,5 s	0,5 s
Max. cycle time of the device	15 ms	15 ms	15 ms	15 ms

Times	773100	773103	773104	773105
Max. processing time for data communication	–	50 ms	50 ms	–
Environmental data				
Ambient temperature				
in accordance with the standard	EN 60068-2-14	EN 60068-2-14	EN 60068-2-14	EN 60068-2-14
Temperature range	0 - 60 °C	0 - 60 °C	-25 - 60 °C	-25 - 60 °C
Forced convection in control cabinet off	55 °C	55 °C	–	–
Storage temperature				
in accordance with the standard	EN 60068-2-1/-2	EN 60068-2-1/-2	EN 60068-2-1/-2	EN 60068-2-1/-2
Temperature range	-25 - 70 °C	-25 - 70 °C	-25 - 70 °C	-25 - 70 °C
Climatic suitability				
in accordance with the standard	EN 60068-2-30, EN 60068-2-78	EN 60068-2-30, EN 60068-2-78	EN 60068-2-30, EN 60068-2-78	EN 60068-2-30, EN 60068-2-78
Humidity	93 % r. h. at 40 °C	93 % r. h. at 40 °C	93 % r. h. at 40 °C	93 % r. h. at 40 °C
Condensation during operation	Not permitted	Not permitted	Short-term (only with separated extra low voltage)	Short-term (only with separated extra low voltage)
Max. operating height above SL	2000 m	2000 m	2000 m	2000 m
EMC	EN 61131-2	EN 61131-2	EN 61131-2	EN 61131-2
Vibration				
in accordance with the standard	EN 60068-2-6	EN 60068-2-6	EN 60068-2-6	EN 60068-2-6
Frequency	10 - 150 Hz	10 - 150 Hz	5 - 500 Hz	5 - 500 Hz
Acceleration	1g	1g	1g	1g
Broadband noise				
in accordance with the standard	–	–	EN 60068-2-64	EN 60068-2-64
Frequency	–	–	5 - 500 Hz	5 - 500 Hz
Acceleration	–	–	19 m/s² rms	19 m/s² rms
Corrosive gas check				
SO ₂ : Concentration 10 ppm, duration 10 days, passive	–	–	DIN V 40046-36	DIN V 40046-36
H ₂ S: Concentration 1 ppm, duration 10 days, passive	–	–	DIN V 40046-37	DIN V 40046-37

Environmental data	773100	773103	773104	773105
Shock stress				
in accordance with the standard	EN 60068-2-27	EN 60068-2-27	EN 60068-2-27	EN 60068-2-27
Acceleration	15g	15g	15g	15g
Duration	11 ms	11 ms	11 ms	11 ms
Airgap creepage				
in accordance with the standard	EN 61131-2	EN 61131-2	EN 61131-2	EN 61131-2
Overvoltage category	III	III	III	III
Pollution degree	2	2	2	2
Rated insulation voltage	250 V	250 V	250 V	250 V
Rated impulse withstand voltage	6 kV	6 kV	6 kV	6 kV
Protection type				
in accordance with the standard	EN 60529	EN 60529	EN 60529	EN 60529
Housing	IP20	IP20	IP20	IP20
Terminals	IP20	IP20	IP20	IP20
Mounting area (e.g. control cabinet)	IP54	IP54	IP54	IP54
Potential isolation	773100	773103	773104	773105
Potential isolation between	SC output and system voltage	SC output and system voltage	SC output and system voltage	SC output and system voltage
Type of potential isolation	Protective separation	Protective separation	Protective separation	Protective separation
Rated surge voltage	2500 V	2500 V	2500 V	2500 V
Potential isolation between	Relay output and system voltage	Relay output and system voltage	Relay output and system voltage	Relay output and system voltage
Type of potential isolation	Protective separation	Protective separation	Protective separation	Protective separation
Rated surge voltage	6000 V	6000 V	6000 V	6000 V
Mechanical data	773100	773103	773104	773105
Mounting position	horizontally on mounting rail	horizontally on mounting rail	horizontally on mounting rail	horizontally on mounting rail
DIN rail				
Top hat rail	35 x 7,5 EN 50022	35 x 7,5 EN 50022	35 x 7,5 EN 50022	35 x 7,5 EN 50022
Recess width	27 mm	27 mm	27 mm	27 mm
Cable length				
Max. cable length per input	1 km	1 km	1 km	1 km
Sum of individual cable lengths at the test pulse output	40 km	40 km	40 km	40 km

Mechanical data	773100	773103	773104	773105
Material				
Bottom	PPO UL 94 V0	PPO UL 94 V0	PPO UL 94 V0	PPO UL 94 V0
Front	ABS UL 94 V0	ABS UL 94 V0	ABS UL 94 V0	ABS UL 94 V0
Connection type	Spring-loaded terminal, screw terminal	Spring-loaded terminal, screw terminal	Spring-loaded terminal, screw terminal	Spring-loaded terminal, screw terminal
Conductor cross section with screw terminals				
1 core flexible	0,25 - 1,5 mm², 24 - 16 AWG	0,25 - 1,5 mm², 24 - 16 AWG	0,25 - 1,5 mm², 24 - 16 AWG	0,25 - 1,5 mm², 24 - 16 AWG
2 core with the same cross section, flexible without crimp connectors or with TWIN crimp connectors	0,25 - 0,75 mm², 24 - 20 AWG	0,25 - 0,75 mm², 24 - 20 AWG	0,25 - 0,75 mm², 24 - 20 AWG	0,25 - 0,75 mm², 24 - 20 AWG
Conductor cross section with screw terminals (relay outputs)				
1 core flexible	0,25 - 2,5 mm², 24 - 12 AWG	0,25 - 2,5 mm², 24 - 12 AWG	0,25 - 2,5 mm², 24 - 12 AWG	0,25 - 2,5 mm², 24 - 12 AWG
2 core with the same cross section, flexible without crimp connectors or with TWIN crimp connectors	0,25 - 1,5 mm², 24 - 16 AWG	0,25 - 1,5 mm², 24 - 16 AWG	0,25 - 1,5 mm², 24 - 16 AWG	0,25 - 1,5 mm², 24 - 16 AWG
Torque setting with screw terminals	0,25 Nm	0,25 Nm	0,25 Nm	0,25 Nm
Torque setting with screw terminals (relay outputs)	0,5 Nm	0,5 Nm	0,5 Nm	0,5 Nm
Stripping length with screw terminals	7 mm	7 mm	7 mm	7 mm
Stripping length with screw terminals (relay outputs)	8 mm	8 mm	8 mm	8 mm
Conductor cross section with spring-loaded terminals				
1 core flexible without crimp connector	0,25 - 1,5 mm², 24 - 16 AWG	0,25 - 1,5 mm², 24 - 16 AWG	0,25 - 1,5 mm², 24 - 16 AWG	0,25 - 1,5 mm², 24 - 16 AWG
1 core flexible with crimp connector	0,25 - 0,75 mm², 24 - 20 AWG	0,25 - 0,75 mm², 24 - 20 AWG	0,25 - 0,75 mm², 24 - 20 AWG	0,25 - 0,75 mm², 24 - 20 AWG

Mechanical data	773100	773103	773104	773105
Conductor cross section with spring-loaded terminals (relay outputs)				
1 core flexible without crimp connector	0,25 - 2,5 mm², 24 - 12 AWG	0,25 - 2,5 mm², 24 - 12 AWG	0,25 - 2,5 mm², 24 - 12 AWG	0,25 - 2,5 mm², 24 - 12 AWG
1 core flexible with crimp connector	0,25 - 1,5 mm², 24 - 16 AWG	0,25 - 1,5 mm², 24 - 16 AWG	0,25 - 1,5 mm², 24 - 16 AWG	0,25 - 1,5 mm², 24 - 16 AWG
Spring-loaded terminals: Terminal points per connection	1	1	1	1
Stripping length with spring-loaded terminals	9 mm	9 mm	9 mm	9 mm
Stripping length with spring-loaded terminals (relay outputs)	10 mm	10 mm	10 mm	10 mm
Dimensions				
Height	94 mm	94 mm	94 mm	94 mm
Width	135 mm	135 mm	135 mm	135 mm
Depth	121 mm	121 mm	121 mm	121 mm
Weight	499 g	518 g	538 g	519 g

Where standards are undated, the 2020-07 latest editions shall apply.

8.1 Safety characteristic data



NOTICE

You must comply with the safety characteristic data in order to achieve the required safety level for your plant/machine.

Unit	Operating mode	EN ISO 13849-1: 2015 PL	EN ISO 13849-1: 2015 Category	EN IEC 62061 SIL CL/maximum SIL	EN IEC 62061 PFH _D [1/h]	EN ISO 13849-1: 2015 T _M [year]
------	----------------	-------------------------	-------------------------------	---------------------------------	-------------------------------------	--

Logic						
CPU	2-channel	PL e	Cat. 4	SIL CL 3	4,90E-09	20
Expansion	–	PL e	Cat. 4	SIL CL 3	9,20E-09	20
Input						
Inputs	1-channel	PL d	Cat. 2	SIL CL 2	2,50E-09	20
Inputs	2-channel	PL e	Cat. 4	SIL CL 3	2,90E-10	20
Inputs	Short circuit-forming safety mats	PL d	Cat. 3	SIL CL 2	1,81E-09	20
Inputs	1-ch., pulsed light barrier	PL e	Cat. 4	SIL CL 3	2,50E-10	20
Cascad. inputs	–	PL e	Cat. 4	SIL CL 3	3,10E-10	20
Output						
SC outputs	1-channel	PL d	Cat. 2	SIL CL 2	7,00E-09	20
SC outputs	2-channel	PL e	Cat. 4	SIL CL 3	8,60E-10	20
Cascad. outputs	–	PL e	Cat. 4	SIL CL 3	4,91E-10	20
Relay outputs	1-channel	PL c	Cat. 1	-	2,90E-08	20
Relay outputs	2-channel	PL e	Cat. 4	SIL CL 3	3,00E-10	20

All the units used within a safety function must be considered when calculating the safety characteristic data.



INFORMATION

A safety function's SIL/PL values are **not** identical to the SIL/PL values of the units that are used and may be different. We recommend that you use the PAscal software tool to calculate the safety function's SIL/PL values.



CAUTION!

It is essential to consider the relay's service life graphs. The relay outputs' safety-related characteristic data is only valid if the values in the service life graphs are met.

The PFH value depends on the switch frequency and the load of the relay output. If the service life graphs are not accessible, the stated PFH value can be used irrespective of the switch frequency and the load, as the PFH value already considers the relay's B10d value as well as the failure rates of the other components.

9 Supplementary data

9.1 Service life graph for the relay contacts

The service life graphs indicate the number of cycles from which failures due to wear must be expected. The wear is mainly caused by the electrical load; the mechanical load is negligible.

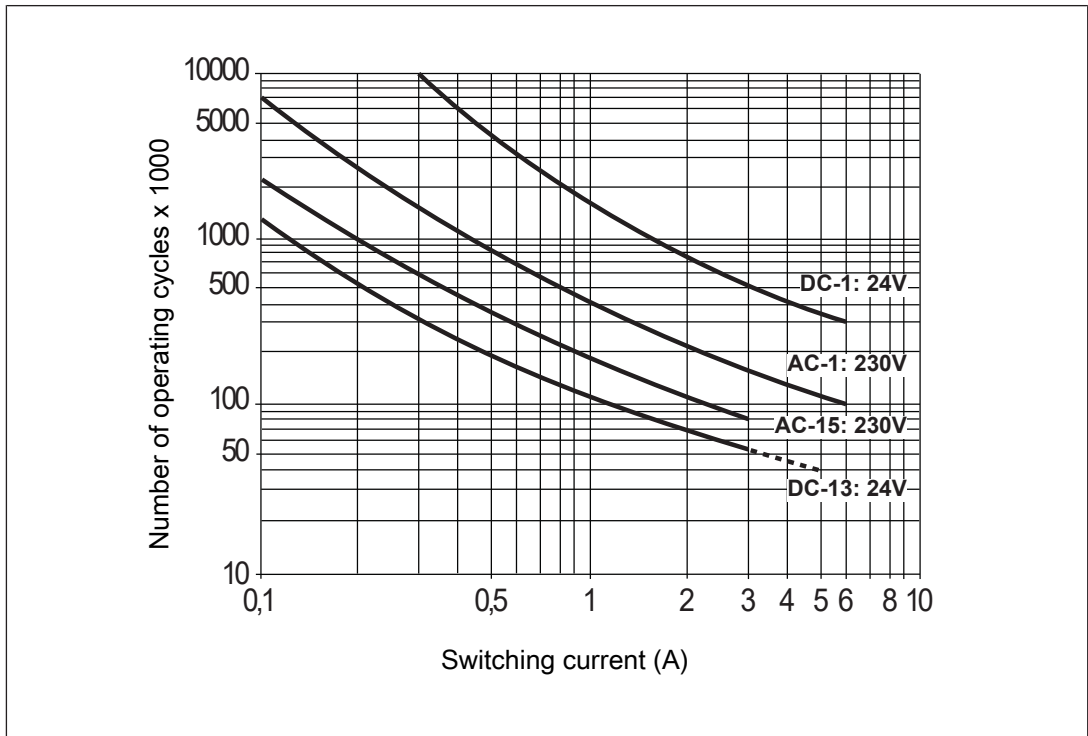

Fig.: Service life graphs at 24 VDC and 230 VAC

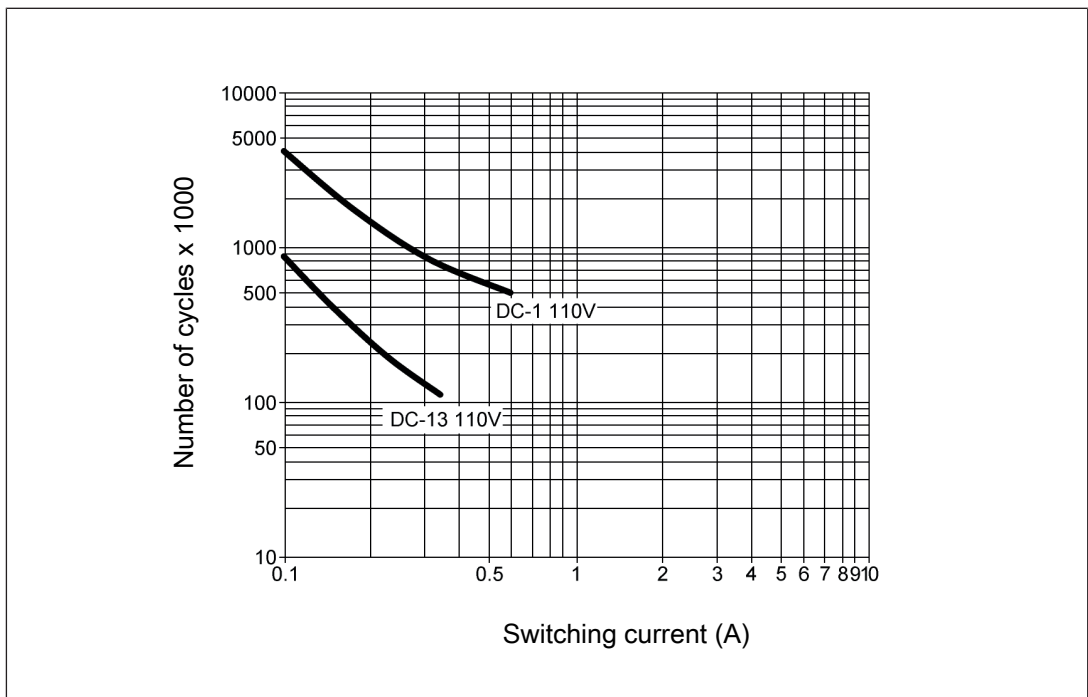

Fig.: Service life graphs at 110 VDC

Example

- ▶ Inductive load: 0.2 A
- ▶ Utilisation category: AC15
- ▶ Contact service life: 1 000 000 cycles

Provided the application to be implemented requires fewer than 1 000 000 cycles, the PFH value (see [Technical details \[📖 31\]](#)) can be used in the calculation.

To increase the service life, sufficient spark suppression must be provided on all relay contacts. With capacitive loads, any power surges that occur must be noted. With DC contactors, use flywheel diodes for spark suppression.

We recommend you use semiconductor outputs to switch 24 VDC loads.

10 Order reference

10.1 Product

Product type	Features	Order no.
PNOZ m1p	Base unit	773100
PNOZ m1p coated version	Base unit, coated version	773105
PNOZ m1p ETH	Base unit, Ethernet interface	773103
PNOZ m1p ETH coated version	Base unit, Ethernet interface, coated version	773104

10.2 Accessories

Connection terminals

Product type	Features	Order no.
Set spring terminals	1 set of spring-loaded terminals	783100
Set screw terminals	1 set of screw terminals	793100

Terminator, jumper

Product type	Features	Order no.
PNOZmulti bus terminator	Terminator	779110
PNOZmulti bus terminator coated	Terminator, coated version	779112
KOP-XE	Jumper	774639
KOP-XE coated	Jumper, coated version	774640

► Support

Technical support is available from Pilz round the clock.

Americas

Brazil

+55 11 97569-2804

Canada

+1 888 315 7459

Mexico

+52 55 5572 1300

USA (toll-free)

+1 877-PILZUSA (745-9872)

Asia

China

+86 21 60880878-216

Japan

+81 45 471-2281

South Korea

+82 31 778 3300

Australia and Oceania

Australia

+61 3 95600621

New Zealand

+64 9 6345350

Europe

Austria

+43 1 7986263-0

Belgium, Luxembourg

+32 9 3217570

France

+33 3 88104003

Germany

+49 711 3409-444

Ireland

+353 21 4804983

Italy, Malta

+39 0362 1826711

Scandinavia

+45 74436332

Spain

+34 938497433

Switzerland

+41 62 88979-32

The Netherlands

+31 347 320477

Turkey

+90 216 5775552

United Kingdom

+44 1536 462203

You can reach our international hotline on:

+49 711 3409-222

support@pilz.com

Pilz develops environmentally-friendly products using ecological materials and energy-saving technologies. Offices and production facilities are ecologically designed, environmentally-aware and energy-saving. So Pilz offers sustainability, plus the security of using energy-efficient products and environmentally-friendly solutions.



We are represented internationally. Please refer to our homepage www.pilz.com for further details or contact our headquarters.

Headquarters: Pilz GmbH & Co. KG, Felix-Wankel-Straße 2, 73760 Ostfildern, Germany
Telephone: +49 711 3409-0, Telefax: +49 711 3409-133, E-Mail: info@pilz.com, Internet: www.pilz.com

PILZ
THE SPIRIT OF SAFETY

20878-EN-18, 2022-11 Printed in Germany
© Pilz GmbH & Co. KG, 2019

CECE®, CHRE®, CMSE®, InduraNET p®, Leansafe®, Master of Safety®, Master of Security®, PAS4000®, PAScall®, PASconfig®, Pilz®, PTT®, PLID®, PMCPirimo®, PMCPiritego®, PMCTendo®, PMD®, PMJ®, PNOZ®, PRBM®, PRCM®, PRIMO®, PRM®, PSEN®, PSENi®, PSS®, PVS®, SafetyBUS p®, SafetyEYE®, SafetyNET p®, THE SPIRIT OF SAFETY® are registered and protected trademarks of Pilz GmbH & Co. KG in some countries. We would point out that product features may vary from the details stated in this document, depending on the status at the time of publication and the scope of the equipment. We accept no responsibility for the validity, accuracy and entirety of the text and graphics presented in this information. Please contact our Technical Support if you have any questions.