



## PNOZ m EF 4DI4DOR

**PILZ**  
THE SPIRIT OF SAFETY

- ▶ Configurable, safe small controllers PNOZmulti 2

This document is the original document.

Where unavoidable, for reasons of readability, the masculine form has been selected when formulating this document. We do assure you that all persons are regarded without discrimination and on an equal basis.

All rights to this documentation are reserved by Pilz GmbH & Co. KG. Copies may be made for the user's internal purposes. Suggestions and comments for improving this documentation will be gratefully received.

Pilz®, PIT®, PMI®, PNOZ®, Primo®, PSEN®, PSS®, PVIS®, SafetyBUS p®, SafetyEYE®, SafetyNET p®, the spirit of safety® are registered and protected trademarks of Pilz GmbH & Co. KG in some countries.



SD means Secure Digital

<b>1</b>	<b>Introduction</b>	<b>5</b>
1.1	Validity of documentation	5
1.2	Using the documentation	5
1.3	Definition of symbols	5
<b>2</b>	<b>Overview</b>	<b>7</b>
2.1	Scope of supply	7
2.2	Unit features	7
2.3	Front view	8
<b>3</b>	<b>Safety</b>	<b>9</b>
3.1	Intended use	9
3.2	System requirements	10
3.3	Safety regulations	10
3.3.1	Safety assessment	10
3.3.2	Use of qualified personnel	10
3.3.3	Warranty and liability	10
3.3.4	Disposal	11
3.3.5	For your safety	11
<b>4</b>	<b>Function description</b>	<b>12</b>
4.1	Integrated protection mechanisms	12
4.2	Functions	12
4.3	System reaction time	12
4.4	Block diagram	12
<b>5</b>	<b>Installation</b>	<b>13</b>
5.1	General installation guidelines	13
5.2	Dimensions in mm	13
5.3	Connecting the base unit and expansion modules	14
<b>6</b>	<b>Commissioning</b>	<b>15</b>
6.1	General wiring guidelines	15
6.2	Connection	15
6.3	Download modified project to the PNOZmulti system	16
<b>7</b>	<b>Operation</b>	<b>17</b>
7.1	LED indicators	17
7.2	Function test of the relay outputs	18
<b>8</b>	<b>Technical details</b>	<b>19</b>
8.1	Safety characteristic data	22
8.2	Classification according to ZVEI, CB24I	23
<b>9</b>	<b>Supplementary data</b>	<b>24</b>
9.1	Service life graph for the relay contacts	24
9.2	Permitted ambient temperature $T_{amb}$ dependent on the total current $I_{sum}$	25

<b>10</b>	<b>Order reference .....</b>	<b>26</b>
10.1	Product.....	26
10.2	Accessories.....	26
10.2.1	Terminals .....	26
10.2.2	Connector plug.....	26
<b>11</b>	<b>EC declaration of conformity .....</b>	<b>27</b>
<b>12</b>	<b>UKCA-Declaration of Conformity .....</b>	<b>28</b>

# 1 Introduction

## 1.1 Validity of documentation

This documentation is valid for the product PNOZ m EF 4DI4DOR. It is valid until new documentation is published.

This operating manual explains the function and operation, describes the installation and provides guidelines on how to connect the product.

## 1.2 Using the documentation

This document is intended for instruction. Only install and commission the product if you have read and understood this document. The document should be retained for future reference.

## 1.3 Definition of symbols

Information that is particularly important is identified as follows:



### **DANGER!**

This warning must be heeded! It warns of a hazardous situation that poses an immediate threat of serious injury and death and indicates preventive measures that can be taken.



### **WARNING!**

This warning must be heeded! It warns of a hazardous situation that could lead to serious injury and death and indicates preventive measures that can be taken.



### **CAUTION!**

This refers to a hazard that can lead to a less serious or minor injury plus material damage, and also provides information on preventive measures that can be taken.



### **NOTICE**

This describes a situation in which the product or devices could be damaged and also provides information on preventive measures that can be taken. It also highlights areas within the text that are of particular importance.



**INFORMATION**

This gives advice on applications and provides information on special features.

## 2 Overview

### 2.1 Scope of supply

- ▶ Expansion module PNOZ m EF 4DI4DOR
- ▶ Jumper

### 2.2 Unit features

Application of the product PNOZ m EF 4DI4DOR:

Expansion module for connection to a base unit from the PNOZmulti 2 system.

The product has the following features:

- ▶ Can be configured in the PNOZmulti Configurator
- ▶ Positive-guided relay outputs:
  - 4 safety outputs  
depending on the application, up to PL e of EN ISO 13849-1 and up to SIL 3 of EN IEC 62061
- ▶ 4 inputs for connecting, for example:
  - Emergency stop pushbuttons
  - Two-hand pushbuttons
  - Safety gate limit switches
  - Start buttons
  - Light barriers
  - Scanner
  - Enabling switches
  - PSEN
  - Operating mode selector switches
- ▶ LED display for:
  - Error messages
  - Diagnostics
  - Supply voltage
  - Output circuits
  - Input circuits
- ▶ Test pulse outputs used to monitor shorts across the inputs
- ▶ Monitoring of shorts between the safety outputs
- ▶ Plug-in connection terminals:  
Either spring-loaded terminal or screw terminal available as accessories (see Order references)
- ▶ Please refer to the document "PNOZmulti System Expansion" for the PNOZmulti base units that can be connected.

## 2.3 Front view

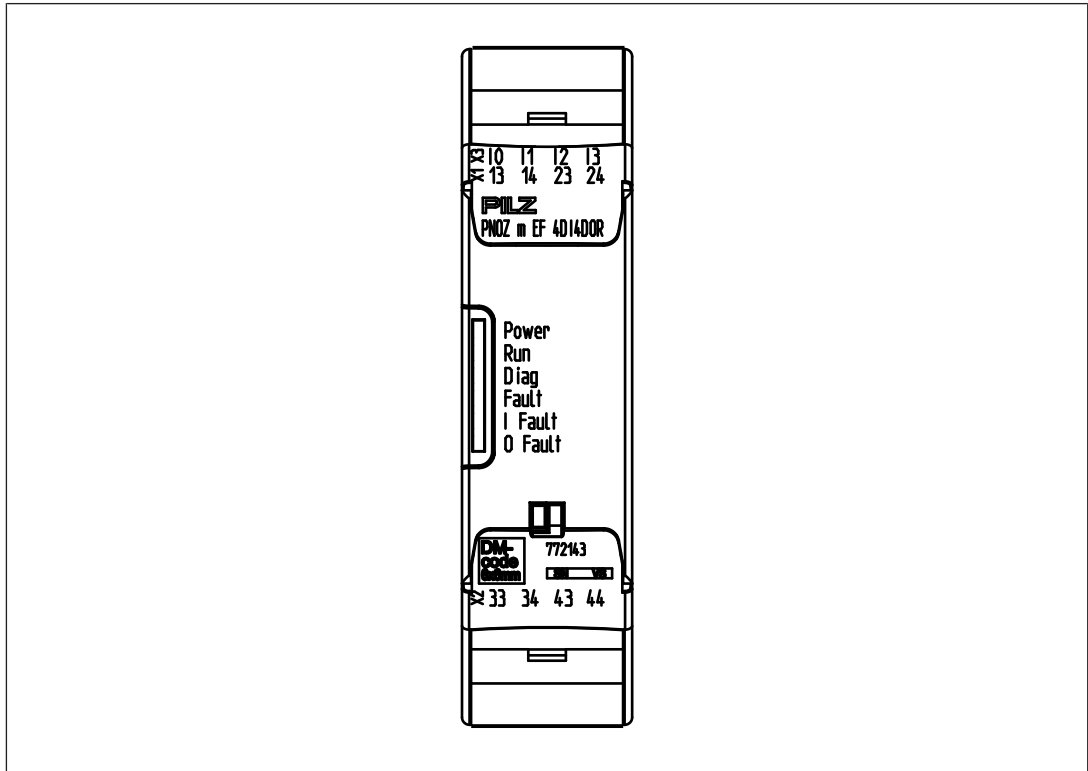

Legend:

- ▶ Inputs I0 – I3
- ▶ Outputs O0 – O3
- ▶ LEDs:
  - POWER
  - Run
  - Diag
  - Fault
  - I Fault
  - O Fault



## 3 Safety

### 3.1 Intended use

The expansion module may only be connected to a base unit from the configurable system PNOZmulti 2 (please refer to the document "PNOZmulti System Expansion" for details of the base units that can be connected).

The configurable system PNOZmulti 2 is used for the safety-related interruption of safety circuits and is designed for use in:

- ▶ Emergency stop equipment
- ▶ Safety circuits in accordance with VDE 0113 Part 1 and EN 60204-1

#### Lifts Directive

The product PNOZ m EF 4DI4DOR can be used as a PESSRAL (programmable electronic system in safety-related applications for lifts) in accordance with the Lifts Directive 2014/33/EU. It meets the requirements for passenger and goods lifts in accordance with EN 81-1/2, EN 81-20, EN 81-22 and EN 81-50, as well as the requirements for escalators and moving walks in accordance with EN 115-1.

The safety controller should be installed in a protected environment that meets at least the requirements of pollution degree 2.

Example: Protected inside space or control cabinet with protection type IP54 and appropriate air conditioning.

#### Use in furnaces

The module PNOZ m EF 4DI4DOR can be used in furnaces in accordance with EN 298. If the module's relay outputs shut down the entire fuel supply and the furnace is used in continuous operation, appropriate external measures must be used to establish diversity of the shutdown elements (requirement of EN 50156-1). For example, an appropriate measure may be an additional, monitored switching element (contactor or relay), which is activated by a safe semiconductor output and is switched in series with both relay outputs.

#### Improper use

The following is deemed improper use in particular

- ▶ Any component, technical or electrical modification to the product,
- ▶ Use of the product outside the areas described in this operating manual,
- ▶ Use of the product outside the technical details (see [Technical details](#)  19).



#### NOTICE

##### EMC-compliant electrical installation

The product is designed for use in an industrial environment. The product may cause interference if installed in other environments. If installed in other environments, measures should be taken to comply with the applicable standards and directives for the respective installation site with regard to interference.

## 3.2 System requirements

Please refer to the "Product Modifications PNOZmulti" document in the "Version overview" section for details of which versions of the base unit and PNOZmulti Configurator can be used for this product.

## 3.3 Safety regulations

### 3.3.1 Safety assessment

Before using a device it is necessary to perform a safety assessment in accordance with the Machinery Directive.

Functional safety is guaranteed for the product as a single component. However, this does not guarantee the functional safety of the overall plant/machine. In order to achieve the required safety level for the overall plant/machine, define the safety requirements for the plant/machine and then define how these must be implemented from a technical and organisational standpoint.

### 3.3.2 Use of qualified personnel

The products may only be assembled, installed, programmed, commissioned, operated, maintained and decommissioned by competent persons.

A competent person is someone who, because of their training, experience and current professional activity, has the specialist knowledge required to test, assess and operate the work equipment, devices, systems, plant and machinery in accordance with the general standards and guidelines for safety technology.

It is the company's responsibility only to employ personnel who

- ▶ Are familiar with the basic regulations concerning health and safety / accident prevention,
- ▶ Have read and understood the information provided in this description under "Safety",
- ▶ And have a good knowledge of the generic and specialist standards applicable to the specific application.

### 3.3.3 Warranty and liability

All claims to warranty and liability will be rendered invalid if

- ▶ The product was used contrary to the purpose for which it is intended,
- ▶ Damage can be attributed to not having followed the guidelines in the manual,
- ▶ Operating personnel are not suitably qualified,
- ▶ Any type of modification has been made (e.g. exchanging components on the PCB boards, soldering work etc.).

### 3.3.4 Disposal

- ▶ In safety-related applications, please comply with the mission time  $T_M$  in the safety-related characteristic data.
- ▶ When decommissioning, please comply with local regulations regarding the disposal of electronic devices (e.g. Electrical and Electronic Equipment Act).

### 3.3.5 For your safety

The unit meets all the necessary conditions for safe operation. However, you should always ensure that the following safety requirements are met:

- ▶ This operating manual only describes the basic functions of the unit. The expanded functions are described in the PNOZmulti Configurator's online help. Only use these functions once you have read and understood the documentations.
- ▶ Do not open the housing or make any unauthorised modifications.
- ▶ Please make sure you shut down the supply voltage when performing maintenance work (e.g. exchanging contactors).

## 4 Function description

### 4.1 Integrated protection mechanisms

The relay meets the following safety requirements:

- ▶ The circuit is redundant with built-in self-monitoring.
- ▶ The safety device remains effective in the case of a component failure.
- ▶ The relay contacts meet the requirements for protective separation through increased insulation compared with all other circuits in the safety system.

### 4.2 Functions

The expansion module provides additional inputs and additional relay outputs.

The function of the inputs and outputs on the control system depends on the safety circuit created using the PNOZmulti Configurator. A removable data medium is used to download the safety circuit to the base unit. The base unit has 2 microcontrollers that monitor each other. They evaluate the input circuits on the base unit and expansion modules and switch the outputs on the base unit and expansion modules accordingly.

The online help on the PNOZmulti Configurator contains descriptions of the operating modes and all the functions of the PNOZmulti control system, plus connection examples.

### 4.3 System reaction time

Calculation of the maximum reaction time between an input switching off and a linked output in the system switching off is described in the document "PNOZmulti System Expansion".

### 4.4 Block diagram

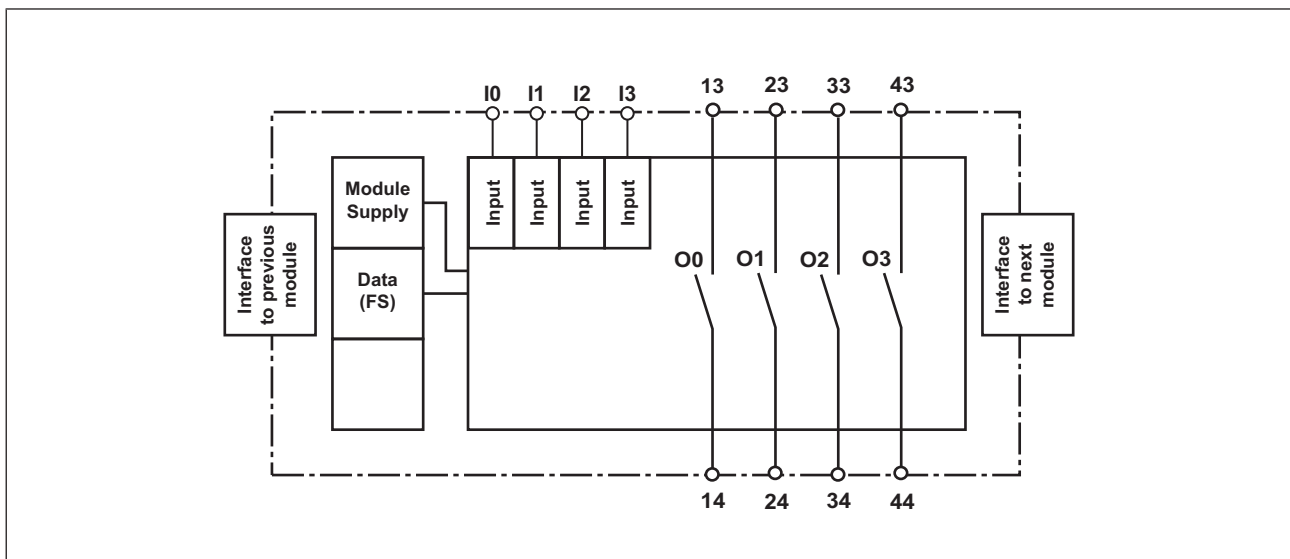

## 5 Installation

### 5.1 General installation guidelines

- ▶ The unit should be installed in a control cabinet with a protection type of at least IP54.
- ▶ Fit the safety system to a horizontal mounting rail. The venting slots must face upward and downward. Other mounting positions could damage the safety system.
- ▶ Use the locking elements on the rear of the unit to attach it to a mounting rail.
- ▶ In environments exposed to heavy vibration, the unit should be secured using a fixing element (e.g. retaining bracket or end angle).
- ▶ Open the locking slide before lifting the unit from the mounting rail.
- ▶ To comply with EMC requirements, the mounting rail must have a low impedance connection to the control cabinet housing.
- ▶ The ambient temperature of the PNOZmulti units in the control cabinet must not exceed the figure stated in the technical details. Air conditioning may otherwise be required.



#### NOTICE

Damage due to electrostatic discharge!

Electrostatic discharge can damage components. Ensure against discharge before touching the product, e.g. by touching an earthed, conductive surface or by wearing an earthed armband.

### 5.2 Dimensions in mm

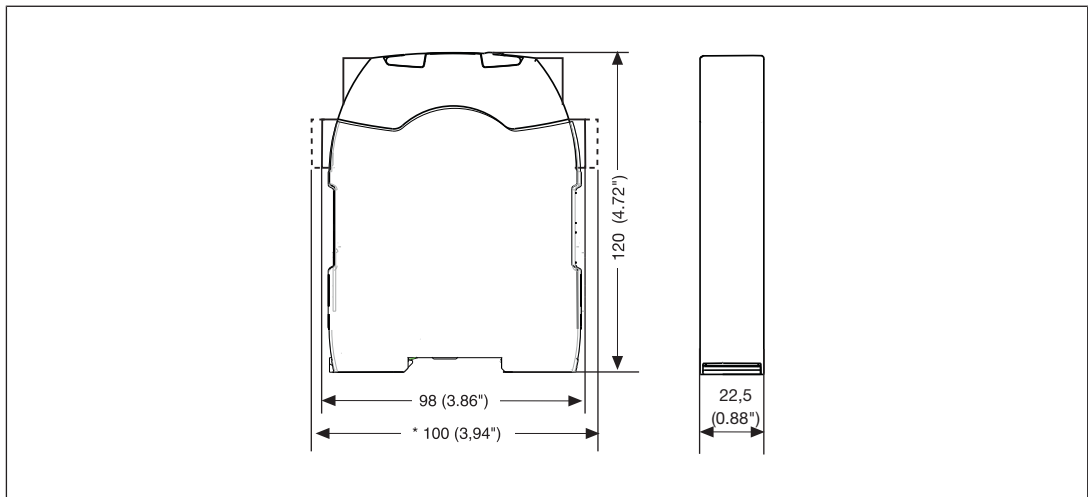

### 5.3 Connecting the base unit and expansion modules

Connect the base unit and the expansion modules as described in the operating manuals for the base modules.

- ▶ The terminator must be fitted to the last expansion module
- ▶ Install the expansion module in the position configured in the PNOZmulti Configurator.

The position of the expansion modules is defined in the PNOZmulti Configurator. The expansion modules are connected to the left or right of the base unit, depending on the type.

Please refer to the document "PNOZmulti System Expansion" for details of the number of modules that can be connected to the base unit and the module types.

## 6 Commissioning

### 6.1 General wiring guidelines

The wiring is defined in the circuit diagram of the PNOZmulti Configurator.

Please note:

- ▶ Information given in the [Technical details \[19\]](#) must be followed.
- ▶ The position of the expansion module is specified in the Hardware configuration of the PNOZmulti Configurator.
- ▶ Use copper wiring with a temperature stability of 75 °C.
- ▶ To prevent contact welding, a fuse should be connected before the output contacts (see [Technical details \[19\]](#)).
- ▶ Adequate protection must be provided on all output contacts with capacitive and inductive loads.

### 6.2 Connection

Input circuit	Single-channel	Dual-channel
Example: E-Stop without detection of shorts across contacts		
Example: E-Stop with detection of shorts across contacts		

Relay outputs		
Dual output		
Single output		
Feedback loop		
Contacts from external contactors		

### 6.3 Download modified project to the PNOZmulti system

As soon as an additional expansion module has been connected to the system, the project must be amended in the PNOZmulti Configurator and downloaded back into the base unit. Proceed as described in the operating manual for the base unit.



**NOTICE**

For the commissioning and after every user program change, you must check whether the safety devices are functioning correctly.





















## 7 Operation

The PNOZmulti system is ready for operation when the "POWER" and "RUN" LEDs on the base unit are lit continuously.

### 7.1 LED indicators

**Legend**

-  LED on
-  LED flashes
-  LED off

LED						Error
POWER	Run	Diag	Fault	IFault	OFault	
						No supply voltage
						Expansion module PNOZ m EF 4DI4DOR running without error.
						Expansion module PNOZ m EF 4DI4DOR is in a STOP condition.
						Internal error on the expansion module PNOZ m EF 4DI4DOR or on the overall system. Expansion module is in a safe condition.
						External error on the expansion module PNOZ m EF 4DI4DOR or on the overall system. Expansion module is in a safe condition.
						Internal error on the inputs of the expansion module PNOZ m EF 4DI4DOR. Expansion module is in a safe condition, e.g. pulse error.
						Internal error on the outputs of the expansion module PNOZ m EF 4DI4DOR. Expansion module is in a safe condition.
						External error on the inputs of the expansion module PNOZ m EF 4DI4DOR. Expansion module is in a safe condition.
						External error on the outputs of the expansion module PNOZ m EF 4DI4DOR. Expansion module is in a safe condition, e.g. defective feedback loop.

## 7.2 Function test of the relay outputs

When the relay outputs are switched on, the mechanical contact on the relay cannot be tested automatically. Depending on the operational environment, measures to detect the non-opening of switching elements may be required under some circumstances.

When the product is used in accordance with the European Machinery Directive, a check must be carried out to ensure that the safety contacts on the relay outputs open correctly. Start the device again or open the safety contacts (switch off output), so that the internal diagnostics can check the correct opening of the safety contacts

- ▶ for SIL 3/PL e at least 1x per month
- ▶ for SIL 2/PL d at least 1x per year

## 8 Technical details

<b>General</b>	
Certifications	<b>CE, EAC, KOSHA, TÜV, UKCA, cULus Listed</b>
Application range	<b>Failsafe</b>
Module's device code	<b>00E1h</b>
<b>Electrical data</b>	
Supply voltage	
for	<b>Module supply</b>
internal	<b>Via base unit</b>
Voltage	<b>24 V</b>
Kind	<b>DC</b>
Current consumption	<b>122 mA</b>
Power consumption	<b>3 W</b>
Max. power dissipation of module	<b>6,5 W</b>
Status indicator	<b>LED</b>
Permitted loads	<b>inductive, resistive</b>
<b>Inputs</b>	
Number	<b>4</b>
Input voltage in accordance with EN 61131-2 Type 1	<b>24 V DC</b>
Input current at rated voltage	<b>5 mA</b>
Input current range	<b>2,5 - 5,3 mA</b>
Pulse suppression	<b>0,5 ms</b>
Maximum input delay	<b>8 ms</b>
Potential isolation	<b>No</b>
<b>Relay outputs</b>	
Number of relay outputs	<b>4</b>
Utilisation category	
In accordance with the standard	<b>EN 60947-4-1</b>
Utilisation category of safety contacts	
AC1 at	<b>250 V</b>
Min. current	<b>10 mA</b>
Max. current	<b>6 A</b>
Max. power	<b>1500 VA</b>
DC1 at	<b>24 V</b>
Min. current	<b>10 mA</b>
Max. current	<b>6 A</b>
Max. power	<b>144 W</b>
Utilisation category	
In accordance with the standard	<b>EN 60947-5-1</b>

### Relay outputs

#### Utilisation category of safety contacts

AC15 at	<b>230 V</b>
Max. current	<b>3 A</b>
Max. power	<b>690 W</b>
DC13 (6 cycles/min) at	<b>24 V</b>
Max. current	<b>3 A</b>
Max. power	<b>72 W</b>

#### Utilisation category in accordance with UL

Voltage	<b>240 V AC G.U. Resistive</b>
With current	<b>6 A</b>
Voltage	<b>24 V DC G. U. Resistive</b>
With current	<b>6 A</b>
Pilot Duty; R300	<b>24 V DC</b>
With current	<b>3 A</b>
Pilot Duty; B300	<b>230 V AC</b>
With current	<b>3 A</b>

#### Airgap creepage between

Relay contacts	<b>3 mm</b>
Relay contacts and other circuits	<b>5,5 mm</b>

#### External contact fuse protection, safety contacts

In accordance with the standard	<b>VDE 0660</b>
Blow-out fuse, quick	<b>10 A</b>
Blow-out fuse, slow	<b>6 A</b>

Switch-off delay **22 ms**

Contact material **AgCuNi + 0,2 µm Au**

Potential isolation **yes**

### Environmental data

#### Ambient temperature

In accordance with the standard	<b>EN 60068-2-14</b>
Temperature range	<b>0 - 60 °C</b>
Forced convection in control cabinet off	<b>55 °C</b>

#### Storage temperature

In accordance with the standard	<b>EN 60068-2-1/-2</b>
Temperature range	<b>-25 - 70 °C</b>

#### Climatic suitability

In accordance with the standard **EN 60068-2-30, EN 60068-2-78**

Condensation during operation **Not permitted**

Max. operating height above sea level **2000 m**

EMC **EN 61131-2**

#### Vibration

In accordance with the standard	<b>EN 60068-2-6</b>
Frequency	<b>5 - 150 Hz</b>
Acceleration	<b>1g</b>

### Environmental data

#### Shock stress

In accordance with the standard	<b>EN 60068-2-27</b>
Acceleration	<b>15g</b>
Duration	<b>11 ms</b>

#### Airgap creepage

In accordance with the standard	<b>EN 61131-2</b>
Overvoltage category	<b>II</b>
Pollution degree	<b>2</b>

#### Protection type

In accordance with the standard	<b>EN 60529</b>
Housing	<b>IP20</b>
Terminals	<b>IP20</b>
Mounting area (e.g. control cabinet)	<b>IP54</b>

### Potential isolation

Potential isolation between	<b>Relay output and system voltage</b>
Type of potential isolation	<b>Protective separation</b>
Rated insulation voltage	<b>250 V</b>
Rated surge voltage	<b>4000 V</b>

### Mechanical data

Mounting position	<b>horizontally on mounting rail</b>
Mechanical life	<b>10,000,000 cycles</b>
DIN rail	
Top hat rail	<b>35 x 7,5 EN 50022</b>
Recess width	<b>27 mm</b>
Cable length	
Max. cable length per input	<b>1 km</b>
Material	
Bottom	<b>PC</b>
Front	<b>PC</b>
Top	<b>PC</b>
Connection type	<b>Spring-loaded terminal, screw terminal</b>
Mounting type	<b>plug-in</b>
Conductor cross section with screw terminals	
1 core flexible	<b>0,25 - 2,5 mm<sup>2</sup>, 24 - 12 AWG</b>
2 core with the same cross section, flexible without crimp connectors or with TWIN crimp connectors	<b>0,2 - 1,5 mm<sup>2</sup>, 24 - 16 AWG</b>
Torque setting with screw terminals	<b>0,5 Nm</b>
Conductor cross section with spring-loaded terminals:	
Flexible with/without crimp connector	<b>0,2 - 2,5 mm<sup>2</sup>, 24 - 12 AWG</b>
Spring-loaded terminals: Terminal points per connection	<b>2</b>
Stripping length with spring-loaded terminals	<b>9 mm</b>

**Mechanical data**

Dimensions

Height	101,4 mm
Width	22,5 mm
Depth	120 mm

Weight	190 g
--------	-------

Where standards are undated, the 2012-04 latest editions shall apply.

**8.1 Safety characteristic data**



**NOTICE**

You must comply with the safety characteristic data in order to achieve the required safety level for your plant/machine.

Unit	Operating mode	EN ISO 13849-1: 2015 PL	EN ISO 13849-1: 2015 Category	EN IEC 62061 SIL CL/max-imum SIL	EN IEC 62061 PFH <sub>D</sub> [1/h]	EN ISO 13849-1: 2015 T <sub>M</sub> [year]
------	----------------	-------------------------	-------------------------------	----------------------------------	-------------------------------------	--------------------------------------------

**Logic**

CPU	2-channel	PL e	Cat. 4	SIL 3	2,84E-10	20
-----	-----------	------	--------	-------	----------	----

**Input**

Inputs	1-channel	PL d	Cat. 2	SIL 2	2,10E-09	20
--------	-----------	------	--------	-------	----------	----

Inputs	2-channel	PL e	Cat. 4	SIL 3	4,27E-11	20
--------	-----------	------	--------	-------	----------	----

Inputs	Short circuit-forming safety mats	PL d	Cat. 3	SIL 2	1,80E-10	20
--------	-----------------------------------	------	--------	-------	----------	----

Inputs	1-ch., pulsed light barrier	PL e	Cat. 4	SIL 3	2,10E-10	20
--------	-----------------------------	------	--------	-------	----------	----

**Output**

Relay outputs	1-channel	PL c	Cat. 1	-	3,75E-08	20
---------------	-----------	------	--------	---	----------	----

Relay outputs	2-channel	PL e	Cat. 4	SIL 3	7,52E-12	20
---------------	-----------	------	--------	-------	----------	----

All the units used within a safety function must be considered when calculating the safety characteristic data.



**INFORMATION**

A safety function's SIL/PL values are **not** identical to the SIL/PL values of the units that are used and may be different. We recommend that you use the PAscal software tool to calculate the safety function's SIL/PL values.



**CAUTION!**

It is essential to consider the relay's service life graphs. The relay outputs' safety-related characteristic data is only valid if the values in the service life graphs are met.

The PFH value depends on the switch frequency and the load of the relay output. If the service life graphs are not accessible, the stated PFH value can be used irrespective of the switch frequency and the load, as the PFH value already considers the relay's B10d value as well as the failure rates of the other components.

## 8.2 Classification according to ZVEI, CB24I

The following tables describe the classes and specific values of the product interface and the classes of interfaces compatible with it. The classification is described in the ZVEI position paper "Classification of Binary 24 V Interfaces - Functional Safety aspects covered by dynamic testing".

Input	
Interfaces	
Drain	
Interface	<b>Module</b>
Class	<b>C2</b>
Source	
Interface	<b>Sensor</b>
Class	<b>C2, C3</b>
Drain parameters	
Max. test pulse duration	<b>500 µs</b>
Min. input resistance	<b>5,6 kOhm</b>
Max. capacitive load	<b>126 nF</b>

## 9 Supplementary data

### 9.1 Service life graph for the relay contacts

The service life graphs indicate the number of cycles from which failures due to wear must be expected. The wear is mainly caused by the electrical load; the mechanical load is negligible.

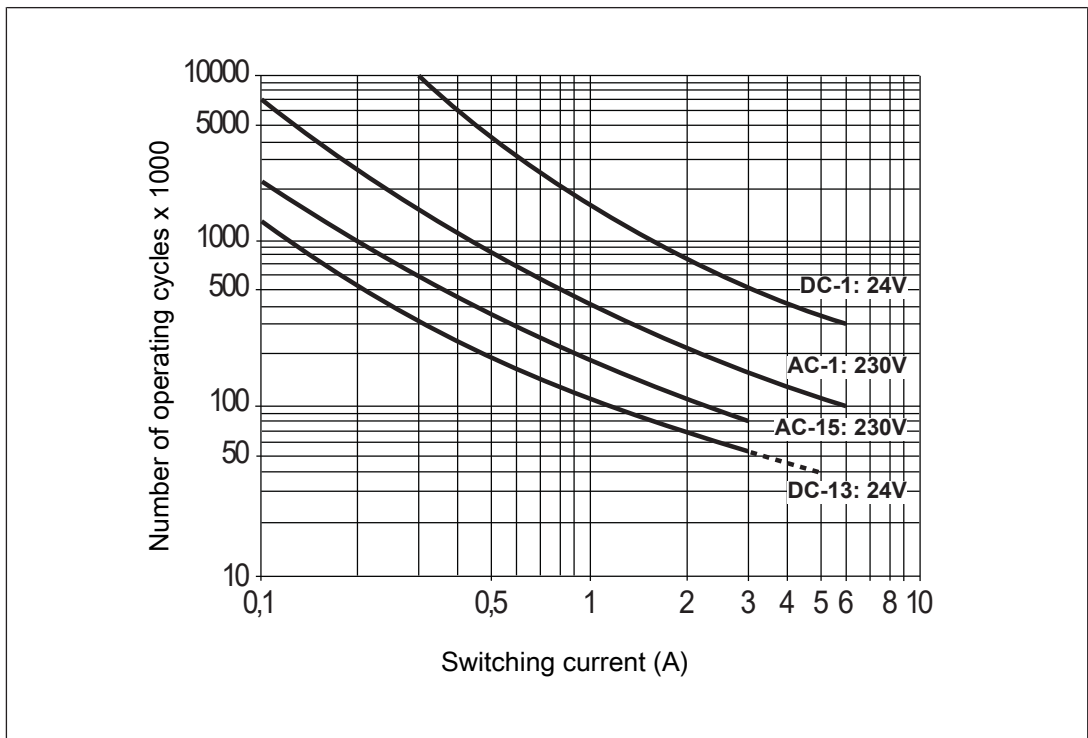

Fig.: Service life graphs at 24 VDC and 230 VAC

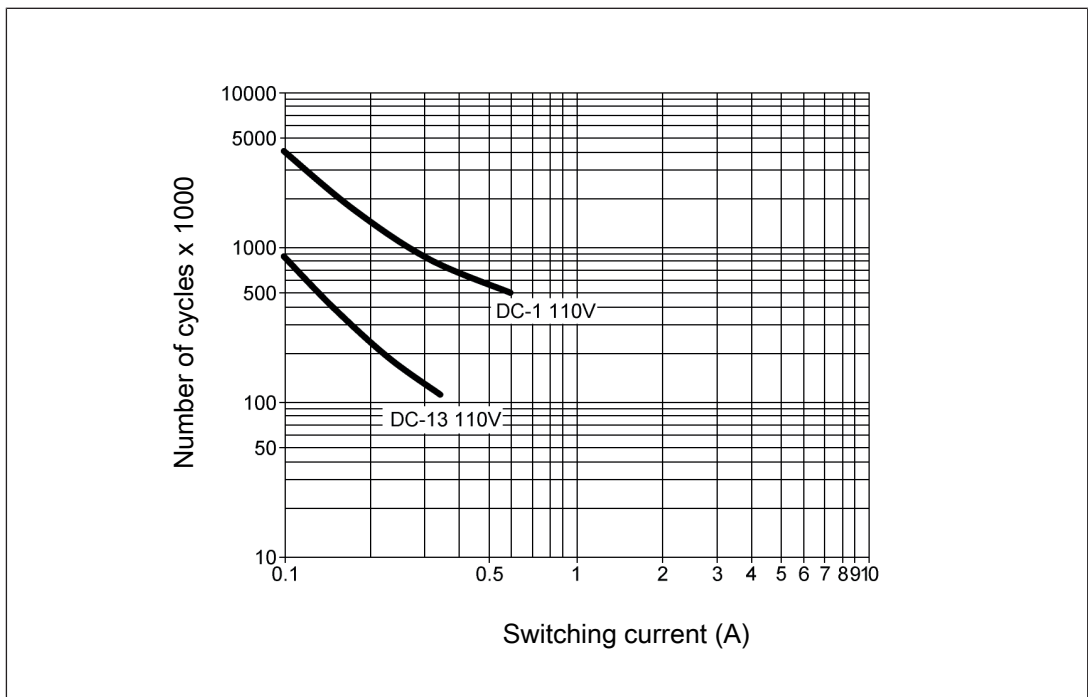

Fig.: Service life graphs at 110 VDC



**Example**

- ▶ Inductive load: 0.2 A
- ▶ Utilisation category: AC15
- ▶ Contact service life: 1 000 000 cycles

Provided the application to be implemented requires fewer than 1 000 000 cycles, the PFH value (see [Technical details \[19\]](#)) can be used in the calculation.

To increase the service life, sufficient spark suppression must be provided on all relay contacts. With capacitive loads, any power surges that occur must be noted. With DC contactors, use flywheel diodes for spark suppression.

We recommend you use semiconductor outputs to switch 24 VDC loads.

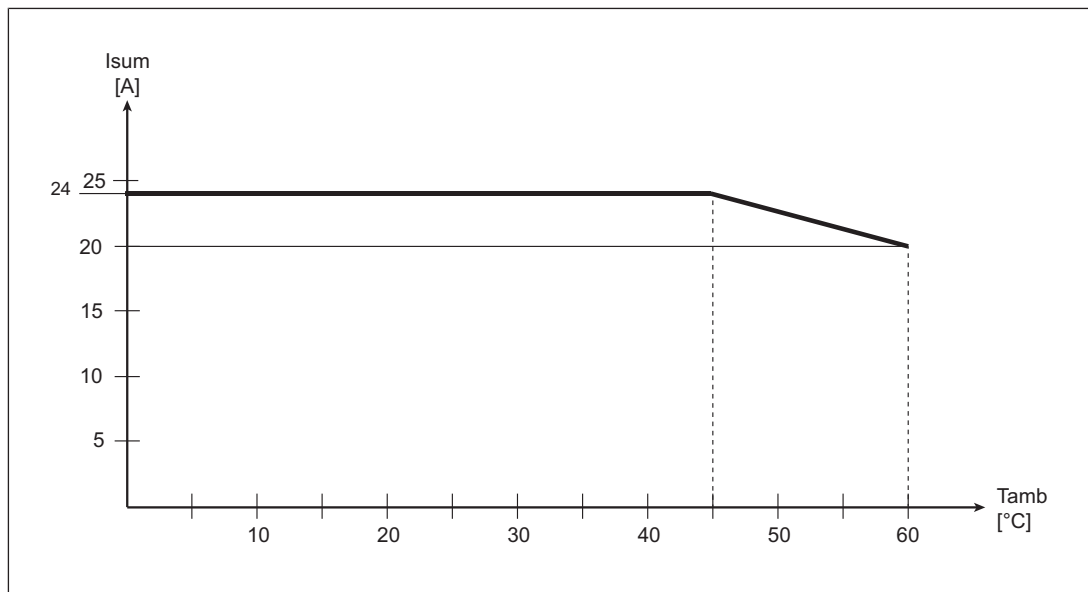
**9.2****Permitted ambient temperature  $T_{amb}$  dependent on the total current  $I_{sum}$** 

Max. permitted total current of relay outputs at an ambient temperature of < 45 °C: 24 A

Max. permitted total current of relay outputs at an ambient temperature of = 60 °C: 20 A

## 10 Order reference

### 10.1 Product

Product type	Features	Order no.
PNOZ m EF 4DI4DOR	Configurable safe small controllers PNOZmulti 2, expansion module, 4 safe digital inputs, 4 safe relay outputs.	772143

### 10.2 Accessories

#### 10.2.1 Terminals

Product type	Features	Order no.
Spring terminals PNOZ mml2p	Spring-loaded terminals, PNOZ mml2p, 1 set.	783540
Screw terminals PNOZ mml2p	Plug-in screw terminals, PNOZ mml2p, 1 set.	793540

#### 10.2.2 Connector plug

Product type	Features	Order no.
PNOZ mm0.xp connector left (10 pcs)	Connector plug to connect the modules to the left-hand side of the PNOZmulti base unit, yellow/black (10 pieces).	779260

## 11 **EC declaration of conformity**

This product/these products meet the requirements of the directive 2006/42/EC for machinery of the European Parliament and of the Council. The complete EC Declaration of Conformity is available on the Internet at [www.pilz.com/downloads](http://www.pilz.com/downloads).

Authorised representative: Norbert Fröhlich, Pilz GmbH & Co. KG, Felix-Wankel-Str. 2, 73760 Ostfildern, Germany

## 12 UKCA-Declaration of Conformity

This product(s) complies with following UK legislation: Supply of Machinery (Safety) Regulation 2008.

The complete UKCA Declaration of Conformity is available on the Internet at [www.pilz.com/downloads](http://www.pilz.com/downloads).

Representative: Pilz Automation Technology, Pilz House, Little Colliers Field, Corby, Northamptonshire, NN18 8TJ United Kingdom, eMail: [mail@pilz.co.uk](mailto:mail@pilz.co.uk)

# ► Support

Technical support is available from Pilz round the clock.

## Americas

### Brazil

+55 11 97569-2804

### Canada

+1 888 315 7459

### Mexico

+52 55 5572 1300

### USA (toll-free)

+1 877-PILZUSA (745-9872)

## Asia

### China

+86 21 60880878-216

### Japan

+81 45 471-2281

### South Korea

+82 31 778 3300

## Australia and Oceania

### Australia

+61 3 95600621

### New Zealand

+64 9 6345350

## Europe

### Austria

+43 1 7986263-0

### Belgium, Luxembourg

+32 9 3217570

### France

+33 3 88104003

### Germany

+49 711 3409-444

### Ireland

+353 21 4804983

### Italy, Malta

+39 0362 1826711

## Scandinavia

+45 74436332

## Spain

+34 938497433

## Switzerland

+41 62 88979-32

## The Netherlands

+31 347 320477

## Turkey

+90 216 5775552

## United Kingdom

+44 1536 462203

## You can reach our international hotline on:

+49 711 3409-222

support@pilz.com

Pilz develops environmentally-friendly products using ecological materials and energy-saving technologies. Offices and production facilities are ecologically designed, environmentally-aware and energy-saving. So Pilz offers sustainability, plus the security of using energy-efficient products and environmentally-friendly solutions.



We are represented internationally. Please refer to our homepage [www.pilz.com](http://www.pilz.com) for further details or contact our headquarters.

Headquarters: Pilz GmbH & Co. KG, Felix-Wankel-Straße 2, 73760 Ostfildern, Germany  
Telephone: +49 711 3409-0, Telefax: +49 711 3409-133, E-Mail: [info@pilz.com](mailto:info@pilz.com), Internet: [www.pilz.com](http://www.pilz.com)

**PILZ**  
THE SPIRIT OF SAFETY

1002702-EN-10, 2022-10 Printed in Germany  
© Pilz GmbH & Co. KG, 2019

CECE®, CHRE®, CMSE®, InduraNET p®, Leansafe®, Master of Safety®, Master of Security®, PAS4000®, PAScale®, PASconfig®, Pilz®, PTT®, PLID®, PMCPirimo®, PMCPiritego®, PMCTendo®, PMD®, PMJ®, PNOZ®, PRCM®, PRM®, PRTM®, PSEN®, PSS®, PVS®, SafetyBUS p®, SafetyEYE®, SafetyNET p®, THE SPIRIT OF SAFETY® are registered and protected trademarks of Pilz GmbH & Co. KG in some countries. We would point out that product features may vary from the details stated in this document, depending on the status at the time of publication and the scope of the equipment. We accept no responsibility for the validity, accuracy and entirety of the text and graphics presented in this information. Please contact our Technical Support if you have any questions.