



## PNOZ m ES ETH

**PILZ**  
THE SPIRIT OF SAFETY

- ▶ Configurable, safe small controllers PNOZmulti 2

This document is the original document.

Where unavoidable, for reasons of readability, the masculine form has been selected when formulating this document. We do assure you that all persons are regarded without discrimination and on an equal basis.

All rights to this documentation are reserved by Pilz GmbH & Co. KG. Copies may be made for the user's internal purposes. Suggestions and comments for improving this documentation will be gratefully received.

Pilz®, PIT®, PMI®, PNOZ®, Primo®, PSEN®, PSS®, PVIS®, SafetyBUS p®, SafetyEYE®, SafetyNET p®, the spirit of safety® are registered and protected trademarks of Pilz GmbH & Co. KG in some countries.



SD means Secure Digital

<b>1</b>	<b>Introduction</b>	<b>5</b>
1.1	Validity of documentation	5
1.2	Using the documentation	5
1.3	Definition of symbols	5
<b>2</b>	<b>Overview</b>	<b>7</b>
2.1	Scope of supply	7
2.2	Unit features	7
2.3	Front view	8
<b>3</b>	<b>Safety</b>	<b>9</b>
3.1	Intended use	9
3.2	System requirements	9
3.3	Safety regulations	10
3.3.1	Use of qualified personnel	10
3.3.2	Warranty and liability	10
3.3.3	Disposal	10
3.3.4	For your safety	10
<b>4</b>	<b>Function description</b>	<b>11</b>
4.1	Unit properties	11
4.2	Block diagram	11
<b>5</b>	<b>Installation</b>	<b>12</b>
5.1	General installation guidelines	12
5.2	Dimensions in mm	12
5.3	Connect the base unit and expansion modules	13
<b>6</b>	<b>Commissioning</b>	<b>14</b>
6.1	General wiring guidelines	14
6.2	Preparing for operation	14
6.3	Download modified project to the PNOZmulti system	14
6.4	Ethernet interfaces	15
6.4.1	RJ45 interfaces ("Ethernet")	15
6.4.2	Requirements of the connection cable and connector	15
6.4.3	Interface configuration	15
6.4.4	RJ45 connection cable	16
6.4.5	Process data exchange	17
<b>7</b>	<b>Operation</b>	<b>18</b>
7.1	Messages	18
7.2	Reset Ethernet connection settings	18
<b>8</b>	<b>Technical details</b>	<b>19</b>
<b>9</b>	<b>Order reference</b>	<b>21</b>
9.1	Product	21
9.2	Accessories	21

9.2.1	Plug-in connector .....	21
9.2.2	Connector plug.....	21

# 1 Introduction

## 1.1 Validity of documentation

This documentation is valid for the product PNOZ m ES ETH. It is valid until new documentation is published.

This operating manual explains the function and operation, describes the installation and provides guidelines on how to connect the product.

## 1.2 Using the documentation

This document is intended for instruction. Only install and commission the product if you have read and understood this document. The document should be retained for future reference.

## 1.3 Definition of symbols

Information that is particularly important is identified as follows:



### **DANGER!**

This warning must be heeded! It warns of a hazardous situation that poses an immediate threat of serious injury and death and indicates preventive measures that can be taken.



### **WARNING!**

This warning must be heeded! It warns of a hazardous situation that could lead to serious injury and death and indicates preventive measures that can be taken.



### **CAUTION!**

This refers to a hazard that can lead to a less serious or minor injury plus material damage, and also provides information on preventive measures that can be taken.



### **NOTICE**

This describes a situation in which the product or devices could be damaged and also provides information on preventive measures that can be taken. It also highlights areas within the text that are of particular importance.



**INFORMATION**

This gives advice on applications and provides information on special features.

## 2 Overview

### 2.1 Scope of supply

- ▶ Expansion module PNOZ m ES ETH
- ▶ Jumper

### 2.2 Unit features

Application of the product PNOZ m ES ETH:

Communication module for connection to a base unit from the configurable control system PNOZmulti 2.

The product has the following features:

- ▶ Can be configured in the PNOZmulti Configurator
- ▶ 2 Ethernet interfaces
- ▶ Status indicators for supply voltage, communication and errors
- ▶ Max. 1 communication module can be connected to the left of the base unit PNOZmulti 2
- ▶ Please refer to the document "PNOZmulti System Expansion" for the PNOZmulti base units that can be connected.

## 2.3 Front view

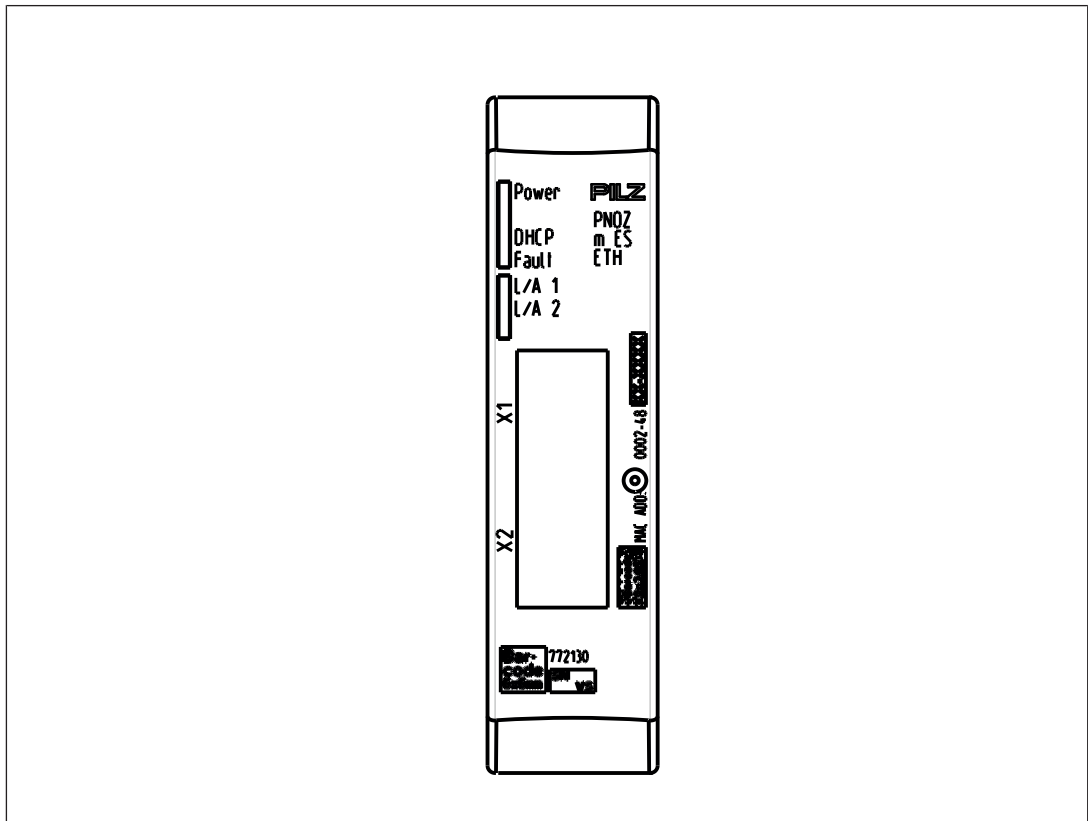

### Legend:

- ▶ X1, X2:  
Ethernet interfaces
- ▶ LEDs:
  - Power
  - DHCP
  - L/A 1 (Link/Act 1)
  - L/A 2 (Link/Act 2)



## 3 Safety

### 3.1 Intended use

The expansion module PNOZ m ES ETH is used for communication of the configurable control system PNOZmulti 2 via Ethernet.

The expansion module may only be connected to a base unit from the configurable system PNOZmulti 2 (please refer to the document "PNOZmulti System Expansion" for details of the base units that can be connected).

The configurable system PNOZmulti 2 is used for the safety-related interruption of safety circuits and is designed for use in:

- ▶ Emergency stop equipment
- ▶ Safety circuits in accordance with VDE 0113 Part 1 and EN 60204-1

The expansion module may not be used for safety-related functions.

The module PNOZ m ES ETH can be used as a non-safety-related component in accordance with the Lifts Directive 2014/33/EU.

It meets the environmental requirements for passenger and goods lifts in accordance with EN 81-1/2, EN 81-20, EN 81-22 and EN 81-50, as well as the requirements for escalators and moving walks in accordance with EN 115-1.

The safety controller should be installed in a protected environment that meets at least the requirements of pollution degree 2.

Example: Protected inside space or control cabinet with protection type IP54 and appropriate air conditioning.

#### Improper use

The following is deemed improper use in particular

- ▶ Any component, technical or electrical modification to the product,
- ▶ Use of the product outside the areas described in this operating manual,
- ▶ Use of the product outside the technical details (see [Technical details](#) [19]).



#### NOTICE

##### EMC-compliant electrical installation

The product is designed for use in an industrial environment. The product may cause interference if installed in other environments. If installed in other environments, measures should be taken to comply with the applicable standards and directives for the respective installation site with regard to interference.

### 3.2 System requirements

Please refer to the "Product Modifications PNOZmulti" document in the "Version overview" section for details of which versions of the base unit and PNOZmulti Configurator can be used for this product.

## **3.3 Safety regulations**

### **3.3.1 Use of qualified personnel**

The products may only be assembled, installed, programmed, commissioned, operated, maintained and decommissioned by competent persons.

A competent person is someone who, because of their training, experience and current professional activity, has the specialist knowledge required to test, assess and operate the work equipment, devices, systems, plant and machinery in accordance with the general standards and guidelines for safety technology.

It is the company's responsibility only to employ personnel who

- ▶ Are familiar with the basic regulations concerning health and safety / accident prevention,
- ▶ Have read and understood the information provided in this description under "Safety",
- ▶ And have a good knowledge of the generic and specialist standards applicable to the specific application.

### **3.3.2 Warranty and liability**

All claims to warranty and liability will be rendered invalid if

- ▶ The product was used contrary to the purpose for which it is intended,
- ▶ Damage can be attributed to not having followed the guidelines in the manual,
- ▶ Operating personnel are not suitably qualified,
- ▶ Any type of modification has been made (e.g. exchanging components on the PCB boards, soldering work etc.).

### **3.3.3 Disposal**

- ▶ When decommissioning, please comply with local regulations regarding the disposal of electronic devices (e.g. Electrical and Electronic Equipment Act).

### **3.3.4 For your safety**

The unit meets all the necessary conditions for safe operation. However, you should always ensure that the following safety requirements are met:

- ▶ This operating manual only describes the basic functions of the unit. The expanded functions are described in the PNOZmulti Configurator's online help. Only use these functions once you have read and understood the documentations.
- ▶ Do not open the housing or make any unauthorised modifications.
- ▶ Please make sure you shut down the supply voltage when performing maintenance work (e.g. exchanging contactors).

## 4 Function description

### 4.1 Unit properties

The product PNOZ m ES ETH has two Ethernet interfaces to

- ▶ Download the project
- ▶ Read the diagnostic data
- ▶ Set virtual inputs for standard functions
- ▶ Read virtual outputs for standard functions

via Ethernet (TCP/IP, Modbus/TCP).

Information on diagnostics via the Ethernet interfaces can be found in the document entitled "PNOZmulti 2 communication interfaces".

The connection to Ethernet is made via the two 8-pin RJ45 sockets.

The Ethernet interface is configured in the PNOZmulti Configurator and is described in the online help for the PNOZmulti Configurator.

### 4.2 Block diagram

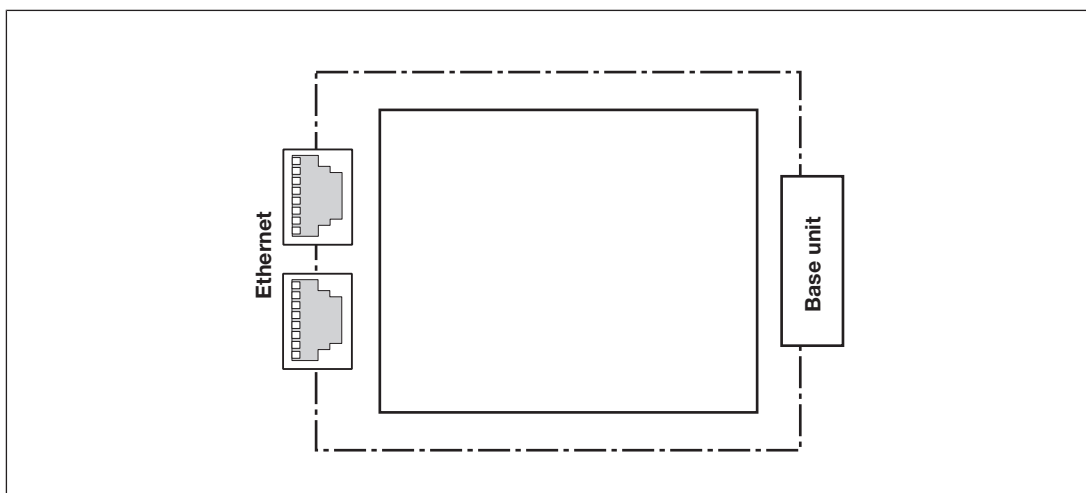

## 5 Installation

### 5.1 General installation guidelines

- ▶ The unit should be installed in a control cabinet with a protection type of at least IP54.
- ▶ Fit the safety system to a horizontal mounting rail. The venting slots must face upward and downward. Other mounting positions could damage the safety system.
- ▶ Use the locking elements on the rear of the unit to attach it to a mounting rail.
- ▶ In environments exposed to heavy vibration, the unit should be secured using a fixing element (e.g. retaining bracket or end angle).
- ▶ Open the locking slide before lifting the unit from the mounting rail.
- ▶ To comply with EMC requirements, the mounting rail must have a low impedance connection to the control cabinet housing.
- ▶ The ambient temperature of the PNOZmulti units in the control cabinet must not exceed the figure stated in the technical details. Air conditioning may otherwise be required.



#### NOTICE

Damage due to electrostatic discharge!

Electrostatic discharge can damage components. Ensure against discharge before touching the product, e.g. by touching an earthed, conductive surface or by wearing an earthed armband.

### 5.2 Dimensions in mm

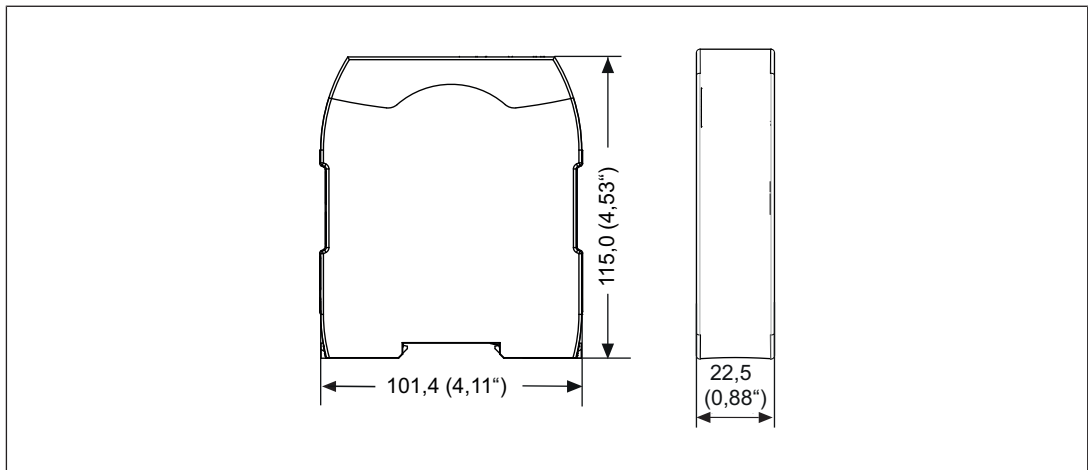

### 5.3 **Connect the base unit and expansion modules**

Connect the base unit and the expansion module as described in the operating instructions for the base units.

- ▶ Connect the black/yellow terminator to the expansion module.
- ▶ Install the expansion module in the position in which it is configured in the PNOZmulti Configurator.

The position of the expansion modules is defined in the PNOZmulti Configurator. The expansion modules are connected to the left or right of the base unit, depending on the type.

Please refer to the document "PNOZmulti System Expansion" for details of the number of modules that can be connected to the base unit and the module types.

## 6 Commissioning

### 6.1 General wiring guidelines

The wiring is defined in the circuit diagram of the PNOZmulti Configurator.

Please note:

- ▶ Information given in the [Technical details \[19\]](#) must be followed.
- ▶ The position of the expansion module is specified in the Hardware configuration of the PNOZmulti Configurator.
- ▶ Use copper wiring with a temperature stability of 75 °C.

### 6.2 Preparing for operation

Detection and activation of the Ethernet interface, depending on the USB interface on the base unit:

▶ **USB interface on the base unit not connected**

If the USB interface on the base unit is not connected, the Ethernet interface will be detected and activated by the base unit as soon as the communication module has been connected to the base unit.

▶ **USB interface on the base unit connected**

If the USB interface on the base unit is already connected, the "Ethernet" interface will first need to be selected on the base unit display to enable the Ethernet interface on the base unit to be detected and activated (see operating manual for the base unit for details of the setting).

### 6.3 Download modified project to the PNOZmulti system

As soon as an additional expansion module has been connected to the system, the project must be amended in the PNOZmulti Configurator and downloaded back into the base unit. Proceed as described in the operating manual for the base unit.



**NOTICE**

For the commissioning and after every user program change, you must check whether the safety devices are functioning correctly.

## 6.4 Ethernet interfaces

### 6.4.1 RJ45 interfaces ("Ethernet")

Two free switch ports are provided as Ethernet interfaces via an internal autosensing switch. The autosensing switch automatically detects whether data transfer is occurring at 10 Mbit/s or 100 Mbit/s.



#### INFORMATION

The connected subscribers must support the autosensing/autonegotiation function. If not, the communication partner must be set permanently to "10 Mbit/s, half duplex".

The switch's automatic crossover function means there is no need to distinguish on the connection cable between patch cable (uncrossed data line connection) and crossover cable (crossover data line connection). The switch automatically creates the correct data line connection internally. Patch cable can therefore be used as the connection cable for end devices as well as cascading.

Both Ethernet interfaces use RJ45 technology.

### 6.4.2 Requirements of the connection cable and connector

The following minimum requirements must be met:

- ▶ Ethernet standards (min. Category 5) 10BaseT or 100BaseTX
- ▶ Double-shielded twisted pair cable for industrial Ethernet use
- ▶ Shielded RJ45 connectors (industrial connectors)

### 6.4.3 Interface configuration

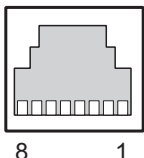
RJ45 socket 8-pin	PIN	Standard	Crossover
	1	TD+ (Transmit+)	RD+ (Receive+)
	2	TD- (Transmit-)	RD- (Receive-)
	3	RD+ (Receive+)	TD+ (Transmit+)
	4	n.c.	n.c.
	5	n.c.	n.c.
	6	RD- (Receive-)	TD- (Transmit-)
	7	n.c.	n.c.
	8	n.c.	n.c.

### 6.4.4 RJ45 connection cable

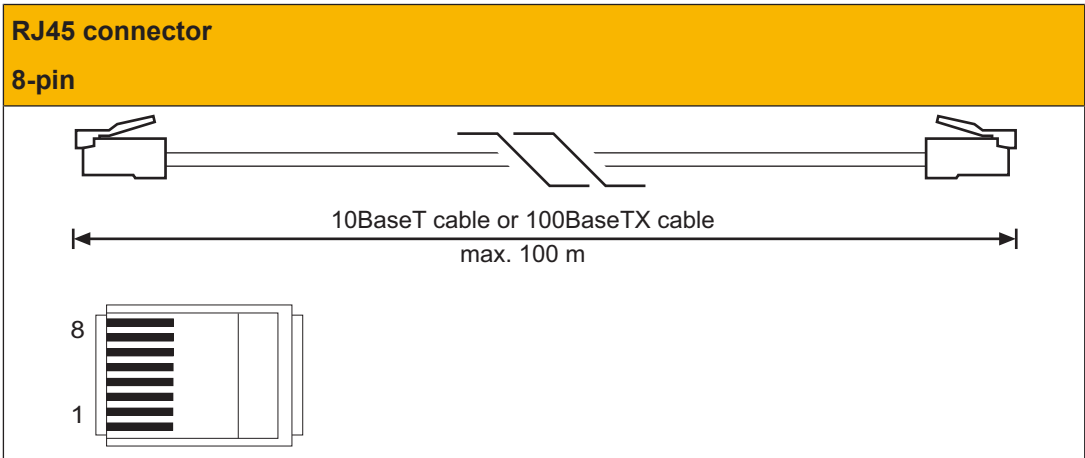

**NOTICE**

With the plug-in connection please note that the data cable and connector have a limited mechanical load capacity. Appropriate design measures should be used to ensure that the plug-in connection is insensitive to increased mechanical stress (e.g. through shock, vibration). Such measures include fixed routing with strain relief, for example.



### 6.4.5 Process data exchange

The RJ45 interfaces on the internal autosensing switch enable process data to be exchanged with other Ethernet subscribers within a network.

The product PNOZ m ES ETH can also be connected to Ethernet via a hub (hub or switch).

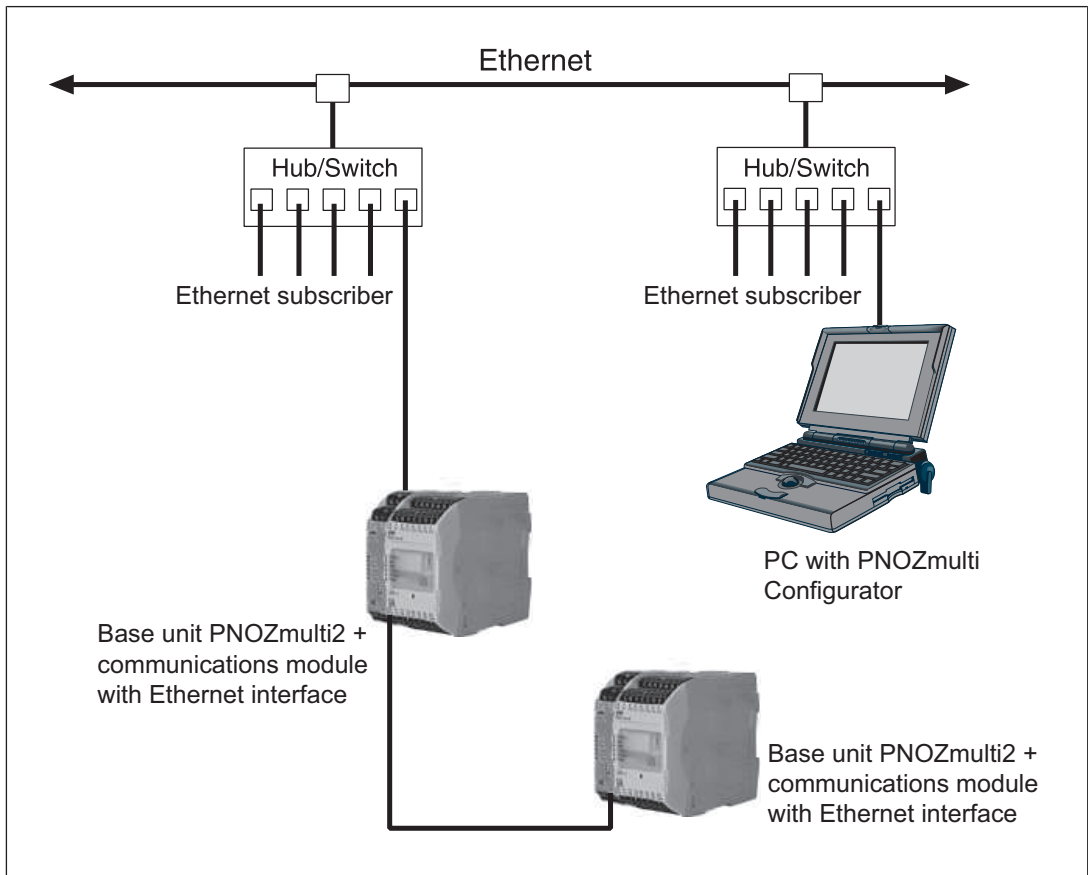



## 7 Operation











When the supply voltage is switched on, the PNOZmulti copies the configuration from the chip card.

The safety system PNOZmulti is ready for operation when the "POWER" and "RUN" LEDs on the base unit and the "POWER" LED on the PNOZ m ES ETH are lit continuously.

### 7.1 Messages

#### Legend

-  LED on
-  LED flashes
-  LED off

LED	LED status		Meaning
Power			No supply voltage
		Green	Supply voltage is present
L/A 1 ( Link / Act 1 )			No network connection at X1 / No data traffic at X1
		Green	Network connection present at X1 / Data traffic present at X1
L/A 2 ( Link / Act 2 )			No network connection at X2 / No data traffic at X2
		Green	Network connection present at X2 / Data traffic present at X2
Fault		Red	Internal fault
		Red	No connection to base unit
DHCP		Yellow	The unit could not be assigned an IP address by the DHCP Server.
		Yellow	The unit is waiting for the DHCP Server to assign an IP address

### 7.2 Reset Ethernet connection settings

The Ethernet connection settings of the base unit can be configured in the PNOZmulti Configurator.

You can reset the base unit's Ethernet connection settings to the default settings.

Proceed as follows:

- ▶ Switch off the supply voltage
- ▶ Remove the chip card
- ▶ Restart the base unit without the chip card inserted.

The Ethernet connection settings are now reset to the default settings.

## 8 Technical details

<b>General</b>	
Certifications	<b>CE, EAC, UKCA, cULus Listed</b>
Application range	<b>Standard</b>
Module's device code	<b>1202h</b>
<b>Electrical data</b>	
Supply voltage	
for	<b>Module supply</b>
internal	<b>Via base unit</b>
Voltage	<b>3,3 V</b>
Kind	<b>DC</b>
Voltage tolerance	<b>-2 %/+2 %</b>
Current consumption	<b>295 mA</b>
Power consumption	<b>1 W</b>
Status indicator	<b>LED</b>
<b>Ethernet interface</b>	
Number	<b>2</b>
IP address (automatically off)	<b>169.254.60.1</b>
Connection type	<b>RJ45</b>
Transmission rate	<b>10 MBit/s, 100 MBit/s</b>
<b>Fieldbus interface</b>	
Fieldbus interface	<b>Modbus/TCP</b>
Device type	<b>Slave</b>
Connection	<b>RJ45</b>
Galvanic isolation	<b>yes</b>
<b>Environmental data</b>	
Ambient temperature	
In accordance with the standard	<b>EN 60068-2-14</b>
Temperature range	<b>0 - 60 °C</b>
Forced convection in control cabinet off	<b>55 °C</b>
Storage temperature	
In accordance with the standard	<b>EN 60068-2-1/-2</b>
Temperature range	<b>-25 - 70 °C</b>
Climatic suitability	
In accordance with the standard	<b>EN 60068-2-30, EN 60068-2-78</b>
Condensation during operation	<b>Not permitted</b>
Max. operating height above sea level	<b>2000 m</b>
EMC	<b>EN 61131-2</b>
Vibration	
In accordance with the standard	<b>EN 60068-2-6</b>
Frequency	<b>10 - 150 Hz</b>
Acceleration	<b>1g</b>

### Environmental data

#### Shock stress

In accordance with the standard	<b>EN 60068-2-27</b>
Acceleration	<b>15g</b>
Duration	<b>11 ms</b>

#### Airgap creepage

In accordance with the standard	<b>EN 61131-2</b>
Overvoltage category	<b>II</b>
Pollution degree	<b>2</b>

#### Protection type

In accordance with the standard	<b>EN 60529</b>
Housing	<b>IP20</b>
Terminals	<b>IP20</b>
Mounting area (e.g. control cabinet)	<b>IP54</b>

### Potential isolation

Potential isolation between	<b>Fieldbus and module voltage</b>
Type of potential isolation	<b>Functional insulation</b>
Rated insulation voltage	<b>30 V</b>
Rated surge voltage	<b>500 V</b>

### Mechanical data

Mounting position	<b>horizontally on mounting rail</b>
-------------------	--------------------------------------

#### DIN rail

Top hat rail	<b>35 x 7,5 EN 50022</b>
Recess width	<b>27 mm</b>

#### Cable length

Max. cable length per input	<b>0,1 km</b>
-----------------------------	---------------

#### Material

Bottom	<b>PC</b>
Front	<b>PC</b>
Top	<b>PC</b>

#### Dimensions

Height	<b>101,4 mm</b>
Width	<b>22,5 mm</b>
Depth	<b>111 mm</b>

Weight	<b>80 g</b>
--------	-------------

Where standards are undated, the 2012-04 latest editions shall apply.

## 9 Order reference

### 9.1 Product

Product type	Features	Order no.
PNOZ m ES ETH	Configurable safe small controllers PNOZmulti 2, communication module, 2 Ethernet / Modbus TCP interfaces.	772130

### 9.2 Accessories

#### 9.2.1 Plug-in connector

Product type	Features	Order no.
RJ45 Connector	RJ45 plug-in connector, straight, IP20, 8-pin, Cat6a, IDC connection, AWG22, cable diameter: 5.5 - 8.5 mm	380401

#### 9.2.2 Connector plug

Product type	Features	Order no.
PNOZ mm0.xp connector left (10 pcs)	Connector plug to connect the modules to the left-hand side of the PNOZmulti base unit, yellow/black (10 pieces).	779260

# ► Support

Technical support is available from Pilz round the clock.

## Americas

### Brazil

+55 11 97569-2804

### Canada

+1 888 315 7459

### Mexico

+52 55 5572 1300

### USA (toll-free)

+1 877-PILZUSA (745-9872)

## Asia

### China

+86 21 60880878-216

### Japan

+81 45 471-2281

### South Korea

+82 31 778 3300

## Australia and Oceania

### Australia

+61 3 95600621

### New Zealand

+64 9 6345350

## Europe

### Austria

+43 1 7986263-0

### Belgium, Luxembourg

+32 9 3217570

### France

+33 3 88104003

### Germany

+49 711 3409-444

### Ireland

+353 21 4804983

### Italy, Malta

+39 0362 1826711

## Scandinavia

+45 74436332

## Spain

+34 938497433

## Switzerland

+41 62 88979-32

## The Netherlands

+31 347 320477

## Turkey

+90 216 5775552

## United Kingdom

+44 1536 462203

## You can reach our international hotline on:

+49 711 3409-222

support@pilz.com

Pilz develops environmentally-friendly products using ecological materials and energy-saving technologies. Offices and production facilities are ecologically designed, environmentally-aware and energy-saving. So Pilz offers sustainability, plus the security of using energy-efficient products and environmentally-friendly solutions.



We are represented internationally. Please refer to our homepage [www.pilz.com](http://www.pilz.com) for further details or contact our headquarters.

Headquarters: Pilz GmbH & Co. KG, Felix-Wankel-Straße 2, 73760 Ostfildern, Germany  
Telephone: +49 711 3409-0, Telefax: +49 711 3409-133, E-Mail: [info@pilz.com](mailto:info@pilz.com), Internet: [www.pilz.com](http://www.pilz.com)

**PILZ**  
THE SPIRIT OF SAFETY

1002700-EN-08, 2022-10 Printed in Germany  
© Pilz GmbH & Co. KG, 2019

CECE®, CHRE®, CMSE®, InduraNET p®, Leansafe®, Master of Safety®, Master of Security®, PAS4000®, PAScall®, PASconfig®, Pilz®, PTT®, PLID®, PMCPirimo®, PMCPiritego®, PMCTendo®, PMD®, PMJ®, PNOZ®, PRCM®, PRM®, PRMNET p®, PSEN®, PSENi®, PSS®, PVS®, SafetyBUS p®, SafetyEYE®, THE SPIRIT OF SAFETY® are registered and protected trademarks of Pilz GmbH & Co. KG in some countries. We would point out that product features may vary from the details stated in this document, depending on the status at the time of publication and the scope of the equipment. We accept no responsibility for the validity, accuracy and entirety of the text and graphics presented in this information. Please contact our Technical Support if you have any questions.