



PNOZ po3.1p

PILZ
THE SPIRIT OF SAFETY

- ▶ Safety relays

This document is the original document.

Where unavoidable, for reasons of readability, the masculine form has been selected when formulating this document. We do assure you that all persons are regarded without discrimination and on an equal basis.

All rights to this documentation are reserved by Pilz GmbH & Co. KG. Copies may be made for the user's internal purposes. Suggestions and comments for improving this documentation will be gratefully received.

Pilz®, PIT®, PMI®, PNOZ®, Primo®, PSEN®, PSS®, PVIS®, SafetyBUS p®, SafetyEYE®, SafetyNET p®, the spirit of safety® are registered and protected trademarks of Pilz GmbH & Co. KG in some countries.



SD means Secure Digital

Introduction	4
Validity of documentation	4
Using the documentation	4
Definition of symbols	4
Safety	5
Intended use	5
Safety regulations	5
Safety assessment	5
Use of qualified personnel	6
Warranty and liability	6
Disposal	6
For your safety	6
Unit features	7
Safety features	7
Block diagram/terminal configuration	7
Function Description	8
Installation	8
Wiring	9
Preparing for operation	10
Operation	10
Status indicators	11
Faults – Interference	11
Dimensions in mm	11
Technical details	12
Safety characteristic data	14
Supplementary data	15
Service life graph	16
Remove plug-in terminals	17
Order reference	17
EC declaration of conformity	18
UKCA-Declaration of Conformity	18

Introduction

Validity of documentation

This documentation is valid for the product PNOZ po3.1p. It is valid until new documentation is published.

This operating manual explains the function and operation, describes the installation and provides guidelines on how to connect the product.

Using the documentation

This document is intended for instruction. Only install and commission the product if you have read and understood this document. The document should be retained for future reference.

Definition of symbols

Information that is particularly important is identified as follows:



DANGER!

This warning must be heeded! It warns of a hazardous situation that poses an immediate threat of serious injury and death and indicates preventive measures that can be taken.



WARNING!

This warning must be heeded! It warns of a hazardous situation that could lead to serious injury and death and indicates preventive measures that can be taken.



CAUTION!

This refers to a hazard that can lead to a less serious or minor injury plus material damage, and also provides information on preventive measures that can be taken.



NOTICE

This describes a situation in which the product or devices could be damaged and also provides information on preventive measures that can be taken. It also highlights areas within the text that are of particular importance.



INFORMATION

This gives advice on applications and provides information on special features.

Safety

Intended use

The PNOZ po3.1p is an expansion module of the safety system PNOZpower. It may only be used with a base unit or a control module of the modular safety system PNOZpower.

The expansion module meets the requirements of EN 60947-5-1 and EN 60204-1.

The max. achievable safety level depends on the base unit. The expansion module may not exceed this. The safety-related characteristic values stated under [safety-related characteristic data](#) [ 14] can only be achieved if the base unit also exhibits these safety characteristic values.

Improper use

The following is deemed improper use in particular

- ▶ Any component, technical or electrical modification to the product,
- ▶ Use of the product outside the areas described in this operating manual,
- ▶ Use of the product outside the technical details (see [Technical details](#) [ 12]).



NOTICE

EMC-compliant electrical installation

The product is designed for use in an industrial environment. The product may cause interference if installed in other environments. If installed in other environments, measures should be taken to comply with the applicable standards and directives for the respective installation site with regard to interference.

Safety regulations

Safety assessment

Before using a device, a safety assessment in accordance with the Machinery Directive is required.

The product as an individual component fulfils the functional safety requirements in accordance with EN ISO 13849 and EN 62061. However, this does not guarantee the functional safety of the overall plant/machine. To achieve the relevant safety level of the overall plant/machine's required safety functions, each safety function needs to be considered separately.

Use of qualified personnel

The products may only be assembled, installed, programmed, commissioned, operated, maintained and decommissioned by persons who are competent to do so.

A competent person is a qualified and knowledgeable person who, because of their training, experience and current professional activity, has the specialist knowledge required. To be able to inspect, assess and operate devices, systems and machines, the person has to be informed of the state of the art and the applicable national, European and international laws, directives and standards.

It is the company's responsibility only to employ personnel who

- ▶ Are familiar with the basic regulations concerning health and safety / accident prevention,
- ▶ Have read and understood the information provided in the section entitled Safety
- ▶ Have a good knowledge of the generic and specialist standards applicable to the specific application.

Warranty and liability

All claims to warranty and liability will be rendered invalid if

- ▶ The product was used contrary to the purpose for which it is intended,
- ▶ Damage can be attributed to not having followed the guidelines in the manual,
- ▶ Operating personnel are not suitably qualified,
- ▶ Any type of modification has been made (e.g. exchanging components on the PCB boards, soldering work etc.).

Disposal

- ▶ In safety-related applications, please comply with the mission time T_M in the safety-related characteristic data.
- ▶ When decommissioning, please comply with local regulations regarding the disposal of electronic devices (e.g. Electrical and Electronic Equipment Act).

For your safety

The unit meets all the necessary conditions for safe operation. However, please note the following:

- ▶ Note for overvoltage category III: If voltages higher than low voltage (>50 VAC or >120 VDC) are present on the unit, connected control elements and sensors must have a rated insulation voltage of at least 250 V.

Unit features

- ▶ Expansion module control inputs via PNOZpower bus
- ▶ Positive-guided relay outputs:
 - 8 safety contacts (N/O)
- ▶ LED indicator for:
 - Supply voltage
 - Switch state of the safety contacts
 - Error
- ▶ Plug-in connection terminals

Safety features

In conjunction with a base unit of the safety system PNOZpower, the expansion module fulfills the following safety requirements:

- ▶ The circuit is redundant with built-in self-monitoring.
- ▶ The safety device remains effective in the case of a component failure.
- ▶ The correct opening and closing of the safety device relays is tested automatically in each on-off cycle.

Block diagram/terminal configuration

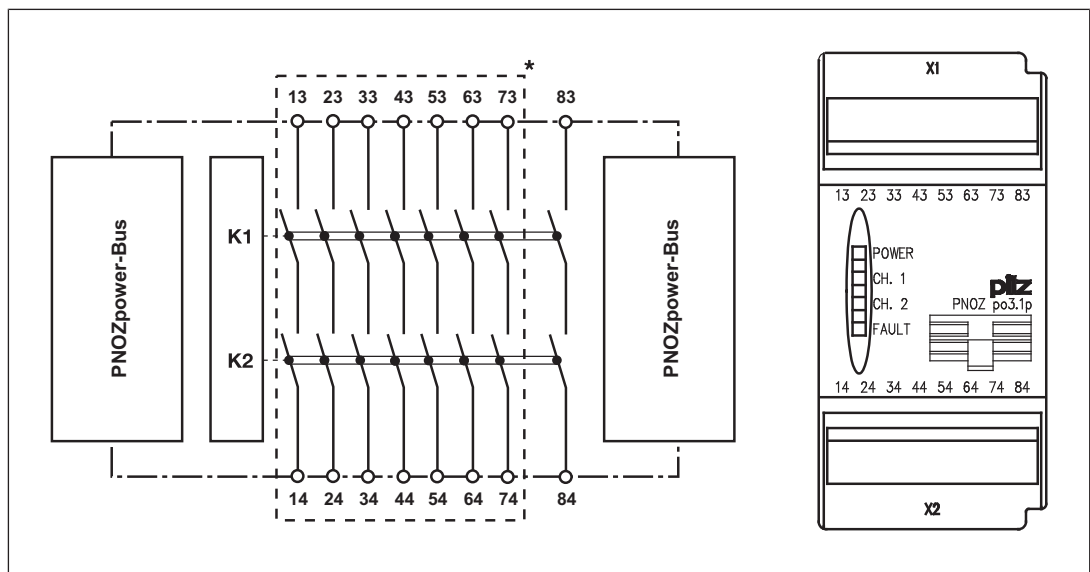

*Safe separation from non-marked area, except for safety contact 83-84, in accordance with EN 60947-1, 6 kV, basic insulation between all safety contacts.

Function Description

The safety contacts are controlled by the base unit. The base unit controls the status of the input circuits and the feedback loop. The supply voltage is fed via the PNOZpower bus. When supply voltage is applied the "POWER" LED will light. The unit is ready for operation when the feedback loop and the start circuit are closed at the base unit.

- ▶ Functional procedure after closing the input circuit of the base unit:
 - Close the safety contacts 13-14, 23-24, 33-34, 43-44, 53-54, 63-64, 73-74 and 83-84.
 - The LEDs "CH. 1" and "CH. 2" are lit.
- ▶ Functional procedure after opening the input circuit of the base unit:
 - Safety contacts 13-14, 23-24, 33-34, 43-44, 53-54, 63-64, 73-74 and 83-84 are opened redundantly.
 - The LEDs "CH. 1" and "CH. 2" go out.



NOTICE

When controlling an expansion module via the den PNOZpower bus the switch-on delay/delay-on de-energisation of the controlling device (e.g base unit, control module, ...) and the expansion module are added together.

Installation

- ▶ The unit should be installed in a control cabinet with a protection type of at least IP54.
- ▶ Use the notches on the rear of the unit to attach it to a DIN rail.
- ▶ Fit the unit to a horizontal DIN rail. If other mounting positions are used, the switching capability values stated in the technical details cannot be maintained.
- ▶ There are 2 sockets on the rear of the PNOZ po3.1p.
The base unit/control module and the expansion modules are connected using the jumpers supplied.



NOTICE

Always connect a terminator to the first and last device.

- ▶ Only use terminators, jumpers and terminals of the modular safety system PNOZpower.
- ▶ Layout:
 - The base module and the expansion modules can be installed in any position on the PNOZpower modular safety system.
- ▶ Maximum hardware:
 - 1 base unit/control module
 - 4 expansion modules
 - 1 power supply unit

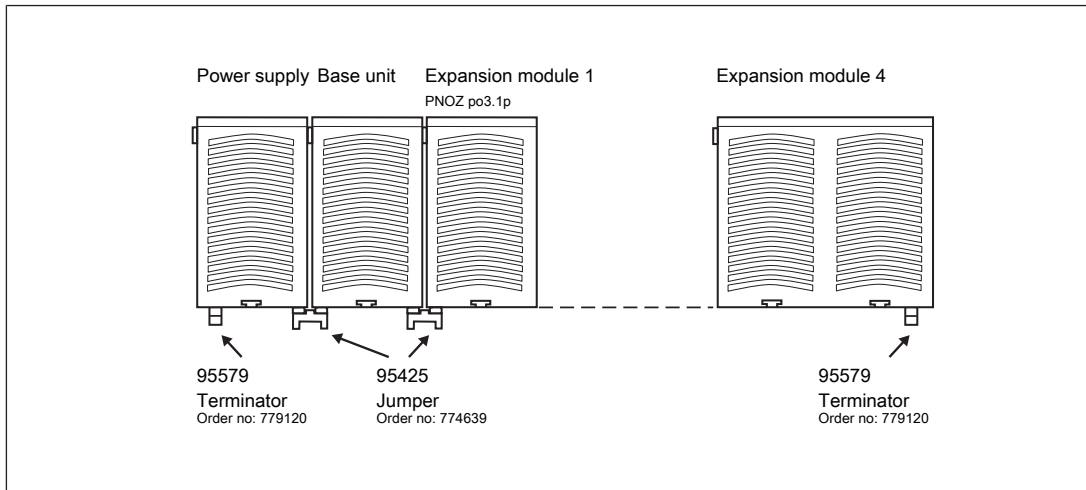
**WARNING!****Risk of electrocution!**

When voltage is applied, contact with live components could result in serious or even fatal injury from an electric shock.

The plug-in connection terminals should only be connected and disconnected when the voltage is switched off.

Wiring

Please note:

- ▶ Information given in the "[Technical details \[12\]](#)" must be followed.
- ▶ The outputs 13-14, 23-24, 33-34, 43-44, 53-54, 63-64, 73-74, 83-84 are safety contacts.
- ▶ To prevent contact welding, a fuse should be connected before the output contacts (see [Technical details \[12\]](#)).
- ▶ Use copper wiring with a temperature stability of 60/75 °C.
- ▶ To prevent EMC interferences (particularly common-mode interferences) the measures described in EN 60204-1 must be executed. This includes the separate routing of cables of the control circuits (input, start and feedback loop) from other cables for energy transmission or the shielding of cables, for example.
- ▶ Adequate protection must be provided on all output contacts with capacitive and inductive loads.
- ▶ Do not switch low currents using contacts that have been used previously with high currents.

Preparing for operation

The expansion module is ready for operation when it is connected to a base unit via the PNOZpower bus.

If the contactors are to be controlled directly, we recommend the following wiring:

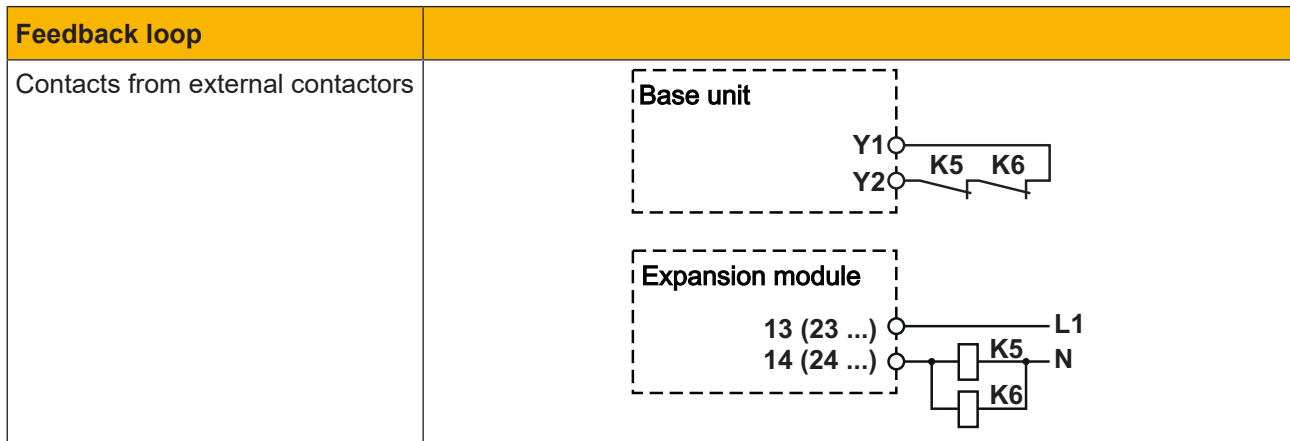

Operation

When the relay outputs are switched on, the mechanical contact on the relay cannot be tested automatically. Depending on the operational environment, measures to detect the non-opening of switching elements may be required under some circumstances.

When the product is used in accordance with the European Machinery Directive, a check must be carried out to ensure that the safety contacts on the relay outputs open correctly. Open the safety contacts (switch off output) and start the device again, so that the internal diagnostics can check that the safety contacts open correctly

- ▶ for SIL CL 3/PL e at least 1x per month
- ▶ for SIL CL 2/PL d at least 1x per year



NOTICE

The safety function should be checked after initial commissioning and each time the plant/machine is changed. The safety functions may only be checked by qualified personnel.

Status indicators

LEDs indicate the status and errors during operation:



LED on



POWER

Supply voltage is present.



CH.1

Safety contacts of channel 1 are closed.



CH.2

Safety contacts of channel 2 are closed.



FAULT

Contact malfunction

Faults – Interference

By closing or interrupting the input circuit you can check whether the unit switches on or off correctly.

For safety reasons, the expansion module cannot be started if the following faults are present:

- ▶ **Contact malfunction:** As the expansion module is connected to a base unit or a control module, reactivation will not be possible if the contacts have welded after the input circuit has opened.

Dimensions in mm

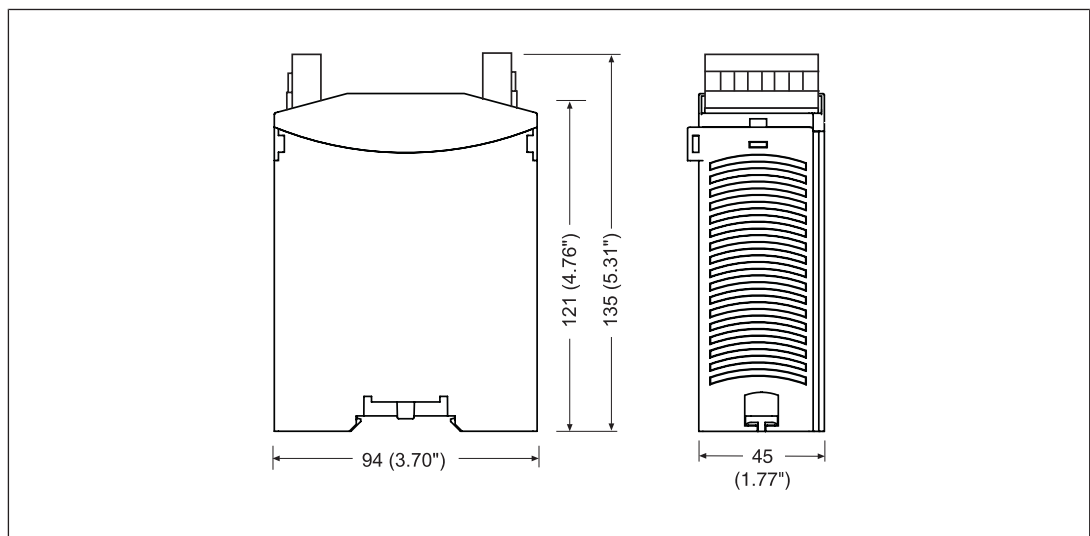

Technical details

General

Certifications **CCC, CE, EAC, TÜV, UKCA, cULus Listed**

Electrical data

Supply voltage

Voltage **24 V**
 Kind **DC**
 Power consumption **4 W**

Duty cycle **100 %**

Relay outputs

Number of output contacts

Safety contacts (N/O), instantaneous **8**

Max. short circuit current I_K **1 kA**

Utilisation category

In accordance with the standard **EN 60947-4-1**

Utilisation category of safety contacts

AC1 at **240 V**
 Min. current **0,01 A**
 Max. current **8 A**
 Max. power **2000 VA**
 DC1 at **24 V**
 Min. current **0,01 A**
 Max. current **8 A**
 Max. power **200 W**

Utilisation category

In accordance with the standard **EN 60947-5-1**

Utilisation category of safety contacts

AC15 at **230 V**
 Max. current **5 A**
 DC13 (6 cycles/min) at **24 V**
 Max. current **5 A**

Utilisation category in accordance with UL

Voltage **240 V AC G. P.**
 With current **8 A**
 Voltage **24 V DC Resistive**
 With current **5 A**
 Pilot Duty **C300, R300**

External contact fuse protection, safety contacts

In accordance with the standard **EN 60947-5-1**
 Max. melting integral **240 A²s**
 Blow-out fuse, quick **10 A**
 Blow-out fuse, slow **6 A**
 Blow-out fuse, gG **10 A**
 Circuit breaker 24V AC/DC, characteristic B/C **6 A**

Relay outputs

Contact material	AgSnO₂ + 0,2 µm Au
------------------	--------------------------------------

Conventional thermal current while loading several contacts

lth per contact at UB DC; AC1: 240 V, DC1: 24 V

Conv. therm. current with 1 contact	8 A
Conv. therm. current with 2 contacts	8 A
Conv. therm. current with 3 contacts	8 A
Conv. therm. current with 4 contacts	7,1 A
Conv. therm. current with 5 contacts	6,4 A
Conv. therm. current with 6 contacts	5,8 A
Conv. therm. current with 7 contacts	5,4 A
Conv. therm. current with 8 contacts	5 A

Times

Switch-on delay

With automatic start typ.	30 ms
With automatic start max.	50 ms

Delay-on de-energisation

With E-STOP typ.	20 ms
With E-STOP max.	30 ms

Environmental data

Climatic suitability	EN 60068-2-78
----------------------	----------------------

Ambient temperature

Temperature range	-10 - 55 °C
-------------------	--------------------

Storage temperature

Temperature range	-40 - 85 °C
-------------------	--------------------

Climatic suitability

Humidity	93 % r. h. at 40 °C
----------	----------------------------

Condensation during operation

Not permitted

EMC

EN 60947-5-1, EN 61000-6-2, EN 61326-3-1

Vibration

In accordance with the standard	EN 60068-2-6
Frequency	10 - 55 Hz
Amplitude	0,35 mm

Airgap creepage

In accordance with the standard	EN 60947-1
Overvoltage category	III
Pollution degree	2

Rated insulation voltage

250 V

Rated impulse withstand voltage

6 kV

Protection type

Housing	IP30
Terminals	IP20
Mounting area (e.g. control cabinet)	IP54

Mechanical data	
Mounting position	horizontally on mounting rail
Mechanical life	10,000,000 cycles
Material	
Bottom	PPO UL 94 V1
Top	ABS UL 94 V0
Connection type	Screw terminal
Mounting type	plug-in
Conductor cross section with screw terminals	
1 core flexible	0,2 - 2,5 mm², 24 - 12 AWG
2 core with the same cross section, flexible with crimp connectors, no plastic sleeve	0,25 - 2,5 mm², 24 - 14 AWG
2 core with the same cross section, flexible without crimp connectors or with TWIN crimp connectors	0,5 - 1,5 mm², 24 - 14 AWG
Torque setting with screw terminals	0,5 Nm
Stripping length with screw terminals	8 mm
Dimensions	
Height	94 mm
Width	45 mm
Depth	121 mm
Weight	355 g

Where standards are undated, the 2020-07 latest editions shall apply.

Safety characteristic data



NOTICE
 You must comply with the safety characteristic data in order to achieve the required safety level for your plant/machine.

Operating mode	EN ISO 13849-1: 2015	EN ISO 13849-1: 2015	EN 62061 SIL CL	EN 62061 PFH _D [1/h]	IEC 61511 SIL	IEC 61511 PFD	EN ISO 13849-1: 2015 T _M [year]
–	PL e	Cat. 4	SIL CL 3	2,31E-09	SIL 3	2,03E-06	20

Explanatory notes for the safety-related characteristic data:

- ▶ The SIL CL value in accordance with EN 62061 corresponds to the SIL value in accordance with EN 61508.
- ▶ T_M is the maximum mission time in accordance with EN ISO 13849-1. The value also applies as the retest interval in accordance with EN 61508-6 and IEC 61511 and as the proof test interval and mission time in accordance with EN 62061.

All the units used within a safety function must be considered when calculating the safety characteristic data.

**INFORMATION**

A safety function's SIL/PL values are **not** identical to the SIL/PL values of the units that are used and may be different. We recommend that you use the PAScal software tool to calculate the safety function's SIL/PL values.

Supplementary data**CAUTION!**

It is essential to consider the relay's service life graphs. The relay outputs' safety-related characteristic data is only valid if the values in the service life graphs are met.

The PFH value depends on the switch frequency and the load of the relay output. If the service life graphs are not accessible, the stated PFH value can be used irrespective of the switch frequency and the load, as the PFH value already considers the relay's B10d value as well as the failure rates of the other components.

Service life graph

The service life graphs indicate the number of cycles from which failures due to wear must be expected. The wear is mainly caused by the electrical load; the mechanical load is negligible.

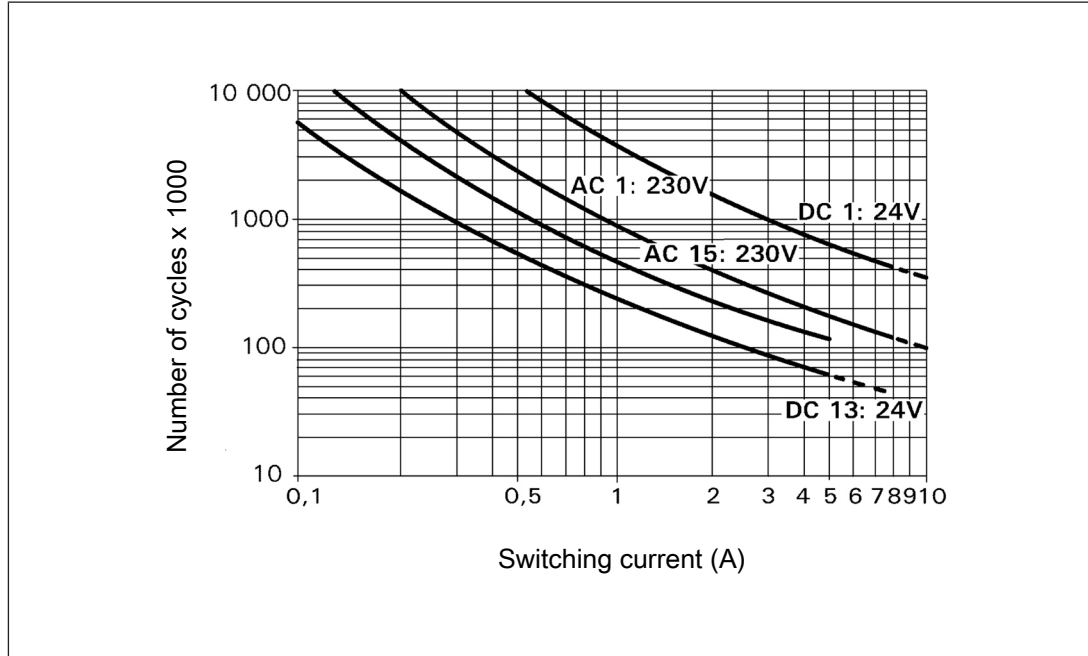

Example

- ▶ Inductive load: 0.2 A
- ▶ Utilisation category: AC15
- ▶ Contact service life: 4 000 000 cycles

Provided the application to be implemented requires fewer than 4 000 000 cycles, the PFH value (see Technical details) can be used in the calculation.

To increase the service life, sufficient spark suppression must be provided on all output contacts. With capacitive loads, any power surges that occur must be noted. With DC contacts, use flywheel diodes for spark suppression.

Remove plug-in terminals

Procedure

► Insert a suitable screwdriver into the housing recess behind the terminal.

Do **not** remove the terminals by pulling the cables!

► Lever the terminal out.

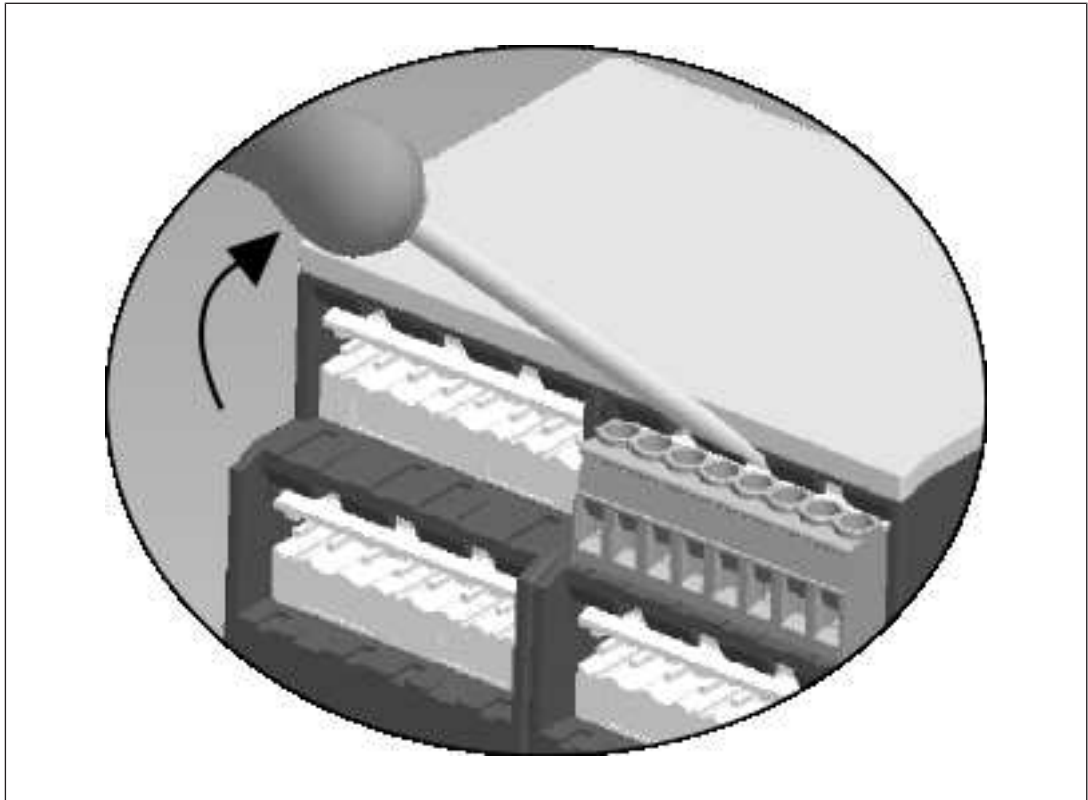

WARNING!

Risk of electrocution!

When voltage is applied, contact with live components could result in serious or even fatal injury from an electric shock.

The plug-in connection terminals should only be connected and disconnected when the voltage is switched off.

Order reference

Product type	Connection type	Order no.
PNOZ po3.1p	Screw terminals	773630

EC declaration of conformity

This product/these products meet the requirements of the directive 2006/42/EC for machinery of the European Parliament and of the Council. The complete EC Declaration of Conformity is available on the Internet at www.pilz.com/support/downloads.

Representative: Norbert Fröhlich, Pilz GmbH & Co. KG, Felix-Wankel-Str. 2, 73760 Ostfildern, Germany

UKCA-Declaration of Conformity

This product(s) complies with following UK legislation: Supply of Machinery (Safety) Regulation 2008.

The complete UKCA Declaration of Conformity is available on the Internet at www.pilz.com/support/downloads.

Representative: Pilz Automation Technology, Pilz House, Little Colliers Field, Corby, Northamptonshire, NN18 8TJ United Kingdom, eMail: mail@pilz.co.uk

► Support

Technical support is available from Pilz round the clock.

Americas

Brazil

+55 11 97569-2804

Canada

+1 888 315 7459

Mexico

+52 55 5572 1300

USA (toll-free)

+1 877-PILZUSA (745-9872)

Asia

China

+86 21 60880878-216

Japan

+81 45 471-2281

South Korea

+82 31 778 3300

Australia and Oceania

Australia

+61 3 95600621

New Zealand

+64 9 6345350

Europe

Austria

+43 1 7986263-0

Belgium, Luxembourg

+32 9 3217570

France

+33 3 88104003

Germany

+49 711 3409-444

Ireland

+353 21 4804983

Italy, Malta

+39 0362 1826711

Scandinavia

+45 74436332

Spain

+34 938497433

Switzerland

+41 62 88979-32

The Netherlands

+31 347 320477

Turkey

+90 216 5775552

United Kingdom

+44 1536 462203

You can reach our international hotline on:

+49 711 3409-222

support@pilz.com

Pilz develops environmentally-friendly products using ecological materials and energy-saving technologies. Offices and production facilities are ecologically designed, environmentally-aware and energy-saving. So Pilz offers sustainability, plus the security of using energy-efficient products and environmentally-friendly solutions.



We are represented internationally. Please refer to our homepage www.pilz.com for further details or contact our headquarters.

Headquarters: Pilz GmbH & Co. KG, Felix-Wankel-Straße 2, 73760 Ostfildern, Germany
Telephone: +49 711 3409-0, Telefax: +49 711 3409-133, E-Mail: info@pilz.com, Internet: www.pilz.com

PILZ
THE SPIRIT OF SAFETY

20676-EN-09, 2022-06 Printed in Germany
© Pilz GmbH & Co. KG, 2019

CECE®, CHRE®, CMSE®, InduraNET p®, Leansafe®, Master of Safety®, Master of Security®, PAS4000®, PAScall®, PASconfig®, Pilz®, PTT®, PLID®, PMCPirimo®, PMCPiritego®, PMCTendo®, PMD®, PMJ®, PNOZ®, PRBM®, PRCM®, PRM®, PRMNET p®, PSEN®, PSENi®, PSS®, PVS®, SafetyBUS p®, SafetyEYE®, SafetyNET p®, THE SPIRIT OF SAFETY® are registered and protected trademarks of Pilz GmbH & Co. KG in some countries. We would point out that product features may vary from the details stated in this document, depending on the status at the time of publication and the scope of the equipment. We accept no responsibility for the validity, accuracy and entirety of the text and graphics presented in this information. Please contact our Technical Support if you have any questions.