



PNOZ s60

PILZ
THE SPIRIT OF SAFETY

► Safety relays

This document is the original document.

Where unavoidable, for reasons of readability, the masculine form has been selected when formulating this document. We do assure you that all persons are regarded without discrimination and on an equal basis.

All rights to this documentation are reserved by Pilz GmbH & Co. KG. Copies may be made for the user's internal purposes. Suggestions and comments for improving this documentation will be gratefully received.

Pilz®, PIT®, PMI®, PNOZ®, Primo®, PSEN®, PSS®, PVIS®, SafetyBUS p®, SafetyEYE®, SafetyNET p®, the spirit of safety® are registered and protected trademarks of Pilz GmbH & Co. KG in some countries.



SD means Secure Digital

Introduction	5
Validity of documentation	5
Using the documentation	5
Definition of symbols	5
Safety	6
Intended use	6
Safety regulations	6
Safety assessment	6
Use of qualified personnel	7
Warranty and liability	7
Disposal	7
For your safety	7
Unit features	8
Safety features	8
Block diagram/terminal configuration	9
Function description	9
Installation	11
Wiring	12
Preparing for operation	14
Application example	16
Operation	20
Status indicators	20
Faults - malfunctions	21
Dimensions	22
Technical details	23
Safety characteristic data	31
Supplementary data	32
Service life graph	32
Permitted operating height	33
Order reference	34
Product	34
Accessories	34

EC declaration of conformity	34
UKCA-Declaration of Conformity	34

Introduction

Validity of documentation

This documentation is valid for the product PNOZ s60. It is valid until new documentation is published.

This operating manual explains the function and operation, describes the installation and provides guidelines on how to connect the product.

Using the documentation

This document is intended for instruction. Only install and commission the product if you have read and understood this document. The document should be retained for future reference.

Definition of symbols

Information that is particularly important is identified as follows:



DANGER!

This warning must be heeded! It warns of a hazardous situation that poses an immediate threat of serious injury and death and indicates preventive measures that can be taken.



WARNING!

This warning must be heeded! It warns of a hazardous situation that could lead to serious injury and death and indicates preventive measures that can be taken.



CAUTION!

This refers to a hazard that can lead to a less serious or minor injury plus material damage, and also provides information on preventive measures that can be taken.



NOTICE

This describes a situation in which the product or devices could be damaged and also provides information on preventive measures that can be taken. It also highlights areas within the text that are of particular importance.



INFORMATION

This gives advice on applications and provides information on special features.

Safety

Intended use

The voltage monitoring relay operates as a device for the safe monitoring of DC supplies and 1-phase or 3-phase supplies with no voltage applied with neutral conductor. The monitored three-phase network must be earthed at the star point. The voltage monitoring device may be used in

- ▶ Safety circuits in accordance with EN 60204-1
- ▶ Standard for Safety – UL 6420 Chapter 5.4

The voltage monitoring relay prevents the safety contacts from closing until it is guaranteed that the plant has no voltage applied. As soon as a hazardous voltage is detected, the safety contacts are opened.

Improper use

The following is deemed improper use in particular

- ▶ Any component, technical or electrical modification to the product,
- ▶ Use of the product outside the areas described in this operating manual,
- ▶ Use of the product outside the technical details (see [Technical details](#)  23]).



NOTICE

EMC-compliant electrical installation

The product is designed for use in an industrial environment. The product may cause interference if installed in other environments. If installed in other environments, measures should be taken to comply with the applicable standards and directives for the respective installation site with regard to interference.

Safety regulations

Safety assessment

Before using a device, a safety assessment in accordance with the Machinery Directive is required.

The product as an individual component fulfils the functional safety requirements in accordance with EN ISO 13849 and EN 62061. However, this does not guarantee the functional safety of the overall plant/machine. To achieve the relevant safety level of the overall plant/machine's required safety functions, each safety function needs to be considered separately.

Use of qualified personnel

The products may only be assembled, installed, programmed, commissioned, operated, maintained and decommissioned by persons who are competent to do so.

A competent person is a qualified and knowledgeable person who, because of their training, experience and current professional activity, has the specialist knowledge required. To be able to inspect, assess and operate devices, systems and machines, the person has to be informed of the state of the art and the applicable national, European and international laws, directives and standards.

It is the company's responsibility only to employ personnel who

- ▶ Are familiar with the basic regulations concerning health and safety / accident prevention,
- ▶ Have read and understood the information provided in the section entitled Safety
- ▶ Have a good knowledge of the generic and specialist standards applicable to the specific application.

Warranty and liability

All claims to warranty and liability will be rendered invalid if

- ▶ The product was used contrary to the purpose for which it is intended,
- ▶ Damage can be attributed to not having followed the guidelines in the manual,
- ▶ Operating personnel are not suitably qualified,
- ▶ Any type of modification has been made (e.g. exchanging components on the PCB boards, soldering work etc.).

Disposal

- ▶ In safety-related applications, please comply with the mission time T_M in the safety-related characteristic data.
- ▶ When decommissioning, please comply with local regulations regarding the disposal of electronic devices (e.g. Electrical and Electronic Equipment Act).

For your safety

The unit meets all the necessary conditions for safe operation. However, please note the following:

- ▶ Note for overvoltage category III: If on the device there are voltages higher than 300 V measured to the earth potential, connected control elements and sensors must have a rated insulation voltage of at least 600 V.

Unit features

- ▶ Redundant measuring inputs for DC circuits and 3-phase AC circuits
- ▶ Positive-guided relay outputs:
 - 3 safety contacts (N/O), instantaneous
 - 1 auxiliary contact (N/C), instantaneous
- ▶ 7 semiconductor outputs
- ▶ LED display for:
 - Supply voltage
 - Switch state of the safety contacts
 - Diagnostics
 - State of measuring circuit
- ▶ Semiconductor outputs signal:
 - Status of measuring circuit
 - Error
- ▶ Input circuit (Y4-Y5) and feedback loop (Y1-Y2) to monitor external contactors or switch disconnectors
- ▶ Protective separation between the external voltage supply and the hazardous voltage circuits
- ▶ Plug-in connection terminals (either spring-loaded terminal or screw terminal)
- ▶ A connector can be used to connect contact expansion module PNOZsigma:
 - PNOZ s7
 - PNOZ s7.1
 - PNOZ s7.2
 - PNOZ s8
 - PNOZ s9
 - PNOZ s10
 - PNOZ s11

Safety features

The safety relay meets the following safety requirements:

- ▶ The circuit is redundant with built-in self-monitoring.
- ▶ The safety function remains effective in the case of a component failure.
- ▶ The correct opening and closing of the safety function relays is tested automatically in each on-off cycle.

Block diagram/terminal configuration

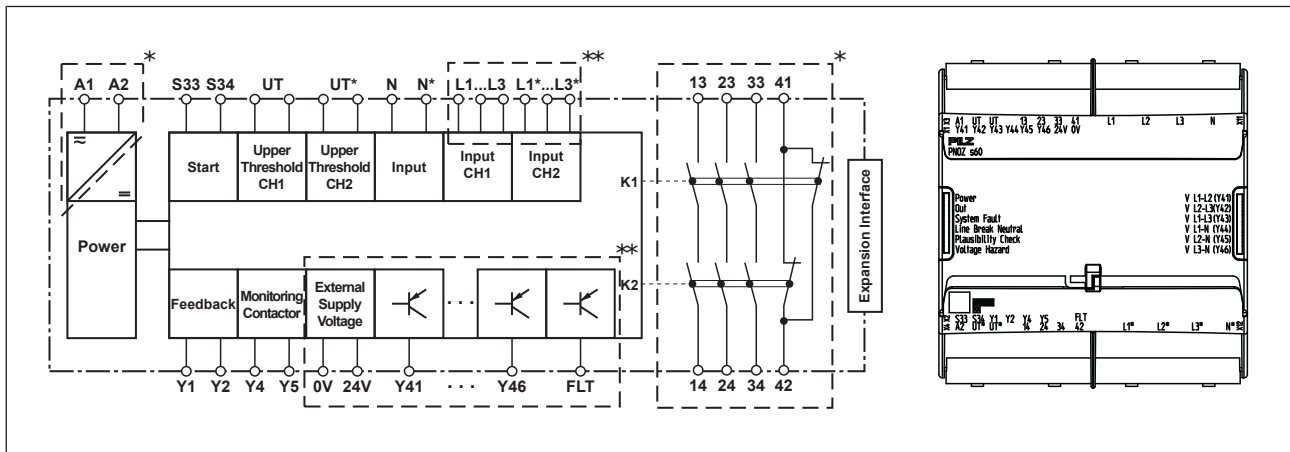

- *Insulation against the non-marked area and between the relay contacts: Basic insulation (overvoltage category III) at 300 V, 4 kV. Insulation against the other areas marked with **: Protective separation (overvoltage category III) at 300 V, 6 kV.
- **Insulation against all other areas and between the measuring connections L1^(*), L2^(*), L3^(*): protective separation (overvoltage category III) at 600 V, 8 kV

Function description



The voltage monitoring relay PNOZ s60 operates as a threshold switch. It measures the DC voltage (L+) connected to the measuring circuit, as well as single-phase (L1) or three-phase (L1, L2, L3) phase voltages. The switching threshold is selectable, 6 V or 12 V. The N/C contact of the monitored contactor or switch disconnecter must be connected to input circuit Y4-Y5 and the measuring voltages must be connected to the measuring circuit (L1^(*), L2^(*), L3^(*)). When the supply voltage is applied, the "POWER" LED will light.

- ▶ Input circuit Y4-Y5 is open (contactor active or switch disconnecter switched on) or one of the measuring voltages is greater than the switching threshold
 - The safety contacts 13-14, 23-24 and 33-34 are open.
 - Auxiliary contact 41-42 is closed.
- ▶ Input circuit Y4-Y5 is closed (contactor inactive or switch disconnecter switched off), feedback loop Y1-Y2 is closed (expansion contactor de-energised), start circuit S33-S34 is closed and all measuring voltages are lower than the switching threshold
 - The safety contacts 13-14, 23-24 and 33-34 are closed.
 - Auxiliary contact 41-42 is open.
- ▶ Self test: An internal self test is carried out during initial commissioning and each time the supply voltage is switched off and on. The process simulates switching all measuring voltages on and then off again. The unit is ready for operation once the self test has been completed successfully.
- ▶ Increase in the number of available instantaneous safety contacts by connecting contact expansion modules or expansion contactors; Connectors can be used to connect contact expansion modules PNOZsigma.

The state of the measuring circuits is displayed via the auxiliary outputs Y41 ... Y46 and the relevant LEDs:

Measuring voltage	Semiconductor	LED	Description
L1 - L2	Y41	VL1-L2 (Y41)	LED lights when the measuring voltage > 110 V
L2 - L3	Y42	VL2-L3 (Y42)	LED lights when the measuring voltage > 110 V
L1 - L3	Y43	VL1-L3 (Y43)	LED lights when the measuring voltage > 110 V
L1 – N	Y44	VL1-N (Y44)	LED lights when the measuring voltage > 64 V
L2 – N	Y45	VL2-N (Y45)	LED lights when the measuring voltage > 64 V
L3 – N	Y46	VL3-N (Y46)	LED lights when the measuring voltage > 64 V

Table of functions

- ▶ Automatic start, start circuit S33-34 is closed
- ▶ The supply voltage is connected
- ▶ Base unit only, excluding expansion modules
- ▶ If the N/O contact of the safety contacts (13-14, 23-24 and 33-34) are closed, then the N/ C contact (41-42) is open
- ▶ U_{feff} = Lower switching threshold (see [Technical details](#)  23]
- ▶ U_{reff} = Upper switching threshold (see [Technical details](#)  23]

Inputs					Assign						
Measuring channel (L1-L3 and L1*-L3*)	Unit temperature	Open circuit	Input circuit (Y4-Y5)	Feedback loop (Y1-Y2)	Safety contacts (13-14, 23-24, 33-34)	LEDs					Fault output (FLT)
						Out	System Fault	Line Break Neutral	Plausibility Check	Voltage Hazard	
$< U_{\text{feff}}$	$< 75\text{ °C}$	No	Open	Open	Open	●	●	●	●	●	L
$< U_{\text{feff}}$	$< 75\text{ °C}$	No	Open	Closed	Open	●	●	●	☀	●	L
$< U_{\text{feff}}$	$< 75\text{ °C}$	No	Closed	Open	Open	●	☀	●	●	●	H
$< U_{\text{feff}}$	$< 75\text{ °C}$	No	Closed	Closed	Closed	☀	●	●	●	●	L
$< U_{\text{feff}}$	$< 75\text{ °C}$	Yes	Open	●	☀	☀	...	●	H

Inputs					Assign						
Measuring channel (L1-L3 and L1*-L3*)	Unit temperature	Open circuit	Input circuit (Y4-Y5)	Feedback loop (Y1-Y2)	Safety contacts (13-14, 23-24, 33-34)	LEDs					Fault output (FLT)
						Out	System Fault	Line Break Neutral	Plausibility Check	Voltage Hazard	
$< U_{\text{reff}}$	75 - 85 °C	No	Closed	Closed	Closed			●	●	●	L
$< U_{\text{reff}}$	> 85 °C	No	Closed	Closed	Closed			●	●	●	H
$> U_{\text{reff}}$	< 75 °C	No	Open	Closed	Open	●	●	●	●	●	L
$> U_{\text{reff}}$	< 75 °C	No	Closed	Closed	Open	●	●	●	●		H
$> U_{\text{reff}}$	< 75 °C	Yes	Open	●			H
$> U_{\text{reff}}$	75 - 85 °C	No	Closed	Closed	Open	●		●	●		H
$> U_{\text{reff}}$	> 85 °C	No	Open	Closed	Open	●		●	●	●	L

Legend

- LED on
- LED flashes
- LED off
- ... State irrelevant
- H High
- L Low

Installation

Install base unit without contact expansion module:

- ▶ Ensure that the plug terminator is inserted at the side of the unit.

Connect base unit and PNOZsigma contact expansion module:

- ▶ Remove the plug terminator at the side of the base unit and at the contact expansion module.
- ▶ Connect the base unit and the contact expansion module to the supplied connector before mounting the units on the DIN rail.

Control cabinet installation

- ▶ The safety relay should be installed in a control cabinet with a protection type of at least IP54.
- ▶ When installing, a distance must be maintained above and below the relay and to other heat-generating devices. We recommend the following distances:
 - Above and below: 30 mm
 - To other heat-generating devices: 20 mm
- ▶ The ambient temperature of the product in the control cabinet must not exceed the figure stated in the technical details, otherwise air conditioning may be required.
- ▶ Use the notch on the rear of the unit to attach it to a DIN rail (35 mm).
- ▶ When installed vertically: Secure the unit by using a fixing element (e.g. retaining bracket or end angle).
- ▶ Push the device upwards or downwards before lifting it from the DIN rail.

Wiring



NOTICE

Connect the measuring voltages L1 and L1*, L2 and L2*, L3 and L3*, and N and N* each to separate terminals on the plant, so that at least one measuring voltage will be present if a terminal screw should come away unintentionally (single fault tolerance).



NOTICE

To meet the requirements of the safety circuits, separate wires in separate multicore cables must be used for the measuring voltages L1, L2, L3, N and the measuring voltages L1*, L2*, L3*, N*.



NOTICE

Ensure that there is sufficient fuse protection for the connection cables at terminals L1, L2, L3, L1*, L2*, L3*!



NOTICE

To prevent contact welding, a fuse should be connected before the output contacts (see [Technical details \[23\]](#)).

Please note:

- ▶ Information given in the "[Technical details \[23\]](#)" must be followed.
- ▶ Outputs 13-14, 23-24, 33-34 are safety contacts; output 41-42 is an auxiliary contact (e.g. for display).

- ▶ Auxiliary contact 41-42 should **not** be used for safety circuits!
- ▶ Outputs Y41-46 and FLT are auxiliary outputs, e.g. for communication with a PLC or display. Do not use auxiliary outputs Y41-Y46 and FLT for safety circuits!
- ▶ Semiconductor outputs should **not** be used for safety circuits!
- ▶ There is no bridging of the semiconductor supply in the event of supply interruptions! Ensure that there is sufficient voltage bridging on the semiconductor supply voltage.
- ▶ Do not connect undesignated terminals.
- ▶ Connect the neutral conductors N and N* to the earth connection or the neutral conductor of the three phase supply.
- ▶ Calculation of the max. cable length l_{\max} for the N-cable:

$$l = \frac{R \cdot A}{\rho_{\text{Cu}}}$$

R_{\max} = max. overall cable resistance (see [Technical details](#) [ 23])

A = Cross-sectional area of a round conductor

ρ_{Cu} = Specific resistance:

$$\rho_{\text{Cu}} = 1,7 \cdot 10^{-2} \frac{\Omega \text{mm}^2}{\text{m}}$$

- ▶ Use copper wiring with a temperature stability of 75 °C.
- ▶ To prevent EMC interferences (particularly common-mode interferences) the measures described in EN 60204-1 must be executed. This includes the separate routing of cables of the control circuits (input, start and feedback loop) from other cables for energy transmission or the shielding of cables, for example.
- ▶ Cables that have to be laid outside the control cabinet must be protected from mechanical damage, e.g. by installing them in a conduit.
- ▶ A SELV/PELV voltage source can be connected to 24 VDC (external supply voltage). Ensure that there is sufficient fuse protection for the SELV-PELV voltage sources.
- ▶ Ensure that there is adequate protection on all output contacts with capacitive and inductive loads (see [Technical details](#) [ 23]).
- ▶ Do not switch low currents using contacts that have been used previously with high currents.
- ▶ The three-phase network must be earthed in the star point.

Preparing for operation

Supply voltage	AC	DC

Input circuit	
Contactor to be monitored	

Measuring circuit, three-phase measurement	
Measuring voltage L1	
Measuring voltage L2	
Measuring voltage L3	
Measuring voltage N	

Measuring circuit, single-phase measurement	
Measuring voltage L1	

Measuring circuit, DC voltage		
Measuring voltage L+		

Start circuit	Automatic start	Manual start

Feedback loop	With feedback loop monitoring	Without feedback loop monitoring
Contacts from external contactors or bridge		

Semiconductor output	
The semiconductor outputs require an external 24 VDC supply.	

Switchable switching threshold	Switching threshold 6 V (no bridge)	Switching threshold 12 V
Upper threshold CH1		
Upper threshold CH2		



NOTICE

If UT or UT* is not bridged, the 6 V switching threshold will apply automatically.



NOTICE

No switch contacts may be connected to UT or UT*.

<p>Connection to PNOZsigma contact expansion modules PNOZ s7, PNOZ s7.1, PNOZ s7.2, PNOZ s8, PNOZ s10, PNOZ s11</p>	
<p>The input circuit is connected and evaluated via the connector</p>	<p>The diagram shows a dashed box containing 'PNOZ s60' on the left and 'PNOZsigma expansion module' on the right. A vertical line labeled 'Interface PNOZsigma' connects the two components.</p>

The wiring will differ if you are using the contact expansion module PNOZ s9. Please note the following:

<p>2-channel input circuit</p>	
<p>The input circuit is connected and evaluated via the connector</p>	<p>The diagram shows a dashed box containing 'PNOZ s60' on the left and 'PNOZ s9' on the right. A vertical line labeled 'Interface PNOZsigma' connects them. Above the interface is a switch symbol consisting of two circles connected by a horizontal line, with 'Y4' above the left circle and 'S34' above the right circle.</p>



INFORMATION

If a base unit and a contact expansion module are linked via the connector, no additional wiring is necessary.
Do not connect A1/A2 to the contact expansion module!

Application example

Voltage monitoring on the machine drive M1:

When the voltage in the measuring circuit drops below the threshold voltage, the safety contacts on the PNOZ s60 close. No voltage is applied to the machine drive. Guard locking on the safety gate system PSEN ml b can be activated or deactivated.

If the safety gate is opened or guard locking is deactivated, the safety contacts on the PNOZ s3 (A1) open. Voltage supply via the motor contactors KM1 and KM2 is interrupted.

If the safety gate is closed again and guard locking is activated, the safety contacts on the PNOZ s3 close. Motor contactors KM1 and KM2 are closed again and the machine can be started.



When the voltage in the measuring circuit again exceeds the threshold voltage, the safety contacts on the PNOZ s60 open. This prevents the guard locking being deactivated during operation.



NOTICE

Additional safety measures may be necessary. Carry out a risk analysis to identify potential hazards.

The following applications illustrate an

- ▶ [Example for AC measuring circuit](#)  18]
- ▶ [Example for DC measuring circuit](#)  19]

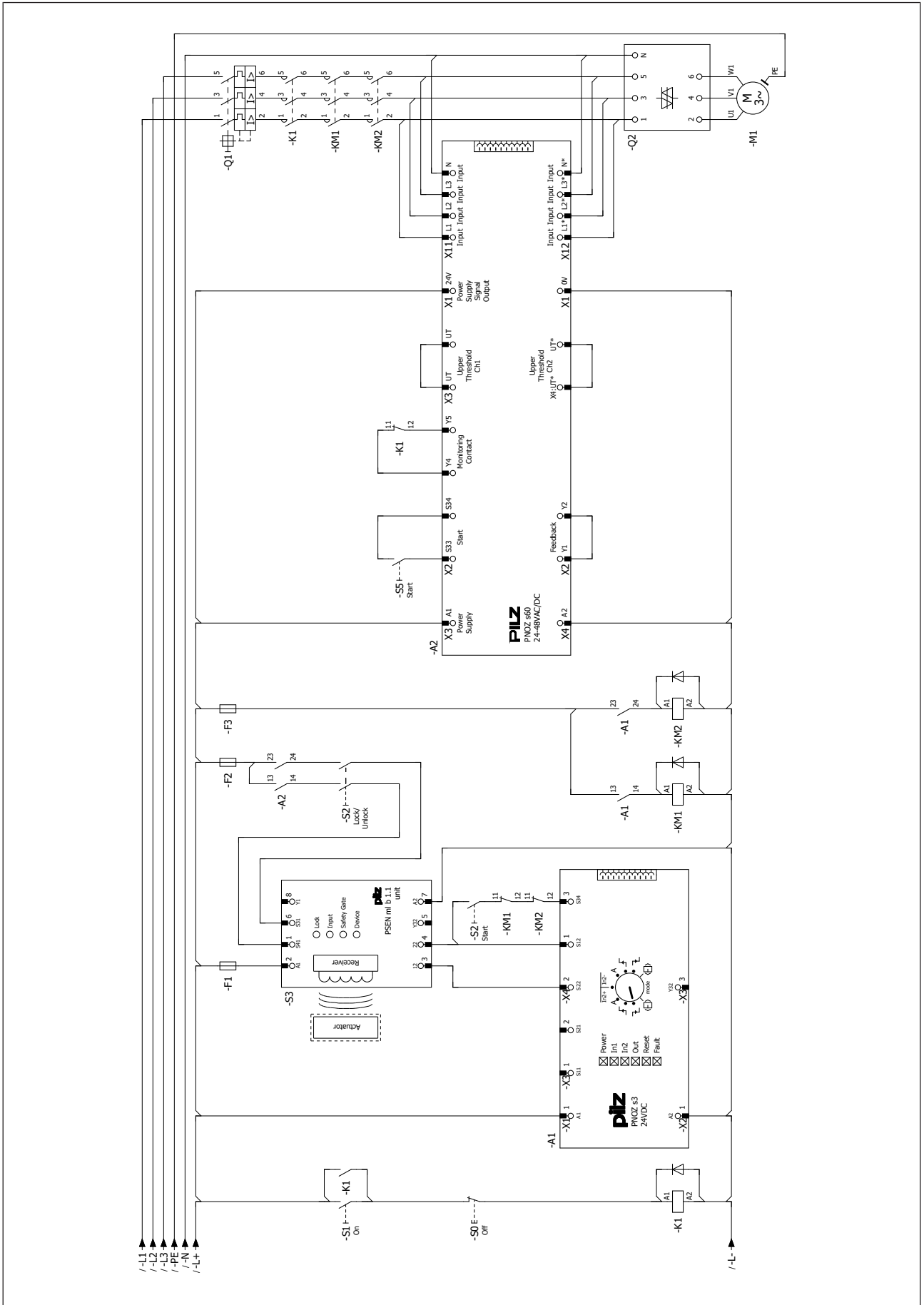

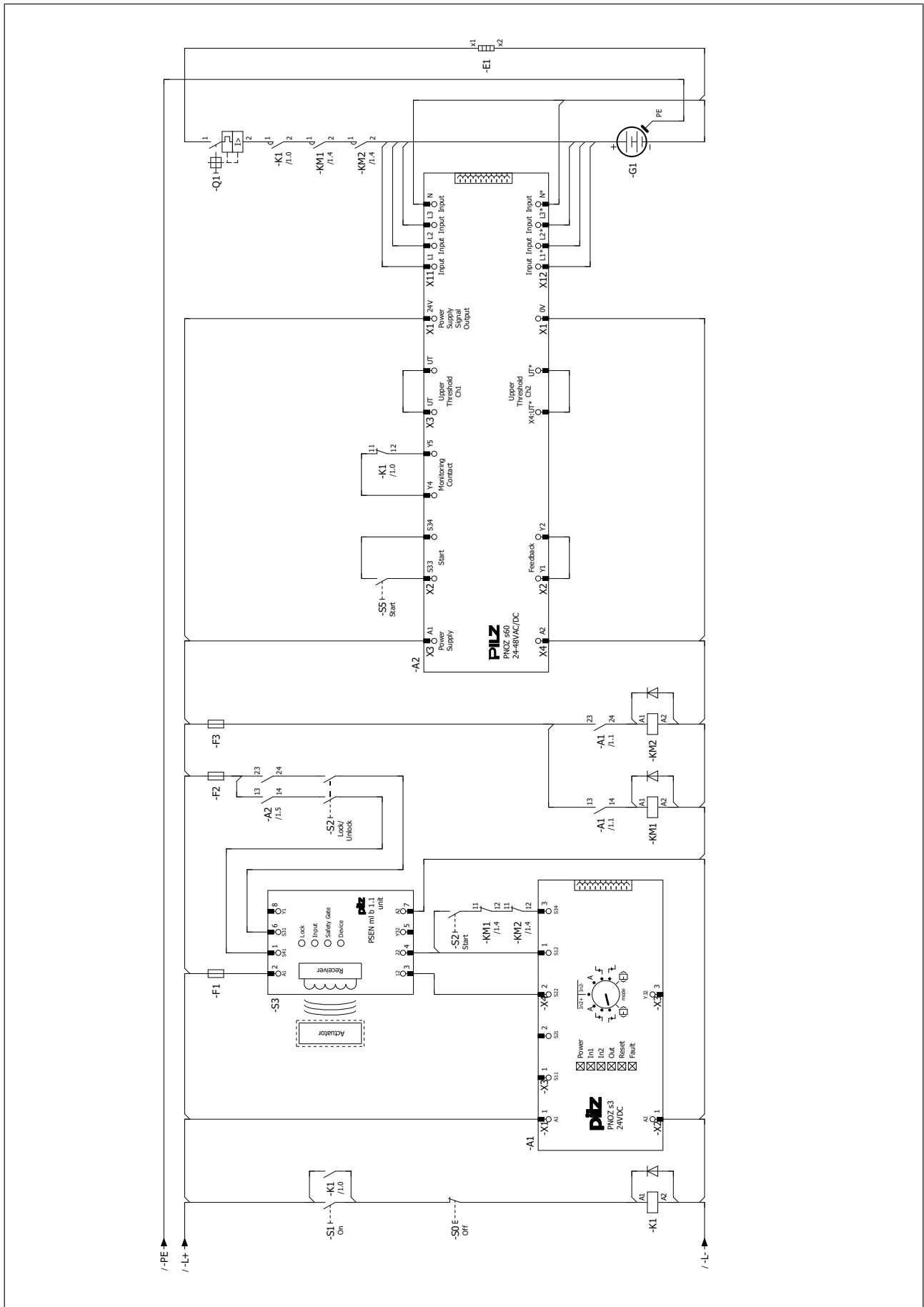

Operation

When the relay outputs are switched on, the mechanical contact on the relay cannot be tested automatically. Depending on the operational environment, measures to detect the non-opening of switching elements may be required under some circumstances.

When the product is used in accordance with the European Machinery Directive, a check must be carried out to ensure that the safety contacts on the relay outputs open correctly. Start the device again or open the safety contacts (switch off output), so that the internal diagnostics can check the correct opening of the safety contacts

- ▶ for SIL 3/PL e at least 1x per month
- ▶ for SIL 2/PL d at least 1x per year



NOTICE

The safety function should be checked after initial commissioning and each time the plant/machine is changed. The safety functions may only be checked by qualified personnel.



NOTICE

If the measuring voltages are below the set switching threshold for longer than 24 hours, the PNOZ s60 must be restarted (switch the supply voltage off and on).

Status indicators















INFORMATION

Several status indicators and error indicators may occur simultaneously.

The unit is ready for operation when the Power LED is permanently lit.

LEDs indicate the status and errors during operation:

-  LED on
-  LED flashes
-  LED off

	POWER Supply voltage is present.
	OUT Safety contacts are closed.
	SYSTEM FAULT see Faults - malfunctions [ 21]
	SYSTEM FAULT Internal housing temperature is between 75 ... 85 °C.
	LINE BREAK NEUTRAL Open circuit between N and N*.
	PLAUSIBILITY CHECK Input circuit (Y4-Y5) open and measuring voltage is lower than the set switching threshold.
	VOLTAGE HAZARD Input circuit (Y4-Y5) closed and measuring voltage is higher than the set switching threshold.
	VL1-L2(Y41) ... VL3-N(Y46) State of measuring voltage (see Function description [ 9])

Faults - malfunctions

- ▶ The "PLAUSIBILITY CHECK" LED lights: Measuring voltage is lower than the switching threshold, although input circuit Y4-Y5 is open.
- ▶ The "SYSTEM FAULT" LED lights:
 - Open circuit on at least one measuring cable
 - Time difference between the two measuring channels is too great
 - Internal fault
 - Internal housing temperature above 85 °C
 - Fault on the expansion module/terminator not connected
- ▶ The "VOLTAGE HAZARD" LED lights: At least one measuring voltage is higher than the switching threshold, although input circuit Y4-Y5 is closed.
- ▶ Malfunctions of the safety contacts (13-14, 23-24, 33-34): If the contacts have welded, re-activation will not be possible after the input circuit has opened.

Dimensions

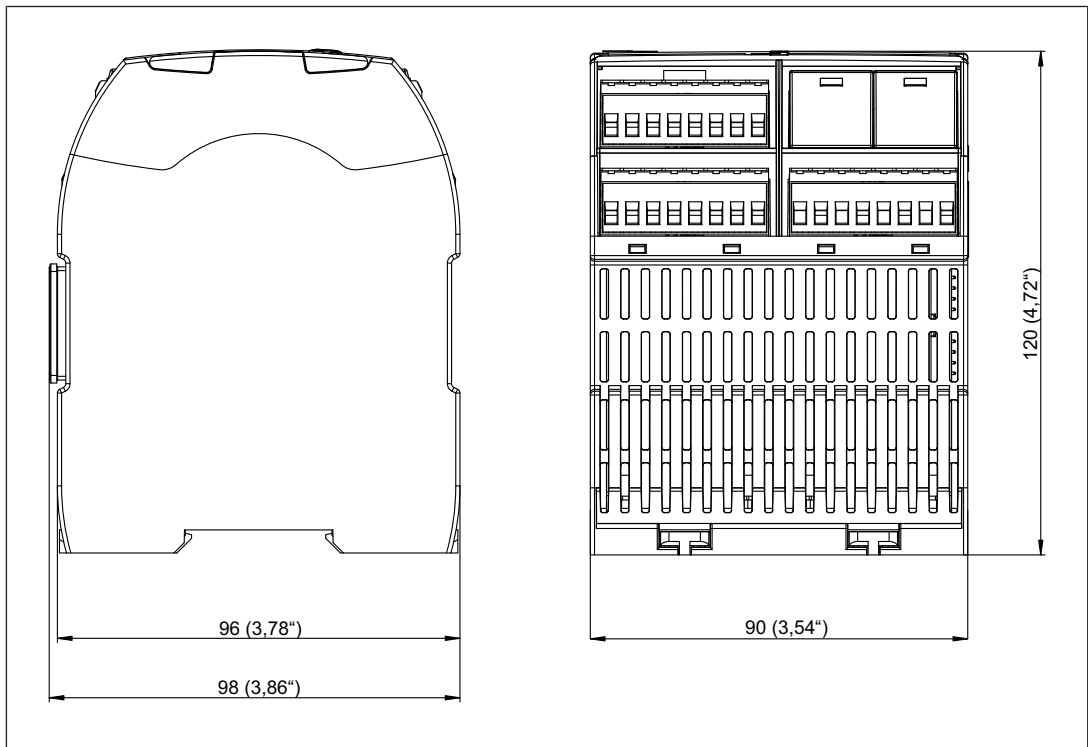

Fig.: Dimensions in mm (")

Technical details

General	750600	750601	751600	751601
Certifications	CCC, CE, EAC, TÜV, UKCA, cULus Listed	CCC, CE, EAC, TÜV, UKCA, cULus Listed	CCC, CE, EAC, TÜV, UKCA, cULus Listed	CCC, CE, EAC, TÜV, UKCA, cULus Listed
Electrical data	750600	750601	751600	751601
Supply voltage				
for	Device supply	Device supply	Device supply	Device supply
Voltage	24 - 48 V	100 - 240 V	24 - 48 V	100 - 240 V
Kind	AC/DC	AC/DC	AC/DC	AC/DC
Voltage tolerance	-15 %/+10 %	-15 %/+10 %	-15 %/+10 %	-15 %/+10 %
Output of external power supply (AC)	10,2 VA	10,5 VA	10,2 VA	10,5 VA
Output of external power supply (DC)	7,5 W	8 W	7,5 W	8 W
Frequency range AC	50 - 60 Hz	50 - 60 Hz	50 - 60 Hz	50 - 60 Hz
Duty cycle	100 %	100 %	100 %	100 %
Measuring circuit	750600	750601	751600	751601
Min. measuring voltage	110 V	110 V	110 V	110 V
Max. measuring voltage	600 V	600 V	600 V	600 V
Min. measuring voltage against N (N*)	64 V	64 V	64 V	64 V
Max. measuring voltage against N (N*)	346 V	346 V	346 V	346 V
Min. measuring voltage L+ against L-	64 V	64 V	64 V	64 V
Max. measuring voltage L+ against L-	420 V	420 V	420 V	420 V
Tolerance, measuring voltage	85 - 110 %	85 - 110 %	85 - 110 %	85 - 110 %
Frequency range	50 - 60 Hz	50 - 60 Hz	50 - 60 Hz	50 - 60 Hz
Frequency range against N	50 - 60 Hz	50 - 60 Hz	50 - 60 Hz	50 - 60 Hz
Upper switching threshold U _{reff}	6 V, 12 V	6 V, 12 V	6 V, 12 V	6 V, 12 V
Lower switching threshold U _{eff}	5 V, 10 V	5 V, 10 V	5 V, 10 V	5 V, 10 V
Input resistance	1.000 kOhm	1.000 kOhm	1.000 kOhm	1.000 kOhm
Max. neutral conductor impedance	120 Ohm	120 Ohm	120 Ohm	120 Ohm

Inputs	750600	750601	751600	751601
Number	6	6	6	6
Voltage at				
Input circuit DC	24 V	24 V	24 V	24 V
Start circuit DC	24 V	24 V	24 V	24 V
Feedback loop DC	24 V	24 V	24 V	24 V
Current at				
Input circuit DC	80 mA	80 mA	80 mA	80 mA
Start circuit DC	40 mA	40 mA	40 mA	40 mA
Feedback loop DC	0,5 mA	0,5 mA	0,5 mA	0,5 mA
Max. inrush current impulse				
Current pulse, input circuit	0,1 A	0,1 A	0,1 A	0,1 A
Pulse duration, input circuit	200 ms	200 ms	200 ms	200 ms
Current pulse, feedback loop	0,1 A	0,1 A	0,1 A	0,1 A
Pulse duration, feedback loop	150 ms	150 ms	150 ms	150 ms
Semiconductor outputs	750600	750601	751600	751601
Number	6	6	6	6
Voltage	24 V	24 V	24 V	24 V
Current	50 mA	50 mA	50 mA	50 mA
External supply voltage	24 V	24 V	24 V	24 V
Voltage tolerance	-20 %/+20 %	-20 %/+20 %	-20 %/+20 %	-20 %/+20 %
Semiconductor outputs (standard)	750600	750601	751600	751601
Switching capability				
Voltage	24 V	24 V	24 V	24 V
Current	0,05 A	0,05 A	0,05 A	0,05 A
Power	1,2 W	1,2 W	1,2 W	1,2 W
Galvanic isolation	yes	yes	yes	yes
Short circuit-proof	yes	yes	yes	yes
Residual current at "0"	0,1 mA	0,1 mA	0,1 mA	0,1 mA
Signal level at "1"	UB - 2.5 V DC at 0.05 A	UB - 2.5 V DC at 0.05 A	UB - 2.5 V DC at 0.05 A	UB - 2.5 V DC at 0.05 A

Relay outputs	750600	750601	751600	751601
Number of output contacts				
Safety contacts (N/O), instantaneous	3	3	3	3
Auxiliary contacts (N/C)	1	1	1	1
Max. short circuit current IK	1 kA	1 kA	1 kA	1 kA
Utilisation category				
In accordance with the standard	EN 60947-4-1	EN 60947-4-1	EN 60947-4-1	EN 60947-4-1
Utilisation category of safety contacts				
AC1 at	250 V	250 V	250 V	250 V
Min. current	5 mA	5 mA	5 mA	5 mA
Max. current	6 A	6 A	6 A	6 A
Max. power	1500 VA	1500 VA	1500 VA	1500 VA
DC1 at	24 V	24 V	24 V	24 V
Min. current	5 mA	5 mA	5 mA	5 mA
Max. current	6 A	6 A	6 A	6 A
Max. power	144 W	144 W	144 W	144 W
Utilisation category of auxiliary contacts				
AC1 at	250 V	250 V	250 V	250 V
Min. current	5 mA	5 mA	5 mA	5 mA
Max. current	6 A	6 A	6 A	6 A
Max. power	1500 VA	1500 VA	1500 VA	1500 VA
DC1 at	24 V	24 V	24 V	24 V
Min. current	5 mA	5 mA	5 mA	5 mA
Max. current	6 A	6 A	6 A	6 A
Max. power	144 W	144 W	144 W	144 W
Utilisation category				
In accordance with the standard	EN 60947-5-1	EN 60947-5-1	EN 60947-5-1	EN 60947-5-1
Utilisation category of safety contacts				
AC15 at	230 V	230 V	230 V	230 V
Max. current	3 A	3 A	3 A	3 A
DC13 (6 cycles/min) at	24 V	24 V	24 V	24 V
Max. current	5 A	5 A	5 A	5 A

Relay outputs	750600	750601	751600	751601
Utilisation category of auxiliary contacts				
AC15 at	230 V	230 V	230 V	230 V
Max. current	3 A	3 A	3 A	3 A
DC13 (6 cycles/min) at	24 V	24 V	24 V	24 V
Max. current	5 A	5 A	5 A	5 A
Utilisation category in accordance with UL				
Voltage	250 V AC G.U. (same polarity)	250 V AC G.U. (same polarity)	250 V AC G.U. (same polarity)	250 V AC G.U. (same polarity)
With current	6 A	6 A	6 A	6 A
Voltage	24 V DC G. U.	24 V DC G. U.	24 V DC G. U.	24 V DC G. U.
With current	6 A	6 A	6 A	6 A
Pilot Duty	R300, B300 for NO contact only	R300, B300 for NO contact only	R300, B300 for NO contact only	R300, B300 for NO contact only
External contact fuse protection, safety contacts				
In accordance with the standard	EN 60947-5-1	EN 60947-5-1	EN 60947-5-1	EN 60947-5-1
Max. melting integral	66 A²s	66 A²s	66 A²s	66 A²s
Blow-out fuse, quick	6 A	6 A	6 A	6 A
Blow-out fuse, slow	4 A	4 A	4 A	4 A
Blow-out fuse, gG	6 A	6 A	6 A	6 A
Circuit breaker 24V AC/DC, characteristic B/C	4 A	4 A	4 A	4 A
External contact fuse protection, auxiliary contacts				
Max. melting integral	66 A²s	66 A²s	66 A²s	66 A²s
Blow-out fuse, quick	6 A	6 A	6 A	6 A
Blow-out fuse, slow	4 A	4 A	4 A	4 A
Blow-out fuse, gG	6 A	6 A	6 A	6 A
Circuit breaker 24 V AC/DC, characteristic B/C	4 A	4 A	4 A	4 A
Contact material	AgCuNi + 0,2 µm Au	AgCuNi + 0,2 µm Au	AgCuNi + 0,2 µm Au	AgCuNi + 0,2 µm Au

Conventional thermal current while loading several contacts	750600	750601	751600	751601
Ith per contact at UB AC; AC1: 240 V, DC1: 24 V				
Conv. therm. current with 1 contact	6 A	6 A	6 A	6 A
Conv. therm. current with 2 contacts	6 A	6 A	6 A	6 A
Conv. therm. current with 3 contacts	4 A	4 A	4 A	4 A
Ith per contact at UB DC; AC1: 240 V, DC1: 24 V				
Conv. therm. current with 1 contact	6 A	6 A	6 A	6 A
Conv. therm. current with 2 contacts	6 A	6 A	6 A	6 A
Conv. therm. current with 3 contacts	4 A	4 A	4 A	4 A
Times	750600	750601	751600	751601
Switch-on delay				
With automatic start typ.	20 ms	20 ms	20 ms	20 ms
With automatic start max.	30 ms	30 ms	30 ms	30 ms
With automatic start after power on typ.	700 ms	700 ms	700 ms	700 ms
With automatic start after power on max.	800 ms	800 ms	800 ms	800 ms
With manual start typ.	20 ms	20 ms	20 ms	20 ms
With manual start max.	30 ms	30 ms	30 ms	30 ms

Times	750600	750601	751600	751601
Delay-on de-energisation				
With power failure typ. UB 240 V	–	140 ms	–	140 ms
With power failure max. UB 240 V	–	155 ms	–	155 ms
With power failure typ. UB 120 V	–	35 ms	–	35 ms
With power failure max. UB 120 V	–	40 ms	–	40 ms
After safety function is triggered typ.	20 ms	20 ms	20 ms	20 ms
After safety function is triggered max.	30 ms	30 ms	30 ms	30 ms
Recovery time at max. switching frequency 1/s				
After power failure	1500 ms	1500 ms	1500 ms	1500 ms
After safety function is triggered	1000 ms	1000 ms	1000 ms	1000 ms
Supply interruption before de-energisation				
	20 ms	10 ms	20 ms	10 ms
Simultaneity, channel 1 and 2 max.				
	3-8 s	3-8 s	3-8 s	3-8 s
Environmental data				
	750600	750601	751600	751601
Climatic suitability	EN 60068-2-1, EN 60068-2-14, EN 60068-2-2, EN 60068-2-78	EN 60068-2-1, EN 60068-2-14, EN 60068-2-2, EN 60068-2-78	EN 60068-2-1, EN 60068-2-14, EN 60068-2-2, EN 60068-2-78	EN 60068-2-1, EN 60068-2-14, EN 60068-2-2, EN 60068-2-78
Ambient temperature				
Temperature range	-10 - 55 °C	-10 - 55 °C	-10 - 55 °C	-10 - 55 °C
Storage temperature				
Temperature range	-40 - 85 °C	-40 - 85 °C	-40 - 85 °C	-40 - 85 °C
Climatic suitability				
Humidity	93 % r. h. at 40 °C	93 % r. h. at 40 °C	93 % r. h. at 40 °C	93 % r. h. at 40 °C
Condensation during operation				
	Not permitted	Not permitted	Not permitted	Not permitted
EMC				
	EN 60255-26, EN 61326-3-1	EN 60255-26, EN 61326-3-1	EN 60255-26, EN 61326-3-1	EN 60255-26, EN 61326-3-1

Environmental data	750600	750601	751600	751601
Vibration				
In accordance with the standard	EN 60255-21-1	EN 60255-21-1	EN 60255-21-1	EN 60255-21-1
Test severity class	Class 1	Class 1	Class 1	Class 1
Shock stress				
In accordance with the standard	EN 60255-21-2	EN 60255-21-2	EN 60255-21-2	EN 60255-21-2
Test severity class	Class 1	Class 1	Class 1	Class 1
Earthquake				
In accordance with the standard	EN 60255-21-3	EN 60255-21-3	EN 60255-21-3	EN 60255-21-3
Test severity class	Class 0	Class 0	Class 0	Class 0
Continuous shock				
Test severity class	Class 1	Class 1	Class 1	Class 1
Airgap creepage				
In accordance with the standard	EN 60255-27	EN 60255-27	EN 60255-27	EN 60255-27
Overvoltage category	III	III	III	III
Pollution degree	2	2	2	2
Rated insulation voltage	600 V	600 V	600 V	600 V
Rated impulse withstand voltage	6 kV	6 kV	6 kV	6 kV
Protection type				
Housing	IP20	IP20	IP20	IP20
Terminals	IP20	IP20	IP20	IP20
Mounting area (e.g. control cabinet)	IP54	IP54	IP54	IP54
Mechanical data	750600	750601	751600	751601
Mounting position	Any	Any	Any	Any
Mechanical life	10,000,000 cycles	10,000,000 cycles	10,000,000 cycles	10,000,000 cycles
Material				
Bottom	PC	PC	PC	PC
Front	PC	PC	PC	PC
Top	PC	PC	PC	PC
Connection type	Screw terminal	Screw terminal	Spring-loaded terminal	Spring-loaded terminal
Mounting type	plug-in	plug-in	plug-in	plug-in

Mechanical data	750600	750601	751600	751601
Conductor cross section with screw terminals				
1 core flexible	0,25 - 2,5 mm², 24 - 12 AWG	0,25 - 2,5 mm², 24 - 12 AWG	–	–
2 core with the same cross section, flexible with crimp connectors, no plastic sleeve	0,25 - 1 mm², 24 - 16 AWG	0,25 - 1 mm², 24 - 16 AWG	–	–
2 core with the same cross section, flexible without crimp connectors or with TWIN crimp connectors	0,2 - 1,5 mm², 24 - 16 AWG	0,2 - 1,5 mm², 24 - 16 AWG	–	–
Torque setting with screw terminals				
	0,5 Nm	0,5 Nm	–	–
Stripping length with screw terminals				
	8 mm	8 mm	–	–
Conductor cross section with spring-loaded terminals:				
Flexible with/without crimp connector	–	–	0,2 - 2,5 mm², 24 - 12 AWG	0,2 - 2,5 mm², 24 - 12 AWG
Spring-loaded terminals: Terminal points per connection				
	–	–	2	2
Stripping length with spring-loaded terminals				
	–	–	9 mm	9 mm
Dimensions				
Height	98 mm	98 mm	98 mm	98 mm
Width	90 mm	90 mm	90 mm	90 mm
Depth	120 mm	120 mm	120 mm	120 mm
Weight	670 g	655 g	670 g	655 g

Where standards are undated, the 2022-09 latest editions shall apply.

Safety characteristic data



NOTICE

You must comply with the safety characteristic data in order to achieve the required safety level for your plant/machine.

Operating mode	EN ISO 13849-1: 2015 PL	EN ISO 13849-1: 2015 Category	EN IEC 62061 SIL CL/ maximum SIL	EN IEC 62061 PFH _D [1/h]	EN/IEC 61511 SIL	EN/IEC 61511 PFD	EN ISO 13849-1: 2015 T _M [year]
–	PL e	Cat. 4	SIL 3	4,91E-10	SIL 3	3,56E-05	20

Explanatory notes for the safety-related characteristic data:

- ▶ Safety characteristic data in accordance with EN IEC 62061 and EN/IEC 61511 was calculated based on EN/IEC 61508.
- ▶ T_M is the maximum mission time in accordance with EN ISO 13849-1. The value also applies as the retest interval in accordance with EN/IEC 61508-6 and EN/IEC 61511 and as the proof test interval and mission time in accordance with EN IEC 62061.

All the units used within a safety function must be considered when calculating the safety characteristic data.



INFORMATION

A safety function's SIL/PL values are **not** identical to the SIL/PL values of the units that are used and may be different. We recommend that you use the PAScal software tool to calculate the safety function's SIL/PL values.



CAUTION!

It is essential to consider the relay's service life graphs. The relay outputs' safety-related characteristic data is only valid if the values in the service life graphs are met.

The PFH value depends on the switch frequency and the load of the relay output. If the service life graphs are not accessible, the stated PFH value can be used irrespective of the switch frequency and the load, as the PFH value already considers the relay's B10d value as well as the failure rates of the other components.

Supplementary data

Service life graph

The service life graphs indicate the number of cycles from which failures due to wear must be expected. The wear is mainly caused by the electrical load; the mechanical load is negligible.

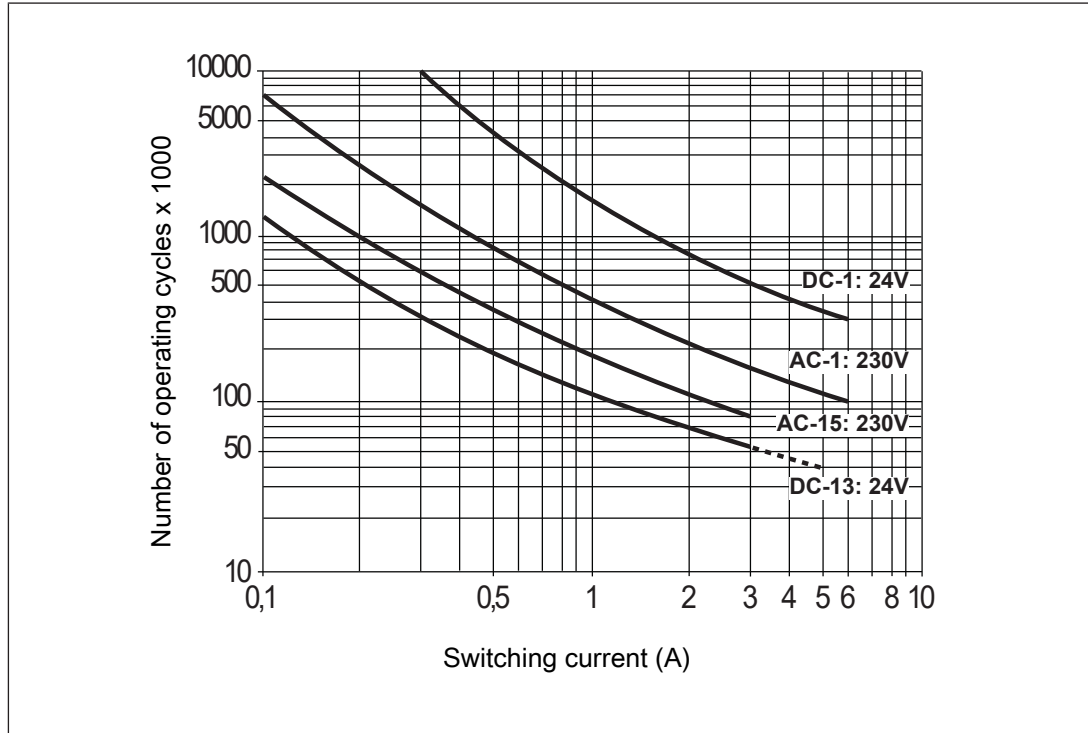

Fig.: Service life graphs at 24 VDC and 230 VAC

Example

- ▶ Inductive load: 0.2 A
- ▶ Utilisation category: AC15
- ▶ Contact service life: 1 000 000 cycles

Provided the application to be implemented requires fewer than 1 000 000 cycles, the PFH value (see [Technical details \[23\]](#)) can be used in the calculation.

To increase the service life, sufficient spark suppression must be provided on all relay contacts. With capacitive loads, any power surges that occur must be noted. With DC contactors, use flywheel diodes for spark suppression.

Permitted operating height

The values stated in the technical details apply to the use of the device in operating heights up to max. 2000 m above sea level. When used in greater heights, constraints have to be taken into account:

- ▶ Permitted maximum operating height 5000 m
- ▶ Reduction of the max. measuring voltage, the max. operating voltage and the max. voltage at the output relays for applications with protective separation:

Max. operating height	Max. measuring voltage Phase - Phase Phase - Neutral	Max. operating voltage	Max. voltage at the out- put relays
3000 m	300 V	150 V	150 V
4000 m	300 V	150 V	150 V
5000 m	150 V	150 V	150 V

- ▶ Reduction of the max. measuring voltage, the max. operating voltage and the max. voltage at the output relays for applications with basic insulation:

Max. operating height	Max. measuring voltage Phase - Phase Phase - Neutral	Max. operating voltage	Max. voltage at the out- put relays
3000 m	600 V	150 V	150 V
4000 m	600 V	150 V	150 V
5000 m	300 V	150 V	150 V

- ▶ From an operating height of 2000 m the max. permitted ambient temperature is reduced by 0.5 °C/100 m

Operating height	Permitted ambient temperature
3000 m	50 °C
4000 m	45 °C
5000 m	40 °C

Order reference

Product

Product type	Features	Connection type	Order no.
PNOZ s60	24 - 48 VAC/DC	Screw terminals	750600
PNOZ s60	100 – 240 VAC/DC	Screw terminals	750601
PNOZ s60	24 - 48 VAC/DC	Spring-loaded terminals	751600
PNOZ s60	100 – 240 VAC/DC	Spring-loaded terminals	751601

Accessories

Connector

Product type	Features	Order no.
PNOZ s terminator plug (10 pieces)	Connector for terminating a PNOZsigma base unit or PNOZsigma expansion module, 10 pieces	750010
PNOZ s connector (10 pieces)	Connector for connecting a PNOZsigma base unit to a PNOZsigma expansion module, 10 pieces	750020

EC declaration of conformity

This product/these products meet the requirements of the directive 2006/42/EC for machinery of the European Parliament and of the Council. The complete EC Declaration of Conformity is available on the Internet at www.pilz.com/downloads.

Authorised representative: Norbert Fröhlich, Pilz GmbH & Co. KG, Felix-Wankel-Str. 2, 73760 Ostfildern, Germany

UKCA-Declaration of Conformity

This product(s) complies with following UK legislation: Supply of Machinery (Safety) Regulation 2008.

The complete UKCA Declaration of Conformity is available on the Internet at www.pilz.com/downloads.

Representative: Pilz Automation Technology, Pilz House, Little Colliers Field, Corby, Northamptonshire, NN18 8TJ United Kingdom, eMail: mail@pilz.co.uk

► Support

Technical support is available from Pilz round the clock.

Americas

Brazil

+55 11 97569-2804

Canada

+1 888 315 7459

Mexico

+52 55 5572 1300

USA (toll-free)

+1 877-PILZUSA (745-9872)

Asia

China

+86 21 60880878-216

Japan

+81 45 471-2281

South Korea

+82 31 778 3300

Australia and Oceania

Australia

+61 3 95600621

New Zealand

+64 9 6345350

Europe

Austria

+43 1 7986263-0

Belgium, Luxembourg

+32 9 3217570

France

+33 3 88104003

Germany

+49 711 3409-444

Ireland

+353 21 4804983

Italy, Malta

+39 0362 1826711

Scandinavia

+45 74436332

Spain

+34 938497433

Switzerland

+41 62 88979-32

The Netherlands

+31 347 320477

Turkey

+90 216 5775552

United Kingdom

+44 1536 462203

You can reach our international hotline on:

+49 711 3409-222

support@pilz.com

Pilz develops environmentally-friendly products using ecological materials and energy-saving technologies. Offices and production facilities are ecologically designed, environmentally-aware and energy-saving. So Pilz offers sustainability, plus the security of using energy-efficient products and environmentally-friendly solutions.



We are represented internationally. Please refer to our homepage www.pilz.com for further details or contact our headquarters.

Headquarters: Pilz GmbH & Co. KG, Felix-Wankel-Straße 2, 73760 Ostfildern, Germany
 Telephone: +49 711 3409-0, Telefax: +49 711 3409-133, E-Mail: info@pilz.com, Internet: www.pilz.com

PILZ
 THE SPIRIT OF SAFETY

CECE®, CHRE®, CMSE®, InduraNET p®, Leansafe®, Master of Safety®, Master of Security®, PAS4000®, PAScall®, PASconfig®, Pilz®, PTT®, PLID®, PMCprimo®, PMCprotego®, PMClendo®, PMD®, PMJ®, PNOZ®, PRCM®, PRM®, PRTM®, PSEN®, PSS®, PVS®, SafetyBUS p®, SafetyEYE®, THE SPIRIT OF SAFETY® are registered and protected trademarks of Pilz GmbH & Co. KG in some countries. We would point out that product features may vary from the details stated in this document, depending on the status at the time of publication and the scope of the equipment. We accept no responsibility for the validity, accuracy and entirety of the text and graphics presented in this information. Please contact our Technical Support if you have any questions.

1004492-EN-03, 2022-02 Printed in Germany
 © Pilz GmbH & Co. KG, 2019