



PSEN 2.1p-21

PILZ
THE SPIRIT OF SAFETY

► PSEN sensor technology

This document is the original document.

Where unavoidable, for reasons of readability, the masculine form has been selected when formulating this document. We do assure you that all persons are regarded without discrimination and on an equal basis.

All rights to this documentation are reserved by Pilz GmbH & Co. KG. Copies may be made for the user's internal purposes. Suggestions and comments for improving this documentation will be gratefully received.

Pilz®, PIT®, PMI®, PNOZ®, Primo®, PSEN®, PSS®, PVIS®, SafetyBUS p®, SafetyEYE®, SafetyNET p®, the spirit of safety® are registered and protected trademarks of Pilz GmbH & Co. KG in some countries.



SD means Secure Digital

| | |
|--|-----------|
| Introduction | 4 |
| Validity of documentation | 4 |
| Using the documentation | 4 |
| Definition of symbols | 4 |
| Safety | 5 |
| Intended use | 5 |
| Safety regulations | 6 |
| Safety assessment | 6 |
| Use of qualified personnel | 6 |
| Warranty and liability | 6 |
| Disposal | 6 |
| For your safety | 7 |
| Unit features | 7 |
| Function description | 7 |
| Block diagram | 8 |
| Operating distances | 8 |
| Lateral and vertical offset | 9 |
| Wiring | 9 |
| Pin assignment | 10 |
| Requirements and connection to evaluation devices | 10 |
| Installation | 13 |
| Adjustment | 14 |
| Periodic test | 15 |
| Dimensions in mm | 15 |
| Technical details | 16 |
| Safety characteristic data | 17 |
| Order reference | 18 |
| System | 18 |
| Accessories | 18 |
| EC declaration of conformity | 19 |
| UKCA-Declaration of Conformity | 19 |

Introduction

Validity of documentation

This documentation is valid for the product PSEN 2.1p-21. It is valid until new documentation is published.

This operating manual explains the function and operation, describes the installation and provides guidelines on how to connect the product.

Using the documentation

This document is intended for instruction. Only install and commission the product if you have read and understood this document. The document should be retained for future reference.

Definition of symbols

Information that is particularly important is identified as follows:



DANGER!

This warning must be heeded! It warns of a hazardous situation that poses an immediate threat of serious injury and death and indicates preventive measures that can be taken.



WARNING!

This warning must be heeded! It warns of a hazardous situation that could lead to serious injury and death and indicates preventive measures that can be taken.



CAUTION!

This refers to a hazard that can lead to a less serious or minor injury plus material damage, and also provides information on preventive measures that can be taken.



NOTICE

This describes a situation in which the product or devices could be damaged and also provides information on preventive measures that can be taken. It also highlights areas within the text that are of particular importance.



INFORMATION

This gives advice on applications and provides information on special features.

Safety

Intended use



The safety function of the safety switch is:

- ▶ The N/O of the safety contact opens and the N/C of the safety contact closes, when the actuator is removed beyond the assured release distance s_{ar} or when the actuator is not detected.

The safety switch meets the requirements in accordance with:

- ▶ EN 60947-5-3: PDDB only in connection
 - with the actuator PSEN 2.1-20,
 - the interface PSEN i1 and
 - the approved evaluation devices.

The safety switch is designed for applications in series connections and it must only be operated with the following components:

- ▶ Actuator PSEN 2.1-20,
- ▶ Interface PSEN i1 (see [Order reference](#) [ 19]) and
- ▶ a suitable evaluation device (see [Requirements and connection to evaluation devices](#) [ 10]).

Improper use

The following is deemed improper use in particular

- ▶ Any component, technical or electrical modification to the product,
- ▶ Use of the product outside the areas described in this operating manual,
- ▶ Use of the product outside the technical details (see [Technical details](#) [ 16]).



NOTICE

EMC-compliant electrical installation

The product is designed for use in an industrial environment. The product may cause interference if installed in other environments. If installed in other environments, measures should be taken to comply with the applicable standards and directives for the respective installation site with regard to interference.

Safety regulations

Safety assessment

Before using a device, a safety assessment in accordance with the Machinery Directive is required.

The product as an individual component fulfils the functional safety requirements in accordance with EN ISO 13849 and EN 62061. However, this does not guarantee the functional safety of the overall plant/machine. To achieve the relevant safety level of the overall plant/machine's required safety functions, each safety function needs to be considered separately.

Use of qualified personnel

The products may only be assembled, installed, programmed, commissioned, operated, maintained and decommissioned by persons who are competent to do so.

A competent person is a qualified and knowledgeable person who, because of their training, experience and current professional activity, has the specialist knowledge required. To be able to inspect, assess and operate devices, systems and machines, the person has to be informed of the state of the art and the applicable national, European and international laws, directives and standards.

It is the company's responsibility only to employ personnel who

- ▶ Are familiar with the basic regulations concerning health and safety / accident prevention,
- ▶ Have read and understood the information provided in the section entitled Safety
- ▶ Have a good knowledge of the generic and specialist standards applicable to the specific application.

Warranty and liability

All claims to warranty and liability will be rendered invalid if

- ▶ The product was used contrary to the purpose for which it is intended,
- ▶ Damage can be attributed to not having followed the guidelines in the manual,
- ▶ Operating personnel are not suitably qualified,
- ▶ Any type of modification has been made (e.g. exchanging components on the PCB boards, soldering work etc.).

Disposal

- ▶ In safety-related applications, please comply with the mission time T_M in the safety-related characteristic data.
- ▶ When decommissioning, please comply with local regulations regarding the disposal of electronic devices (e.g. Electrical and Electronic Equipment Act).

For your safety**WARNING!****Loss of safety function due to manipulation of the interlocking device**

Manipulation of the interlocking device may lead to serious injury and death.

- You should prevent any possibility of the interlocking device being manipulated through the use of a spare actuator.
- Keep the substitute actuator in a safe place and protect it from unauthorised access.
- If substitute actuators are used, these must be installed as described under [Installation](#)  13].
- If the original actuators are replaced with substitute actuators, the original actuators must be destroyed before disposal.

- ▶ Do not remove the connector's protective cap until you are just about to connect the unit. This will prevent potential contamination.

Unit features



- ▶ The actuator PSEN 2.1-20 belongs to the safety switch.
- ▶ Coded actuator
- ▶ Safety switch with 4-pin M8 male connector
- ▶ 2 safety contacts (reed contacts - N/C and N/O)
- ▶ Design: Square
- ▶ Operation Magnetic
- ▶ Switching voltage 24 VDC
- ▶ LED to display switch status
- ▶ Series connection via PSEN i1 interface

Function description

If the actuator is within the response range (safety gate closed), the safety contacts on the safety switch will be switched. The N/O contact is closed and the N/C contact is opened.

The safety switch is designed for applications in series connections.

Operate the PSEN 2.1p-21 in conjunction with the following components:

- ▶ Actuator PSEN 2.1-20 (see [Order reference](#)  18]),
- ▶ Interface PSEN i1 (see [Order reference](#)  19]) and
- ▶ a connected evaluation device (see [Requirements and connection to evaluation devices](#)  10]).

Block diagram

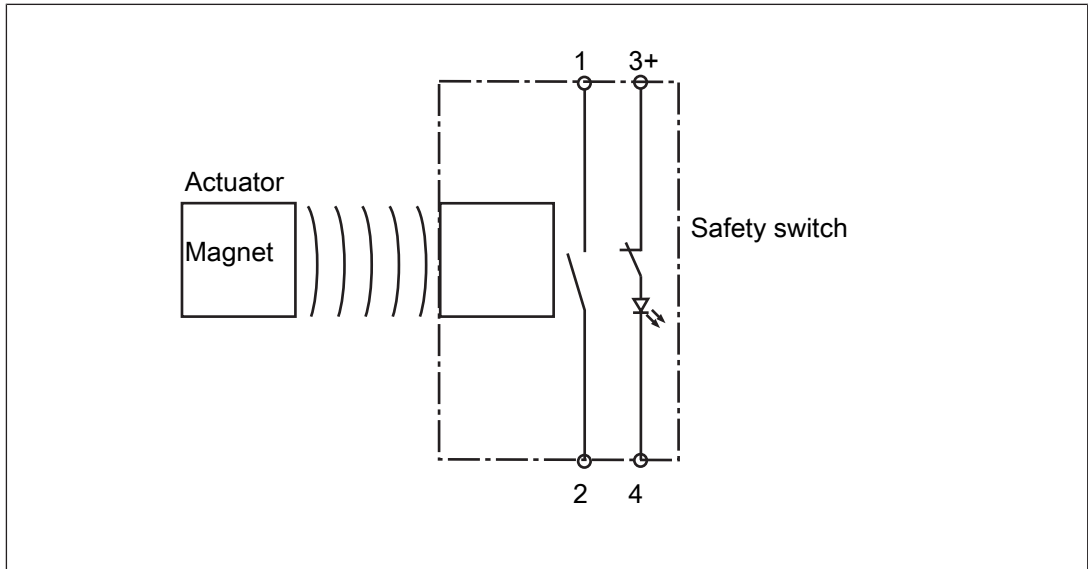

Operating distances

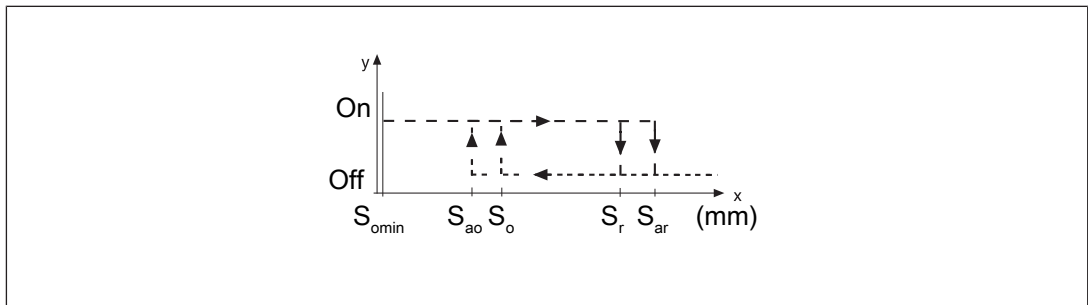

Legend

- S_{ao} Assured operating distance
- S_{omin} Min. operating distance
- S_{ar} Assured release distance

The offset-independent values for the switching distances are included in the [Technical details \[16\]](#).

Lateral and vertical offset

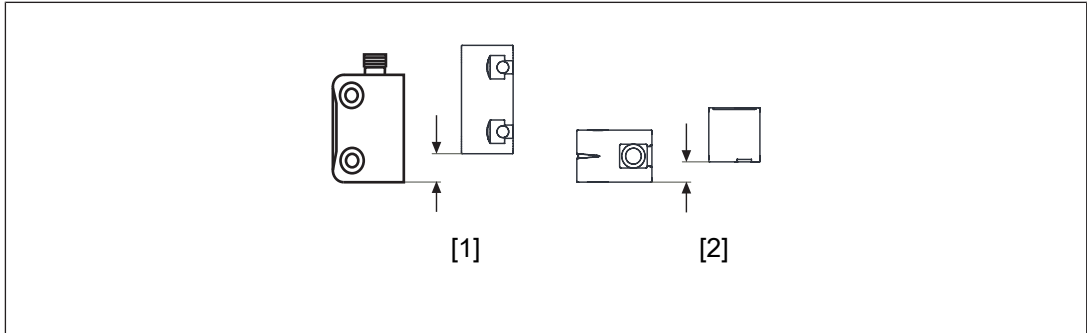

Legend

- [1] Lateral offset
- [2] Vertical offset

Actuator PSEN 2.1-20

The stated values are valid at a temperature of 20 °C.

| Assured operating distance S_{ao} in mm | | | | | | |
|---|----------------|-----|-----|-----|-----|-----|
| Vertical offset | Lateral offset | | | | | |
| | | 1.0 | 1.5 | 2.0 | 2.5 | 3.0 |
| 1 | | 7.5 | 7.5 | 7.5 | 7.0 | 7.0 |
| 2 | | 7.5 | 7.5 | 7.0 | 7.0 | 7.0 |
| 3 | | 7.0 | 7.0 | 7.0 | 6.5 | 6.5 |
| 4 | | 6.5 | 6.5 | 6.5 | 6.5 | 6.5 |
| 5 | | 6.0 | 6.0 | 6.0 | 5.5 | 5.5 |

Wiring

- ▶ Information given in the [Technical details \[16\]](#) must be followed.
- ▶ Calculation of the max. cable length l_{max} :

$$l_{max} = \frac{R_{lmax} - R_i}{R_l / km}$$

R_{lmax} = Max. overall cable resistance (see evaluation device's technical details)

R_i = Internal resistance sensor (see [Technical details \[16\]](#))

R_l / km = Cable resistance/km of the cable (see technical details cable)

- ▶ Ensure the wiring and EMC requirements of EN 60204-1 are met.

- ▶ In the following cases, check the function that detects shorts across contacts prior to commissioning:
 - On evaluation devices with DC supply voltage: Overall cable resistance ≥ 15 Ohms per channel
 - On evaluation devices with AC supply voltage: Overall cable resistance ≥ 25 Ohms per channel
 - For details of how to perform the test for shorts across the contacts, please refer to the operating manual for the relevant evaluation device.

Pin assignment



NOTICE

The colour marking for the connection lead only applies for the cable that Pilz supplies as an accessory

The safety switch is shown in an unoperated condition.

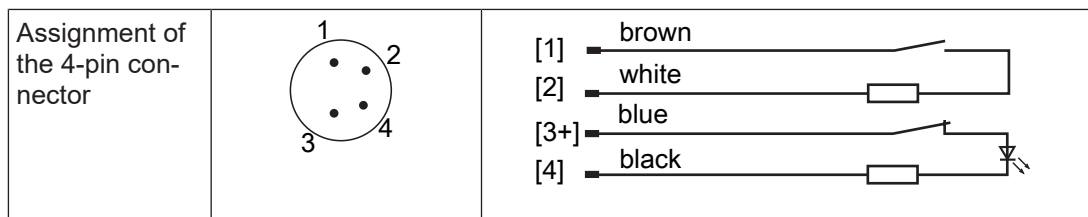

Requirements and connection to evaluation devices

For use of PSEN 2.1p-21 in accordance with DIN EN 60947-5-3 an evaluation device must be connected.

Connect the PSEN 2.1p-21

- ▶ **either** with a certified Pilz evaluation device
- ▶ **or** with an evaluation device with defined properties

Certified Pilz evaluation devices are, for example:

- ▶ PNOZelog for safety gate monitoring
 - PNOZ e3.1p, PNOZ e3vp
 - PNOZ e5.13p
- ▶ PNOZmulti for safety gate monitoring
Configure the switch in the PNOZmulti Configurator with switch type 2.
- ▶ PSS for safety gate monitoring with standard function block SB064, SB066 or FS_Safety Gate
- ▶ PSSuniversal PLC for safety gate monitoring with function block FS_SafetyGate

The correct connection to the respective evaluation device is described in the operating manual for the evaluation device. Make sure that the connection is made in accordance with the specifications in the operating manual for the selected evaluation device.

Defined properties of evaluation devices:

- ▶ 2-channel with feasibility monitoring
- ▶ Open circuit monitoring of the safety switch is performed
- ▶ Inputs and outputs on the evaluation device must fulfil the requirements of IEC 61131, Type 3
- ▶ Technical data of the evaluation device must fulfil the requirements in the [Technical details \[16\]](#) of PSEN 2.1p-21
 - Always comply with the max. switching current safety contacts of PSEN 2.1p-21.
- ▶ Outputs at the evaluation device must only be switched on again when both reed contacts at the safety switch have been opened and closed (partial operation lock)



INFORMATION

Risk time in accordance with DIN EN 60947-5-3

The risk time is made up of the reaction time of the sensor (see [Technical details \[16\]](#)) and the processing and delay times of the evaluation device (s. operating manual for the relevant evaluation device).

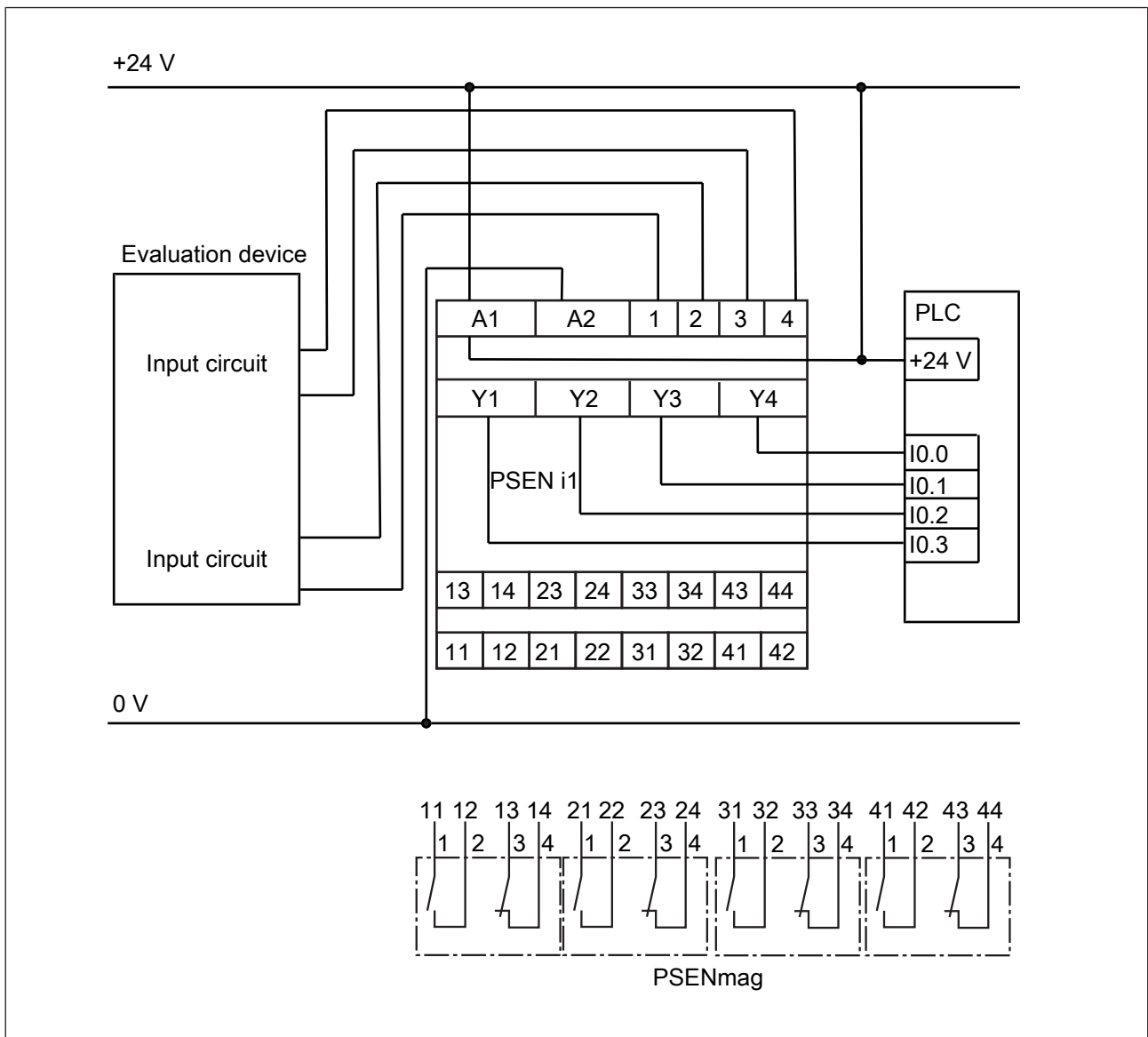
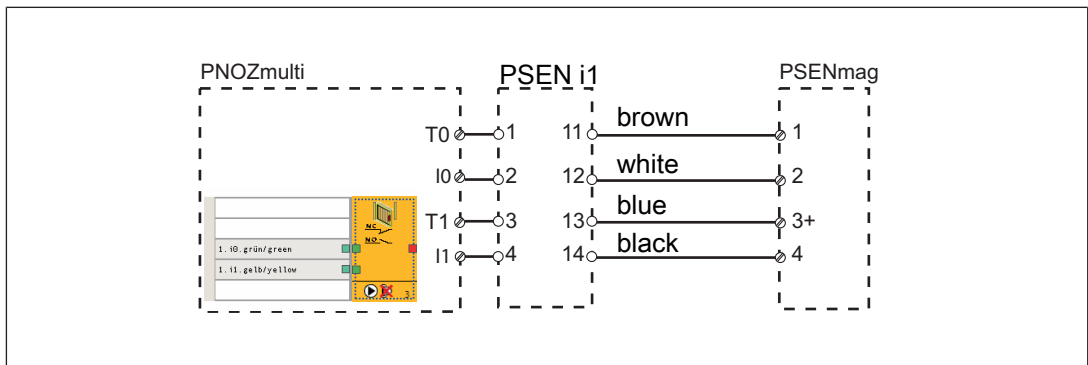

Fig.: Dual-channel connection of four PSENmag to the input circuits of an evaluation device

Examples for connection to Pilz evaluation devices:



Legend

I0 Input OSSD

I1 Input OSSD

T1, T2 Test pulse outputs

Installation



CAUTION!

Potential loss of safety function due to changed device properties

The unit's properties may be affected if installed in an environment containing electrically or magnetically conductive material.

- Please check the operating distances and the assured release distance.



CAUTION!

Possible loss of the safety function by changing the release distance S_{ar} with non-flush installation

Installing the safety switch non-flush within electrically or magnetically conductive material, the value for the assured release distance S_{ar} can change.

- Check the assured release distance S_{ar} .

- ▶ Safety switches and actuators must be positioned so that they are secured against a change of position.
- ▶ Secure the actuator using a countersunk screw M4 or M5.
- ▶ The safety switch and actuator should only be secured using screws and nuts made of non-magnetic material (e.g. brass or stainless steel).
- ▶ Avoid the risk of damages from foreseeable external influences by attaching the safety switch and actuator. If necessary, safety switch and actuator have to be protected.



INFORMATION

Protect the actuator from unauthorised removal (e.g. via a screw lock or concealed installation) and from contamination.

- ▶ Prevent self-loosening of the fastening elements of safety switch and actuator.
- ▶ The fastening of safety switch and actuator has to be sufficiently stable to ensure the proper operation of the safety switch and the actuator.
- ▶ The distance between two safety switches must be maintained (see [Technical details \[16\]](#)).
- ▶ Safety switches and actuators
 - Should be kept away from iron swarf
 - Should not be exposed to strong magnetic fields
- ▶ Prevent the safety switch and actuator being exposed to heavy shock or vibration.
- ▶ Make sure that the safety switch and actuator cannot be used as an end stop.
- ▶ Circumvention of the safety switch in a reasonably foreseeable manner must be prevented.
- ▶ Please note the installation measures in accordance with EN ISO 14119 for a proximity switch type 4 with coding level Low.
- ▶ Alignment errors of the guard must not adversely affect the safety function of the guard.
- ▶ The assured operating distance S_{ao} and the assured release distance S_{ar} must be tested under real conditions.
- ▶ Do not apply any installation tools (e.g. Pliers) on the surfaces of the switch.
- ▶ Install safety switch and actuator
 - facing each other in parallel
 - so that the faces with the product names are opposite each other.
- ▶ The protection type (see [Technical details \[16\]](#)) can only be achieved by using the Pilz connection leads available as an accessory.
- ▶ If possible, do not install the safety switch and actuator on to ferromagnetic material. Changes to the operating distances are to be expected. In this case, use the spacer (see [Order reference \[19\]](#)).

Adjustment

- ▶ The safety switch may only be used with the corresponding actuator PSEN 2.1-20.
- ▶ Always test the function with the PSEN i1 interface and connected evaluation device.
- ▶ The stated operating distances (see [Technical details \[16\]](#)) only apply when the safety switch and actuator are installed according to the specifications in [Installation \[13\]](#). Operating distances may deviate if other arrangements are used. Note the maximum permitted lateral and vertical offset (see [Operating distances and Lateral and vertical offset \[8\]](#)).

Periodic test

- ▶ Carry out a monthly function test on the safety switch and actuator.
- ▶ Always test the function with the PSEN i1 interface and connected evaluation device.
- ▶ The safety function may only be checked by qualified personnel.

Dimensions in mm

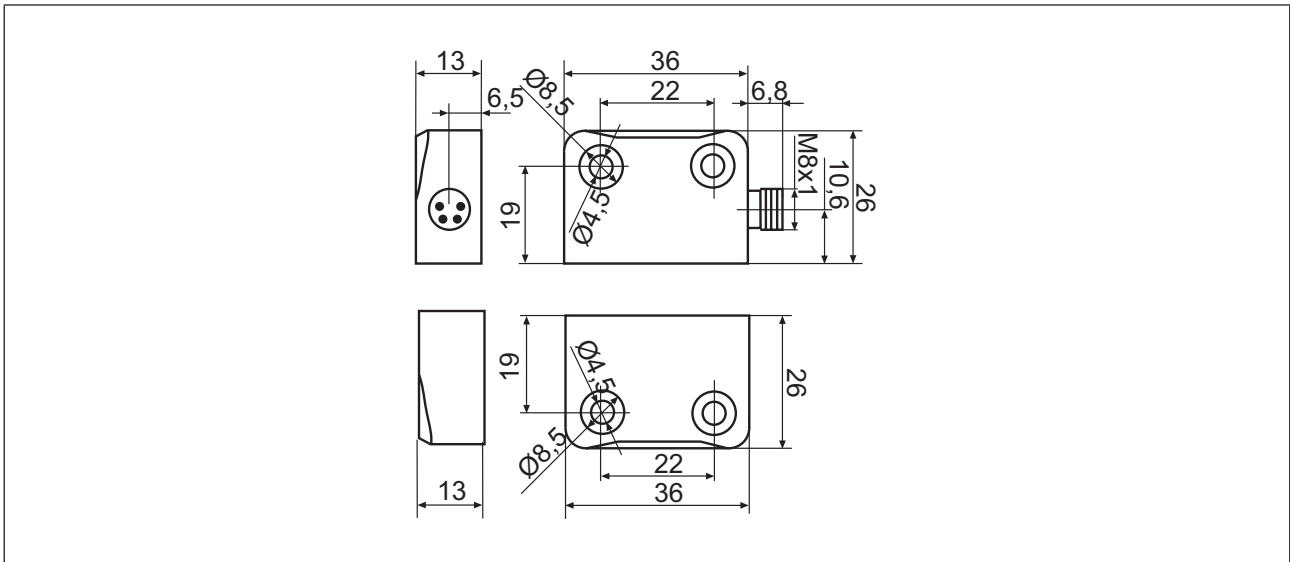

Technical details

| General | |
|--|---|
| Certifications | CE, EAC, TÜV, UKCA, cULus Listed |
| Sensor's mode of operation | Magnetic |
| Coding level in accordance with EN ISO 14119 | Low |
| Design in accordance with EN ISO 14119 | 4 |
| Classification in accordance with EN 60947-5-3 | PDDB |
| Electrical data | |
| Supply voltage | |
| Voltage | 24 V |
| Kind | DC |
| Voltage tolerance | -20 %/+20 % |
| Max. switching frequency | 1 Hz |
| Lowest operating current (I _m) | 1 mA |
| Switching voltage | 24 V |
| Internal resistance | 100 Ohm |
| Max. switching current, safety contacts | 10 mA |
| Max. breaking capacity, safety contacts | 0,3 W |
| Times | |
| Reaction time (actuator removed) | 2 ms |
| Environmental data | |
| Ambient temperature | |
| Temperature range | -25 - 70 °C |
| Climatic suitability | |
| In accordance with the standard | IEC 60068-2-30 |
| Humidity | 93 % r. h. at 40 °C |
| Max. operating height above sea level | 2000 m |
| EMC | EN 60947-5-3 |
| Vibration | |
| In accordance with the standard | EN 60947-5-2 |
| Frequency | 10 - 55 Hz |
| Amplitude | 1 mm |
| Shock stress | |
| Acceleration | 30g |
| Duration | 11 ms |
| Airgap creepage | |
| Pollution degree | 3 |
| Rated insulation voltage | 25 V |
| Rated impulse withstand voltage | 0,33 kV |
| Protection type | |
| Housing | IP65, IP67 |
| Connector | IP67 |
| Operating distances | |
| Assured operating distance S _{ao} | 8 mm |

| Operating distances | |
|---|--|
| Min. operating distance Somin | 0,5 mm |
| Assured release distance Sar | 26 mm |
| Repetition accuracy switching distances | 6 % |
| Mechanical data | |
| Actuator 1 | PSEN 2.1-20 |
| Typ. Hysteresis | 6 mm |
| Sensor flush installation in accordance with EN 60947-5-2 | yes, follow installation guidelines |
| Connection type | M8, 4-pin male connector |
| Material | |
| Top | PBT |
| Max. torque setting | |
| Safety switch | 1 Nm |
| Actuator 1 | 1 Nm |
| Dimensions | |
| Height | 36 mm |
| Width | 26 mm |
| Depth | 13 mm |
| Actuator dimensions | |
| Height | 36 mm |
| Width | 26 mm |
| Depth | 13 mm |
| Weight of safety switch | 15 g |
| Weight of actuator | 20 g |
| Weight | 35 g |

Where standards are undated, the 2015-09 latest editions shall apply.

Safety characteristic data



NOTICE

You must comply with the safety characteristic data in order to achieve the required safety level for your plant/machine.

| | |
|--|---|
| B10d in accordance with EN ISO 13849-1: 2015 and EN 62061 | TM [year] in accordance with EN ISO 13849-1:2015 |
| 2.000.000 | 20 |

Order reference

System

| Product type | Features | Connection type | Order no. |
|---|---|-------------------------|-----------|
| PSEN 2.1p-21/PSEN 2.1-20 /8mm/LED/1unit | Magnetic safety switch, actuator cube, with assured operating distance 8 mm | 4-pin M8 male connector | 502221 |
| PSEN 2.1p-21/8mm/LED/1switch | Magnetic safety switch | 4-pin M8 male connector | 522121 |
| PSEN 2.1-20/1actuator | Actuator cube, with assured operating distance 8 mm | | 512120 |

Accessories

Cable

| Product type | Connection 1 | Connection 2 | Length | Order no. |
|---|--------------------------------------|-----------------------------|--------|-----------|
| PSEN Kabel Winkel/cable angleplug 2m | Female connector, M8 angled, 4-pin | Open cable end | 2 m | 533110 |
| PSEN Kabel Gerade /cable straightplug 2m | Female connector, M8 straight, 4-pin | | 2 m | 533111 |
| PSEN Kabel Winkel/cable angleplug 5m | Female connector, M8 angled, 4-pin | | 5 m | 533120 |
| PSEN Kabel Gerade/cable straightplug 5m | Female connector, M8 straight, 4-pin | | 5 m | 533121 |
| PSEN Kabel Winkel/cable angleplug 10m | Female connector, M8 angled, 4-pin | | 10 m | 533130 |
| PSEN Kabel Gerade /cable straightplug 10m | Female connector, M8 straight, 4-pin | | 10 m | 533131 |
| PSEN Kabel Winkel/cable angleplug 3m | Female connector, M8 angled, 4-pin | | 30 m | 533140 |
| PSEN Kabel Gerade /cable straightplug 30m | Female connector, M8 straight, 4-pin | | 30 m | 533141 |
| PSS67 Cable M8sf M12sm | Female connector, M8 straight, 4-pin | Male connector M12 straight | 3 m | 380200 |
| | | | 5 m | 380201 |
| | | | 10 m | 380202 |
| | | | 30 m | 380203 |
| PSS67 Cable M8af M12sm | Female connector M8 angled, 4-pin | | 3 m | 380204 |
| | | | 5 m | 380205 |
| | | | 10 m | 380206 |
| | | | 30 m | 380207 |

Installation material

| Product type | Features | Order no. |
|------------------------|---|-----------|
| PSEN Winkel / bracket | Mounting bracket | 532110 |
| PSEN spacer | Spacer | 534310 |
| PSEN reverse spacer | Spacer | 534320 |
| PSEN screw M4x16 10pcs | Screws made of high-grade steel with one-way slot | 540310 |

Connector

| Product type | Features | Order no. |
|-----------------|---|-----------|
| PSEN ma adapter | Adapter for connecting the safety switch to PSS67 and PDP67 | 380300 |

Series connection

| Product type | Features | Order no. |
|--------------------------------|---|-----------|
| PSEN i1 Interface for 4 PSEN 2 | Interface PSEN i1 for connecting and evaluating several safety switches PSEN ma | 535110 |
| PDP67 F 8DI ION | Decentralised input module IP67 for PNOZmulti | 773600 |

EC declaration of conformity

This product/these products meet the requirements of the directive 2006/42/EC for machinery of the European Parliament and of the Council. The complete EC Declaration of Conformity is available on the Internet at www.pilz.com/downloads.

Authorised representative: Norbert Fröhlich, Pilz GmbH & Co. KG, Felix-Wankel-Str. 2, 73760 Ostfildern, Germany

UKCA-Declaration of Conformity

This product(s) complies with following UK legislation: Supply of Machinery (Safety) Regulation 2008.

The complete UKCA Declaration of Conformity is available on the Internet at www.pilz.com/downloads.

Representative: Pilz Automation Technology, Pilz House, Little Colliers Field, Corby, Northamptonshire, NN18 8TJ United Kingdom, eMail: mail@pilz.co.uk

