

PSEN Y junction M8 SENS/Cable

► Accessories

Connection

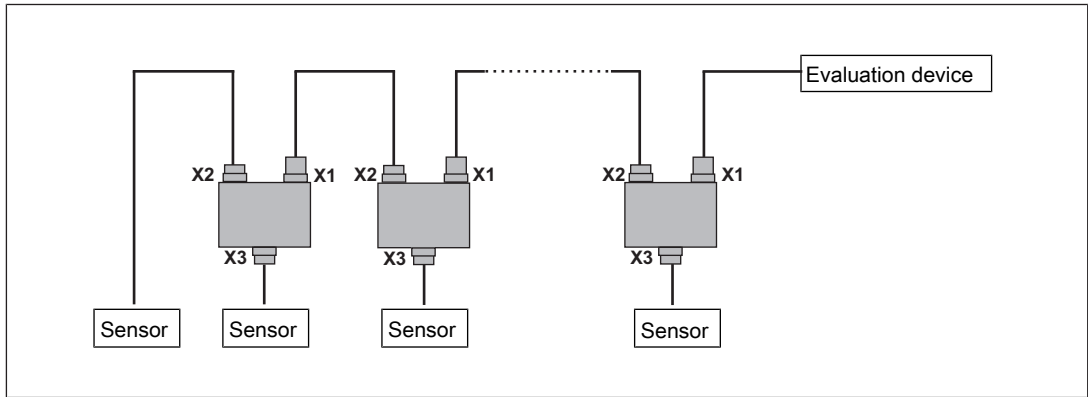

Fig.: Connection PSEN Y junction M8 SENSOR (order no. 540317)

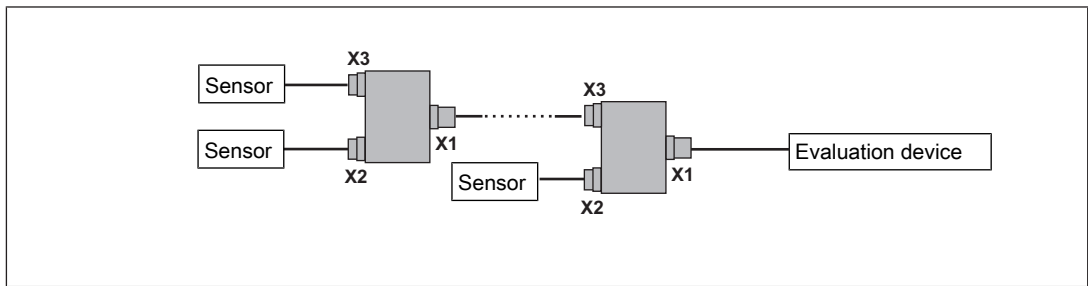

Fig.: Connection PSEN Y junction M8 cable channel (order no. 540318)

Legende

- X1 M8 male connector
- X2 M8 female connector
- X3 M8 female connector



NOTICE

When commissioning, activate the safety function of each sensor in the safety chain and check the correct response of the evaluation device's safety outputs.

Connector pin assignment

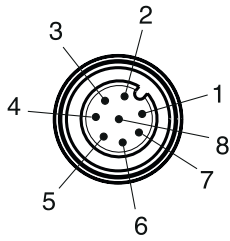

Plan view of plug-in connector X1

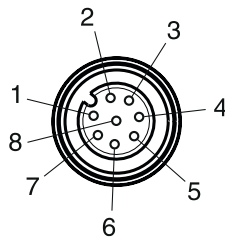

Plan view of plug-in connector X2

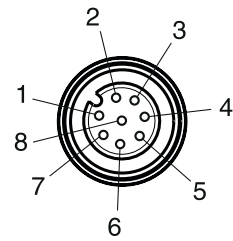

Plan view of plug-in connector X3

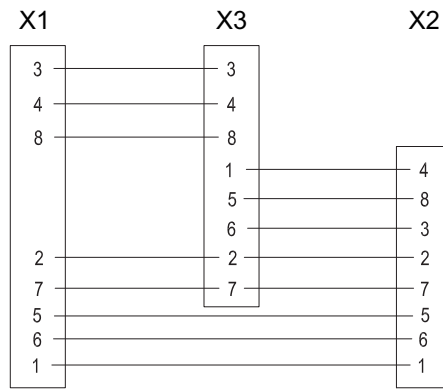

Contact assignment 8-pin

Dimensions

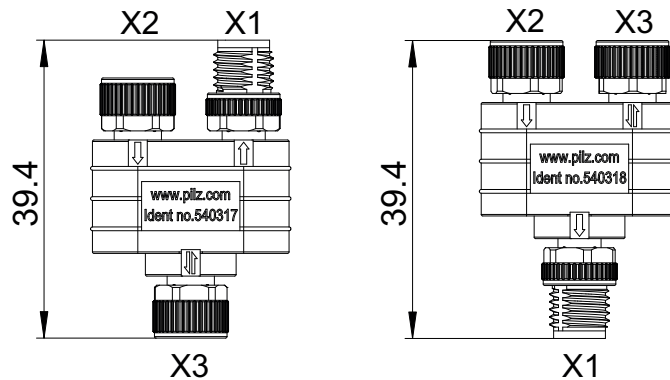
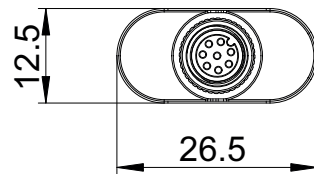

Technical details

General	540317	540318
Approvals	-	-
Electrical data	540317	540318
Rated voltage		
Voltage UB	30 V	30 V
Rated current	1 A	1 A
Test voltage	500 V	500 V
Insulation resistance	100 MOhm	100 MOhm
Volume resistance	5 mOhm	5 mOhm
Environmental data	540317	540318
Ambient temperature		
Temperature range	-20 - 80 °C	-20 - 80 °C
Airgap creepage		
Pollution degree	3	3
Protection type		
X1 when inserted	IP67	IP67
X2 when inserted	IP67	IP67
X3 when inserted	IP67	IP67
Housing	IP67	IP67
Mechanical data	540317	540318
Plug-in connector X1	M8, 8-pin male connector	M8, 8-pin male connector
In accordance with the standard	EN 61076-2-104	EN 61076-2-104
Plug-in connector X2	M8, 8-pin female connector	M8, 8-pin female connector
In accordance with the standard	EN 61076-2-104	EN 61076-2-104
Plug-in connector X3	M8, 8-pin female connector	M8, 8-pin female connector
In accordance with the standard	EN 61076-2-104	EN 61076-2-104
Material of ring nut X1	Zn nickel-plated	Zn nickel-plated
Material of ring nut X2	Zn nickel-plated	Zn nickel-plated
Material of ring nut X3	Zn nickel-plated	Zn nickel-plated
Housing material X1	TPU	TPU
Housing material X2	TPU	TPU
Housing material X3	TPU	TPU
Material of contact surface X1	Au	Au
Material of contact surface X2	Au	Au
Material of contact surface X3	Au	Au
Material of gasket	FPM	FPM
Material of pin	CuZn gold-plated	CuZn gold-plated
Material of socket	CuZn gold-plated	CuZn gold-plated
Mating cycles X1	100	100
Mating cycles X2	100	100
Mating cycles X3	100	100
Colour of housing	black	black

Mechanical data	540317	540318
Material		
Housing	TPU	TPU
Weight	12 g	12 g

Order reference

Product type	Features	Connector X1	Connector X2	Connector X3	Order No.
PSEN Y junction M8 SENSOR		M8 male connector	M8 female connector	M8 female connector	540 317
PSEN Y junction M8 cable channel		M8 male connector	M8 female connector	M8 female connector	540 318

► Support

Technical support is available from Pilz round the clock.

Americas

Brazil
+55 11 97569-2804

Canada
+1 888-315-PILZ (315-7459)

Mexico
+52 55 5572 1300

USA (toll-free)
+1 877-PILZUSA (745-9872)

Asia

China
+86 21 60880878-216

Japan
+81 45 471-2281

South Korea
+82 31 450 0680

Australia

+61 3 95446300

Europe

Austria
+43 1 7986263-0

Belgium, Luxembourg
+32 9 3217575

France
+33 3 88104000

Germany
+49 711 3409-444

Ireland
+353 21 4804983

Italy
+39 0362 1826711

Scandinavia

+45 74436332

Spain

+34 938497433

Switzerland

+41 62 88979-30

The Netherlands

+31 347 320477

Turkey

+90 216 5775552

United Kingdom

+44 1536 462203

You can reach our international hotline on:

+49 711 3409-444
support@pilz.com

Pilz develops environmentally-friendly products using ecological materials and energy-saving technologies. Offices and production facilities are ecologically designed, environmentally-aware and energy-saving. So Pilz offers sustainability, plus the security of using energy-efficient products and environmentally-friendly solutions.



Pilz GmbH & Co. KG
Felix-Wankel-Straße 2
73760 Ostfildern, Germany
Tel.: +49 711 3409-0
Fax: +49 711 3409-133
info@pilz.com
www.pilz.com

