



**PSEN op2H-s-30-XXX/1**

**Safety light curtains with infrared beams**



**OPERATION MANUAL**

**1001421-EN-03**

This document is a translation of the original document.

All rights to this documentation are reserved by Pilz GmbH & Co. KG. Copies may be made for internal purposes.

Suggestions and comments for improving this documentation will be gratefully received.

Pilz®, PIT®, PMI®, PNOZ®, Primo®, PSEN®, PSS®, PVIS®, SafetyBUS p®, SafetyEYE®, SafetyNET p®, the spirit of safety® are registered and protected trademarks of Pilz GmbH & Co. KG in some countries.

Pilz GmbH & Co. KG  
Felix-Wankel-Straße 2  
73760 Ostfildern, Germany  
Telephone: +49 711 3409-0  
Telefax: +49 711 3409-133  
E-Mail: [pilz.gmbh@pilz.de](mailto:pilz.gmbh@pilz.de)  
[www.pilz.com](http://www.pilz.com)

## INDEX

<b>1. GENERAL INFORMATION .....</b>	<b>1</b>
1.1. General description of the safety light curtains.....	1
1.1.1. <i>Package contents</i> .....	3
1.2. New features compared to the PSEN op2H Series .....	3
1.3. How to choose the device.....	4
1.3.1. <i>Resolution</i> .....	4
1.3.2. <i>Controlled height</i> .....	5
1.3.3. <i>Minimum installation distance</i> .....	6
1.4. Typical applications .....	9
1.5. Safety information.....	11
<b>2. INSTALLATION MODE .....</b>	<b>12</b>
2.1. Precautions to be observed for the choice and installation of the device .....	12
2.2. General information on device positioning .....	13
2.2.1. <i>Minimum installation distance</i> .....	14
2.2.2. <i>Minimum distance from reflecting surfaces</i> .....	15
2.2.3. <i>Emitter and receiver orientation</i> .....	17
2.2.4. <i>Installation of several adjacent safety light curtains</i> .....	18
2.2.5. <i>Use of deviating mirrors</i> .....	19
2.2.6. <i>Controls after first installation</i> .....	20
<b>3. MECHANICAL MOUNTING .....</b>	<b>22</b>
<b>4. ELECTRICAL CONNECTIONS .....</b>	<b>25</b>
4.1. Notes on connections .....	26
4.2. Earth connection .....	29
<b>5. ALIGNMENT PROCEDURE.....</b>	<b>30</b>
5.1. Correct alignment procedure .....	32
<b>6. FUNCTIONING MODE .....</b>	<b>33</b>
6.1. Reset mode.....	33
6.2. Test function.....	33
6.3. Reset function .....	34
<b>7. DIAGNOSTIC FUNCTIONS.....</b>	<b>35</b>
7.1. User interface.....	35
7.2. Diagnostic messages .....	36
<b>8. PERIODICAL CHECKS.....</b>	<b>38</b>
8.1. General information and useful data .....	39
<b>9. DEVICE MAINTENANCE .....</b>	<b>40</b>
9.1. Product disposal.....	40
<b>10. TECHNICAL DATA .....</b>	<b>41</b>
<b>11. LIST OF AVAILABLE MODELS.....</b>	<b>42</b>
<b>12. OVERALL DIMENSIONS .....</b>	<b>43</b>
<b>13. OUTFIT .....</b>	<b>44</b>
<b>14. ACCESSORIES.....</b>	<b>45</b>
14.1. Angled fixing bracket mounting.....	46
<b>15. GLOSSARY .....</b>	<b>50</b>



## 1. GENERAL INFORMATION

### 1.1. General description of the safety light curtains

The safety light curtains of the PSEN op2H-s series are optoelectronic multibeam devices that are used to protect working areas that, in presence of machines, robots, and automatic systems in general, can become dangerous for operators that can get in touch, even accidentally, with moving parts.

The light curtains of the PSEN op2H-s series are Type 2 intrinsic safety systems used as accident-prevention protection devices and are manufactured in accordance with the international Standards in force for safety, in particular:

- |                              |   |
|------------------------------|---|
| <b>CEI IEC 61496-1:</b> 2004 | Safety of machinery: electro-sensitive protective equipment. Part 1: General prescriptions and tests.   |
| <b>CEI IEC 61496-2:</b> 2006 | Safety of machinery: electro-sensitive protective equipment - Particular requirements for equipment using active optoelectronic protective devices. |

The device, consisting of one emitter and one receiver housed inside strong aluminium profiles, generates infrared beams that detect any opaque object positioned within the light curtain detection field. The emitter and the receiver are equipped with the command and control functions. The connections are made through a M12 connector located in the lower side of the profile. The synchronisation between the emitter and the receiver takes place optically, *i.e.* no electrical connection between the two units is required. The microprocessor guarantees the check and the management of the beams that are sent and received through the units. The microprocessor – through some LEDs – informs the operator about the general conditions of the safety light curtain (see section 7 “Diagnostic functions”).

The device consists in 2 units that, according to the model, are composed by one or several emitting and receiving modules.  
The receiver checks the control operations and safety actions.

During installation, two yellow LEDs facilitate the alignment of both units (see section 5 “*Alignment procedure*”).

As soon as an object, a limb or the operator’s body accidentally interrupts one or some of the infrared beams sent by the emitter, the receiver immediately opens the OSSD outputs and blocks the MPCE machine (if correctly connected to the OSSD).

Some parts or sections of this manual containing important information for the operator are preceded by a note:



Notes and detailed descriptions about particular characteristics of the safety devices in order to better explain their functioning.  
Special instructions regarding the installation process.



The information provided in the paragraphs following this symbol is very important for safety and may prevent accidents.  
Always read this information accurately and carefully follow the advice to the letter.

This manual contains all the information necessary for the selection and operation of the safety devices.

However, specialised knowledge not included in this technical description is required for the planning and implementation of a safety light curtain on a power-driven machine. As the required knowledge may not be completely included in this manual, we suggest the customer to contact Pilz Technical Service for any necessary information relative to the functioning of the PSEN op2H-s light curtains and the safety rules that regulate the correct installation (see section 8 “*Periodical checks*”).

### ***1.1.1. Package contents***

Package contains the following objects:

- Receiver (RX)
- Emitter (TX)
- Quick Guide for first installation
- CD with user manual and other documents
- Checklist and periodical maintenance schedule
- 4 angled fixing brackets and specific fasteners
- 2 angled fixing brackets for models with heights included between 1200 and 1800 mm

### **1.2. New features compared to the PSEN op2H Series**

The PSEN op2H-s safety light curtains, compared to the PSEN op2H-s series, present the following new features:

- Increased operating distance
- Range enlargement with 150 to 1800 mm controlled heights
- Reduced response times
- New fastening system with rotating brackets
- New mechanical profile compatible with PSEN op2H-s accessories
- Different positioning of synchronisation optics (the first one from the reference line)
- Different mechanical mounting

### 1.3. How to choose the device

There are at least three different main characteristics that should be considered when choosing a safety light curtain, after having evaluated the risk assessment:

#### 1.3.1. Resolution

The resolution of the device is the minimum dimension that an opaque object must have in order to obscure at least one of the beams that constitute the sensitive area.

The resolution strictly depends on the part of the body to be protected.

$R = 30 \text{ mm}$  hand protection



As shown in Fig.1, the resolution only depends on the geometrical characteristics of the lenses, diameter and distance between centres, and is independent from any environmental and operating conditions of the safety light curtain.

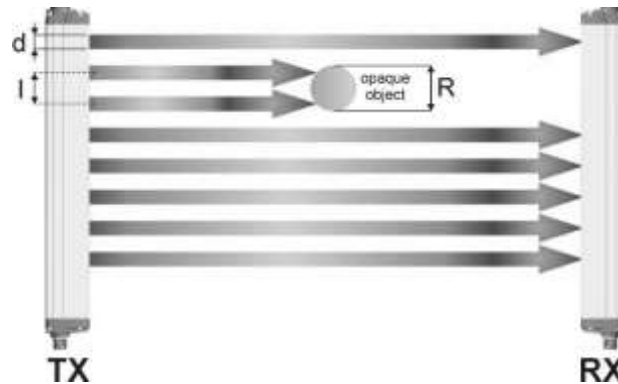

Fig. 1

The resolution value is obtained applying the following formula:

$$R = l + d$$

where:

$l$  = Distance between two adjacent optics

$d$  = Lens diameter



1.3.2. *Controlled height*

The controlled height is the height protected by the safety light curtain ( **Hp** )

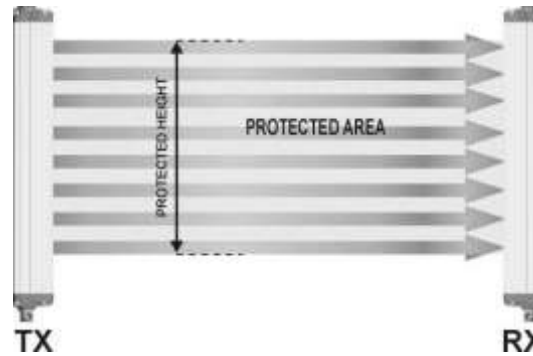

Fig. 2

The PSEN op2H-s controlled height is delimited by the yellow line pad-printed on the front glass and by the dimensions listed in the table:

Model	Controlled height Hp (mm)
PSEN op2H-s-30-015/1	150
PSEN op2H-s-30-030/1	300
PSEN op2H-s-30-045/1	450
PSEN op2H-s-30-060/1	600
PSEN op2H-s-30-075/1	750
PSEN op2H-s-30-090/1	900
PSEN op2H-s-30-105/1	1050
PSEN op2H-s-30-120/1	1200
PSEN op2H-s-30-135/1	1350
PSEN op2H-s-30-150/1	1500
PSEN op2H-s-30-165/1	1650
PSEN op2H-s-30-180/1	1800

### 1.3.3. Minimum installation distance

The safety device must be positioned at a specific safety distance (Fig. 3). This distance must ensure that the dangerous area cannot be reached before the dangerous motion of the machine has been stopped by the AOPD.

The safety distance depends on 4 factors, according to the EN-999 Standard:

- Response time of the AOPD (the time between the effective beam interruption and the opening of the OSSD contacts).
- Machine stopping time (the time between the effective opening of the contacts of the AOPD and the real stop of the dangerous motion of the machine).
- AOPD resolution.
- Approaching speed of the object to be detected.

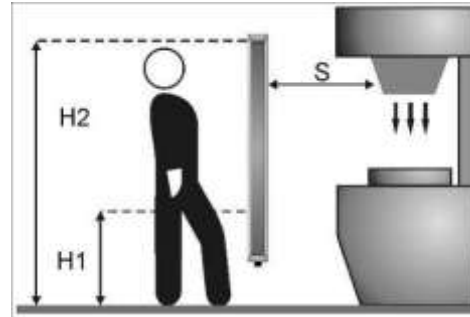

Fig. 3

The following formula is used for the calculation of the safety distance:

$$S = K (t_1 + t_2) + C$$

where:

S = Minimum safety distance in mm.

K = Speed of the object, limb or body approaching the dangerous area in mm/sec.

t<sub>1</sub> = Response time of the AOPD in seconds (see section 9 "Technical data")

t<sub>2</sub> = Machine stopping time in seconds.

d = Resolution of the system.

C = Additional distance based on the possibility to insert the body or one of body parts inside the dangerous area before the protective device trips.

C = 8 (d - 14) for devices with resolution ≤ 40mm

C = 850 mm for devices with resolution > 40mm.

**NOTE: K value is:****2000 mm/s if the calculated value of S is  $\leq$  500 mm****1600 mm/s if the calculated value of S is  $>$  500 mm**

When devices with  $>40$  mm resolution are used, the height of the top beam has to be  $\geq 900$  mm (H2) from machine supporting base while the height of the bottom beam has to be  $\leq 300$  mm (H1).

If the safety light curtain must be mounted in a horizontal position (Fig.4), the distance between the dangerous area and the most distant optical beam must be equal to the value calculated using the following formula:

$$S = 1600 \text{ mm/s } (t_1 + t_2) + 1200 - 0.4 H$$

where:

S = Minimum safety distance in mm.

$t_1$  = Response time of the AOPD in seconds  
(see section 9 "Technical data")

$t_2$  = Machine stopping time in seconds.

H = Beam height from ground; this height must always be less than 1,000 mm.

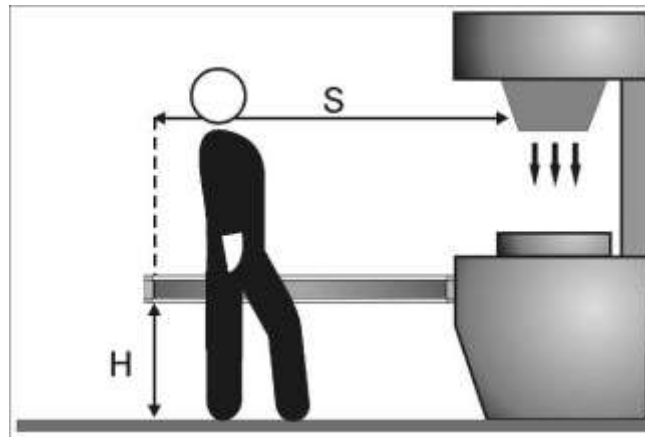

**Fig. 4**

**Practical examples:**

Let's suppose to have a light curtain with height = 600 mm

- 1) To calculate the distance of the device from the AOPD, in a vertical position, the following formula is used:

$$S = K * T + C$$

where:

T = t<sub>1</sub> + t<sub>2</sub>

t<sub>1</sub> = AOPD response time + PNOZsigma relay release time (max 80 ms)

t<sub>2</sub> = Machine total stopping time.

C = 8 \* (d - 14) for devices with resolution <= 40 mm

C = 850 for devices with resolution > 40 mm

d = Resolution of the system.

In all cases, if K = 2000mm/sec then S will be > 500 mm.

Distance will have then to be recalculated using K = 1600 mm/sec.

English

PSEN op2H-s-30-060/1	
<b>T</b>	0.398 sec
<b>C</b>	128 mm
<b>S</b>	764.8 mm

- 2) To calculate the distance of the device from the AOPD, in a horizontal position, the following formula is used:

$$S = 1600 * T + 1200 - 0.4 * H$$

where:

H = Beam min. height from ground 15 \* (d - 50)

D = resolution

PSEN op2H-s-30-060/1	
<b>t</b>	0.3 Sek.
<b>H</b>	0 mm
<b>S</b>	1828.8 mm



**WARNING:** the reference standard is EN 999 "Machine safety - the positioning of the protective device based on the approaching speed of the human body".

This information is just an indication and a kind of summary.

For safety distance correct calculation, it is compulsory to refer to the whole EN 999 standard.

#### 1.4. Typical applications

The safety light curtains of the PSEN op2H-s series are used in all automation fields where the control and protection of the access to dangerous areas are necessary.

In particular, they are used to stop the moving of mechanical parts in:

- Automatic machines;
- Machines for packaging, material handling, storing;
- Weaving machines, wood working machines, ceramic working machines;
- Automatic and semiautomatic assembly lines;
- Automatic warehouses.



**In food industry applications, Pilz Technical Service has to verify the compatibility of the material of the safety light curtain housing with any chemical agents used in the production process.**

##### ***Example 1: Cooling and conditioning systems***

Cooling and conditioning systems, as well as automotive equipment and components are checked inside a machine, to detect possible leaks by a helium mass spectrometer. The point where these parts are positioned inside the measuring chamber requires a Type 2 protection ensuring a certain space saving and an easy access to the protected area.



*Solution:* the PSEN op2H-s safety light curtain series represents the ideal solution if the safety requirements and the application are considered. When even just one of the light curtain beams is interrupted, the test machine is immediately stopped.

*Advantages:* the PSEN op2H-s light curtain meets the customer's needs when easy access is necessary in presence of machine stops. Easy installation, configuration and use are other advantages.

**Example 2: Automatic warehouses**

Operator protection in automatic warehouses.

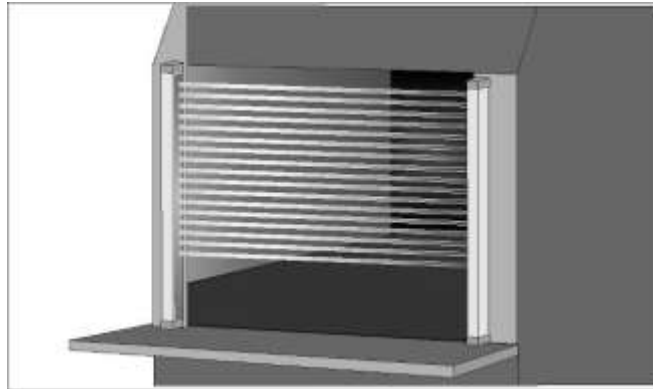

English

**Solution:** the PSEN op2H-s safety light curtain series represents the ideal solution if the safety requirements and the application are considered. When even just one of the light curtain beams is interrupted, the carousel is immediately stopped.

**Advantages:** the PSEN op2H-s light curtain meets the customer's needs when easy access is necessary in presence of machine stops. Easy installation, configuration and use are other advantages.

## 1.5. Safety information



For a correct and safe use of the safety light curtains of the PSEN op2H-s series, the following points must be observed:

- The stopping system of the machine must be electrically controlled.
- This control system must be able to stop the dangerous movement of the machine within the total machine stopping time T as per par. 1.1.3, and during all working cycle phases.
- Mounting and connection of the safety light curtain must be carried out only by qualified personnel, according to the indications included in the special sections (refer to sections 2; 3; 4; 5) and in the applicable Standards.
- The safety light curtain must be securely installed in a particular position so that access to the dangerous zone is not possible without the interruption of the beams (see section 2 "*Installation mode*").
- The personnel operating in the dangerous area must be well trained and must have adequate knowledge of all the operating procedures of the safety light curtain.
- The TEST button must be located outside the protected area because the operator must check the protected area during all Test and Reset operations.  
Please carefully read the instructions for the correct functioning before powering the light curtain.

### Serial numbers on transmitters and receivers

- Transmitters and receivers should only be installed, operated and replaced in pairs.
- Transmitters and receivers have the same serial number.

### Repair information:

- Please always send transmitters and receivers with the same serial number for repair.  
(During the repair, both units will be programmed to the current software status.)

## 2. INSTALLATION MODE

### 2.1. Precautions to be observed for the choice and installation of the device



Make sure that the protection level assured by the PSEN op2H-s device (Type 2) is compatible with the real danger level of the machine to be controlled, according to EN 954-1 and EN 13849.

- The outputs (OSSD) of the AOPD must be used as machine stopping devices and not as command devices. The machine must have its own START command.
- The dimension of the smallest object to be detected must be larger than the resolution level of the device.
- The AOPD must be installed in a room complying with the technical characteristics indicated in section 10 "*Technical data*".
- Do not place the device near intense and/or flashing light sources and, in particular, close to receiving unit front surface.
- The presence of intense electromagnetic disturbances could affect device correct operation. This condition shall be carefully assessed by seeking the advice of Pilz Technical service.
- The operating distance of the device can be reduced in presence of smog, fog or airborne dust.
- A sudden change in environment temperature, with very low minimum peaks, can generate a small condensation layer on the lenses and so jeopardise functioning.

English



## 2.2. General information on device positioning

The safety light curtain should be carefully positioned, in order to reach a very high protection standard. Access to the dangerous area must only be possible by passing through the protecting safety light beams.



Fig.5a shows some examples of possible access to the machine from the top and the bottom sides. These situations may be very dangerous and so the installation of the safety light curtain at sufficient height in order to completely cover the access to the dangerous area (Fig.5b) becomes necessary.

**NO**

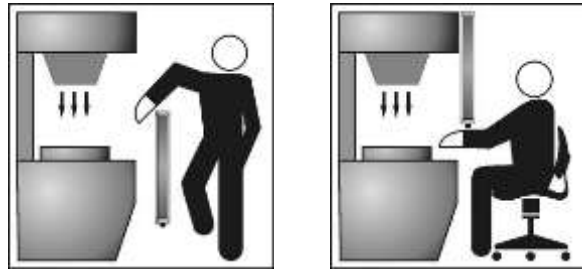

Fig.5a



**YES**



Fig.5b

Under standard operating conditions, machine starting must not be possible while operators are inside the dangerous area.

When the installation of the safety light curtain very near to the dangerous area is not possible, a second light curtain must be mounted in a horizontal position in order to prevent any lateral access (as shown in Fig.6b).



If the operator is able to enter the dangerous area, an additional mechanical protection must be mounted to prevent the access.

**NO**



Fig.6a



**YES**



Fig.6b

English

### 2.2.1. Minimum installation distance

Refer to par.1.3.3. "Minimum installation distance"

### 2.2.2. Minimum distance from reflecting surfaces

Reflecting surfaces placed near the light beams of the safety device (over, under or laterally) can cause passive reflections. These reflections can compromise the recognition of an object inside the controlled area.

However, if the **RX** receiver detects a secondary beam (reflected by the side-reflecting surface) the object might not be detected, even if the object interrupts the main beam.

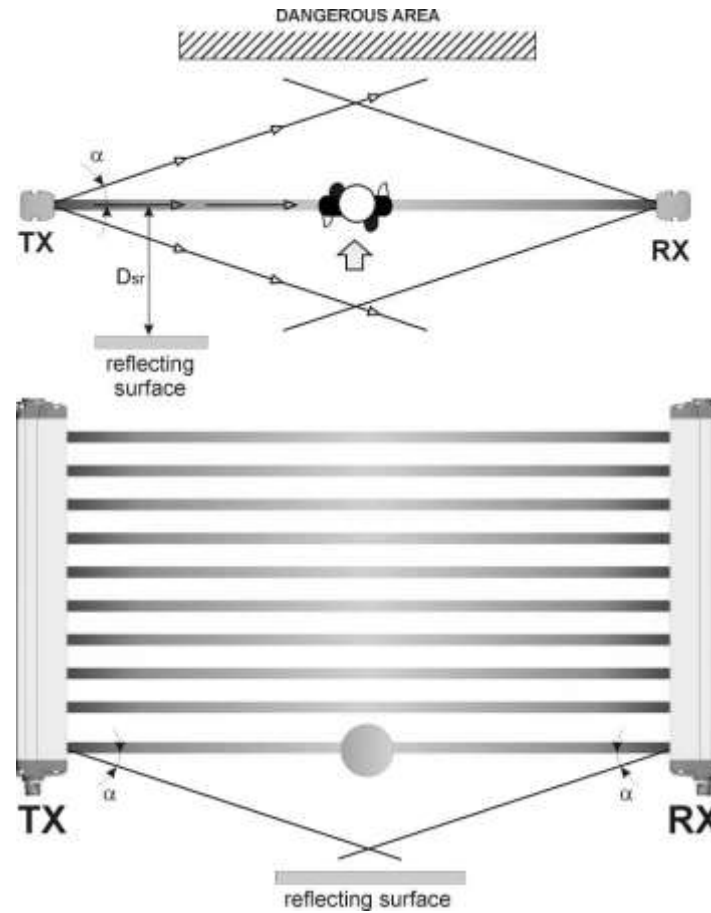

Fig. 7

It is thus important to position the safety light curtain according to the minimum distance from reflecting surfaces.

The minimum distance depends on:

- Operating distance between emitter (TX) and receiver (RX);
- Real opening angle of AOPD (EAA); in particular:

for AOPD type 2 EAA = 10° ( $\alpha = 5^\circ$ )

Diagram of Fig. 8 shows the min. distance from the reflecting surface ( $D_{sr}$ ), based on the operating distance:

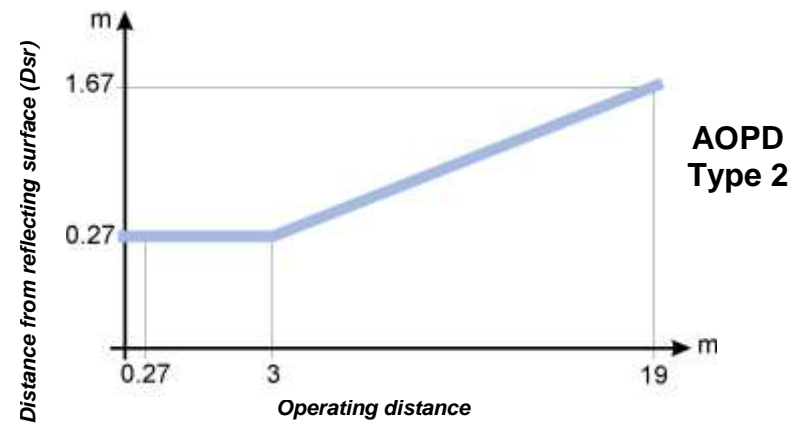

Fig. 8

The formula to get  $D_{sr}$  is the following:

$$D_{sr} (m) = 0.27$$

$$D_{sr} (m) = 0,5 \text{ operating distance (m)} \times \text{tg } 2\alpha$$

for oper. distances < 3 m

for oper. distances  $\geq$  3 m

English

### 2.2.3. *Emitter and receiver orientation*

The two units shall be installed parallel to each other, with the beams orthogonal respect to the emitting and receiving directions, with the connectors positioned in the same manner.

The configurations shown in Fig. 9 must be avoided:

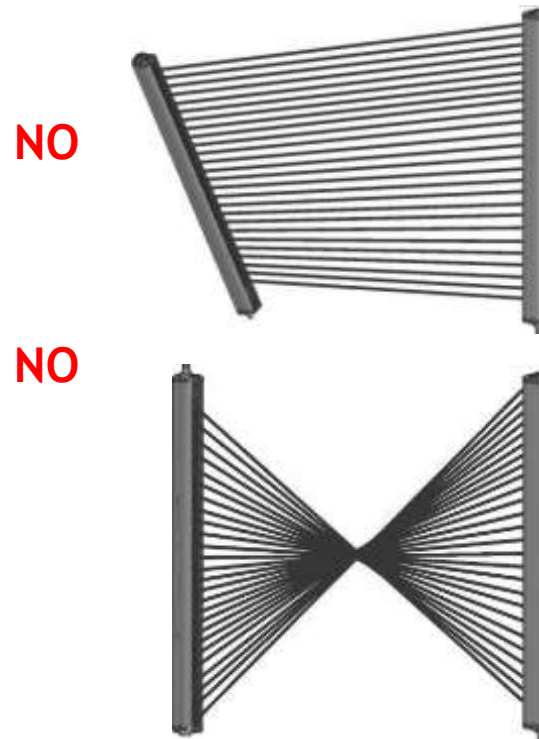

**Fig.9**

2.2.4. Installation of several adjacent safety light curtains

When several safety devices must be installed in adjacent areas, interferences between the emitter of one device and the receiver of the other must be avoided.

Fig.10 provides an example of possible interferences between different devices and two pertinent solutions.

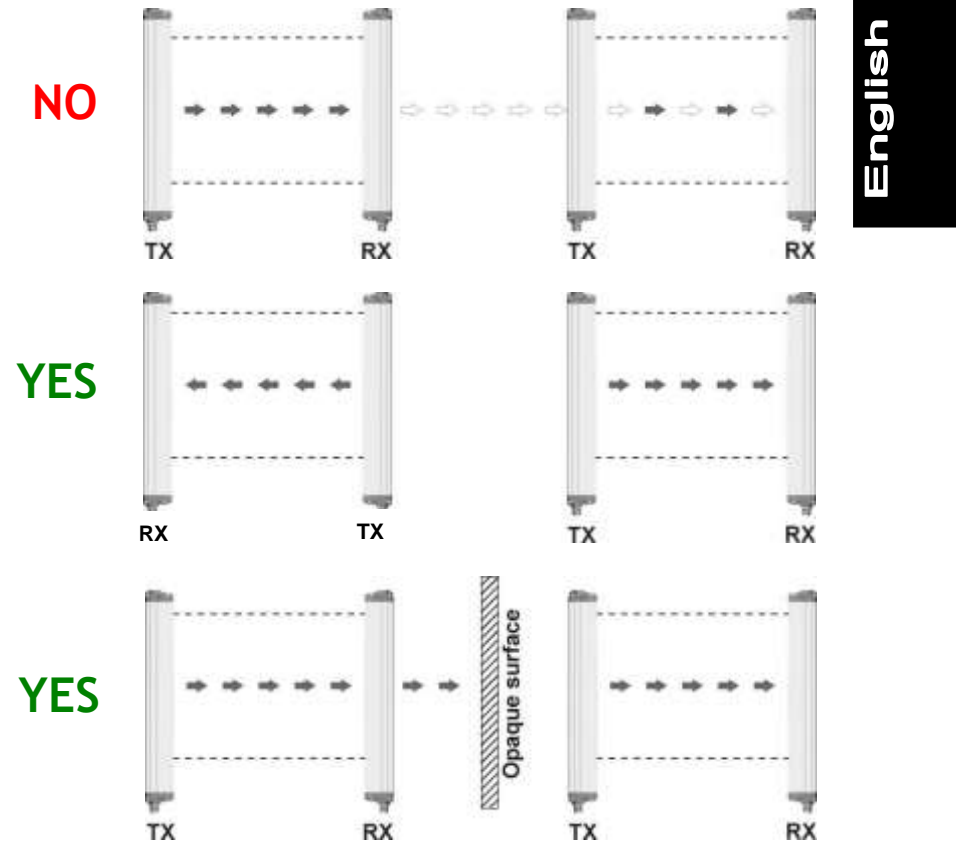

Fig.10

English

2.2.5. Use of deviating mirrors

The control of any dangerous area, with several but adjacent access sides, is possible using only one safety device and well-positioned deviating mirrors.

Fig.11 shows a possible solution to control three different access sides, using two mirrors placed at 45° with respect to the beams.

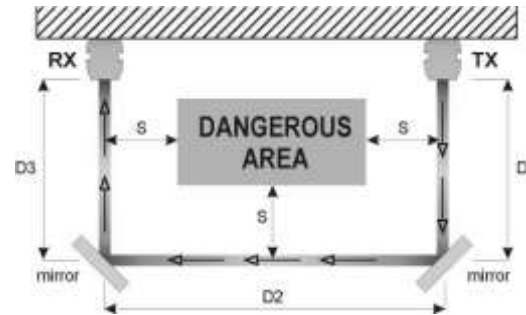

Fig. 11

The operator must respect the following precautions when using the deviating mirrors:

- The alignment of the emitter and the receiver can be a very critical operation when deviating mirrors are used. Even a very small mirror displacement is enough to lose alignment. The use of the Pilz laser pointer accessory is recommended under these conditions.
- The minimum safety distance (S) must be respected for each single section of the beams.
- The effective operating range decreases by about 15% by using only one deviating mirror, the percentage further decreases by using 2 or more mirrors (for more details refer to the technical specifications of the mirrors used).

The following table shows the operating distances relating to the number of mirrors used.

number of mirrors	operating distance
1	16.5 m
2	13.7 m
3	11.6 m

- Do not use more than three mirrors for each device.
- The presence of dust or dirt on the reflecting surface of the mirror causes a drastic reduction in the range.

### 2.2.6. Controls after first installation

The control operations to carry-out after the first installation and before machine start-up are listed hereinafter. The controls must be carried-out by qualified personnel, either directly or under the strict supervision of the person in charge of machinery Safety.

Verify that:

AOPD remains blocked (➤) intercepting the beams along the protected area using the specific test piece, following the Fig.12 scheme.

**TP30 for light curtains with 30 mm resolution: PSEN op2H-s-30**

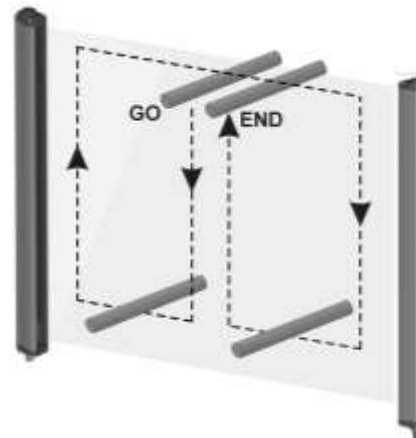

Fig. 12

- AOPD has to be correctly aligned, press slightly on the product side in both directions the red LED must not turn on ➤.
- The activation of the TEST function causes the opening of the OSSD outputs (red LED ➤ on and controlled machine stop).
- The response time at machine STOP, including the AOPD and machine response times, must be included in the limits defined in the calculation of the safety distance (refer to section 2 “Installation modes”).
- The safety distance between the dangerous parts and AOPD must comply with the requirements indicated in section 2 “Installation modes”.



- A person must not access or remain between AOPD and the dangerous parts of the machine.
- Access to the dangerous areas of the machine must not be possible from any unprotected area.
- AOPD must not be disturbed by external light sources, ensuring that it remains in Normal operating function for at least 10-15 minutes and placing the specific test piece in the protected area in the SAFE condition for the same period.
- Verify the correspondence of all the accessory functions, activating them in the different operating conditions.

### 3. MECHANICAL MOUNTING

The emitting (TX) and receiving (RX) units must be installed with the relevant sensitive surfaces facing each other. The connectors must be positioned on the same side and the distance must be included within the operating range of the model used (see section 10 “Technical data”).

The two units must be positioned the most aligned and parallel possible.

The next step is the fine alignment, as shown in section 5 “Alignment Procedure”.

Two types of brackets can be used to fix the two units:

#### **Rotating brackets**

Rotating fixing brackets are supplied with all models (Fig.13).

They can be used separately from or together with the angled fixing brackets.

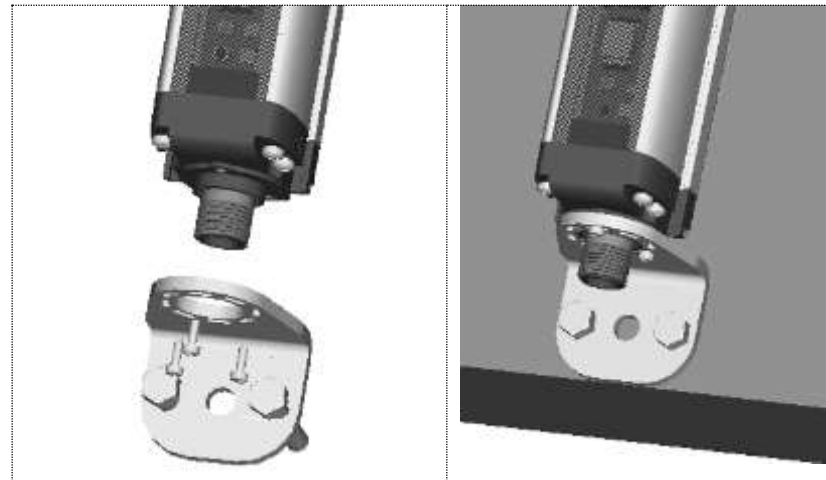
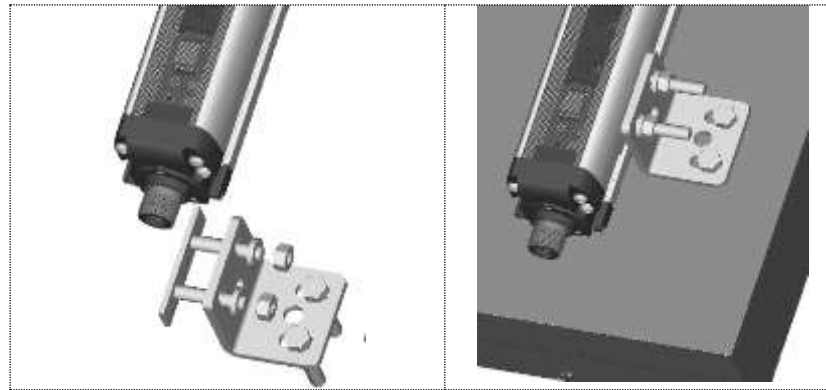

Fig. 13

**Angled fixing brackets**

Angled fixing brackets (Fig.14), are supplied with all models.



**Fig. 14**

In case of applications with particularly strong vibrations, vibration dampers, together with mounting brackets, are recommended to reduce the impact of the vibrations.

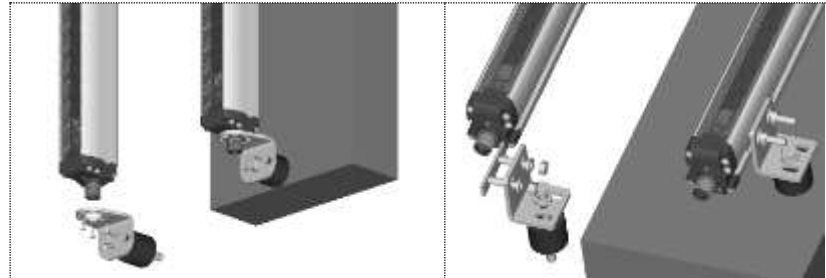

**Fig. 15**

The recommended mounting positions according to the light curtain length are shown in Fig.15 and in the following table.

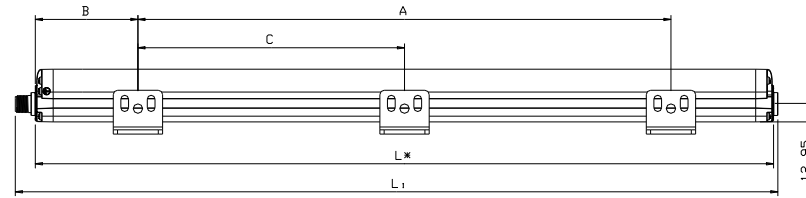

MODELS	L (mm)	A (mm)	B (mm)	C (mm)
PSEN op2H-s-30-015/1	216.3	108	54	-
PSEN op2H-s-30-030/1	366.2	216	75	-
PSEN op2H-s-30-045/1	516.3	316	100	-
PSEN op2H-s-30-060/1	666.2	366	150	-
PSEN op2H-s-30-075/1	816.3	466	175	-
PSEN op2H-s-30-090/1	966.2	566	200	-
PSEN op2H-s-30-105/1	1116.2	666	225	-
PSEN op2H-s-30-120/1	1266.3	966	150	483
PSEN op2H-s-30-135/1	1416.2	1066	175	533
PSEN op2H-s-30-150/1	1566.3	1166	200	583
PSEN op2H-s-30-165/1	1716.3	1266	225	633
PSEN op2H-s-30-180/1	1866.3	1366	250	683

kk = Resolution (30mm – 50 mm – 90 mm)

English

#### 4. ELECTRICAL CONNECTIONS

All electrical connections to the emitting and receiving units are made through a male M12 connector, located on the lower part of the two units. For receiver a M12 5-pole connector is used, while for emitter a M12 4-pole connector is used.

**RECEIVER (RX) \*):**

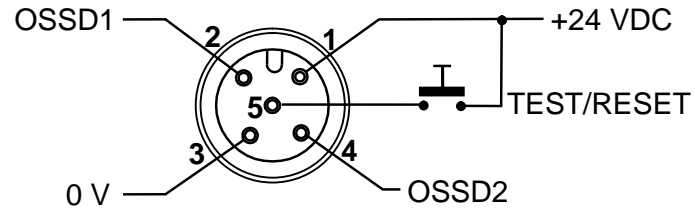

- 1 = brown = +24 VDC
- 2 = white = OSSD 1
- 3 = blue = 0 V
- 4 = black = OSSD 2
- 5 = grey = TEST/RESET

**EMITTER (TX) \*):**

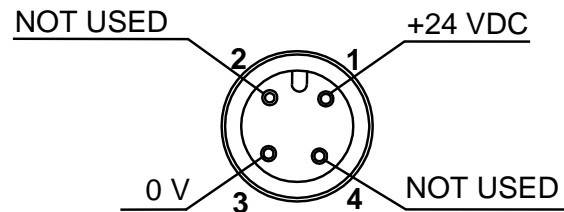

- 1 = brown = +24 VDC
- 2 = white = NOT USED
- 3 = blue = 0 V
- 4 = black = NOT USED

\*) [plugs an pinning compatible to PSEN op4F/H series](#)

#### 4.1. Notes on connections

For the correct functioning of the PSEN op2H-s safety light curtains, the following precautions regarding the electrical connections have to be respected:

- Do not place connection cables in contact with or near high-voltage cables and/or cable undergoing high current variations (e.g. motor power supplies, inverters, etc.);



- Do not connect in the same multi-pole cable the OSSD wires of different light curtains;

- The TEST/RESET wire must be connected through a N.O. button to the supply voltage of the AOPD.



The TEST/RESET button must be located in such a way that the operator can check the protected area during any Test and Reset operation. (see section 6 “*Functioning mode*”).

- The device is protected internally against overvoltage and overcurrent. The use of other external components is not recommended.

You may use for example a safety relay of the PNOZsigma (PNOZ s4, PNOZ s5) range as an evaluation device. The wiring is described in the operating manual of the PNOZsigma unit.

- Do not use varistors, RC circuits or LEDs in parallel at relay inputs or in series at OSSD outputs.
- The OSSD1 and OSSD2 safety contacts cannot be connected in series or in parallel, but can be used separately (Fig.16). If one of these configurations is erroneously used, the device enters into the output failure condition (see section 7 “Diagnostic functions”).

- Connect both OSSDs to the activating device. Failure to connect an OSSD to the activating device jeopardises the system safety degree that the light curtain has to control

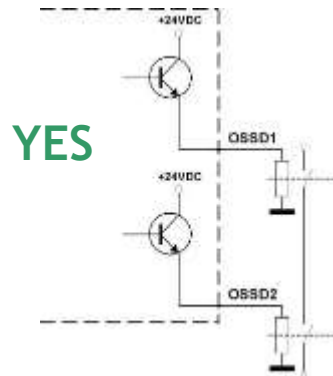

YES

Fig. 16

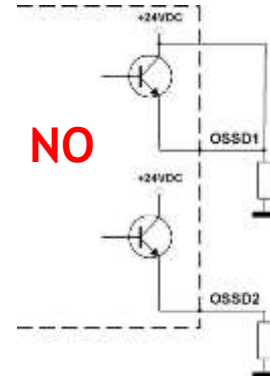

NO

Fig. 17

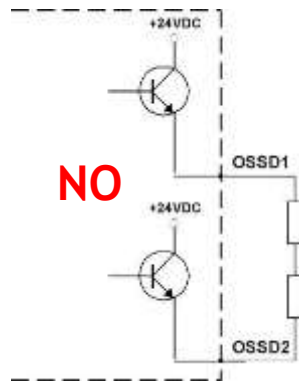

NO

Fig. 18

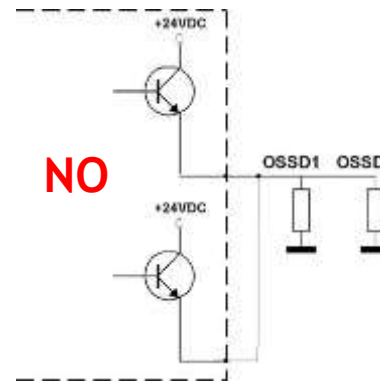

NO

Fig. 19

English



#### 4.2. Earth connection

PSEN op2H-s safety light curtain units are preset for easy ground connection. A special compartment, positioned onto caps and marked with the special symbol shown in Figure 20, allows connection with ground cable by means of an additional screw coming with the equipment.

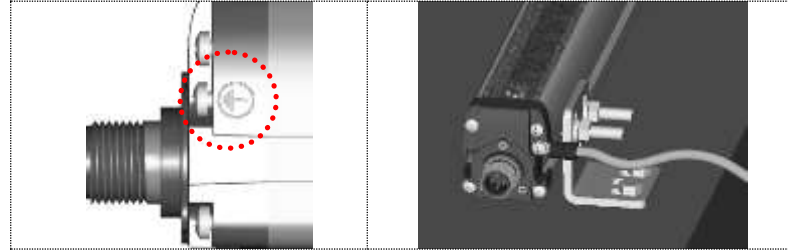

**Fig. 20**

Ground connection configuration is the most common and guarantees the best immunity against electromagnetic disturbances. PSEN op2H-s can function even without ground connection.

This condition has to be carefully evaluated according to the EMC disturbance immunity and necessary insulation class considering the plant or entire system where the light curtain is installed.

### 5. ALIGNMENT PROCEDURE

The alignment between the emitting and the receiving units is necessary to obtain the correct functioning of the light curtain. A good alignment prevents outputs instability caused by dust or vibrations.

The alignment is perfect if the optical axes of the first and the last emitting unit's beams coincide with the optical axes of the corresponding elements of the receiving unit.

The beam used to synchronise the two units is the first after the connector. SYNC is the optics connected with this beam and LAST is the optics connected to the last beam after the SYNC unit.

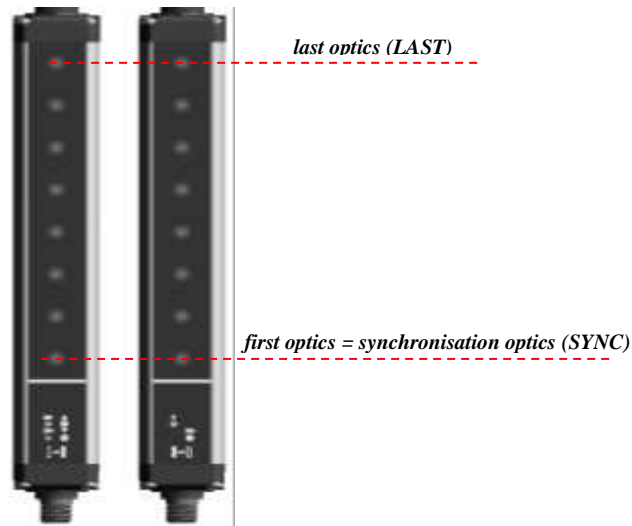

English

Fig.21

Signals are clearly identified through symbols allowing immediate reading, independent of bars directions. A short description of the signalling LEDs is necessary to avoid misunderstandings.

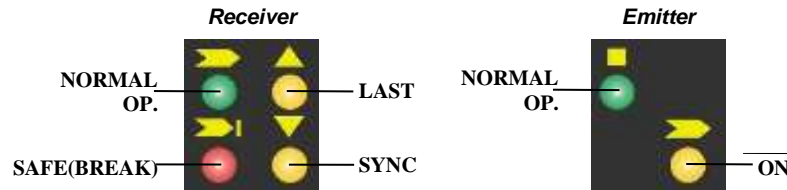

Fig. 22

The standard installation described hereinafter is the one shown in Fig. 22, *i.e.* with the bar assembled with the connectors pointing down.

Two yellow LEDs (▲ LAST, ▼ SYNC) on PSEN op2H-s receiver, facilitates the alignment procedure. During standard operation, the LEDs indicate the safety light curtain status, as shown in the table.

### FUNCTIONING STATUS

LED colour	Symbol	Normal Status NORMAL OP.	Stop Status SAFE(BREAK)		
Yellow	▲	OFF	ON	OFF	OFF
Yellow	▼	OFF	ON	ON	OFF
Red	➡	OFF	ON	ON	ON
Green	➡	ON	OFF	OFF	OFF
		- Standard condition: - Not interrupted beams	- Units not aligned - Top side not aligned - Highest beam interrupted	- Bottom side not aligned - Lowest beam interrupted	Units aligned, but at least one of beams (the highest and lowest excluded) is interrupted

### 5.1. Correct alignment procedure

The light curtain alignment can be effected only after having completed the mechanical installation and the electrical connections. The following procedure has to be followed:

- Check the green LED (■) and the yellow LED (➤) on the TX unit. If ON, the emitter is running correctly;
- Verify that the sensitive area from the safety light curtain is free;
- Verify that one of the following conditions is present on the RX unit:

STANDARD CONDITION - NORMAL OP.

- Green LED (➤) ON and red LED (➤I) OFF. Both yellow LEDs (▲, ▼) are OFF. Units are aligned.

STOP CONDITION - SAFE (BREAK)

- Green LED (➤) OFF and red LED (➤I) ON.
- The status of both yellow LEDs (▲, ▼) does not matter. Units are not aligned.
- Continue with the following steps to pass from condition 2 to condition 1:
  - A Keep the receiver in a steady position and set the emitter until the yellow LED (▼ SYNC) is OFF. This condition shows the effective alignment of the first synchronisation beam.
  - B Rotate the emitter, pivoting on the lower optics axis, until the yellow LED (▲ LAST) is OFF. Under these conditions, the SAFE LED shall turn ON.

**NOTE: Ensure that the green LED (➤) is steady ON.**

- C Delimit the area in which the LED (➤) is steady through some micro adjustments - for the first and then for the second unit - then place both units in the centre of this area.
  - Fix the two units firmly using brackets.
  - (➤) Verify that the green LED on the RX unit is ON (➤I) and beams are not interrupted, then verify that the red LED turns ON if even one single beam is interrupted (condition where an object has been detected).
  - This verification shall be made with the special cylindrical "Test Piece" having a size suitable to the resolution of the device used.

**NOTE: Passing the Test Piece along the whole sensitive area and at any distance from the two units, the red LED (➤I) shall be always ON and never change status.**

A daily test is recommended.

## 6. FUNCTIONING MODE

### 6.1. Reset mode

The interruption of a beam due to an opaque object causes the opening of OSSD outputs and the stop of the safety light curtain SAFE (BREAK) condition ➤I.

The AOPD will automatically restart its standard operation (NORMAL OP. condition ➤) as soon as the object is removed.



**WARNING:** Carefully assess risk conditions and reset modes.

In applications protecting access to dangerous areas, the automatic reset mode is potentially unsafe if it allows the operator to pass completely beyond the sensitive area (see Fig. 6b). In this case, the reset, using for example the manual reset of the Pilz safety relay, might be necessary.

### 6.2. Test function

The TEST function can be activated by keeping a normally open external contact (TEST push-button), closed for at least 0.5 seconds.

The TEST signal is active high.

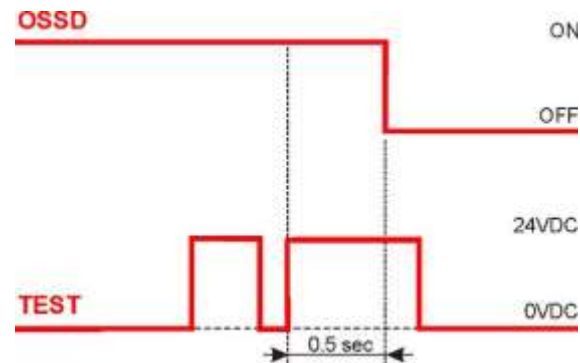

### 6.3. Reset function

The RX light curtain has a RESET function which is activated after an internal error. The reset can be made only in case of optical error or OSSD error (See sect. 7 “*Diagnostic Functions*”)

The RESET function can be activated by keeping a normally open external contact (RESET/RESTART push-button), closed for at least 5 seconds.

The RESET signal is active high.

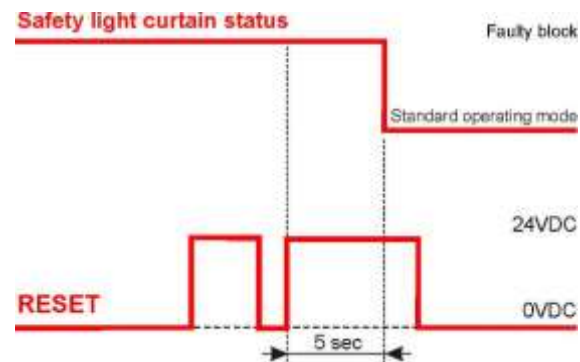

English

## 7. DIAGNOSTIC FUNCTIONS

### 7.1. User interface

The operator can visualise the operating condition of the light curtains through the four LEDs positioned on the receiver unit and two LEDs on the emitter unit.

Fig.23 shows all signalling LEDs modes: OFF, ON and BLINKING.

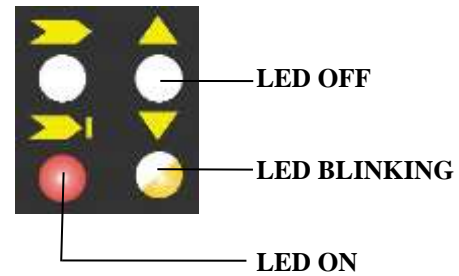









Fig. 23

### 7.2. Diagnostic messages

The operator is able to check the main causes of the system stop and failure, using the same LEDs used for visualising the functions.





For Receiver:

Function	Status	Meaning	LED
Normal operation	TEST (red ON)	Light curtain being tested, the OSSD status shall be OFF	
	Emission (OSSD ON) (green ON)	Light curtain working and in standard operating conditions	
	Interruption (OSSD OFF) (red ON)	Light curtain working and in safety block conditions.	
Function	Type	Check and repair	LED
Error status	OSSD error (yellow and red BLINKING)	Check OSSD connections; make sure that they are not in contact with one another or with the supply cables, then Reset. If the failure continues contact Pilz	
	Internal error (red ON, yellow BLINKING)	Switch OFF and switch ON the supply circuit; if the failure continues contact Pilz	
	Optical error (red ON, yellow BLINKING)	Reset. If the failure continues contact Pilz	
	No power supply (LEDs OFF)	Check connections and input voltage correct value. If the failure continues contact Pilz	

English



For Emitter:

Function	Status	Meaning	LED
Normal operation	Test (green ON)	Light curtain being tested, the OSSD status must be OFF	
	Emission (green ON yellow ON)	Light curtain working in normal operating conditions	
Function	Type	Check and repair	LED
Error status	Internal error (green ON yellow BLINKING)	Switch OFF and switch ON the power supply circuit. If the failure continues contact Pilz	
	Optic error (green ON yellow BLINKING)	Switch OFF and switch ON the power supply circuit. If the failure continues contact Pilz	
	No power supply (LEDs OFF)	Check connections and input voltage value. If the failure continues contact Pilz	

## 8. PERIODICAL CHECKS

The following is a list of recommended check and maintenance operations that should be periodically carried out by qualified personnel.

Check that:

- The AOPD stays locked (➤) during beam interruption along the entire protected area, using the suitable "Test Piece". (\*)
- The AOPD is correctly aligned: by slightly pressing product side, in both directions, the red LED shall not come ON ➤.
- Enabling the TEST function, the OSSD outputs should open (the red LED ➤ is ON and the controlled machine stops).
- The response time upon machine STOP (including response time of the AOPD and of the machine) is within the limits defined for the calculation of the safety distance (see section 2 "*Installation mode*").
- The safety distance between the dangerous areas and the AOPD are in accordance with the instructions included in section 2 "*Installation mode*".
- Access of a person between AOPD and machine dangerous parts is not possible nor is it possible for him/her to stay there.
- Access to the dangerous area of the machine from any unprotected area is not possible.
- The AOPD and the external electrical connections are not damaged.

The frequency of checks depends on the particular application and on the operating conditions of the safety light curtain.

(\*) according to the Fig.12 scheme

Verify that:

AOPD remains blocked (➤) intercepting the beams along the protected area using the specific test piece, following the Fig.12 scheme.

***TP30 for light curtains with 30 mm resolution: PSEN op2H-s-30***

### 8.1. General information and useful data



Safety MUST be a part of our conscience.

The safety devices fulfil their safety function only if they are correctly installed, in accordance with the Standards in force.

If you are not certain to have the expertise necessary to install the device in the correct way, Pilz Customer Service is at your disposal to carry out the installation.

The device uses fuses that are not self-resetting. Consequently, in presence of short-circuits causing the cut-off of these fuses, both units shall be sent to Pilz service department.

A power failure caused by interferences may cause the temporary opening of the outputs, but the safe functioning of the light curtain will not be compromised.

## 9. DEVICE MAINTENANCE

PSEN op2H-s safety light curtains do not require special maintenance operations.

To avoid the reduction of the operative distance, optics protective front surfaces shall be cleaned at regular intervals.

To this end, use soft cotton cloths damped in water; do not apply too much pressure onto the surface so as not to make it dull.

Please do not use on plastic surfaces or light curtain painted surfaces:

- alcohol or solvents
- wool or synthetic cloths
- paper or other abrasive materials

### 9.1. Product disposal

Under current Italian and European laws, Pilz is not obliged to take care of product disposal at the end of its life.

Pilz recommends to dispose of the product in compliance with local laws or contact authorised waste collection centres.

## 10. TECHNICAL DATA

The product technical specifications are given below.

ELECTRICAL DATA	
Power supply (Vdd):	24 Vdc $\pm$ 20%
Unit current draw (TX):	2 W max
Unit current draw (RX):	3.5 W max (without load)
Outputs:	2 PNP
Short-circuit protection:	1.4 A max
Output current:	0.5 A max / each output
Output voltage – status ON:	Vdd –1 V min
Output voltage – status OFF:	0.2 V max
Capacitive load	2.2 $\mu$ F @ 24Vdc max
Response times:	See table below
Protected height:	150..1800mm
Safety category:	Type 2
Auxiliary functions:	Reset / Test
Electrical protection:	Class I / Class III (see sect.4.2)
Connections:	M12-4 poles for emitter M12-5 poles for receiver
Cables length (for power supply):	50 m. max
OPTICAL DATA	
Emitting light ( $\lambda$ ) :	Infrared, LED (950 nm)
Resolution:	30 mm
Operating distance:	0.2...19 m
Ambient light rejection:	IEC-61496-2
MECHANICAL AND ENVIRONMENTAL DATA	
Operating temperature:	-10...+ 55 °C
Storage temperature:	-25...+ 70 °C
Humidity:	15...95 % (no condensation)
Mechanical protection:	IP 65 (EN 60529)
Vibrations:	Width 0.35 mm, Frequency 10 ... 55 Hz 20 sweep per axis, 1octave/min (EN 60068-2-6)
Shock resistance:	16 ms (10 G) 1,000 shocks per axis (EN 60068-2-29)
Housing material:	Painted aluminium (yellow RAL 1003)
Front side material:	PMMA
Caps material:	PC MAKROLON
Weight (single unit):	1.3 kg / linear metre

**11. LIST OF AVAILABLE MODELS**

MODEL	Protected Height (mm)	No. Beams	Response time (msec)	Resolution (mm)
PSEN op2H-s-30-015/1	150	8	8	30
PSEN op2H-s-30-030/1	300	16	9	30
PSEN op2H-s-30-045/1	450	24	11	30
PSEN op2H-s-30-060/1	600	32	12	30
PSEN op2H-s-30-075/1	750	40	14	30
PSEN op2H-s-30-090/1	900	48	15	30
PSEN op2H-s-30-105/1	1050	56	17	30
PSEN op2H-s-30-120/1	1200	64	18	30
PSEN op2H-s-30-135/1	1350	72	20	30
PSEN op2H-s-30-150/1	1500	80	21	30
PSEN op2H-s-30-165/1	1650	88	23	30
PSEN op2H-s-30-180/1	1800	96	24	30

**English**

## 12. OVERALL DIMENSIONS

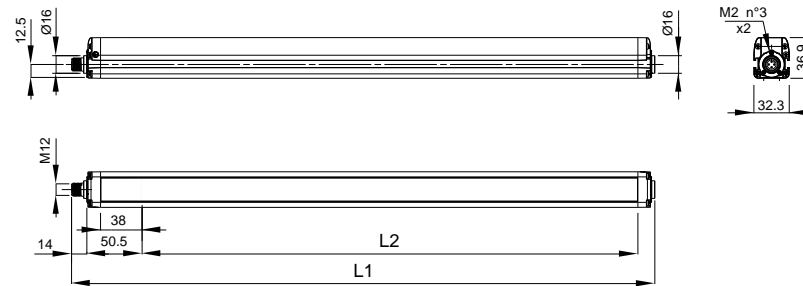

MODEL	L <sub>1</sub>	L <sub>2</sub>
PSEN op2H-s-30-015/1	233.3	153.3
PSEN op2H-s-30-030/1	383.2	303.2
PSEN op2H-s-30-045/1	533.2	453.3
PSEN op2H-s-30-060/1	683.2	603.2
PSEN op2H-s-30-075/1	833.2	753.3
PSEN op2H-s-30-090/1	983.2	903.2
PSEN op2H-s-30-105/1	1133.2	1053.2
PSEN op2H-s-30-120/1	1283.3	1203.3
PSEN op2H-s-30-135/1	1433.2	1353.2
PSEN op2H-s-30-150/1	1583.3	1503.3
PSEN op2H-s-30-165/1	1733.3	1653.3
PSEN op2H-s-30-180/1	1883.3	1803.3

kk = Resolution (30mm – 50 mm – 90 mm)

### 13. OUTFIT

#### Rotating fixing bracket

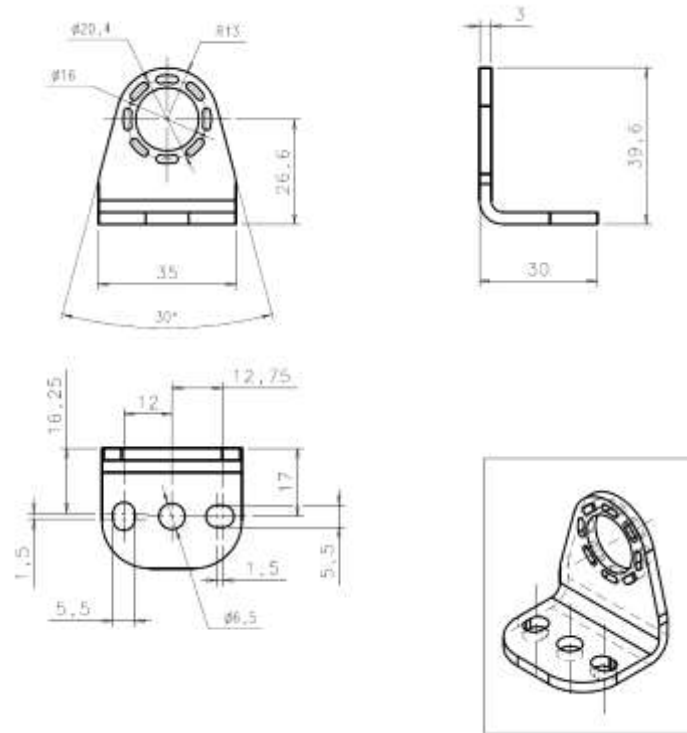

English

MODEL	DESCRIPTION
PSEN op bracket turnable (kit) (630772)	Rotating fixing bracket (kit 4pz.)



## 14. ACCESSORIES

### Angled fixing bracket

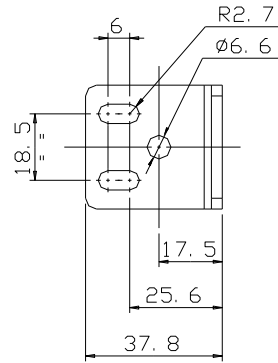
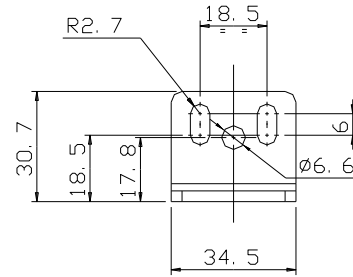
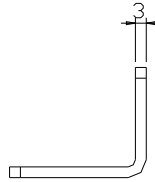

14.1 Angled fixing bracket mounting

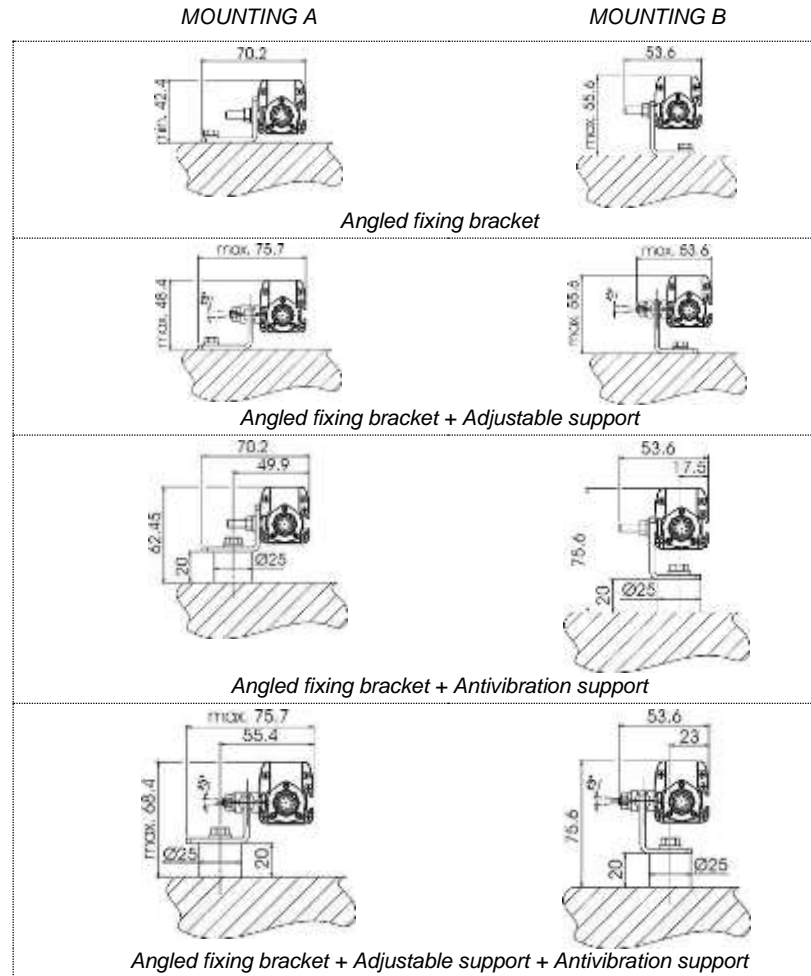

English

MODEL	DESCRIPTION
PSEN op bracket kit (630325)	Fixing brackets for angle mounting (4 pcs kit)
PSEN op bracket kit anti vibration (630327)	Antivibration support (4 pcs kit)
PSEN op bracket kit adjustable (630326)	Adjustable support (4 pcs Kit)

Deviating mirrors

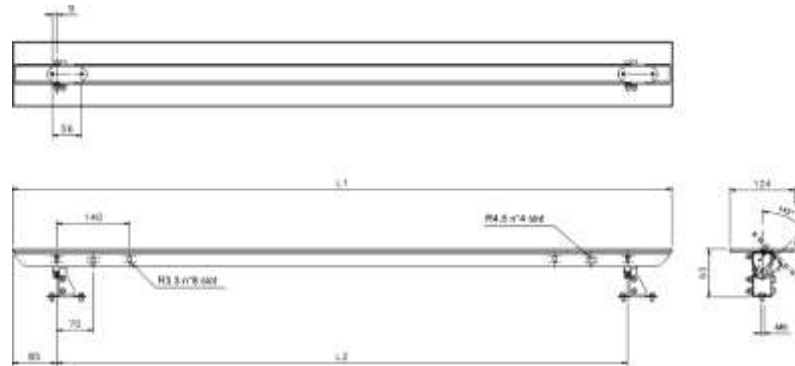

MODEL	DESCRIPTION	L <sub>1</sub> (mm)	L <sub>2</sub> (mm)
mirror 550 (630335)	Deviating mirror H= 550 mm	554	384
mirror 700 (630336)	Deviating mirror H= 700 mm	704	534
mirror 900 (630337)	Deviating mirror H= 900 mm	904	734
mirror 1000 (630338)	Deviating mirror H= 700 mm	1004	834
mirror 1270 (630339)	Deviating mirror H= 1270 mm	1264	1094

Columns and floor stands

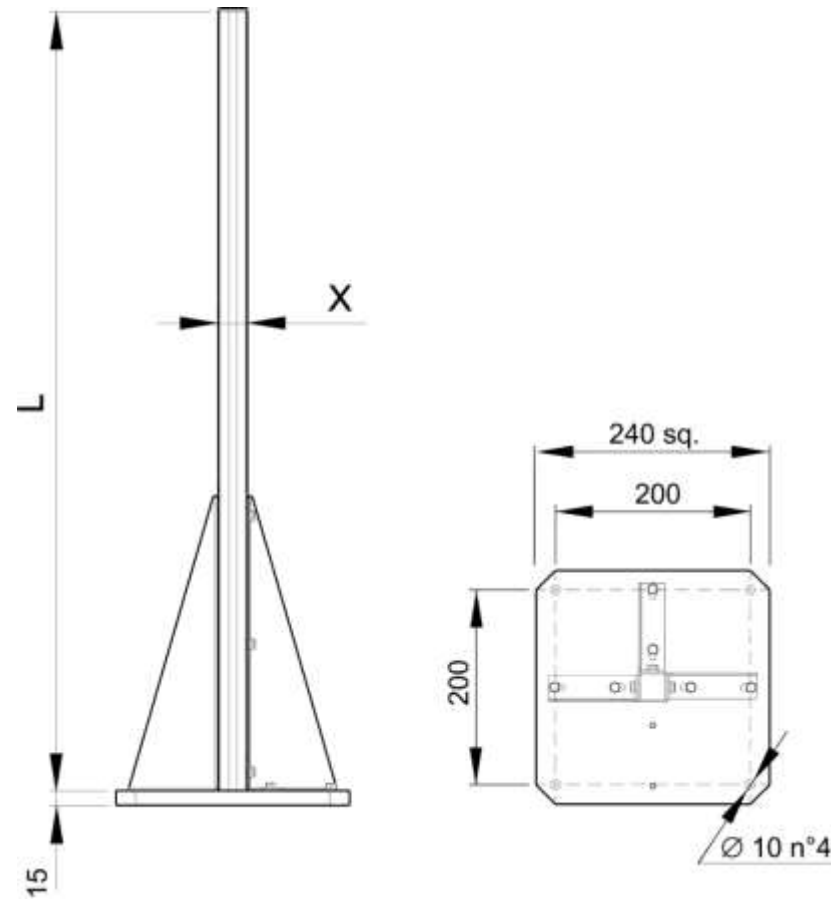

English

MODEL	DESCRIPTION	L (mm)	X (mm)
Stand 1000 (630331)	Column and floor stand H= 1000 mm	1000	30x30
Stand 1200 (630332)	Column and floor stand H= 1200 mm	1200	30x30
Stand 1500 (630332)	Column and floor stand H= 1500 mm	1500	45x45
Stand 1800 (630333)	Column and floor stand H= 1800 mm	1800	45x45

**Test piece**

MODEL	DESCRIPTION
Testpiece F 14mm (630345)	Test piece Ø 14 mm
Testpiece H 30mm (630346)	Test piece Ø 30 mm

**Connection cables**

MODELL	Description	Cable length
PSEN op cable M12 4-p.	Cabel unshielded, M12, 4 pole	3 m (630300) 5 m 630301 10 m (630302) 30 m (630296)
PSEN op cable angle M12 4-p.	Cabel unshielded, M12, 4 pole, angle	3 m (630341) 5 m 630342 10 m (630343) 30 m (630344)
PSEN op cable M12 5-p..	Cabel unshielded, M12, 5 pole	3 m (630310) 5 m 630311 10 m (630312) 30 m (630297)
PSEN op cable angle M12 5-p.	Cabel unshielded, M12, 5 pole, angle	3 m (630347) 5 m 630348 10 m (630349) 30 m (630350)

**DESCRIPTION**

## 15. GLOSSARY

**ACTIVE OPTOELECTRONIC PROTECTIVE DEVICE (AOPD):** its detection function is achieved thanks to the use of optoelectronic receivers and emitters detecting the optical beams interruptions inside the device caused by an opaque object present inside the specified detecting area.

An active optoelectronic protective device (AOPD) can operate both in emitter-receiver mode and in retro-reflective light curtains.

**BLOCK CONDITION (=BREAK):** status of the light curtain taking place when a suitably-sized opaque object (see DETECTING CAPACITY) interrupts one or several light curtain beams.

Under these conditions, OSSD1 and OSS2 light curtain outputs are simultaneously switched OFF within the device response time.

**CONTROLLED MACHINE:** machine having the potentially-dangerous points protected by the light curtain or by another safety system.

**CROSSING HAZARD:** situation under which an operator crossing the area controlled by the safety device and this latter stops and keeps the machine stopped until the hazard is eliminated, and then enters the dangerous area. Now the safety device could not be able to prevent or avoid an unexpected restart of the machine with the operator still present inside the dangerous area.

**DANGEROUS AREA:** area representing an immediate or imminent physical hazard for the operator working inside it or who could get in contact with it.

**DETECTING CAPACITY (= RESOLUTION):** limit of the parameter of the sensor function specified by the supplier, that will enable the electro-sensitive protective equipment (AOPD). In case of an active optoelectronic protective device (AOPD), with resolution we mean the minimum dimension, which an opaque object must have in order to interrupt at least one of the beams that constitute the sensitive area.

**ELECTROSENSITIVE PROTECTIVE EQUIPMENT (AOPD):** assembly of devices and/or components working together to activate the protective disabling function or to detect the presence of something and including at least: a sensor, command/control devices and output signal switching devices.

**EMITTER:** unit emitting infrared beams, consisting of a set of optically-synchronised LEDs. The emitting unit, combined with the receiving unit (installed in the opposite position), generates an optical “curtain”, *i.e.* the detecting area.

**FINAL SWITCHING DEVICE (FSD):** part of the control system connected to machine safety and breaking the circuit towards machine primary command element (MPCE) when the output signal switching device (OSSD) reaches the inactive condition.

**MACHINE OPERATOR:** qualified person authorised for machine use.

**MACHINE PRIMARY COMMAND ELEMENT (MPCE):** electrically-powered element having the direct control of machine regular operation so as to be the last element, in order of time, to operate when the machine has to be enabled or blocked.

**MIN. INSTALLATION DISTANCE:** min. distance necessary to allow machine dangerous moving parts to completely stop before the operator can reach the nearest dangerous point. This distance shall be measured from the middle point of the detecting area to the nearest dangerous point. The factors affecting min. installation distance value are: machine stop time, safety system overall response time, barrier resolution.

**N.O.:** normally opened

**N.C.:** normally closed

**OFF STATUS:** status when the output circuit is interrupted and does not allow current stream.

**ON STATUS:** status when the output circuit is operational and allows current stream.

**OUTPUT SIGNAL SWITCHING DEVICE (OSSD):** part of the electrosensitive protective equipment (AOPD) connected to machine control system that, when the sensor is triggered during standard operating mode, is switched to the inactive status.

**PROTECTED AREA:** area where a specified test object is detected by the AOPD.

**PROTECTIVE DEVICE:** device having the function to protect the operator against possible risks of injury due to the contact with machine potentially-dangerous parts.

**QUALIFIED OPERATOR:** a person who holds a professional training certificate or having a wide knowledge and experience and who is acknowledged as qualified to install and/or use of the product and to carry out periodical test procedures.

**RECEIVER:** unit receiving infrared beams, consisting of a set of optically-synchronised phototransistors. The receiving unit, combined with the emitting unit (installed in the opposite position), generates an optical "curtain", *i.e.* the detecting area.

**RESPONSE TIME:** max. time elapsing between the occurrence of the event leading to sensor activation and the reaching of the inactive state by the output signal switching device (OSSD).

**RESTART INTERLOCK (= RESTART):** device preventing machine automatic restart after sensor activation during a dangerous phase of machine operating cycle, after a change of machine operating mode, and after a variation in machine start control devices.

**RISK:** probability of occurrence of an injury and severity of the injury itself.

**SAFETY LIGHT CURTAIN:** it is an active optoelectronic protective device (AOPD) including an integrated system consisting of one or several emitting elements and one or several receiving elements forming a detection area with a detecting capacity specified by the supplier.

**START INTERLOCK (= START):** device preventing machine automatic start when the AOPD is powered, or when the power supply is cut and then restored.

**TEST PIECE:** opaque object having a suitable size and used to test safety light curtain correct operation.

**TYPE (OF AOPD):** the Electrosensitive Protective Equipment (AOPD) have different reactions in case of faults or under different environmental conditions. The classification and definition of the "type" (ex. type 2, type 4, according to IEC 61496-1) defines the minimum requirements needed for AOPD design, manufacturing and testing.

**WORKING POINT:** machine position where the material or semifinished product is worked.