

► PSEN opII3B Series

PILZ
THE SPIRIT OF SAFETY

Operating Manual-1004845-EN-05
- PSEN sensor technology



This document is the original document.

Where unavoidable, for reasons of readability, the masculine form has been selected when formulating this document. We do assure you that all persons are regarded without discrimination and on an equal basis.

All rights to this documentation are reserved by Pilz GmbH & Co. KG. Copies may be made for the user's internal purposes. Suggestions and comments for improving this documentation will be gratefully received.

Pilz®, PIT®, PMI®, PNOZ®, Primo®, PSEN®, PSS®, PVIS®, SafetyBUS p®, SafetyEYE®, SafetyNET p®, the spirit of safety® are registered and protected trademarks of Pilz GmbH & Co. KG in some countries.



SD means Secure Digital

1	Introduction	6
1.1	Validity of documentation	6
1.2	Using the documentation	6
1.3	Definition of symbols	6
2	Overview	8
2.1	Unit view	10
2.2	Scope of supply	11
3	Safety	12
3.1	Intended use	12
3.2	Safety regulations	13
3.2.1	Safety assessment	13
3.2.2	Use of qualified personnel	13
3.2.3	Warranty and liability	14
3.2.4	Disposal	14
4	Function description	15
4.1	Basic function	15
4.2	Automatic start and restart	16
4.3	Operation of two safety light curtains with the same alignment	17
5	Project configuration	18
5.1	Maintaining the safety distance	18
5.2	Prevent reaching across a vertical protected field	19
5.3	Prevent creeping underneath and stepping over	20
5.4	Resolution	23
5.5	Protected field perimeters	23
5.6	Ambient conditions	23
5.7	Distance from reflective surfaces	24
5.8	Minimum distance between parallel, aligned safety light curtains	27
5.9	Installation of several adjacent safety light grids	29
5.10	Use of deviating mirrors	30
6	Installation and alignment	32
6.1	Attach the safety light curtain to the mounting surface	33
6.2	Orientation	36
6.2.1	General guidelines	36
6.2.2	Safety light curtain alignment	37
7	Wiring	39
7.1	General guidelines	39
7.2	Connector pin assignment	40
7.3	Support with wiring	41
8	Commissioning	43
8.1	System connection	43
8.2	Checking the safety light curtain	45

9	Operation	48
9.1	Display elements	48
9.2	Status information	49
9.3	Safety light grid restart	51
9.4	Malfunction	51
10	Regular checks and maintenance	52
10.1	Checks	52
10.1.1	Regular check	52
10.1.2	Checking of safety light curtains with beam coding	52
10.1.3	Check after plant/machine modification	54
10.2	Maintenance	54
11	Dimensions	55
12	Technical details Order no. 632100-632102	56
13	Technical details Order no. 632103-632105	59
14	Technical details Order no. 632110-632112	62
15	Technical details Order no. 632113-632115	65
16	Classification according to ZVEI, CB24I	68
17	Safety characteristic data	69
18	Order reference	70
18.1	Order reference for safety light curtains	70
18.2	Order reference for accessories	71
18.2.1	Mirror column set	73
18.2.2	Mirror columns	74
18.2.3	Protective column sets	74
18.2.4	Protective columns	74
18.2.5	Muting accessories	75
18.3	Order reference: Component parts	76
19	Appendix	79
19.1	Check list	79
19.2	Muting applications with safety controller	82
19.2.1	Introduction	82
19.2.2	Prerequisites	83
19.2.3	Wiring	84
19.2.4	Cross muting	84
19.2.5	L-muting	86
19.2.6	T-muting (sequential muting)	87
19.2.7	Override	89

20	EC declaration of conformity	90
21	UKCA-Declaration of Conformity	91

1 Introduction

1.1 Validity of documentation

This documentation is valid for the product PSEN opI13B Series from Version 4.0. It is valid until new documentation is published.

This operating manual explains the function and operation, describes the installation and provides guidelines on how to connect the product.

1.2 Using the documentation

This document is intended for instruction. Only install and commission the product if you have read and understood this document. The document should be retained for future reference.

1.3 Definition of symbols

Information that is particularly important is identified as follows:



DANGER!

This warning must be heeded! It warns of a hazardous situation that poses an immediate threat of serious injury and death and indicates preventive measures that can be taken.



WARNING!

This warning must be heeded! It warns of a hazardous situation that could lead to serious injury and death and indicates preventive measures that can be taken.



CAUTION!

This refers to a hazard that can lead to a less serious or minor injury plus material damage, and also provides information on preventive measures that can be taken.



NOTICE

This describes a situation in which the product or devices could be damaged and also provides information on preventive measures that can be taken. It also highlights areas within the text that are of particular importance.



INFORMATION

This gives advice on applications and provides information on special features.

2 Overview

Safety light curtains in the PSEN opI3B Series constitute electrosensitive protective equipment (ESPE type: 3) in accordance with IEC 61496-1 and IEC 61496-2 (AOPD) for workspaces in which machines, robots, and automated systems might pose a physical danger to their operators.

Unit features

- ▶ Operating range
 - 0.2 - 15 m with resolution 170 mm
 - 10 - 55 m with resolution 300 mm
- ▶ Infrared protected field is generated
- ▶ LED indicator for status information
- ▶ Optical synchronisation of transmitters and receivers
- ▶ Beam coding A and B for greater insensitivity (see [Installing several safety light curtains in parallel](#) [📖 29])
 - to stray light and short-term interruptions of the protected field
 - to mutual interference when using two safety light curtains with the same alignment
- ▶ Muting applications can be implemented using muting accessories (see [Order references for accessories](#) [📖 71]) and an appropriate safety controller.

The implementation of muting applications is described in [Muting applications with safety controller](#) [📖 82].
- ▶ Connection to evaluation devices
 - PDP67 ION and PDP67 ION HP: 5-pin M12 two-sided connector (see [Order reference for accessories, connection to PDP67](#) [📖 72])
 - all other suitable evaluation devices (see [System connection](#) [📖 43]): 5-pin M12 one-sided connector and open cable end connection to clamping sleeves (see [Order reference for accessories, connection to other evaluation devices](#) [📖 72])
- ▶ Aluminium alloy housing
- ▶ Die-cast zinc end caps
- ▶ Shock resistance
 - Bracket swivel mount: 10g
 - Bracket Adv Bracket Kit: 50g
- ▶ Front panel of PC

- ▶ Standard installation kit with flexible bracket (swivel mount) (included in delivery) to hold the transmitter/receiver
 - For standard application
 - Transmitter/receiver remains rotatable for proper orientation
- ▶ PSEN opII Adv Bracket Kit (available as an [accessory](#)  71) as a bracket for transmitter/receiver
 - Transmitter/receiver can be rotated on the bracket for alignment purposes
 - Protected field heights of 450 mm – 600 mm, including: 1 PSEN opII Adv Bracket Kit2 (= 2 clamping units per transmitter and receiver)
 - Protected field heights of 750 mm – 1200 mm, including:
 - 1 PSEN opII Adv Bracket Kit3 (= 3 clamping units per transmitter and receiver)
 - Protected field heights of 1350 mm – 1500 mm, including:
 - 2 PSEN opII Adv Bracket Kit2 (= 4 clamping units per transmitter and receiver)

2.1 Unit view

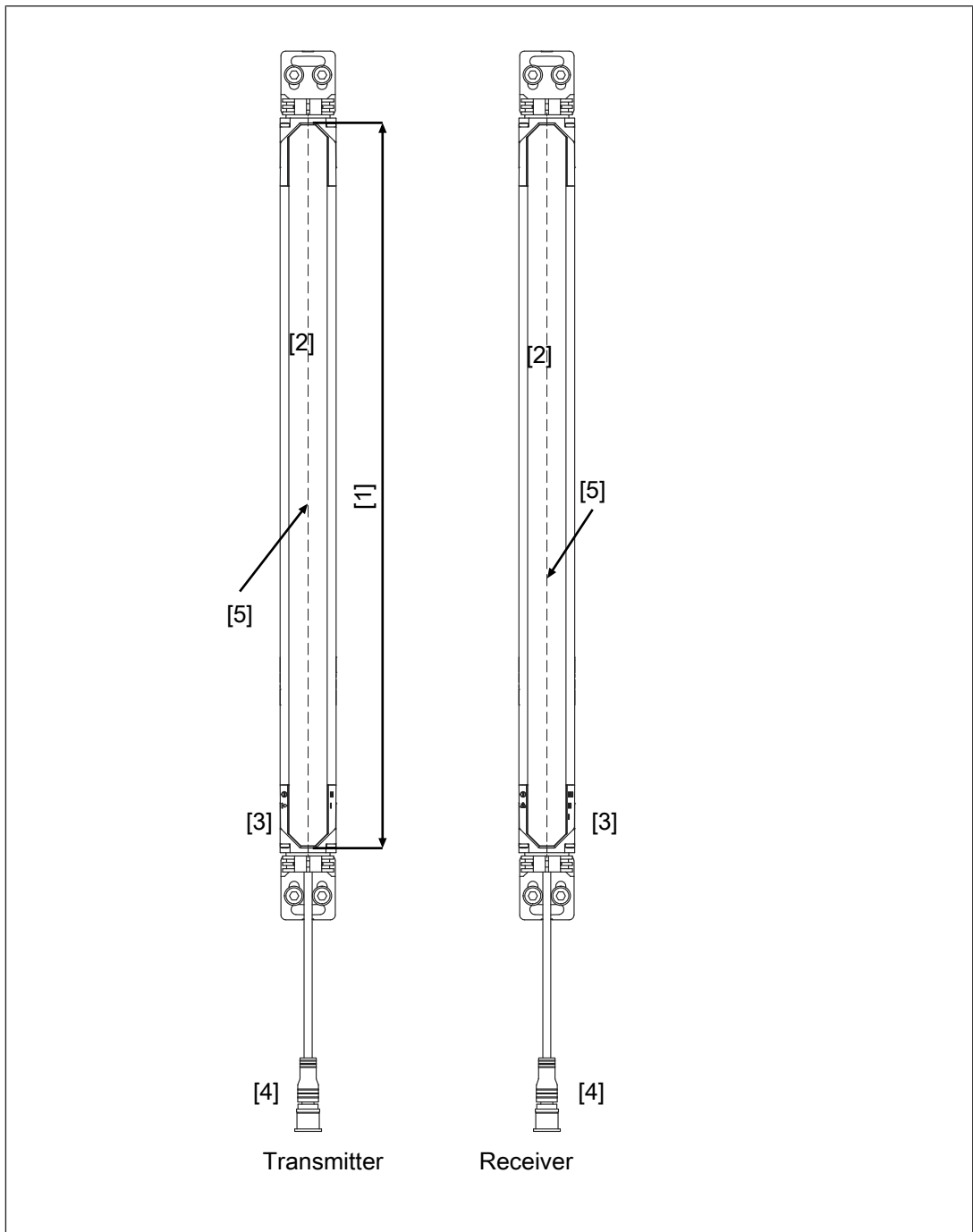



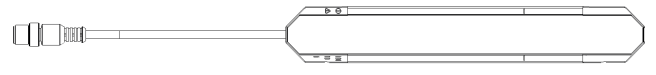
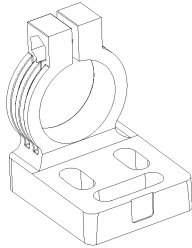
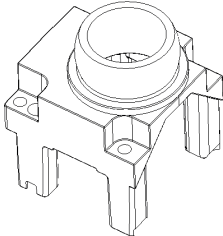

Fig.: Front view of the safety light curtain transmitter and receiver, protected field height 450 - 1500 mm with connection cable and installation kit

Legend

- [1] Overall length
- [2] Tinted front panel
- [3] LEDs for status information

- [4] Connection cable M12 connector
- [5] Optical centre axis

2.2 Scope of supply

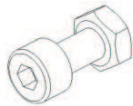
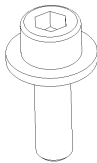
Qty	Description	Illustration
1	Transmitter	
1	Receiver	
4	Standard installation kit consisting of:	
4	▶ Flexible bracket (swivel mount) in which transmitters/receivers can be fastened and rotated to the proper orientation	
4	▶ Holder for connecting the transmitter/receiver end caps to the flexible bracket	
16	▶ Tightening screw M3x33.4 oval-head screw, self-tapping	
4	▶ Clamping screw with nut ISO 4762 M4x10 8.8 cylinder screw with nut	
8	▶ Mounting screw ISO 4762 M6x20 8.8 cylinder screw with washer	

3 Safety

3.1 Intended use

Safety light curtains in the PSEN opII3B Series are electrosensitive protective equipment of the ESPE type 3. They are used to protect personnel and systems. The safety light curtains are designed to

- ▶ Secure danger zones within buildings and
- ▶ Secure access within buildings with the following resolution:
 - 170 mm at a range of 0.2 - 15 m
 - 300 mm at a range of 10 - 55 m

The safety light curtain may only be used for personal protection on machinery if

- ▶ The safety light curtain can stop the hazardous state and
- ▶ The safety light curtain controls the machine start-up and
- ▶ The safety assessment does not specify a better resolution than that stated in the [Technical details](#)  56].

The safety level PL d (Cat. 3)/SIL CL 2 is only achieved if

- ▶ The safety outputs must be processed safety-related in 2-channel mode.

The safety light curtain is not equipped with a restart interlock.

If the safety assessment necessitates a restart interlock, this feature must be ensured within the plant's programmable safety system or an accessory. For the implementation with an accessory Pilz recommends that you use the accessory PSEN opII lockout (see [Order reference for accessories](#)  71]). The system may not be started in the danger zone following a protection violation if personnel are still in the danger zone.

Prevent circumvention of the protected field. This means that other safety devices and safeguards may be required in addition to the safety light curtain. These should be determined via a safety assessment based on the specific application area and specific local conditions (e.g. official specifications).

Refer to IEC/TS 62046 to determine other necessary safeguards for securing the danger zone.

Their application must fulfil the site's relevant national regulations (e. g. EN 60204-1, NFPA 79:17-7).

Improper use

The following is deemed improper use in particular

- ▶ Any component, technical or electrical modification to the product,
- ▶ Use of the product outside the areas described in this operating manual,
- ▶ Use of the product outside the technical details (see [Technical details](#)  56]).

**NOTICE****EMC-compliant electrical installation**

The product is designed for use in an industrial environment. The product may cause interference if installed in other environments. If installed in other environments, measures should be taken to comply with the applicable standards and directives for the respective installation site with regard to interference.

3.2 Safety regulations

3.2.1 Safety assessment

Before using a device, a safety assessment in accordance with the Machinery Directive is required.

The product as an individual component fulfils the functional safety requirements in accordance with EN ISO 13849 and EN 62061. However, this does not guarantee the functional safety of the overall plant/machine. To achieve the relevant safety level of the overall plant/machine's required safety functions, each safety function needs to be considered separately.

3.2.2 Use of qualified personnel

The products may only be assembled, installed, programmed, commissioned, operated, maintained and decommissioned by persons who are competent to do so.

A competent person is a qualified and knowledgeable person who, because of their training, experience and current professional activity, has the specialist knowledge required. To be able to inspect, assess and operate devices, systems and machines, the person has to be informed of the state of the art and the applicable national, European and international laws, directives and standards.

It is the company's responsibility only to employ personnel who

- ▶ Are familiar with the basic regulations concerning health and safety / accident prevention,
- ▶ Have read and understood the information provided in the section entitled Safety
- ▶ Have a good knowledge of the generic and specialist standards applicable to the specific application.

3.2.3 **Warranty and liability**

All claims to warranty and liability will be rendered invalid if

- ▶ The product was used contrary to the purpose for which it is intended,
- ▶ Damage can be attributed to not having followed the guidelines in the manual,
- ▶ Operating personnel are not suitably qualified,
- ▶ Any type of modification has been made (e.g. exchanging components on the PCB boards, soldering work etc.).

3.2.4 **Disposal**

- ▶ In safety-related applications, please comply with the mission time T_M in the safety-related characteristic data.
- ▶ When decommissioning, please comply with local regulations regarding the disposal of electronic devices (e.g. Electrical and Electronic Equipment Act).

4 Function description

4.1 Basic function

The safety light curtain consists of a transmitter and a receiver.

Their shape and design

- ▶ protect the transmitter and receiver from external damage
- ▶ protect the safety light grid from malfunctions caused by vibration (see [Technical details, environmental data section](#)  56).

The protected area is covered by infrared light beams, which are emitted from the transmitter to the receiver. The protected field thus produced is able to detect an opaque object.



The control and monitoring of the transmitted and received infrared rays is performed by microprocessors.

The output signal switching devices (OSSDs) switch to the OFF state when one of the following conditions is met:

- ▶ One or more light beams are interrupted by an object, a body part, or an opaque object that is at least as large as the resolution covered by the safety light curtain (170 mm or 300 mm, see [Technical details](#) , 56),
- ▶ A fault is detected in the safety light curtain,
- ▶ Stray light is detected.

If a fault occurs, the OSSDs remain in the OFF state. The state can be returned to the ON state only after a successful [restart](#) , 51 of the safety light grid.

The safety light grid in the PSEN opI3B Series offers the following functions:

- ▶ Automatic start
- ▶ automatic restart
- ▶ Operation of 2 safety light grids that are parallel to one another and are installed with the same orientation (noting the information in [ambient conditions](#) , 27) and [minimum separation of parallel, aligned safety light grids](#) , 27)

Transmitters and receivers are each electrically connected with a cable with an M12 connector that is assigned to the transmitter and receiver on the LED side.

The transmitter and receiver are optically synchronised and therefore need not be directly connected to each other.

Information about the operating status of the safety light curtain and any error state is provided by means of LEDs.

The indicators are described in the section: [Status information](#) , 49.

4.2 Automatic start and restart

Automatic start

When the safety light curtain is switched on the safety light curtain starts automatically and the OSSDs switch to the ON state under the following conditions:

- ▶ Both OSSDs are wired correctly **and**
- ▶ No fault has occurred **and**
- ▶ The protected field is clear.

If the protected field is violated, the OSSDs switch to the OFF state.

Automatic restart

The OSSDs automatically switch to the ON state during operation under the following conditions:

- ▶ Both OSSDs are wired correctly **and**
- ▶ No fault has occurred **and**
- ▶ the protected field is clear **and**
- ▶ at least 80 ms have elapsed since the switch to the OFF state.

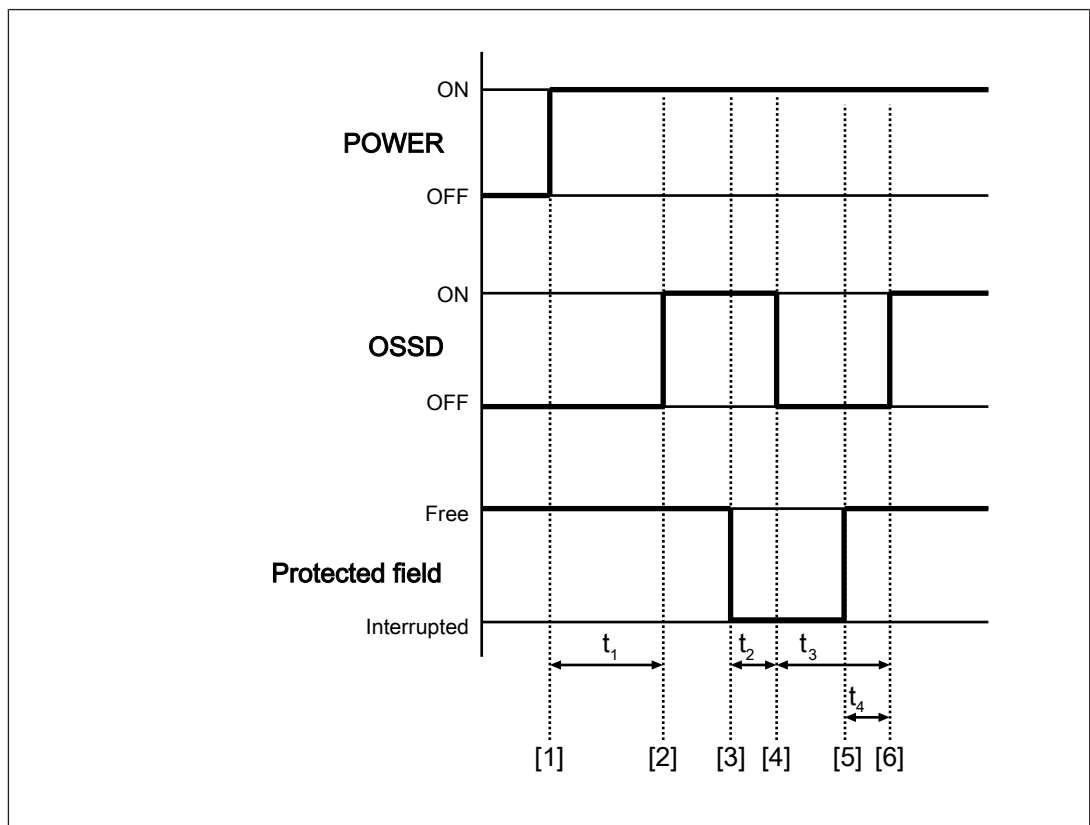

Fig.: Automatic start and restart timing diagram

Legend

- [1] Safety light curtain is switched on
- [2] Check completed successfully, OSSDs in the ON state
- [3] Protected field broken
- [4] OSSDs in the OFF state

- [5] Protected field is clear again, fault check is restarted
- [6] OSSDs in the ON state
- t_1 Check is begun to determine whether the protected field is clear and whether there are faults
- t_2 Response time (coded/uncoded), until OSSDs switch to the OFF state (see [Technical details \[56\]](#))
- t_3 Minimum time that the OSSDs remain in the OFF state: 80 ms
- t_4 Time between the protected field being enabled and the OSSDs changing to the ON state
 - ▶ Without beam coding
 - If a synchronisation beam pair is interrupted: Response time + 10 ms
 - If both synchronisation beam pairs (first and last light beam pair) are interrupted: see uncoded resynchronisation time in the technical details
 - ▶ With beam coding
 - If a synchronisation beam pair is interrupted: Response time (with beam coding) + 10 ms
 - If both synchronisation beam pairs (first and last light beam pair) are interrupted: see coded resynchronisation time in the technical details

4.3 Operation of two safety light curtains with the same alignment

Two adjacent safety light curtains with the same alignment can be operated, without the two safety light curtains influencing each other (see [Minimum distance between parallel, aligned safety light curtains \[27\]](#)).

For the correct function of the two safety light curtains, a beam coding of the safety light curtains is required. The beam coding is performed via the connection of the safety light curtain to the supply voltage (see [Connector pin assignment \[40\]](#)).

5 Project configuration

5.1 Maintaining the safety distance

The minimum distance of the safety light curtain to the dangerous machine component should be such that the operator cannot reach the danger zone until the movement of the dangerous machine part has stopped.

In accordance with the standard

- ▶ EN ISO 13855

this distance depends on three factors:

- ▶ Response time of the safety light curtain

Time between the beams being interrupted and the OSSDs changing to the OFF state (see [Technical details \[56\]](#))

When beam coding is used, the response time is increased (see Technical Details)

- ▶ Machine's stopping time

Time between the OSSDs changing to the OFF state and the hazardous machine movement stopping (including the reaction time of the connected relay)

- ▶ Approach speed

The speed with which the object to be detected is nearing the danger zone in mm/s



NOTICE

Increase in safety light curtain's response time

When beam coding is used, the response time is increased (see Technical Details)

The general formula for calculating the minimum distance in accordance with EN ISO 13855 is as follows:

$$S = K * (t_1 + t_2) + C$$

S	Minimum distance in mm, measured from the start of the protected field to the danger source
K	Approach speed with which the object to be detected is nearing the danger zone in mm/s K = 1600 mm/s
t ₁	Response time of the safety light curtain in seconds Time it takes for the signal at the OSSD output on the safety light curtain to change once a protected field has been violated (see Technical details [56])
t ₂	Machine's stopping time in seconds The time required for the machine to stop after the signal at the OSSD output changes
C	Additional distance of 850 mm for safety light curtains with body protection

5.2 Prevent reaching across a vertical protected field

If the possibility of someone reaching across a vertical protected field is present, the minimum distance in mm in accordance with EN ISO 13855 between the protected field and the danger zone must not be less than the value calculated to the following equation.

$$S = K * (t_1 + t_2) + C_{RO}$$

S	Minimum distance in mm, measured from the start of the protected field to the danger source
K	Approach speed with which the object to be detected is nearing the danger zone in mm/s K = 1600 mm/s
t ₁	Response time of the safety light curtain in seconds Time it takes for the signal at the OSSD output on the safety light curtain to change once a protected field has been violated (see Technical details [56])
t ₂	Machine's stopping time in seconds The time required for the machine to stop after the signal at the OSSD output changes
C _{RO}	Additional distance where a body part can move in the direction of the danger zone before the safety light curtain's OSSD triggers

Height of the danger zone	Height of the top edge of the protected field's safety light curtain		
	900	1200	1500
2600 ^a	0	0	0
2500	400	300	300
2400	550	500	450
2200	800	700	650
2000	950	850	750
1800	1100	950	800
1600	1150	1000	850
1400	1200	1000	850
1200	1200	1000	800
1000	1200	950	700
800	1150	800	450
600	1050	550	0
400	900	0	0
200	600	0	0

Distance C_{RO} when reaching over a vertical protected field

Application example:

- ▶ Height of the danger zone = 1400 mm
 - ▶ Height of the top edge of the safety light curtain's protected field = 1200 mm
- This results in the distance C_{RO} as an allowance = 1000 mm

Note:

- ▶ If various values result when determining the safety distance to these formulas, the higher value has to be used.

General formula to EN ISO 13855	$S = K * (t_1 + t_2) + C$
Prevent reaching across a vertical protected field in accordance with EN ISO 13855	$S = K * (t_1 + t_2) + C_{RO}$

5.3 Prevent creeping underneath and stepping over

To prevent anyone crawling underneath in accordance with EN ISO 13855, the distance from the reference plane (the floor, for example) to the lowest beam must be max. 300 mm.

The uppermost beam must be at a distance of at least 900 mm from the reference plane (the floor, for example).

Determine the height for a safety light curtain of the PSEN opI3B Series with a resolution of 170 mm (range 15 m)

The bottom edge of the safety light curtain must be at the height of 226 mm as a maximum.

The height of the lowest beam is then ≤ 300 mm and creeping underneath the protected field is prevented.

The top edge of the safety light curtain must be at least at the height of 990 mm.

The height of the uppermost beam is then ≥ 900 mm and stepping over the protected field is prevented.

If a risk assessment permits a distance from the reference plane of 400 mm, the required protected field height of the safety light curtain may be reduced to 750 mm.

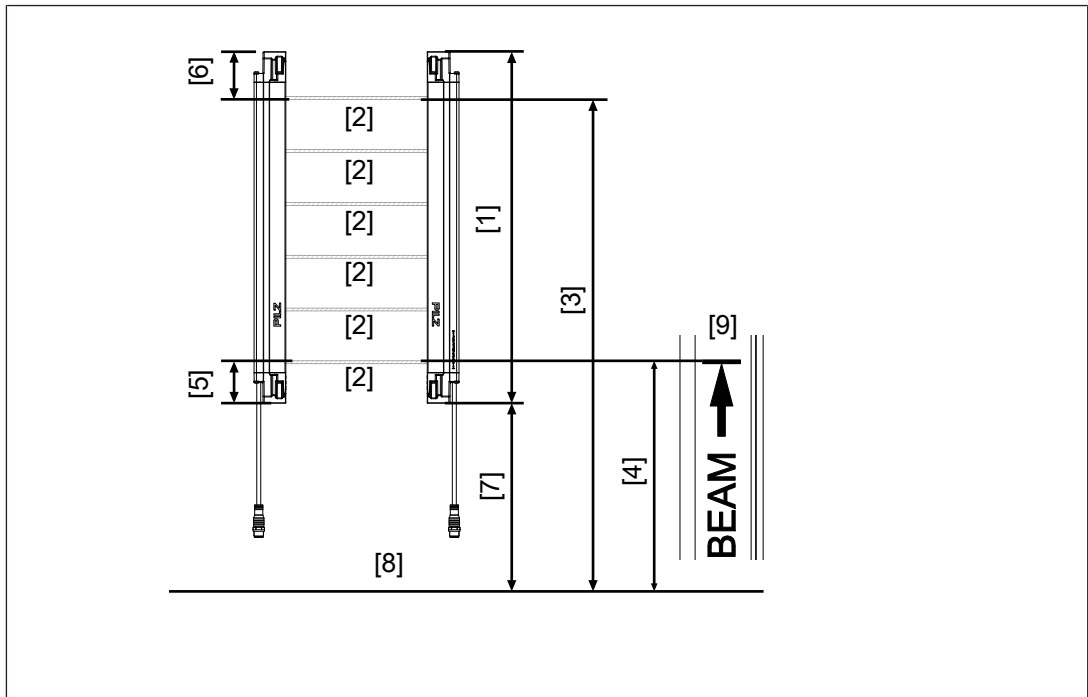

Legend

- [1] Total length ± 3 mm (see [Technical details](#)  56)
- [2] Light beams
- [3] 900 mm distance of the uppermost light beam from the floor to prevent stepping over
- [4] 300 mm distance of the lowest light beam from the floor to prevent creeping underneath
- [5] 74 mm distance of the lowest light beam from the bottom edge of the safety light curtain
- [6] 90 mm distance of the uppermost light beam from the upper edge of the safety light curtain
- [7] Distance of the bottom edge of the safety light curtain from the floor
- [8] Floor
- [9] Zoom display of the position marking of the lowest light beam

Determine the height for a safety light curtain of the PSEN oplI3B Series with a resolution of 300 mm (range 55 m)

The bottom edge of the safety light curtain must be at the height of 172 mm as a maximum.

The height of the lowest beam is then ≤ 300 mm and creeping underneath the protected field is prevented.

The top edge of the safety light curtain must be at least at the height of 1049 mm.

The height of the uppermost beam is then ≥ 900 mm and stepping over the protected field is prevented.

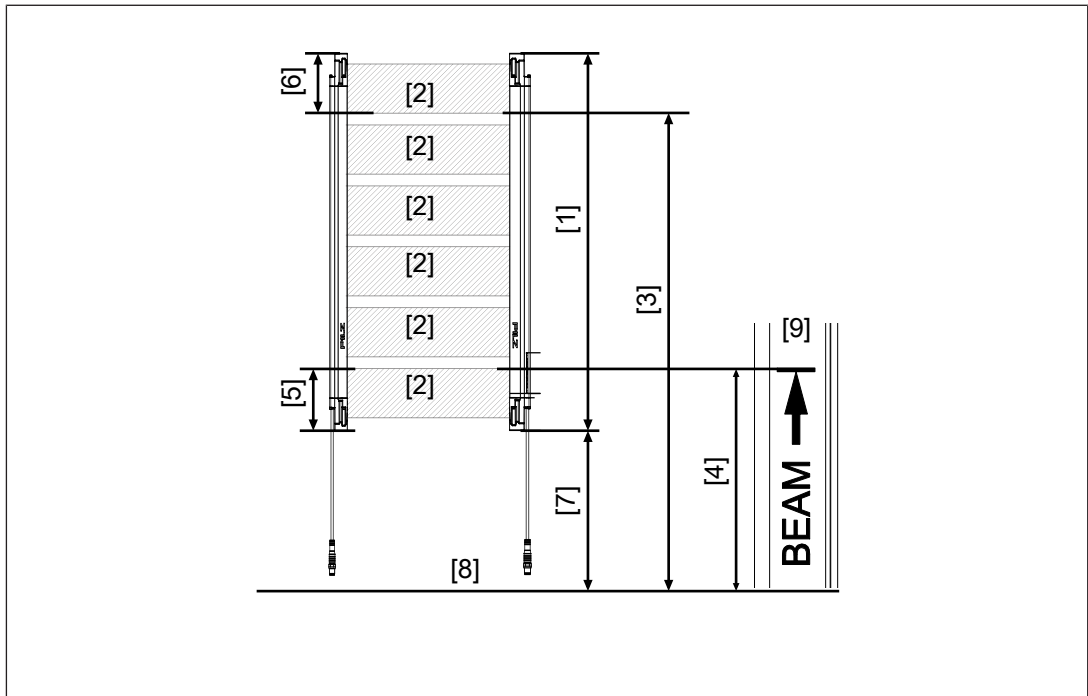

Legend

- [1] Total length ± 3 mm (see [Technical details \[56\]](#))
- [2] Light beams
- [3] 900 mm distance of the uppermost light beam from the floor to prevent stepping over
- [4] 300 mm distance of the lowest light beam from the floor to prevent creeping underneath
- [5] 128 mm distance of the lowest light beam from the bottom edge of the safety light curtain
- [6] 149 mm distance of the uppermost light beam from the upper edge of the safety light curtain
- [7] Distance of the bottom edge of the safety light curtain from the floor
- [8] Floor
- [9] Zoom display of the position marking of the lowest light beam

To prevent creeping underneath and stepping over, safety light curtains with a protected field height of at least 900 mm are therefore suitable (see [Order reference \[70\]](#)).

5.4 Resolution

The safety light grids may only be used for protected fields in which the detection capability (see [Technical details](#) [ 56]) is sufficient.

5.5 Protected field perimeters

During planning, ensure sufficient protected field height to secure the danger zone.

The protected field perimeter is defined in [dimensions](#) [ 55].

5.6 Ambient conditions

- ▶ Install the safety light grids in an environment that corresponds to the environmental data provided in the [Technical details](#) [ 56].
- ▶ Do not install the safety light grid near particularly intense and/or flashing light sources; this applies to the receiver in particular.
- ▶ The transmitter of one safety light curtain must not interfere with the receiver of another safety light curtain .
- ▶ The transmitters and receivers of two different safety light grids must not be synchronised.
- ▶ Avoid strong electromagnetic interference when operating the safety light grid.
- ▶ When operating the safety light grid, avoid the development of smoke, mist, or dust that would reduce the grid's operating range.

5.7 Distance from reflective surfaces

If there are reflective surfaces near the beams emitted from the safety light curtain (whether from above, below, or from the side), passive reflections can cause an object within the protected field to remain undetected (see diagrams).

As a result, the safety light curtain must be installed at a minimum distance from reflective surfaces.

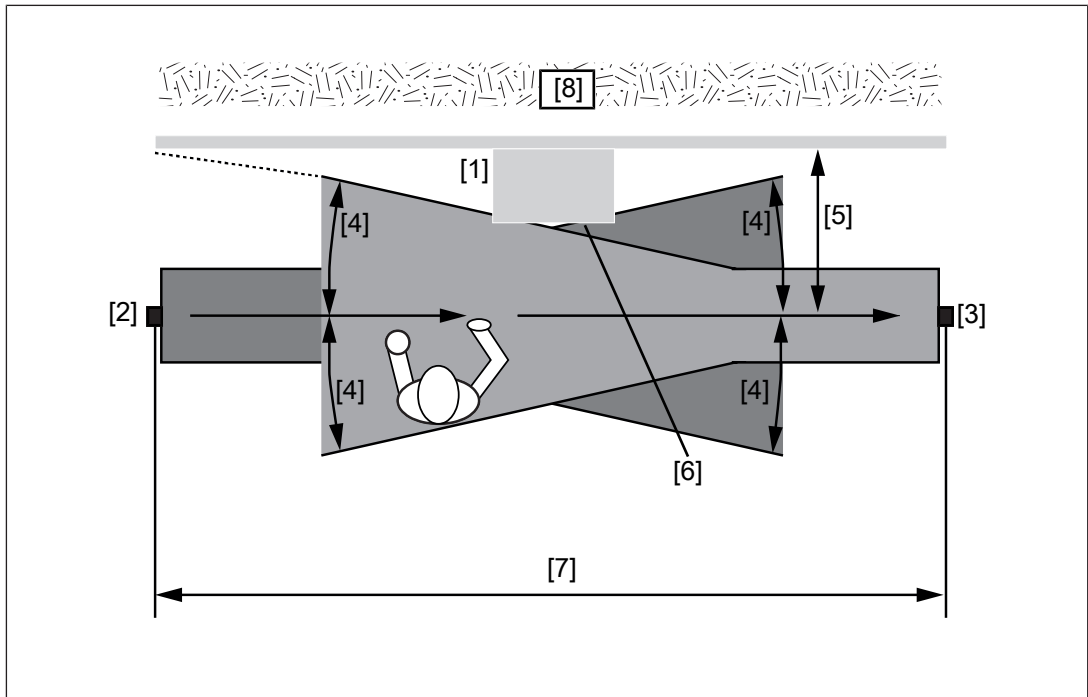
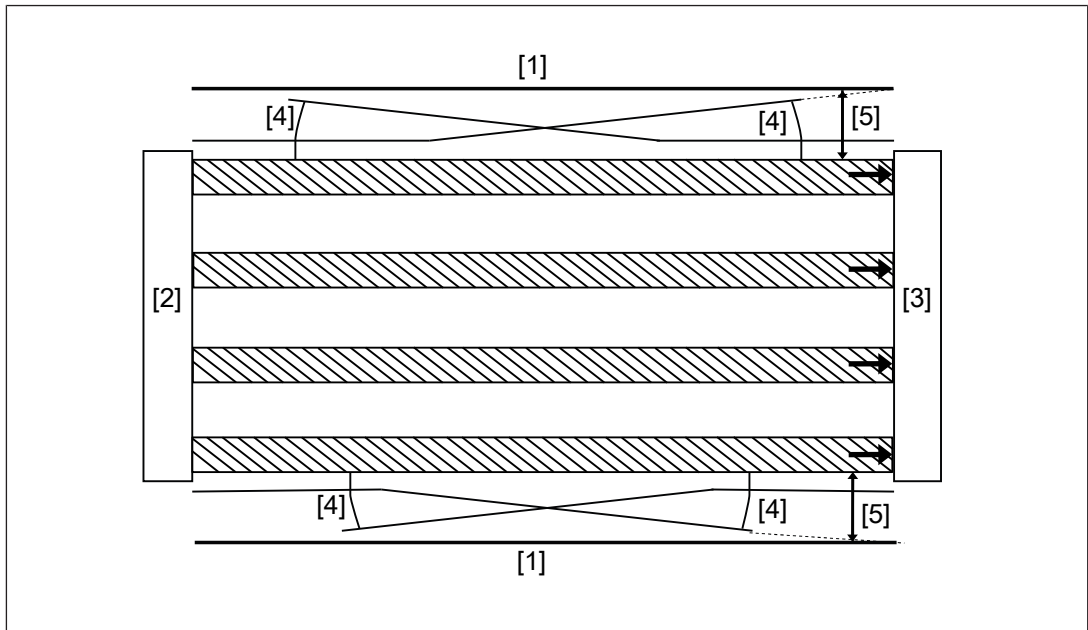

Fig.: Interference with the function of the safety light curtain due to reflective surfaces – top view



Legend

- [1] Reflective surface
- [2] Transmitter
- [3] Receiver
- [4] Half of the opening angle (= α) (see [Technical details \[56\]](#)) of the light beams emitted by the safety light curtain
- [5] Minimum distance D from the outer edge of the safety light curtain's outermost light beam to the reflective surface
- [6] Passive reflection on the surface
- [7] Distance between transmitter and receiver (working distance)
- [8] Danger zone

The minimum distance D depends on two factors:

- ▶ Working distance between transmitter and receiver
- ▶ the maximum [opening angle \[56\]](#) of the light beams emitted by the safety light curtain at:

$7^\circ = \pm 3.5^\circ$ in relation to the optical axis

Minimum distance of the safety light curtain to reflective surfaces

The formula for calculating the minimum distance D is:

- ▶ Working distance < 3 m: $D = 0.184$ m
- ▶ For a working distance of 3 m or more: $D = \text{working distance in m} \times \tan 3.5^\circ$

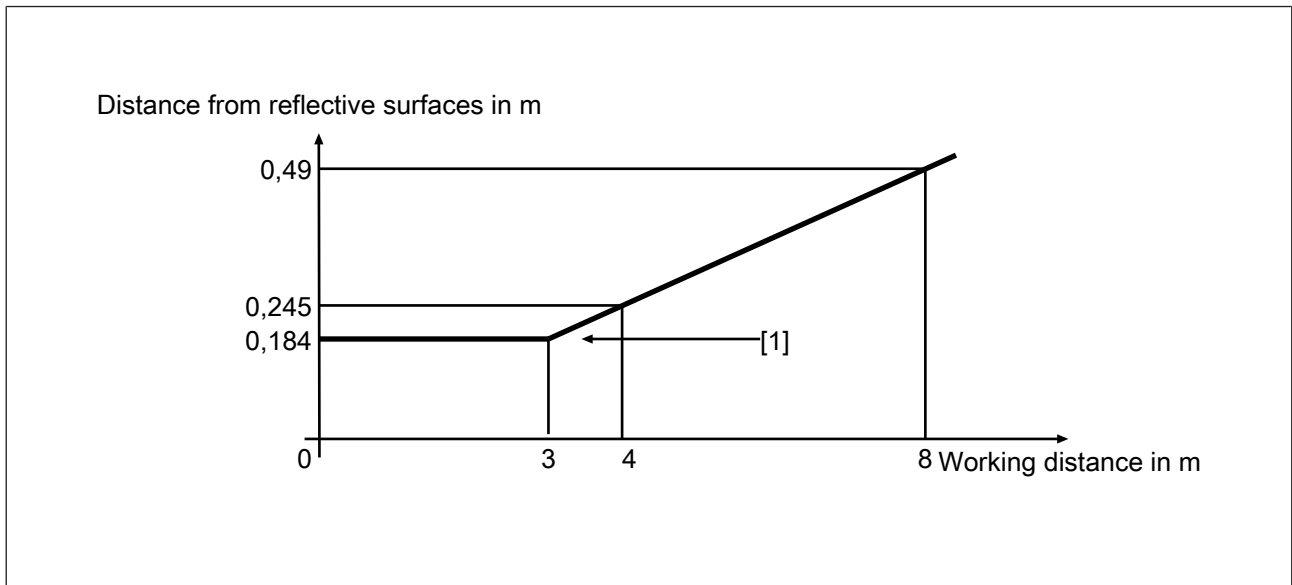

Fig.: Relationship between minimum distance and working distance

Legend

[1] Minimum distance D

5.8 Minimum distance between parallel, aligned safety light curtains

Note:

Safety light curtains that are installed parallel and aligned to each other must be installed at a minimum distance to each other, as specified under [Distance to reflective surfaces](#) [📖 24].

Without beam coding

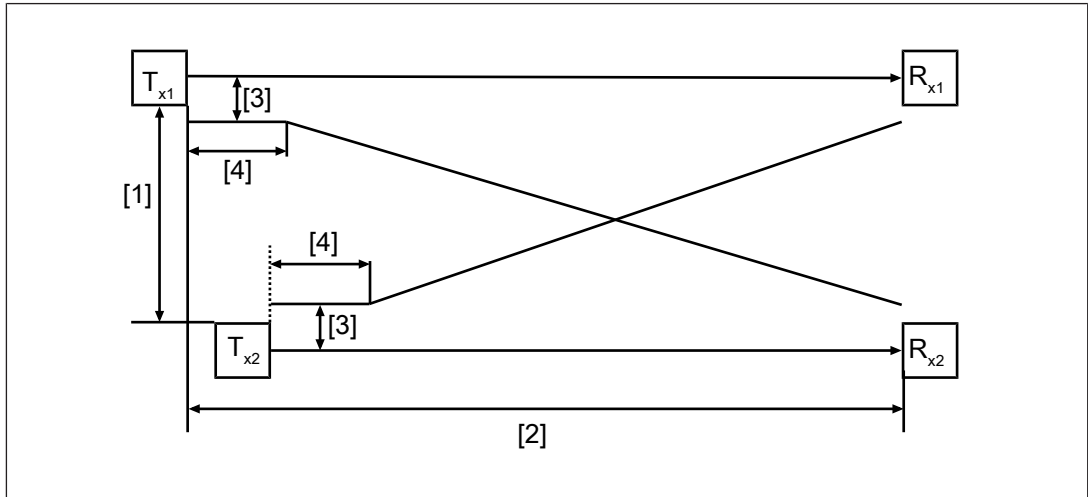

Legend

T_{x1} Transmitter from the first safety light curtain

R_{x1} Receiver from the first safety light curtain

T_{x2} Transmitter from the second safety light curtain

R_{x2} Receiver from the second safety light curtain

[1] Minimum distance D_{LV} between two safety light curtains that are aligned

▶ Working distance $A < 3$ m: $D_{LV} = 2 \times D = 0.368$ m

▶ Working distance $A \geq 3$ m: $D_{LV} = 2 \times A \times \tan 3.5^\circ$

[2] Working distance A

[3] Minimum distance D, dependent on the working distance

[4] Working distance (≤ 3 m) with constant minimum distance $D = 0.184$ m

With beam coding

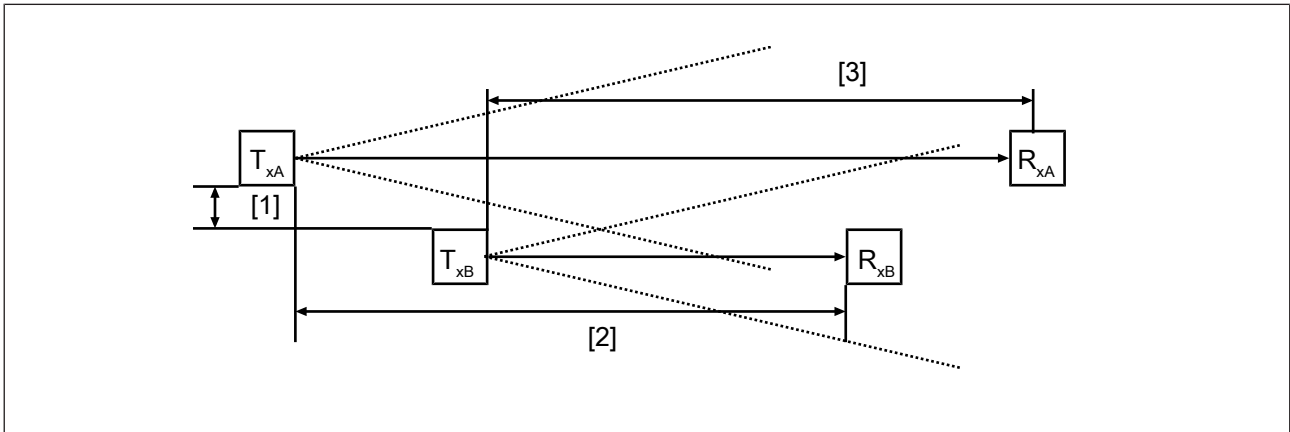

Legend

- T_{xA} Transmitter from the first safety light curtain
- R_{xA} Receiver from the first safety light curtain
- T_{xB} Transmitter from the second safety light curtain
- R_{xB} Receiver from the second safety light curtain
- [1] Minimum distance between two aligned safety light curtains with beam coding
- [2] Distance between the transmitter of the first safety light curtain and the receiver of the second safety light curtain
- [3] Distance between the transmitter of the second safety light curtain and the receiver of the first safety light curtain

Minimum distance between two aligned safety light curtains with beam coding

Lower value of the distances [2] and [3]	Minimum distance between safety light curtains that are aligned in parallel [1]
▶ 170 mm resolution	
[2] < 2.5 m or [3] < 2.5 m	2 x D = 368 mm
[2] ≥ 2.5 m and [3] ≥ 2.5 m	-
▶ 300 mm resolution	
[2] < 10 m or [3] < 10 m	2 x 10 m x tan α
[2] ≥ 10 m and [3] ≥ 10 m	-

5.9 Installation of several adjacent safety light grids

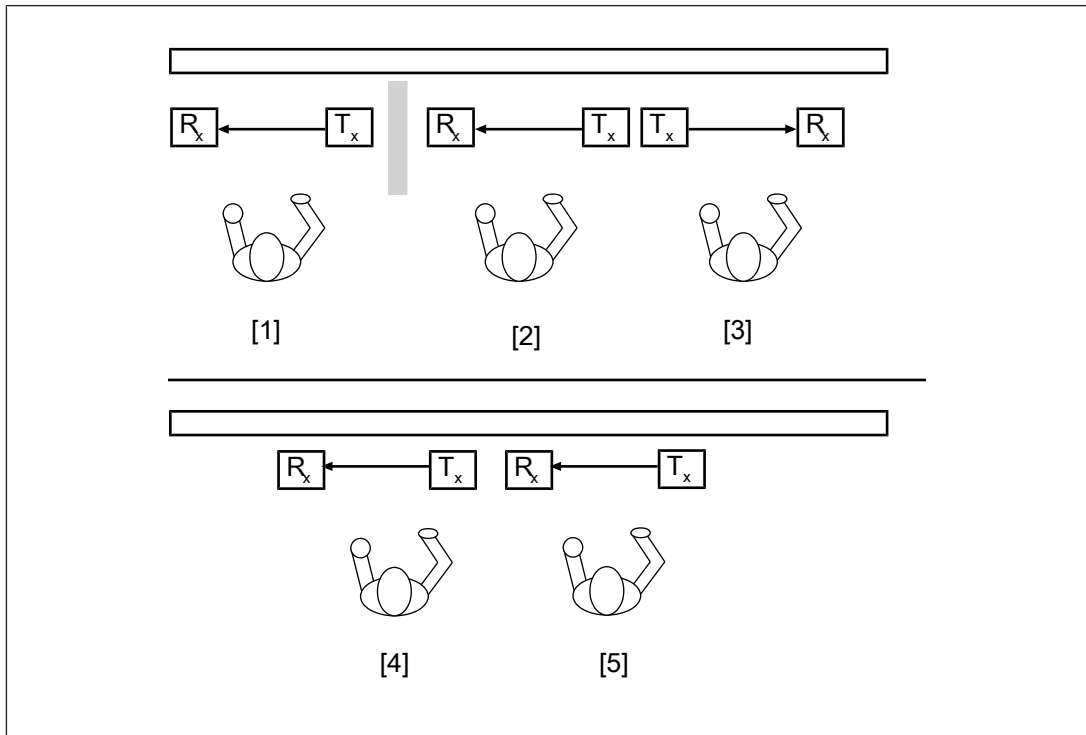

Fig.: Using several adjacent safety light curtains

Legend

R_x Safety light curtain receiver

T_x Safety light curtain transmitter

- [1] Connecting the safety light curtain with an opaque surface to shield the safety light curtain on the right
- [2] Connection of the safety light curtain aligned with [1]
- [3] Connection of safety light curtain without shielding, but in opposite alignment to [2]
- [4] Connection of the safety light curtain with beam coding A-coded
- [5] Connection of the safety light curtain with beam coding B-coded



WARNING!

Possible loss of the safety function with differing applications

There is an increased risk of injury or even a threat to life when the following conditions are simultaneously fulfilled in the application:

- both light curtains are coded,
- there is an offset between the light curtains,
- light curtains in various lengths are installed side by side,
- the receivers of the light curtains are aligned (such as pos. [4] and [5]).

Contact Pilz to exclude a hazard by taking appropriate measures.

► Beam coding of two safety light curtains

- If two safety light codes are to be used in parallel, a beam coding of the safety light curtains is recommended. When connecting the safety light curtain to the supply voltage, the safety light curtains are connected to different pins. This guarantees a differentiation of the beams, and transmitter and receiver can not interfere with each other.

If several adjacent safety light curtains need to be installed, steps must be taken to ensure that the transmitter on one safety light curtain does not interfere with the receiver on another safety light curtain.

An arrangement of the adjacent safety light curtains can be achieved by various methods.



WARNING!

Hazard due to loss of the safety function

When calculating the safety distance, remember the extended response time when using beam coding (see [Technical details](#) [📖 56]).

Changing from uncoded to coded operation is a change to the safety light curtain and requires a new risk assessment and hazard analysis.

- Perform a new risk assessment and hazard analysis and determine the new [minimum distance](#) [📖 18] to the danger zone with the extended response time.

5.10 Use of deviating mirrors

Danger zones with different but adjacent access sides can be monitored using a safety light curtain in conjunction with [deviating mirrors](#) [📖 71].

The diagram below shows an example solution for monitoring three different access sides using two deviating mirrors. The deviating mirrors must be positioned at an angle of 45° to the beams from the safety light curtain.

When using deviating mirrors, please note:

- Even a minor angular displacement of the mirror can lead to misalignment, adversely affecting or preventing the function of the safety light curtain. Use the laser pointer PSEN opII for alignment (see [Order reference for accessories](#) [📖 71]).
- The minimum safety distance to the danger zone must be maintained for all sections of the light path.
- The use of a single deviating mirror reduces the operating range (the degree of reduction is specified in the technical details of the used mirrors). This percentage increases when an additional deviating mirror is used. Please consider this reduction when positioning the safety light curtain.
- You should not use more than two mirrors per device.
- Any dust or dirt on the mirror's reflective surface will drastically reduce the operating range.

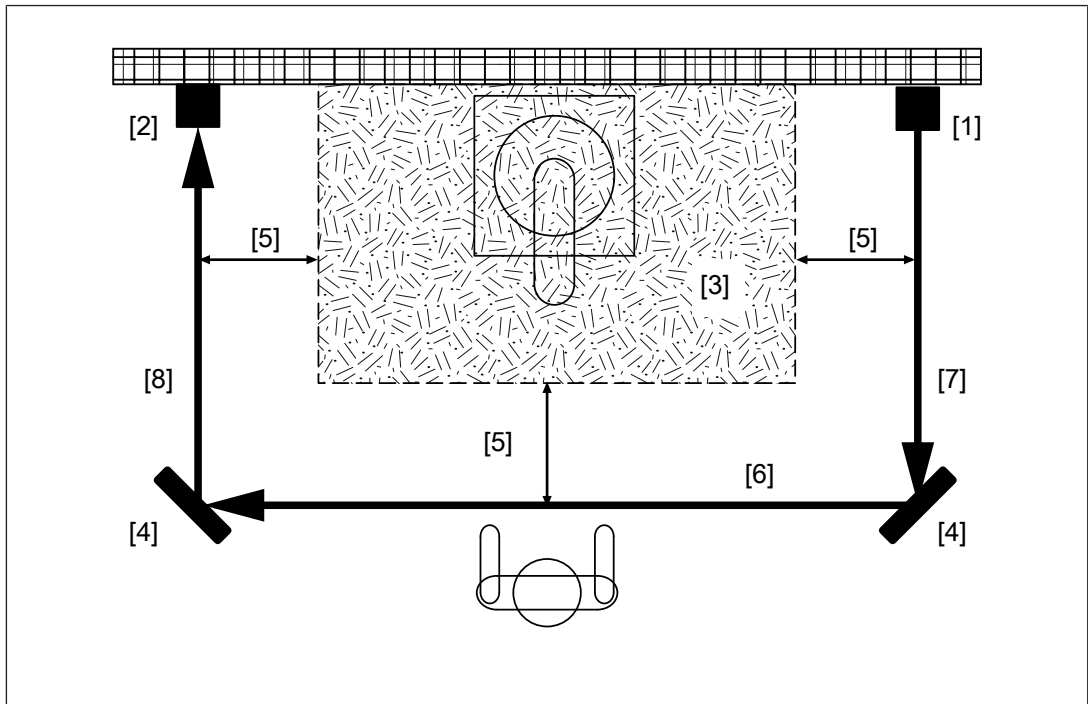

Fig.: Example for using deviating mirrors

Legend

- [1] Transmitter
- [2] Receiver
- [3] Hazardous area
- [4] Deviating mirror
- [5] Minimum safety distance
- [6] Distance between the deviating mirrors
- [7] Distance from transmitter to deviating mirror
- [8] Distance from deviating mirror to receiver

6 Installation and alignment

Note:

- ▶ The optical surfaces of the transmitter and receiver must be parallel to each other and oriented opposite to each other.
- ▶ The connection sides of the transmitter and receiver must be on the same side and at the same height (see diagram).

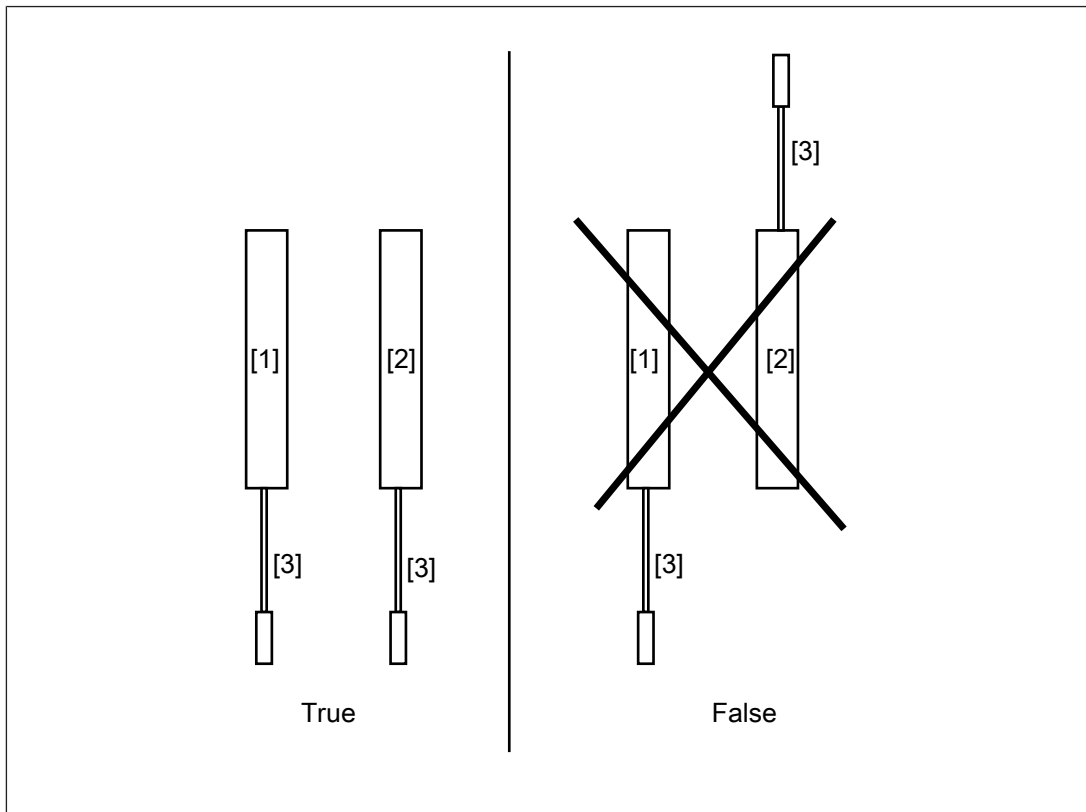

Legend

- [1] Transmitter
- [2] Receiver
- [3] Connection cable

- ▶ The distance between the transmitter and receiver must be within the operating range of the safety light curtain used (see [Technical details \[56\]](#)).
- ▶ The installation surface must be at least as wide as the standard installation kit
- ▶ The installation surface may have a flatness imperfection of no more than 1.5 mm.

6.1 Attach the safety light curtain to the mounting surface

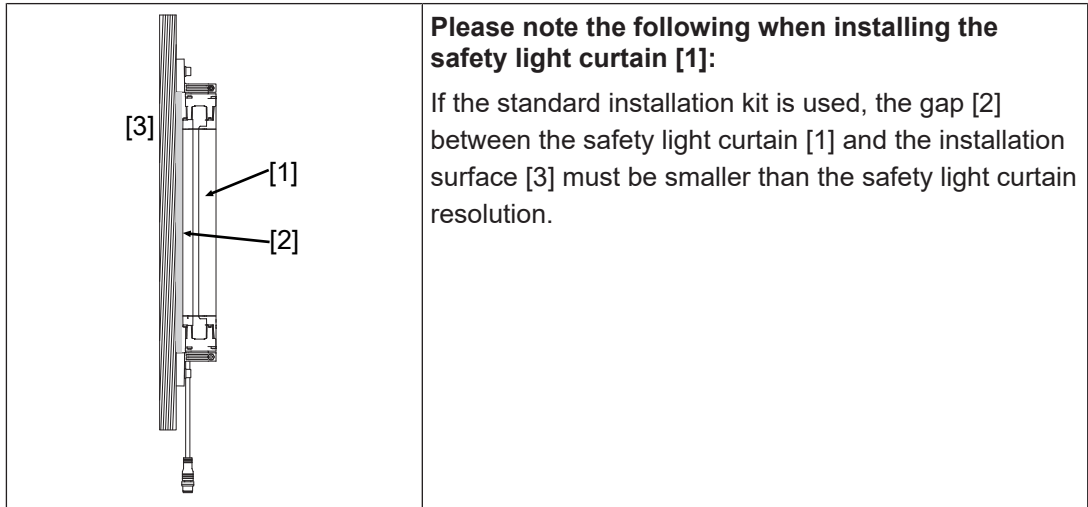

Prepare the installation surface.

Clean the installation surface. The installation surface must be free of dust and grease.

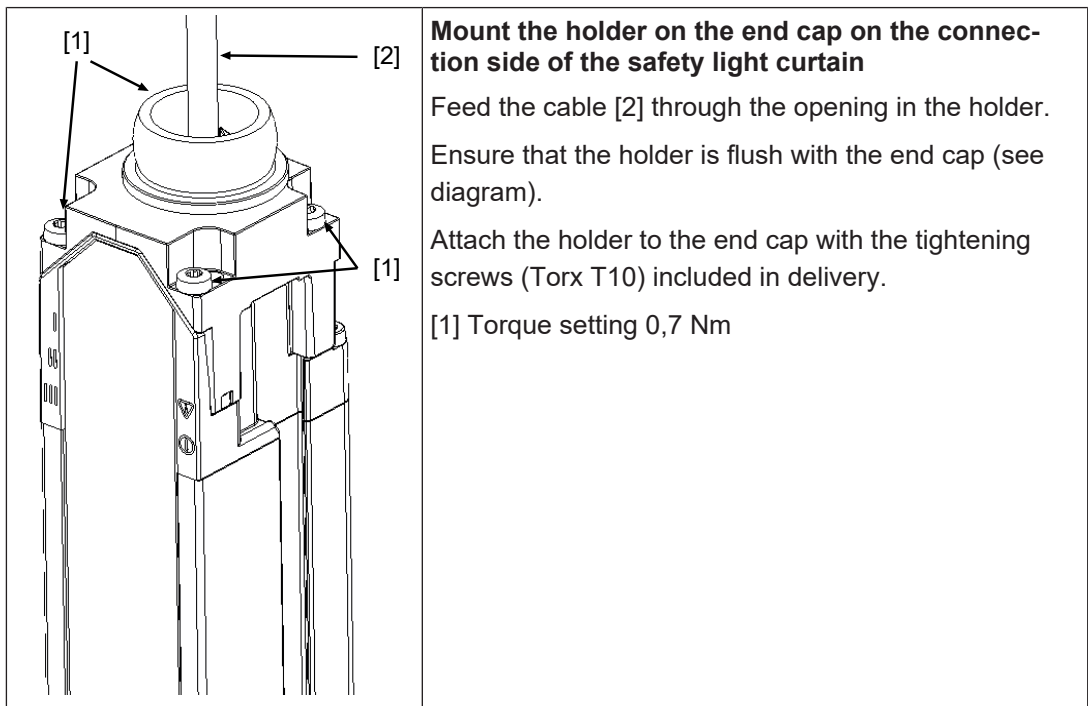

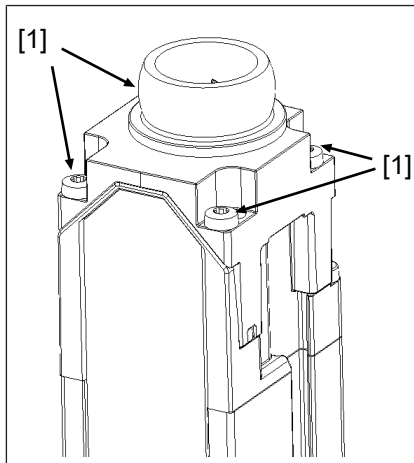

Mount the holder on the end cap on the wiring side of the safety light curtain

Ensure that the holder is flush with the end cap (see diagram).

Attach the holder to the end cap with the tightening screws included in delivery.

[1] Torque setting 0,7 Nm

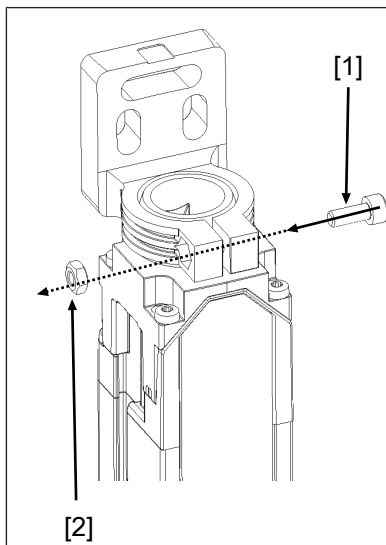

Mount the flexible bracket (swivel mount) on the holder on both the connection and wiring sides of the safety light curtain.

Push the flexible bracket over the holder. The flexible bracket must lie flush with the holder.

Fix the flexible bracket in place with the clamping screw [1] and the nut [2].

The screw connection is only tightened to the final torque when the assembly is orientated.

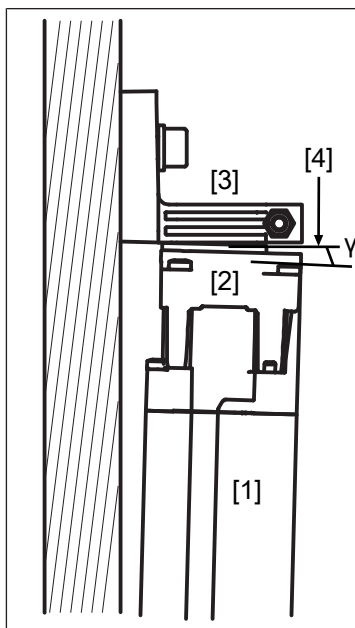

Uneven installation surfaces can be compensated for with the standard installation kit to a limited extent only.

Please note the following when installing the safety light curtain [1]:

- ▶ The angle [4] of the flexible bracket [3] on the holder [2] may not be more than 2°.
- ▶ The flexible bracket [3] must be seated on one side of the holder [2].

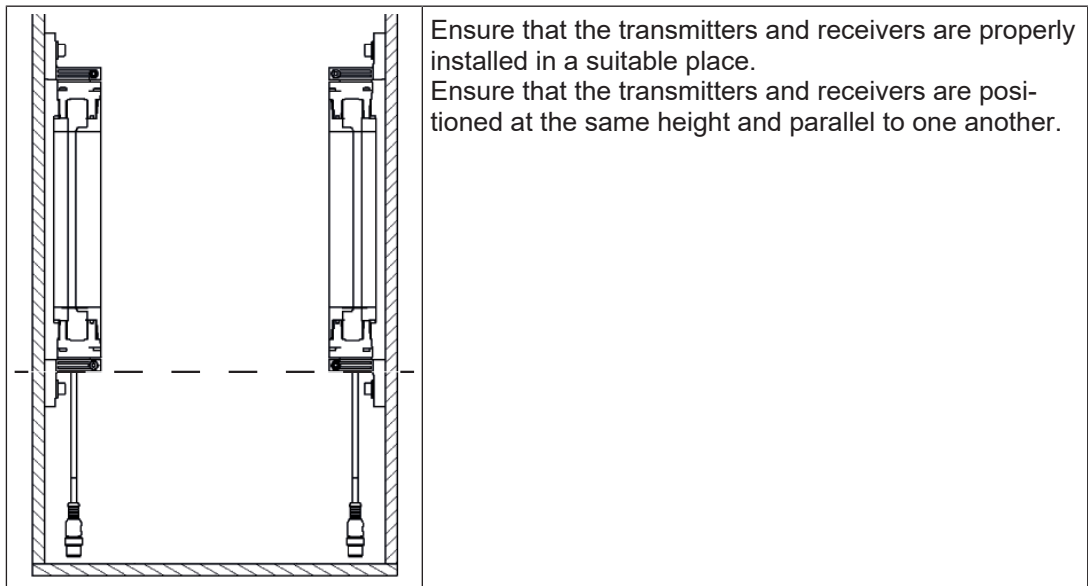
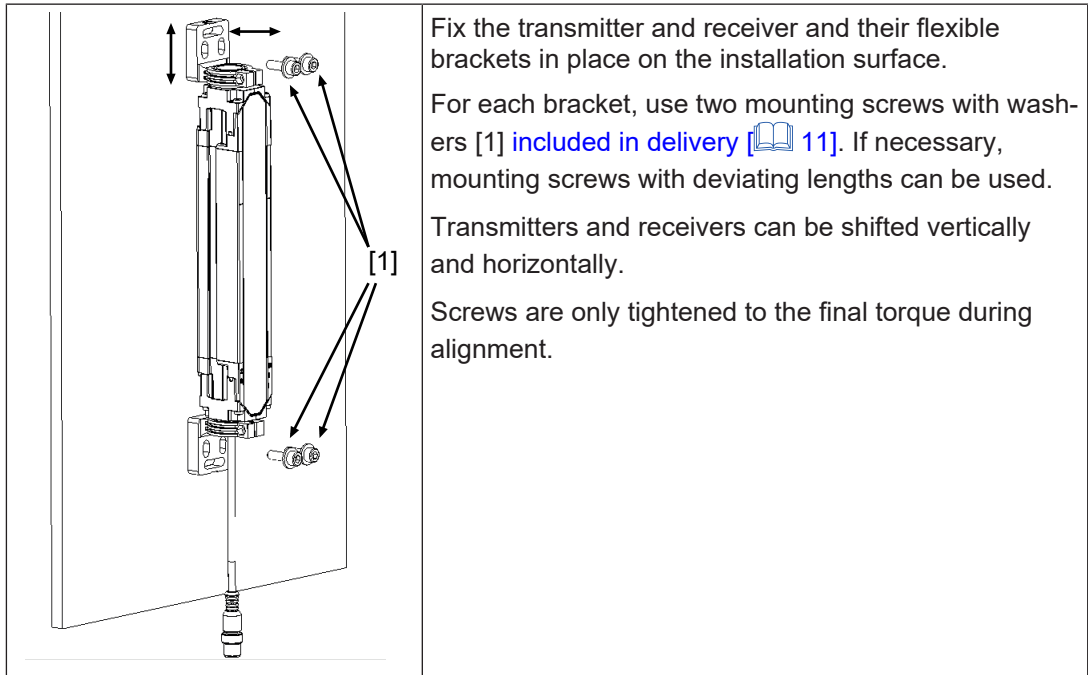
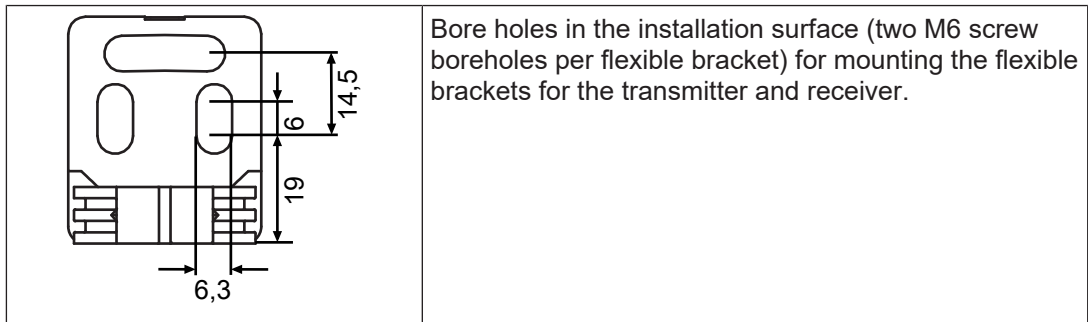

6.2 Orientation

6.2.1 General guidelines

For the safety light curtain to function properly, the transmitter and receiver must be aligned correctly.

The safety light curtain's transmitter and receiver can be aligned with or without a laser alignment tool.

- ▶ Alignment with laser alignment tool: the safety light curtain does not need to be switched on
- ▶ Alignment without a laser alignment tool: the safety light curtain must be already wired (see Wiring) and switched on

For alignment Pilz recommends the PSEN opII Laserpointer (see [Order references for accessories](#)  71]).

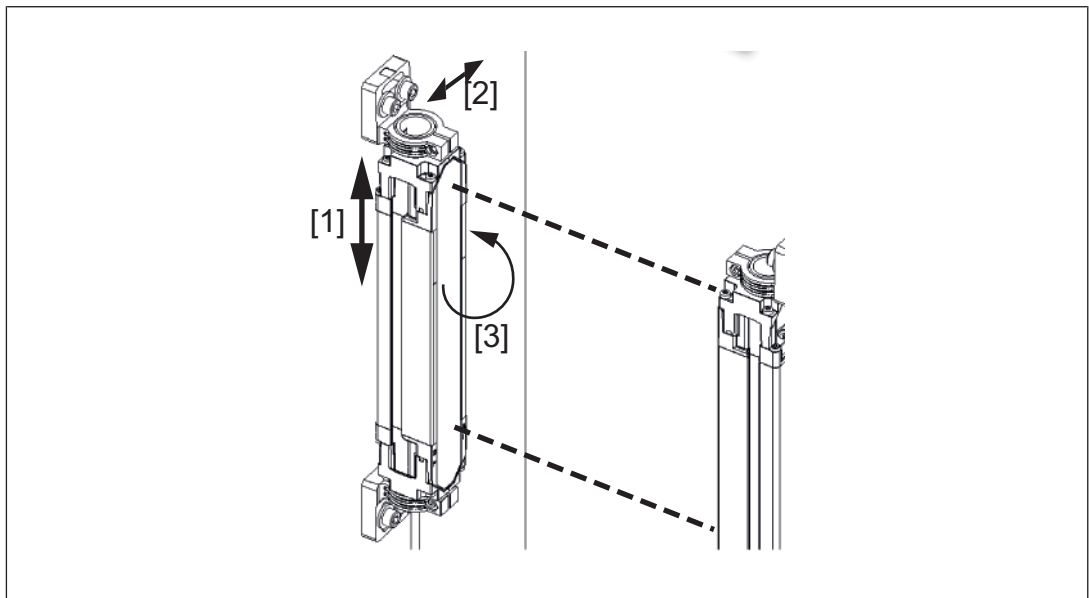

Fig.: Transmitter/receiver modification directions during orientation

Legend

- [1] Vertical: by vertical shifting of position in the elongated holes in the top and bottom flexible brackets
- [2] Horizontal: by moving up and down in the slots in a horizontal direction
- [3] The axis orientation can be changed by rotating the flexible bracket right or left

Pilz recommends that modifications to the orientation of the transmitter/receiver be made in the following sequence:

1. Vertical modification
2. Horizontal modification
3. Axis orientation modification

6.2.2 Safety light curtain alignment

Optimal orientation with the use of a laser orientation aid

The optimal orientation has been achieved with a laser orientation aid if the following conditions are met:

- ▶ The beam of the laser orientation aid attached to the transmitter strikes the receiver **and**
- ▶ the beam of the laser orientation aid attached to the receiver strikes the transmitter

Perform the orientation as described in the laser orientation aid's operating manual.



WARNING!

The laser beam of the laser orientation aid is harmful to the human eye

The human eye may be injured.

- Ensure that the laser beam is not directed at a human eye.

Optimal orientation without a laser orientation aid

1. Determine the maximum rotation range in when the protected field LED (OSSD status) illuminates green.
Rotate the transmitter and receiver until the protected field LED (OSSD status) changes from red to green.
2. Rotate the transmitter to the centre of the rotation range in which the protected field LED illuminates green.
3. Rotate the receiver to the centre of the rotation range in which the protected field LED illuminates green.

After the safety light curtain's transmitter and receiver have been orientated, the clamping screws and nuts and the mounting screws must be tightened to their final torques.

- ▶ Tighten the clamping screws [1] and the nuts [2] on the flexible bracket to a torque of 1,1 Nm.
- ▶ Tighten the brackets' mounting screws [3] on the installation surface to a torque of 3 Nm.

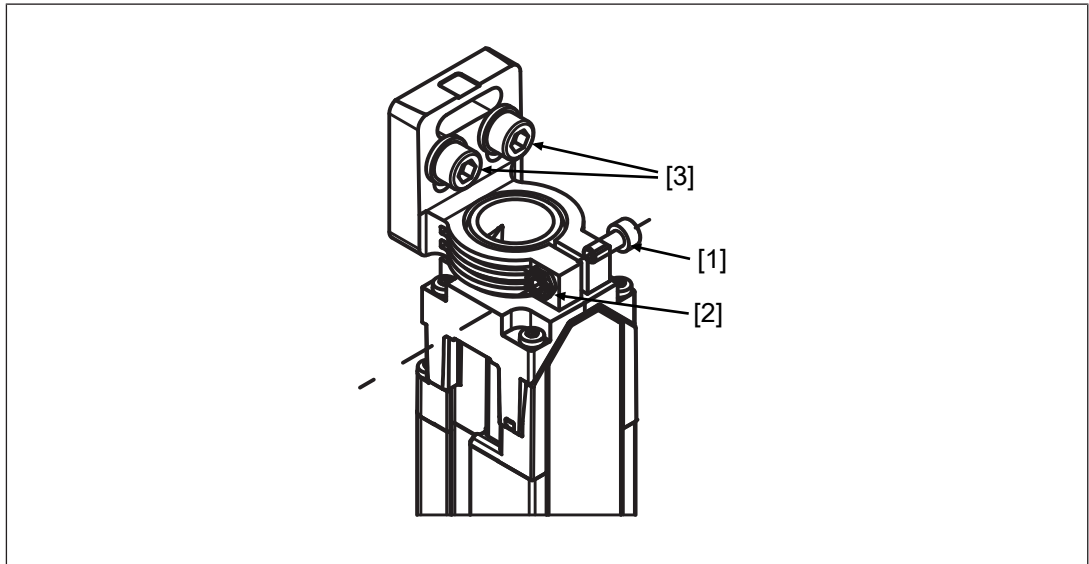



Legend

- [1] Clamping screw
- [2] Nut
- [3] Mounting screws

7 Wiring

7.1 General guidelines

- ▶ Do not lay the connecting cable near or in contact with cables that carry high or highly volatile currents.
- ▶ Use separate cables to connect the wires to the OSSDs on different safety light curtains or safety switches.
- ▶ Do **not** connect contacts OSSD1 and OSSD2 in series or in parallel.
- ▶ For supply voltage, use only PELV/SELV power supplies that have a voltage buffer in accordance with EN 60204-1.
- ▶ The power supply must be able to bridge a short (20 ms) supply voltage failure in accordance with EN 61496-1.
- ▶ SELV power supply
 - Do **not** connect the safety light curtain housing to the earth conductor or the protective conductor. The transmitters and receivers must be electrically isolated from the machine/system. The use of the flexible bracket (swivel mount) provides this electrical isolation.
- ▶ Connection to PDP67
 - Use the order reference of the cable listed (see [Accessories, connection to PDP67](#) [ 72])
- ▶ Connection to other evaluation devices
 - Use the order reference of the cable listed (see [Accessories, connection to other evaluation devices](#) [ 72])
 - The clamps for connection to the evaluation device must be kept in a locked control cabinet. This prevents unauthorised modifications.
- ▶ Ensure compliance with permissible cable bending radii (see [Technical details](#) [ 56]).

7.2 Connector pin assignment

Transmitter and receiver electrical connections are made with M12 connectors. These connectors are located on the bottom of the transmitters and receivers.

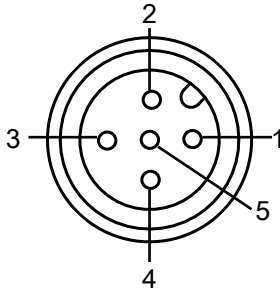
5-pin connector on the transmitter	PIN	Assignment	Cable colour
	1	uncoded: +24 VDC	brown
		A-coded: +24 V DC	
		B-coded: 0 V DC	
	2	Reserved	white
	3	0 VDC	blue
	4	Reserved	black
5	uncoded: +24 VDC	grey	
	A-coded: 0 V DC		
	B-coded: +24 V DC		

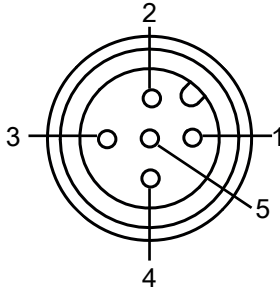
5-pin connector on the receiver	PIN	Assignment	Cable colour
	1	uncoded: +24 VDC	brown
		A-coded: +24 V DC	
		B-coded: 0 V DC	
	2	OSSD 1	white
	3	0 VDC	blue
	4	OSSD 2	black
5	uncoded: +24 VDC	grey	
	A-coded: 0 V DC		
	B-coded: +24 V DC		

► Ensure that the wiring is performed as stated in the truth table.

Receiver/transmitter	Pin	Uncoded	A-coded	B-coded
Receiver	1	24 V	24 V	0 V
	3	0 V	0 V	0 V
	5	24 V	0 V	24 V
Transmitter	1	24 V	24 V	0 V
	3	0 V	0 V	0 V
	5	24 V	0 V	24 V

Truth table for checking the pin assignment

7.3 Support with wiring

Use the PSEN opII Y Junction M12-M12/M12 for simplified wiring.

With the adapter you can connect transmitter (female connector X1) and receiver (female connector X2) to an M12 port (2FDI) on an evaluation device (male connector X3).

► Example: Implementation of rear access protection

Use the adapters to connect the transmitter and receiver on the safety light curtains to an evaluation unit, as shown.

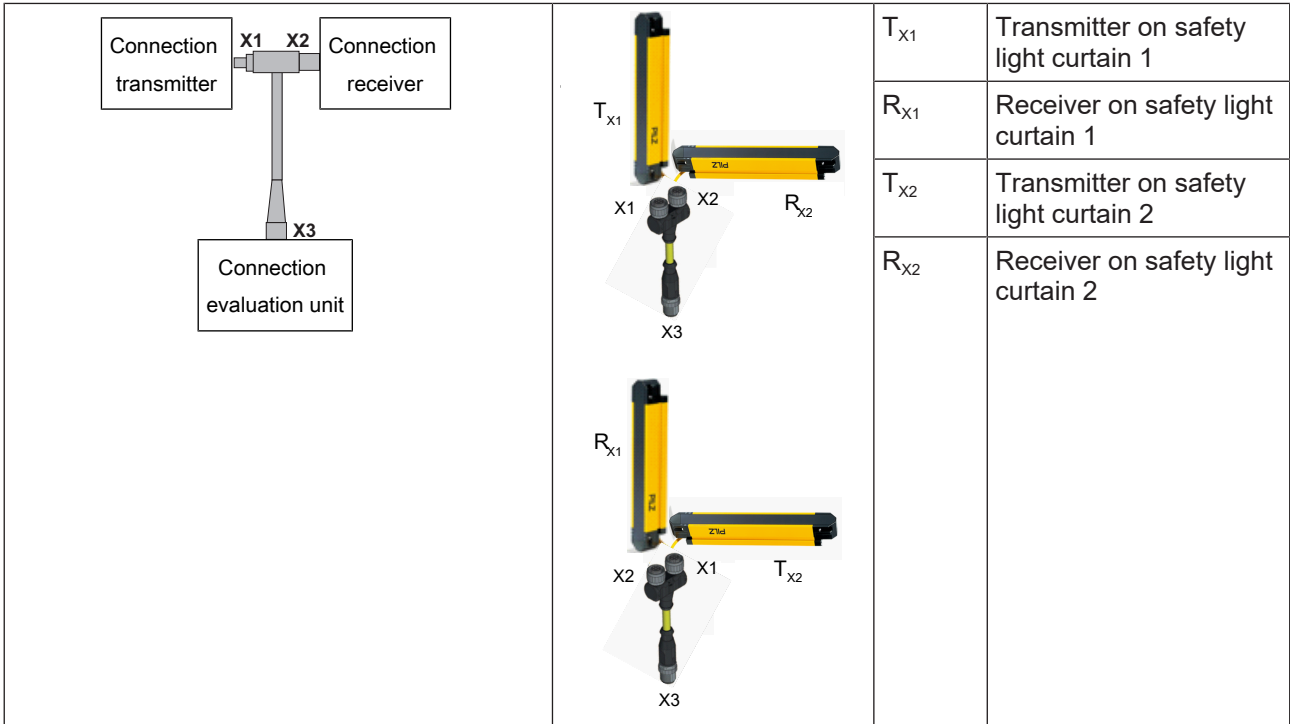

► Example: install parallel-aligned safety light curtains next to each another

Use the adapters to connect the transmitter and receiver on the safety light curtains to an evaluation unit, as shown.

Details of how to determine the minimum distances are described in: [Minimum distance between parallel-aligned safety light curtains \[27\]](#)

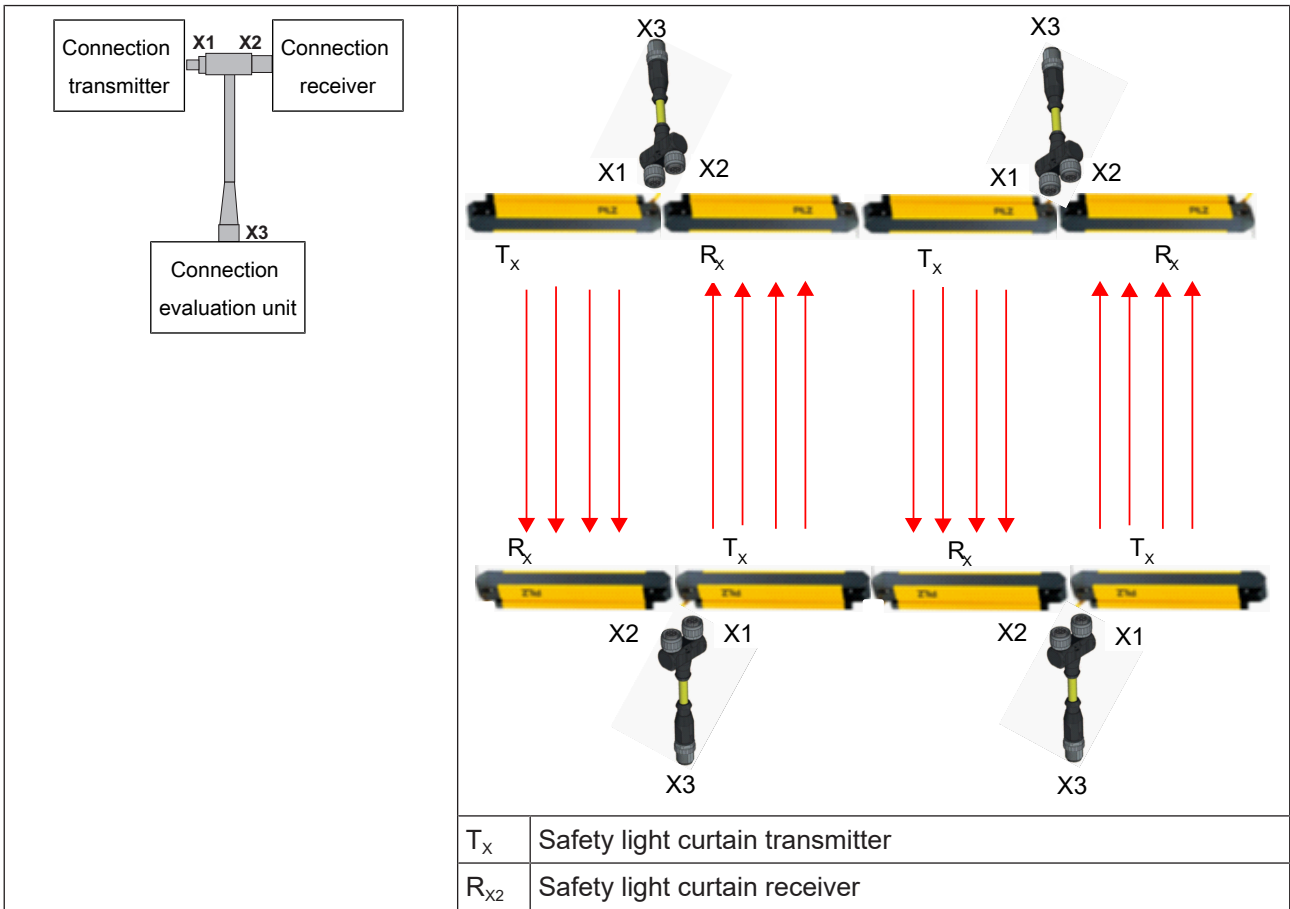

► Example: save on cable when making connections in the control cabinet

Use the adapter to connect the transmitter and receiver on the safety light curtains to an evaluation unit in a remotely installed control cabinet, as shown.

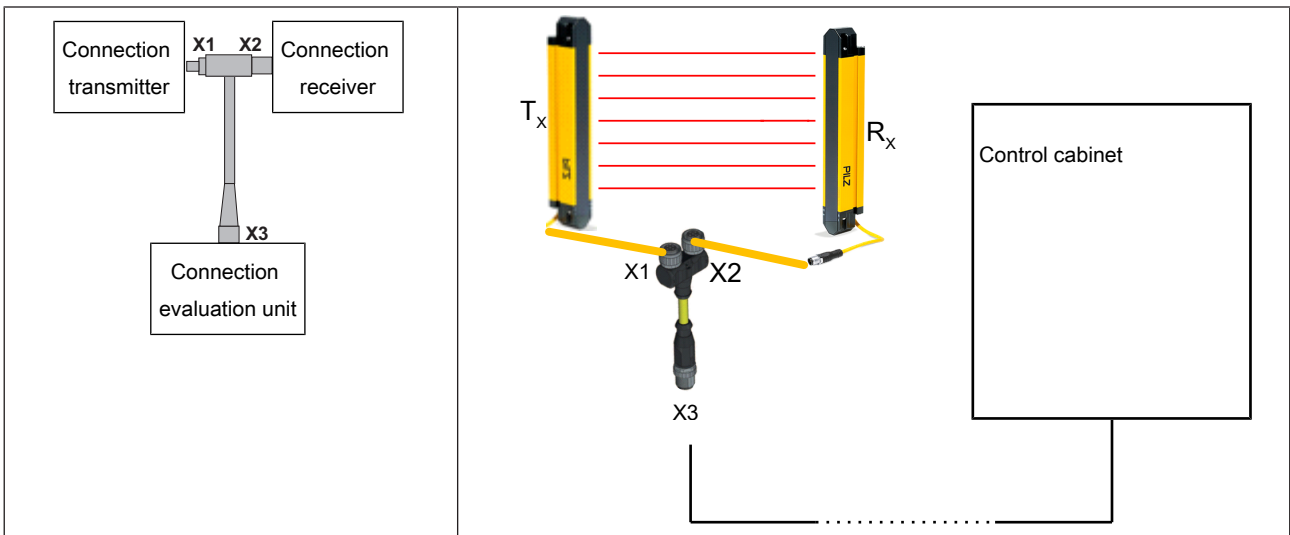

8 Commissioning

8.1 System connection

Make sure that the selected evaluation device has the following properties:

- ▶ 2-channel with feasibility monitoring
- ▶ OSSD signals are evaluated
- ▶ A test pulse lasting no longer than 300 µs is bridged

Suitable Pilz evaluation devices are, for example:

- ▶ PNOZelog for monitoring safety light curtains
- ▶ PNOZsigma for monitoring safety light curtains
- ▶ PNOZ X for monitoring safety light curtains
- ▶ PDP67 ION and PDP67 ION HP
 - Connect the OSSDs on the receiver to pins 2 and 4 on the PDP67 ION.
 - Ensure that pins 1 and 5 on the PDP67 ION are used as an ST output.
 - Make the connection using one of the cables listed in the order reference (see [Order reference for accessories, connection to PDP67](#)  72]).
- ▶ PNOZmulti for safety light curtain monitoring
Configure the safety light curtain in the PNOZmulti Configurator with switch type 3.
- ▶ Automation system PSS 4000 for monitoring safety light curtains with the FS_LightCurtain function block

The correct connection to the respective evaluation device is described in the operating manual for the evaluation device. Connect the evaluation device according to the specifications in the selected evaluation device's operating manual.

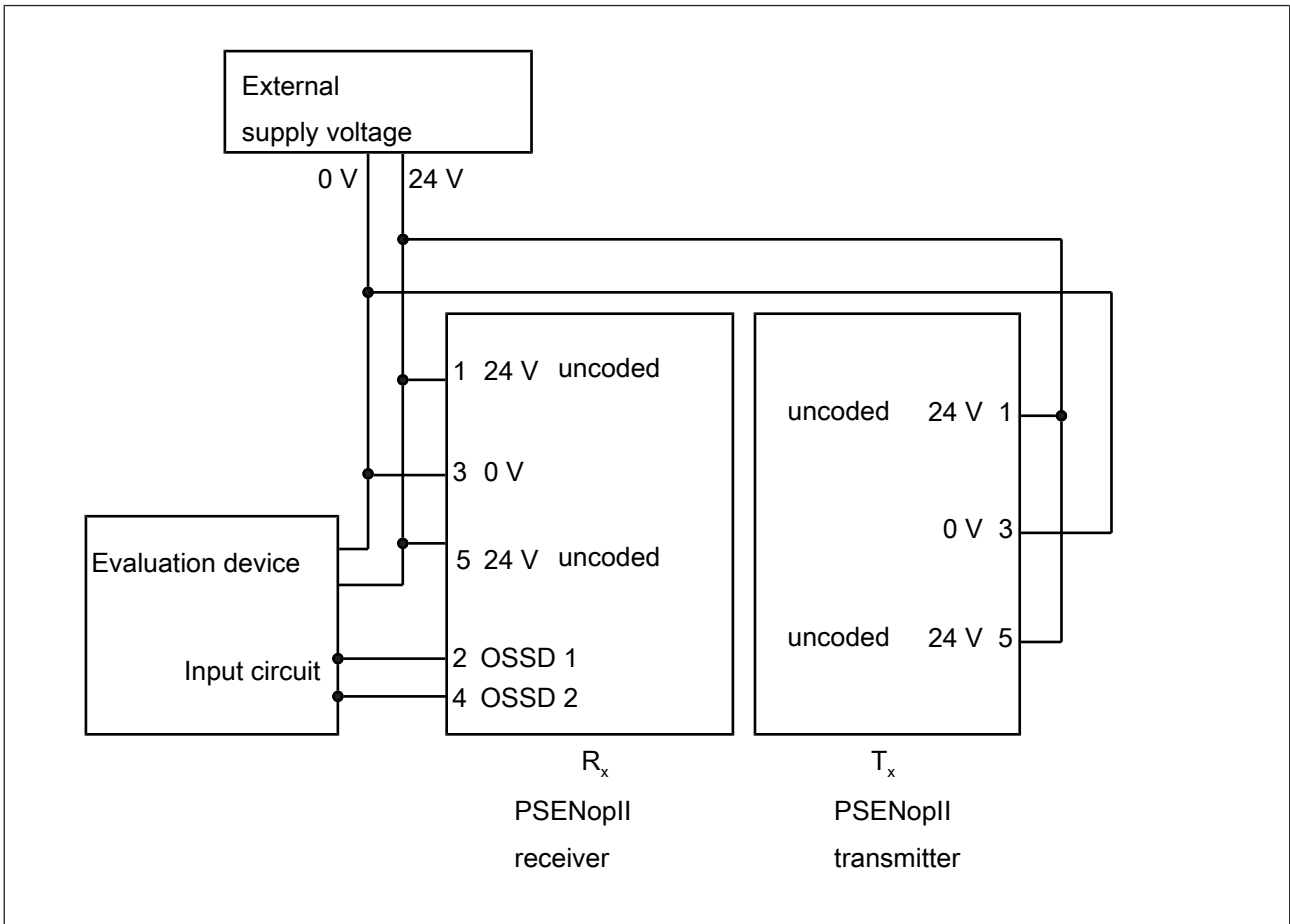

Fig.: Dual-channel connection of an uncoded safety light curtain at the input circuit of an evaluation device



WARNING!

Hazard due to loss of the safety function

When calculating the safety distance, remember the extended response time when using beam coding (see [Technical details \[56\]](#)).

Changing from uncoded to coded operation is a change to the safety light curtain and requires a new risk assessment and hazard analysis.

- Perform a new risk assessment and hazard analysis and determine the new [minimum distance \[18\]](#) to the danger zone with the extended response time.



CAUTION!

When considering the examples, please note that Pilz accepts no responsibility for the specific application. In particular, they may not be used without testing and approval.

The system manufacturer is responsible for creating appropriate safety concepts for the overall plant and for connection to the programmable safety system (including the user program). The applicable standards and regulations must be considered and observed.

8.2 Checking the safety light curtain

Once the safety light grid has been installed and aligned, final inspections must be carried out before it can be put into service.



INFORMATION

This inspection may only be carried out by qualified personnel.

Check the safety function of the safety light curtain

Procedure

In each of the indicated checks, the OSSDs must switch to the OFF state.

The OSSD status LED  on the left side of the receiver must illuminate red.



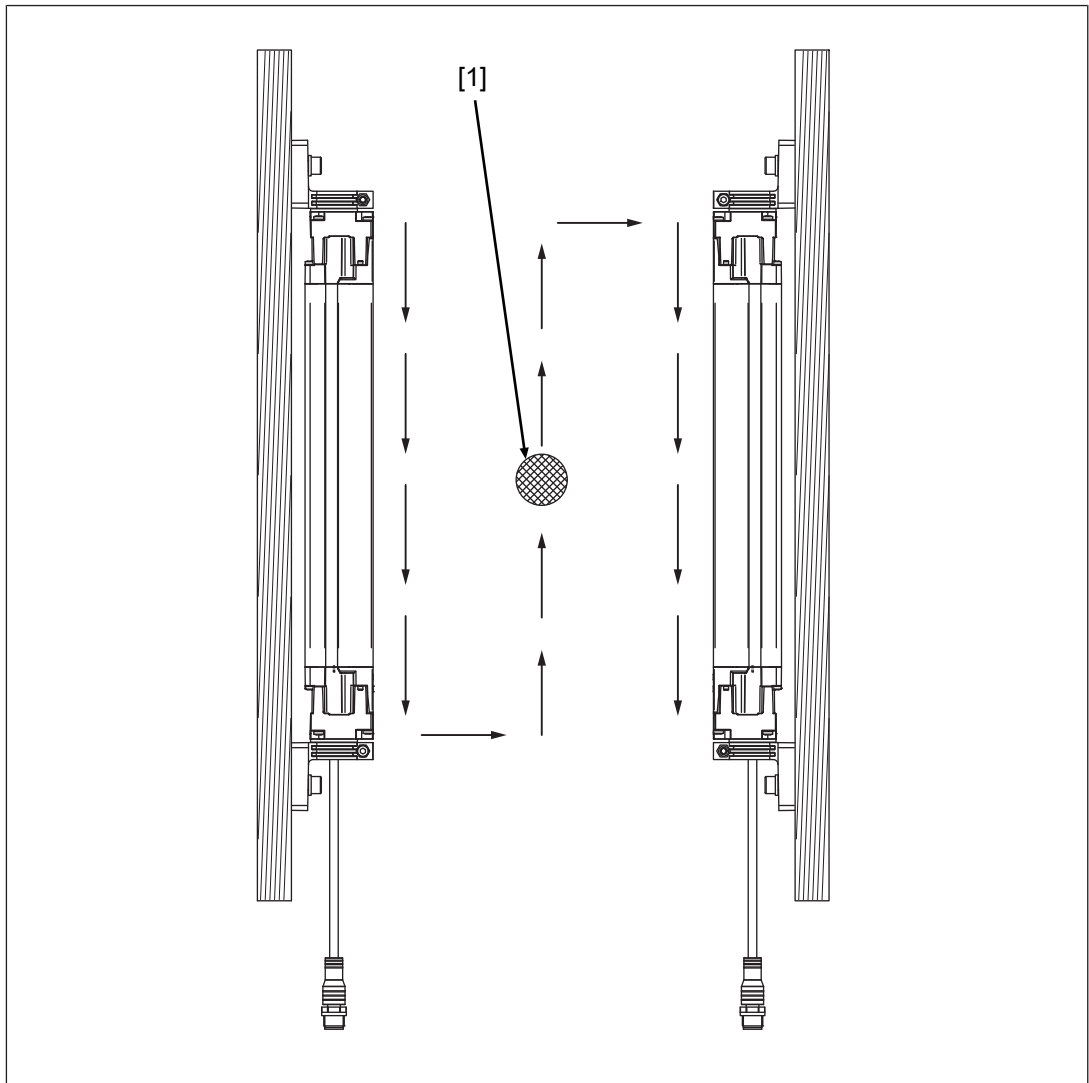

1. Move the test rod slowly through the protected field (see diagram):
 - In the vicinity of the transmitter
 - In the vicinity of the receiver
 - In the centre of the protected field
2. Place the test rod at rest in a position in the protected field that is considered critical for the safety assessment results



Legend

[1] Test rod





Check ambient conditions and installation

- ▶ **Correct alignment and attachment**
Check the seating of the mounting screws by applying pressure to the edges of the safety light curtain. Neither the device status LED  of the transmitter nor that of the receiver may illuminate.
- ▶ **Safety distance**
The safety distance must comply with the requirements in [Maintaining the safety distance](#) [ 18].
- ▶ **Circumventing the protected field**
The danger zone must be secured so that it is impossible to access by circumventing the protected field.
- ▶ **Protected field perimeters**
The protected field perimeters (see [Dimensions](#) [ 55]) must completely secure the hazardous area, making it inaccessible.
- ▶ **Response and stopping times must fulfil the requirements in Maintaining the safety distance**
Ensure that the safety light curtain's response time and the machine's stopping time fulfil the requirements in [Maintaining the safety distance](#).
- ▶ **Check beam coding**
Is beam coding displayed correctly at the receiver (see [Checking of safety light curtains with beam coding](#) [ 52])?
- ▶ **No intense or flashing light sources in the vicinity**
There may be no especially intense or flashing light sources in the vicinity of the safety light grid.
- ▶ **Ambient conditions**
Please observe the [environmental conditions](#) [ 23].
- ▶ **Use of deviating mirrors**
Check all areas that are bounded by a deviating mirror.



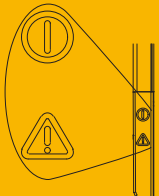

9 Operation

9.1 Display elements

The safety light curtain's operating status is indicated with LEDs in the end caps of the connection side of the receiver and on the transmitter.

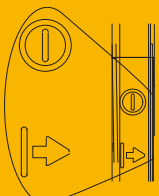
			
	Device status		<ul style="list-style-type: none"> ▶ Reception quality: <ul style="list-style-type: none"> – III: Best quality – I: Worst quality ▶ Status of the beam coding when the protected field is interrupted
	OSSD status (protected field LED)		

LED indicator on the receiver

			
	Device status		<ul style="list-style-type: none"> ▶ Status of the beam coding during normal operation ▶ Light beam error information
	<ul style="list-style-type: none"> ▶ Light beam status ▶ Status of the beam coding during normal operation 		

LED indicators on the transmitter



INFORMATION



The reception quality also depends on the distance.

If the distance between sender and receiver is near the max. operating range, it is not possible to achieve a very high reception quality even with optimum alignment.













































However, the safety light curtain can be operated with low reception quality when the alignment is performed as described in [Safety light curtain alignment \[37\]](#).

























9.2 Status information

Legend

















-  LED on
-  LED flashes
-  LED off





















Displays on the receiver

					Meaning
 Green	 Green				Ready for operation The current reception quality status is indicated
 Green	 Red	 Green	 Green	 Green	
 Green	 Red				Protected field is interrupted, Uncoded
 Green	 Red	 Green			Protected field is interrupted, A-coded
 Green	 Red		 Green		Protected field is interrupted, B-coded
 Red	 Red				OSSD fault Restart [51] the safety light curtain.
 Red	 Red				
 Green	 Green	 Green	 Green	 Green	Stray light warning Warns of the OSSDs' change to the OFF state due to the presence of stray light.

					Meaning
 Green	 Red	 Green	 Green	 Green	<p>Stray light fault OSSDs have changed to the OFF state due to the presence of stray light.</p> <ol style="list-style-type: none"> 1. Use the beam coding of the safety light curtain. 2. Install an opaque surface on the side facing the stray light source or reverse the positions of the safety light curtain's transmitter and receiver. 3. Restart  51 the safety light curtain.
 Red	 Red	 Green	 ●	 ●	<p>Overtemperature; OSSD in the OFF state</p> <ol style="list-style-type: none"> 1. Ensure that the ambient temperature corresponds to the information in the Technical details  56]. 2. Restart  51 the safety light curtain.
 Red	 Red	 ●	 Green	 ●	<p>Undervoltage; OSSD in the OFF state</p> <ol style="list-style-type: none"> 1. Ensure that the supply voltage corresponds to the information in the Technical details  56]. 2. Restart  51 the safety light curtain.

Indicators on the transmitter

				Meaning
 green	 red	 green	 green	Safety light curtain is started
 green	 green	 ●	 ●	Safety light curtain in operation Transmitter sends uncoded
 green	 green	 green	 ●	Safety light curtain in operation Transmitter sends A-coded

				Meaning
 green	 green		 green	Safety light curtain in operation Transmitter sends B-coded
 red	 red			An error has occurred. Perform a safety light curtain restart [51] .
 red	 red	 green		Overtemperature; OSSD in the OFF state 1. Ensure that the ambient temperature corresponds to the information in the Technical details [56] . 2. Perform a safety light curtain restart [51] .
 red	 red		 green	Undervoltage; OSSD in the OFF state 1. Ensure that the supply voltage corresponds to the information in the Technical details [56] . 2. Perform a safety light curtain restart [51] .

9.3 Safety light grid restart

⇒ Disconnect the voltage supply from the safety light curtain, then reconnect the safety light curtain back to the voltage supply. The safety light curtains [start automatically \[16\]](#).

9.4 Malfunction



WARNING!

Loss of safety function due to a malfunction of the safety light curtain

A safety light curtain malfunction may lead to serious injury or death.

If there is a safety light curtain malfunction, immediately discontinue operation of the system components whose danger zone the grid secures.



10 Regular checks and maintenance

10.1 Checks

Regular checks can bring to light changes to the plant/machine, safeguards and ambient conditions.

10.1.1 Regular check

Pilz recommends that the safety light curtain be checked every six months.

- ▶ Check the safety light curtain's front panel.
 - Scratched front panel: Replace the safety light curtain.
 - Dirty front panel: [Clean the front panel](#)  54].
In a particularly dirty environment, front panel cleanliness should be checked more frequently.
- ▶ Check the tightness of the safety light curtain's front panel.
All screws must be tightened to the torque specified in the [Technical details](#)  56].
- ▶ Check the safety function of the safety light curtain (see [Check the safety function of the safety light curtain](#)  52]).

10.1.2 Checking of safety light curtains with beam coding

When switching on the safety light curtains, the correct function of the coding must be checked.













INFORMATION

















This inspection may only be carried out by qualified personnel.

The following LEDs must light after switching on:

Receiver

Status					
Ready for operation	 green	 green			
The current reception quality status is indicated.					















Transmitter

Status				
Safety light curtain in operation Transmitter sends uncoded	 green	 green		
Safety light curtain in operation Transmitter sends A-coded	 green	 green	 green	
Safety light curtain in operation Transmitter sends B-coded	 green	 green		 green

Check whether the coding corresponds to the specifications in [Installation of several adjacent safety light curtains](#) [29].

Check the [pin assignment](#) [40], when other displays can be seen at the safety light curtain.

Interrupt the protected field. The following LED must light at the receiver:

					Meaning
 green	 red	 green			Protected field is interrupted, A-coded
 green	 red		 green		Protected field is interrupted, B-coded

10.1.3 Check after plant/machine modification

Check the safety light curtain each time the plant/machine is modified.

The following measures should also be regarded as a modification:

- ▶ The exchange of the safety light curtain
- ▶ The exchange of components of the safety light curtain
- ▶ A changed connection of the safety light curtain (change from uncoded connection to coded connection).

You **must** comply with the requirements of the applicable national regulations.



INFORMATION

This inspection may only be carried out by qualified personnel.

The Appendix contains a [Checklist](#)  79] which should help you perform the safety check.

10.2 Maintenance

Other than cleaning the lens covers, the safety light curtains requires no other form of maintenance.



CAUTION!

Improper cleaning agents can damage the safety light curtain and lead to malfunctions.

Moist cotton cloths should be used for cleaning.

Avoid using

- ▶ Alcohol,
- ▶ Solvents,
- ▶ Cloths made of wool,
- ▶ Cloths made of synthetic material.

Clean the lens covers during the regular [check of the safety light curtain](#)  52].

11 Dimensions

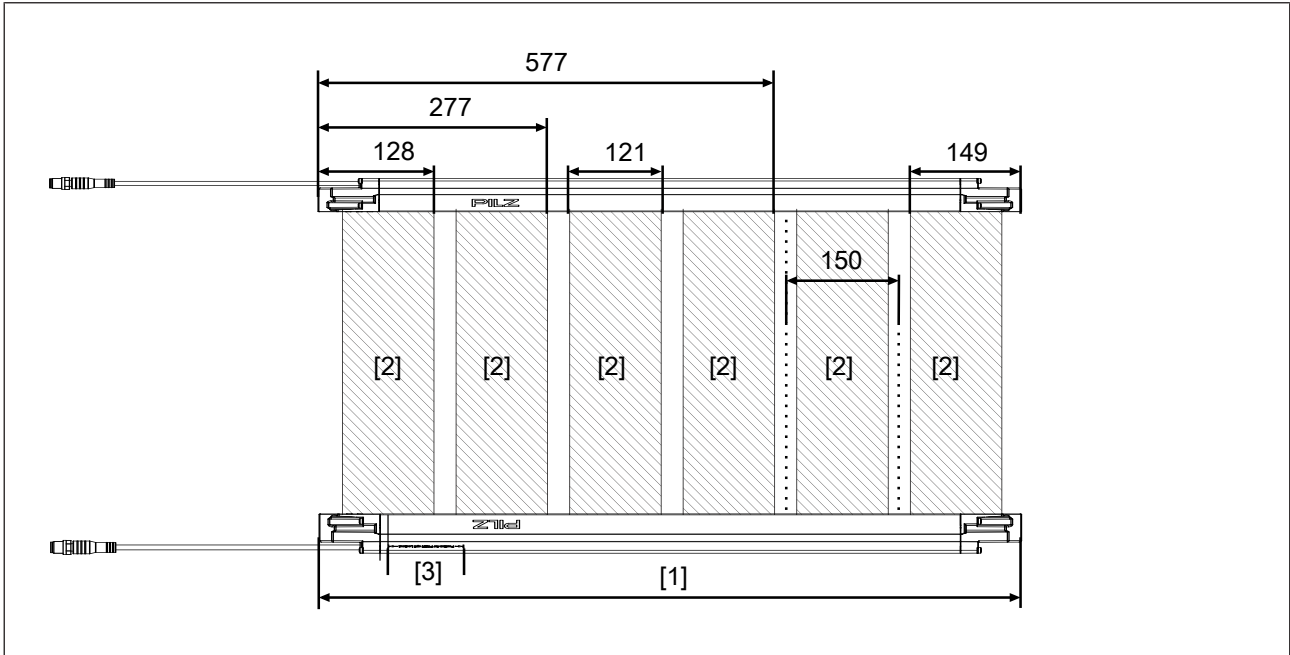

Fig.: Front view of safety light curtain with 300 mm resolution, transmitter and receiver, protected field height 450 – 1500 mm

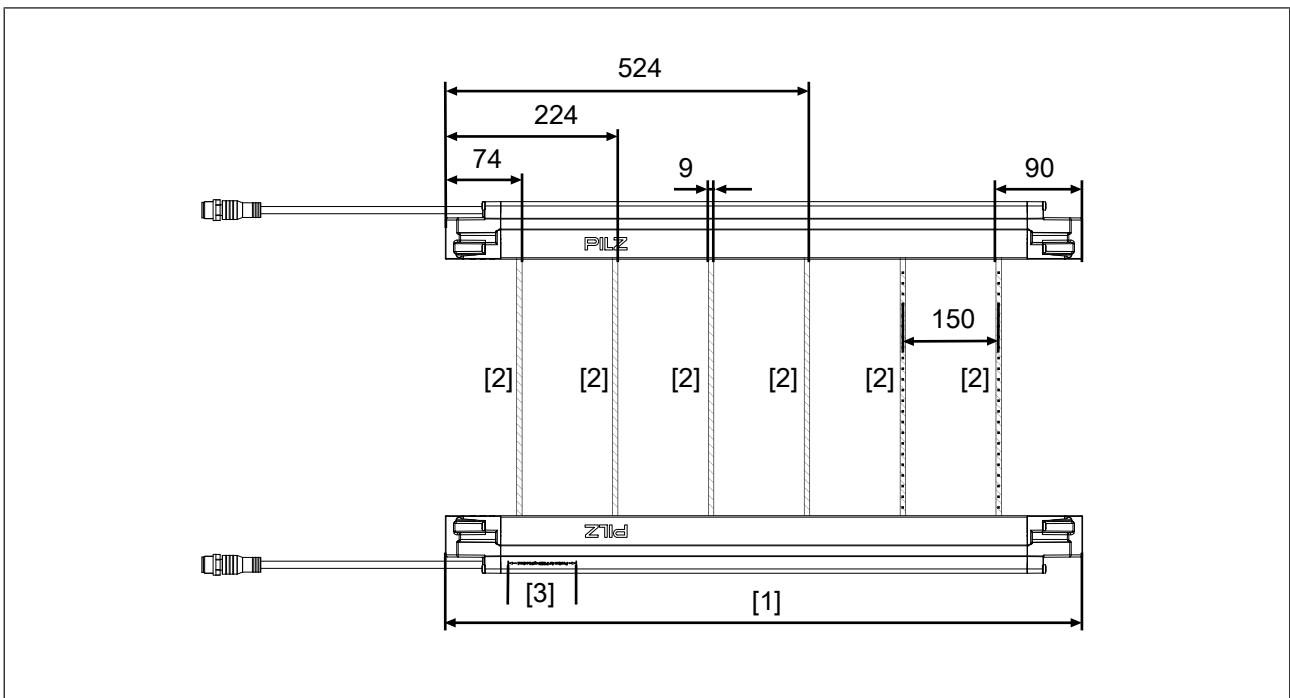

Fig.: Front view of safety light curtain with 170 mm resolution, transmitter and receiver, protected field height 450 – 1500 mm with connection cable

Legend

- [1] Total length of transmitter (without cable) ± 3 mm
- [2] Light beams
- [3] Marking on the receiver for the position of PSEN opII lockout

12 Technical details Order no. 632100-632102

General	632100	632101	632102
Certifications	CE, EAC, KCs, TÜV, UKCA, cULus Listed	CE, EAC, KCs, TÜV, UKCA, cULus Listed	CE, EAC, KCs, TÜV, UKCA, cULus Listed
ESPE type	3	3	3
Sensor's mode of operation	Infrared	Infrared	Infrared
Protected field height	450 mm	600 mm	750 mm
Resolution			
Protection type	Object	Object	Object
Operating range	0,2 - 15 m	0,2 - 15 m	0,2 - 15 m
Detection capability	170 mm	170 mm	170 mm
Electrical data	632100	632101	632102
Supply voltage			
Voltage	24 V	24 V	24 V
Kind	DC	DC	DC
Voltage tolerance	-25 %/+20 %	-25 %/+20 %	-25 %/+20 %
Residual ripple DC	5 %	5 %	5 %
Max. power consumption OSSD in the OFF state	2,5 W	2,5 W	2,5 W
Max. voltage OSSD in the OFF state	0,2 V	0,2 V	0,2 V
Max. power consumption transmitter	1,5 W	1,5 W	1,5 W
Max. inductive load per output	1 H	1 H	1 H
Protection class	3	3	3
Beam coding	Yes	Yes	Yes
Optical data	632100	632101	632102
Opening angle	-3,5 - 3,5 deg	-3,5 - 3,5 deg	-3,5 - 3,5 deg
Used wavelength range	850 nm	850 nm	850 nm
No. of beams	3	4	5
Semiconductor outputs	632100	632101	632102
OSSD safety outputs	2	2	2
Switching current per output	100 mA	100 mA	100 mA
Residual current at "0" signal	0,1 mA	0,1 mA	0,1 mA
Voltage drop at OSSDs	1,5 V	1,5 V	1,5 V
Max. cable capacitance at the outputs without load	40 nF	40 nF	40 nF
Times	632100	632101	632102
Max. test pulse duration, safety outputs	300 µs	300 µs	300 µs
Supply interruption before de-energisation	600 µs	600 µs	600 µs

Times	632100	632101	632102
Response time t1	5,2 ms	5,2 ms	5,2 ms
Response time (with beam coding)	11,7 ms	11,7 ms	11,7 ms
Resynchronisation time uncoded	0,17 s	0,17 s	0,17 s
Resynchronisation time coded	0,6 s	0,6 s	0,6 s
Environmental data	632100	632101	632102
Ambient temperature			
Temperature range	-25 - 60 °C	-25 - 60 °C	-25 - 60 °C
Storage temperature			
Temperature range	-40 - 70 °C	-40 - 70 °C	-40 - 70 °C
Climatic suitability			
Humidity	95 % r. h. at 50 °C	95 % r. h. at 50 °C	95 % r. h. at 50 °C
Condensation during operation	Not permitted	Not permitted	Not permitted
Max. operating height above SL	2000 m	2000 m	2000 m
EMC	IEC 61496-1	IEC 61496-1	IEC 61496-1
Vibration			
in accordance with the standard	EN 60068-2-6	EN 60068-2-6	EN 60068-2-6
Frequency	10 - 150 Hz	10 - 150 Hz	10 - 150 Hz
Amplitude	0,75 mm	0,75 mm	0,75 mm
Acceleration	0,2g	0,2g	0,2g
Shock stress			
in accordance with the standard	EN 60068-2-27	EN 60068-2-27	EN 60068-2-27
Bracket	Adv Bracket Kit	Adv Bracket Kit	Adv Bracket Kit
Number of shocks	1000	1000	1000
Acceleration	40g	40g	40g
Duration	6 ms	6 ms	6 ms
in accordance with the standard	EN 60068-2-27	EN 60068-2-27	EN 60068-2-27
Bracket	Adv Bracket Kit	Adv Bracket Kit	Adv Bracket Kit
Number of shocks	3	3	3
Acceleration	50g	50g	50g
Duration	11 ms	11 ms	11 ms
in accordance with the standard	EN 60068-2-27	EN 60068-2-27	EN 60068-2-27
Bracket	Swivel-Mount	Swivel-Mount	Swivel-Mount
Number of shocks	1000	1000	1000
Acceleration	10g	10g	10g
Duration	16 ms	16 ms	16 ms
Protection type			
Housing	IP65	IP65	IP65

Mechanical data	632100	632101	632102
Min. bending radius (fixed permanently) K1	5 x Ø	5 x Ø	5 x Ø
Min. bending radius (moving) K1	10 x Ø	10 x Ø	10 x Ø
Connection type			
Receiver	M12, 5-pin male connector	M12, 5-pin male connector	M12, 5-pin male connector
Transmitter	M12, 5-pin male connector	M12, 5-pin male connector	M12, 5-pin male connector
Max. cable length	50 m	50 m	50 m
Material			
Housing	Aluminium	Aluminium	Aluminium
End caps	Zn	Zn	Zn
Front screen	PC	PC	PC
Max. torque setting			
Clamping screw	1,1 Nm	1,1 Nm	1,1 Nm
Installation screw	3 Nm	3 Nm	3 Nm
Fixing screw	0,7 Nm	0,7 Nm	0,7 Nm
Dimensions			
Height	454 mm	604 mm	754 mm
Width	35 mm	35 mm	35 mm
Depth	40 mm	40 mm	40 mm
Weight	1.413 g	1.815 g	2.218 g

Where standards are undated, the 2020-07 latest editions shall apply.

13 Technical details Order no. 632103-632105

General	632103	632104	632105
Certifications	CE, EAC, KCs, TÜV, UKCA, cULus Listed	CE, EAC, KCs, TÜV, UKCA, cULus Listed	CE, EAC, KCs, TÜV, UKCA, cULus Listed
ESPE type	3	3	3
Sensor's mode of operation	Infrared	Infrared	Infrared
Protected field height	900 mm	1.200 mm	1.500 mm
Resolution			
Protection type	Object	Object	Object
Operating range	0,2 - 15 m	0,2 - 15 m	0,2 - 15 m
Detection capability	170 mm	170 mm	170 mm
Electrical data	632103	632104	632105
Supply voltage			
Voltage	24 V	24 V	24 V
Kind	DC	DC	DC
Voltage tolerance	-25 %/+20 %	-25 %/+20 %	-25 %/+20 %
Residual ripple DC	5 %	5 %	5 %
Max. power consumption OSSD in the OFF state	2,5 W	2,5 W	2,5 W
Max. voltage OSSD in the OFF state	0,2 V	0,2 V	0,2 V
Max. power consumption transmitter	1,5 W	1,5 W	1,5 W
Max. inductive load per output	1 H	1 H	1 H
Protection class	3	3	3
Beam coding	Yes	Yes	Yes
Optical data	632103	632104	632105
Opening angle	-3,5 - 3,5 deg	-3,5 - 3,5 deg	-3,5 - 3,5 deg
Used wavelength range	850 nm	850 nm	850 nm
No. of beams	6	8	10
Semiconductor outputs	632103	632104	632105
OSSD safety outputs	2	2	2
Switching current per output	100 mA	100 mA	100 mA
Residual current at "0" signal	0,1 mA	0,1 mA	0,1 mA
Voltage drop at OSSDs	1,5 V	1,5 V	1,5 V
Max. cable capacitance at the outputs without load	40 nF	40 nF	40 nF
Times	632103	632104	632105
Max. test pulse duration, safety outputs	300 µs	300 µs	300 µs
Supply interruption before de-energisation	600 µs	600 µs	600 µs

Times	632103	632104	632105
Response time t1	5,2 ms	5,2 ms	5,4 ms
Response time (with beam coding)	11,7 ms	11,7 ms	11,7 ms
Resynchronisation time uncoded	0,17 s	0,17 s	0,18 s
Resynchronisation time coded	0,6 s	0,6 s	0,6 s
Environmental data	632103	632104	632105
Ambient temperature			
Temperature range	-25 - 60 °C	-25 - 60 °C	-25 - 60 °C
Storage temperature			
Temperature range	-40 - 70 °C	-40 - 70 °C	-40 - 70 °C
Climatic suitability			
Humidity	95 % r. h. at 50 °C	95 % r. h. at 50 °C	95 % r. h. at 50 °C
Condensation during operation	Not permitted	Not permitted	Not permitted
Max. operating height above SL	2000 m	2000 m	2000 m
EMC	IEC 61496-1	IEC 61496-1	IEC 61496-1
Vibration			
in accordance with the standard	EN 60068-2-6	EN 60068-2-6	EN 60068-2-6
Frequency	10 - 150 Hz	10 - 150 Hz	10 - 150 Hz
Amplitude	0,75 mm	0,75 mm	0,75 mm
Acceleration	0,2g	0,2g	0,2g
Shock stress			
in accordance with the standard	EN 60068-2-27	EN 60068-2-27	EN 60068-2-27
Bracket	Adv Bracket Kit	Adv Bracket Kit	Adv Bracket Kit
Number of shocks	1000	1000	1000
Acceleration	40g	40g	40g
Duration	6 ms	6 ms	6 ms
in accordance with the standard	EN 60068-2-27	EN 60068-2-27	EN 60068-2-27
Bracket	Adv Bracket Kit	Adv Bracket Kit	Adv Bracket Kit
Number of shocks	3	3	3
Acceleration	50g	50g	50g
Duration	11 ms	11 ms	11 ms
in accordance with the standard	EN 60068-2-27	EN 60068-2-27	EN 60068-2-27
Bracket	Swivel-Mount	Swivel-Mount	Swivel-Mount
Number of shocks	1000	1000	1000
Acceleration	10g	10g	10g
Duration	16 ms	16 ms	16 ms
Protection type			
Housing	IP65	IP65	IP65

Mechanical data	632103	632104	632105
Min. bending radius (fixed permanently) K1	5 x Ø	5 x Ø	5 x Ø
Min. bending radius (moving) K1	10 x Ø	10 x Ø	10 x Ø
Connection type			
Receiver	M12, 5-pin male connector	M12, 5-pin male connector	M12, 5-pin male connector
Transmitter	M12, 5-pin male connector	M12, 5-pin male connector	M12, 5-pin male connector
Max. cable length	50 m	50 m	50 m
Material			
Housing	Aluminium	Aluminium	Aluminium
End caps	Zn	Zn	Zn
Front screen	PC	PC	PC
Max. torque setting			
Clamping screw	1,1 Nm	1,1 Nm	1,1 Nm
Installation screw	3 Nm	3 Nm	3 Nm
Fixing screw	0,7 Nm	0,7 Nm	0,7 Nm
Dimensions			
Height	904 mm	1.204 mm	1.504 mm
Width	35 mm	35 mm	35 mm
Depth	40 mm	40 mm	40 mm
Weight	2.621 g	3.426 g	4.232 g

Where standards are undated, the 2020-07 latest editions shall apply.

14 Technical details Order no. 632110-632112

General	632110	632111	632112
Certifications	CE, EAC, KCs, TÜV, UKCA, cULus Listed	CE, EAC, KCs, TÜV, UKCA, cULus Listed	CE, EAC, KCs, TÜV, UKCA, cULus Listed
ESPE type	3	3	3
Sensor's mode of operation	Infrared	Infrared	Infrared
Protected field height	450 mm	600 mm	750 mm
Resolution			
Protection type	Object	Object	Object
Operating range	10 - 55 m	10 - 55 m	10 - 55 m
Detection capability	300 mm	300 mm	300 mm
Electrical data	632110	632111	632112
Supply voltage			
Voltage	24 V	24 V	24 V
Kind	DC	DC	DC
Voltage tolerance	-25 %/+20 %	-25 %/+20 %	-25 %/+20 %
Residual ripple DC	5 %	5 %	5 %
Max. power consumption OSSD in the OFF state	2,5 W	2,5 W	2,5 W
Max. voltage OSSD in the OFF state	0,2 V	0,2 V	0,2 V
Max. power consumption transmitter	1,5 W	1,5 W	1,5 W
Max. inductive load per output	1 H	1 H	1 H
Protection class	3	3	3
Beam coding	Yes	Yes	Yes
Optical data	632110	632111	632112
Opening angle	-3,5 - 3,5 deg	-3,5 - 3,5 deg	-3,5 - 3,5 deg
Used wavelength range	850 nm	850 nm	850 nm
No. of beams	3	4	5
Semiconductor outputs	632110	632111	632112
OSSD safety outputs	2	2	2
Switching current per output	100 mA	100 mA	100 mA
Residual current at "0" signal	0,1 mA	0,1 mA	0,1 mA
Voltage drop at OSSDs	1,5 V	1,5 V	1,5 V
Max. cable capacitance at the outputs without load	40 nF	40 nF	40 nF
Times	632110	632111	632112
Max. test pulse duration, safety outputs	300 µs	300 µs	300 µs
Supply interruption before de-energisation	600 µs	600 µs	600 µs

Times	632110	632111	632112
Response time t1	5,2 ms	5,2 ms	5,2 ms
Response time (with beam coding)	11,7 ms	11,7 ms	11,7 ms
Resynchronisation time uncoded	0,17 s	0,17 s	0,17 s
Resynchronisation time coded	0,6 s	0,6 s	0,6 s
Environmental data	632110	632111	632112
Ambient temperature			
Temperature range	-25 - 60 °C	-25 - 60 °C	-25 - 60 °C
Storage temperature			
Temperature range	-40 - 70 °C	-40 - 70 °C	-40 - 70 °C
Climatic suitability			
Humidity	95 % r. h. at 50 °C	95 % r. h. at 50 °C	95 % r. h. at 50 °C
Condensation during operation	Not permitted	Not permitted	Not permitted
Max. operating height above SL	2000 m	2000 m	2000 m
EMC	IEC 61496-1	IEC 61496-1	IEC 61496-1
Vibration			
in accordance with the standard	EN 60068-2-6	EN 60068-2-6	EN 60068-2-6
Frequency	10 - 150 Hz	10 - 150 Hz	10 - 150 Hz
Amplitude	0,75 mm	0,75 mm	0,75 mm
Acceleration	0,2g	0,2g	0,2g
Shock stress			
in accordance with the standard	EN 60068-2-27	EN 60068-2-27	EN 60068-2-27
Bracket	Adv Bracket Kit	Adv Bracket Kit	Adv Bracket Kit
Number of shocks	1000	1000	1000
Acceleration	40g	40g	40g
Duration	6 ms	6 ms	6 ms
in accordance with the standard	EN 60068-2-27	EN 60068-2-27	EN 60068-2-27
Bracket	Adv Bracket Kit	Adv Bracket Kit	Adv Bracket Kit
Number of shocks	3	3	3
Acceleration	50g	50g	50g
Duration	11 ms	11 ms	11 ms
in accordance with the standard	EN 60068-2-27	EN 60068-2-27	EN 60068-2-27
Bracket	Swivel-Mount	Swivel-Mount	Swivel-Mount
Number of shocks	1000	1000	1000
Acceleration	10g	10g	10g
Duration	16 ms	16 ms	16 ms
Protection type			
Housing	IP65	IP65	IP65

Mechanical data	632110	632111	632112
Min. bending radius (fixed permanently) K1	5 x Ø	5 x Ø	5 x Ø
Min. bending radius (moving) K1	10 x Ø	10 x Ø	10 x Ø
Connection type			
Receiver	M12, 5-pin male connector	M12, 5-pin male connector	M12, 5-pin male connector
Transmitter	M12, 5-pin male connector	M12, 5-pin male connector	M12, 5-pin male connector
Max. cable length	50 m	50 m	50 m
Material			
Housing	Aluminium	Aluminium	Aluminium
End caps	Zn	Zn	Zn
Front screen	PC	PC	PC
Max. torque setting			
Clamping screw	1,1 Nm	1,1 Nm	1,1 Nm
Installation screw	3 Nm	3 Nm	3 Nm
Fixing screw	0,7 Nm	0,7 Nm	0,7 Nm
Dimensions			
Height	454 mm	604 mm	754 mm
Width	35 mm	35 mm	35 mm
Depth	40 mm	40 mm	40 mm
Weight	1.415 g	1.816 g	2.217 g

Where standards are undated, the 2020-07 latest editions shall apply.

15 Technical details Order no. 632113-632115

General	632113	632114	632115
Certifications	CE, EAC, KCs, TÜV, UKCA, cULus Listed	CE, EAC, KCs, TÜV, UKCA, cULus Listed	CE, EAC, KCs, TÜV, UKCA, cULus Listed
ESPE type	3	3	3
Sensor's mode of operation	Infrared	Infrared	Infrared
Protected field height	900 mm	1.200 mm	1.500 mm
Resolution			
Protection type	Object	Object	Object
Operating range	10 - 55 m	10 - 55 m	10 - 55 m
Detection capability	300 mm	300 mm	300 mm
Electrical data	632113	632114	632115
Supply voltage			
Voltage	24 V	24 V	24 V
Kind	DC	DC	DC
Voltage tolerance	-25 %/+20 %	-25 %/+20 %	-25 %/+20 %
Residual ripple DC	5 %	5 %	5 %
Max. power consumption OSSD in the OFF state	2,5 W	2,5 W	2,5 W
Max. voltage OSSD in the OFF state	0,2 V	0,2 V	0,2 V
Max. power consumption transmitter	1,5 W	1,5 W	1,5 W
Max. inductive load per output	1 H	1 H	1 H
Protection class	3	3	3
Beam coding	Yes	Yes	Yes
Optical data	632113	632114	632115
Opening angle	-3,5 - 3,5 deg	-3,5 - 3,5 deg	-3,5 - 3,5 deg
Used wavelength range	850 nm	850 nm	850 nm
No. of beams	6	8	10
Semiconductor outputs	632113	632114	632115
OSSD safety outputs	2	2	2
Switching current per output	100 mA	100 mA	100 mA
Residual current at "0" signal	0,1 mA	0,1 mA	0,1 mA
Voltage drop at OSSDs	1,5 V	1,5 V	1,5 V
Max. cable capacitance at the outputs without load	40 nF	40 nF	40 nF
Times	632113	632114	632115
Max. test pulse duration, safety outputs	300 µs	300 µs	300 µs
Supply interruption before de-energisation	600 µs	600 µs	600 µs

Times	632113	632114	632115
Response time t1	5,2 ms	5,2 ms	5,4 ms
Response time (with beam coding)	11,7 ms	11,7 ms	11,7 ms
Resynchronisation time uncoded	0,17 s	0,17 s	0,18 s
Resynchronisation time coded	0,6 s	0,6 s	0,6 s
Environmental data	632113	632114	632115
Ambient temperature			
Temperature range	-25 - 60 °C	-25 - 60 °C	-25 - 60 °C
Storage temperature			
Temperature range	-40 - 70 °C	-40 - 70 °C	-40 - 70 °C
Climatic suitability			
Humidity	95 % r. h. at 50 °C	95 % r. h. at 50 °C	95 % r. h. at 50 °C
Condensation during operation	Not permitted	Not permitted	Not permitted
Max. operating height above SL	2000 m	2000 m	2000 m
EMC	IEC 61496-1	IEC 61496-1	IEC 61496-1
Vibration			
in accordance with the standard	EN 60068-2-6	EN 60068-2-6	EN 60068-2-6
Frequency	10 - 150 Hz	10 - 150 Hz	10 - 150 Hz
Amplitude	0,75 mm	0,75 mm	0,75 mm
Acceleration	0,2g	0,2g	0,2g
Shock stress			
in accordance with the standard	EN 60068-2-27	EN 60068-2-27	EN 60068-2-27
Bracket	Adv Bracket Kit	Adv Bracket Kit	Adv Bracket Kit
Number of shocks	1000	1000	1000
Acceleration	40g	40g	40g
Duration	6 ms	6 ms	6 ms
in accordance with the standard	EN 60068-2-27	EN 60068-2-27	EN 60068-2-27
Bracket	Adv Bracket Kit	Adv Bracket Kit	Adv Bracket Kit
Number of shocks	3	3	3
Acceleration	50g	50g	50g
Duration	11 ms	11 ms	11 ms
in accordance with the standard	EN 60068-2-27	EN 60068-2-27	EN 60068-2-27
Bracket	Swivel-Mount	Swivel-Mount	Swivel-Mount
Number of shocks	1000	1000	1000
Acceleration	10g	10g	10g
Duration	16 ms	16 ms	16 ms
Protection type			
Housing	IP65	IP65	IP65

Mechanical data	632113	632114	632115
Min. bending radius (fixed permanently) K1	5 x Ø	5 x Ø	5 x Ø
Min. bending radius (moving) K1	10 x Ø	10 x Ø	10 x Ø
Connection type			
Receiver	M12, 5-pin male connector	M12, 5-pin male connector	M12, 5-pin male connector
Transmitter	M12, 5-pin male connector	M12, 5-pin male connector	M12, 5-pin male connector
Max. cable length	50 m	50 m	50 m
Material			
Housing	Aluminium	Aluminium	Aluminium
End caps	Zn	Zn	Zn
Front screen	PC	PC	PC
Max. torque setting			
Clamping screw	1,1 Nm	1,1 Nm	1,1 Nm
Installation screw	3 Nm	3 Nm	3 Nm
Fixing screw	0,7 Nm	0,7 Nm	0,7 Nm
Dimensions			
Height	904 mm	1.204 mm	1.504 mm
Width	35 mm	35 mm	35 mm
Depth	40 mm	40 mm	40 mm
Weight	2.618 g	3.420 g	4.221 g

Where standards are undated, the 2020-07 latest editions shall apply.

16 Classification according to ZVEI, CB24I

The following tables describe the classes and specific values of the product interface and the classes of interfaces compatible with it. The classification is described in the ZVEI position paper "Classification of Binary 24 V Interfaces - Functional Safety aspects covered by dynamic testing".

Safe 1-pole HL outputs

Source		Drain	
Safety switch	C2	Evaluation device	C1, C2

Source parameters	Min.	Typ.	Max.
Test impulse duration	-	-	300 μ s
Rated current	-	-	0,1 A
Capacitive load	-	-	40 nF

17 Safety characteristic data



NOTICE

You must comply with the safety characteristic data in order to achieve the required safety level for your plant/machine.

Operating mode	EN ISO 13849-1: 2015 PL	EN ISO 13849-1: 2015 Category	EN IEC 62061 SIL CL/ maximum SIL	EN IEC 62061 PFH _D [1/h]	EN/IEC 61511 SIL	EN/IEC 61511 PFD	EN ISO 13849-1: 2015 T _M [year]
Sensor, 2-channel	PL d	Cat. 3	SIL CL 2	2,00E-07	–	2,00E-03	20

Explanatory notes for the safety-related characteristic data:

- ▶ Safety characteristic data in accordance with EN IEC 62061 and EN/IEC 61511 was calculated based on EN/IEC 61508.
- ▶ T_M is the maximum mission time in accordance with EN ISO 13849-1. The value also applies as the retest interval in accordance with EN/IEC 61508-6 and EN/IEC 61511 and as the proof test interval and mission time in accordance with EN IEC 62061.

All the units used within a safety function must be considered when calculating the safety characteristic data.



INFORMATION

A safety function's SIL/PL values are **not** identical to the SIL/PL values of the units that are used and may be different. We recommend that you use the PAScal software tool to calculate the safety function's SIL/PL values.

18 Order reference

18.1 Order reference for safety light curtains

Product type	Features	Order no.
PSEN opII3B-s-170-045	Safety light curtain for body protection, Resolution 170 mm Protected field height 450 mm	632100
PSEN opII3B-s-170-060	Safety light curtain for body protection, Resolution 170 mm Protected field height 600 mm	632101
PSEN opII3B-s-170-075	Safety light curtain for body protection, Resolution 170 mm Protected field height 750 mm	632102
PSEN opII3B-s-170-090	Safety light curtain for body protection, Resolution 170 mm Protected field height 900 mm	632103
PSEN opII3B-s-170-120	Safety light curtain for body protection, Resolution 170 mm Protected field height 1200 mm	632104
PSEN opII3B-s-170-150	Safety light curtain for body protection, Resolution 170 mm Protected field height 1500 mm	632105
PSEN opII3B-s-300-045	Safety light curtain for body protection, Resolution 300 mm Protected field height 450 mm	632110
PSEN opII3B-s-300-060	Safety light curtain for body protection, Resolution 300 mm Protected field height 600 mm	632111
PSEN opII3B-s-300-075	Safety light curtain for body protection, Resolution 300 mm Protected field height 750 mm	632112
PSEN opII3B-s-300-090	Safety light curtain for body protection, Resolution 300 mm Protected field height 900 mm	632113

Product type	Features	Order no.
PSEN opII3B-s-300-120	Safety light curtain for body protection, Resolution 300 mm Protected field height 1200 mm	632114
PSEN opII3B-s-300-150	Safety light curtain for body protection, Resolution 300 mm Protected field height 1500 mm	632115

18.2 Order reference for accessories

Standard installation kit

Product type	Features	Order No.
PSEN opII Bracket Kit	Standard installation with flexible bracket	632015

Expanded mounting kit

Product type	Features	Order No.
PSEN opII Adv Bracket Kit-2	Four-piece expanded mounting kit with three degrees of freedom for an absence of dead zones for protected field heights from 150 mm up to and including 600 mm (for hand or finger protection) from 450 mm up to and including 600 mm (for body protection)	632016
PSEN opII Adv Bracket Kit-3	Six-piece expanded mounting kit with three degrees of freedom for an absence of dead zones for protected field heights from 750 mm up to and including 1200 mm	632017

Installation material

Product type	Features	Order no.
PSEN opII slot nuts	4 slot nuts for installing accessories to the profile of a PSEN opII light curtain or a PSEN opII protective column	632512

Restart interlock

Product type	Features	Order no.
PSEN opII lockout	Add-on module for a safety light curtain PSEN opII	632510

Laser alignment guide

Product type	Features	Order No.
PSEN opII laser pointer	Laser orientation aid for safety light curtain from the PSEN opII series	632014

Connection to PDP67

Product type	Features	Connector X1	Connector X2	Connector X3	Order no.
PSS67 Cable M12sf M12sm, 3m	3 m	M12, 5-pin female connector, straight	M12, 5-pin male connector, straight		380208
PSS67 Cable M12sf M12sm, 5m	5 m	M12, 5-pin female connector, straight	M12, 5-pin male connector, straight		380209
PSS67 Cable M12sf M12sm, 10m	10 m	M12, 5-pin female connector, straight	M12, 5-pin male connector, straight		380210
PSS67 cable M12-5sf, M12-5sm, 20m	20 m	M12, 5-pin female connector, straight	M12, 5-pin male connector, straight		380220
PSS67 Cable M12sf M12sm, 30m	30 m	M12, 5-pin female connector, straight	M12, 5-pin male connector, straight		380211
PSS67 Cable M12af M12am, 3m	3 m	M12, 5-pin female connector, angled	M12, 5-pin male connector, angled		380212
PSS67 Cable M12af M12am, 5m	5 m	M12, 5-pin female connector, angled	M12, 5-pin male connector, angled		380213
PSS67 Cable M12af M12am, 10m	10 m	M12, 5-pin female connector, angled	M12, 5-pin male connector, angled		380214
PSS67 Cable M12af M12am, 30m	30 m	M12, 5-pin female connector, angled	M12, 5-pin male connector, angled		380215

Connection to other evaluation devices

Product type	Features	Connector X1	Connector X2	Connector X3	Order no.
PSEN op cable axial M12 5-pole 3m	3 m	M12, 5-pin female connector, straight			630310
PSEN op cable axial M12 5-pole 5m	5 m	M12, 5-pin female connector, straight			630311
PSEN op cable axial M12 5-pole 10m	10 m	M12, 5-pin female connector, straight			630312
PSEN cable M12-5sf 20m	20 m	M12, 5-pin female connector, straight			630298
PSEN op cable axial M12 5-pole 30m	30 m	M12, 5-pin female connector, straight			630297

Product type	Features	Connector X1	Connector X2	Connector X3	Order no.
PSEN op cable axial M12 5-pole 50m	50 m	M12, 5-pin female connector, straight			630364
PSEN op cable angle M12 5-pole 3m	3 m	M12, 5-pin female connector, angled			630347
PSEN op cable angle M12 5-pole 5m	5 m	M12, 5-pin female connector, angled			630348
PSEN op cable angle M12 5-pole 10m	10 m	M12, 5-pin female connector, angled			630349
PSEN op cable angle M12 5-pole 30m	30 m	M12, 5-pin female connector, angled			630350
PSEN op cable angle M12 5-pole 50m	50 m	M12, 5-pin female connector, angled			630365
PSEN opII Y Junction M12-M12/M12	Cable separator for PSEN opII	M12, 5-pin female connector	M12, 5-pin female connector	M12, 5-pin male connector	632511

18.2.1 Mirror column set

consisting of

- ▶ PSEN opII mirror column-xxx,
- ▶ PSEN opII adjustable base unit and
- ▶ Floor anchor PSEN screw set mirror column

Product type	Features	Height	Order no.
PSEN opII mirror column-060 Set	with PSEN opII mirror column-060	60 cm	632007
PSEN opII mirror column-090 Set	with PSEN opII mirror column-090	90 cm	632008
PSEN opII mirror column-120 Set	with PSEN opII mirror column-120	120 cm	632009
PSEN opII mirror column-165 Set	with PSEN opII mirror column-165	165 cm	632010

18.2.2 Mirror columns

Individual mirror column (without PSEN opII adjustable base unit)

Product type	Features	Height	Order no.
PSEN opII mirror column-060	Mirror column	60 cm	632032
PSEN opII mirror column-090	Mirror column	90 cm	632033
PSEN opII mirror column-120	Mirror column	120 cm	632034
PSEN opII mirror column-165	Mirror column	165 cm	632035

18.2.3 Protective column sets

consisting of

- ▶ PSEN opII protective column-xxx,
- ▶ PSEN opII adjustable base unit and
- ▶ Floor anchor PSEN screw set mirror column

Product type	Features	Height	Order no.
PSEN opII protective column-060 Set	With protective column PSEN opII protective column-060	60 cm	632505
PSEN opII protective column-090 Set	With protective column PSEN opII protective column-090	90 cm	632506
PSEN opII protective column-120 Set	With protective column PSEN opII protective column-120	120 cm	632507
PSEN opII protective column-165 Set	With protective column PSEN opII protective column-165	165 cm	632508
PSEN opII protective column-195 Set	With protective column PSEN opII protective column-195	195 cm	632509

18.2.4 Protective columns

Protective column individually (without PSEN opII adjustable base unit)

Product type	Features	Height	Order no.
PSEN opII protective column-060	Protective column for safety light curtain	600 mm	632500
PSEN opII protective column-090	Protective column for safety light curtain	900 mm	632501
PSEN opII protective column-120	Protective column for safety light curtain	1200 mm	632502
PSEN opII protective column-165	Protective column for safety light curtain	1650 mm	632503
PSEN opII protective column-195	Protective column for safety light curtain	1950 mm	632504

18.2.5 Muting accessories

Product type	Features	Order no.
PSEN opII L-muting set	<p>Muting set for safety light curtains of the PSEN opIIxx series.</p> <ul style="list-style-type: none"> ▶ 2 x muting sensors PSEN op3.3, ▶ 2 x PSEN op Reflector, ▶ 2 x 1 m cable for muting sensors, ▶ 1 x PSEN opII muting box for connecting the muting sensors, ▶ 1 x muting lamp PIT si2.1, ▶ 1 x muting arm PSEN opII muting arm, ▶ 1 x bracket for muting sensor PSEN opII muting arm bracket kit 	6C000182
PSEN opII T-muting set	<p>Muting set for safety light curtains of the PSEN opIIxx-A series.</p> <ul style="list-style-type: none"> ▶ 4 x muting sensors PSEN op3.3, ▶ 4 x PSEN op Reflector, ▶ 4 x 1 m cable for muting sensors, ▶ 1 x PSEN opII muting box for connecting the muting sensors, ▶ 1 x muting lamp PIT si2.1, ▶ 2 x muting arm PSEN opII muting arm, ▶ 2 x bracket for muting sensor PSEN opII muting arm bracket kit 	6C000183
PSEN opII X-muting set	<p>Muting set for safety light curtains of the PSEN opIIxx series.</p> <ul style="list-style-type: none"> ▶ 2 x muting sensors PSEN op3.3, ▶ 2 x PSEN op Reflector, ▶ 2 x 1 m cable for muting sensors, ▶ 1 x PSEN opII muting box for connecting the muting sensors, ▶ 1 x muting lamp PIT si2.1, ▶ 2 x muting arm PSEN opII muting arm, ▶ 1 x bracket for muting sensor PSEN opII muting arm bracket kit 	6C000184
PSEN opII muting box	<p>Wiring aid for PSEN opII safety light curtains</p> <p>Connection option for 4 muting sensors, muting lamp and pushbuttons for start and override</p>	6C000181
PSEN opII muting arm	2 muting arms for installing muting sensors to sender and receiver of the PSEN opIIxx series	6C000185
PSEN opII muting arm bracket kit	4 attachments for installing muting sensors to muting arms	6C000186

Product type	Features	Order no.
PIT si2.1 LED muting lamp	LED signal lamp for muting mode	620015
PSEN op3.1 Receiver NO/NC M12	Single-channel light beam device, receiver with NO/NC outputs	630831
PSEN op3.2 Emitter M12	Single-channel light beam device, receiver with NO/NC outputs	630832

18.3 Order reference: Component parts

Transmitter

Product type	Features	Order no.
PSEN opII3B-s-170-045 emitter	For safety light curtain for body protection, Resolution 170 mm Protected field height 450 mm	632400
PSEN opII3B-s-170-060 emitter	For safety light curtain for body protection, Resolution 170 mm Protected field height 600 mm	632401
PSEN opII3B-s-170-075 emitter	For safety light curtain for body protection, Resolution 170 mm Protected field height 750 mm	632402
PSEN opII3B-s-170-090 emitter	For safety light curtain for body protection, Resolution 170 mm Protected field height 900 mm	632403
PSEN opII3B-s-170-120 emitter	For safety light curtain for body protection, Resolution 170 mm Protected field height 1200 mm	632404
PSEN opII3B-s-170-150 emitter	For safety light curtain for body protection, Resolution 170 mm Protected field height 1500 mm	632405
PSEN opII3B-s-300-045 emitter	For safety light curtain for body protection, Resolution 300 mm Protected field height 450 mm	632410
PSEN opII3B-s-300-060 emitter	For safety light curtain for body protection, Resolution 300 mm Protected field height 600 mm	632411
PSEN opII3B-s-300-075 emitter	For safety light curtain for body protection, Resolution 300 mm Protected field height 750 mm	632412

Product type	Features	Order no.
PSEN opII3B-s-300-090 emitter	For safety light curtain for body protection, Resolution 300 mm Protected field height 900 mm	632413
PSEN opII3B-s-300-120 emitter	For safety light curtain for body protection, Resolution 300 mm Protected field height 1200 mm	632414
PSEN opII3B-s-300-150 emitter	For safety light curtain for body protection, Resolution 300 mm Protected field height 1500 mm	632415

Receiver

Product type	Features	Order no.
PSEN opII3B-s-170-045 receiver	For safety light curtain for body protection, Resolution 170 mm Protected field height 450 mm	632440
PSEN opII3B-s-170-060 receiver	For safety light curtain for body protection, Resolution 170 mm Protected field height 600 mm	632441
PSEN opII3B-s-170-075 receiver	For safety light curtain for body protection, Resolution 170 mm Protected field height 750 mm	632442
PSEN opII3B-s-170-090 receiver	For safety light curtain for body protection, Resolution 170 mm Protected field height 900 mm	632443
PSEN opII3B-s-170-120 receiver	For safety light curtain for body protection, Resolution 170 mm Protected field height 1200 mm	632444
PSEN opII3B-s-170-150 receiver	For safety light curtain for body protection, Resolution 170 mm Protected field height 1500 mm	632445
PSEN opII3B-s-300-045 receiver	For safety light curtain for body protection, Resolution 300 mm Protected field height 450 mm	632450
PSEN opII3B-s-300-060 receiver	For safety light curtain for body protection, Resolution 300 mm Protected field height 600 mm	632451

Product type	Features	Order no.
PSEN opII3B-s-300-075 receiver	For safety light curtain for body protection, Resolution 300 mm Protected field height 750 mm	632452
PSEN opII3B-s-300-090 receiver	For safety light curtain for body protection, Resolution 300 mm Protected field height 900 mm	632453
PSEN opII3B-s-300-120 receiver	For safety light curtain for body protection, Resolution 300 mm Protected field height 1200 mm	632454
PSEN opII3B-s-300-150 receiver	For safety light curtain for body protection, Resolution 300 mm Protected field height 1500 mm	632455

19 Appendix

19.1 Check list

The checklist below is intended as an aid in for the following work on a safety light curtain of PSEN opII3B Series:

- ▶ commissioning,
- ▶ recommissioning, and
- ▶ running the specified regular check.

Note that the check list is not intended to replace the plant-specific safety analysis required for commissioning/recommissioning, nor the resulting inspections and actions.



INFORMATION

Commissioning, recommissioning and regular inspection may only be carried out by qualified personnel.



We recommend that you keep the completed check list and store it with the machine documentation for reference.

No.	Action	OK	NOT OK	Notes
1	Check the safety category/standards			
	Does the category of the safety light curtain match the category required for the plant/machine?			
	Have the standards applicable for the plant/machine been considered?			
2	Check the ambient conditions for the safety light curtain			
	Have the environmental conditions been met (see Ambient conditions [ 23])?			
	Have the technical details been met for all the safety light curtain components?			
3	Check access to the danger zone Are all access points to the danger zone safeguarded by either safety light curtains or mechanical safeguards?			

No.	Action	OK	NOT OK	Notes
4	Check minimum distance to the danger zone			
	Has the minimum distance been calculated in accordance with the applicable standards?			
	Has the minimum distance been determined with the response time for the selected beam coding (see Technical details  56)?			
	Has the calculated minimum distance been maintained at all points?			
5	Check protected field			
	Has the ability to crawl underneath the protected field undetected been excluded?			
6	Check safety light curtain			
	Make sure that there are no objects in front of the safety light curtain (trailing cable, crossbeams, struts, covers, etc.).			
	Make sure that there are no transparent materials between the monitored protected field and the safety light curtain (such as the glass panel).			
	Are all the mechanical connections on the safety light curtain attached correctly?			
	Are all the electrical connections to the safety light curtain wired correctly?			
	Is the beam coding displayed correctly at the transmitter?			
7	Check the effectiveness of the safety light curtain during the hazardous movement			
	Is the safety light curtain effective throughout the whole of the plant/machine's hazardous movement?			
8	Check the output circuitry of the programmable control system			
	Have OSSDs been incorporated as required for the desired safety category?			
	Are the switching elements that are connected to the OSSDs (valves, contactors, etc.) monitored with feedback loops?			
	Does the wiring of the OSSDs match the circuit diagram?			

No.	Action	OK	NOT OK	Notes
9	<p>Check guard function for protected field of the safety light curtain:</p> <p>Interrupt the protected field at various points: The hazardous movement must be shut down.</p>			
10	<p>Switch off safety light curtain</p> <p>Is the hazardous movement stopped immediately when you switch off?</p>			

Use of muting

No.	Action	OK	NOT OK	Notes
11	<p>Check the ambient conditions for the safety light curtain</p> <p>Have the ambient conditions for the muting sensors been met (see Ambient conditions [ 23])?</p>			
12	<p>Check minimum distance to the danger zone</p> <p>Has the minimum distance been calculated in accordance with the applicable standards?</p>			
	<p>Has the minimum distance been determined with the response time for the selected beam coding (see Technical details [ 56])?</p>			
	<p>Has the calculated minimum distance been maintained at all points?</p>			
13	<p>Check protected field</p> <p>Has the ability to creep underneath or access the protected field from the rear undetected been excluded?</p>			
14	<p>Check muting sensors</p> <p>Make sure that there are no objects in front of the muting sensors (e.g. trailing cables, crossbeams, struts, covers).</p> <p>Make sure that the safety light curtain and muting sensors do not interfere with each other.</p> <p>Make sure that a reflection light barrier energises as a muting sensor if the corresponding reflector is covered.</p> <p>The safety light curtain must be synchronised in the process and the other muting sensors must not energise.</p>			

No.	Action	OK	NOT OK	Notes
	Are all the mechanical connections to the muting sensors attached correctly?			
	Are all the electrical connections to the muting sensors wired correctly?			
15	Check the effectiveness of the safety light curtain during the hazardous movement Is the safety light curtain effective throughout the whole of the plant/machine's hazardous movement?			
16	Check guard function for protected field of the safety light curtain: Interrupt the protected field at various points (if muting is not activated): The hazardous movement must be shut down.			
17	Switch off safety light curtain Is the hazardous movement stopped immediately when you switch off (if muting is not activated)?			

19.2 Muting applications with safety controller

19.2.1 Introduction

Muting is the temporary, automatic suspension of a safety function by a machine's control system. It can be used to enable access for materials:

- ▶ During a non-hazardous part of the machine cycle or
- ▶ When safety is maintained by other means.

By wiring the PSEN opII3B Series to an appropriate safety controller and muting sensors, with appropriate settings in the safety controller configuration, the PSEN opII3B Series can be used in muting applications.

An appropriate safety controller must meet the following requirements:

- ▶ Muting functions are met in accordance with IEC 62046.
- ▶ A requested reset is performed by the safety controller.
- ▶ A reset cancels a restart interlock in the safety controller.

Buttons for reset, muting sensors, override and muting lamp can be connected to the PSEN opII muting box. Via this box they can be connected to a safety controller.

Pilz recommends using the PSEN opII muting box for wiring (see [Order references for accessories](#) [ 71])

19.2.2 Prerequisites

- ▶ Safety light curtain and muting sensors must not interfere with each other. For this reason, sufficient distances must be maintained or the muting sensors must use a different wavelength range to the safety light curtain (wavelength range of the safety light curtain 600 nm ... 1200 nm).

- The muting sensor PSEN op3.3 can be used for a working distance ≤ 3 m. A minimum distance of 100 mm must be maintained between the muting sensors and the protected field.
- The muting sensor PSEN op3.1/3.2 can be used for a working distance > 3 m (see [Order references for muting accessories \[75\]](#)).

The PSEN op3.2 must be assembled on the receiver side and PSEN op3.1 on the transmitter side. This avoids mutual interference.

The greater the required working distance, the greater the distances between the muting sensors must be.

Working distance	Distance between the muting sensors PSEN op3.1/3.2
4 m	100 mm
6 m	200 mm
10 m	300 mm

Distance between the muting sensors PSEN op3.1/3.2, depending on the working distance

- ▶ A muting sensor must energise when the incidence of light is covered.
 - The safety light curtain must be synchronised in the process and the other muting sensors must not energise.
- ▶ Additional documents that apply
 - Operating manual of the safety controller
 - Operating manual of the muting sensor used

You will need to be conversant with the information in these documents in order to use muting.

19.2.3 Wiring

- ▶ Route the cables so that they are protected.
- ▶ Ambient conditions

Please observe the [environmental conditions](#) [📖 23].

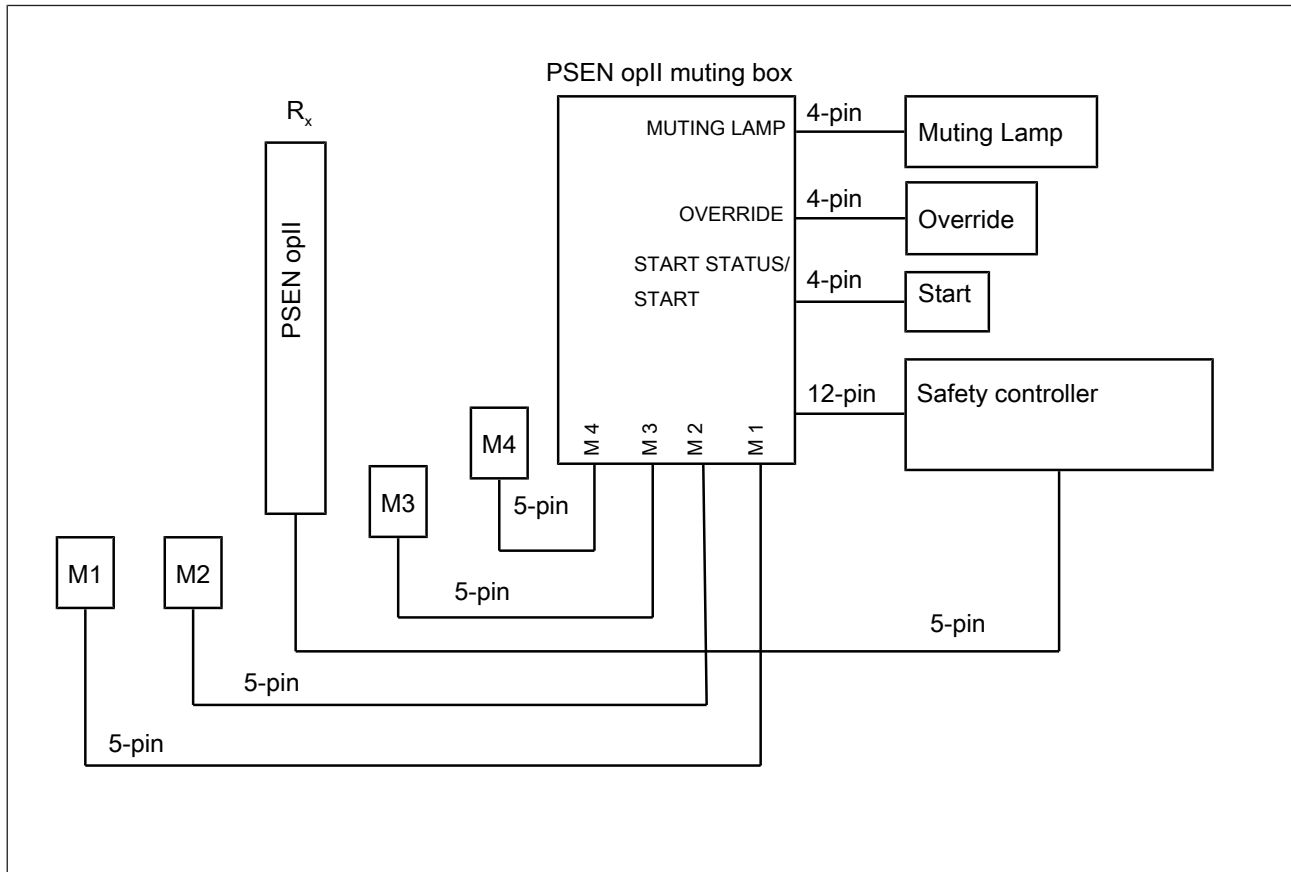

19.2.4 Cross muting

Cross muting is suitable for transporting material into and out of the danger zone.

- ▶ With cross muting, two muting sensors must be arranged in such a way that the light beams intersect after the safety light curtain's protected field (see diagram). The intersection point must be positioned after the protected field, in the direction of the danger zone.
- ▶ No part of a person's body must be able to reach the intersection point before it is detected by the safety light curtain.
- ▶ The time between the first and second muting sensor energising must not be more than 4 s.
If this is not possible, T-muting must be used.
- ▶ If using the PSEN opII muting arm, the technical details for the PSEN opII muting arm must be considered for mechanical stress due to shock and vibration.
- ▶ Pilz recommends the PSEN opII X Muting Set for assembling and wiring a cross muting application on a safety light curtain (see [Order references for accessories](#) [📖 71]).
- ▶ When using the muting set (or components of the set), the technical details of the set's components must be considered for the environmental data (e.g. shock and vibration).

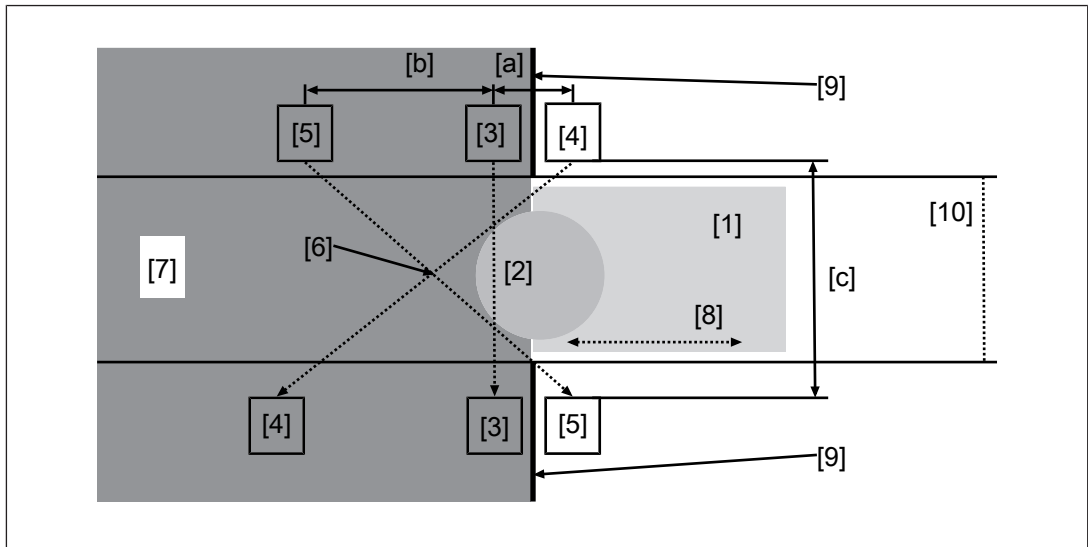



Fig.: Arrangement of the muting sensors with cross muting

Legend

- [1] Object that is to be transported through the protected field
 - [2] Test piece, Ø 500 mm
 - [3] Safety light curtain
 - [4] Muting sensor 1
 - [5] Muting sensor 2
 - [6] Intersection point of muting sensors 1 and 2
 - [7] Danger zone
 - [8] Direction of transport
 - [9] Guard to prevent access to the danger zone
 - [10] Conveyor
 - a Distance of muting sensor 1 from protected field
When using the PSEN opII X Muting Set > 100 mm
 - b Distance of muting sensor 2 from protected field
When using the PSEN opII X Muting Set > 100 mm
 - c Working distance between the safety light curtain's transmitter and receiver
When using the PSEN opII X Muting Set < 3000 mm
- ▶ Muting may only be initiated if both beams are activated with a defined time period. Select the time period to suit your application. The time period must not exceed 4 s.
 - ▶ Muting may not be initiated when an object with a diameter of at least 500 mm (corresponding to a person) is detected.

19.2.5 L-muting

Only use L-muting for transporting material out of the danger zone.

- ▶ If using the PSEN opII muting arm, the technical details for the PSEN opII muting arm must be considered for mechanical stress due to shock and vibration.
- ▶ Pilz recommends the PSEN opII L Muting Set for assembling and wiring an L-muting application on a safety light curtain (see [Order references for accessories](#)  71).
- ▶ When using the muting set (or components of the set), the technical details of the set's components must be considered for the environmental data (e.g. shock and vibration).

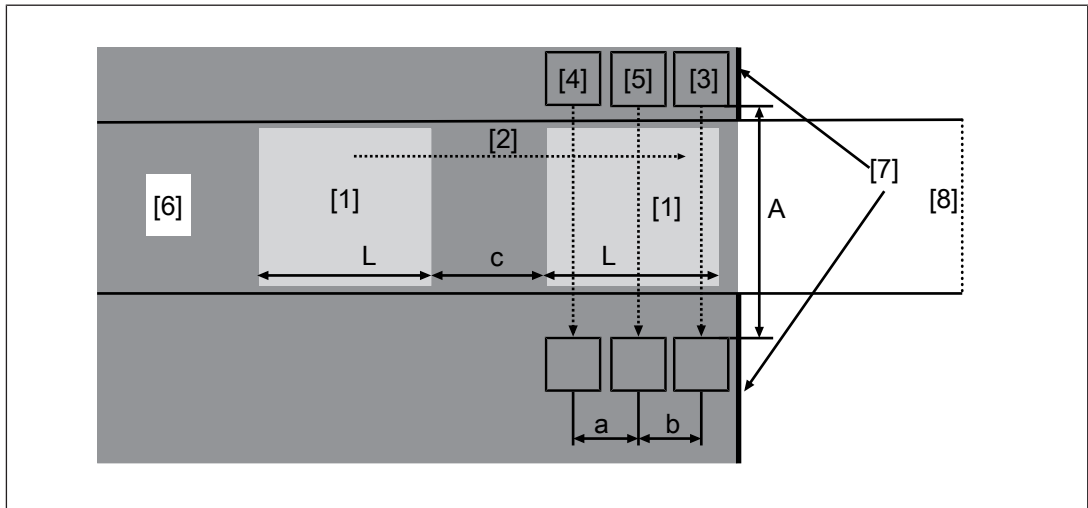

Fig.: Arrangement of the muting sensors with L-muting

Legend

- [1] Object that is to be transported through the protected field
- [2] Direction of transport with speed v
- [3] Safety light curtain
- [4] Muting sensor 1
- [5] Muting sensor 2
- [6] Danger zone
- [7] Guard to prevent access to the danger zone
- [8] Conveyor
 - a Distance of muting sensor 1 from muting sensor 2
 - b Distance of muting sensor 2 from protected field
 - c Distance between two objects that are being transported through the protected field
 - L Length of the object that triggers the muting state as it passes the muting sensors
 - A Working distance between the safety light curtain's transmitter and receiver

- [7] Muting sensor 4
- [8] Danger zone
- [9] Guard to prevent access to the danger zone
- [10] Conveyor
 - a Distance a, muting sensor 1 from muting sensor 2
 - b Distance b, muting sensor 2 from protected field
 - d Distance d, muting sensor 3 from protected field
 - e Distance e, muting sensor 4 from muting sensor 3
 - f Distance f between two objects that are being transported through the protected field
 - L Length of the object that triggers the muting state as it passes the muting sensors
 - A Working distance A between the safety light curtain's transmitter and receiver

Comply with the following distances and times

- ▶ Working distance A between the safety light curtain's transmitter and receiver
When using the PSEN opII T Muting Set < 3000 mm
- ▶ a = Distance of muting sensor 1 from muting sensor 2
Recommendation in IEC 62046 > 250 mm
- ▶ b = Distance of muting sensor 2 from protected field
When using the PSEN opII T Muting Set > 100 mm
Recommendation in IEC 62046 < 200 mm
- ▶ d = Distance of protected field from muting sensor 3
When using the PSEN opII T Muting Set > 100 mm
- ▶ e = Distance of muting sensor 3 from muting sensor 4
When using the PSEN opII T Muting Set > 100 mm
- ▶ L = Length of the object that triggers the muting state as it passes the muting sensors
 $L > a + b + d + e$
- ▶ $a + b + d + e > 500$ mm (recommendation in IEC 62046)
- ▶ f = Distance between two objects that are being transported through the protected field
 $f > a + b + d + e$

19.2.7 Override

The override function is used to override the muting function in the event of an error.

Override enables the machine to be operated manually, to remove material from the safe-guard's protected field for example.

Override must only be available when at least one muting sensor has triggered and the protected field is blocked.

One exception is when override is only used for the output. In this case, override is also permitted if the safety light curtain is in an OFF state, but no muting sensor has been triggered.

Activating the override must not initiate motion. A separate control device must be operated to initiate this motion.

Comply with the override start-up conditions required by the standard IEC 62046.

Start-up conditions, when safety light curtain and danger zone are visible from the location from which the override is started:

- ▶ Override must be started using a hold-to-run control device. The control device must be positioned so that entering the danger zone is impossible as long as the hold-to-run control device is active. **Or**
- ▶ Override must be started by operating and releasing a pushbutton, triggering an override time, the maximum length of which is defined by a risk assessment.

Start-up conditions, when the danger zone is not visible from the location from which the override is started:

- ▶ Override must be started using a spring return key switch (or a pushbutton with equal security).
 - The spring return key switch (or pushbutton with equal security), must be positioned so that the danger zone cannot be entered while this switch is operated **and**
 - The safety light curtain that has been overridden must be visible from the location from which the override is initiated, **and**
 - Before initiating the override, it must be possible to inspect the area secured by the safety light curtain **and**
 - Access to the danger zone must not be possible during the override sequence **and**
 - It must be possible to initiate an emergency stop from the same location.

Comply with the override shutdown conditions required by the standard IEC 62046.

- ▶ The muting-dependent override function must be ended automatically when one of the following conditions arises:
 - All muting sensors are deactivated and the safety light curtain's protected field is clear or
 - A pre-set time limit has expired or
 - The hold-to-run control device is released or
 - An interlock state is detected.

20 **EC declaration of conformity**

This product/these products meet the requirements of the directive 2006/42/EC for machinery of the European Parliament and of the Council. The complete EC Declaration of Conformity is available on the Internet at www.pilz.com/downloads.

Authorised representative: Norbert Fröhlich, Pilz GmbH & Co. KG, Felix-Wankel-Str. 2, 73760 Ostfildern, Germany

21

UKCA-Declaration of Conformity

This product(s) complies with following UK legislation: Supply of Machinery (Safety) Regulation 2008.

The complete UKCA Declaration of Conformity is available on the Internet at www.pilz.com/downloads.

Representative: Pilz Automation Technology, Pilz House, Little Colliers Field, Corby, Northamptonshire, NN18 8TJ United Kingdom, eMail: mail@pilz.co.uk

► Support

Technical support is available from Pilz round the clock.

Americas

Brazil

+55 11 97569-2804

Canada

+1 888 315 7459

Mexico

+52 55 5572 1300

USA (toll-free)

+1 877-PILZUSA (745-9872)

Asia

China

+86 21 60880878-216

Japan

+81 45 471-2281

South Korea

+82 31 778 3300

Australia and Oceania

Australia

+61 3 95600621

New Zealand

+64 9 6345350

Europe

Austria

+43 1 7986263-0

Belgium, Luxembourg

+32 9 3217570

France

+33 3 88104003

Germany

+49 711 3409-444

Ireland

+353 21 4804983

Italy, Malta

+39 0362 1826711

Scandinavia

+45 74436332

Spain

+34 938497433

Switzerland

+41 62 88979-32

The Netherlands

+31 347 320477

Turkey

+90 216 5775552

United Kingdom

+44 1536 462203

You can reach our international hotline on:

+49 711 3409-222

support@pilz.com

Pilz develops environmentally-friendly products using ecological materials and energy-saving technologies. Offices and production facilities are ecologically designed, environmentally-aware and energy-saving. So Pilz offers sustainability, plus the security of using energy-efficient products and environmentally-friendly solutions.



We are represented internationally. Please refer to our homepage www.pilz.com for further details or contact our headquarters.

Headquarters: Pilz GmbH & Co. KG, Felix-Wankel-Straße 2, 73760 Ostfildern, Germany
Telephone: +49 711 3409-0, Telefax: +49 711 3409-133, E-Mail: info@pilz.com, Internet: www.pilz.com

PILZ
THE SPIRIT OF SAFETY

1004845-EN-05, 2023-04 Printed in Germany
© Pilz GmbH & Co. KG, 2019

CECE®, CHRE®, CMSE®, InduraNET p®, Leansafe®, Master of Safety®, Master of Security®, PAS4000®, PAScall®, PASconfig®, Pilz®, PTT®, PLID®, PMCPirimo®, PMCPiritego®, PMCTendo®, PMD®, PMJ®, PNOZ®, PRBM®, PRCM®, PRIMO®, PRM®, PSEN®, PSENi®, PSS®, PVS®, SafetyBUS p®, SafetyEYE®, THE SPIRIT OF SAFETY® are registered and protected trademarks of Pilz GmbH & Co. KG in some countries. We would point out that product features may vary from the details stated in this document, depending on the status at the time of publication and the scope of the equipment. We accept no responsibility for the validity, accuracy and entirety of the text and graphics presented in this information. Please contact our Technical Support if you have any questions.