

A

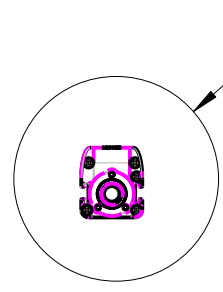

B

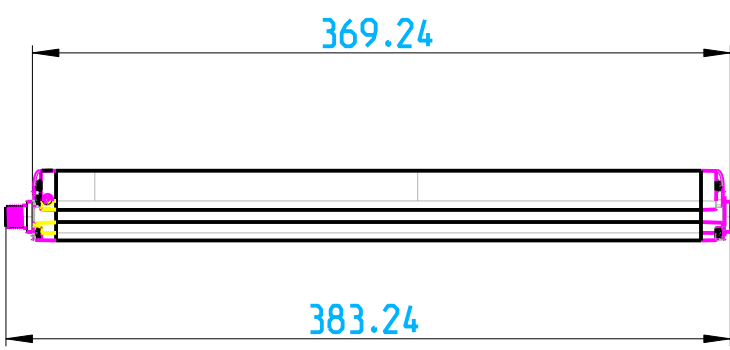
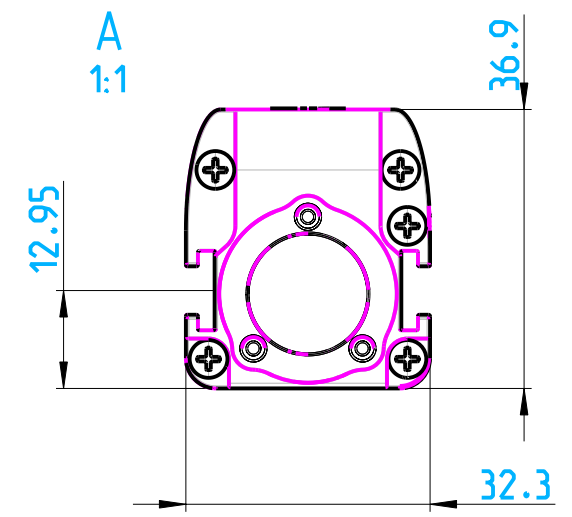

A
1:1

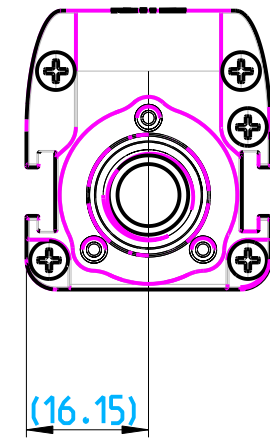
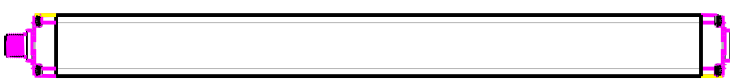
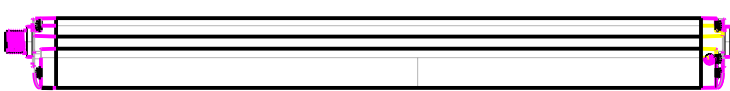
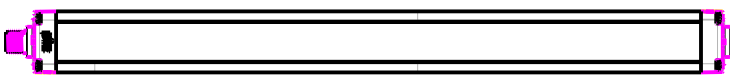

B
1:1

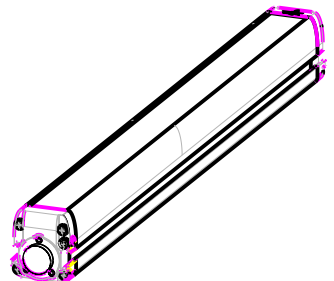

Observe protection note to DIN 34

-	20110065	10.3.2011	EP-MK	EP-MK	neue Zeichnung new drawing	
Index	ECD no.	Date	Editor	Checked	Date	Name
Scale					10.3.2011	EP-MK
1:4					10.3.2011	EP-MK
Material						
-						
-						
Surface						
-						
All dimensions are in mm					MODEL: 2008565	
Unspecified tolerance					DRW: 2008566	
					Internet Dokument Internet document PSEN op 030/1	
					Doc.-No. 2008566	
					Page 1	
					Mat.-No. -	
					of 1	

