

1 2 3 4 5 6 7 8

A

A

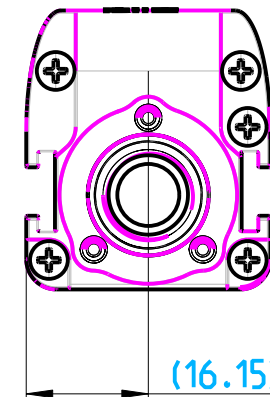
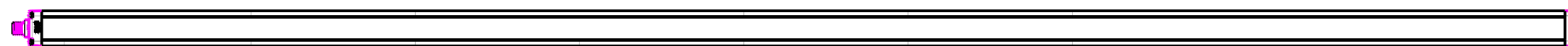
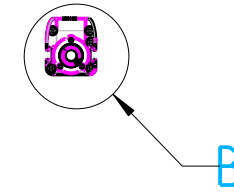
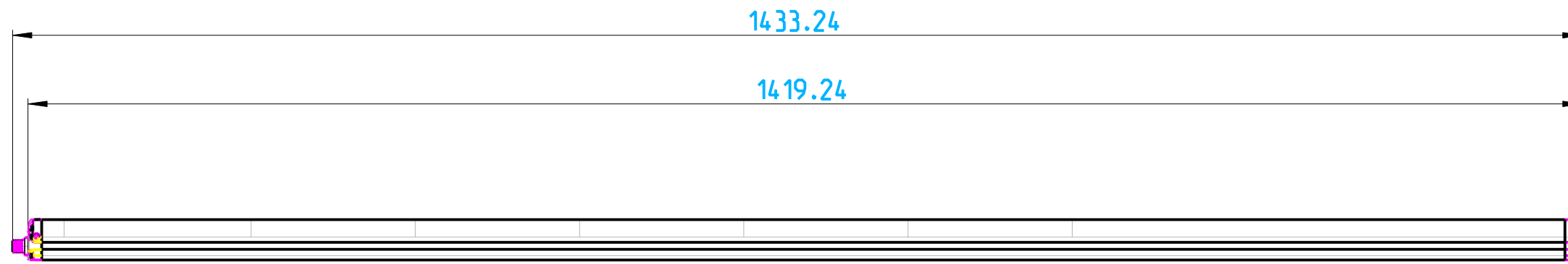
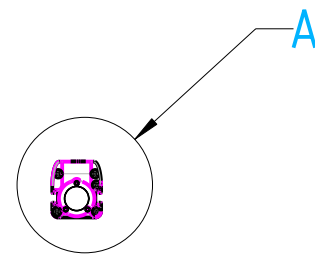

B  
1:1

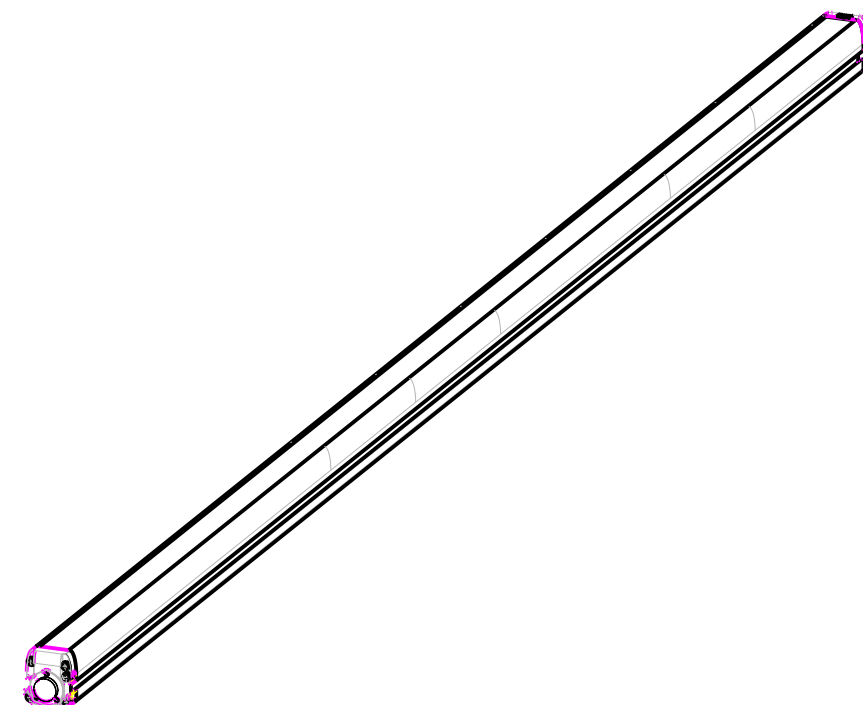
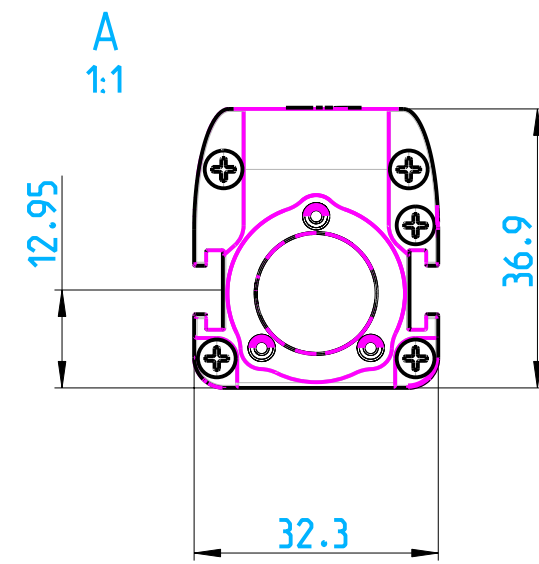

Observe protection note to DIN 34

-	20110065	10.3.2011	EP-MK	EP-MK	neue Zeichnung	
Index	ECO no.	Date	Editor	Checked	new drawing	
Scale	1:5			Date	Name	MODEL: 2008584 DRW: 2008585
Material			Created	10.3.2011	EP-MK	Internet Dokument Internet document PSEN op 135/1
			Checked	10.3.2011	EP-MK	
			Norm	-	-	
Surface			All dimensions are in mm			Doc.-No. 2008585
			Unspecified Tolerance			Page 1
					Mat.-No. -	of 1



B

B

C

C

D

D

E

E

F

F

1 2 3 4 5 6 7 8