

1 2 3 4

A

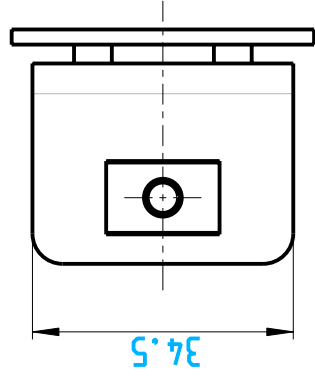

B

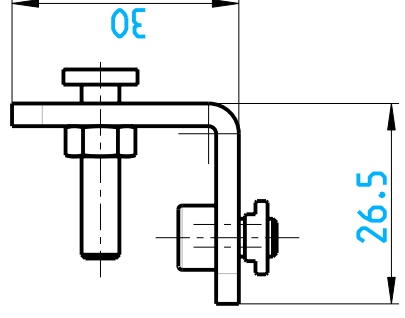
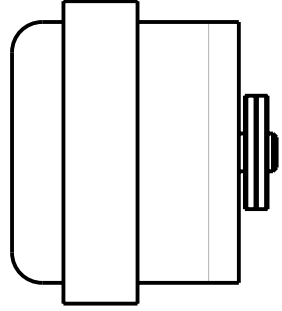
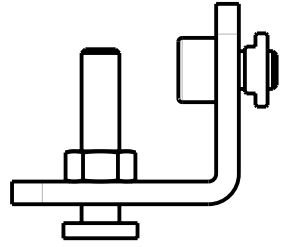

C

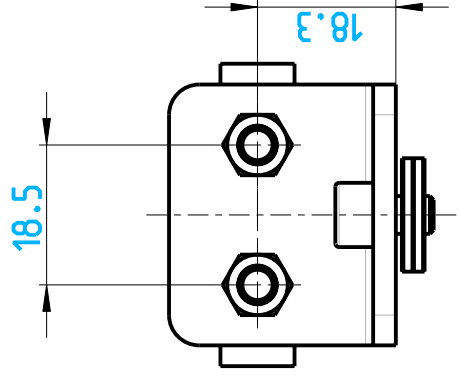

D

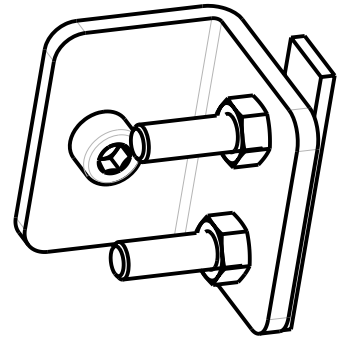
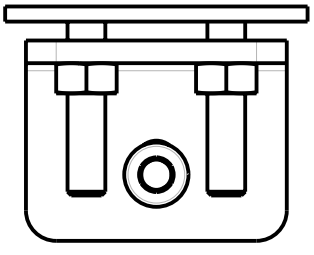

Mat.No	Number of bracket parts
630956	4
630957	6
630958	4
630959	6

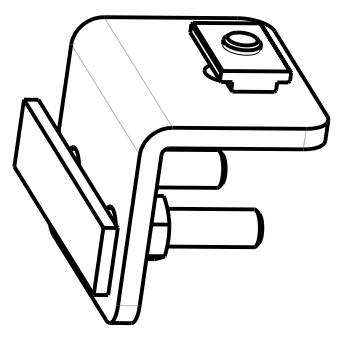

Observe protection note to DIN 34

-	20120306	06.09.2012	EP-MK	EP-MK	-	-	MODEL: 2011225	DRW: 2011226
Index	ECO no.	Date	Editor	Checked	Date	Name	Internet Dokument Internet document PSEN op Protective Bracket	
Scale			Created	Checked	Norm	EP-MK		
1:1			07.09.2012	07.09.2012	-	EP-MK	Doc.-No. 2011226 Page 1	
Material		All dimensions are in mm		Unspecified tolerance		Mat.-No. - of 1		