



## ► PZE X4VP

**PILZ**  
THE SPIRIT OF SAFETY

Operating Manual-1003202-EN-14  
- Safety relays



This document is the original document.

Where unavoidable, for reasons of readability, the masculine form has been selected when formulating this document. We do assure you that all persons are regarded without discrimination and on an equal basis.

All rights to this documentation are reserved by Pilz GmbH & Co. KG. Copies may be made for the user's internal purposes. Suggestions and comments for improving this documentation will be gratefully received.

Pilz®, PIT®, PMI®, PNOZ®, Primo®, PSEN®, PSS®, PVIS®, SafetyBUS p®, SafetyEYE®, SafetyNET p®, the spirit of safety® are registered and protected trademarks of Pilz GmbH & Co. KG in some countries.



SD means Secure Digital

<b>Introduction</b> .....	<b>5</b>
Validity of documentation .....	5
Using the documentation .....	5
Definition of symbols .....	5
<b>Safety</b> .....	<b>6</b>
Intended use .....	6
Safety regulations .....	6
Safety assessment .....	6
Use of qualified personnel .....	7
Warranty and liability .....	7
Disposal .....	7
For your safety .....	7
<b>Unit features</b> .....	<b>8</b>
<b>Safety features</b> .....	<b>8</b>
<b>Block diagram/terminal configuration</b> .....	<b>8</b>
<b>Function description</b> .....	<b>9</b>
<b>Installation</b> .....	<b>9</b>
<b>Wiring</b> .....	<b>10</b>
<b>Preparing for operation</b> .....	<b>10</b>
<b>Operation</b> .....	<b>11</b>
Status indicators .....	11
<b>Faults – Interference</b> .....	<b>11</b>
<b>Dimensions in mm</b> .....	<b>12</b>
<b>Technical details Order no. 777580, 777581, 777582</b> .....	<b>12</b>
<b>Technical details Order no. 777583, 787580, 787581</b> .....	<b>17</b>
<b>Technical details Order no. 787582, 787583</b> .....	<b>21</b>
<b>Safety characteristic data</b> .....	<b>24</b>
<b>Supplementary data</b> .....	<b>25</b>
Service life graph .....	25

<b>Remove plug-in terminals .....</b>	<b>27</b>
<b>Order reference .....</b>	<b>27</b>
<b>EC declaration of conformity .....</b>	<b>28</b>
<b>UKCA-Declaration of Conformity .....</b>	<b>28</b>

## Introduction

### Validity of documentation

This documentation is valid for the product PZE X4VP. It is valid until new documentation is published.

This operating manual explains the function and operation, describes the installation and provides guidelines on how to connect the product.

### Using the documentation

This document is intended for instruction. Only install and commission the product if you have read and understood this document. The document should be retained for future reference.

### Definition of symbols

Information that is particularly important is identified as follows:



#### **DANGER!**

This warning must be heeded! It warns of a hazardous situation that poses an immediate threat of serious injury and death and indicates preventive measures that can be taken.



#### **WARNING!**

This warning must be heeded! It warns of a hazardous situation that could lead to serious injury and death and indicates preventive measures that can be taken.



#### **CAUTION!**

This refers to a hazard that can lead to a less serious or minor injury plus material damage, and also provides information on preventive measures that can be taken.



#### **NOTICE**

This describes a situation in which the product or devices could be damaged and also provides information on preventive measures that can be taken. It also highlights areas within the text that are of particular importance.

**INFORMATION**

This gives advice on applications and provides information on special features.

**Safety****Intended use**

The contact expansion module PZE X4VP meets the requirements of EN 60947-5-1 and EN 60204- 1. It is an expansion module for increasing the number of contacts available on a base unit. Base units are all safety relays with feedback loop.

The max. achievable safety level depends on the base unit. The expansion module may not exceed this. The safety-related characteristic values stated under [safety-related characteristic data](#) [ 24] can only be achieved if the base unit also exhibits these safety characteristic values.

**Improper use**

The following is deemed improper use in particular:

- ▶ Any component, technical or electrical modification to the product,
- ▶ Use of the product outside the areas described in this operating manual,
- ▶ Use of the product outside the technical details (see chapter entitled [Technical Details](#) [ 12]).

**NOTICE****EMC-compliant electrical installation**

The product is designed for use in an industrial environment. The product may cause interference if installed in other environments. If installed in other environments, measures should be taken to comply with the applicable standards and directives for the respective installation site with regard to interference.

**Safety regulations****Safety assessment**

Before using a device, a safety assessment in accordance with the Machinery Directive is required.

The product as an individual component fulfils the functional safety requirements in accordance with EN ISO 13849 and EN IEC 62061. However, this does not guarantee the functional safety of the overall plant/machine. To achieve the relevant safety level of the overall plant/machine's required safety functions, each safety function needs to be considered separately.

**Use of qualified personnel**

The products may only be assembled, installed, programmed, commissioned, operated, maintained and decommissioned by persons who are competent to do so.

A competent person is a qualified and knowledgeable person who, because of their training, experience and current professional activity, has the specialist knowledge required. To be able to inspect, assess and operate devices, systems and machines, the person has to be informed of the state of the art and the applicable national, European and international laws, directives and standards.

It is the company's responsibility only to employ personnel who

- ▶ Are familiar with the basic regulations concerning health and safety / accident prevention,
- ▶ Have read and understood the information provided in the section entitled Safety
- ▶ Have a good knowledge of the generic and specialist standards applicable to the specific application.

**Warranty and liability**

All claims to warranty and liability will be rendered invalid if

- ▶ The product was used contrary to the purpose for which it is intended,
- ▶ Damage can be attributed to not having followed the guidelines in the manual,
- ▶ Operating personnel are not suitably qualified,
- ▶ Any type of modification has been made (e.g. exchanging components on the PCB boards, soldering work etc.).

**Disposal**

- ▶ In safety-related applications, please comply with the mission time  $T_M$  in the safety-related characteristic data.
- ▶ When decommissioning, please comply with local regulations regarding the disposal of electronic devices (e.g. Electrical and Electronic Equipment Act).

**For your safety**

The unit meets all the necessary conditions for safe operation. However, please note the following:

- ▶ Note for overvoltage category III: If voltages higher than low voltage (>50 VAC or >120 VDC) are present on the unit, connected control elements and sensors must have a rated insulation voltage of at least 250 V.

### Unit features

- ▶ Positive-guided relay outputs:
  - 4 safety contacts (N/O), delay-on de-energisation
- ▶ LED display for:
  - Switch status of the safety contacts
- ▶ Connection for feedback loop
- ▶ Operation: single-channel
- ▶ Unit types with various delay times
- ▶ Plug-in connection terminals (either spring-loaded terminal or screw terminal)
- ▶ See order reference for unit types

### Safety features

The unit meets the following safety requirements:

- ▶ The contact expansion module expands an existing circuit. As the output relays are monitored via the base unit's feedback loop, the safety functions on the existing circuit are transferred to the contact expansion module.
- ▶ The safety function remains effective in the case of a component failure.
- ▶ Earth fault in the feedback loop:
  - Detected, depending on the base unit that is used.
- ▶ Earth fault in the input circuit:
  - The output relays de-energise and the safety contacts open.

### Block diagram/terminal configuration

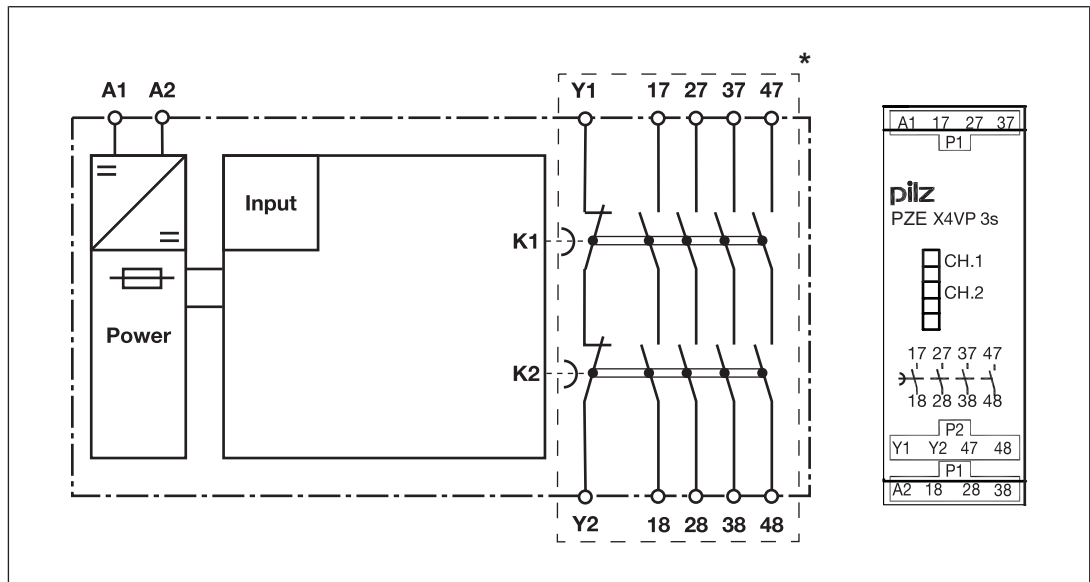

\*Insulation between the non-marked area and the relay contacts: Basic insulation (over-voltage category III), Protective separation (overvoltage category II)



## Function description

The contact expansion module PZE X4VP is an add-on device with delay-on de-energisation, and it is used to expand a safety circuit. The contact expansion module is driven by a base unit (e. g. emergency stop relay).

- ▶ Functional procedure once the input circuit is closed (e.g. safety contacts on the base unit are closed):
  - The supply voltage is present at input (A1) of the contact expansion module.
  - The safety contacts 17-18, 27-28, 37-38 and 47-48 close.
  - The LEDs "CH.1" and "CH.2" are lit.
- ▶ Functional procedure once the input circuit is opened (e.g. safety contacts on the base unit are opened):
  - The supply voltage is not present at input (A1) of the contact expansion module.
  - The LEDs "CH.1" and "CH.2" go out.
  - Safety contacts 17-18, 27-28, 37-38 and 47-48 are opened redundantly once the delay time has elapsed.



### NOTICE

At the latest the safety contacts open after the delay time  $t_v + 50\%$  of the value, even in the case of a component failure.

## Installation

- ▶ The unit should be installed in a control cabinet with a protection type of at least IP54.
- ▶ Use the notch on the rear of the unit to attach it to a DIN rail (35 mm).
- ▶ When installed vertically: Secure the unit by using a fixing element (e.g. retaining bracket or end angle).
- ▶ If more than 2 units are installed next to each other in the control cabinet, leave a distance of at least 6 mm between the units.

## Wiring

Please note:

- ▶ Information given in the "[Technical details \[12\]](#)" must be followed.
- ▶ Outputs 17-18, 27-28, 37-38 and 47-48 are delay-on de-energisation safety contacts.
- ▶ To prevent contact welding, a fuse should be connected before the output contacts (see [Technical details \[12\]](#)).
- ▶ Calculation of the max. cable length  $l_{max}$  in the input circuit:

$$l_{max} = \frac{R_{lmax}}{R_l / km}$$

$R_{lmax}$  = max. overall cable resistance (see [Technical details \[12\]](#))

$R_l / km$  = cable resistance/km

- ▶ Use copper wiring with a temperature stability of 60/75 °C.
- ▶ To prevent EMC interferences (particularly common-mode interferences) the measures described in EN 60204-1 must be executed. This includes the separate routing of cables of the control circuits (input, start and feedback loop) from other cables for energy transmission or the shielding of cables, for example.
- ▶ Adequate protection must be provided on all output contacts with capacitive and inductive loads.
- ▶ Do not switch low currents using contacts that have been used previously with high currents.
- ▶ The power supply must comply with the regulations for extra low voltages with protective electrical separation (SELV, PELV) in accordance with VDE 0100, Part 410.

## Preparing for operation

Supply voltage	AC	DC
	/	
Input circuit	Single-channel	Dual-channel
Base unit: Safety relay PNOZ X Driven via safety contacts		/

Feedback loop	Base unit: Safety relay PNOZ X	
Y1 and Y2 are inputs on the base unit; they evaluate the feedback loop		

### Operation

When the relay outputs are switched on, the mechanical contact on the relay cannot be tested automatically. Depending on the operational environment, measures to detect the non-opening of switching elements may be required under some circumstances.

When the product is used in accordance with the European Machinery Directive, a check must be carried out to ensure that the safety contacts on the relay outputs open correctly. Open the safety contacts of the contact expansion module (switch off outputs of the base unit) and start the base unit again so that the internal diagnostics can check that the safety contacts open correctly

- ▶ for SIL CL 2/PL d at least 1x per year



#### NOTICE

The safety functions should be checked after initial commissioning and each time the plant/machine is changed. The safety functions may only be checked by qualified personnel.

### Status indicators

LEDs indicate the status and errors during operation:



LED on



#### CH.1

Safety contacts of channel 1 are closed.



#### CH.2

Safety contacts of channel 2 are closed.

### Faults – Interference

By closing or interrupting the input circuit you can check whether the unit switches on or off correctly.

For safety reasons, the unit cannot be started if the following faults are present:

- ▶ **Contact malfunction:** As the contact block is connected to a base unit, reactivation will not be possible if the contacts have welded after the input circuit has opened.
- ▶ Open circuit, short circuit or earth fault ( e.g. in the input circuit)
- ▶ In the case of an error, the delay-on de-energisation safety contacts may open before the delay time has elapsed.

### Dimensions in mm

\* with spring-loaded terminals

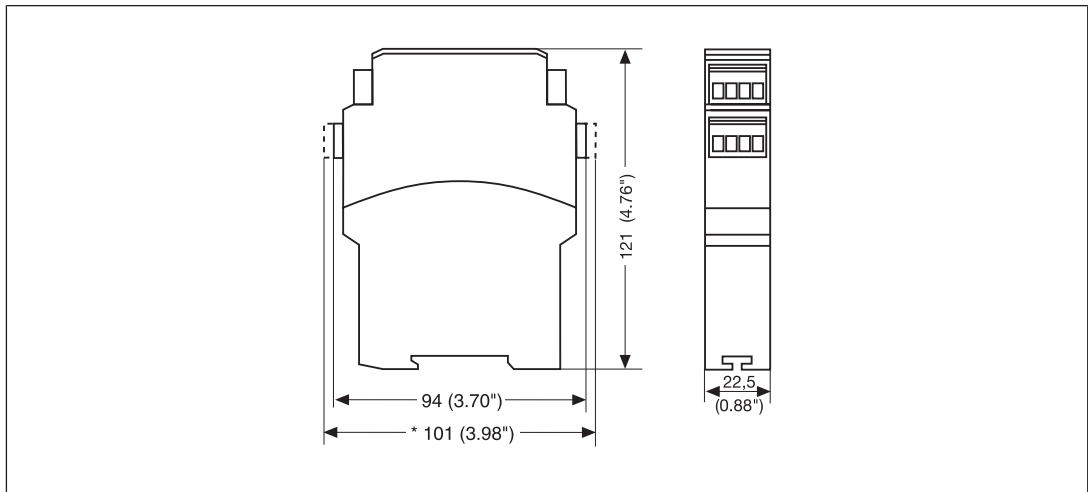

### Technical details Order no. 777580, 777581, 777582

General	777580	777581	777582
Certifications	CCC, CE, EAC, TÜV, UKCA, cULus Listed	CCC, CE, EAC, TÜV, UKCA, cULus Listed	CCC, CE, EAC, TÜV, UKCA, cULus Listed
Electrical data	777580	777581	777582
Supply voltage			
Voltage	24 V	24 V	24 V
Kind	DC	DC	DC
Voltage tolerance	-15 %/+10 %	-15 %/+10 %	-15 %/+10 %
Output of external power supply (DC)	2,5 W	2,5 W	2,5 W
Residual ripple DC	20 %	20 %	20 %
Duty cycle	100 %	100 %	100 %
Max. inrush current impulse			
Current pulse, A1	1,7 A	1,7 A	1,7 A
Pulse duration, A1	50 ms	100 ms	140 ms
Inputs	777580	777581	777582
Quantity	1	1	1
Voltage at			
Input circuit DC	24 V	24 V	24 V
Current at			
Input circuit DC	95 mA	95 mA	95 mA
Max. overall cable resistance R <sub>lmax</sub>			
Single-channel at UB DC	30 Ohm	30 Ohm	30 Ohm

<b>Relay outputs</b>	<b>777580</b>	<b>777581</b>	<b>777582</b>
Number of output contacts			
Safety contacts (N/O), delayed	<b>4</b>	<b>4</b>	<b>4</b>
Max. short circuit current IK	<b>1 kA</b>	<b>1 kA</b>	<b>1 kA</b>
Utilisation category in accordance with the standard	<b>EN 60947-4-1</b>	<b>EN 60947-4-1</b>	<b>EN 60947-4-1</b>
Utilisation category of safety contacts delayed			
AC1 at	<b>240 V</b>	<b>240 V</b>	<b>240 V</b>
Min. current	<b>0,01 A</b>	<b>0,01 A</b>	<b>0,01 A</b>
Max. current	<b>6 A</b>	<b>6 A</b>	<b>6 A</b>
Max. power	<b>1500 VA</b>	<b>1500 VA</b>	<b>1500 VA</b>
DC1 at	<b>24 V</b>	<b>24 V</b>	<b>24 V</b>
Min. current	<b>0,01 A</b>	<b>0,01 A</b>	<b>0,01 A</b>
Max. current	<b>6 A</b>	<b>6 A</b>	<b>6 A</b>
Max. power	<b>150 W</b>	<b>150 W</b>	<b>150 W</b>
Utilisation category in accordance with the standard	<b>EN 60947-5-1</b>	<b>EN 60947-5-1</b>	<b>EN 60947-5-1</b>
Utilisation category of safety contacts delayed			
AC15 at	<b>230 V</b>	<b>230 V</b>	<b>230 V</b>
Max. current	<b>3 A</b>	<b>3 A</b>	<b>3 A</b>
DC13 (6 cycles/min) at	<b>24 V</b>	<b>24 V</b>	<b>24 V</b>
Max. current	<b>4 A</b>	<b>4 A</b>	<b>4 A</b>
Utilisation category in accordance with UL			
Voltage with current	<b>250 V AC G.U. (same polarity)</b>	<b>250 V AC G.U. (same polarity)</b>	<b>250 V AC G.U. (same polarity)</b>
Voltage with current	<b>24 V DC G. U.</b>	<b>24 V DC G. U.</b>	<b>24 V DC G. U.</b>
Pilot Duty	<b>B300, R300</b>	<b>B300, R300</b>	<b>B300, R300</b>
External contact fuse protection, safety contacts in accordance with the standard	<b>EN 60947-5-1</b>	<b>EN 60947-5-1</b>	<b>EN 60947-5-1</b>

<b>Relay outputs</b>	<b>777580</b>	<b>777581</b>	<b>777582</b>
External contact fuse protection, delayed safety contacts			
Max. melting integral	<b>66 A<sup>2</sup>s</b>	<b>66 A<sup>2</sup>s</b>	<b>66 A<sup>2</sup>s</b>
Blow-out fuse, quick	<b>6 A</b>	<b>6 A</b>	<b>6 A</b>
Blow-out fuse, slow	<b>4 A</b>	<b>4 A</b>	<b>4 A</b>
Blow-out fuse, gG	<b>6 A</b>	<b>6 A</b>	<b>6 A</b>
Circuit breaker, 24 V AC/DC, characteristic B/C	<b>4 A</b>	<b>4 A</b>	<b>4 A</b>
Contact material	<b>AgCuNi + 0,2 µm Au</b>	<b>AgCuNi + 0,2 µm Au</b>	<b>AgCuNi + 0,2 µm Au</b>
<b>Conventional thermal current while loading several contacts</b>	<b>777580</b>	<b>777581</b>	<b>777582</b>
I <sub>th</sub> per contact at UB DC; AC1: 240 V, DC1: 24 V			
Conv. therm. current with 1 contact	<b>6 A</b>	<b>6 A</b>	<b>6 A</b>
Conv. therm. current with 2 contacts	<b>5 A</b>	<b>5 A</b>	<b>5 A</b>
Conv. therm. current with 3 contacts	<b>4,5 A</b>	<b>4,5 A</b>	<b>4,5 A</b>
Conv. therm. current with 4 contacts	<b>4 A</b>	<b>4 A</b>	<b>4 A</b>
<b>Times</b>	<b>777580</b>	<b>777581</b>	<b>777582</b>
Switch-on delay			
with automatic start after power on typ.	<b>55 ms</b>	<b>55 ms</b>	<b>55 ms</b>
with automatic start after power on max.	<b>200 ms</b>	<b>200 ms</b>	<b>200 ms</b>
Delay time t <sub>v</sub>	<b>0,5 s</b>	<b>1 s</b>	<b>2 s</b>
Time accuracy	<b>-50 %/+50 %</b>	<b>-50 %/+50 %</b>	<b>-50 %/+50 %</b>
Supply interruption before de-energisation	<b>250 ms</b>	<b>500 ms</b>	<b>1.000 ms</b>
<b>Environmental data</b>	<b>777580</b>	<b>777581</b>	<b>777582</b>
Climatic suitability	<b>EN 60068-2-78</b>	<b>EN 60068-2-78</b>	<b>EN 60068-2-78</b>
Ambient temperature			
Temperature range	<b>-10 - 55 °C</b>	<b>-10 - 55 °C</b>	<b>-10 - 55 °C</b>
Storage temperature			
Temperature range	<b>-40 - 85 °C</b>	<b>-40 - 85 °C</b>	<b>-40 - 85 °C</b>
Climatic suitability			
Humidity	<b>93 % r. h. at 40 °C</b>	<b>93 % r. h. at 40 °C</b>	<b>93 % r. h. at 40 °C</b>
Condensation during operation	<b>Not permitted</b>	<b>Not permitted</b>	<b>Not permitted</b>
EMC	<b>EN 60947-5-1, EN 61000-6-2, EN 61326-3-1</b>	<b>EN 60947-5-1, EN 61000-6-2, EN 61326-3-1</b>	<b>EN 60947-5-1, EN 61000-6-2, EN 61326-3-1</b>

<b>Environmental data</b>	<b>777580</b>	<b>777581</b>	<b>777582</b>
Vibration			
in accordance with the standard	<b>EN 60068-2-6</b>	<b>EN 60068-2-6</b>	<b>EN 60068-2-6</b>
Frequency	<b>10 - 55 Hz</b>	<b>10 - 55 Hz</b>	<b>10 - 55 Hz</b>
Amplitude	<b>0,35 mm</b>	<b>0,35 mm</b>	<b>0,35 mm</b>
Airgap creepage			
in accordance with the standard	<b>EN 60947-1</b>	<b>EN 60947-1</b>	<b>EN 60947-1</b>
Overvoltage category	<b>III / II</b>	<b>III / II</b>	<b>III / II</b>
Pollution degree	<b>2</b>	<b>2</b>	<b>2</b>
Rated insulation voltage	<b>250 V</b>	<b>250 V</b>	<b>250 V</b>
Rated impulse withstand voltage	<b>4 kV</b>	<b>4 kV</b>	<b>4 kV</b>
Protection type			
Housing	<b>IP40</b>	<b>IP40</b>	<b>IP40</b>
Terminals	<b>IP20</b>	<b>IP20</b>	<b>IP20</b>
Mounting area (e.g. control cabinet)	<b>IP54</b>	<b>IP54</b>	<b>IP54</b>
<b>Mechanical data</b>	<b>777580</b>	<b>777581</b>	<b>777582</b>
Mounting position	<b>Any</b>	<b>Any</b>	<b>Any</b>
Mechanical life	<b>10,000,000 cycles</b>	<b>10,000,000 cycles</b>	<b>10,000,000 cycles</b>
Material			
Bottom	<b>PPO UL 94 V1</b>	<b>PPO UL 94 V1</b>	<b>PPO UL 94 V1</b>
Front	<b>ABS UL 94 V0</b>	<b>ABS UL 94 V0</b>	<b>ABS UL 94 V0</b>
Top	<b>PPO UL 94 V1</b>	<b>PPO UL 94 V1</b>	<b>PPO UL 94 V1</b>
Connection type	<b>Screw terminal</b>	<b>Screw terminal</b>	<b>Screw terminal</b>
Mounting type	<b>plug-in</b>	<b>plug-in</b>	<b>plug-in</b>
Conductor cross section with screw terminals			
1 core flexible	<b>0,25 - 2,5 mm<sup>2</sup>, 24 - 12 AWG</b>	<b>0,25 - 2,5 mm<sup>2</sup>, 24 - 12 AWG</b>	<b>0,25 - 2,5 mm<sup>2</sup>, 24 - 12 AWG</b>
2 core with the same cross section, flexible with crimp connectors, no plastic sleeve	<b>0,25 - 1 mm<sup>2</sup>, 24 - 16 AWG</b>	<b>0,25 - 1 mm<sup>2</sup>, 24 - 16 AWG</b>	<b>0,25 - 1 mm<sup>2</sup>, 24 - 16 AWG</b>
2 core with the same cross section, flexible without crimp connectors or with TWIN crimp connectors	<b>0,2 - 1,5 mm<sup>2</sup>, 24 - 16 AWG</b>	<b>0,2 - 1,5 mm<sup>2</sup>, 24 - 16 AWG</b>	<b>0,2 - 1,5 mm<sup>2</sup>, 24 - 16 AWG</b>
Torque setting with screw terminals	<b>0,5 Nm</b>	<b>0,5 Nm</b>	<b>0,5 Nm</b>
Stripping length with screw terminals	<b>8 mm</b>	<b>8 mm</b>	<b>8 mm</b>
Dimensions			
Height	<b>94 mm</b>	<b>94 mm</b>	<b>94 mm</b>
Width	<b>22,5 mm</b>	<b>22,5 mm</b>	<b>22,5 mm</b>
Depth	<b>121 mm</b>	<b>121 mm</b>	<b>121 mm</b>

<b>Mechanical data</b>	<b>777580</b>	<b>777581</b>	<b>777582</b>
Weight	<b>185 g</b>	<b>190 g</b>	<b>205 g</b>

Where standards are undated, the 2022-09 latest editions shall apply.



### Technical details Order no. 777583, 787580, 787581

<b>General</b>	<b>777583</b>	<b>787580</b>	<b>787581</b>
Certifications	CCC, CE, EAC, TÜV, UKCA, cULus Listed	CCC, CE, EAC, TÜV, UKCA, cULus Listed	CCC, CE, EAC, TÜV, UKCA, cULus Listed
<b>Electrical data</b>	<b>777583</b>	<b>787580</b>	<b>787581</b>
Supply voltage			
Voltage	24 V	24 V	24 V
Kind	DC	DC	DC
Voltage tolerance	-15 %/+10 %	-15 %/+10 %	-15 %/+10 %
Output of external power supply (DC)	2,5 W	2,5 W	2,5 W
Residual ripple DC	20 %	20 %	20 %
Duty cycle	100 %	100 %	100 %
Max. inrush current impulse			
Current pulse, A1	1,7 A	1,7 A	1,7 A
Pulse duration, A1	180 ms	50 ms	100 ms
<b>Inputs</b>	<b>777583</b>	<b>787580</b>	<b>787581</b>
Quantity	1	1	1
Voltage at			
Input circuit DC	24 V	24 V	24 V
Current at			
Input circuit DC	95 mA	95 mA	95 mA
Max. overall cable resistance R <sub>lmax</sub>			
Single-channel at UB DC	30 Ohm	30 Ohm	30 Ohm
<b>Relay outputs</b>	<b>777583</b>	<b>787580</b>	<b>787581</b>
Number of output contacts			
Safety contacts (N/O), delayed	4	4	4
Max. short circuit current I <sub>K</sub>	1 kA	1 kA	1 kA
Utilisation category			
in accordance with the standard	EN 60947-4-1	EN 60947-4-1	EN 60947-4-1

<b>Relay outputs</b>	<b>777583</b>	<b>787580</b>	<b>787581</b>
Utilisation category of safety contacts delayed			
AC1 at	<b>240 V</b>	<b>240 V</b>	<b>240 V</b>
Min. current	<b>0,01 A</b>	<b>0,01 A</b>	<b>0,01 A</b>
Max. current	<b>6 A</b>	<b>6 A</b>	<b>6 A</b>
Max. power	<b>1500 VA</b>	<b>1500 VA</b>	<b>1500 VA</b>
DC1 at	<b>24 V</b>	<b>24 V</b>	<b>24 V</b>
Min. current	<b>0,01 A</b>	<b>0,01 A</b>	<b>0,01 A</b>
Max. current	<b>6 A</b>	<b>6 A</b>	<b>6 A</b>
Max. power	<b>150 W</b>	<b>150 W</b>	<b>150 W</b>
Utilisation category in accordance with the standard			
	<b>EN 60947-5-1</b>	<b>EN 60947-5-1</b>	<b>EN 60947-5-1</b>
Utilisation category of safety contacts delayed			
AC15 at	<b>230 V</b>	<b>230 V</b>	<b>230 V</b>
Max. current	<b>3 A</b>	<b>3 A</b>	<b>3 A</b>
DC13 (6 cycles/min) at	<b>24 V</b>	<b>24 V</b>	<b>24 V</b>
Max. current	<b>4 A</b>	<b>4 A</b>	<b>4 A</b>
Utilisation category in accordance with UL			
Voltage	<b>250 V AC G.U. (same polarity)</b>	<b>250 V AC G.U. (same polarity)</b>	<b>250 V AC G.U. (same polarity)</b>
with current	<b>6 A</b>	<b>6 A</b>	<b>6 A</b>
Voltage	<b>24 V DC G. U.</b>	<b>24 V DC G. U.</b>	<b>24 V DC G. U.</b>
with current	<b>6 A</b>	<b>6 A</b>	<b>6 A</b>
Pilot Duty	<b>B300, R300</b>	<b>B300, R300</b>	<b>B300, R300</b>
External contact fuse protection, safety contacts in accordance with the standard			
	<b>EN 60947-5-1</b>	<b>EN 60947-5-1</b>	<b>EN 60947-5-1</b>
External contact fuse protection, delayed safety contacts			
Max. melting integral	<b>66 A<sup>2</sup>s</b>	<b>66 A<sup>2</sup>s</b>	<b>66 A<sup>2</sup>s</b>
Blow-out fuse, quick	<b>6 A</b>	<b>6 A</b>	<b>6 A</b>
Blow-out fuse, slow	<b>4 A</b>	<b>4 A</b>	<b>4 A</b>
Blow-out fuse, gG	<b>6 A</b>	<b>6 A</b>	<b>6 A</b>
Circuit breaker, 24 V AC/DC, characteristic B/C	<b>4 A</b>	<b>4 A</b>	<b>4 A</b>
Contact material	<b>AgCuNi + 0,2 µm Au</b>	<b>AgCuNi + 0,2 µm Au</b>	<b>AgCuNi + 0,2 µm Au</b>

<b>Conventional thermal current while loading several contacts</b>	<b>777583</b>	<b>787580</b>	<b>787581</b>
Ith per contact at UB DC; AC1: 240 V, DC1: 24 V			
Conv. therm. current with 1 contact	<b>6 A</b>	<b>6 A</b>	<b>6 A</b>
Conv. therm. current with 2 contacts	<b>5 A</b>	<b>5 A</b>	<b>5 A</b>
Conv. therm. current with 3 contacts	<b>4,5 A</b>	<b>4,5 A</b>	<b>4,5 A</b>
Conv. therm. current with 4 contacts	<b>4 A</b>	<b>4 A</b>	<b>4 A</b>
<b>Times</b>	<b>777583</b>	<b>787580</b>	<b>787581</b>
Switch-on delay			
with automatic start after power on typ.	<b>55 ms</b>	<b>55 ms</b>	<b>55 ms</b>
with automatic start after power on max.	<b>200 ms</b>	<b>200 ms</b>	<b>200 ms</b>
Delay time tv	<b>3 s</b>	<b>0,5 s</b>	<b>1 s</b>
Time accuracy	<b>-50 %/+50 %</b>	<b>-50 %/+50 %</b>	<b>-50 %/+50 %</b>
Supply interruption before de-energisation	<b>1.500 ms</b>	<b>250 ms</b>	<b>500 ms</b>
<b>Environmental data</b>	<b>777583</b>	<b>787580</b>	<b>787581</b>
Climatic suitability	<b>EN 60068-2-78</b>	<b>EN 60068-2-78</b>	<b>EN 60068-2-78</b>
Ambient temperature			
Temperature range	<b>-10 - 55 °C</b>	<b>-10 - 55 °C</b>	<b>-10 - 55 °C</b>
Storage temperature			
Temperature range	<b>-40 - 85 °C</b>	<b>-40 - 85 °C</b>	<b>-40 - 85 °C</b>
Climatic suitability			
Humidity	<b>93 % r. h. at 40 °C</b>	<b>93 % r. h. at 40 °C</b>	<b>93 % r. h. at 40 °C</b>
Condensation during operation	<b>Not permitted</b>	<b>Not permitted</b>	<b>Not permitted</b>
EMC	<b>EN 60947-5-1, EN 61000-6-2, EN 61326-3-1</b>	<b>EN 60947-5-1, EN 61000-6-2, EN 61326-3-1</b>	<b>EN 60947-5-1, EN 61000-6-2, EN 61326-3-1</b>
Vibration			
in accordance with the standard	<b>EN 60068-2-6</b>	<b>EN 60068-2-6</b>	<b>EN 60068-2-6</b>
Frequency	<b>10 - 55 Hz</b>	<b>10 - 55 Hz</b>	<b>10 - 55 Hz</b>
Amplitude	<b>0,35 mm</b>	<b>0,35 mm</b>	<b>0,35 mm</b>
Airgap creepage			
in accordance with the standard	<b>EN 60947-1</b>	<b>EN 60947-1</b>	<b>EN 60947-1</b>
Overvoltage category	<b>III / II</b>	<b>III / II</b>	<b>III / II</b>
Pollution degree	<b>2</b>	<b>2</b>	<b>2</b>
Rated insulation voltage	<b>250 V</b>	<b>250 V</b>	<b>250 V</b>
Rated impulse withstand voltage	<b>4 kV</b>	<b>4 kV</b>	<b>4 kV</b>

<b>Environmental data</b>	<b>777583</b>	<b>787580</b>	<b>787581</b>
Protection type			
Housing	<b>IP40</b>	<b>IP40</b>	<b>IP40</b>
Terminals	<b>IP20</b>	<b>IP20</b>	<b>IP20</b>
Mounting area (e.g. control cabinet)	<b>IP54</b>	<b>IP54</b>	<b>IP54</b>
<b>Mechanical data</b>	<b>777583</b>	<b>787580</b>	<b>787581</b>
Mounting position	<b>Any</b>	<b>Any</b>	<b>Any</b>
Mechanical life	<b>10,000,000 cycles</b>	<b>10,000,000 cycles</b>	<b>10,000,000 cycles</b>
Material			
Bottom	<b>PPO UL 94 V1</b>	<b>PPO UL 94 V1</b>	<b>PPO UL 94 V1</b>
Front	<b>ABS UL 94 V0</b>	<b>ABS UL 94 V0</b>	<b>ABS UL 94 V0</b>
Top	<b>PPO UL 94 V1</b>	<b>PPO UL 94 V1</b>	<b>PPO UL 94 V1</b>
Connection type	<b>Screw terminal</b>	<b>Spring-loaded terminal</b>	<b>Spring-loaded terminal</b>
Mounting type	<b>plug-in</b>	<b>plug-in</b>	<b>plug-in</b>
Conductor cross section with screw terminals			
1 core flexible	<b>0,25 - 2,5 mm<sup>2</sup>, 24 - 12 AWG</b>	–	–
2 core with the same cross section, flexible with crimp connectors, no plastic sleeve	<b>0,25 - 1 mm<sup>2</sup>, 24 - 16 AWG</b>	–	–
2 core with the same cross section, flexible without crimp connectors or with TWIN crimp connectors	<b>0,2 - 1,5 mm<sup>2</sup>, 24 - 16 AWG</b>	–	–
Torque setting with screw terminals			
	<b>0,5 Nm</b>	–	–
Stripping length with screw terminals			
	<b>8 mm</b>	–	–
Conductor cross section with spring-loaded terminals: Flexible with/without crimp connector			
	–	<b>0,2 - 1,5 mm<sup>2</sup>, 24 - 16 AWG</b>	<b>0,2 - 1,5 mm<sup>2</sup>, 24 - 16 AWG</b>
Spring-loaded terminals: Terminal points per connection			
	–	<b>2</b>	<b>2</b>
Stripping length with spring-loaded terminals			
	–	<b>8 mm</b>	<b>8 mm</b>
Dimensions			
Height	<b>94 mm</b>	<b>101 mm</b>	<b>101 mm</b>
Width	<b>22,5 mm</b>	<b>22,5 mm</b>	<b>22,5 mm</b>
Depth	<b>121 mm</b>	<b>121 mm</b>	<b>121 mm</b>
Weight	<b>210 g</b>	<b>185 g</b>	<b>190 g</b>

Where standards are undated, the 2022-09 latest editions shall apply.

Technical details Order no. 787582, 787583

General	787582	787583
Certifications	CCC, CE, EAC, TÜV, UKCA, cULus Listed	CCC, CE, EAC, TÜV, UKCA, cULus Listed
Electrical data	787582	787583
Supply voltage		
Voltage	24 V	24 V
Kind	DC	DC
Voltage tolerance	-15 %/+10 %	-15 %/+10 %
Output of external power supply (DC)	2,5 W	2,5 W
Residual ripple DC	20 %	20 %
Duty cycle	100 %	100 %
Max. inrush current impulse		
Current pulse, A1	1,7 A	1,7 A
Pulse duration, A1	140 ms	180 ms
Inputs	787582	787583
Quantity	1	1
Voltage at		
Input circuit DC	24 V	24 V
Current at		
Input circuit DC	95 mA	95 mA
Max. overall cable resistance R <sub>I-max</sub>		
Single-channel at UB DC	30 Ohm	30 Ohm
Relay outputs	787582	787583
Number of output contacts		
Safety contacts (N/O), delayed	4	4
Max. short circuit current I <sub>K</sub>	1 kA	1 kA
Utilisation category		
in accordance with the standard	EN 60947-4-1	EN 60947-4-1
Utilisation category of safety contacts delayed		
AC1 at	240 V	240 V
Min. current	0,01 A	0,01 A
Max. current	6 A	6 A
Max. power	1500 VA	1500 VA
DC1 at	24 V	24 V
Min. current	0,01 A	0,01 A
Max. current	6 A	6 A
Max. power	150 W	150 W
Utilisation category		
in accordance with the standard	EN 60947-5-1	EN 60947-5-1

<b>Relay outputs</b>	<b>787582</b>	<b>787583</b>
Utilisation category of safety contacts delayed		
AC15 at	<b>230 V</b>	<b>230 V</b>
Max. current	<b>3 A</b>	<b>3 A</b>
DC13 (6 cycles/min) at	<b>24 V</b>	<b>24 V</b>
Max. current	<b>4 A</b>	<b>4 A</b>
Utilisation category in accordance with UL		
Voltage with current	<b>250 V AC G.U. (same polarity)</b>	<b>250 V AC G.U. (same polarity)</b>
	<b>6 A</b>	<b>6 A</b>
Voltage with current	<b>24 V DC G. U.</b>	<b>24 V DC G. U.</b>
	<b>6 A</b>	<b>6 A</b>
Pilot Duty	<b>B300, R300</b>	<b>B300, R300</b>
External contact fuse protection, safety contacts		
in accordance with the standard	<b>EN 60947-5-1</b>	<b>EN 60947-5-1</b>
External contact fuse protection, delayed safety contacts		
Max. melting integral	<b>66 A<sup>2</sup>s</b>	<b>66 A<sup>2</sup>s</b>
Blow-out fuse, quick	<b>6 A</b>	<b>6 A</b>
Blow-out fuse, slow	<b>4 A</b>	<b>4 A</b>
Blow-out fuse, gG	<b>6 A</b>	<b>6 A</b>
Circuit breaker, 24 V AC/DC, characteristic B/C	<b>4 A</b>	<b>4 A</b>
Contact material	<b>AgCuNi + 0,2 µm Au</b>	<b>AgCuNi + 0,2 µm Au</b>
<b>Conventional thermal current while loading several contacts</b>	<b>787582</b>	<b>787583</b>
I <sub>th</sub> per contact at UB DC; AC1: 240 V, DC1: 24 V		
Conv. therm. current with 1 contact	<b>6 A</b>	<b>6 A</b>
Conv. therm. current with 2 contacts	<b>5 A</b>	<b>5 A</b>
Conv. therm. current with 3 contacts	<b>4,5 A</b>	<b>4,5 A</b>
Conv. therm. current with 4 contacts	<b>4 A</b>	<b>4 A</b>
<b>Times</b>	<b>787582</b>	<b>787583</b>
Switch-on delay		
with automatic start after power on typ.	<b>55 ms</b>	<b>55 ms</b>
with automatic start after power on max.	<b>200 ms</b>	<b>200 ms</b>
Delay time tv	<b>2 s</b>	<b>3 s</b>
Time accuracy	<b>-50 %/+50 %</b>	<b>-50 %/+50 %</b>
Supply interruption before de-energisation	<b>1.000 ms</b>	<b>1.500 ms</b>

<b>Environmental data</b>	<b>787582</b>	<b>787583</b>
Climatic suitability	<b>EN 60068-2-78</b>	<b>EN 60068-2-78</b>
Ambient temperature		
Temperature range	<b>-10 - 55 °C</b>	<b>-10 - 55 °C</b>
Storage temperature		
Temperature range	<b>-40 - 85 °C</b>	<b>-40 - 85 °C</b>
Climatic suitability		
Humidity	<b>93 % r. h. at 40 °C</b>	<b>93 % r. h. at 40 °C</b>
Condensation during operation	<b>Not permitted</b>	<b>Not permitted</b>
EMC	<b>EN 60947-5-1, EN 61000-6-2, EN 61326-3-1</b>	<b>EN 60947-5-1, EN 61000-6-2, EN 61326-3-1</b>
Vibration		
in accordance with the standard	<b>EN 60068-2-6</b>	<b>EN 60068-2-6</b>
Frequency	<b>10 - 55 Hz</b>	<b>10 - 55 Hz</b>
Amplitude	<b>0,35 mm</b>	<b>0,35 mm</b>
Airgap creepage		
in accordance with the standard	<b>EN 60947-1</b>	<b>EN 60947-1</b>
Overvoltage category	<b>III / II</b>	<b>III / II</b>
Pollution degree	<b>2</b>	<b>2</b>
Rated insulation voltage	<b>250 V</b>	<b>250 V</b>
Rated impulse withstand voltage	<b>4 kV</b>	<b>4 kV</b>
Protection type		
Housing	<b>IP40</b>	<b>IP40</b>
Terminals	<b>IP20</b>	<b>IP20</b>
Mounting area (e.g. control cabinet)	<b>IP54</b>	<b>IP54</b>
<b>Mechanical data</b>	<b>787582</b>	<b>787583</b>
Mounting position	<b>Any</b>	<b>Any</b>
Mechanical life	<b>10,000,000 cycles</b>	<b>10,000,000 cycles</b>
Material		
Bottom	<b>PPO UL 94 V1</b>	<b>PPO UL 94 V1</b>
Front	<b>ABS UL 94 V0</b>	<b>ABS UL 94 V0</b>
Top	<b>PPO UL 94 V1</b>	<b>PPO UL 94 V1</b>
Connection type	<b>Spring-loaded terminal</b>	<b>Spring-loaded terminal</b>
Mounting type	<b>plug-in</b>	<b>plug-in</b>
Conductor cross section with spring-loaded terminals: Flexible with/without crimp connector	<b>0,2 - 1,5 mm<sup>2</sup>, 24 - 16 AWG</b>	<b>0,2 - 1,5 mm<sup>2</sup>, 24 - 16 AWG</b>
Spring-loaded terminals: Terminal points per connection	<b>2</b>	<b>2</b>
Stripping length with spring-loaded terminals	<b>8 mm</b>	<b>8 mm</b>
Dimensions		
Height	<b>101 mm</b>	<b>101 mm</b>
Width	<b>22,5 mm</b>	<b>22,5 mm</b>
Depth	<b>121 mm</b>	<b>121 mm</b>
Weight	<b>205 g</b>	<b>210 g</b>

Where standards are undated, the 2022-09 latest editions shall apply.

### Safety characteristic data



**NOTICE**

You must comply with the safety characteristic data in order to achieve the required safety level for your plant/machine.

Operating mode	EN ISO 13849-1: 2015	EN ISO 13849-1: 2015	EN IEC 62061 SIL CL/ maximum SIL	EN IEC 62061 PFH <sub>D</sub> [1/h]	EN/IEC 61511 SIL	EN/IEC 61511 PFD	EN ISO 13849-1: 2015 T <sub>M</sub> [year]
	PL	Category					

Safety contacts, delayed <30 s

PL d	Cat. 3	SIL 2	2,48E-09	SIL 2	1,47E-05	20
------	--------	-------	----------	-------	----------	----

Explanatory notes for the safety-related characteristic data:

- ▶ Safety characteristic data in accordance with EN IEC 62061 and EN/IEC 61511 was calculated based on EN/IEC 61508.
- ▶ T<sub>M</sub> is the maximum mission time in accordance with EN ISO 13849-1. The value also applies as the retest interval in accordance with EN/IEC 61508-6 and EN/IEC 61511 and as the proof test interval and mission time in accordance with EN IEC 62061.

All the units used within a safety function must be considered when calculating the safety characteristic data.



**INFORMATION**

A safety function's SIL/PL values are **not** identical to the SIL/PL values of the units that are used and may be different. We recommend that you use the PAscal software tool to calculate the safety function's SIL/PL values.



### Supplementary data



**CAUTION!**

It is essential to consider the relay's service life graphs. The relay outputs' safety-related characteristic data is only valid if the values in the service life graphs are met.

The PFH value depends on the switch frequency and the load of the relay output. If the service life graphs are not accessible, the stated PFH value can be used irrespective of the switch frequency and the load, as the PFH value already considers the relay's B10d value as well as the failure rates of the other components.

**Service life graph**

The service life graphs indicate the number of cycles from which failures due to wear must be expected. The wear is mainly caused by the electrical load; the mechanical load is negligible.

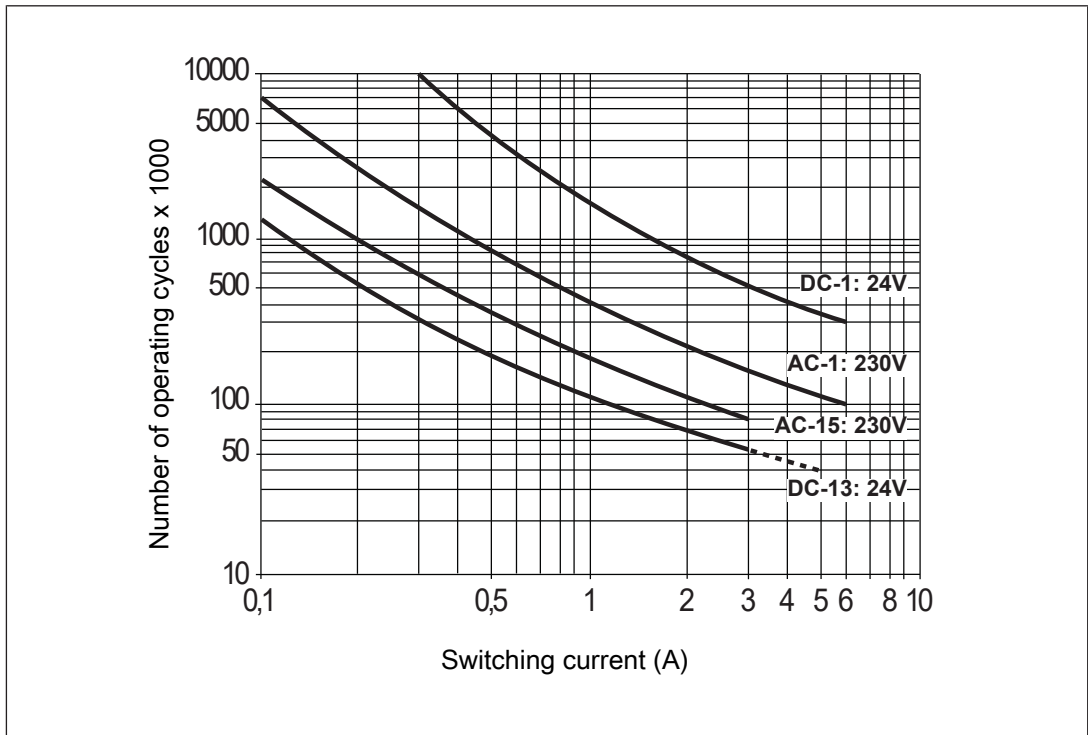

Fig.: Service life graphs at 24 VDC and 230 VAC

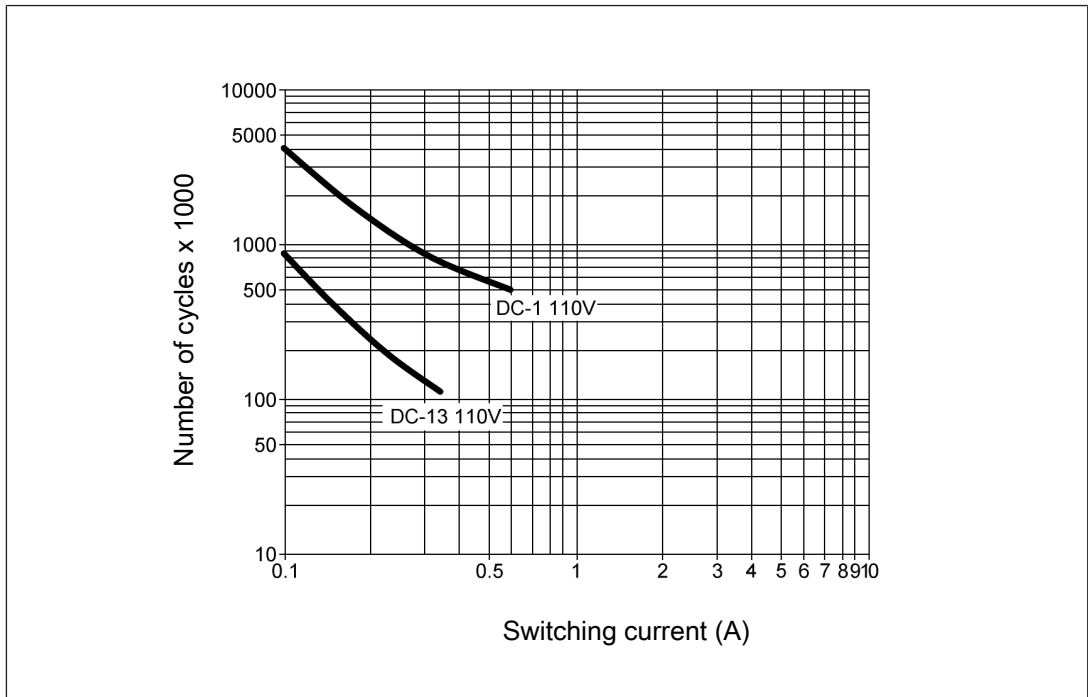

Fig.: Service life graphs at 110 VDC

### Example

- ▶ Inductive load: 0.2 A
- ▶ Utilisation category: AC15
- ▶ Contact service life: 1 000 000 cycles

Provided the application to be implemented requires fewer than 1 000 000 cycles, the PFH value (see [Technical details \[12\]](#)) can be used in the calculation.

To increase the service life, sufficient spark suppression must be provided on all relay contacts. With capacitive loads, any power surges that occur must be noted. With DC contactors, use flywheel diodes for spark suppression.

## Remove plug-in terminals

### Procedure

► Insert a suitable screwdriver into the housing recess behind the terminal.

Do **not** remove the terminals by pulling the cables!

► Lever the terminal out.

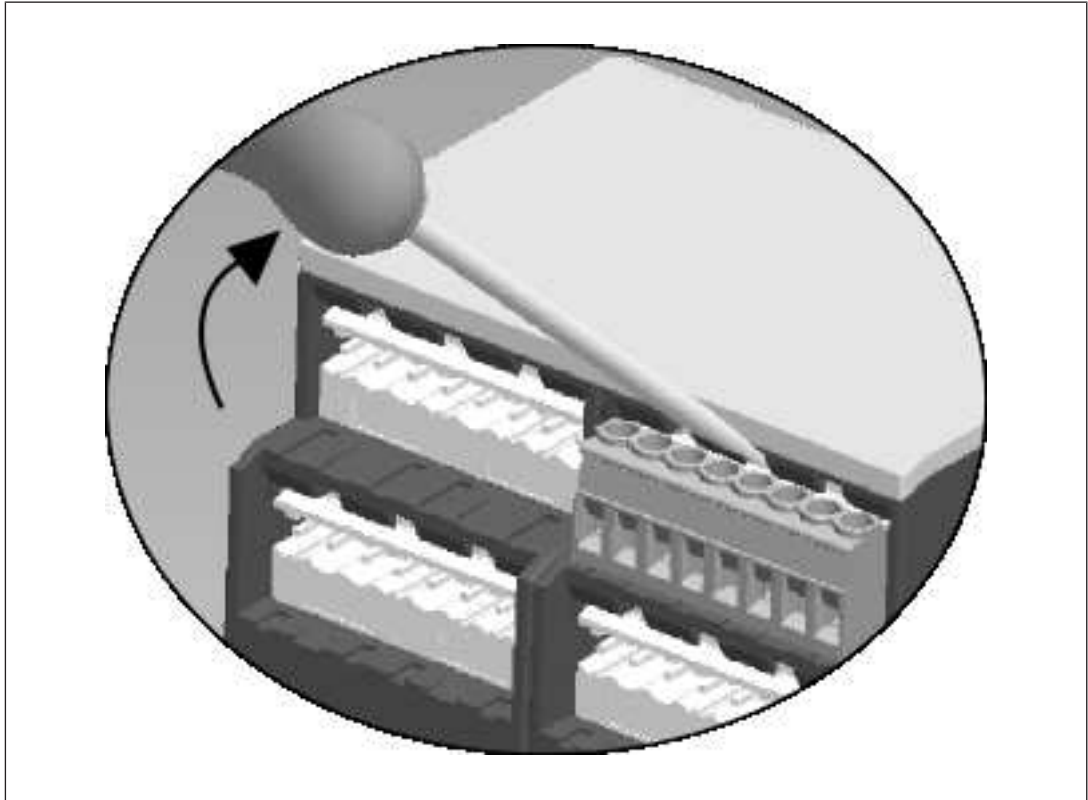

### Order reference

Product type	Features	Connection type	Order no.
PZE X4VP	24 V DC; $t_V = 0.5$ s	Screw terminals, plug-in	777580
PZE X4VP C	24 V DC; $t_V = 0.5$ s	Spring-loaded terminals, plug-in	787580
PZE X4VP	24 V DC; $t_V = 1$ s	Screw terminals, plug-in	777581
PZE X4VP C	24 V DC; $t_V = 1$ s	Spring-loaded terminals, plug-in	787581
PZE X4VP	24 V DC; $t_V = 2$ s	Screw terminals, plug-in	777582
PZE X4VP C	24 V DC; $t_V = 2$ s	Spring-loaded terminals, plug-in	787582
PZE X4VP	24 V DC; $t_V = 3$ s	Screw terminals, plug-in	777583
PZE X4VP C	24 V DC; $t_V = 3$ s	Spring-loaded terminals, plug-in	787583

### **EC declaration of conformity**

This product/these products meet the requirements of the directive 2006/42/EC on machinery of the European Parliament and of the Council. The complete EC Declaration of Conformity is available on the Internet at [www.pilz.com/downloads](http://www.pilz.com/downloads).

Representative: Hansjürgen Horter, Pilz GmbH & Co. KG, Felix-Wankel-Straße 2, 73760 Ostfildern, Germany

### **UKCA-Declaration of Conformity**

This product(s) complies with following UK legislation: Supply of Machinery (Safety) Regulation 2008.

The complete UKCA Declaration of Conformity is available on the Internet at [www.pilz.com/downloads](http://www.pilz.com/downloads).

Representative: Pilz Automation Technology, Pilz House, Little Colliers Field, Corby, Northamptonshire, NN18 8TJ United Kingdom, eMail: [mail@pilz.co.uk](mailto:mail@pilz.co.uk)

# ► Support

Technical support is available from Pilz round the clock.

## Americas

### Brazil

+55 11 97569-2804

### Canada

+1 888 315 7459

### Mexico

+52 55 5572 1300

### USA (toll-free)

+1 877-PILZUSA (745-9872)

## Asia

### China

+86 21 60880878-216

### Japan

+81 45 471-2281

### South Korea

+82 31 778 3300

## Australia and Oceania

### Australia

+61 3 95600621

### New Zealand

+64 9 6345350

## Europe

### Austria

+43 1 7986263-0

### Belgium, Luxembourg

+32 9 3217570

### France

+33 3 88104003

### Germany

+49 711 3409-444

### Ireland

+353 21 4804983

### Italy, Malta

+39 0362 1826711

## Scandinavia

+45 74436332

## Spain

+34 938497433

## Switzerland

+41 62 88979-32

## The Netherlands

+31 347 320477

## Turkey

+90 216 5775552

## United Kingdom

+44 1536 462203

## You can reach our international hotline on:

+49 711 3409-222

support@pilz.com

Pilz develops environmentally-friendly products using ecological materials and energy-saving technologies. Offices and production facilities are ecologically designed, environmentally-aware and energy-saving. So Pilz offers sustainability, plus the security of using energy-efficient products and environmentally-friendly solutions.



We are represented internationally. Please refer to our homepage [www.pilz.com](http://www.pilz.com) for further details or contact our headquarters.

Headquarters: Pilz GmbH & Co. KG, Felix-Wankel-Straße 2, 73760 Ostfildern, Germany  
Telephone: +49 711 3409-0, Telefax: +49 711 3409-133, E-Mail: [info@pilz.com](mailto:info@pilz.com), Internet: [www.pilz.com](http://www.pilz.com)

**PILZ**  
THE SPIRIT OF SAFETY

1003202-EN-14, 2023-06 Printed in Germany  
© Pilz GmbH & Co. KG, 2019

CECE®, CHRE®, CMSE®, InduraNET p®, Leansafe®, Master of Safety®, Master of Security®, PAS4000®, PAScall®, PASconfig®, Pilz®, PTT®, PLID®, PMCPirimo®, PMCPiritego®, PMCTendo®, PMD®, PMJ®, PNOZ®, PRCM®, PRM®, PRMNET p®, PSEN®, PSENi®, PSS®, PVS®, SafetyBUS p®, SafetyEYE®, SafetyNET p®, THE SPIRIT OF SAFETY® are registered and protected trademarks of Pilz GmbH & Co. KG in some countries. We would point out that product features may vary from the details stated in this document, depending on the status at the time of publication and the scope of the equipment. We accept no responsibility for the validity, accuracy and entirety of the text and graphics presented in this information. Please contact our Technical Support if you have any questions.